

602902

HAND-BOOK  
OF  
NATURAL PHILOSOPHY  
AND  
ASTRONOMY.

BY DIONYSIUS LARDNER, D.C.L.

FORMERLY PROFESSOR OF NATURAL PHILOSOPHY AND ASTRONOMY  
IN UNIVERSITY COLLEGE, LONDON.

SECOND COURSE.

HEAT—COMMON ELECTRICITY—MAGNETISM—  
VOLTAIC ELECTRICITY.

WITH UPWARDS OF TWO HUNDRED ILLUSTRATIONS.

LONDON:  
TAYLOR, WALTON, AND MABERLY,  
No. 1, UPPER GOWER STREET, AND IVY LANE, PATERNOSTER ROW.  
show  
by c  
1852.



**LONDON :**  
**SPOTTISWOODEN and SHAW,**  
**New-street-Square.**

## ADVERTISEMENT.

IN the composition of this Work the Author has had in view the satisfaction of those who desire to obtain a knowledge of the elements of physics without pursuing them through their mathematical consequences and details. The methods of demonstration and illustration have accordingly been adapted to such readers.

The Work has been also composed with the object of supplying that information relating to physical and mechanical science, which is required by the Medical and Law Student, the Engineer, and Artisan, by those who are preparing for the universities, and, in short, by those, who, having already entered upon the active pursuits of business, are still desirous to sustain and improve their knowledge of the general truths of physics, and of those laws by which the order and stability of the material world are maintained.

According to the original plan of the Work, it was intended to comprise Astronomy and Meteorology in the present volume, and so to complete the series. It was found, however, that these subjects, treated with the fulness and clearness commensurate with their importance, would swell the volume to an objectionable bulk; and the publishers considered that they should best consult the interest and convenience of purchasers, by consigning Astronomy and Meteorology to a separate volume.

These will therefore form the third and concluding course of this Handbook.

Facility of reference has been presented by the copious analytical tables of contents, as well as by the distinct titles prefixed to every paragraph, and by the Index given at the end of each volume.

It is intended to annex to the concluding volume a general Index to the three courses, which will confer upon the work all the useful qualities of a compendious Encyclopædia of Physical and Astronomical Science.

# CONTENTS.

## BOOK I.

### Heat.

#### CHAP. I.

##### PRELIMINARY PRINCIPLES AND DEFINITIONS.

Sect. •	Page
1304. Heat - - - - -	1
1305. Sensible heat - - - - -	<i>ib.</i>
1306. Insensible heat - - - - -	<i>ib.</i>
1307. Dilatation and contraction - - - - -	<i>ib.</i>
1308. Liquefaction and solidification - - - - -	2
1309. Vaporization and condensation - - - - -	<i>ib.</i>
1310. Incandescence - - - - -	<i>ib.</i>
1311. Combustion - - - - -	3
1312. Thermometers and pyrometers - - - - -	<i>ib.</i>
1313. Conduction - - - - -	<i>ib.</i>
1314. Radiation - - - - -	4
1315. Diathermanous media - - - - -	<i>ib.</i>
1316. Reflection of heat - - - - -	<i>ib.</i>
1317. Refraction of heat - - - - -	5
1318. Different senses of the terms heat and caloric - - - - -	<i>ib.</i>
1319. Hypothesis to explain thermal phenomena - - - - -	<i>ib.</i>

#### CHAP. II.

##### THERMOMETRY.

1320. Measures of temperature - - - - -	<i>ib.</i>
1321. Thermoscopic substances - - - - -	6
1322. Mercurial thermometer - - - - -	<i>ib.</i>
1323. Preparation of the mercury - - - - -	7
1324. Selection of the tube - - - - -	<i>ib.</i>
1325. Formation of the bulb - - - - -	<i>ib.</i>
1326. Introduction of the mercury - - - - -	8
1327. Thermometric scale arbitrary - - - - -	9
1328. Standard points—division of scale - - - - -	<i>ib.</i>
1329. Numeration of scale—zero point - - - - -	10
1330. No natural zero - - - - -	<i>ib.</i>
1331. Phenomena fit to supply standard points - - - - -	<i>ib.</i>
1332. Freezing and boiling points of water adopted by common consent - - - - -	<i>ib.</i>
1333. Determination of these points - - - - -	11
1334. Different thermometric units and zeros—Fahrenheit's scale - - - - -	<i>ib.</i>
1335. Centigrade scale - - - - -	<i>ib.</i>
1336. Reaumur's scale - - - - -	12
1337. Methods of computing the temperature according to any one scale when the temperature according to any other is given - - - - -	<i>ib.</i>

Sect.	Page
1338. Rate of dilatation of mercury - - - - -	13
1339. Its dilatation uniform between standard points - - - - -	14
1340. Use of a standard thermometer - - - - -	<i>ib.</i>
1341. Range of the scale of thermometers varies with purpose to which they are applied - - - - -	15
1342. Qualities which render mercury a convenient thermoscopic fluid - - - - -	<i>ib.</i>
1343. Bulbs liable to a permanent change of capacity, which renders correction of scale necessary - - - - -	<i>ib.</i>
1344. Self-registering thermometers - - - - -	16
1345. Spirit of wine thermometer - - - - -	<i>ib.</i>
1346. Air thermometer - - - - -	<i>ib.</i>
1347. Drebhel's air thermometer - - - - -	17
1348. Amonton's air thermometer - - - - -	<i>ib.</i>
1349. The differential thermometer - - - - -	<i>ib.</i>
1350. Pyrometers adapted to measure high temperatures - - - - -	18
1351. Graduation of a pyrometer - - - - -	<i>ib.</i>
1352. Temperature of metallic standard measures must be observed - - - - -	19
1353. Borda's pyrometric standard measure - - - - -	20
1354. Construction and use of a vernier - - - - -	21

#### CHAP. III.

##### DILATATION OF SOLIDS.

1355. Solids least susceptible of dilatation - - - - -	22
1356. Homogeneous solids dilate equally throughout their volume - - - - -	<i>ib.</i>
1357. Dilatation of volume and surface computed from linear dilatation - - - - -	<i>ib.</i>
1358. Dilatation of solids uniform between the standard thermometric points - - - - -	23
1359. Dilatations cease to be uniform near the point of fusion - - - - -	<i>ib.</i>
1360. Exceptional cases presented by certain crystals - - - - -	<i>ib.</i>
1361. Tabular statement of the rate of dilatation of solids - - - - -	24
1362. Measure of the force of dilatation and contraction of solids - - - - -	26
1363. Practical application of the forces of dilatation and contraction in drawing together the walls of a building - - - - -	<i>ib.</i>

Sect.	Page	Sect.	Page
1364. Moulds for casting in metal must be larger than the objects to be cast - - - - -	26	1395. Exceptional phenomena manifested by water approaching its freezing point - - - - -	43
1365. Hoops and tires tightened by the contraction in cooling - - - - -	27	1396. Temperature of greatest density - - - - -	44
1366. Compensators necessary in all metallic buildings - - - - -	<i>ib.</i>	1397. Taken as the basis of the French metrical system - - - - -	<i>ib.</i>
1367. Blistering and cracking of lead and zinc roofs - - - - -	<i>ib.</i>	1398. Effect of the relative densities of different strata of the same liquid - - - - -	<i>ib.</i>
1368. Metallic inlaying liable to start - - - - -	<i>ib.</i>	1399. Process of heating a liquid - - - - -	45
1369. Compensating pendulum - - - - -	<i>ib.</i>	1400. Heat does not descend in a liquid - - - - -	<i>ib.</i>
1370. Harrison's gridiron pendulum - - - - -	28	1401. Experiments showing the propagation of heat through a liquid by currents - - - - -	<i>ib.</i>
1371. Bars of different metals mutually attached are curved by dilatation and contraction - - - - -	29	1402. Method of warming buildings by hot water - - - - -	46
1372. Application of this principle to compensation pendulums - - - - -	30		
1373. Its application to balance wheels - - - - -	<i>ib.</i>		

## CHAP. IV.

## DILATATION OF GASES.

1374. Volume of gaseous bodies dependent on pressure and temperature - - - - -	31
1375. Method of observing the dilatation of gases under uniform pressure - - - - -	<i>ib.</i>
1376. Dilatation of gaseous bodies uniform and equal - - - - -	33
1377. Amount of this dilatation ascertained - - - - -	<i>ib.</i>
1378. Increment of volume corresponding to 1° - - - - -	<i>ib.</i>
1379. Experiments of Gay Lussac, Dulong and Petit, showing uniformity and equality of expansion - - - - -	34
1380. This result qualified by researches of Rudberg and Regnault - - - - -	<i>ib.</i>
1381. Formula to compute the change of volume of a gas corresponding to a given change of temperature - - - - -	35
1382. Increase of pressure due to increase of temperature - - - - -	37
1383. Formula expressing the general relation between the volume, temperature, and pressure - - - - -	<i>ib.</i>
1384. Examples of the effects of dilatation and contraction - - - - -	38
1385. Ventilation and warming of buildings - - - - -	<i>ib.</i>
1386. Effects of open fire-places and close stoves - - - - -	39
1387. Methods of warming apartments - - - - -	<i>ib.</i>
1388. Principle of an Argand lamp - - - - -	40
1389. Cause of atmospheric currents - - - - -	41
1390. Experiments illustrating the expansion and contraction of air - - - - -	<i>ib.</i>

## CHAP. V.

## DILATATION OF LIQUIDS.

1391. Liquid a state of transition - - - - -	42
1392. Rate of dilatation of liquids in general uniform - - - - -	43
1393. Specific gravity of liquid varies with its temperature - - - - -	<i>ib.</i>
1394. Rate of dilatation of liquid - - - - -	<i>ib.</i>

## CHAP. VI.

## CALORIMETRY.

1403. Quantitative analysis of heat - - - - -	47
1404. Calorimetry and thermometry - - - - -	<i>ib.</i>
1405. Thermal unit - - - - -	<i>ib.</i>
1406. Specific heat - - - - -	<i>ib.</i>
1407. Uniform and variable - - - - -	48
1408. Methods of solving calorimetric problems - - - - -	<i>ib.</i>
1409. Calorimeter of Lavoisier and Laplace - - - - -	<i>ib.</i>
1410. Application of calorimeter to determine specific heat - - - - -	50
1411. Specific heat of water uniform - - - - -	<i>ib.</i>
1412. Method of ascertaining the specific heat of other bodies by calorimeter - - - - -	51
1413. Method of equalization of temperature - - - - -	<i>ib.</i>
1414. Application of this method - - - - -	52
1415. Method of cooling - - - - -	53
1416. Results of calorimetric researches - - - - -	<i>ib.</i>
1417. Relation of specific heat to density - - - - -	<i>ib.</i>
1418. The fire syringe - - - - -	<i>ib.</i>
1419. Specific heat of gases and vapours increases as their density is diminished - - - - -	<i>ib.</i>
1420. Specific heat under constant pressure and constant volume - - - - -	54
1421. Greater under a constant pressure - - - - -	<i>ib.</i>
1422. Example of the expansion of high pressure steam - - - - -	<i>ib.</i>
1423. Low temperature of superior strata of atmosphere - - - - -	<i>ib.</i>
1424. Line of perpetual snow - - - - -	55
1425. Liquefaction of gases - - - - -	<i>ib.</i>
1426. Development and absorption of heat by chemical combination - - - - -	56
1427. Specific heats of simple gases equal under the same pressure - - - - -	<i>ib.</i>
1428. Formula for the variation of specific heat consequent on change of pressure - - - - -	57
1429. Relation between specific heat and atomic weight - - - - -	<i>ib.</i>
1430. Tables of specific heat - - - - -	58

## CHAP. VII.

## LIQUEFACTION AND SOLIDIFICATION.

1431. Thermal phenomena attending liquefaction - - - - -	63
--	----



Sect.	Page	Sect.	Page
1501. Processes by which gases have been liquefied or solidified	97	1539. Example of streams of volcanic lava	114
1502. Gases which have been liquefied	98	1540. Example of the earth itself	<i>ib.</i>
1503. At extreme pressures gases depart from the common law of the density being proportional to pressure	99	1541. Temperature increases with the depth	<i>ib.</i>
1504. State of ebullition	<i>ib.</i>	1542. The earth was formerly in a state of fusion, and is still cooling	115
1505. Boiling point varies with the pressure	<i>ib.</i>		
1506. Experimental verification of this principle	100	CHAP. X.	
1507. At elevated stations water boils at low temperatures	<i>ib.</i>	RADIATION.	
1508. Table of the boiling points of water at various places	101	1543. Heat radiates like light	<i>ib.</i>
1509. Latent heat of vapour	<i>ib.</i>	1544. Thermal analysis of solar light	<i>ib.</i>
1510. Different estimates of the latent heat of the vapour of water	103	1545. Thermal solar rays differently refrangible	116
1511. Heat absorbed in evaporation at different temperatures	<i>ib.</i>	1546. Physical analysis of solar light. Three spectra	<i>ib.</i>
1512. Latent heat of vapour of water ascertained by Regnault	104	1547. Relative refrangibility of the constituents of solar light varies with the refracting medium	117
1513. Latent heat of other vapours ascertained by Fabre and Silbermann	<i>ib.</i>	1548. Invisible rays may be luminous and all rays may be thermal	<i>ib.</i>
1514. Condensation of vapour	105	1549. Refraction of invisible thermal rays	118
1515. Why vessels in which liquids are boiled are not destroyed by excessive heat	<i>ib.</i>	1550. Heat radiated from each point on the surface of a body	<i>ib.</i>
1516. Uses of latent heat of steam in domestic economy	106	1551. Why bodies are not therefore indefinitely cooled	119
1517. Method of warming dwelling-houses	<i>ib.</i>	1552. Radiation is superficial or nearly so	<i>ib.</i>
1518. Effects of the temperature of different climates on certain liquids	<i>ib.</i>	1553. Reflection of heat	<i>ib.</i>
		1554. Rate of radiation proportional to excess of temperature of radiator above surrounding medium	120
CHAP. IX.		1555. Intensity inversely as square of distance	<i>ib.</i>
CONDUCTION.		1556. Influence of surface on radiating power	<i>ib.</i>
1519. Good and bad conductors	107	1557. Reflection of heat	<i>ib.</i>
1520. Experimental illustration of conduction	<i>ib.</i>	1558. Absorption of heat	121
1521. Table of conducting powers	108	1559. Tabular statement of radiating and reflecting powers	<i>ib.</i>
1522. Liquids and gases are non-conductors	109	1560. Singular anomaly in the reflection from metallic surfaces	122
1523. Temperature equalized in these by circulation	<i>ib.</i>	1561. Thermal equilibrium maintained by the interchange of heat by radiation and absorption	<i>ib.</i>
1524. Conducting power diminished by subdivision and pulverization	110	1562. Erroneous hypothesis of radiation of cold	123
1525. Beautiful examples of this principle in the animal economy	<i>ib.</i>	1563. Transmission of heat	<i>ib.</i>
1526. Uses of the plumage of birds	<i>ib.</i>	1564. Melloni's thermoscopic apparatus	<i>ib.</i>
1527. The wool and fur of animals	111	1565. Results of Melloni's researches	125
1528. The bark of vegetables	<i>ib.</i>	1566. Transparent media not proportionally diathermanous	<i>ib.</i>
1529. Properties of the artificial clothing of man	<i>ib.</i>	1567. Decomposition of heat by absorption	<i>ib.</i>
1530. Effects of snow on the soil in winter	<i>ib.</i>	1568. Absorption not superficial but limited to a certain depth	126
1531. Matting upon exotics	112	1569. Physical conditions of diathermanism	127
1532. Method of preserving ice in hot climates	<i>ib.</i>	1570. Refraction and polarization of heat	128
1533. Glass and porcelain vessels why broken by hot water	<i>ib.</i>	1571. Application of these principles to explain various phenomena	<i>ib.</i>
1534. Wine coolers	<i>ib.</i>	1572. Experiment of radiated and reflected heat with pair of parabolic reflectors	<i>ib.</i>
1535. A heated globe cools inwards	<i>ib.</i>	1573. Materials fitted for vessels to keep liquids warm	129
1536. Example of a fluid metal cast in spherical mould	113	1574. Advantage of a polished stove	<i>ib.</i>
1537. Cooling process may be indefinitely protracted	<i>ib.</i>	1575. Helmets and cuirasses should be polished	<i>ib.</i>
1538. Example of the casting of the hydraulic press which raised the Britannia bridge	<i>ib.</i>	1576. Deposition of moisture on window panes	<i>ib.</i>
		1577. Principles which explain the phenomena of dew and hoar-frost	131

Sect.	Page	Sect.	Page
1578. Dew not deposited under a clouded sky - - -	132	1598. Table I. showing the temperature of the blood of 13 individuals in different climates. Table II. showing the temperature of the blood in 6 individuals in different climates. Table III. showing the temperature of the blood in the same individual at different hours of the day. Table IV. showing the limits between which the temperatures of the blood in different races was observed to vary in India. Table V. showing the temperature of the blood observed in different species of animals - - -	139
1579. Production of artificial ice by radiation in hot climates - - -	<i>ib.</i>	1599. Deductions from these observations - - -	141
<b>CHAP. XI.</b>			
<b>COMBUSTION.</b>			
1580. Heat developed or absorbed in chemical combination - - -	<i>ib.</i>	1600. Birds have the highest and amphibians the lowest temperature -	142
1581. This effect explained by specific heat of compound being less or greater than that of components - - -	133	1601. Experiments of Breschet and Becquerel - - -	<i>ib.</i>
1582. Or by heat being developed or absorbed by change of state - - -	<i>ib.</i>	1602. Comparative temperature of the blood in health and sickness -	<i>ib.</i>
1583. Combustion - - -	<i>ib.</i>	1603. Other experiments by Breschet and Becquerel - - -	<i>ib.</i>
1584. Flame - - -	<i>ib.</i>	1604. Experiments to ascertain the rate of development of animal heat -	<i>ib.</i>
1585. Agency of oxygen - - -	<i>ib.</i>	1605. Total quantity of heat explained by chemical laws without any special vital cause - - -	143
1586. Combustibles - - -	134		
1587. Combustion explained - - -	<i>ib.</i>		
1588. Temperature necessary to produce combustion - - -	<i>ib.</i>		
1589. Light of flame only superficial -	135		
1590. Illuminating power of combustibles -	<i>ib.</i>		
1591. Constituents of combustibles used for illumination - - -	<i>ib.</i>		
1592. Spongy platinum rendered incandescent by hydrogen - - -	<i>ib.</i>		
1593. Quantity of heat developed by combustibles - - -	136		
1594. Table of the quantities of heat evolved in the combustion of various bodies - - -	<i>ib.</i>		
<b>CHAP. XII.</b>			
<b>ANIMAL HEAT.</b>			
1595. Temperature of organized bodies not in equilibrium with surrounding medium - - -	138	1606. Indications of the senses fallacious	
1596. Temperature of the blood in the human species - - -	<i>ib.</i>	1607. Sense of touch, a fallacious measure of heat - - -	
1597. Researches of Davy to determine the temperature of the blood -	<i>ib.</i>	1608. Its indications contradictory -	<i>ib.</i>
		1609. These contradictions explained -	146
		1610. Examples of the fallacious impressions produced by objects on the touch - - -	
		1611. Feats of fire-eaters explained -	<i>ib.</i>
<b>CHAP. XIII.</b>			
<b>THE SENSATION OF HEAT.</b>			

BOOK II.

Magnetism.

CHAP. I.		Sect.	Page
DEFINITIONS AND PRIMARY PHENOMENA.			
Sect.	Page	1618. Curve representing the varying intensity - - -	151
1612. Natural magnets : loadstone -	149	1619. Magnetic attraction and repulsion -	152
1613. Artificial magnets - - -	<i>ib.</i>	1620. Like poles repel, unlike attract -	<i>ib.</i>
1614. Neutral line or equator : poles -	<i>ib.</i>	1621. Magnets arrange themselves mutually parallel with poles reversed - - -	153
1615. Experimental illustrations of them -	150	1622. Magnetic axis - - -	<i>ib.</i>
1616. Experimental illustration of the distribution of the magnetic force - - -	<i>ib.</i>	1623. How ascertained experimentally -	<i>ib.</i>
1617. Varying intensity of magnetic force indicated by a pendulum - - -	151	1624. Hypothesis of two fluids, boreal and austral - - -	155
		1625. Condition of the natural or unmagnetized state - - -	<i>ib.</i>



Sect.	Page	Sect.	Page
1625. Condition of the magnetized state	155	1658. The magnetic equator	170
1627. Coercive force	156	Its form and position not regular	<i>ib.</i>
1628. Coercive force insensible in soft iron, most active in highly tempered steel	<i>ib.</i>	Variation of the dip going north or south	<i>ib.</i>
1629. Magnetic substances	<i>ib.</i>	Lines of equal dip	171
<b>CHAP. II.</b>			
<b>MAGNETISM BY INDUCTION.</b>			
1630. Soft iron rendered temporarily magnetic	<i>ib.</i>	1659. Magnetic meridians	<i>ib.</i>
1631. This may be effected by proximity without contact	157	1660. Method of ascertaining the declination of the needles	<i>ib.</i>
1632. Induction	158	Local declinations	172
1633. Magnets with poles reversed neutralize each other	<i>ib.</i>	1661. Lines of no declination called agonic lines	<i>ib.</i>
1634. A magnet broken at equator produces two magnets	159	1662. Declination in different longitudes at equator and in lat. 45°	<i>ib.</i>
1635. Decomposition of magnetic fluid not attended by its transfer between pole and pole	<i>ib.</i>	1663. Isogonic lines	173
1636. The decomposition is molecular	<i>ib.</i>	1664. Local dip	<i>ib.</i>
1637. Coercive force of iron varies with its molecular structure	160	1665. Position of magnetic poles	<i>ib.</i>
1638. Effect of induction on hard iron or steel	<i>ib.</i>	1666. Magnetic poles not antipodal	174
1639. Forms of magnetic needles and bars	161	1667. Periodical variations of terrestrial magnetism	<i>ib.</i>
1640. Compound magnet	<i>ib.</i>	1668. Intensity of terrestrial magnetism	175
1641. Effects of heat on magnetism	162	1669. Increases from equator to poles	176
1642. A red heat destroys the magnetism of iron	<i>ib.</i>	1670. Isodynamic lines	<i>ib.</i>
1643. Different magnetic bodies lose their magnetism at different temperatures	<i>ib.</i>	1671. Their near coincidence with isothermal lines	<i>ib.</i>
1644. Heat opposed to induction	<i>ib.</i>	1672. Equatorial and polar intensification	<i>ib.</i>
1645. Induced magnetism rendered permanent by hammering and other mechanical effects	<i>ib.</i>	1673. Effect of the terrestrial magnetism on soft iron	<i>ib.</i>
1646. Compounds of iron differently susceptible of magnetism	163	1674. Its effects on steel bars	177
1647. Compounds of other magnetic bodies not susceptible	<i>ib.</i>	1675. Diurnal variation of the needle	<i>ib.</i>
1648. Magnets with consequent points	<i>ib.</i>	1676. Disturbances in the magnetic intensity	179
<b>CHAP. III.</b>			
<b>TERRESTRIAL MAGNETISM.</b>			
1649. Analogy of the earth to a magnet	164	1677. Influence of the aurora borealis	<i>ib.</i>
1650. The azimuth compass	165	<b>CHAP. IV.</b>	
1651. The mariner's compass	166	<b>MAGNETIZATION.</b>	
1652. The dipping-needle	167	1678. Effects of induction	<i>ib.</i>
1653. Analysis of magnetic phenomena of the earth	<i>ib.</i>	1679. Their application in the production of artificial magnets	180
1654. Magnetic meridian	168	1680. Best material for artificial magnets	<i>ib.</i>
1655. Declination or variation	<i>ib.</i>	1681. Best form for bar magnets	<i>ib.</i>
1656. Magnetic polarity of the earth	<i>ib.</i>	1682. Horse-shoe magnets	<i>ib.</i>
1657. Change of direction of the dipping-needle	169	1683. Methods of producing artificial magnets by friction	181
Complete analogy of the earth to a magnet	170	1684. Method of single touch	<i>ib.</i>
		1685. Method of double touch	182
		1686. Inapplicable to compass needles and long bars	183
		1687. Magnetic saturation	<i>ib.</i>
		1688. Limit of magnetic force	<i>ib.</i>
		1689. Influence of the temper of the bar on the coercive force	184
		1690. Effects of terrestrial magnetism on bars	<i>ib.</i>
		1691. Means of preserving magnetic bars from these effects by armatures or keepers	185
		1692. Magnetism may be preserved by terrestrial induction	186
		1693. Compound magnets	<i>ib.</i>
		1694. Magnetized tracings on a steel plate	<i>ib.</i>
		1695. Influence of heat on magnetic bars	<i>ib.</i>
		Astatic needle	187

BOOK III.

Electricity.

CHAP. I.

ELECTRICAL ATTRACTIONS AND REPULSIONS.

Sect.		Page
1696.	Electrical effects - - -	189
1697.	Origin of the name "electricity" -	<i>ib.</i>
1698.	The electric fluid - - -	190
1699.	Positive and negative electricity -	191
1700.	Hypothesis of a single electric fluid -	<i>ib.</i>
1701.	Hypothesis of two fluids - - -	192
1702.	Results of scientific research independent of these hypotheses -	<i>ib.</i>
1703.	Hypothesis of two fluids preferred -	<i>ib.</i>
1704.	Explanation of the above effects produced by the pith balls -	<i>ib.</i>
1705.	Electricity developed by various bodies - - -	193
1706.	Origin of the terms vitreous and resinous fluids - - -	<i>ib.</i>
1707.	No certain test to determine which of the bodies submitted to friction receives positive and negative electricity - - -	<i>ib.</i>
1708.	Classification of positive and negative substances - - -	194
1709.	Method of producing electricity by glass and silk with amalgams -	195

CHAP. II.

CONDUCTION.

1710.	Conducting power - - -	196
1711.	Conductors and non-conductors -	<i>ib.</i>
1712.	Classification of conductors according to the degrees of their conducting power - - -	<i>ib.</i>
1713.	Insulators - - -	197
1714.	Insulating stools - - -	<i>ib.</i>
1715.	Electrics and non-electrics obsolete terms - - -	<i>ib.</i>
1716.	Two persons reciprocally charged with contrary electricities placed on insulating stools - - -	198
1717.	Atmosphere a non-conductor -	<i>ib.</i>
1718.	Rarefied air a non-conductor -	<i>ib.</i>
1719.	Use of the silk string which suspends pith balls - - -	199
1720.	Water a conductor - - -	<i>ib.</i>
1721.	Insulators must be kept dry -	<i>ib.</i>
1722.	No certain test to distinguish conductors from non-conductors -	<i>ib.</i>
1723.	Conducting power variously affected by temperature - - -	200
1724.	Effects produced by touching an electrified body by a conductor which is not insulated - - -	<i>ib.</i>
1725.	Effect produced when the touching conductor is insulated - - -	201
1726.	Why the earth is called the common reservoir - - -	<i>ib.</i>
1727.	Electricity passes by preference on the best conductors - - -	<i>ib.</i>

CHAP. III.

INDUCTION.

Sect.		Page
1728.	Action of electricity at a distance -	202
1729.	Induction defined - - -	<i>ib.</i>
1730.	Experimental exhibition of its effects - - -	203
1731.	Effects of sudden inductive action -	205
1732.	Example in the case of a frog -	<i>ib.</i>
1733.	Inductive shock of the human body - - -	206
1734.	Development of electricity by induction - - -	<i>ib.</i>

CHAP. IV.

ELECTRICAL MACHINES.

1735.	Parts of electrical machines - - -	207
1736.	The common cylindrical machine -	<i>ib.</i>
1737.	Nairne's cylinder machine - - -	209
1738.	Common plate machine - - -	<i>ib.</i>
1739.	Armstrong's hydro-electrical machine - - -	210
1740.	Appendages to electrical machines -	212
1741.	Insulating stools - - -	<i>ib.</i>
1742.	Discharging rods - - -	213
1743.	Jointed dischargers - - -	<i>ib.</i>
1744.	Universal discharger - - -	<i>ib.</i>

CHAP. V.

CONDENSER AND ELECTROPHOROUS.

1745.	Reciprocal inductive effects of two conductors - - -	214
1746.	Principle of the condenser - - -	216
1747.	Disimulated or latent electricity -	217
1748.	Free electricity - - -	<i>ib.</i>
1749.	Forms of condenser - - -	218
1750.	Collecting and condensing plates -	<i>ib.</i>
1751.	Cuthbertson's condenser - - -	<i>ib.</i>
1752.	The electrophorous - - -	219

CHAP. VI.

ELECTROSCOPES.

1753.	General principle of electroscopes -	220
1754.	Pith ball electroscope - - -	221
1755.	Needle electroscope - - -	<i>ib.</i>
1756.	Coulomb's electroscope - - -	222
1757.	Quadrant electrometer - - -	<i>ib.</i>
1758.	Gold leaf electroscopes - - -	<i>ib.</i>
1759.	Condensing electroscope - - -	223

CHAP. VII.

THE LEYDEN JAR.

1760.	The Leyden jar - - -	227
1761.	Effect of the metallic coating -	228

Sect.	Page
1762. Water may be substituted for the metallic coating - - -	229
1763. Experimental proof that the charge adheres to the glass and not to the coating - - -	<i>ib.</i>
1764. Improved form of Leyden jar -	230
1765. Charging a series of jars by cascade	231
1766. Electric battery - - -	<i>ib.</i>
1767. Common electric battery - -	232
1768. Method of indicating and estimating amount of charge - - -	<i>ib.</i>

## CHAP. VIII.

## LAWS OF ELECTRICAL FORCES.

1769. Electric forces investigated by Coulomb - - -	234
1770. Proof-plane - - -	235
1771. Law of electrical force similar to that of gravitation - - -	<i>ib.</i>
1772. Distribution of the electric fluid on conductors - - -	236
1773. It is confined to their surfaces -	<i>ib.</i>
1774. How the distribution varies - -	237
1775. Distribution on an ellipsoid - -	<i>ib.</i>
1776. Effects of edges and points - -	<i>ib.</i>
1777. Experimental illustration of the effect of a point - - -	238
1778. Rotation produced by the reaction of points - - -	239
1779. Another experimental illustration of this principle - - -	240
1780. Electrical orrery - - -	<i>ib.</i>

## CHAP. IX.

## MECHANICAL EFFECTS OF ELECTRICITY.

1781. Attractions and repulsions of electrified bodies - - -	241
1782. Action of an electrified body on a non-conductor not electrified -	<i>ib.</i>
1783. Action of an electrified body on a non-conductor charged with like electricity - - -	242
1784. Its action on a non-conductor charged with opposite electricity	<i>ib.</i>
1785. Its action on a non-conductor not electrified - - -	<i>ib.</i>
1786. Its action on a conductor charged with like electricity - - -	243
1787. Its action upon a conductor charged with opposite electricity - - -	244
1788. Attractions and repulsions of pith balls explained - - -	<i>ib.</i>
1789. Strong electric charges rupture imperfect conductors — Card pierced by discharge of jar -	245
1790. Curious fact observed by M. Tremery - - -	<i>ib.</i>
1791. Wood and glass broken by discharge - - -	246
1792. Electrical bells - - -	<i>ib.</i>
1793. Repulsion of electrified threads -	247
1794. Curious effect of repulsion of pith balls - - -	<i>ib.</i>
1795. Electrical dance - - -	<i>ib.</i>
1796. Curious experiments on electrified water - - -	248
1797. Experiment with electrified sealing wax - - -	<i>ib.</i>
1798. Electrical sec-saw - - -	249

## CHAP. X.

## THERMAL EFFECTS OF ELECTRICITY.

Sect.	Page
1799. A current of electricity passing over a conductor raises its temperature - - -	249
1800. Experimental verification — Wire heated, fused, and burnt - -	250
1801. Thermal effects are greater as the conducting power is less - - -	<i>ib.</i>
1802. Ignition of metals - - -	<i>ib.</i>
1803. Effect on fulminating silver - -	251
1804. Electric pistol - - -	<i>ib.</i>
1805. Ether and alcohol ignited - -	<i>ib.</i>
1806. Resinous powder burnt - - -	252
1807. Gunpowder exploded - - -	<i>ib.</i>
1808. Electric mortar - - -	<i>ib.</i>
1809. Kinnnersley's electrometer - -	<i>ib.</i>

## CHAP. XI.

## LUMINOUS EFFECTS OF ELECTRICITY.

1810. Electric fluid not luminous - -	253
1811. Conditions under which light is developed by an electric current -	<i>ib.</i>
1812. The electric spark - - -	254
1813. Electric aigrette - - -	255
1814. The length of the spark - - -	<i>ib.</i>
1815. Discontinuous conductors produce luminous effects - - -	<i>ib.</i>
1816. Various experimental illustrations	<i>ib.</i>
1817. Effect of rarefied air - - -	256
1818. Experimental imitation of the auroral light - - -	257
1819. Phosphorescent effect of the spark	<i>ib.</i>
1820. Leichtenberg's figures - - -	<i>ib.</i>
1821. Experiments indicating specific differences between the two fluids - - -	258
1822. Electric light above the barometric column - - -	<i>ib.</i>
1823. Cavendish's electric barometer -	259
1824. Luminous effects produced by imperfect conductors - - -	<i>ib.</i>
1825. Attempts to explain electric light — The thermal hypothesis - -	<i>ib.</i>
1826. Hypothesis of decomposition and recombination - - -	260
1827. Cracking noise attending electric spark - - -	261

## CHAP. XII.

## PHYSIOLOGICAL EFFECTS OF ELECTRICITY.

1828. Electric shock explained - - -	<i>ib.</i>
1829. Secondary shock - - -	262
1830. Effect produced on the skin by proximity to an electrified body	<i>ib.</i>
1831. Effect of the spark taken on the knuckle - - -	263
1832. Methods of limiting and regulating the shock by a jar - - -	<i>ib.</i>
1833. Effects of discharges of various force - - -	<i>ib.</i>
1834. Phenomena observed in the autopsy after death by the shock	<i>ib.</i>
1835. Effects of a long succession of moderate discharges - - -	<i>ib.</i>
1836. Effects upon a succession of patients receiving the same discharge - - -	<i>ib.</i>
1837. Remarkable experiments of Nollet, Dr. Watson, and others - - -	<i>ib.</i>

CHAP. XIII.

CHEMICAL AND MAGNETIC EFFECTS OF ELECTRICITY.	
Sect.	Page
1838. Phenomena which supply the basis of the electro-chemical theory -	264

Sect.	Page
1839. Faraday's experimental illustration of this -	265
1840. Effect of an electric discharge on a magnetic needle -	<i>ib.</i>
1841. Experimental illustration of this -	266

BOOK IV.

Voltaic Electricity.

CHAP. I.

SIMPLE VOLTAIC COMBINATION.	
Sect.	Page
1842. Discovery of galvanism -	267
1843. Volta's correction of galvanic theory -	268
1844. Theory of animal electricity exploded -	269
1845. Contact hypothesis of Volta -	<i>ib.</i>
1846. Electro-motive force -	<i>ib.</i>
1847. Classification of bodies according to their electro-motive property -	270
1848. Relation of electro-motive force to susceptibility of oxydation -	271
1849. Analogy of electro-motive action to induction -	<i>ib.</i>
1850. Electro-motive action of gases and liquids -	272
1851. Difference of opinion as to origin of electro-motive action -	273
1852. Polar arrangement of the fluids in all electro-motive combinations -	274
1853. Positive and negative poles -	<i>ib.</i>
1854. Electro-motive effect of a liquid interposed between two solid conductors -	<i>ib.</i>
1855. Electro-motive action of two liquids between two solids -	276
1856. Practical examples of such combinations -	<i>ib.</i>
1857. Most powerful combinations determined -	277
1858. Form of electro-motive combination -	<i>ib.</i>
1859. Volta's first combination -	278
1860. Wollaston's combination -	<i>ib.</i>
1861. Hare's spiral arrangement -	<i>ib.</i>
1862. Amalgamation of the zinc -	<i>ib.</i>
1863. Cylindrical combinations with one fluid -	279
1864. Cylindrical combinations with two fluids -	280
1865. Grove's battery -	<i>ib.</i>
1866. Bunsen's battery -	<i>ib.</i>
1867. Daniel's constant battery -	281
1868. Pouillet's modification of Daniel's battery -	<i>ib.</i>
1869. Advantages and disadvantages of these several systems -	282
1870. Smee's battery -	<i>ib.</i>
1871. Wheatstone's system -	283
1872. Bagnaton's system -	<i>ib.</i>
1873. Becquerel's system -	<i>ib.</i>
1874. Schönbein's modification of Bunsen's battery -	284

Sect.	Page
1875. Grove's gas electro-motive apparatus -	284

CHAP. II.

VOLTAIC BATTERIES.

1876. Volta's invention of the pile -	285
1877. Explanation of the principle of the pile -	286
1878. Effect of the imperfect liquid conductors -	287
1879. Method of developing electricity in great quantity -	288
1880. Distinction between quantity and intensity important -	<i>ib.</i>
1881. Volta's first pile -	289
1882. The couronne des tasses -	<i>ib.</i>
1883. Cruikshank's arrangement -	290
1884. Wollaston's arrangement -	<i>ib.</i>
1885. Helical pile of Faculty of Sciences at Paris -	291
1886. Mode of forming piles -	<i>ib.</i>
1887. Conductors connecting the elements -	292
1888. Pile may be placed at any distance from place of experiment -	<i>ib.</i>
1889. Memorable piles—Davy's pile at Royal Institution -	293
1890. Napoleon's pile at Polytechnic School -	<i>ib.</i>
1891. Children's great plate battery -	<i>ib.</i>
1892. Hare's deflagrator -	<i>ib.</i>
1893. Strathg's deflagrator -	<i>ib.</i>
1894. Pepsy's pile at London Institution -	294
1895. Powerful batteries on Daniel's and Grove's principles -	<i>ib.</i>
1896. Dry piles -	<i>ib.</i>
1897. Deluc's pile -	295
1898. Zamboni's pile -	<i>ib.</i>
1899. Piles of a single metal -	<i>ib.</i>
1900. Ritter's secondary piles -	296

CHAP. III.

VOLTAIC CURRENTS.

1901. The voltaic current -	<i>ib.</i>
1902. Direction of the current -	297
1903. Poles of the pile, how distinguished -	298
1904. Voltaic current -	<i>ib.</i>
1905. Case in which the earth completes the circuit -	299
1906. Methods of connecting the poles with the earth -	300

Sect.	Page	Sect.	Page
1907. Various denominations of currents	300	1938. Intensity of the force vanishes when distance of pole bears a very great ratio to diameter of current	322
1908. The electric fluid forming the current not necessarily in motion	<i>ib.</i>	1939. But directive power of pole continues	<i>ib.</i>
1909. Method of coating the conducting wire	301	1940. Spiral and heliacal currents	<i>ib.</i>
1910. Supports of conducting wire	<i>ib.</i>	1941. Expedient to render circulating currents moveable	323
1911. Ampère's reotrope to reverse the current	<i>ib.</i>	1942. Rotatory motion imparted to circular current by a magnetic pole	<i>ib.</i>
1912. Pohl's reotrope	303	1943. Progressive motion imparted to it	324
1913. Electrodes	<i>ib.</i>	1944. Reciprocal action of the current on pole	<i>ib.</i>
1914. Floating supports for conducting wire	304	1945. Action of a magnet on a circular floating current	<i>ib.</i>
1915. Ampère's apparatus for supporting moveable currents	<i>ib.</i>	1946. Reciprocal action of the current on magnet	325
<b>CHAP. IV.</b>			
<b>RECIPROCAL INFLUENCE OF RECTILINEAR CURRENTS AND MAGNETS.</b>			
1916. Mutual action of magnets and currents	305	1947. Case of instable equilibrium of the current	<i>ib.</i>
1917. Electro-magnetism	<i>ib.</i>	1948. Case of a spiral current	<i>ib.</i>
1918. Direction of the mutual forces exerted by a rectilinear current on the poles of a magnet	306	1949. Circular or spiral currents exercise same action as a magnet	326
1919. Circular motion of magnetic pole round a fixed current	308	1950. Case of heliacal current	<i>ib.</i>
1920. Circular motion of a current round a magnetic pole	<i>ib.</i>	1951. Method of neutralizing effect of the progressive motion of such a current	<i>ib.</i>
1921. Apparatus to illustrate experimentally these effects	309	1952. Right-handed and left-handed helices	<i>ib.</i>
1922. Apparatus to exhibit direction of force impressed by a rectilinear current on a magnetic pole	<i>ib.</i>	1953. Front of current on each kind	<i>ib.</i>
1923. Apparatus to measure the intensity of this force	310	1954. Magnetic properties of heliacal currents, their poles determined	<i>ib.</i>
1924. Intensity varies inversely as the distance	311	1955. Experimental illustration of those properties	327
1925. Case in which the current is within but not at the centre of the circle in which the pole revolves	312	1956. The front of a circulating current has the properties of a south and the back those of a north magnetic pole	<i>ib.</i>
1926. Action of a current on a magnet, both poles being free	<i>ib.</i>	1957. Adaptation of an heliacal current to Ampère's and Delarive's apparatus	328
1927. Case in which the current is outside the circle described by the poles	313	1958. Action of an heliacal current on a magnetic needle placed in its axis	329
1928. Case in which the current passes through the circle	314	<b>CHAP. VI.</b>	
1929. Case in which the current passes within the circle	<i>ib.</i>	<b>ELECTRO-MAGNETIC INDUCTION.</b>	
1930. Apparatus to illustrate electro-magnetic rotation	315	1959. Inductive effect of a voltaic current upon a magnet	331
1931. To cause either pole of a magnet to revolve round a fixed voltaic current	316	1960. Magnetic induction of an heliacal current	<i>ib.</i>
1932. To cause a moveable current to revolve round the fixed pole of a magnet	<i>ib.</i>	1961. Polarity produced by the induction of heliacal current	332
1933. Ampère's method	318	1962. Consequent points produced	<i>ib.</i>
1934. To make a magnet turn on its own axis by a current parallel to it	319	1963. Inductive action of common electricity produces polarity	<i>ib.</i>
<b>CHAP. V.</b>			
<b>RECIPROCAL INFLUENCE OF CIRCULATING CURRENTS AND MAGNETS.</b>			
1935. Front and back of circulating current	321	1964. Conditions on which a needle is magnetized positively and negatively	333
1936. Axis of current	<i>ib.</i>	1965. Results of Savary's experiments	<i>ib.</i>
1937. Reciprocal action of circulating current and magnetic pole	<i>ib.</i>	1966. Magnetism imparted to the needle affected by the non-magnetic substance which surrounds it	334
		1967. Formation of powerful electro-magnets	335
		1968. Conditions which determine the force of magnet	<i>ib.</i>
		1969. Electro-magnet of Faculty of Sciences at Paris	<i>ib.</i>
		1970. Form of electro-magnets in general	336
		1971. Electro-magnetic power applied as mechanical agent	<i>ib.</i>

Sect.		Page
1972.	Electro-motive power applied in workshop of M. Froment -	337
1973.	Electro-motive machines constructed by him -	339
1974.	Applied as a sonometer -	343
1975.	Momentary current by induction -	<i>ib.</i>
1976.	Experimental illustration -	344
1977.	Momentary currents produced by magnetic induction -	345
1978.	Experimental illustrations -	<i>ib.</i>
1979.	Inductive effects produced by a permanent magnet revolving under an electro-magnet -	346
1980.	Use of a contact breaker -	348
1981.	Magneto-electric machine -	<i>ib.</i>
1982.	Effects of this machine, its medical use -	350
1983.	Inductive effects of the successive convolutions of the same helix -	<i>ib.</i>
1984.	Effects of momentary inductive currents produced upon revolving metallic disks : researches of Arago, Herschel, Babbage, and Faraday -	351

## CHAP. VII.

## INFLUENCE OF TERRESTRIAL MAGNETISM ON VOLTAIC CURRENTS.

1985.	Direction of the earth's magnetic attraction -	353
1986.	In this part of the earth it corresponds to that of the boreal pole of an artificial magnet -	354
1987.	Direction of the force impressed by it upon a current -	<i>ib.</i>
1988.	Effect of terrestrial magnetism on a vertical current -	355
1989.	Effect upon a horizontal current directed north and south -	<i>ib.</i>
1990.	Case of a horizontal current directed east and west -	<i>ib.</i>
1991.	Case of a horizontal current in any intermediate direction -	<i>ib.</i>
1992.	Effect of the earth's magnetism on a vertical current which turns round a vertical axis -	356
1993.	Effect on a current which is capable of moving in an horizontal plane -	<i>ib.</i>
1994.	Experimental illustrations of these effects; Pouillet's apparatus -	<i>ib.</i>
1995.	Its application to show the effect of terrestrial magnetism on a horizontal current -	358
1996.	Its effects on vertical currents shown by Ampère's apparatus -	359
1997.	Its effects on a circular current shown by Ampère's apparatus -	<i>ib.</i>
1998.	Its effect on a circular or spiral current shown by Delarive's floating apparatus -	<i>ib.</i>
1999.	Astatic currents formed by Ampère's apparatus -	360
2000.	Effect of earth's magnetism on spiral currents shown by Ampère's apparatus -	<i>ib.</i>
2001.	Effect on horizontal current shown by Pouillet's apparatus -	361
2002.	Effect of terrestrial magnetism on an heliacal current shown by Ampère's apparatus -	362

Sect.		Page
2003.	The dip of a current illustrated by Ampère's rectangle -	362

## CHAP. VIII.

## RECIPROCAL INFLUENCE OF VOLTAIC CURRENTS.

2004.	Results of Ampère's researches -	363
2005.	Reciprocal action of rectilinear currents -	364
2006.	Action of a spiral or heliacal current on a rectilinear current -	<i>ib.</i>
2007.	Mutual action of diverging or converging rectilinear currents -	365
2008.	Experimental illustrations of this -	<i>ib.</i>
2009.	Mutual action of rectilinear currents which are not in the same plane -	366
2010.	Mutual action of different parts of the same current -	367
2011.	Ampère's experimental verification of this -	<i>ib.</i>
2012.	Action of an indefinite rectilinear current on a finite rectilinear current at right angles to it -	368
2013.	Case in which the indefinite current is circular -	369
2014.	Experimental verification of these principles -	<i>ib.</i>
2015.	To determine in general the action of an indefinite rectilinear current on a finite rectilinear current -	370
2016.	Experimental illustration of these principles -	373
2017.	Effect of a straight indefinite current on a system of diverging or converging currents -	<i>ib.</i>
2018.	Experimental illustration of this action -	374
2019.	Consequences deducible from this action -	<i>ib.</i>
2020.	Action of an indefinite straight current on a circulating current -	375
2021.	Case in which the indefinite straight current is perpendicular to the plane of the circulating current -	376
2022.	Case in which the straight current is oblique to the plane of the circulating current -	377
2023.	Reciprocal effects of curvilinear currents -	<i>ib.</i>
2024.	Mutual action of curvilinear currents in general -	378

## CHAP. IX.

## VOLTAIC THEORY OF MAGNETISM.

2025.	Circulating currents have the magnetic properties -	<i>ib.</i>
2026.	Magnetism of the earth may proceed from currents -	379
2027.	Artificial magnets explained on this hypothesis -	<i>ib.</i>
2028.	Effect of the presence or absence of coercive force -	380
2029.	This hypothesis cannot be admitted as established until the existence of the molecular currents shall be proved -	<i>ib.</i>

CHAP. X.		Sect.	Page
REOSCOPES AND REOMETERS.			
Sect.			Page
2030.	Instruments to ascertain the presence and to measure the intensity of currents -		380
2031.	Expedient for augmenting the effect of a feeble current -		381
2032.	Method of constructing a reoscope, galvanometer, or multiplier -		382
2033.	Nobili's reometer -		383
2034.	Differential reometer -		384
2035.	Great sensitiveness of these instruments illustrated -		<i>ib.</i>
CHAP. XI.			
THERMO-ELECTRICITY.			
2036.	Disturbances of the thermal equilibrium of conductors produces a disturbance of the electric equilibrium -		<i>ib.</i>
2037.	Thermo-electric current -		385
2038.	Experimental illustration -		<i>ib.</i>
2039.	Conditions which determine the direction of current -		<i>ib.</i>
2040.	A constant difference of temperature produces a constant current -		386
2041.	Different metals have different thermo-electric energies -		<i>ib.</i>
2042.	Pouillet's thermo-electric apparatus -		<i>ib.</i>
2043.	Relation between the intensity of the current, and length and section of the conducting wires -		388
2044.	Conducting powers of metals -		389
2045.	Current passing through a compound circuit of uniform intensity -		<i>ib.</i>
2046.	Equivalent simple circuit -		390
2047.	Ratio of intensities in two compound circuits -		<i>ib.</i>
2048.	Intensity of the current on a given conductor varies with the thermo-electric energy of the source -		<i>ib.</i>
2049.	Thermo-electric piles -		391
2050.	Thermo-electric pile of Nobili and Melloni -		392
CHAP. XII.			
ELECTRO-CHEMISTRY.			
2051.	Decomposing power of a voltaic current -		393
2052.	Electrolytes and electrolysis -		<i>ib.</i>
2053.	Liquids alone susceptible of electrolysis -		<i>ib.</i>
2054.	Faraday's electro-chemical nomenclature -		<i>ib.</i>
2055.	Positive and negative electrodes -		394
2055.	Only partially accepted -		<i>ib.</i>
2057.	Composition of water -		<i>ib.</i>
2058.	Electrolysis of water -		395
2059.	Explanation of this phenomenon by the electro-chemical hypothesis -		396
2060.	Method of electrolysis which separates the constituents -		397
2061.	How are the constituents transferred to the electrodes -		398
2062.	Solution of the hypothesis of Grotthus -		399
2063.	Effect of acid and salt on the electrolysis of water -		400
	Cases in which the matter of the electrodes combines with the constituents of the electrolyte -		<i>ib.</i>
2064.	Secondary action of the hydrogen at the negative electrode -		401
2065.	Its action on bodies dissolved in the bath -		402
2066.	Example of zinc and platinum electrodes in water -		<i>ib.</i>
2067.	Secondary effects of the current -		<i>ib.</i>
2068.	Compounds which are susceptible of electrolysis -		<i>ib.</i>
2069.	Electrolytic classification of the simple bodies -		403
2070.	Electro-negative bodies -		<i>ib.</i>
2071.	Electro-positive bodies -		<i>ib.</i>
2072.	The order of the series not certainly determined -		404
2073.	Electrolytes which have compound constituents -		<i>ib.</i>
2074.	According to Faraday, electrolytes whose constituents are simple can only be combined in a single proportion -		<i>ib.</i>
2075.	Apparent exceptions explained by secondary action -		405
2076.	Secondary effects favored by the nascent state of the constituents. Results of the researches of Becquerel and Crosse -		<i>ib.</i>
2077.	The successive action of the same current on different vessels of water -		406
2078.	The same current has an uniform electrolytic power -		407
2079.	Voltmeter of Faraday -		<i>ib.</i>
2080.	Effect of the same current on different electrolytes -		<i>ib.</i>
2081.	It comprises secondary results -		408
2082.	Practical example of its application -		<i>ib.</i>
2083.	Sir H. Davy's experiments, showing the transfer of the constituents of electrolytes through intermediate solutions -		409
2083*.	While being transferred they are deprived of their chemical property -		410
2084.	Exception in the case of producing insoluble compounds -		411
2085.	This transfer denied by Faraday -		412
2086.	Apparent transfer explained by him on Grotthus' hypothesis -		<i>ib.</i>
2087.	Faraday thinks that conduction and decomposition are closely related -		413
2088.	Maintains that non-metallic liquids only conduct when capable of decomposition by the current -		<i>ib.</i>
2089.	Faraday's doctrine not universally accepted; Pouillet's observations -		<i>ib.</i>
2090.	Davy's experiments repeated and confirmed by Becquerel -		414
2091.	The electrodes proved to exercise different electrolytic powers by Pouillet -		415
2092.	Case in which the negative electrode alone acts -		416
2093.	Cases in which the electrodes act unequally; -		<i>ib.</i>

Sect.	Page	Sect.	Page
2094. Liquid electrodes; series of electrolytes in immediate contact -	416	2128. Conducting wires - - -	432
2095. Experimental illustration of this -	417	2129. Telegraphic signs - - -	433
2096. Electrolysis of the alkalis and earths - - -	418	2130. Signs made with the needle system -	433
2097. The series of new metals - - -	<i>ib.</i>	2131. Telegraphs operating by an electro-magnet - - -	435
2098. Schönbein's experiments on the passivity of iron - - -	419	2132. Morse's system - - -	436
2099. Other methods of rendering iron passive - - -	420	2133. Electro-chemical telegraphs -	437
2100. Tree of Saturn - - -	<i>ib.</i>		
2101. Davy's method of preserving the copper sheathing of ships -	421		
2102. Chemical effects produced in voltaic batteries - - -	<i>ib.</i>		
2108. Effect of amalgamating the zinc -	422		
2104. Effects in Sinec's battery - - -	<i>ib.</i>		
2105. In Wheatstone's battery - - -	423		
2106. In the two fluid batteries - - -	<i>ib.</i>		
2107. Grove's battery - - -	424		
2108. Bunsen's battery - - -	<i>ib.</i>		
2109. Daniel's battery - - -	<i>ib.</i>		
<b>CHAP. XIII.</b>			
* ELECTRO-METALLURGY.			
2110. Origin of this art - - -	425		
2111. The metallic constituent deposited on the negative electrode -	426		
2112. Any body may be used as the negative electrode - - -	<i>ib.</i>		
2113. Use of a soluble positive electrode -	<i>ib.</i>		
2114. Conditions which affect the state of the metal deposited - - -	<i>ib.</i>		
2115. The deposit to be of uniform thickness - - -	427		
2116. Means to prevent absorption of the solution by the electrode - - -	<i>ib.</i>		
2117. Non-conducting coating used where partial deposit is required -	<i>ib.</i>		
2118. Application of these principles to gilding, silvering, &c. - - -	<i>ib.</i>		
2119. Cases in which the coating is inadhesive - - -	428		
2120. Application to gilding, silvering, or bronzing objects of art - - -	<i>ib.</i>		
2121. Production of metallic moulds of articles - - -	<i>ib.</i>		
2122. Production of objects in solid metal -	429		
2123. Reproduction of stereotypes and engraved plates - - -	<i>ib.</i>		
2124. Metallizing textile fabrics - - -	<i>ib.</i>		
2125. Glypography - - -	430		
2126. Reproduction of Daguerreotypes -	<i>ib.</i>		
<b>CHAP. XIV.</b>			
ELECTRO-TELEGRAPHY.			
2127. Common principle of all electric telegraphs - - -	431		

## CHAP. XV.

## CALORIFIC, LUMINOUS, AND PHYSIOLOGICAL EFFECTS OF THE VOLTAIC CURRENT.

2134. Conditions on which calorific power of current depends -	439
2135. Caloric effects — Haro's and Children's deflagrators - - -	<i>ib.</i>
2136. Wollaston's thimble battery -	440
2137. Experimental illustration of the conditions which affect calorific power of a current - - -	<i>ib.</i>
2138. Substances ignited and exploded by the current - - -	441
2139. Application of this in civil and military engineering - - -	<i>ib.</i>
2140. Jacobi's experiments on conduction by water - - -	442
2141. Combustion of the metals - - -	<i>ib.</i>
2142. Spark produced by the voltaic current - - -	443
2143. The electric light - - -	<i>ib.</i>
2144. Action of a magnet on the electric flame - - -	444
2145. Incandescence of charcoal by the current not combustion - - -	445
2146. Electric lamps of Messrs. Foucault, Deleuil, and Duboscq-Soleil - - -	<i>ib.</i>
2147. Method of applying the heat of charcoal to the fusion of refractory bodies and the decomposition of the alkalis - - -	<i>ib.</i>
2148. Physiological effects of the current -	446
2149. Medical application of the voltaic shock - - -	447
2150. Effect on bodies recently deprived of life - - -	<i>ib.</i>
Effect of the shock upon a leech -	448
2151. Excitation of the nerves of taste -	<i>ib.</i>
2152. Excitation of the nerves of sight -	<i>ib.</i>
2153. Excitation of the nerves of hearing -	<i>ib.</i>
2154. Supposed sources of electricity in the animal organization - - -	449
2155. Electrical fishes - - -	<i>ib.</i>
2156. Properties of the torpedo — Observations of Walsh - - -	<i>ib.</i>
2157. Observations of Becquerel and Breschet - - -	450
2158. Observations of Matteucci - - -	<i>ib.</i>
2159. The electric organ - - -	<i>ib.</i>





HAND-BOOK  
OF  
NATURAL PHILOSOPHY  
AND  
ASTRONOMY.

---

---

SECOND COURSE.

—♦—

BOOK THE FIRST.

HEAT.

CHAPTER I.

PRELIMINARY PRINCIPLES AND DEFINITIONS.

1304. HEAT, like all other physical agents, is manifested and measured by its effects.

1305. *Sensible heat*.—One of the most familiar of these effects is the sense of more or less warmth which a body, when it receives or loses heat, produces upon our organs.

When the heat received or lost by a body is attended with this sense of increased or diminished warmth, it is called *sensible heat*.

1306. *Insensible heat*.—But it will occur in certain cases that a body may receive a very large accession of heat without any increased sense of warmth being produced by it, and may, on the other hand, lose a considerable quantity of heat without exciting any diminished sense of warmth. The heat which a body would thus receive or lose without affecting the senses, is called *latent heat*.

1307. *Dilatation and contraction*.—When a body receives

or loses heat, it generally suffers a change in its dimensions, the increase of heat being usually attended with an increase, and the diminution of heat with a diminution of volume.

This enlargement of volume due to the accession of heat is called *dilatation*, and the diminution of volume attending the loss of heat is called *contraction*.

There are, however, certain exceptional cases in which heat, whether received or lost, is attended with no change of volume, and others in which changes take place the reverse of those just mentioned; that is to say, where an accession of heat is accompanied by a diminution, and a loss of heat with an increase of volume.

1308. *Liquefaction and solidification*.—If heat be imparted in sufficient quantity to a solid body, it will pass into the liquid state. Thus, ice or lead, being solid, will become liquid by receiving a sufficient accession of heat. This change is called *fusion* or *liquefaction*.

If heat be abstracted in sufficient quantity from a body in the liquid state, it will pass into the solid state. Thus, water or molten lead losing heat in sufficient quantity will become solid. This change is called *congelation* or *solidification*; the former term being applied to substances which are usually liquid, and the latter to those that are usually solid.

1309. *Vaporization and condensation*.—If heat be imparted in sufficient quantity to a body in the liquid state, it will pass into the state of vapour. Thus, water being heated sufficiently will pass into the form of steam. This change is called *vaporization*.

If a body in the state of vapour lose heat in sufficient quantity, it will pass into the liquid state. Thus, if a certain quantity of heat be abstracted from steam, it will become water.

This change is called *condensation*; because, in passing from the vaporous to the liquid state, the body always undergoes a very considerable diminution of volume, and therefore becomes condensed.

1310. *Incandescence*.—Heat, when imparted to bodies in a certain quantity, will in some cases render them luminous.

Thus, if metal be heated to a certain degree, it will become *red-hot*; a term signifying merely that it emits red light. This luminous state, which is consequent on the accession of heat, is called *incandescence*.

The more intense the heat is which is imparted to an incan-

descent body, the more *white* will be the light which it emits. When it first becomes luminous, it emits a dusky red light. The redness becomes brighter as the heat is augmented, until at length, when the heat becomes extremely intense, it emits a white light resembling solar light.

A bar of iron submitted to the action of a furnace will exhibit a succession of phenomena illustrative of this.

1311. *Combustion*. — Certain bodies, when surrounded by atmospheric air, being heated to a certain degree, will enter into chemical combination with the oxygen gas which forms one of the constituents of the atmosphere.

This combination will be attended with a large development of heat, which is accompanied usually by incandescence and flame.

This phenomenon is called *combustion*, and the bodies which are susceptible of this effect are called *combustibles*.

The flame, which is one of the effects of combustion, is gas rendered incandescent by heat.

1312. *Thermometers and pyrometers*. — The degree of sensible heat by which a body is affected, is called its *temperature*, and the instruments by which the temperature of bodies is indicated and measured are called *thermometers* and *pyrometers*; the latter term being applied to those which are adapted to the measurement of the higher order of temperatures.

Changes of temperature are indicated and measured by the change of volume which they produce upon bodies very susceptible of dilatation. Such bodies are called *thermoscopic bodies*. The principal of these are, for thermometers, mercury, alcohol, and air; and, for pyrometers, the metals, and especially those which are most difficult of fusion.

1313. *Conduction*. — When heat is communicated to any part of a body, the temperature of that part is momentarily raised above the general temperature of the body. This excessive heat, however, is gradually transmitted from particle to particle throughout the entire volume, until it becomes uniformly diffused, and the temperature of the body becomes equalized.

This quality, in virtue of which heat is transmitted from particle to particle throughout the volume of a body, is called *conductibility*.

Bodies have the quality of conductivity in different degrees ; those being called good conductors in which any inequality of temperature is quickly equalized, the excess of heat being transmitted with great promptitude and facility from particle to particle. Those in which it passes more slowly and imperfectly through the dimensions of a body, and in which, therefore, the equilibrium of temperature is more slowly established, are called imperfect conductors. Bodies, in which the excess of heat fails to be transmitted from particle to particle before it has been dissipated in other ways, are called non-conductors.

The metals in general are good conductors, but different metals have different degrees of conductivity. The earths and woods are bad conductors, and soft, porous, and spongy substances still worse.

1314. *Radiation.* — Heat is propagated from bodies which contain it by radiation in the same manner, and according to nearly the same rules, as those which govern the radiation of light. Thus, it proceeds in straight lines from the points whence it emanates, diverging in every direction, these lines being called thermal rays.

1315. *Diathermanous media.* — Certain bodies are pervious to the rays of heat, just as glass and other transparent media are pervious to the rays of light. They are called diathermanous bodies. Thus atmospheric air and gaseous bodies in general are diathermanous.

The rays of heat are reflected and refracted according to the same laws as those of light. They are collected into foci by spherical mirrors and lenses, they are polarized both by reflection and refraction, and are subject to all the phenomena of double refraction by certain crystals in a manner analogous to that already explained in relation to the rays of light.

Bodies are diathermanous in different degrees.

Imperfectly diathermanous bodies transmit some of the rays of heat which impinge on them, and absorb others ; the portions which they absorb raising their temperature, but those which they transmit not affecting their temperature.

1316. *Reflection of heat.* — The surfaces of bodies also reflect heat in different degrees ; those rays which they do not reflect they absorb. The processes of transmission, absorption, and reflection vary with the nature of the body and the state of its surface with respect to smoothness, roughness, or colour.

1317. *Refraction of heat.*—Rays of heat, like those of light, are differently refrangible.

1318. *Different senses of the terms heat and caloric.*—The term heat is used in different senses: first, to express the sensation produced when we touch a heated body or are surrounded by a hot medium; secondly, to express the quality of the body by which this sensation is produced; and thirdly, to express the physical agent, whatever it be, to which the quality of the body is due. Notwithstanding these different senses of the same term, no confusion or obscurity arises in its use, the particular sense in which it is applied being generally evident by the context; nevertheless it were to be desired that writers on physics could agree upon a nomenclature more definite.

The term *caloric* has been proposed, and to some extent adopted, to express the physical agent to which the effects of heat are due.

1319. *Hypothesis to explain thermal phenomena.*—Two hypotheses have been proposed to explain the phenomena of heat. The first regards heat as an extremely subtle fluid pervading all space, entering into combination in various proportions and quantities with bodies, and producing by this combination the effects of expansion, fusion, vaporization, and all the other phenomena above mentioned. The second hypothesis regards it as the effect of the vibration or undulation, produced either in the constituent molecules of bodies themselves, or in a subtle impenetrable fluid which pervades them.

In the present Book the effects of heat will be explained independently of hypothesis; and, when they have been fully developed, the different theories proposed for their explanation will be stated.

## CHAP. II.

### THERMOMETRY.

1520. *Measures of temperature.*—Of all the various effects of heat, that which is best adapted to indicate and measure temperature is dilatation and contraction. The same body always has the same volume at the same temperature, and always

suffers the same change of volume with the same change of temperature.

Since the volume and change of volume admit of the most exact measurement and of the most precise numerical expression, they become the means of submitting the degrees of warmth and cold, or, which is the same, the degrees of temperature, to arithmetical measure and expression.

1321. *Thermoscopic substances.*—Although all bodies whatever are susceptible of dilatation and contraction by change of temperature, they are not equally convenient for thermoscopic agents.

For reasons which will become apparent hereafter, the most available thermoscopic substance for general purposes is mercury.

1322. *Mercurial thermometer.*—The mercurial thermometer consists of a capillary tube of glass, at one end of which a thin spherical or cylindrical bulb is blown, the bulb and a part of the tube being filled with mercury.

When such an instrument is exposed to an increase of temperature, the glass and mercury will both expand. If they expanded in the same proportion, the capacity of the bulb and tube would be enlarged in the same proportion as the mercury contained in them, and, consequently, the column of mercury in the tube would neither rise nor fall, since the enlargement of its volume would be exactly equal to the enlargement of the capacity of the bulb and tube. If, however, the expansion of the bulb and tube be different from that of the mercury, the column in the tube will, after expansion, stand higher or lower than before, according as the expansion of the mercury is greater or less than the expansion of the bulb and tube.

It is found that the dilatibility of mercury is greater than the dilatibility of glass in the proportion of nearly 20 to 1, and, consequently, the capacity of the bulb and tube will be less enlarged than the volume of the mercury contained in them in the proportion of nearly 1 to 20; consequently, for the reason above stated, every elevation of temperature by which the mercury and tube would be affected will cause the column of mercury to rise in the tube, and every diminution of temperature will cause it to fall.

The space through which the mercury will rise in the tube by a given increase of temperature will be greater or less ac-

ording to the proportion which the tube bears to the capacity of the bulb. The smaller the proportion the tube bears to the capacity of the bulb, the greater will be the elevation of the column produced by a given increase of temperature; for a given increase of temperature will produce a definite increase of volume in the mercury, and this increase of volume will fill a greater space in the tube in proportion to the smallness of the tube compared with the capacity of the bulb.

Such an instrument, without other appendages or preparation, would merely indicate such changes of temperature in a given place as would be sufficient to produce visible changes in the elevation of the column of mercury sustained in the tube. To render it useful for the purposes of science and art, and in domestic economy, various precautions are necessary, which have for their object to render the indications of different thermometers comparable with each other, and to supply exact numerical indications of measurement of the changes of temperature.

1323. *Preparation of the mercury.*—For this purpose it is necessary, in the first instance, that the mercury with which the tube is filled shall be perfectly pure and homogeneous. This object is attained by the same means as have been already explained in the case of the barometer (715.).

1324. *Selection of the tube.*—In the selection of the tube it is necessary that it be capillary, that is to say, a tube having an extremely small bore, and that the bore should be of uniform magnitude throughout its entire length.

The smallness of the bore is essential to the sensibility of the instrument, as already explained; and its uniformity is necessary in order that the same change of volume of the mercury should correspond to the same length of the column in every part of the tube.

The uniformity of the bore of the tube may be tested by letting into it a small drop of mercury, sufficient to fill about a third of an inch of the tube. Let this be made to fall gradually through the entire length of the tube, stopping its motion at intervals, and let the space it occupies at different parts of the tube be measured. If this space be everywhere the same, the bore is uniform; if not, the tube must be rejected.

1325. *Formation of the bulb.*—The bulb, whether spherical or cylindrical, can be formed upon the end of the tube by the



ordinary process of glassblowing. The sensibility of the thermometer requires that the capacity of the bulb should bear a large proportion to the calibre of the tube. If, however, the capacity of the bulb be considerable, the quantity of mercury it contains may be so great that it will not be affected by the temperature of the surrounding medium with sufficient promptitude.

A cylindrical bulb of the same capacity will be more readily affected by the temperature of the surrounding medium than a spherical bulb, since it will expose a greater surface.

The glass of which the bulb is formed should be as thin as is compatible with the necessary strength, in order that the heat may pass more freely from the external medium to the mercury.

1326. *Introduction of the mercury.*—The tube to be filled is represented in *fig. 425.*, where B A C is the tube, and C D a reservoir formed at the top for the purpose of filling it, which is to be afterwards detached. Let the tube be first dried by holding it over the flame of a spirit-lamp, so as to evaporate and expel all moisture which may be attached to the inner surface of the glass. To fill it, let a quantity of purified mercury be poured into the reservoir C D. This will not fall through the bore, being prevented by the air included in the reservoir A B and in the tube. To expel this, and cause the mercury to take its place, let the tube be placed in an inclined position over a charcoal fire or the flame of a spirit-lamp, so that the air shall be heated. When heated it will expand, force itself in bubbles through the mercury in C D, and escape into the atmosphere. This will continue until all the air in the bulb A B and in the tube A C has been expelled.



*Fig. 425.* The pressure of the atmosphere acting on the mercury in C D will then force it through the tube into the bulb A B, which, as well as the entire length of the tube, it will ultimately fill. If a sufficient quantity of mercury be supplied to the reservoir C D, the bulb A B, the tube A C, and a part of the reservoir C D, will be filled with mercury after all the air has been expelled.

When this has been accomplished, let the tube be removed from the source of heat, and allowed gradually to cool. A file

applied at *c*, where the top of the tube is joined to the superior reservoir, detaches that reservoir from the tube, which remains with the bulb *A B* completely filled with mercury.

In this state the instrument would give no indication of change of temperature, no space being left for exhibiting the play of the mercury by dilatation and contraction.

To obtain space for this, let the bulb *A B* be exposed to a temperature higher than any which the instrument is intended to indicate. The mercury dilating will then overflow, and will continue to overflow until the mercury acquires the extreme temperature to which it is exposed.

A jet of flame being now directed by a blow-pipe on the end *c*, it will be hermetically sealed; after which, being allowed to cool, the mercurial column will subside, the space in the tube above it being a vacuum, since the air is expelled. The column will continue to subside until the mercury assumes that state which corresponds to the temperature of the air surrounding the instrument.

1327. *Thermometric scale arbitrary.* — The variation of the height of the mercurial column in such a tube will in all cases correspond with the changes of temperature incidental to the surrounding medium; but, in order that it may supply a numerical expression and measure of such changes, a scale must be attached to the tube, by which the variations of the column may be indicated, and the divisions or the units of such scale must correspond to some known change of temperature. It is evident that such a scale, like all other standards for the arithmetical measure of physical effects, must be to some extent arbitrary. We accordingly find different scales and different thermometric units prevailing in different countries, and even in the same country at different times.

1328. *Standard points. — Division of scale.* — Whatever thermometric unit be adopted, it is necessary that two standard temperatures be selected, to which the mercury can be reduced at the times and places where thermometers may be required to be constructed or verified. The instrument being exposed to these two temperatures, the points at which the mercurial column stands are marked upon the scale. The space upon the scale between these points is thus divided into a certain number of equal parts, which are called degrees, these degrees being the thermometric unit. The same divisions are then

continued upon the scale above the higher and below the lower standard point, and such divisions may be continued indefinitely. The scale is then complete.

In this process, the number of equal parts into which the space between the standard points is divided, is altogether arbitrary.

1329. *Numeration of scale. — Zero point.* — It now remains to number the scale; and, for this purpose, a zero point must be selected. If there existed a minor limit to temperature, a temperature below which no body could possibly fall, then such a temperature would supply a natural thermometric zero, and the scale might be numbered upwards from it.

1330. *No natural zero.* — In that case, although the thermometric unit would still remain arbitrary, the zero of the scale would not be so. But no such natural thermometric zero exists.

There is no natural limit either to the increase or diminution of temperature. The zero, therefore, of the thermometric scale, like the thermometric scale itself, must be arbitrary.

1331. *Phenomena fit to supply standard points.* — Thermal phenomena present great varieties of standard temperatures, by which thermometric scales may be established, and which may serve equally as terms of temperature for the purpose of distinguishing the indications of different thermometers constructed at different times and places. Thus, the temperatures at which all solid bodies fuse, and those at which all liquids congeal, are fixed. For different bodies these are different, but always the same for the same body. In like manner, the temperatures at which all liquids boil under a given pressure are invariable for the same liquids, though different for different liquids. The temperature of the blood in the human species presents another example of a fixed temperature.

1332. *Freezing and boiling points of water adopted by common consent.* — Now any two of these various temperatures naturally fixed might be taken as the thermometric standards, the choice being altogether arbitrary. Thus, it appears that the arithmetical division of the scale, and consequently the thermometric unit, the position of its zero, and, in fine, the standard temperatures by which alone the indication of different thermometers can be rendered comparable, are severally arbitrary. Unanimity, nevertheless, has prevailed in the selection of standard temperatures. The temperature at which ice melts,

and that at which distilled water boils, when the barometer stands at 29·8 inches, have been adopted in all countries as the two temperatures with reference to which thermometric scales are constructed.

1333. *Determination of these points.* — The bulb and tube, as already described, being filled with pure mercury, and a blank scale being attached to the tube, the instrument is immersed successively in melting ice and boiling water, and the points at which the mercurial column stands in each case are marked upon the scale. The former is called the *freezing point*, and the latter the *boiling point*.

1334. *Different thermometric units and zeros.* — *Fahrenheit's scale.* — The same unanimity has not prevailed either as respects the unit or the thermometric zero. In England, Holland, some of the German States, and in North America, the interval between the freezing and boiling points is divided into 180 equal parts, each part representing the thermometric unit. The scale is continued by equal divisions above the boiling and below the freezing points.

The zero is placed at the thirty-second division below the freezing point; so that, on this scale, the freezing point is  $32^{\circ}$ , and the boiling point  $32^{\circ} + 180^{\circ} = 212^{\circ}$ .

This scale is known as Fahrenheit's, and was adopted about 1724.

The reason for fixing the zero of the scale at  $32^{\circ}$  below the freezing point is, that that point indicated a temperature which was at that time believed to be the natural zero of temperature, or the greatest degree of cold which could exist, being the most intense cold which had been observed in Iceland.

We shall see hereafter that much lower temperatures, natural and artificial, have been since observed.

The divisions of the interval between the freezing and boiling points into 180 equal parts was founded upon some inexact supposition connected with the dilatation of mercury.

The divisions of this scale are continued in the same manner below zero, such divisions being considered negative, and expressed by the negative sign prefixed to them. Thus,  $+ 32^{\circ}$  signifies  $32^{\circ}$  above zero, but  $- 32^{\circ}$  signifies  $32^{\circ}$  below zero.

1335. *Centigrade scale.* — In France, Sweden, and some other parts of Europe, the centigrade scale prevails.

In this scale the interval between the freezing and boiling

points is divided into 100 equal parts, and the zero is placed at the freezing point.

1336. *Reaumur's scale.* — In some countries the scale of Reaumur is used, in which the interval between the freezing and boiling points is divided into eighty equal parts, the zero being placed at the freezing point.

1337. *Methods of computing the temperature according to any one scale when the temperature according to any other is given.* — As all these scales are used to a greater or less extent in different parts of the world, it will be necessary to establish rules by which the temperature expressed by any one of them may be converted into the corresponding temperature expressed by any other.

Since the numbers of degrees into which the interval between the freezing and boiling points is divided on the three scales are 180, 100, and 80 respectively, it follows that 18° Fahrenheit are equal to 10° centigrade and to 8° Reaumur; or that 9° Fahrenheit, 5° centigrade, and 4° Reaumur are represented by equal lengths of the scales. Hence are inferred the following rules: —

1. To reduce any number of Fahrenheit degrees to an equivalent number of centigrade or Reaumur degrees, divide by 9, and multiply by 5 for centigrade, and by 4 for Reaumur.

2. To reduce any number of centigrade degrees to an equivalent number of Fahrenheit or Reaumur, divide by 5, and multiply by 9 for Fahrenheit, and by 4 for Reaumur.

3. To reduce any number of Reaumur degrees to an equivalent number of Fahrenheit or centigrade, divide by 4, and multiply by 9 for Fahrenheit, and by 5 for centigrade.

If it be required to reduce any temperature expressed by one scale to the equivalent temperature expressed by another, the preceding rules will be sufficient for the centigrade and Reaumur, inasmuch as they have the same zero. But when it is required to reduce the temperature of Fahrenheit to the equivalent temperature on the other scales, it is necessary first to subtract from the temperature of Fahrenheit 32° (the distance between the two zeros), and then apply the preceding rule, or if it be required to reduce a temperature on the centigrade or Reaumur to an equivalent temperature on Fahrenheit, first apply the preceding rules, and then *add* 32°.

These principles are expressed briefly by the following for-

mulæ, in which F, C, and R express the same temperature upon the three scales :—

$$C = \frac{5}{9} \times (F - 32),$$

$$R = \frac{4}{9} \times (F - 32),$$

$$F = \frac{9}{5} \times C + 32 = \frac{9}{4} \times R + 32.$$

Two or all the three scales are sometimes attached to the same thermometer, so that equivalent temperatures are evident on inspection.

Such reductions may also be facilitated by the following table, showing the temperatures by the scales of Fahrenheit and Reaumur which are equivalent to those of the centigrade.

*Table for converting the Centigrade Thermometer into Degrees of Reaumur and Fahrenheit's Thermometer.*

Cent.	Reau.	Fahr.	Cent.	Reau.	Fahr.	Cent.	Reau.	Fahr.	Cent.	Reau.	Fahr.
100	80°	212	64	51·2	147·2	29	23·2	84·2	—6	—4·8	21·2
99	79·2	210·2	63	50·4	145·4	28	22·4	82·4	7	5·6	19·4
98	78·4	208·4	62	49·6	143·6	27	21·6	80·6	8	6·4	17·6
97	77·6	206·6	61	48·8	141·8	26	20·8	78·8	9	7·2	15·8
96	76·8	204·8	60	48°	140°	25	20°	77°	10	8°	14°
95	76°	203°	59	47·2	138·2	24	19·2	75·2	11	8·8	12·2
94	75·2	201·2	58	46·4	136·4	23	18·4	73·4	12	9·6	10·4
93	74·4	190·4	57	45·6	134·6	22	17·6	71·6	13	10·4	8·6
92	73·6	197·6	56	44·8	132·8	21	16·8	69·8	14	11·2	6·8
91	72·8	195·8	55	44°	131°	20	16°	68°	15	12°	5°
90	72°	194°	54	43·2	129·2	19	15·2	66·2	16	12·8	3·2
89	71·2	192·2	53	42·4	127·4	18	14·4	64·4	17	13·6	1·4
88	70·4	190·4	52	41·6	125·6	17	13·6	62·6	18	14·4	—0·4
87	69·6	188·6	51	40·8	123·8	16	12·8	60·8	19	15·2	2·2
86	68·8	186·8	50	40°	122°	15	12°	59°	20	16°	4°
85	68°	185°	49	39·2	120·2	14	11·2	57·2	21	1·8	5·8
84	67·2	183·2	48	38·4	118·4	13	10·4	55·4	22	17·6	7·6
83	66·4	181·4	47	37·6	116·6	12	9·6	53·6	23	18·4	9·4
82	65·6	179·6	46	36·8	114·8	11	8·8	51·8	24	19·2	11·2
81	64·8	177·8	45	36°	113°	10	8°	50°	25	20°	13°
80	64°	176°	44	35·2	111·2	9	7·2	48·2	26	20·8	14·8
79	63·2	174·2	43	34·4	109·4	8	6·4	46·4	27	21·6	16·6
78	62·4	172·4	42	33·6	107·6	7	5·6	44·6	28	22·4	18·4
77	61·6	170·6	41	32·8	105·8	6	4·8	42·8	29	23·2	20·2
76	60·8	168·8	40	32°	104°	5	4°	41°	30	24°	22°
75	60°	167°	39	31·2	102·2	4	3·2	39·2	31	24·8	23·8
74	59·2	165·2	38	30·4	100·4	3	2·4	37·4	32	25·6	25·6
73	58·4	163·4	37	29·6	98·6	2	1·6	35·6	33	2·4	27·4
72	57·6	161·6	36	28·8	96·8	1	0·8	33·8	34	27·2	29·2
71	56·8	159·8	35	28°	95°	0	0°	32°	35	28°	31°
70	56°	158°	34	27·2	93·2	—1	0·8	30·2	36	28·8	32·8
69	55·2	156·2	33	26·4	91·4	2	1·6	28·4	37	29·6	34·6
68	54·4	154·4	32	25·6	89·6	3	2·4	26·6	38	30·4	36·4
67	53·6	152·6	31	24·8	87·8	4	3·2	24·8	39	31·2	38·2
66	52·8	150·8	30	24°	86°	5	4°	23°	40	32°	40°
65	52°	149°									

1338. *Rate of dilatation of mercury.*—It has been ascertained by experiment, that mercury, when raised from 32° to 212°, suffers an increment of volume amounting to 2-111ths of its volume at 32°. Thus, 111 cubic inches of mercury at 32° will, if raised to 212°, become 113 cubic inches. From this may be deduced the increment of volume which mercury receives for

each degree of temperature. For, since the increase of volume corresponding to an elevation of  $180^\circ$  is  $\frac{1}{111}$  of its volume at  $32^\circ$ , we shall find the increment of volume corresponding to one degree by dividing  $\frac{1}{111}$  by 180, or, what is the same, by dividing  $\frac{1}{111}$  by 90, which gives  $\frac{1}{9990}$ . It follows, therefore, that for each degree of temperature by which the mercury is raised, it will receive an increment of volume amounting to the 9990th part of its volume at  $32^\circ$ . It follows, therefore, that the weight of mercury which fills the portion of a thermometric tube representing one degree of temperature, will be the 9990th part of the total weight contained in the bulb and tube.

1339. *Its dilatation uniform between the standard points.* —

In adopting the dilatation of mercury as a measure of temperature, it is assumed that equal dilatations of this fluid are produced by equal increments of heat. Now, although it is certain that to raise a given quantity of mercury from the freezing to the boiling point will always require the same quantity of heat, it does not follow that equal increments of volume will correspond to equal increments of heat throughout the whole extent of the thermometric scale. Thus, although the same quantity of heat must always be imparted to the mercury contained in the tube to raise it from  $32^\circ$  to  $212^\circ$ , it may happen that more or less heat may be required to raise it from  $32^\circ$  to  $42^\circ$ , than from  $202^\circ$  to  $212^\circ$ . In other words, the dilatation produced by equal increments of heat, in different parts of the scale, might be variable. Experiments conducted, however, under all the conditions necessary to ensure accurate results, have proved that mercury is uniformly dilated between the freezing and boiling points, or that equal increments of heat imparted to it produce equal increments of volume. The same uniform dilatation prevails to a considerable extent of the scale above the boiling and below the freezing points; but at extreme temperatures this uniformity of expansion ceases, as will be more fully explained hereafter.

1340. *Use of a standard thermometer.* — A thermometer having once been carefully graduated may be used as a standard instrument for graduating other thermometers, just as good chronometers once accurately set are used as regulators for other time-pieces. To graduate a thermometer by means of such a standard, it is only necessary to expose the two instruments to the same varying temperatures, and to mark upon the

blank scale of that which is to be graduated two points corresponding to any two temperatures shown by the standard thermometer, and then to divide the scale accordingly.

Thus, for example, if the two instruments be immersed in warm water and the column of the standard thermometer be observed to indicate the temperature of  $150^{\circ}$ , let the point at which the mercury stands in the other thermometer be marked upon its scale.

Let the two instruments be then immersed in cold water and let us suppose that the standard thermometer indicates  $50^{\circ}$ . Let the point at which the instrument to be graduated stands be then marked. Let the intervals of the scale between these two points, thus corresponding to the temperatures of  $50^{\circ}$  and  $150^{\circ}$ , be divided into one hundred equal parts; each part will be a degree in the scale, which may be continued by like divisions above  $150^{\circ}$  and below  $50^{\circ}$ .

1341. *Range of the scale of thermometers varies with the purpose to which they are applied.* — The range of the scale of thermometers is determined by the purpose to which they are to be applied. Thus, thermometers intended to indicate the temperature of dwelling-houses need not range above or below the extreme temperatures of the air, and the scale does not usually extend much below the freezing point nor above  $100^{\circ}$ ; and thus the sensitiveness of the instrument may be increased, since a considerable length of the tube may represent a limited range of the scale.

1342. *Qualities which render mercury a convenient thermoscopic fluid.* — Mercury possesses several thermal qualities which render it a convenient fluid for common thermometers. It is highly sensitive to change of temperature, dilating with promptitude by the same increments of heat with great regularity and through a considerable range of temperature. It will be shown hereafter that a smaller quantity of heat produces in it a greater dilatation than in most other liquids. It freezes at a very low and boils at a very high temperature. At the temperatures which are not near these extreme limits, it expands and contracts with considerable uniformity.

The freezing point of mercury being  $-40^{\circ}$ , or  $40^{\circ}$  below zero, and its boiling point  $+600^{\circ}$ , such a thermometer will have correct indications through a very large range of temperature.

1343. *Bulbs liable to a permanent change of capacity, which*



*renders correction of scale necessary.* — It has been found that, from some physical causes which are not satisfactorily explained, the bulbs of thermometers are liable to a change of magnitude after the lapse of a certain time. It follows from this that a thermometer, though accurately graduated when first made, may become at a later period erroneous in its indications; since a diminution of the capacity of the bulb would cause the standard points and all other temperatures to be raised upon the scale. To obviate this, thermometers used for purposes requiring much precision ought to be verified from time to time by comparison with well-constructed standards, or by exposure to the standard temperatures.

It is also found that a change of magnitude is produced in the bulb of a thermometer by sudden changes of temperature, which render verification necessary.

1344. *Self-registering thermometers.* — It is sometimes needed, in the absence of an observer, to ascertain the variations which may have taken place in a thermometer. Instruments called self-regulating thermometers have been contrived, which partially serve this purpose by indicating, not the variations of the mercurial column, but the limits of its play within a given time. This is accomplished by floating indices placed on the mercury within the tube, which are so adapted that one is capable of being raised with the column, but not depressed, and the other of being depressed but not raised. The consequence is, that one of these indices will remain at the highest, and the other at the lowest point which the mercurial column may have attained in the interval, and thus register the highest point and lowest point of its range.

The self-regulating thermometers on this principle which are the best known are Sykes and Rutherford's.

1345. *Spirit of wine thermometers.* — Alcohol is frequently used as a thermoscopic liquid. It has the advantage of being applicable to a range of temperature below the freezing point of mercury; no degree of cold yet observed in nature or attained by artificial processes having frozen it. It is usually coloured so as to render the column easily observable in the tube.

1346. *Air thermometers.* — Atmospheric air is a good thermoscopic fluid. It has the advantage over liquids in retaining its gaseous state at all temperatures, and in the perfect uniformity of its dilatation and contraction. It is also highly sensitive, indicating changes of temperature with great prompt-

titude. Since, however, it is not visible, its expansion and contraction must be rendered observable by expedients which interfere with and render complicated its indications.

1347. *Drebbel's air thermometer.*—The air thermometer of Drebbel, or according to some of Sanctorius, is represented in *fig. 426*. A glass tube, *AB*, open at one end, and having a large thin bulb *C* at the other, is placed with its open end in a coloured liquid, so that the air contained in the tube shall have a less pressure than the atmosphere. A column of the liquid will therefore be sustained in the tube *AB*, the weight of which will represent the difference between the pressure of the external air and the air inclosed in the tube.



Fig. 426.

If the bulb *C* be exposed to a varying temperature, the air included in it will expand and contract, and will cause the column of coloured liquid in the tube *AB* to rise and fall, thereby indicating the changes of temperature.

1348. *Amonton's air thermometer.*—Another form of air thermometer is represented in *fig. 427*. The air included fills half the capacity of the bulb *C*, and its expansion and contraction cause the coloured liquid to rise or fall in the tube *AB*.

1349. *The differential thermometer.*—Of all forms of air thermometer, that which has proved of greatest use in physical enquiries is the differential thermometer represented in *fig. 428*. This consists of two glass bulbs, *A* and *B*, connected by a rectangular glass tube. In the horizontal part of the tube a small quantity of coloured liquid (sulphuric acid, for example) is placed. Atmospheric air is contained in the bulbs and tube,

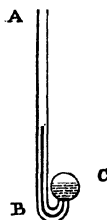

Fig. 427.

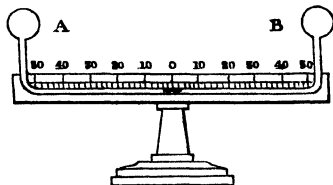

Fig. 428.

separated into two parts by the liquid. The instrument is so adjusted that, when the drop of liquid is at the middle of the

horizontal tube, the air in the bulbs has the same pressure; and, having equal volumes, the quantities at each side of the liquid are necessarily equal. If the bulbs be affected by different temperatures, the liquid will be pressed from that side at which the temperature is greatest, and the extent of its departure from the zero or middle is indicated by the scale.

This thermometer is sometimes varied in its form and arrangement, but the principle remains the same.

Its extreme sensitiveness, in virtue of which it indicates changes of temperature too minute to be observed by common thermometers, renders it extremely valuable as an instrument of scientific research.

By this instrument, changes of temperature not exceeding the 6000th part of a degree are rendered sensible.

1350. *Pyrometers adapted to measure high temperatures.*—The range of the mercurial thermometer being limited by the boiling point of mercury, higher temperatures are measured by the expansion of solids, whose points of fusion are at a very elevated part of the thermometric scale. The solids which are best adapted for this purpose are the metals. Being good conductors, these are promptly affected by heat, and their indications are immediate, constant, and regular.

Instruments adapted for the indication and measurement of this high range of temperature are called *pyrometers*.

1351. *Graduation of a pyrometer.*—To graduate a pyrometer, let the metallic bar be immersed successively in melting ice and boiling water, and let its lengths at these temperatures be accurately measured. Their difference being divided by 180, the quotient will be the increment of length corresponding to one degree of temperature; and this increment being multiplied, the length corresponding to any proposed temperature may be ascertained.

Let  $L^{\circ}$  express the length of the bar at the temperature  $32^{\circ}$ .

Let  $L'$  express its length at the temperature  $212^{\circ}$ .

Let  $i$  express the increase of length corresponding to  $1^{\circ}$ .

We shall then have

$$i = \frac{L' - L^{\circ}}{180}.$$

If  $L$  express in general the length of the bar at the temperature expressed by  $T$ , we shall have

$$L = L^{\circ} + i \times (T - 32),$$

which means nothing more than that the length at the temperature  $\tau$  is found by adding to the length at the temperature  $32^\circ$  as many times the increment corresponding to  $1^\circ$  as there are degrees in  $\tau$  above  $32^\circ$ .

The instrument represented in *fig. 429.* is one of the most simple forms of pyrometer.

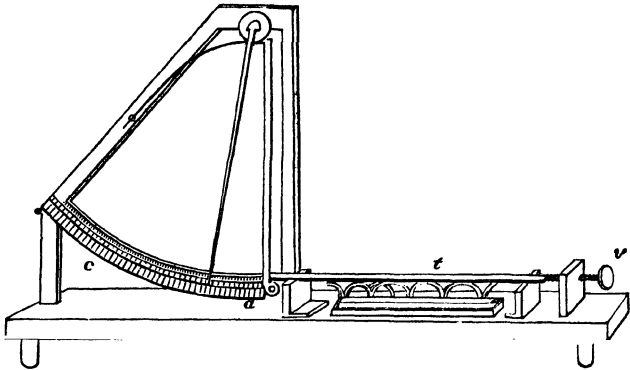

Fig. 429.

A rod of metal,  $t$ , is in contact at one end with the point of a screw  $v$ , and at the other with a lever  $a$ , near its fulcrum. This lever is connected with another so as to form a compound system, such that any motion imparted by the rod to the point on the lever  $a$  in contact with it is augmented in a high ratio, according to the principles explained in (438). A lamp placed under the rod  $t$  raises its temperature; and, as it is resisted by the point of the screw  $v$ , its dilatation must take effect against the lever  $a$ , which, acting on the second lever, will move the index on the graduated arc  $c$ . The ratio of this motion to that of the end of the bar acting on the lever being known (438), the quantity of dilatation may be calculated.

1352. *Temperature of metallic standard measures must be observed.*—The standards used as measures of length for ascertaining distances where great accuracy is required, such as in measuring the bases in geographical surveys, are usually rods of metal. But since these are subject to a change of length with every change of temperature, it would follow that the results of any measurement made by them would be attended with corresponding errors.

For the common purposes of domestic and commercial economy, such errors are too trifling to be worth the trouble of correcting; but this is not the case when they are applied to scientific purposes. It is necessary in such cases to observe the temperature of the rods at the moment each measurement is made.

1353. *Borda's pyrometric standard measure.*—In the operation by which the great arc of the meridian in France was measured, a very beautiful expedient was contrived by Borda, in which the bar itself is converted into a thermometer which indicates its own temperature. This expedient was again rendered available for the series of experiments made by Dulong and Petit, to ascertain the dilatation of bodies by heat.

A bar of platinum,  $PP'$ , *fig.* 430., was connected at one extremity with a similar bar of brass  $BB'$ , of very nearly equal length.

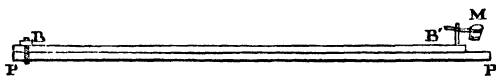

Fig. 430.

The two bars, being screwed or rivetted together at the extremity  $B$ , were free at every other point. Near the extremity  $P'$  of the bar of platinum, and immediately under the extremity  $B'$  of the brass bar, a very exact scale was engraved, the divisions of which marked the millionth part of the entire length of the rod. The extremity  $B'$  of the brass bar carried an index, which moved upon the divided scale. Over the point of this was placed a microscope  $M$ , by which its position could be ascertained, and by which the divisions of the scale could be more exactly read off.

If the two bars,  $PP'$  and  $BB'$ , were equally dilatable, it is evident that the same change of temperature affecting both would make no change in the position of the index; but, brass being more dilatable than platinum, the index pushed by the expansion of the bar  $BB'$  would be moved towards  $P'$  through a space greater than that by which the bar  $PP'$  would be lengthened, and, consequently, it would be advanced upon the scale through a space equal to the difference between the dilatation of the two bars.

The manner of graduating the scale upon  $PP'$  was as follows. The compound bar being submerged in a bath of melting ice,

the position of the index was observed. It was then transferred to a bath of boiling water, when the position of the index was again observed.

The interval between these two positions being divided into 180 equal parts, each part would represent one degree of temperature; or, if such division were too minute to be practicable, it might be divided into a less number of equal parts, as, for example, 36, in which case each division would correspond to 5°. When the index, as most frequently happens, stands between two divisions of the scale, it is necessary to estimate or measure its distance from one of these divisions, in order to express its exact position. This is accomplished by a contrivance called a vernier, which, as it is of great use in all cases where the observation of scales is necessary in science and the arts, it may be useful here to describe.

1354. *Construction and use of a vernier.* — The vernier is a contrivance which, by a subsidiary scale, supplies the means of estimating small fractions of the smallest division marked on the principal scale.

Let A B, *fig.* 431., represent a part of the principal scale. Let C D be the sliding-scale or vernier, which we will suppose to consist of 10 divisions equal in their total length to 11 divisions of the principal scale. Each division of the vernier will therefore be equal to eleven-tenths of a division of the chief scale, and will exceed a division of the chief scale by a tenth of a division.

Let us suppose that the index, D, of the vernier (which coincides with its zero), stands, as in *fig.* 432., at M, between the divisions marked 55 and 56, and that the question is to estimate how much it is above 55. Observe what division of the scale coincides either exactly or most nearly with a division of the vernier. The number of the vernier which stands at such division of the scale will express the number of tenths of a division of the chief scale between the index of the ver-

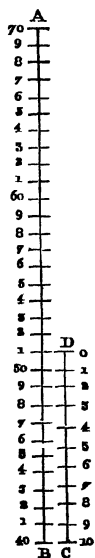

Fig. 431.

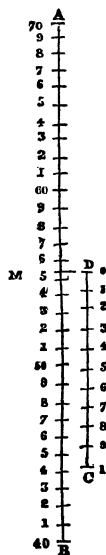

Fig. 432.

nier and the 55th division of the chief scale. In the present case, the 4th division of the vernier coincides nearly with the 51st division of the chief scale. The point on the chief scale indicated, therefore, by the vernier, is  $55\cdot4$ .

It is evident that the distance from the 55th division of the chief scale to the point *M*, which coincides with the index or zero of the vernier, is the difference between 4 divisions of the vernier and 4 divisions of the chief scale; and since a division of the vernier exceeds a division of the scale by a tenth, 4 divisions of the vernier exceed 4 of the scale by four-tenths.

### CHAP. III.

#### DILATATION OF SOLIDS.

1355. *Solids least susceptible of dilatation.*—Of all the states of aggregation of matter, that in which it is least susceptible of dilatation is the solid state. This may be explained by the energy of the cohesion of the component particles of the body, which is the characteristic property of the solid state. It is the nature of heat, by whatever hypothesis that agency be explained, to introduce a repulsive force among the molecules of the body it pervades. In solid bodies this repulsive force, acting against the cohesive force, diminishes the tenacity of the body. The component parts have a tendency to separate from each other, and hence arises the phenomenon of dilatation; but so long as the body preserves the character of solidity, the separation of the component molecules cannot exceed the limits of the play of the cohesive principle; and as these limits are very small, no dilatation which is consistent with the character of a solid can be considerable.

1356. *Homogeneous solids dilate equally throughout their volume.*—If a solid body be perfectly homogeneous, it will dilate uniformly throughout its entire volume by an uniform elevation of temperature. Thus, the length, breadth, and depth will, in general, be all augmented in the same proportion.

1357. *Dilatation of volume and surface computed from linear dilatation.*—It is a principle of geometry, that when a solid

body, without undergoing any change of figure, receives a small increase of magnitude, its increase of surface will be twice, and its increase of volume thrice, the increase of its linear dimensions. That is to say, if its length be augmented by a thousandth part of its primitive length, its surface will be augmented by *two* thousandth parts of its primitive surface, and its volume by *three* thousandth parts of its primitive volume. This is not true in a strictly mathematical sense, but it is sufficiently near the truth for all practical purposes.

Now, since all solid bodies of uniform structure, when affected by heat, expand or contract without suffering any change of figure, and since, while their change of their linear dimensions can be easily and exactly ascertained, that of their surface or volume would be determined with much more difficulty, the changes of these last are deduced from the first by multiplying it by 2 for the increment of surface, and by 3 for the increment of volume.

Thus, if it be found that a bar of zinc being raised from  $32^{\circ}$  to  $212^{\circ}$ , receive an increment of length equal to the 340th part of its length at  $32^{\circ}$ , it may be inferred that its increment of surface is *two* 340th parts, and that its increment of volume is *three* 340th parts of its volume at  $32^{\circ}$ .

1358. *Dilatation of solids uniform between the standard thermometric points.*—It is found that solid bodies in general suffer an uniform rate of dilatation, through a range of temperature extending from  $32^{\circ}$  to  $212^{\circ}$ ; that is to say, the increments of volume which attend each degree of temperature which the body receives are equal. If, therefore, the entire increment of volume which such a body undergoes when it is raised from  $32^{\circ}$  to  $212^{\circ}$  be divided by 180, the quotient will be the increment of volume which it receives when its temperature is raised one degree.

1359. *Dilatation ceases to be uniform near the point of fusion.*—When solids are elevated to temperatures much above  $212^{\circ}$ , and more especially when they approach those temperatures at which they would be fused or liquefied, the dilatations are not uniform. As the temperature is raised, the rate of dilatation is increased, that is to say, a greater increment of volume attends each degree of temperature.

1360. *Exceptional cases presented by certain crystals.*—There are also certain exceptional cases in some crystallized bodies, in which, notwithstanding they are homogeneous, the dilatation is



not equal in all their dimensions. Certain crystals are found to suffer more dilatation in the direction of one axis than in the direction of another.

1361. *Tabular statement of the rates of dilatation of solids.*— In the following table are given the rates of dilatation of solid bodies according to the most recent and accredited authorities. In the first column is given the limits of temperature between which the dilatation has taken place; in the second is given the increment of the linear dimensions, expressed decimally, the linear dimension at the lower temperature being the unit. In the third column the same is expressed as a vulgar fraction.

*Table of the linear Dilatation of Solids.*

Names of Substances.	Interval of Temperature.	Dilatation in Fractions.	
		Decimal.	Vulgar.
<i>According to Lavoisier and Laplace.</i>			
Flint glass (English) - - -	32° to 212°	0·00081166	$\frac{1}{1248}$
Platinum (according to Broda) - - -	"	0·00085655	$\frac{1}{1167}$
Glass (French) with lead - - -	"	0·00087199	$\frac{1}{1147}$
Glass tube without lead - - -	"	0·00087572	$\frac{1}{1142}$
Ditto - - - - -	"	0·00089694	$\frac{1}{1113}$
Ditto - - - - -	"	0·00089760	$\frac{1}{1114}$
Ditto - - - - -	"	0·00091750	$\frac{1}{1090}$
Glass (St. Gobain) - - - - -	"	0·00089089	$\frac{1}{1122}$
Steel (untempered) - - - - -	"	0·00107880	$\frac{1}{927}$
Ditto - - - - -	"	0·00107915	$\frac{1}{927}$
Ditto - - - - -	"	0·00107960	$\frac{1}{926}$
Steel (yellow temper) at 65° - - -	"	0·00123956	$\frac{1}{807}$
Iron, soft forged - - - - -	"	0·00122045	$\frac{1}{819}$
Iron, round wire-drawn - - - - -	"	0·00123504	$\frac{1}{812}$
Gold - - - - -	"	0·00146606	$\frac{1}{682}$
Gold (French standard) annealed - - -	"	0·00151361	$\frac{1}{661}$
Gold (Ditto) not annealed - - - - -	"	0·00155155	$\frac{1}{643}$
Copper - - - - -	"	0·00171220	$\frac{1}{584}$
Ditto - - - - -	"	0·00171733	$\frac{1}{582}$
Ditto - - - - -	"	0·00172240	$\frac{1}{581}$
Brass - - - - -	"	0·00186670	$\frac{1}{535}$
Ditto - - - - -	"	0·00187821	$\frac{1}{533}$
Ditto - - - - -	"	0·00188970	$\frac{1}{529}$
Silver - - - - -	"	0·00190868	$\frac{1}{524}$
Silver - - - - -	"	0·00190974	$\frac{1}{521}$
Tin, Indian or - - - - -	"	0·00193765	$\frac{1}{518}$
Tin, Falmouth - - - - -	"	0·00217298	$\frac{1}{462}$
Lead - - - - -	"	0·00284836	$\frac{1}{351}$

Names of Substances.	Interval of Temperature.	Dilatation in Fractions.	
		Decimal.	Vulgar.
<i>According to Smeaton.</i>			
Glass, white (barometer tubes)	32° to 212°	0·00083333	$\frac{1}{175}$
Steel - - - - -		0·00108333	$\frac{5}{463}$
Steel tempered - - - - -	"	0·00115000	$\frac{5}{470}$
Iron - - - - -	"	0·00122500	$\frac{5}{478}$
Bismuth - - - - -	"	0·00125833	$\frac{7}{553}$
Copper - - - - -	"	0·00139167	$\frac{7}{719}$
Copper 8 parts, tin 1 - - - - -	"	0·00170000	$\frac{3}{588}$
Brass cast - - - - -	"	0·00181667	$\frac{3}{530}$
Brass 16 parts, tin 1 - - - - -	"	0·00187500	$\frac{3}{525}$
Brass wire - - - - -	"	0·00190833	$\frac{3}{324}$
Telescope speculum metal - - - - -	"	0·00193333	$\frac{3}{317}$
Solder (copper 2 parts, zinc 1) - - - - -	"	0·00193333	$\frac{3}{317}$
Tin (fine) - - - - -	"	0·00205833	$\frac{4}{466}$
Tin (grain) - - - - -	"	0·00228333	$\frac{4}{338}$
Solder white (tin 1 part, lead 2) - - - - -	"	0·00248333	$\frac{4}{403}$
Zinc 8 parts, tin 1, slightly forged - - - - -	"	0·00250533	$\frac{3}{369}$
Lead - - - - -	"	0·00269167	$\frac{3}{372}$
Zinc - - - - -	"	0·00286667	$\frac{3}{318}$
Zinc lengthened $\frac{1}{12}$ by hammering - - - - -	"	0·00294167	$\frac{3}{410}$
		0·00310833	$\frac{3}{322}$
<i>According to Major-General Roy.</i>			
Glass (tube) - - - - -	32° to 217°	0·00077550	$\frac{1}{1285}$
Glass (solid rod) - - - - -	"	0·00080833	$\frac{1}{1237}$
Glass cast (prism of) - - - - -	"	0·00111000	$\frac{1}{901}$
Steel (rod of) - - - - -	"	0·00114450	$\frac{1}{874}$
Brass (Hamburgh) - - - - -	"	0·00185550	$\frac{1}{538}$
Brass (English) rod - - - - -	"	0·00189296	$\frac{1}{528}$
Brass (English), angular - - - - -	"	0·00189450	$\frac{1}{528}$
<i>According to Troughton.</i>			
Platinum - - - - -	32° to 212°	0·00099180	$\frac{1}{1008}$
Steel - - - - -	"	0·00118990	$\frac{1}{840}$
Steel wire drawn - - - - -	"	0·00144010	$\frac{1}{694}$
Copper - - - - -	"	0·00191880	$\frac{1}{521}$
Silver - - - - -	"	0·00208260	$\frac{1}{460}$
<i>According to Wollaston.</i>			
Palladium - - - - -	"	0·00100000	$\frac{1}{1000}$
<i>According to Dulong and Petit.</i>			
Platinum - - - - -	32° to 212°	0·00088420	$\frac{1}{1131}$
		0·00275482	$\frac{1}{3631}$
		0·00086133	$\frac{1}{1161}$
Glass - - - - -	32° to 392°	0·00184502	$\frac{1}{544}$
		0·00303252	$\frac{1}{329}$
Iron - - - - -	32° to 212°	0·00118210	$\frac{1}{846}$
		0·00440528	$\frac{1}{227}$
Copper - - - - -	32° to 212°	0·00171820	$\frac{1}{582}$
		0·00564972	$\frac{1}{177}$

1362. *Measure of the force of dilatation and contraction of solids.*—The force with which solid bodies dilate and contract is equal to that which would compress them through a space equal to their dilatation, and to that which would stretch them through a space equal to the amount of their contraction. Thus, if a pillar of metal one hundred inches in height, being raised in temperature, is augmented in height by a quarter of an inch, the force with which such increase of height is produced is equal to a weight which being placed upon the top of the pillar would compress it so as to diminish its height by a quarter of an inch.

In the same manner, if a rod of metal, one hundred inches in length, be contracted by diminished temperature, so as to render its length a quarter of an inch less, the force with which this contraction takes place is equal to that which being applied to stretch it would cause its length to be increased by a quarter of an inch.

1363. *Practical application of the forces of dilatation and contraction in drawing together the walls of buildings.*—This principle is often practically applied in cases where great mechanical force is required to be exerted through small spaces. Thus, in cases where the walls of a building have been thrown out of the perpendicular either by the unequal subsidence of the foundation or by the incumbent pressure of the roof, they have been restored to the perpendicular by the following arrangement:—

A series of iron rods are carried across the building, passing through holes in the walls, and are secured by nuts on the outside. The alternate bars are then heated by lamps until they expand, when the nuts, which are thus removed to some distance from the walls by the increased length of the bars, are screwed up so as to be in close contact with them. The lamps are then withdrawn, and the bars allowed to cool. In cooling they gradually contract, and the walls are drawn together by the nuts through a space equal to their contraction. Meanwhile the intermediate bars have been heated and expanded, and the nuts screwed up as before. The lamps being again withdrawn and transferred to the first set of bars, the second set are contracted in cooling, and the walls further drawn together. This process is continually repeated, until at length the walls are restored to their perpendicular position.

1364. *Moulds for casting in metal must be larger than the object to be cast.*—In all cases where moulds are constructed for

casting objects in metal, the moulds must be made larger than the intended magnitude of the object, in order to allow for its contraction in cooling. Thus the moulds for casting cannon balls must always be greater than the calibre of the gun, since the magnitude of the mould will be that of the ball when the metal is incandescent, and therefore greater than when it is cold.

1365. *Hoops and tires tightened by the contraction in cooling.*—Hoops surrounding water-vats, tubs and barrels, and other vessels composed of staves, and the tires surrounding wheels, are put on in close contact at a high temperature, and, cooling, they contract and bind together the staves or fellies with greater force than could be conveniently applied by any mechanical means.

1366. *Compensators necessary in all metallic structures.*—In all structures composed of metal, or in which metal is used in combination with other materials, such as roofs, conservatories, bridges, railings, pipes for the conveyance of gas or water, rafters for flooring, &c., compensating expedients must be introduced to allow the free play of the metallic bars in dilating and contracting with the vicissitudes of temperature to which they are exposed during the change of seasons.

These expedients vary with the way in which the metal is applied, and with the character of the structure. Pipes are generally so joined from place to place as to be capable of sliding one within another, by a telescopic joint. The successive rails which compose a line of railways cannot be placed end to end, but space must be left between their extremities for dilatation.

1367. *Blistering and cracking of lead and zinc roofs.*—Sheet lead and zinc, both of which metals are very dilatable, when used to cover roofs where they are especially exposed to vicissitudes of temperature, are liable to blister in hot weather by expansion and to crack in cold weather by contraction, unless expedients are adopted to obviate this: zinc, being much more dilatable than lead, is more liable to these objections.

1368. *Metallic inlaying liable to start.*—When ornamental furniture is inlaid with metal without providing for its expansion, the metal, being more dilatable than the wood, is liable, in a small room, to expand and start from its seat.

1369. *Compensating pendulum.*—It has been already shown (547) that the centre of oscillation of a pendulum ought to be

kept constantly at the same distance from its point of suspension, since otherwise the rate of the time-piece regulated by it would not be uniform. This object has been attained by connecting the bob of the pendulum with the point of suspension by rods composed of materials expansible in different degrees, so arranged, that the dilatation of one shall augment the distance of the centre of oscillation from the point of suspension, while the expansion of the other diminishes it.

Let  $s$ , *fig.* 433., be the point of suspension, and  $o$  the centre of oscillation, and let  $s$  be supposed to be connected with  $o$  by means of two rods of metal,  $sA$  and  $Ao$ , which are united at  $A$ , but independent of each other at every other point.



*Fig.* 433.

If such a pendulum be affected by an increase of temperature, the rod  $sA$  will suffer an increment of length, by which the point  $A$  and the rod  $Ao$  attached to it will be lowered; but, at the same time, the rod  $Ao$  being subject to the same increase of temperature, will receive an increment of length, in consequence of which the point  $o$  will be raised to an increased distance above the point  $A$ , at which the rods are united. If the increment of the length of the rod  $Ao$  be in this case equal to the increment of the rod  $sA$ , then the point  $o$  will be raised as much by the increase of the length of  $Ao$  as it is lowered by the increase of the length of  $sA$ , and, consequently, its distance from the point  $s$  will remain the same as before the change of temperature takes place.

To fulfil these conditions, it is only necessary that the length of the rod  $Ao$  shall be less than the length of the rod  $sA$  in exactly the same proportion as the expansibility of the metal composing  $Ao$  exceeds the expansibility of the metal composing  $sA$ . If the lengths of  $sA$  and  $Ao$  were equal, their increments of length would be proportional to their dilatations; but the length of the more dilatible rod  $Ao$ , being less than that of the less dilatible  $sA$ , in the same proportion as the dilatibility of the former is greater than that of the latter, the absolute increments of their length, will necessarily be equal, the greater dilatibility of  $Ao$  being compensated by its lesser length.

1370. *Harrison's gridiron pendulum.*—This principle is variously applied in different pendulums. That which is best



Fig. 434.

known is Harrison's gridiron pendulum represented in *fig. 434*. The bob *P* is attached to a rod of iron *PC*, having a cross-piece *C* at the top. This cross-piece rests upon two rods of brass, *FG* and *KL*, which are themselves supported by a cross-piece, *BE*, of iron. This latter piece is attached to two rods of iron, *BA* and *ED*, which are themselves attached to a cross-piece connected with the point of suspension or knife-edge on which the pendulum vibrates. By the expansion of the iron rods *AB* and *DE*, the distance of the cross-piece *BE* from the point of suspension is augmented; and by the expansion of the iron rod *CP* the distance of the bob *P*, and therefore of the centre of oscillation from the same point, is augmented. By the expansion of the brass rods *FG* and *KL*, the distance of the cross-piece *C* from the cross-piece *BE* is augmented, and therefore the bob *P* and the centre of oscillation proportionally raised. Thus, the distance of the bob *P* and the centre of oscillation from the point

of suspension will depend upon the relative amounts of the two dilatations of the iron and brass rods, the former having a tendency to lower and the latter to raise it. By the table of expansions (1361), it appears that the linear expansion of brass for any given change of temperature is greater than that of iron in the ratio of 1.48 to 1. If, then, the total length of the rods *AB* and *PC* be greater than that of *FG* in the ratio of 1.48 to 1, their actual dilatations will be equal, and the centre of oscillation will remain at the same distance from the point of suspension.

1371. *Bars of different metals mutually attached are curved by dilatation and contraction.* — If two straight bars of differently dilatible metals be soldered together, every change of temperature will bend the combined bar into the form of a curve, the more dilatible metal being on the convex side of the curve when the temperature is raised, and on the concave side of it when it is lowered.

Let the more dilatible metal be called *A*, and the less dilatible *B*. Now, if the temperature be raised, *A* will become longer than *B*, and, as they cannot separate, they must assume such a form, being still in contact, as is consistent with the inequality of

their lengths. This is a condition which will be satisfied by a curve in which the bar A is on the convex and the bar B on the concave side.

If the temperature, on the other hand, be lowered, the more dilatible metal being also the more contractible, the bar A will be more diminished in length than the bar B, and being, therefore, the shorter, will necessarily be on the concave side of the curve.

1372. *Application of this principle to compensation pendulums.*—This principle has been ingeniously applied as a compensator in the pendulums of clocks and the balance-wheels of watches.

Such a compound bar as we have just described is placed at right angles to the rod of the pendulum, and has, at its extremities, two bobs. When the temperature rises, and the centre of oscillation is, by expansion of the pendulum, removed to a greater distance from the point of suspension, this compensating bar is bent into the form of a curve concave towards the point of suspension, as represented in *fig. 435.*; and the bobs which it carries at its extremities being brought closer to the point of suspension, compensate for the increased distance of the bob of the pendulum from that point.

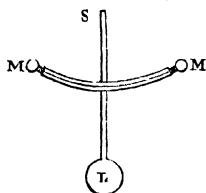

Fig. 435.

If, on the other hand, the temperature falls, and the rod of the pendulum contracting brings the bob and the centre of oscillation nearer to the point of suspension, the compensating bar is bent into a curve, which is concave downwards, as represented in *fig. 436.*; and the bobs which it carries being removed to an increased distance from the point of suspension, compensate for the diminished distance of the bob of the pendulum.

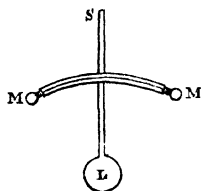

Fig. 436.

1373. *In application to balance-wheels.*—The balance-wheel of a watch is a metallic wheel, which moves on a finely-constructed centre, and is connected with a fine spiral spring, from which it receives an oscillating motion, the time of its oscillation depending partly upon the diameter

of the wheel. Now any change of temperature affecting the magnitude of the wheel by expansion and contraction will cause a change in its diameter, and a consequent change in the time of its oscillation, and the rate of the time-piece which it regulates.

This irregularity has been compensated by attaching to the rim of the wheel a compound metallic arch such as that already described. When the temperature rises, and the diameter of the wheel is augmented, this arch, with its concavity towards the centre of the wheel, becomes more concave, and a weight which it carries is brought nearer to the centre of the wheel, and this compensates for the increased magnitude of the wheel. If, on the other hand, the temperature is lowered, and the diameter of the wheel diminished by contraction, this arch becomes less concave, and the weight which it carries is removed to a greater distance from the centre, and this compensates for the diminished diameter of the wheel.

## CHAP. IV.

### DILATATION OF GASES.

1374. *Volume of gaseous bodies dependent on pressure and temperature.* — It has been already shown (706), that the dimensions of bodies in the gaseous state are dependent altogether upon the pressure by which they are confined. They are capable of expanding spontaneously into any dimensions, however great, and of being reduced by greater pressure to any volume, however small. It follows, therefore, that whenever it be required to determine the change of dimensions of gaseous bodies produced by change of temperature, it will be necessary to provide means of keeping them during the experiment under a uniform pressure, since otherwise the change of dimensions due to change of pressure would be combined with that which is due to change of temperature.

1375. *Method of observing the dilatation of gases under uniform pressure.* — Experimental enquirers have contrived and practised various expedients to accomplish this, one of the most



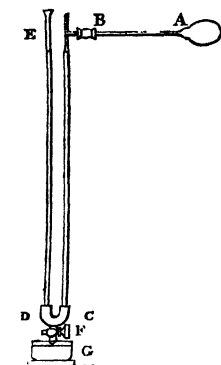

Fig. 437.

simple of which is that of M. Pouillet, represented in *fig. 437*. An iron siphon tube DC is formed with short legs, from the bottom of which proceeds a pipe with a stop-cock F, under which is placed a cistern or reservoir G. In the legs of the siphon DC are inserted two glass tubes, DE and CB, of more than thirty inches in height. The tube DE is open at the top; the tube CD is closed at the top, but has a horizontal branch united to it at B, which is connected with a tube AB made of platinum, which terminates in a hollow ball A, also of platinum. A stop-cock is provided in the tube BA, so as to communicate at pleasure with the external air. The stop-cock F being closed, and the stop-cock in the tube BA being open, mercury is poured into the tube DE, so as to fill the glass tubes DE and CB nearly to the top. Since the two tubes DE and CB both communicate with the external air, the columns of mercury in them will stand at the same level. To determine the expansion which air suffers when raised from the freezing to the boiling point under a uniform pressure, let the reservoir A be immersed in a bath of melting ice, so as to reduce the air included in it to the freezing point. Let the stop-cock in the tube BA be then closed, and let the bulb A be removed to a bath of boiling water. The air in the bulb expanding will press down the column of mercury in BC, and will cause the column in DE to rise; so that the levels of the two columns will no longer coincide. But they may be equalized by opening the stop-cock F, and allowing mercury to flow into the reservoir G from the siphon, until the levels in the two legs come to the same point. When that is accomplished, the pressure upon the expanded air included in the bulb A, and the tube communicating with it, will be equal to that of the atmosphere, and equal to that which the same air has when at the freezing point.

The capacity of the tube CB being known, the volume which corresponds to any length of it will be also known.

Now the increment of volume which the air has suffered by expansion will be indicated by the height through which the

mercury has fallen in the tube C D. This increment, therefore, will be the dilatation of the air included in the bulb A and the communicating tube between the freezing and boiling points.

In the same manner, by this apparatus, the dilatation corresponding to any change whatever of temperature under a given pressure can be ascertained.

1376. *Dilatation of gaseous bodies uniform and equal.* — It has been proved by experiments made with this as well as a variety of other apparatus adapted to the same purpose, that the dilatation of all bodies in the gaseous form is perfectly uniform throughout the whole extent of the thermometric scale, the same increments of temperature producing, under the same pressure, equal increments of volume. But, what is still more remarkable, it has been found that all gases whatever, as well as all vapours raised from liquids by heat, are subject to exactly the same quantity of expansion by the same change of temperature.

1377. *Amount of this dilatation ascertained.* — By the experiments of M. Gay Lussac, it was demonstrated in 1804 that 1000 cubic inches of atmospheric air raised from the freezing to the boiling point were dilated so as to make 1375 inches. These experiments have more recently been repeated by MM. Rudberg, Magnus, Regnault, and Pouillet. It has been found that the dilatation is more exactly expressed by 1367 cubic inches. Thus, the increment of volume of atmospheric air between  $32^{\circ}$  and  $212^{\circ}$  is the  $\frac{367}{1000}$ th, or very nearly one-third of its volume at  $32^{\circ}$ . It follows, therefore, that ten cubic inches of atmospheric air at  $32^{\circ}$  will, if raised to the temperature of  $212^{\circ}$ , become, by dilatation, nearly  $13\frac{7}{10}$  cubic inches; and, for every additional  $180^{\circ}$  of temperature which it receives, it will undergo a like increase of volume.

1378. *Increment of volume corresponding to  $1^{\circ}$ .* — To find the increment of volume corresponding to one degree of temperature, we have only to divide the fraction  $\frac{367}{1000}$  by 180, which gives  $\frac{367}{180000} = \frac{1}{490}$ .

The increment of volume, therefore, which any gas or vapour undergoes when, under the same pressure, the temperature is raised one degree, is the 490th part of the volume which it would have if reduced to the temperature of  $32^{\circ}$ .

It follows from this, that if any volume of air at  $32^{\circ}$  be raised to the temperature of  $32^{\circ} + 490^{\circ} = 522^{\circ}$ , it will expand into twice

its volume ; and if it be raised to a temperature of  $32^{\circ} + 2 \times 490 = 1012$ , it will be expanded into three times its volume, and so on.

1379. *Experiments of Gay Lussac, Dulong, and Petit showed the uniformity and equality of expansion.*—The well-known experiments of Gay Lussac, the results of which were in accordance with those subsequently obtained by Dulong and Petit, establish the fact, that all gases, as well as all vapours, undergo equal changes of volume, by equal increments of temperature, the co-efficient of the expansion of atmospheric air being common to all.

1380. *This result qualified by the researches of Rudberg and Regnault.*—Rudberg first called in question the correctness of this principle, and not only showed that the co-efficient of the expansion of atmospheric air previously determined was inexact, but that other gases, though so nearly equal in their rates of expansion to each other and to atmospheric air, were not precisely so. These researches of Rudberg have been confirmed by those of Magnus and Regnault ; and it appears from them that the following are the increments of volume which the undermentioned gases undergo between  $32^{\circ}$  and  $212^{\circ}$ , their volume at  $32^{\circ}$  being 1.000.

Hydrogen	-	-	-	0.366
Atmospheric air	-	-	-	0.367
Carbonic oxide	-	-	-	0.367
Carbonic acid	-	-	-	0.371
Protoxide of azote	-	-	-	0.372
Cyanogen	-	-	-	0.388
Sulphurous acid	-	-	-	0.390

M. Regnault also found that the dilatation of the same gases are not exactly the same at all pressures. Thus, under  $3\frac{1}{2}$  atmospheres, the dilatation of hydrogen remains unvaried, but the dilatation of air increases from 0.367 to 0.369, and that of carbonic acid from 0.371 to 0.385, while the dilatation of sulphurous acid, under a pressure of only one atmosphere, increases from 0.390 to 0.398.

Thus it appears that although it be certain that the gases are subject to a small difference in their rates of dilatation, and also that the rate of dilatation of the same gas is not absolutely the same at different pressures, yet the inequality and variations are such as may be disregarded for all practical purposes ; and it may

be assumed that all gases and all vapours dilate uniformly, and in the same degree as atmospheric air.

1381. *Formulae to compute the change of volume of a gas corresponding to a given change of temperature.* — The following formulæ will serve to calculate the change of volume which atmospheric air, or any other gas which dilates equally with it, undergoes for any proposed change of temperature.

Let  $v$  express a volume of air at  $32^\circ$ .

Let  $v$  express its volume when raised to a temperature which exceeds  $32^\circ$  by a number of degrees expressed by  $T$ .

The increment of volume, therefore, corresponding to the increment of temperature expressed by  $T$ , will be  $v - v$ ; and since the increment of volume corresponding to  $1^\circ$  is  $\frac{v}{490}$ , the increment corresponding to  $T$  degrees will be  $\frac{v}{490} \times T$ . We shall therefore have

$$v - v = \frac{v}{490} \times T; \quad V = v + \frac{v \times T}{490}$$

and consequently,

$$v = \left(1 + \frac{T}{490}\right) \times v. \quad = v \left(1 + \frac{T}{490}\right)$$

In this case the gas has been supposed to be submitted to an increase of temperature. If it be reduced to a lower temperature, it will suffer a decrement of volume, expressed by  $v - v$ ; and if  $T$  express the number of degrees below  $32^\circ$  to which it is reduced, the decrement of volume for  $1^\circ$  being  $\frac{v}{490}$ , the decrement for  $T$  degrees will be as before,  $\frac{v}{490} \times T$ , and we shall have

$$v - v = \frac{v}{490} \times T; \quad v = v - \frac{v \times T}{490}$$

from which we find,

$$v = \left(1 - \frac{T}{490}\right) \times v. \quad = v \left(1 - \frac{T}{490}\right)$$

If, therefore, the volume of a gas at  $32^\circ$  be known, its volume at any other temperature above or below  $32^\circ$  may be calculated by the following

## RULE.

*Divide the difference between the number of degrees in the temperature and 32° by 490. Add the quotient to 1 if the temperature be above 32°, and subtract it from 1 if it be below 32°. Multiply the volume of the gas at 32° by the resulting number, and the product will be the volume of the gas at the proposed temperature.*

*Table showing the changes of volume of a gaseous body consequent on given changes of temperature.*

In the columns v of the following table are expressed in cubic inches the volumes which a thousand cubic inches of air at 32° will have at the temperatures expressed in the columns t, being supposed to be maintained under the same pressure.

T.	V.	T.	V.	T.	V.	T.	V.	T.	V.
-50	832.7	-5	924.5	40	1016.3	85	1108.2	130	1200.0
-49	831.7	-4	926.5	41	1018.4	86	1110.2	131	1202.0
-48	836.7	-3	928.6	42	1020.4	87	1112.2	132	1204.1
-47	838.8	-2	930.6	43	1022.4	88	1114.3	133	1206.1
-46	840.8	-1	932.7	44	1024.5	89	1116.3	134	1208.2
-45	842.8	0	934.7	45	1026.5	90	1118.4	135	1210.2
-44	844.9	1	936.7	46	1028.6	91	1120.4	136	1212.2
-43	846.9	2	938.8	47	1030.6	92	1122.4	137	1214.3
-42	849.0	3	940.8	48	1032.7	93	1124.5	138	1216.3
-41	851.0	4	942.9	49	1034.7	94	1126.5	139	1218.4
-40	853.1	5	944.9	50	1036.7	95	1128.6	140	1220.4
-39	855.1	6	947.0	51	1038.8	96	1130.6	141	1222.4
-38	857.1	7	949.0	52	1040.8	97	1132.7	142	1224.5
-37	859.2	8	951.0	53	1042.9	98	1134.7	143	1226.5
-36	861.2	9	953.1	54	1044.9	99	1136.7	144	1228.6
-35	863.3	10	955.1	55	1046.9	100	1138.8	145	1230.6
-34	865.3	11	957.1	56	1049.0	101	1140.8	146	1232.7
-33	867.3	12	959.2	57	1051.0	102	1142.9	147	1234.7
-32	869.4	13	961.2	58	1053.1	103	1144.9	148	1236.7
-31	871.4	14	963.3	59	1055.1	104	1147.0	149	1238.8
-30	873.5	15	965.3	60	1057.1	105	1149.0	150	1240.8
-29	875.5	16	967.3	61	1059.2	106	1151.0	151	1242.9
-28	877.6	17	969.4	62	1061.2	107	1153.1	152	1244.9
-27	879.6	18	971.4	63	1063.3	108	1155.1	153	1246.9
-26	881.6	19	973.5	64	1065.3	109	1157.1	154	1249.0
-25	883.7	20	975.5	65	1067.3	110	1159.2	155	1251.0
-24	885.7	21	977.6	66	1069.4	111	1161.2	156	1253.0
-23	887.8	22	979.6	67	1071.4	112	1163.3	157	1255.1
-22	889.8	23	981.6	68	1073.5	113	1165.3	158	1257.1
-21	891.8	24	983.7	69	1075.5	114	1167.3	159	1259.2
-20	893.9	25	985.7	70	1077.6	115	1169.4	160	1261.2
-19	895.9	26	987.8	71	1079.6	116	1171.4	161	1263.3
-18	898.0	27	989.8	72	1081.6	117	1173.5	162	1265.3
-17	900.0	28	991.8	73	1083.7	118	1175.5	163	1267.3
-16	902.0	29	993.9	74	1085.7	119	1177.6	164	1269.4
-15	904.1	30	995.9	75	1087.8	120	1179.6	165	1271.4
-14	906.1	31	998.0	76	1089.8	121	1181.6	166	1273.5
-13	908.2	32	1000.0	77	1091.8	122	1183.7	167	1275.5
-12	910.2	33	1002.0	78	1093.9	123	1185.7	168	1277.5
-11	912.2	34	1004.1	79	1095.9	124	1187.8	169	1279.6
-10	914.3	35	1006.1	80	1098.0	125	1189.8	170	1281.6
-9	916.3	36	1008.2	81	1100.0	126	1191.8	171	1283.7
-8	918.4	37	1010.2	82	1102.0	127	1193.9	172	1285.7
-7	920.4	38	1012.2	83	1104.1	128	1195.9	173	1287.8
-6	922.5	39	1014.3	84	1106.1	129	1198.0	174	1289.8

T.	V.	T.	V.	T.	V.	T.	V.	T.	V.
175	1291·8	188	1318·4	201	1344·9	214	1371·4	270	1485·7
176	1293·9	189	1320·4	202	1346·9	215	1373·5	280	1506·1
177	1295·9	190	1322·4	203	1349·0	216	1375·5	290	1526·5
178	1298·0	191	1324·5	204	1351·0	217	1377·5	300	1546·9
179	1300·0	192	1326·5	205	1353·1	218	1379·6		
180	1302·0	193	1328·6	206	1355·1	219	1381·6	300	1546·9
181	1304·1	194	1330·6	207	1357·1	220	1383·7	400	1751·0
182	1306·1	195	1332·6	208	1359·2			500	1955·1
183	1308·2	196	1334·7	209	1361·2	220	1383·7	600	2159·2
184	1310·2	197	1336·7	210	1363·3	230	1404·1	700	2363·3
185	1312·2	198	1338·8	211	1365·3	240	1424·5	800	2567·3
186	1314·3	199	1340·8	212	1367·3	250	1444·9	900	2771·4
187	1316·3	200	1342·9	213	1369·4	260	1465·3	1000	2975·5

1382. *Increase of pressure due to increase of temperature.*— If air or gas be included within any limits which prevent its expansion by increase of temperature, its elastic force or pressure will be increased in the same proportion as its volume would be increased if it were not thus confined. Thus, if a certain quantity of air confined under a given pressure receive such an increase of temperature as would cause it to expand into double its volume, and if, after having so expanded, it be subject to such an increased pressure as will reduce it to its primitive volume, it will acquire double its primitive pressure. This follows from the principles already established, that the pressure of air and gas is universally as the volume into which they are compressed.

1383. *Formulae expressing the general relation between the volume, temperature, and pressure.*— It will be convenient, however, to establish general formulæ by which the relation between the volume and temperature of the same gases under different pressures may be expressed, so that the volume at any given temperature and pressure being given, the volume at any other temperature and pressure may be obtained.

It has been already shown, that at the same temperature the volume will be inversely as the pressure (708); so that, if  $v$  and  $v'$  be two volumes at the same temperature and under the pressures  $P$  and  $P'$ , we shall have

and therefore

$$v' = v \times \frac{P}{P'}$$

Hence it follows, that if the same quantity of air or gas be simultaneously submitted to changes of temperature and pressure,

the relation between its volumes, pressures, and temperatures, will be expressed by the general formula

$$\frac{v}{v'} = \frac{490 + \tau}{490 + \tau'} \times \frac{P'}{P};$$

where  $\tau$  and  $\tau'$  express the number of degrees above or below  $32^\circ$  at which the temperature stands,  $+$  being used when *above* and  $-$  when *below*  $32^\circ$ , and the pressures being expressed in the usual manner by  $P$  and  $P'$ .

By this formula, the volume of a gas at any proposed temperature and pressure may be found, if its volume at any other temperature and pressure be given.

1384. *Examples of the effects of dilatation and contraction.*—The expansion and contraction of air explain a multitude of phenomena which present themselves in the natural world, in domestic economy, and in the arts.

1385. *Ventilation and warming of buildings.*—In the ventilation and warming of buildings, the entire process, whatever expedients may be adopted, is dependent upon this principle. When a fire is lighted in an open stove to warm a room, the smoke and the gaseous products of combustion, ascending the chimney, soon fill the flue with a column of air so expanded by heat as to be lighter, bulk for bulk, than a similar column of atmospheric air. Such a column, therefore, will have a buoyancy proportional to its relative lightness. This upward tendency is what constitutes the draft of the chimney; and this draft will accordingly be strong and effective in just the same proportion as the column of air in the chimney is kept warm. When the fire is first lighted, the chimney being filled with cold air, there is no draft; and, consequently, the flame and smoke often issue into the room. According as the column of air in the chimney becomes gradually warm, the draft is produced and increased. The draft is sometimes stimulated by holding burning fuel for some time in the flue, so as to warm the lower strata of air in it.

But the most effectual method of stimulating the draft when the fire is lighted is by what is called a blower, which is a sheet of iron that stops up the space above the grate bars, and prevents any air from entering the chimney except that which passes through the fuel, and produces the combustion. This soon causes the column of air in the chimney to become heated,

and a draft of considerable force is speedily produced through the fire.

1386. *Effect of open fire-places and close stoves.* — An open chimney differs from a close stove, inasmuch as the former serves the double purpose of warming and ventilating the room, whereas the latter only warms, and can scarcely be said to ventilate. In a close stove, no air passes through the room to the flue of the chimney, except that which passes through the fuel, and that is necessarily limited in quantity by the rate of combustion maintained in the stove. In an open fire-place, on the other hand, two independent currents of air pass into the flue, one that which passes through the fuel and maintains the combustion, and the other, which is far more considerable in quantity, is that which passes through the opening of the fire-place above the grate.

The temperature of the column in the flue is due entirely to the former, and the activity of the combustion will be determined by the relative magnitudes of the grate and the space above it; these two magnitudes representing the proportion in which the open stove serves the two purposes of warming and ventilation, the grate representing the function of warming, and the space above it the function of ventilating. Even when there is no fire lighted in the grate, the column of air in the chimney is in general at a higher temperature than the external air, and a current will therefore in such case be established up the chimney, so that the fire-place will still serve, even in the absence of fire, the purposes of ventilation. In very warm weather, however, when the external air is at a higher temperature than the air within the building, the effects are reversed; and the air in the chimney being cooled, and therefore heavier than the external air, a downward current is established, which produces in the room the odour of soot. To prevent this, a trap or valve is usually provided in it, which can be closed at pleasure, so as to intercept the current. It should be observed, however, that this trap should only be closed when a downward current is established; since, at other times, even in the absence of fire, the ventilation of the apartment is maintained.

1387. *Methods of warming apartments.* — In all apparatus adapted to warm buildings, the fact that warm air is more expanded, and therefore lighter bulk for bulk, than cool air,



requires to be attended to. It is usual to admit the warm air through apertures placed in the lower parts of a room, because it will ascend by its buoyancy and mix with the colder air, whereas if it were admitted by apertures near the ceiling it would form strata in the upper part of the room, and would escape at any apertures which might be found there. But if there be means of escape only in the lower part of the room, then the strata of warm air let in above will gradually press down upon the cool air below and force it out through the chimney, doors, windows, or other apertures.

In general, the air contained in an apartment collects in strata arranged according to its temperature, the hotter air collecting near the ceiling, and the strata decreasing in temperature downwards. Thermometers placed at different heights between the floor and the ceiling would accordingly show different temperatures. The difference of these temperatures is sometimes so considerable that flies will continue to live in one stratum which would perish in another.

If the door of an apartment be open it will be found that two currents are established through it, the lower current flowing inwards and the upper outwards. If a candle be held in the doorway near the floor, it will be found that the flame will be blown inwards; but if it be raised nearly to the top of the doorway, the flame will be blown outwards. The warm air in this case flows out at the top, while the cold air flows in at the bottom.

1388. *Principle of an Argand lamp.*—The combustion which produces the flame of an Argand lamp is maintained upon the same principle as that by which the combustion is maintained in a common fire-place. The wick, which is cylindrical, surrounds a brass tube which communicates at its lower end with the external air. A glass chimney surrounds the wick and the flame. The air ascending through the glass tube passes the flame and is heated by it, and then ascends in the glass chimney within which it is confined. This glass chimney is therefore filled with a column of heated air which has a buoyancy proportional to its expansion, and ascends with a proportionate force, fresh air being supplied to the wick continually through the brass tube already mentioned. But as the column of air ascending through this brass tube would only touch the flame on its external surface, the internal parts of the

column would not be so strongly heated. To increase the heat imparted to the air, therefore, a metal wire is placed in the centre of the brass tube, which supports a button a little less in diameter than the wick at the level of the flame. When the column of air which ascends in the tube encounters this button, the central parts of the column are intercepted, and can only ascend by passing round the edge of the button, and therefore in contact with the flame. By this expedient all the air which ascends through the brass tube is made to pass in close contact with the flame before it can enter the glass chimney above the flame, and thus the intensity of the force of the draft is increased and the combustion is augmented.

It will be explained hereafter that flame is gas heated to such an intense degree as to become luminous. It is in consequence of its levity that it always ascends in the atmosphere.

1389. *Cause of atmospheric currents.* — The expansion and contraction of different parts of the atmosphere consequent upon the vicissitudes of temperature, produce the phenomena of the winds. When any portion of the atmosphere becomes heated it expands, and being lighter than the surrounding parts of the air it rises; immediately the adjacent air rushes in to fill its place and produces a wind. The sun acting with greater effect on the portions of the atmosphere around the equator than on those near the poles, these portions become heated and lighter than the former. They therefore ascend as air does in a chimney, and the colder portions of the atmosphere around the poles rush in to fill their place. There are, therefore, permanent atmospheric currents established from the poles towards the equator. These, combined with the effects of the rotation of the earth upon its axis, produce the phenomena called the trade-winds, which blow with such regularity and permanency, in the northern hemisphere from the north-east, and in the southern hemisphere from the south-east.

It must be observed, however, that the sun is not the only cause which affects the temperature of the air. The different degrees of heat reflected or radiated from the surface of the land compared with the surface of the water, form another important cause of the variation of the temperature of the air, and therefore of the atmospheric currents.

1390. *Experiments illustrating the expansion and contraction of air.* — The expansion of air by heat and its contraction by

This experiment may be rendered still more striking by using a glass bulb blown at the end of a tube, like a thermometric tube, instead of a glass. Let such a bulb be held for some minutes over the flame of a spirit-lamp. The air which fills it will become highly expanded and rarefied by the heat. Let the open end of the tube be then plunged in water, the bulb being presented upwards. After some time, when the tube has cooled and the air within it contracted, the water will rise in the tube and will nearly fill the bulb, the portion of the bulb not filled being the space within which the air previously heated had been contracted by cooling.

## CHAP. V.

### DILATATION OF LIQUIDS.

1391. *Liquid a state of transition.*—The liquid state is one of transition between the solid and the vaporous states. Solids by heat are converted into liquids, and liquids into vapours.

The liquid state, therefore, is maintained between two limits of temperature a lower limit, at which the liquid would solidify; and a higher limit, at which it would vaporize. In different liquids these limits are separated by a greater or less range of temperature. In some, alcohol for example, the point of solidification stands at a low temperature on the scale; while in others, as in some of the oils, the point of vaporization is placed at a very high limit. In others, as in mercury, these points are

widely separated, the vaporizing point being at a very high, and the freezing point at a very low temperature.

1392. *Rate of dilatation of liquids in general not uniform.*— It is found in general that the rate of dilatation of liquids is not uniform, like that of solids and gases, and that it not only increases as the temperature is elevated, but is subject to certain irregularities as it approaches the points at which the liquid would pass, on the one hand, into the solid, and, on the other, into the vaporous state.

1393. *Specific gravity of a liquid varies with its temperature.*— Since by dilatation and contraction the proportion of the volume of the liquid to its weight is varied, all the methods which have been explained in (763) *et seq.* for ascertaining the specific gravity of liquids will be equally applicable to determine their dilatation and contraction. If, for example, a given volume of liquid at a certain temperature weigh 1000 grains, and the same volume at another temperature weigh only 950 grains, the proportion of the volumes which have equal weights will be the inverse of those numbers, that is, of 950 to 1000.

1394. *Rates of dilatation of liquids.*— The only body in the liquid state whose variations of volume through a considerable range of the thermometric scale are found to be exactly proportional to its change of temperature, is mercury.

It has been ascertained that, from 13° below the freezing point to 212°, the increments of volume in this liquid for equal increments of temperature are equal.

The principal liquids whose rates of dilatation have been submitted to exact experimental investigation, are, water, mercury, and alcohol. The increment of volume which each of these liquids receives from 32° to 212° is  $\frac{1}{23}$ rd of the volume at 32° for water,  $\frac{1}{55}$ th for mercury, and  $\frac{1}{8}$ th for alcohol.

1395. *Exceptional phenomena manifested by water approaching its freezing point.*— Water, as it falls in temperature towards the freezing point, exhibits phenomena which form a striking exception to the general laws of dilatation and contraction by temperature. As its temperature is lowered, the rate at which it contracts is found to diminish until it arrives at the temperature of 38°·8 Fah. when all contraction ceases, and, if the temperature be further lowered, the volume is observed to remain stationary for some time; but, on lowering it still more, instead of

contraction, a dilatation is produced, and this dilatation continues at an increasing rate until the water is congealed. It appears, therefore, that at the temperature of  $38^{\circ}8$  the density of water is a maximum. It is found that for a few degrees above and below such temperature of greatest density the dilatation is the same; thus, at  $1^{\circ}$  above and  $1^{\circ}$  below  $38^{\circ}8$ , and at  $2^{\circ}$  above and  $2^{\circ}$  below that point, the specific gravities are exactly equal.

1396. *Temperature of greatest density.*—The experiments of Blagdon and Gilpin fixed the temperature of greatest condensation at  $39^{\circ}$ ; those of Lefevre, Gineau, Halstrom, Hope, and Rumford fixed it a little above  $40^{\circ}$ . More recent experiments, however, conducted under conditions of greater accuracy by Münke and Stampfer, have determined it at  $38^{\circ}8$ .

1397. *Taken as the basis of the French metrical system.*—Water, at its greatest density, is taken as the base of the uniform system of measures adopted in France, the unit of weight being the weight of a cube of distilled water taken at its greatest density, the side of the cube being the length of a centimetre, or the one hundredth part of a metre, which is the linear unit. The length of the metre is  $39\cdot37$  English inches.

1398. *Effect of the relative densities of different strata of the same liquid.*—It has been already proved that if liquids having different specific gravities be placed in the same vessel without mixing with each other, they will arrange themselves in strata according to their specific gravities, the heavier being below the lighter. This principle will seem to explain several facts. If cold water be poured into a vessel, a thermometer being immersed in it, and hot water be carefully poured over it, so as to prevent the liquids being mixed, the hot water will float on the cold. The thermometer immersed in the cold water will not rise, nor will a thermometer immersed in the hot water fall. But if the water be agitated so as to mix the two strata, then their temperatures will be equalized, and the lower thermometer will rise and the upper fall. If, however, hot water be first poured into the vessel, a thermometer being immersed in it, and cold water be then carefully poured over it, so as to prevent such agitation as would cause the fluids to mix, and a thermometer be also immersed in it, it will be found that the lower thermometer will rapidly fall and the higher one will rise; in fact, in this case the cold water descends through the hot water by its superior gravity, and the two fluids of dif-

ferent temperatures, in passing through one another, become mixed, and the whole mass takes an intermediate temperature.

1399. *Process of heating a liquid.* — The process by which water is boiled by heat applied to the bottom of a vessel, is explained on this principle. The water in contact with the bottom of the vessel being heated, is expanded, and becomes lighter bulk for bulk than the strata over it. It therefore rises, and the water above it falls, and, in its turn being expanded by heat, is made to rise. There is thus a continual current of the water heated by the fire upwards, and a counter current of the colder water forming the superior strata downwards; and this goes on until all the water in the vessel has been raised to the boiling point.

1400. *Heat does not descend in a liquid.* — It is easy to show that any source of heat, however intense, applied to the upper surface of water, would be incapable of raising the temperature of the mass. Thus, if we suppose oil at the temperature of  $300^{\circ}$  poured upon the surface of water in a vessel at  $50^{\circ}$ , the oil will float upon the water, and a thin stratum of the water in contact with it will have its temperature raised, and will therefore be expanded; but, being lighter bulk for bulk than the colder water under it, it will still float on the top. No interchange of currents will take place, by which the heated water forming the upper stratum can be mixed with the water forming the lower stratum; and, as water is a non-conductor of heat, as will hereafter be shown, the heat of the oil, and of the

stratum of water in immediate contact with it, will not be propagated downwards. It would be possible for a cake of ice to remain in the bottom of such a vessel without being melted, notwithstanding the stratum of oil at  $300^{\circ}$  floating upon its surface.

1401. *Experiment showing the propagation of heat through a liquid by currents.* — The system of upward and downward currents produced by heat applied to the bottom of a vessel containing a liquid, may be rendered manifest by the following experiment. Let a tall jar, *fig. 438.*, be filled with cold water, and let some amber powder be thrown into it. The particles of this powder being equal in weight to water

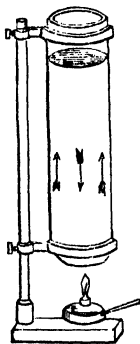

Fig. 438.

bulk for bulk, or nearly so, will remain suspended, and may be seen through the sides of the vessel. Let this jar be immersed to some depth in a vessel of hot water, so that the lowest strata of the water in it may become gradually heated. The water in the bottom of the jar will now be observed continually to ascend, carrying the amber particles with it, while the colder water in the upper part will descend. The contrary currents will be rendered manifest to the eye by the particles of amber which they carry with them.

If heat be applied to the sides of the cylindrical jar, but not to the bottom, the water immediately in contact with the sides, becoming heated, will ascend. The water in the centre of the jar, on the other hand, being removed from the source of heat, will retain its temperature, and will of course sink as the water next the side rises. In this case, two distinct currents will be seen, one immediately next the surface of the jar continually ascending, and the other in the centre of the jar continually descending.

This may be shown by placing the cylindrical glass jar within another somewhat greater in diameter, and pouring a hot liquid in the space between them.

1402. *Method of warming buildings by hot water.* — On the same principle is explained the method of warming buildings by pipes filled with hot water.

A boiler is constructed in the lowest part of the building completely closed at the top, but terminating in a tube or pipe, which is conducted upwards, and carried through the different apartments which it is intended to warm. This pipe terminates in a funnel at the top of the building, the boiler and pipe being filled with water up to the funnel. When fire is applied under the boiler, the water, becoming heated, ascends, and the colder water descends; and these contrary currents continue until every particle of water contained in the pipes carried through the building is raised to whatever temperature, under  $212^{\circ}$ , may be desired.

## CHAP. VI.

## CALORIMETRY.

1403. *Quantitative analysis of heat.*—The department of the physics of heat devoted to the quantitative analysis of that agent is called *calorimetry*, and the instruments by which its quantity is measured are called *calorimeters*.

1404. *Calorimetry and thermometry.*—If the same quantity of heat always produced the same or equal thermometric changes, every thermometer would be a calorimeter, and *calorimetry* would not form a part of this subject distinct from *thermometry*.

But not only do equal quantities of heat produce unequal thermometric changes on different bodies, but even on the same body at different points of the scale, and in some cases no thermometric change whatever.

1405. *Thermal unit.*—To reduce heat to arithmetical expression, it is necessary that some suitable thermal measure be adopted, and a thermal unit selected.

It may be assumed as self-evident, that to produce the same thermal effect on the same quantity of the same body under like circumstances will always require the same quantity of heat. Thus it is apparent, that to raise a pound of pure water from 32° to 33°, or to liquefy a pound of ice, or to convert a pound of water into vapour under a given pressure, will always require the same quantity of heat, from whatever source such heat may proceed.

Water has been selected as the standard of thermal measure, for reasons nearly the same as those which have determined its selection as the standard of specific gravity, (763, *et seq.*)

We shall therefore take as the thermal unit the quantity of heat which is necessary to raise a pound of pure water from 32° to 33°.

1406. *Specific heat.*—The quantity of heat which is necessary to raise a pound of any other body from 32° to 33°, being in general different from that which would produce the same effect on water, and in general being different for different species of bodies, is called their *specific heat*, for the same



reason that the weight they include under the same volume is called their specific gravity.

1407. *Uniform and variable.*—The specific heat of a body is said to be uniform throughout any extent of the thermometric scale when it requires the same quantity of heat to raise the temperature one degree through such extent of the scale.

If  $H$  express the quantity of heat necessary to raise  $w$  lbs. of a body from the temperature expressed by  $T'$  to the temperature expressed by  $T$ , the specific heat being expressed by  $s$  and being uniform, we shall therefore have

$$H = s \times (T - T') \times w;$$

that is to say, the quantity of heat is found by multiplying together the numbers expressing the specific heat, the elevation of temperature, and the weight in lbs.

When the quantity of heat necessary to raise a body one degree is different in different parts of the scale, the specific heat is said to be *variable*; and when it does so vary, it is in general found to increase with the temperature.

1408. *Method of solving calorimetric problems.*—Three methods have been practised for the solution of calorimetric problems: 1st, by measuring the heat by the quantity of ice it liquefies; 2ndly, by calculating it by means of mixing or bringing into close juxtaposition bodies at different temperatures so that their temperatures shall be equalized; and 3dly, by observing the rate at which heated bodies cool.

1409. *Calorimeter of Lavoisier and Laplace.*—The calorimeter of Lavoisier and Laplace is based upon the first of these principles.

This apparatus is represented in *fig. 439*. Two similar metallic vessels,  $v$  and  $v'$ , are constructed, one a little smaller than the other, so that, when applied one within the other, a small space  $A$  may be left between them. From the bottom of the external vessel

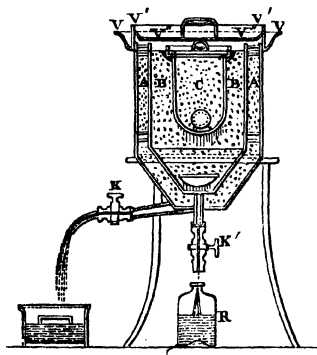

Fig. 439.

$v$  a discharge-pipe, with a stop-cock  $\kappa$ , proceeds. From the bottom of the inner vessel  $v'$  a similar pipe proceeds, which passes water-tight through the bottom of the vessel  $v$ , and is also furnished with a stop-cock  $\kappa'$ .

This pipe  $\kappa'$  is inserted into a close vessel  $R$ . The external vessel  $v$  has a close cover, by which all communication with the external air is cut off, and the inner vessel  $v'$  is likewise furnished with a small cover, by which all communication with the space  $A$  is intercepted. The space  $A$  between the two vessels is filled with pounded ice; and if the apparatus be placed in an atmosphere above  $32^\circ$ , this ice will be gradually liquefied, and the water produced by it will flow off through the cock  $\kappa$ , when the stop-cock is open, and will be received in the vessel  $B$ . The space  $A$  being kept continually supplied with ice, it is evident that the interior vessel  $v'$  will be maintained constantly at the temperature of  $32^\circ$ , and the air included in it, and any objects placed in it will be necessarily reduced to that temperature.

A third vessel  $v''$  is now placed within the second  $v'$ , and the space  $B$  between the second and third is filled with pounded ice, in the same manner as the vessel  $A$ . But it is evident that this ice cannot be affected by the temperature of the external air, since it is surrounded with the melting ice included in the space  $A$ , which is continually at  $32^\circ$ .

If any object at a temperature above  $32^\circ$  be placed at  $C$ , within the vessel  $v''$ , this object will gradually fall in its temperature by imparting its heat to the ice in the space  $B$ ; and it will continue to impart heat, and its temperature will continue to fall, until it arrives at the temperature of  $32^\circ$ , when it will cease to liquefy the ice round it. The water proceeding from the liquefaction of the ice in the space  $B$ , is discharged through the pipe  $\kappa'$ , the stop-cock being opened, and is received in the vessel  $R$ . The quantity of water thus received in  $R$  will therefore be proportional to the heat imparted by the body contained in the vessel  $v''$  to the ice in the space  $B$ .

If this apparatus be applied to solid bodies, it will be sufficient to introduce the body under experiment directly into the interior of the vessel  $v''$ ; but if it be applied to liquids, it will be necessary that the liquid under experiment should be contained in a vessel, which vessel is introduced into  $v''$ . In this case, the vessel containing the liquid should be reduced to the tem-

perature of  $32^{\circ}$  before receiving the liquid, or, if not, the vessel should be raised to the temperature of the liquid, and introduced empty into the calorimeter, so as to ascertain the quantity of ice it would dissolve empty in falling from the temperature of the liquid to  $32^{\circ}$ . When the vessel is introduced, filled with the liquid, the quantity of ice liquefied will be the sum of the quantities liquefied by the vessel and by the liquid which it contains. But the quantity liquefied by the vessel being previously ascertained and subtracted, the remainder will be the quantity dissolved by the liquid contained in the vessel.

1410. *Application of the calorimeter to determine specific heat.*—If equal weights of the same body, placed in the apparatus at different temperatures, cause quantities of water to be deposited in R which are proportional to the temperatures through which they fall, it will follow that within such limits the specific heat is uniform. And, if the quantity of water deposited in R be divided by the number of degrees through which the temperature of the body placed in the calorimeter has fallen, the quantity of ice dissolved by the heat corresponding to one degree will be found. This in fine being divided by the weight of the body placed in the calorimeter expressed in pounds, the weight of ice dissolved by the heat which would raise 1 lb. of the body one degree will be determined.

To express this in arithmetical symbols :—

Let  $w$  = the weight of the body placed in the calorimeter,

$t$  = its temperature,

$w'$  = the weight of water deposited in R while the body is reduced from  $t^{\circ}$  to  $32^{\circ}$ ,

$x$  = weight of ice dissolved by the heat which would raise 1 lb. of the body one degree.

We shall then have

$\frac{w'}{(t-32)}$  = the weight of ice dissolved by the heat which would raise  $w$  one degree ;

and therefore,

$$x = \frac{w'}{w \times (t-32)}$$

1411. *Specific heat of water uniform.*—In applying this method of experimenting to water, it is found that between the

freezing and boiling points its specific heat is sensibly uniform, and that the heat necessary to raise 1 lb. of water one degree is that which would dissolve the 142·65th part of a lb. of ice, so that in the case of water we have  $x = \frac{1}{142\cdot65}$ .

1412. *Method of ascertaining the specific heat of other bodies by the calorimeter.*—Let the specific heat of the body  $w$  be expressed by  $s$ , that of water being the unit. Hence we shall have,

$$s : 1 :: \frac{w'}{w \times (T-32)} : \frac{1}{142\cdot65};$$

and consequently,

$$s = \frac{142\cdot65 \times w'}{w \times (T-32)};$$

which gives the following

RULE.

*Multiply the weight of ice dissolved by 142·65, and multiply the weight of the body which dissolves the ice by the number of degrees of temperature it loses, and divide the former product by the latter. The quotient will be the specific heat of the body.*

1413. *Method of equalization of temperatures.*—When two bodies at different temperatures are mixed, or brought into juxtaposition in such a manner that that which has the higher temperature may transfer to that which has the lower temperature such a portion of its heat that the temperatures may be equalized, the relation between the specific heats may be determined, provided no chemical action nor any change of state be produced by the contact or mixture.

Let the weights of the two bodies be  $w$  and  $w'$ , their temperatures  $T$  and  $T'$ , and their specific heats  $s$  and  $s'$ ; and let  $t$  be their common temperature, after the thermometric equilibrium has been established.

It will therefore follow, that the temperature lost by  $w$  will be  $T-t$ , and the temperature gained by  $w'$  will be  $t-T'$ . But from what has been already explained, the quantity of heat lost by  $w$  will be expressed by  $s \times w \times (T-t)$ , and the quantity of heat gained by  $w'$  will be expressed by  $s' \times w' \times (t-T')$ . But since the quantity of heat lost by  $w$  is imparted to  $w'$ , these two quantities must be equal, and consequently we must have

$$w \times s \times (T-t) = w' \times s' \times (t-T');$$

and from this we infer that

$$s : s' :: w' \times (t - T') : w \times (T - t);$$

that is to say, the specific heats of the two bodies are in the inverse proportion of the products of their weights, and the temperatures which they gain and lose.

This method of determining the relation between the specific heats is applicable either to two liquids, or to a solid and a liquid, provided that when they are mixed or brought together no chemical action takes place between them, and provided the solid be not liquefied. But if such action ensue, it is generally attended with the development or absorption of sensible heat, by which the common temperature would be rendered either higher or lower than that which would result from mere admixture.

1414. *Application of this method.*—If one of the bodies  $w'$  be water, we shall have  $s'=1$ , and therefore

$$s = \frac{w' \times (t - T')}{w \times (T - t)};$$

from which follows the

#### RULE.

*Let the weight of a heated body immersed in water be multiplied by the temperature it loses, and let the weight of the water be multiplied by the temperature it gains. The quotient obtained by dividing the latter product by the former will be the specific heat of the body.*

The method of determining the specific heat of gaseous bodies by means of the water calorimeter of Count Rumford, is similar in principle to the preceding method. This apparatus consists of a worm carried through a vessel of water in a manner similar to the worm of a still. The gas being previously weighed, prepared, and dried, is raised to  $212^{\circ}$  by passing it through a similar worm placed in a vessel of boiling water. It is then passed through the worm of the calorimeter and raises the temperature of the water, its own temperature falling. The elevation of the temperature of the water and the fall of the temperature of the gas being observed, data are obtained from which the specific heat of the gas is calculated.

1415. *Method of cooling.*—Equal and similar volumes of two bodies raised to the same temperature and allowed to cool under precisely similar circumstances, are assumed to lose equal quantities of heat per minute. In order to ensure the exact fulfilment of these conditions, a multitude of precautions are necessary which cannot be detailed here. The result, however, is that by observing the intervals of time which are necessary for equal volumes of the two bodies to fall one degree, we obtain the ratio of the quantities of heat which they lose, and this being determined for equal volumes, the quantities for equal weights may be inferred from the specific gravities of the bodies, and the specific heats will thus be obtained.

This was applied with considerable success by Dulong and Petit, and also by Regnault.

1416. *Results of calorimetric researches.*—Having thus explained the principal methods by which the specific heat of bodies has been experimentally ascertained, we shall now state the most important results which have been attained in this department of the physics of heat.

1417. *Relation of specific heat to density.*—The specific heat of bodies diminishes as their density is increased, and *vice versâ*. This explains the fact that mechanical compression will, without any addition of heat, raise the temperature. If metal be hammered it becomes hot, and it is even affirmed that iron has been rendered incandescent in this manner.

1418. *The fire-syringe.*—The syringe in which compressed air is made to inflame amadou acts on this principle. The air compressed under the syringe acquires a greatly diminished specific heat, and, consequently, although it has received no heat from any external source, the same heat which before compression only gave it the common temperature of the surrounding medium, gives it, after compression, a temperature high enough to produce the ignition of a highly inflammable substance like amadou.

1419. *Specific heat of gases and vapours increase as their density is diminished.*—In general, no practicable force can prevent the dilatation of solids and liquids when their temperature is elevated. This, however, is not the case with gases and vapours, which, when heat is imparted to them, may either be permitted to expand under a given pressure, like solids and liquids; or may be confined to a given volume, which they will

continue to fill in consequence of their elasticity (706), however their temperature may be lowered, and which they will not exceed, however their temperature may be raised.

In this case, the heat imparted or abstracted is manifested by a corresponding change of pressure of the gas or vapour instead of dilatation or contraction.

1420. *Specific heat under constant pressure and constant volume.*—By the specific heat of a gas or vapour is to be understood its specific heat when subject to a constant pressure, that is to say, when it is susceptible, like solids and liquids, of dilatation and contraction.

Specific heat is, however, a term sometimes, though not so properly, applied to the heat necessary to raise the gas or vapour one degree when confined within a given volume. This last is sometimes also called, for distinction, the *relative heat*.

1421. *Greater under a constant pressure.*—The specific heat of a gas or vapour under a given pressure is greater than under a given volume. This difference is explained by the fact, that, in expanding, the temperature falls, and therefore that, when confined to a given volume, less heat is sufficient to produce a given elevation of temperature than when confined under a given pressure, where the dilatation diminishing the density absorbs a portion of the heat.

For atmospheric air, oxygen and hydrogen, the ratio of the specific heat under a given pressure is to the specific heat in a given volume as 1.421 to 1. For carbonic acid it is 1.338; for carbonic oxide, 1.428; for nitrous oxide, 1.343; and for olefiant gas, 1.240.

1422. *Example of the expansion of high-pressure steam.*—The expansion of high-pressure steam escaping from the safety valve forms a remarkable instance that the same quantities of heat may give very different temperatures to a body, in different states of density. Steam produced under a pressure of 35 atmospheres has the temperature of 419°. When such steam escapes into the atmosphere, it undergoes a prodigious expansion without losing heat, and suffers a considerable fall in temperature.

1423. *Low temperature of superior strata of atmosphere.*—The circumstance that rarefied air has an increased capacity for heat, will explain the very low temperatures which are known to exist in the higher regions of the atmosphere.

This effect becomes extremely sensible when we ascend to any considerable height, as has been manifest in ascending high mountains and in balloons. Upon these occasions, the cold has sometimes become so intense, that mercury in the thermometer has been frozen. In strata so elevated that the permanent temperature of the air is below  $32^{\circ}$ , water cannot continue in the liquid state; it exists there only in the form of ice or snow, and we accordingly find eternal snow deposited upon those parts of high mountains which exceed this limit of temperature.

1424. *Line of perpetual snow.*—The level of that stratum of air which by its rarefaction reduces the temperature to  $32^{\circ}$ , is called the *line of perpetual snow*, and its position in different parts of the earth varies, the height increasing generally in approaching the equator, and falling towards the poles. The various conditions which affect the position of this line in different parts of the earth will be explained in a subsequent Book.

1425. *Liquefaction of gases.*—The elevation of temperature produced by the compression of gases, has supplied means of reducing some of them to the liquid form.

Gases may be considered as vapours raised from liquids, which have received, after their separation from the liquid which produced them, a large additional supply of heat. It is to the effects of this surplus heat that their permanent maintenance in the gaseous state must be ascribed. If, by any means, they can be deprived of this surplus heat, so that no heat shall be left in them except that which they received in the process of vaporization, any further loss of heat would necessarily cause them to return, in more or less quantity, to the liquid form. But if the specific heat be so great, that notwithstanding all the heat transmitted to the gas after taking the vaporous form, it still has attained only the common temperature of the atmosphere, it is clear that it can only be restored to the liquid form, either by reducing its temperature to an immense extent, by the application of freezing mixtures, or by first raising its temperature by high degrees of mechanical compression, and then allowing it to fall to the temperature of surrounding objects, or, in fine, by combining both these methods. Thus atmospheric air, at the common temperature of  $50^{\circ}$ , being compressed into a diminished volume, in the proportion of 10,000 to 3, its temperature would be raised through an extent of  $13,500^{\circ}$  of



heat, according to Leslie's experiment. This heat being immediately abstracted by the surrounding objects, its temperature would fall to that of the medium in which it is placed. Thus, without the application of a freezing mixture, or other means of cooling, an immense abstraction of heat may be effected; and this may be continued so long as a mechanical force adequate to the further compression of the gas could be exerted. Freezing mixtures may then be applied to the further reduction of temperature.

1426. *Development and absorption of heat by chemical combination.*—When different liquids are mixed, or when solids are dissolved in liquids, chemical phenomena are generally developed, in consequence of which the specific heat of the mixture differs from that which it would have if the constituents were merely interfused without any change in their thermal qualities. 'Like the other qualities of the constituents, their specific heats are in this case modified; and the compound is generally found to have a less specific heat, than that which would be inferred from the specific heats of its components. When the chemical combination is thus, as it is almost universally, attended by a diminution in the specific heat of the compound as compared with that which would be computed from the specific heats of its components, it is also found that the volume of the mixture is less than the sum of the volumes of its compounds, and that the temperature of the mixture is higher than the common temperature of the liquids mixed.

Thus, for example, if a pint of water and a pint of sulphuric acid, both of the temperature of  $57^{\circ}$ , be mixed, the mixture will rise to the temperature of  $212^{\circ}$ , and the volume of the mixture will be considerably less than a quart. The chemical attraction of the particles, therefore, in this and like cases, produces condensation, and, in fact, the same effect ensues as would be produced by compression. The elevation of temperature may be explained in exactly the same manner, as when bodies are compressed by mechanical force. The specific heat of the mixture being less than that which is due to its component parts, and the absolute quantity of heat contained in it not being diminished, that quantity will raise it to a much higher temperature than that which it would have had, if the specific heats remained unaltered.

1427. *Specific heats of simple gases equal under the same*

*pressure.*—Under equal pressures the simple gases have the same specific heat. This uniformity, however, does not prevail among the compound gases, as will appear by the tables of specific heat of the gases.

1428. *Formula for the variation of specific heat consequent on change of pressure.*—The law according to which the same gas varies its specific heat with the change of pressure or density is, according to Poisson, expressed by the formula—

$$s = s' \times \left( \frac{30}{P} \right)^{1 - \frac{1}{k}},$$

where P expresses the pressure in inches of mercury, s' the specific heat under the mean pressure of 30 inches, and k the constant number, which expresses the ratio of the specific heat under a given pressure to the specific heat under a given volume, which, in the case of common air and the simple gases, is 1.421, as has been already explained, and as will appear by the tables.

1429. *Relation between specific heat and atomic weight.*—On comparing together the numbers expressing the specific heat of the simple bodies, with those which express their atomic weights or chemical equivalents, Dulong and Petit observed that the one increased in almost the exact proportion in which the other diminished, so that by multiplying them together, a product very nearly constant was obtained.

From this it would follow, upon the atomic hypothesis, that the specific heats of the atoms of all the simple bodies are equal. For in equal weights, the number of constituent atoms will be great in proportion as the individual weights of these atoms are small. The number of atoms, therefore, in equal weights, being inversely proportional to the weights of the atoms, and the specific heats being also inversely proportional to the weights of the atoms, it follows that the specific heats of equal weights are in the proportion of the number of atoms contained in those weights, and that, consequently, the specific heats of the component atoms must be equal.

This, therefore, is a quality in which the atoms of all simple bodies, however they may differ in other respects, agree, — that their temperatures are equally affected by the same quantity of heat.

That this law is not rigorously exact, however, is proved by

the fact, that the specific heat of the same body is different at different temperatures and in different states.

It has resulted from the researches of Regnault, that the relation between the specific heat and atomic weights, observed by Dulong and Petit in the simple bodies, also prevails among compound bodies; and that, in general, in all compound bodies of the same atomic composition and having similar chemical constituents, the specific heat is in the inverse ratio of the atomic weight: this law, however, being subject to the same qualification which has been already mentioned for the simple bodies.

The numerical results which manifest the prevalence of this law will be seen in the tables of specific heat.

1430. *Tables of specific heat.*—The following series of tables supply, in a summary form, the results of the most recent experimental researches respecting the specific heat of bodies, and the relation between these, and their chemical constitution.

*Table of specific Heats of simple and compound Bodies determined by M. Regnault.*

Names of Substances.	Specific Heats.	Atomic Weights. (Oxygen=100.)	Products.
<i>Preliminary Results.</i>			
Brass - - - - -	0·09391		
Glass - - - - -	0·19768		
Water - - - - -	1·0080		
Turpentine, spirit of - - - - -	0·42593		
<i>Simple bodies, pure.</i>			
Iron - - - - -	0·11379	339·21	38·597
Zinc - - - - -	0·09555	403·23	38·526
Copper - - - - -	0·09515	395·70	37·849
Cadmium - - - - -	0·05669	696·77	39·502
Silver - - - - -	0·05701	675·80	38·527
Arsenic - - - - -	0·08140	470·04	38·261
Lead - - - - -	0·03140	1294·50	40·647
Bismuth - - - - -	0·03084	1330·37	45·034
Antimony - - - - -	0·05077	806·45	40·944
Tin, Indian - - - - -	0·05623	735·29	41·345
Nickel - - - - -	0·10863	369·68	40·160
Cobalt - - - - -	0·10696	368·99	39·468
Platinum, rolled - - - - -	0·03243	1233·50	39·993
Palladium - - - - -	0·05927	665·90	39·468
Gold - - - - -	0·03244	1243·01	40·328
Sulphur - - - - -	0·20259	201·17	40·754
Selenium - - - - -	0·0837	494·58	41·403
Tellurium - - - - -	0·05155	801·76	41·549
Iodine - - - - -	0·05412	789·75	42·702
Mercury - - - - -	0·03332	1265·82	42·149
<i>Simple bodies, less pure.</i>			
Uranium - - - - -	0·06190	677·84	41·960
Tungsten - - - - -	0·03636	1183·00	43·002
Molybdenum - - - - -	0·07218	598·52	43·163
Nickel, carburetted - - - - -	C·11192	369·68	41·376

Names of Substances.	Specific Heats.	Atomic Weights. (Oxygen = 100.)	Products.
Nickel, more carburetted	0·11631	369·68	42·999
Cobalt, carburetted	0·11714	366·99	43·217
Steel (Hausmann)	0·11848	339·21	40·172
„ pure metal	0·12728	339·21	
Cast iron (white)	0·12983	339·21	44·0·8
Carbon	0·24111	152·88	36·873
Phosphorus	0·1887	196·14	37·024
Iridium (impure)	0·03683	1233·50	45·428
Manganese, very carburetted	0·14411	345·89	49·848
<i>Metallic alloys.</i>			
1 Lead, 1 tin	0·04073	1014·9	41·34
1 „ 2 „	0·04506	921·7	41·53
1 „ 1 antimony	0·03880	1050·5	40·76
1 Bismuth, 1 tin	0·04000	1032·8	41·31
1 „ 2 „	0·04504	933·7	42·05
1 „ 2 „ 1 antimony	0·04621	901·8	41·67
1 „ 2 „ 1 „ 2 zinc	0·05657	735·6	41·61
1 Lead, 2 „ 1 bismuth	0·04476	1023·9	45·83
1 „ 2 „ 2 „	0·06082	1088·2	66·00
1 Mercury, 1 „	0·07294	1000·5	72·97
1 „ 2 „	0·06591	912·1	60·12
1 „ 1 lead	0·03827	1280·1	48·90
<i>Oxides, RO.</i>			
Protoxide of lead in powder	0·05118	1394·5	71·34
„ cast	0·05089	1394·5	70·94
Oxide of mercury	0·05179	1365·8	70·74
Protoxide of manganese	0·15701	445·9	70·01
Oxide of copper	0·14201	495·7	70·39
„ of nickel	0·16234	469·6	76·21
„ „ calcined at the forge	0·15885	469·6	74·60
Mean	-	-	72·03
Magnesia	0·24394	258·4	63·03
Oxide of zinc	0·12480	503·2	62·77
<i>Oxides, R<sup>2</sup>O<sup>3</sup>.</i>			
Peroxide of iron (iron oligist)	0·16695	978·4	163·35
„ slightly calcined	0·17569	978·4	171·90
„ doubly calcined	0·17167	978·4	168·00
„ strongly calcined	-	-	-
„ „ twice	0·16814	978·4	164·44
Acid, arsenious	0·12786	1240·1	158·56
Oxide of chromium	0·17960	1003·6	180·01
„ of bismuth	0·06053	2960·7	179·22
„ of antimony	0·09009	1912·9	172·34
Mean	-	-	169·73
Alumina (Corindon)	0·19762	642·4	126·87
„ (sapphire)	0·21732	642·4	139·61
<i>Oxides, RO<sup>2</sup>.</i>			
Acid, stannic	0·09326	935·3	87·23
„ titanio (artificial)	0·17164	503·7	86·45
„ „ (rutile)	0·17032	503·7	85·79
Mean	-	-	86·49
„ antimonious	0·09535	1006·5	95·92
<i>Oxides, RO<sup>3</sup>.</i>			
Acid, tungstic	0·07983	1483·2	118·38
„ molybdic	0·13240	898·5	118·96
„ silicic	0·19132	577·5	110·48
„ boracic	0·23743	436·0	103·52
<i>Oxides.</i>			
Oxide of magnetic iron	0·16780	1417·6	237·87
<i>Sulphurets, RS.</i>			
Proto-sulphuret of iron	0·13570	540·4	73·33
Sulphuret of nickel	0·12813	570·8	73·15

Names of Substances.	Specific Heats.	Atomic Weights. (Oxygen = 100.)	Products.
Sulphuret of cobalt - - - -	0.12512	570.0	71.34
„ of zinc - - - -	0.12303	604.4	74.35
„ of lead - - - -	0.05086	1495.6	76.00
„ of mercury - - - -	0.05117	1467.0	75.06
Proto-sulphuret of tin - - - -	0.08365	936.5	78.34
Mean - - - -	- - - -	- - - -	74.51
<i>Sulphurets, R<sup>2</sup>S<sup>2</sup>.</i>			
Sulphuret of antimony - - - -	0.08403	2216.4	186.21
„ of bismuth - - - -	0.06002	3261.2	195.90
Mean - - - -	- - - -	- - - -	191.06
<i>Sulphurets, RS<sup>2</sup>.</i>			
Bi-sulphuret of iron - - - -	0.13009	741.6	96.45
„ of tin - - - -	0.11.32	1137.7	136.66
Sulphuret of molybdenum - - - -	0.12334	1001.0	123.46
Mean - - - -	- - - -	- - - -	129.56
<i>Sulphurets, R<sup>2</sup>S.</i>			
Sulphuret of copper - - - -	0.12118	992.0	120.21
„ of silver - - - -	0.07460	1553.0	115.86
<i>Sulphurets.</i>			
Pyrites, magnetic - - - -	0.16023	- - - -	- - - -
<i>Chlorates, R<sup>2</sup>Cl<sup>2</sup>.</i>			
Chlorate of sodium - - - -	0.21401	733.5	156.97
„ of potassium - - - -	0.17295	932.5	161.19
„ of mercury - - - -	0.05205	2974.2	154.80
„ of copper - - - -	0.13827	1234.0	156.83
„ of silver - - - -	0.09109	1794.2	163.42
Mean - - - -	- - - -	- - - -	158.64
<i>Chlorates, RCl<sup>2</sup>.</i>			
Chlorate of barium - - - -	0.08957	1299.5	116.44
„ of strontium - - - -	0.11990	989.9	118.70
„ of calcium - - - -	0.16420	698.6	114.72
„ of magnesium - - - -	0.10460	601.0	118.54
„ of lead - - - -	0.11	1737.1	115.35
Pro-chlorate of mercury - - - -	0.06889	1708.4	117.68
„ of zinc - - - -	0.13618	845.8	115.21
„ of tin - - - -	0.10161	1177.9	119.59
Mean - - - -	- - - -	- - - -	117.03
Chlorate of manganese - - - -	0.14255	788.5	112.51
<i>Chlorides volatile, RCl<sup>1</sup>.</i>			
Chloride of tin - - - -	0.14759	1620.5	239.18
„ of titanium - - - -	0.19145	1188.9	237.63
Mean - - - -	- - - -	- - - -	233.40
<i>Chlorides volatile, R<sup>2</sup>Cl<sup>6</sup>.</i>			
Chlorate of arsenic - - - -	0.17604	2267.8	399.26
„ of phosphorus - - - -	0.20922	1720.1	359.86
Mean - - - -	- - - -	- - - -	379.51
<i>Bromates, R<sup>2</sup>Br<sup>2</sup>.</i>			
Bromate of potassium - - - -	0.11322	1468.2	166.21
„ of silver - - - -	0.07391	2330.0	173.31
Mean - - - -	- - - -	- - - -	169.76
Bromate of sodium - - - -	0.13842	1269.2	175.63
<i>Bromates, RBr<sup>2</sup>.</i>			
Bromate of lead - - - -	0.05326	2272.8	121.00

Names of Substances.	Specific Heats.	Atomic Weights. (Oxygen = 100.)	Products.
<i>Iodates, R<sup>2</sup>I<sup>2</sup>.</i>			
Iodate of potassium - - - -	0·08191	2668·2	169·38
„ of sodium - - - -	0·08684	1869·2	1·2·30
Prot-iodate of mercury - - - -	0·03949	4109·3	162·34
„ of silver - - - -	0·06159	2929·9	180·45
„ of copper - - - -	0·06869	2369·7	162·81
Mean - - - -	-	-	167·45
<i>Iodates, RI<sup>2</sup>.</i>			
Iodate of lead - - - -	0·04267	2872·8	122·54
„ of mercury - - - -	0·04197	2844·1	119·36
Mean - - - -	-	-	120·95
<i>Fluorates, RFI<sup>2</sup>.</i>			
Fluorate of calcium - - - -	0·21492	489·8	105·31
<i>Nitrates, Az<sup>2</sup>O<sup>5</sup> + R<sup>2</sup>O.</i>			
Nitrate of potash - - - -	0·23875	1266·9	302·49
„ of soda - - - -	0·27821	1067·9	297·13
„ of silver - - - -	0·14352	2128·6	305·55
Mean - - - -	-	-	301·72
<i>Nitrates, Az<sup>2</sup>O<sup>5</sup> + RO.</i>			
Nitrate of barytes - - - -	0·15228	1633·9	248·83
<i>Chlorates, Cl<sup>2</sup>O<sup>5</sup> + R<sup>2</sup>O.</i>			
Chlorate of potash - - - -	0·20956	1532·4	321·04
<i>Phosphates, P<sup>2</sup>O<sup>5</sup> + 2R<sup>2</sup>O (Pyrophosphates).</i>			
Phosphate of potash - - - -	0·19102	2072·1	395·70
„ of soda - - - -	0·22833	1674·1	382·22
Mean - - - -	-	-	389·01
<i>Phosphate, P<sup>2</sup>O<sup>5</sup> + 2 RO.</i>			
Phosphate of lead - - - -	0·08208	3681·3	302·14
<i>Phosphate, P<sup>2</sup>O<sup>5</sup> + RO.</i>			
Phosphate of lime - - - -	0·19923	1248·3	248·64
<i>Phosphate, P<sup>2</sup>O<sup>5</sup> + 3 RO.</i>			
Phosphate of lead - - - -	0·07982	4985·8	397·96
<i>Arsenites, AsO<sup>5</sup> + R<sup>2</sup>O.</i>			
Arsenite of potash - - - -	0·15631	„	„
<i>Arsenites of lead, As<sup>2</sup>O<sup>5</sup> + 3 PbO.</i>			
Arsenite of lead - - - -	0·07280	5623·5	409·37
<i>Sulphates, SO<sup>3</sup> + R<sup>2</sup>O.</i>			
Sulphate of potash - - - -	0·19010	1091·1	207·40
„ of soda - - - -	0·23115	892·1	206·21
Mean - - - -	-	-	206·80
<i>Sulphates, SO<sup>3</sup> + RO.</i>			
Sulphate of barytes - - - -	0·11285	1458·1	164·54
„ of strontium - - - -	0·14279	1148·5	164·01
„ of lead - - - -	0·08723	1895·7	165·39
„ of lime - - - -	0·19656	857·2	168·40
„ of magnesia - - - -	0·22159	759·5	168·30
Mean - - - -	-	-	166·15
<i>Chromates.</i>			
Chromate of potash - - - -	0·18505	1241·7	229·83
Bi-chromate of potash - - - -	0·18937	1893·5	358·67
<i>Borates, B<sup>2</sup>O<sup>6</sup> + R<sup>2</sup>O.</i>			
Borate of potash - - - -	0·21975	1461·9	321·27

Names of Substances.	Specific Heats.	Atomic Weights. (Oxygen=100.)	Products.
Borate of soda - - - -	0.23323	1262.9	300.88
Mean - - - -	- - - -	- - - -	311.07
<i>Borates, B<sup>2</sup>O<sup>3</sup>+R<sup>2</sup>O.</i>			
Borate of lead - - - -	0.11409	2266.5	258.60
<i>Borates, B<sup>2</sup>O<sup>3</sup>+2 R<sup>2</sup>O.</i>			
Borate of potash - - - -	0.20478	1025.9	219.52
" of soda - - - -	0.25709	826.9	212.60
Mean - - - -	- - - -	- - - -	216.06
<i>Borates, BO<sup>3</sup>+2 RO.</i>			
Borate of lead - - - -	0.09046	1830.5	164.54
<i>Tungstates.</i>			
Wolfram - - - -	0.09780	"	"
<i>Silicates.</i>			
Zirconia - - - -	0.14548	"	"
<i>Carbonates, CO<sup>2</sup>+R<sup>2</sup>O.</i>			
Carbonate of potash - - - -	0.21623	865.0	187.04
" of soda - - - -	0.27275	666.0	181.65
Mean - - - -	- - - -	- - - -	184.35
<i>Carbonates, CO<sup>2</sup>+RO.</i>			
Carbonate of lime (Iceland spar) - - - -	0.20858	631.0	131.61
" (Arragonite) - - - -	0.20850	631.0	131.56
Marble, white - - - -	0.21585	631.0	136.20
" grey - - - -	0.20989	631.0	132.45
Chalk, white - - - -	0.21585	631.0	135.57
Carbonate of barytes - - - -	0.11038	1231.9	135.99
" of strontium - - - -	0.14483	922.3	133.58
" of iron - - - -	0.19345	714.2	138.16
Mean - - - -	- - - -	- - - -	134.40
Carbonate of lead - - - -	0.08596	1669.5	143.55
" " - - - -	0.21743	582.2	126.59

*Specific Heats of different Bodies determined by M. Regnault.*

Names.	Specific Heats.	Densities.
Animal black - - - -	0.26085	
Charcoal - - - -	0.24150	
Coke of cannel coal - - - -	0.20307	
" of small coal - - - -	0.20085	
Welsh anthracite coal - - - -	0.20171	
Philadelphia " - - - -	0.20100	
Graphite, natural - - - -	0.20187	
" of smelting furnaces - - - -	0.19702	
" of gas retorts - - - -	0.20360	
Diamond - - - -	0.14687	
Turpentine - - - -	0.4672	
Camphilène - - - -	0.4656	
Térébilène - - - -	0.4580	
Térébène - - - -	0.4518	
Lemon juice - - - -	0.4879	
Orange juice - - - -	0.4886	
Gin - - - -	0.4770	
Petroleum - - - -	0.4684	
Steel, soft - - - -	0.1165	7.8609
" tempered - - - -	0.1175	7.7982
Metal of acute cymbals - - - -	0.0858	8.5797
" of soft cymbals, tempered - - - -	0.0862	8.6348
Dutch tears, hard - - - -	0.1923	
" annealed - - - -	0.1937	

Names.	Specific Heats.	Densities.
Sulphur naturally crystallized	0.1776	
" melted for two years	0.1764	
" " for two months	0.1803	
" " recently	0.1844	
Water		
Spirit of turpentine	0.4160	
Solution of chlorate of calcium	0.6448	
Spirit of wine, common at 36°	0.6588	
" of higher degree	0.8413	
" of still higher	0.9402	
Acetic acid concentrated, not crystallized	0.6501	

*Specific Heats determined by M. Regnault.*

Names of Bodies.	Specific Heats.		
	From 20° to 15°.	From 15° to 10°.	From 10° to 5°.
Distilled water	"	"	"
Spirit of turpentine	"	"	"
Solution of chlorate of calcium	0.6462	0.6389	0.6423
Spirit of wine, common, No. 1.	0.6725	0.6651	0.6588
• " weaker, No. 2.	0.8518	0.8429	0.8523
" still weaker, No. 3.	0.9752	0.9682	0.9770
" common	0.6774	0.6540	0.6465
Acetic acid	0.6589	0.6577	0.6609
Mercury	0.0290	0.0283	0.0282
Térébène	0.4267	0.4156	0.4154
Lemon juice	0.4501	0.4424	0.4489
Petroleum	0.4342	0.4325	0.4321
Benzine	0.3932	0.3865	0.3999
Nitrobenzine	0.3499	0.3478	0.3524
Chlorate of silicium	0.1904	0.1904	0.1914
" of titanium	0.1828	0.1802	0.1810
Chloride of tin	0.1416	0.1402	0.1421
Protochlorate of phosphorus	0.1991	0.1987	0.2017
Sulphate of carbon	0.2206	0.2183	0.2179
Ether	0.5157	0.5158	0.5207
" sulphydric	0.4772	0.4653	0.4715
" iodhydric	0.1584	0.1584	0.1587
Spirit of wine	0.6148	0.6017	0.5987
Ether, oxalic	0.4554	0.4521	0.4629
Spirit of wood	0.6009	0.5868	0.5901
Ether, iodhydric	0.1569	0.1556	0.1574
" bromhydric	0.2153	0.2135	0.2164
Chlorate of sulphur	0.2038	0.2024	0.2048
Acetic acid, crystallizable	0.4618	0.4599	0.4587

## CHAP. VII.

### LIQUEFACTION AND SOLIDIFICATION.

1431. *Thermal phenomena attending liquefaction.*—It has been already explained, that when heat is imparted in sufficient quantity to a solid body, such body will at a certain point pass into the liquid state; and when it is abstracted in sufficient quantity from a liquid, the liquid at a certain point will pass into the solid state.



1432.— Certain thermal phenomena of great interest and importance are developed in the progress of these changes, which it will now be necessary to explain.

Let us suppose that a mass of ice or snow, at the temperature of  $20^{\circ}$ , is placed in a vessel and immersed in a bath of quick-silver, under which spirit-lamps are placed. Let one thermometer be immersed in the ice or snow, and another in the mercury. Let the number and force of the lamps be so regulated, that the thermometer in the mercury shall indicate the uniform temperature of  $200^{\circ}$ . The mercury imparting heat to the vessel containing the ice, will first cause the ice to rise from  $20^{\circ}$  to  $32^{\circ}$ , which will be indicated by the thermometer immersed in the ice; but when that thermometer has risen to  $32^{\circ}$ , it will become stationary, and the ice will begin to be liquefied. This process of liquefaction will continue for a considerable time, during which, the thermometer will continue to stand at  $32^{\circ}$ ; at the moment that the last portion of ice is liquefied, it will again begin to rise. The coincidence of this elevation with the completion of the liquefaction may be easily observed, because ice, being lighter bulk for bulk than water, will float on the surface, and so long as a particle of it remains unmelted it will be visible.

Now, it is evident that during this process, the mercury maintained at  $200^{\circ}$  constantly imparts heat to the ice: yet from the moment the liquefaction begins until it is completed, no increase of temperature is exhibited by the thermometer immersed in the ice. If during this process no heat were received by the ice from the mercury, the lamps would cause the temperature of the mercury to rise above  $200^{\circ}$ , which may be easily proved by withdrawing the vessel of ice from the mercurial bath during the process of liquefaction. The moment it is withdrawn, the thermometer immersed in the mercury, instead of remaining fixed at  $200^{\circ}$ , would immediately begin to rise, although the action of the lamps remained the same as before; from which it is obvious that the heat, which on the removal of the ice causes the mercury to rise above  $200^{\circ}$ , was before imparted to the melting ice.

1433. It is evident, therefore, that the heat which is received by the melting ice during the process of liquefaction is latent in it, being incapable of affecting the thermometer or the senses.

If the hand be plunged in the ice at the moment it begins to melt, and at the moment that its liquefaction is completed, the sense of cold will be precisely the same, notwithstanding the large quantity of heat which must have been imparted to the ice during the process of liquefaction.

1434. *Quantity of heat rendered latent in liquefaction.*—The quantity of heat which is absorbed and rendered latent in the process of liquefaction, can be directly ascertained by the calorimeter of Laplace and Lavoisier (1409). To ascertain this in the case of ice, it is only necessary to place a pound of water at any known temperature in the apparatus, and observe the weight of ice it will dissolve in falling to any other temperature. In this way it will be found, that in falling through  $142^{\circ}65$  it will dissolve a pound of ice; and in general, any proposed weight of water, in falling through this range of temperature, will give out as much heat as will dissolve its own weight of ice.

1435. Hence it is inferred, that when ice is liquefied, it absorbs and renders latent as much heat as would be sufficient to raise its own weight of water from  $32^{\circ}$  to  $32^{\circ} + 142^{\circ}65 = 174^{\circ}65$ .

1436. The latent heat of water has for the last half century been estimated at  $135^{\circ}$ , that having been the result of the experimental researches of Lavoisier and Laplace. Dr. Black's estimate was  $140^{\circ}$ , and that of Cavendish  $150^{\circ}$ . A series of experiments have lately been made, under conditions of greater precision, by MM. de la Provostaye and Desains, from which the above estimate has been inferred.

Dr. Black, who first noticed this remarkable fact, inferred that ice is converted into water by communicating to it a certain *dose* of heat, which enters into combination with it in a manner analogous to that which takes place when bodies combine chemically. The heat thus combined with the ice losing its property of affecting the senses or the thermometer, the phenomenon bears a resemblance to those cases of chemical combination, in which the constituent elements change their sensible properties when they form the compound.

1437. *Latent heat rendered sensible by congelation.*—If it be true that water is formed by the combination of a large quantity of heat with ice, it would necessarily follow, that, in the reconversion of water into ice, or in the process of congelation, a cor-

responding quantity of heat must be disengaged. This fact can be easily established, by reversing the experiment just described.

Let us suppose that a vessel containing water at  $60^{\circ}$  is immersed in a bath of mercury at the temperature of  $60^{\circ}$  below the freezing point. If one thermometer be immersed in the mercury, and another in the water, the former will gradually rise, and the latter fall, until the latter indicates  $32^{\circ}$ . This thermometer will then become stationary, and the water will begin to freeze; meanwhile the thermometer immersed in the mercury will still rise, proving that the water while it freezes continually imparts heat to the mercury, although the thermometer immersed in the freezing water does not fall. When the congelation is completed, and the whole quantity of water is reduced to the solid state, then, and not until then, the thermometer immersed in the ice will again begin to fall. The thermometer immersed in the mercury will rise without interruption, until the two thermometers meet at some temperature below  $32^{\circ}$ .

1438. It is evident from this, that the heat which was latent in the water while in the liquid state, is gradually disengaged in the process of congelation; and since the temperature of the ice remains the same as that of the water before congelation, the heat thus disengaged must pass to some other object, which in this case is the mercury.

When congelation takes place under ordinary circumstances, the latent heat which is disengaged from the water which becomes solid is in the first instance imparted to the water which remains in the liquid state. When this water passes into the solid state, the heat which is disengaged from it is transmitted to the adjacent water which remains in the liquid state; and so on.

1439. *Other methods of determining the latent heat of water.*—The latent heat of water may be further illustrated experimentally as follows. Let two equal vessels, one containing a pound of ice at  $32^{\circ}$ , and the other containing a pound of water at  $32^{\circ}$ , be both immersed in the same mercurial bath, maintained by lamps or otherwise at the uniform temperature of  $300^{\circ}$ , and let thermometers be placed in the ice and the water. The ice will immediately begin to melt, and the thermometer immersed in it will remain stationary. The thermometer immersed in the water will, however, at the same time begin to rise. When the

liquefaction of the ice has been completed, and the thermometer immersed in it just begins to rise, the thermometer immersed in the water will be observed to stand at  $174^{\circ}65$ . It follows therefore, supposing the ice and the water to receive the same quantity of heat from the mercury which surrounds them, that as much heat is necessary to liquefy a pound of ice as is sufficient to raise a pound of water from  $32^{\circ}$  to  $174^{\circ}65$ , which is  $142^{\circ}65$ ; a result which confirms what has been already stated.

1440. The following experiment will further illustrate this important fact.

First let a pound of ice at  $32^{\circ}$  be placed in a vessel, and let a pound of water at  $174^{\circ}65$  be poured into the same vessel. The hot water will gradually dissolve the ice, and the temperature of the mixture will rapidly fall; when the ice has been completely dissolved, the water formed by the mixture will have the temperature of  $32^{\circ}$ . Thus although the pound of warm water has lost  $142^{\circ}65$ , the pound of ice has received no increase whatever of temperature. It has merely been liquefied, but retains the same temperature as it had in the solid state.

That it is the process of liquefaction alone which prevents the heat received by the ice when melted from being sensible to the thermometer, may be proved by the following experiment.

Let a pound of water at  $32^{\circ}$  be mixed with a pound of water at  $174^{\circ}65$ , and the mixture will have the temperature of  $103^{\circ}$ , exactly intermediate between the temperatures of the compounds. But if the pound of water at  $32^{\circ}$  had been solid instead of liquid, then the mixture would have had, as already explained, the temperature of  $32^{\circ}$ . It is evident, therefore, that it is the process of liquefaction, and it alone, which renders latent or insensible all that heat which is sensible when the pound of water at  $32^{\circ}$  is liquid.

1441. *Liquefaction and congelation must always be gradual processes.* — It was formerly supposed that water at  $32^{\circ}$  would pass at once from the liquid to the solid state, on losing the least portion of heat; and that, on the other hand, a mass of ice would pass instantly from the solid to the liquid state, on receiving the least addition of heat. What has been just explained, however, shows that this sudden transition from the one state to the other cannot take place.

1442. When a mass of water losing heat gradually is reduced to  $32^{\circ}$ , small portions of ice are formed, which give out their

latent heat to the surrounding liquid, and for the moment prevent its congelation. As this liquid parts with its heat to surrounding objects, more ice is formed, which in like manner disengages its latent heat, and communicates it to a portion of the water still remaining liquid, thus tending to raise its temperature and keep it in the liquid state. The rapidity of the congelation will depend on the rate at which the uncongealed portion of the water can impart its heat to the surrounding air and other adjacent objects.

The same principles explain the gradual process of the liquefaction of ice. A small portion of ice first receives heat from some external source, and having received as much heat as would raise its own weight of water through  $142^{\circ}65$  of the thermometric scale, it becomes liquid. Then an additional portion of ice receives the same addition of heat, and is likewise rendered liquid; and so the process goes on until the whole mass of ice is liquefied.

1443. *Water may continue in the liquid state below  $32^{\circ}$ .*—It is possible, under certain circumstances, to maintain water in the liquid state below the freezing point. If a vessel of water be carefully covered up, free from agitation, and exposed to a temperature of  $22^{\circ}$ , it will gradually fall to that temperature, still remaining in the liquid state; but if it be agitated, or a particle of ice or other solid body be dropped into it, its temperature will suddenly rise to  $32^{\circ}$ , and a portion of it will be converted into ice.

1444. *Explanation of this anomaly.*—To explain this singular fact, it must be considered that the portion of the liquid which is thus suddenly solidified disengages its latent heat, which is communicated to that part of the water which still remains liquid, and raises it from  $22^{\circ}$  to  $32^{\circ}$ , and the remainder of the heat thus disengaged becomes sensible, instead of being latent in the ice itself, whose temperature it raises from  $22^{\circ}$  to  $32^{\circ}$ .

It follows, from what has been already explained, that the entire quantity of latent heat disengaged in this case would be sufficient to raise as much water as is equal in weight to the ice which has been formed through  $142^{\circ}65$ , or, what is the same, it would raise  $14\frac{1}{4}$  times this quantity of water through  $10^{\circ}$ . Now, in the present case, the whole quantity of water in the vessel, including the frozen part, has in fact been raised

10°, and it would follow, therefore, that the frozen portion should constitute one part in  $14\frac{1}{2}$  of the whole mass.

This test of the quantity of latent heat of water was applied with complete success, experimentally, by Dr. Thomson, who showed, that when water cooled without congelation to 22° was suddenly agitated, a portion was congealed, which bore the proportion to the whole quantity just mentioned, that is to say, 10 parts in 142°·65 of the entire mass. He found, likewise, that the same result was obtained when the water was cooled to any other temperature below 32° without congelation. Thus, when water cooled to the temperature of 27° without congelation was agitated, it was found that 28·5 part of the whole mass was congealed. In this case, the whole mass was raised through 5°; and since the heat developed by the frozen portion would be sufficient to raise  $28\frac{1}{2}$  times this portion through 5°, it follows that the frozen portion must be the 28·5 part of the whole mass.

1445. *Useful effects produced by the heat absorbed in liquefaction and developed in congelation.*—The great quantity of heat absorbed by ice when it melts, and given out by water when it freezes, subserves to the most important uses in the economy of nature. It is from this cause that the ocean, seas, and other large natural collections of water are most powerful agents in equalizing the temperature of the inhabited parts of the globe. In the colder regions, every ton of water converted into ice gives out and diffuses in the surrounding region as much heat as would raise a ton of liquid water from 32° to 174°·65; and, on the other hand, when a rise of temperature takes place, the thawing of the ice absorbs a like quantity of heat: thus, in the one case, supplying heat to the atmosphere when the temperature falls; and, in the other, absorbing heat from it when the temperature rises. Hence we see why the variations in climate are less on the sea-coast and on islands, than in the interior of large continents.

The temperature of the air under the line does not vary much more than 4°, and that of the water varies not more than 1°.

1446. *Heat absorbed and developed in the liquefaction and solidification of other bodies.*—The thermal phenomena explained above with reference to water belong to a general class,

and are common, with certain modifications, to all solids which are transformed into liquids by the addition, and to all liquids which are transformed into solids by the abstraction, of heat. Thus, if a mass of tin have its temperature raised by the addition of heat until it attain the temperature of  $442^{\circ}$ , it will then become stationary, notwithstanding it receive further increments of heat; but the moment it becomes stationary, its fusion will begin, and it will continue steadily at the temperature of  $442^{\circ}$  until it be completed; but the moment the last particle of tin has been melted, its temperature will begin to rise.

In the same manner, if lead be submitted to an increase of temperature, it will begin to liquefy when it reaches the temperature of  $594^{\circ}$ ; and notwithstanding the additional quantities of heat imparted to it, its temperature will not rise above  $594^{\circ}$ , until its fusion is completed. In a word, all metals whatever, and in general all solids which by elevation of temperature are fused, undergo, during the process of fusion, no elevation of temperature; the heat imparted to them during this process becoming latent in them, since it does not affect the thermometer.

1447. *Latent heat of fusion.*— This heat is called the *latent heat of fusion*, and its quantity for each body is determined by means similar to those already explained for water.

1448. *Points of fusion.*— Different solids are fused at different temperatures, but the same solid is always fused at the same temperature, which temperature is called its *point of fusion*. This point of fusion constitutes, therefore, a specific character of the solid. The quantity of heat rendered latent during the fusion of different metals is different, but always the same for the same metal. This quantity is estimated or expressed by the number of degrees which it would raise the same weight of the same body, supposing it not to undergo the change from the solid to the liquid state. In the same manner, all liquids which, by the loss of heat, are converted into solids, have a certain point, the same for each liquid, but different for different liquids, at which they pass into the solid form. This point is called their *point of solidification*, or their freezing point. It is customary to apply the latter term only to such bodies as at common temperatures are found in the liquid state.

The point at which a body in the liquid state solidifies, is the

same as that at which the same body in the solid state is liquefied; the points, therefore, of solidification or congelation are the same as the points of fusion or liquefaction for the same bodies. Thus the point of fusion for ice is the same as the freezing point for water.

Two conditions are therefore necessary to the fusion of a solid body: first, its temperature must be reduced to the point of fusion; and, secondly, it must receive a certain quantity of heat, called its heat of fusion, which will become latent in it when the fusion has been completed.

In like manner two conditions are necessary to the congelation or solidification of a liquid: first, it must be reduced to its freezing point; and, secondly, it must be deprived of a certain quantity of heat, which exists latent in it, and maintains it in the liquid state.

In the following table are given the points of fusion of the several bodies named in the first column.

*Table showing the Point of Fusion of various Substances in Degrees of Fahrenheit's Thermometer.*

Names of Substances.	Deg. of Fahr.	Authorities.
Platina - - - - -	3082 <sup>o</sup>	Clarke.
English wrought iron - - - - -	2912	Pouillet and Vauquelin.
French do - - - - -	2732	
Steel (least fusible)- - - - -	2552	
„ (most fusible) - - - - -	2372	
Cast manganese - - - - -	2282	
„ brown, fusible - - - - -	2192	
„ „ very fusible - - - - -	2012	Pouillet.
„ white, fusible - - - - -	2012	
„ „ very fusible - - - - -	1922	
Gold, very pure - - - - -	2282	
„ money - - - - -	2156	
Copper - - - - -	1922	
Braas - - - - -	1859	Daniell.
Silver, very pure - - - - -	1832	
Bronze - - - - -	1652	Pouillet.
Antimony - - - - -	810	
Zinc - - - - -	700	Murray.
	705	Guyton Morveau.
	680	Pouillet.
	608	Pouillet.
Lead - - - - -	590	Irvine.
	592	Guyton Morveau.
	509	Ermann.
	505	Pouillet.
Bismuth - - - - -	477	Irvine.
	480	Crichton.
	512	Guyton Morveau.
	446	Pouillet.
Tin - - - - -	442	Crichton.
	433	Ermann.



Names of Substances.	Deg. of Fahr.	Authorities.
Alloy 5 parts tin, 1 part lead	381	Pouillet.
" 4 " "	372	
" 3 " "	367	
" 2 " "	385	
" 1 " "	466	
" 1 " 3 parts lead	552	
Alloy 3 parts tin, 1 part bismuth	392	
" 2 " "	333·9	
" 1 " "	286·2	
" 4 " 1 part lead, 5 parts bismuth	246	
Sulphur	237	
Iodine	226	
"	225	Pouillet.
Alloy 2 parts lead, 3 parts tin, 5 parts bismuth	212	
" 5 " 3 " 8 "	212	
" 1 " 1 " 4 "	201	Gay Lussac and Thénard, Pouillet. Gay Lussac and Thénard.
Soda	194	
Potash	162	Pouillet.
"	136	
Phosphorus	109	Murray.
Stearic acid	100	
Wax, bleached	158	Pouillet.
" unbleached	154	
"	142	
"	131	
Margaric acid	to	
"	140	
"	120	
Stearine	to	
"	109	
Spermaceti	120	
Acetic acid	113	
Tallow	92	
Ice	32	
Oil of turpentine	14	
Mercury	-38·2	

1449. *Latent heat of fusion of certain bodies.* — The latent heat of fusion has not been so extensively investigated. M. Person has, however, determined it for the bodies named in the following table. The points of fusion observed by M. Person, for the specimens tried, are given. The unit of the numbers expressing the latent heat is, in this case, the quantity of heat necessary to raise the same weight of water from 32° to 33°.

Names of Substances.	Points of Fusion.	Latent Heat for Unity of Weight.	Names of Substances.	Points of Fusion.	Latent Heat for Unity of Weight.
Chloride of lime	83·3	82·42	Tin	455·0	25·74
Phosphate of soda	97·5	98·37	Bismuth	518·0	22·32
Phosphorus	111·6	8·48	Nitrate of soda	590·9	113·36
Bees-wax (yellow)	143·6	78·32	Lead	629·6	9·27
D'Arcet's alloy	204·8	10·73	Nitrate of potash	642·2	83·12
Sulphur	239·0	16·51	Zinc	793·4	49·43

1450. *Facility of liquefaction proportional to the quantity of latent heat.* — The different quantities of latent heat peculiar to different bodies, explain the different degrees of facility with

which they are liquefied. Ice liquefies very slowly, because its latent heat is considerable. Phosphorus and lead, on the other hand, whose latent heat is small, melt very rapidly. Ice cannot be liquefied until it has received as much heat as would raise its own weight of water  $142\cdot65$ ; while lead and phosphorus are liquefied by as much heat as would raise their own weight of water  $9^\circ$ . Hence it will be understood why it is that glaciers and vast depths of snow continue on mountain ridges, such as the Alps, in spite of the heat imparted to them during the hottest summers; such heat, however considerable, being only sufficient to liquefy a portion of their superficial strata, which descends the declivities, and feeds the streams and rivers of which they are the sources.

1451. *Other bodies besides water may continue liquid below the point of solidification.*—The circumstance of water continuing in the liquid state below its freezing point, when kept free from agitation, is not peculiar to that liquid. Tin fused in a crucible was cooled by Mr. Crichton  $4^\circ$  below its melting point, and yet remained liquid; and similar phenomena have been observed with other metals. In all such cases, the moment solidification commences, the liquid, as in the case of water, suddenly rises to its point of fusion; and the same causes in all cases favour solidification.

1452. *Refractory bodies.*—Bodies which are difficult of fusion are called refractory bodies. Among these, one of the most remarkable is carbon or charcoal, one form of which is the precious stone called the diamond. No degree of heat, as yet attained, has reduced this substance to the liquid state; indeed, diamond being crystallized charcoal, it is probable that if the fusion of charcoal could be effected, diamonds could be fabricated. Among the most refractory bodies are the earths, such as lime, alumina, barytes, strontia, &c. Of the metals, the most refractory are iron and platinum, but both of these are fused by the oxy-hydrogen blowpipe, as well as by the galvanic current.

1453. *Alloys liquefy more easily than their constituents.*—It is found that alloys composed of the mixture of two or more metals, in certain proportions, frequently liquefy at a much lower temperature than either of their constituents. Thus a solder composed of 4 parts of lead and 6 of tin fuses at  $336^\circ$ . An alloy composed of 8 parts of bismuth, 5 of lead, and 3 of tin, liquefies at a temperature below that of boiling water; and an

alloy composed of 496 bismuth, 310 lead, 177 tin, and 26 mercury, fuses at  $162^{\circ}5$ . If a thin strip of this alloy be dipped into water that is nearly boiling hot, it will melt like wax.

1454. *Some bodies in fusing pass through different degrees of fluidity.*—Some bodies, like water, pass from the complete solid to the complete liquid state without passing through any intermediate degrees of aggregation; while others, like wax, tallow, and butter, become soft at temperatures considerably below those at which they are liquefied; and there are others, like glass and some of the metals, which never, at any temperature, attain absolute fluidity.

1455. *Singular effects manifested by sulphur.*—Sulphur also presents some curious exceptional circumstances in its state of aggregation at different temperatures. If heat be gradually and slowly imparted to it, it will be fused, and become very fluid at  $302^{\circ}$ . If the supply of heat be continued, it will change its colour and become red and viscous and considerably less fluid. At length, heat being further supplied, and its temperature being raised from  $430^{\circ}$  to  $480^{\circ}$ , it will become altogether red, opaque, and acquire the consistency of a thick paste.

1456. *Points of congelation lowered by the solution of foreign matter.*—The freezing points of liquids are generally lowered when solids are dissolved in them. Thus, when salt is dissolved in water, the freezing point of the solution is always below  $32^{\circ}$ , and its distance below it depends on the quality and quantity of salt in solution.

1457. *Points of congelation of acid solutions.*—The strong acids generally freeze at much lower temperatures than water; and if they be mixed with water, the freezing point of the mixture will hold an intermediate position between those of water and the pure acid. The freezing points of the acids themselves vary with their strength, but not according to any known or regular law.

1458. *Sudden change of volume accompanies congelation.*—When a liquid passes into the solid state by the absorption of heat, a sudden and considerable change of dimensions is frequently observed. This change is sometimes an increase and sometimes a diminution, and in some cases no change takes place at all. When mercury is cooled to its freezing point, which is  $-39^{\circ}$ , it undergoes an instantaneous and considerable diminution of bulk as it passes into the solid state. An effect exactly the reverse takes place with water. When this

liquid cools down to  $32^{\circ}$ , it passes into the solid state, and in doing so undergoes a considerable and irresistible expansion. So great is this expansion, and so powerful is the force with which it takes place, that large rocks are frequently burst when water collected in their crevices freezes. It is a common occurrence that glass bottles containing water, left in dressing-rooms in cold weather, in the absence of fire are broken when the water contained in them freezes, the expansion in freezing not being yielded to by any corresponding dilatation in the glass. An experiment was made at Florence on a brass globe of considerable strength, which was filled with water, and closed by a screw. The water was frozen within the globe, by exposure to a cold below  $32^{\circ}$ , and in the process of freezing the water burst the globe. It was calculated that the force necessary to produce this effect amounted to about 28,000 lbs.

1459. *This expansion in the case of water not identical with that which takes place below the point of greatest density.*— This sudden expansion of water in freezing is a phenomenon distinct from the expansion already noticed, which takes place as the temperature is lowered from  $38^{\circ}\cdot 8$  to  $32^{\circ}$ . The latter expansion is gradual and regular, and accompanied by a gradual and regular decrease of temperature; but, on the other hand, the expansion which takes place when water passes from the state of liquid to the state of ice is sudden and even instantaneous, and is accompanied by no change of temperature, the solid ice having the temperature of  $32^{\circ}$ , and the liquid of which it is formed having had the same temperature just before congelation.

1460. *The quantity of expansion produced in congelation is the same for the same liquid, at whatever temperature congelation takes place.*— When water is cooled below  $32^{\circ}$  without freezing, the expansion which took place from  $38^{\circ}\cdot 8$  to  $32^{\circ}$  is continued, and the liquid continues to dilate below  $32^{\circ}$ : when it is afterwards solidified by agitation, or by throwing in a crystal of ice, a sudden and considerable expansion takes place as already described, but this expansion is always less than would take place if it solidified at  $32^{\circ}$ , by the quantity of expansion which it suffered in cooling from  $32^{\circ}$  to the temperature at which it was solidified. It is observed, that the expansion which water suffers in being solidified at  $32^{\circ}$  amounts to about one-seventh of its bulk. If it be solidified at a lower temperature, it will suffer a less expansion than this; but the expansion

which it suffers in solidification under these circumstances, added to the expansion which it suffers in cooling from  $32^{\circ}$  downwards previous to solidification, will always produce a total amount equal to the expansion which it would suffer in solidifying at  $32^{\circ}$ . Hence the total expansion which water undergoes, from the temperature of greatest density ( $38^{\circ}\cdot 8$ ) until it becomes solid, is always the same, whatever be the temperature at which it passes from the liquid to the solid state. The same observations will be likewise applicable to other liquids similarly solidified.

1461. *Phosphorus and oils in general contract in congealing.*—If a quantity of liquid phosphorus, at the temperature of  $200^{\circ}$ , be gradually cooled, it will be observed to suffer a regular contraction in its dimensions, according to the general laws observed in the cooling of bodies. When it is cooled to the temperature of about  $100^{\circ}$ , it passes into the solid state, and in doing so undergoes a sudden and considerable contraction. Oils generally undergo this sudden contraction in the process of freezing.

1462. *Some bodies expand, and some contract, in congelation.*—It may be assumed as generally true, that bodies which crystallize in freezing undergo a sudden expansion, and that bodies that do not crystallize in freezing, for the most part suffer a sudden contraction. Sulphuric acid, however, is an example of a liquid which passes from the liquid to the solid state, and *vice versâ*, without any discoverable expansion or contraction. Most of the metals contract in passing from the liquid to the solid state, the exceptions being cast iron, bismuth, and antimony, all of which undergo expansion in solidifying.

1463. *Why coin is stamped, and not cast.*—It is evident that a metal which contracts in solidifying cannot be made to take the exact shape of the mould. It is for this reason that money composed of silver, gold, or copper cannot be cast, but must be stamped. Cast iron, on the contrary, as it dilates in solidifying, takes the impression of a mould with great precision, as do also certain alloys used in the arts.

1464. *Contraction of mercury in cooling.*—The most striking instance of sudden contraction in cooling is exhibited in the case of mercury. This was first observed in the case of a thermometer, which when exposed to a temperature about  $40^{\circ}$  below zero, was observed to fall suddenly through a considerable range

of the scale, and in some cases the mercury was precipitated into the bulb. It was observed that the thermometer being exposed to a temperature lower than  $-40^{\circ}$ , the mercury gradually falls until it arrives at about  $-38^{\circ}$ , and that then a great and sudden contraction takes place at the moment the metal is solidified.

This contraction, however, must not be understood as indicating any real fall of temperature, as is the case with all the previous and regular contractions which take place before the solidification of the metal.

1465. *Substances which soften before fusion.*—Substances which soften before they melt, and which pass by degrees from the solid to the liquid state, are mostly of organic origin, and their point of fusion is below the temperature of boiling water. Some of these, which are of most general utility in the arts, are the following :

Colophany begins to melt at	$275^{\circ}$
Brown wax	110
White wax	124
Tallow	104
Pitch	91

1466. *Weldable metals.*—The metals capable of being welded soften before they are fused; and the heat at which they soften is called a *welding heat*. The metals which most readily admit of being welded, are platinum and iron. At an incipient white heat ( $2372^{\circ}$ ) they become soft; and, in this state, pieces of the metal may be intimately united when submitted to severe pressure, or when passed under the hammer.

1467. *Freezing mixtures.*—It may be taken as a physical law of high generality, that a solid cannot pass into the liquid state without absorbing and rendering latent a certain quantity of heat. This heat may be, and often is supplied from some other body in contact with that which is liquefied. But if no such external supply of heat be present, and if, nevertheless, any physical agency cause the liquefaction to take place, the body thus liquefied will actually absorb its own sensible heat. While it is liquefied, it will therefore fall in temperature to that extent which is necessary to supply its latent heat of fluidity at the expense of its sensible heat.

To render this more clear, let us imagine a pound of ice at

the temperature of  $32^{\circ}$  to be mixed with a pound of liquid having the temperature of  $-103^{\circ}$ , and let this liquid be supposed to have the property of dissolving the ice. When the liquefaction is completed, the temperature of the mixture will be  $-103^{\circ}$ . Now the liquid, which is here supposed to be the solvent, neither imparts heat to the ice nor abstracts heat from it. The ice therefore, now liquefied, contains exactly as much heat as it contained before liquefaction, and no more. But, to become liquid, it was necessary that  $142^{\circ}\cdot65$  of heat should be absorbed by it, and become latent in it. This  $142^{\circ}\cdot65$  has therefore been transferred from the sensible to the latent state in the ice itself.

This principle has been applied extensively in scientific researches and in the arts for the production of artificial cold, the compounds thus made being called *freezing mixtures*.

In all freezing mixtures, two or more substances are combined, one or more of which are solid, and which have chemical properties in virtue of which, when intimately mixed together, they enter into combination, and, in combining, liquefy. The operation is so conducted, that no heat is supplied either by the vessel in which the liquefaction takes place, or from any other external source. Such being the case, it follows that the heat absorbed in the liquefaction must be supplied by the substances themselves which compose the mixture, and which must therefore suffer a depression of temperature proportional to the quantity of heat thus rendered latent.

The cold produced will be increased by reducing the temperature of the substances composing the mixture before mixing them. Thus, let A and B be the substances mixed. Before being combined, let them be reduced to  $32^{\circ}$  by immersing them in snow. Let them then be mixed, and let the latent heat of fusion be  $32^{\circ}$ . The mixture will fall to zero, since the  $32^{\circ}$  of sensible heat will be absorbed. But if, at the moment of mixing them, their temperature had been  $64^{\circ}$ , then the temperature of the mixture would become  $32^{\circ}$ .

The substances which may be used to produce freezing mixtures on this principle are very various. •

If equal weights of snow and common salt at  $32^{\circ}$  be mixed, they will liquefy, and the temperature will fall to  $-9^{\circ}$ .

If 2 lbs. of muriate of lime and 1 lb. of snow be separately reduced to  $-9^{\circ}$  in this liquid and then mixed, they will liquefy, and the temperature will fall to  $-74^{\circ}$ .

If 4 lbs. of snow and 5 lbs. of sulphuric acid be reduced to  $-74^{\circ}$  in this last mixture, and then mixed, they will liquefy, and the temperature will fall to  $-90^{\circ}$ .

If a pound of snow be dissolved in about two quarts of alcohol at  $32^{\circ}$ , the mixture will fall nearly to  $-13^{\circ}$ . If the same quantities of snow and alcohol, being reduced in this mixture to  $-13^{\circ}$ , be then mixed, the temperature of the mixture will be reduced to  $-58^{\circ}$ ; and the same process being repeated with like quantities in this second mixture, a further reduction of temperature to  $-98^{\circ}$  may be produced; and so on.

1468. *Apparatus for producing artificial cold.*—Freezing mixtures are used for the artificial production of ice in hot climates. The most simple apparatus for this purpose is represented in *fig. 440.*, and is composed of a tin bucket B, having a slightly conical form, in the bottom of which is a circular hole, a little less in diameter than the bottom. In this hole is soldered the mouth of another tin bucket, G E F H, also conical, but with its smaller end upwards. A space W is thus left between

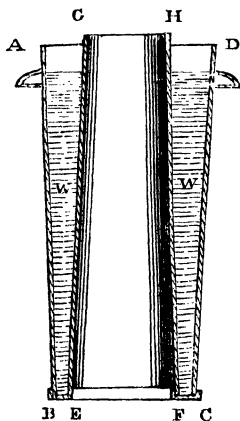

Fig. 440.

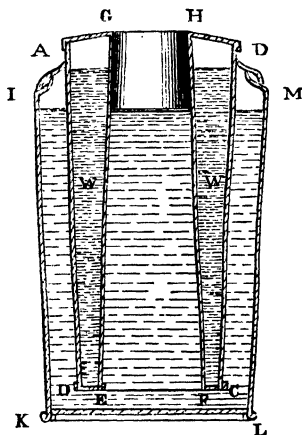

Fig. 441.

the two tin buckets, in which the water or other substance to be cooled is placed.

The freezing mixture is placed in another vessel, IKLM, *fig. 441.*, similar in form to the bucket ABCD. This vessel IKLM ought to be made of some non-conducting material.



1469. *Table of freezing mixtures.*—There are a great variety of bodies which, by combination, serve for freezing mixtures. The following table has been collected from the results of the researches of Walker and Lowitz. The substances are indicated by letters as follows:—

Water - - - - -	W	Nitrate of potash - - - - -	NP
Snow, or ice - - - - -	I	" ammonia - - - - -	NA
Sulphate of ammonia - - - - -	SA	Sulphuric acid - - - - -	SA
" soda - - - - -	SS	Nitric acid - - - - -	NA
Muriate of ammonia - - - - -	MA	Hydrochloric acid - - - - -	HA
" soda - - - - -	MS	Dilute - - - - -	d
" lime - - - - -	ML	Crystallized - - - - -	c
Carbonate of soda - - - - -	CS		

The figures prefixed indicate the proportion by weight in which the ingredients are mixed. Thus, 6SS + 4MA + 2NP + 4dNA signifies a mixture of 6 oz. of sulphate of soda, 4 oz. of muriate of ammonia, 2 oz. of nitrate of potash, and 4 oz. of dilute nitric acid.

	From	to	Cold produced.		From	to	Cold produced.
5 MA+5 NP+16 W	+50°	+10°	40°	12 I+5MS+5 NA	x	-25°	
5 MA+5 NP+8 SS+				3 I+2 dSA	+32°	-23°	55°
16 W - - - - -	+50°	+4°	46°	8 I+5 HA	+32°	-27°	59°
1 NA+1 W - - - - -	+50°	+4°	46°	7 I+4 dNA	+32°	-30°	62°
1 NA+1 CS+1 W - - - - -	+50°	-7°	57°	4 I+5 ML - - - - -	+32°	-40°	72°
3 SS+2 dNA - - - - -	+50°	-3°	53°	2 I+3 cML - - - - -	+32°	-50°	82°
6 SS+4 MA+2 NP+				3 I+4 NP - - - - -	+32°	-51°	83°
4 dNA - - - - -	+50°	-10°	60°	5 PS+3 NA+4 dNA	6°	-31°	31°
6 SS+5 NA+4 dNA	+50°	-14°	64°	3 I+2 dNA - - - - -	0°	-46°	46°
9 PS+4 dNA - - - - -	+50°	-12°	62°	8 I+3 dSA+3dNA	-10°	-56°	46°
9 PS+6 NA+4 dNA	+50°	-21°	71°	1 I+1 dSA - - - - -	-20°	-60°	46°
8 SS+5 HA - - - - -	+50°	0°	50°	3 I+4 ML - - - - -	+20°	-48°	68°
5 SS+4 dSA - - - - -	+50°	+3°	47°	2 I+3 ML - - - - -	-15°	-68°	53°
2 I+1 MS - - - - -	x	-5°		1 I+2 cML - - - - -	0°	-66°	66°
5 I+2 MS+1 MA - - - - -	x	-12°		1 I+3 cML - - - - -	-40°	-73°	33°
24 I+10 MS+5 MA+				8 I+10 dSA - - - - -	-68°	-91°	23°
5 NP - - - - -	x	-18°					

1470. *Extraordinary degrees of artificial cold produced by Thiroler and Mitchel.*—Thiroler produced a powerful freezing

mixture, by solidifying carbonic acid, and mixing it with sulphuric acid or sulphuric ether. A temperature  $120^{\circ}$  below zero, and therefore  $152^{\circ}$  below the freezing point, was thus produced.

Mitchel, repeating the experiment, produced a still more intense cold. He exposed alcohol of the specific gravity of 0.798 successively to the temperatures of  $-130^{\circ}$  and  $-146^{\circ}$ . He states that at the former temperature it had the consistency of oil, and at the latter resembled melting wax.

1471. *Alcohol probably congeals at about  $150^{\circ}$ .*—If these experiments can be relied on, it may be inferred that the freezing point of alcohol, so long and hitherto so vainly sought, is probably about  $-150^{\circ}$ , or  $182^{\circ}$  below the freezing point of water and  $110^{\circ}$  below that of mercury.

1472. *Precautions necessary in experiments with freezing mixtures.*—To ensure success in experiments on extreme cold produced by freezing mixtures, the salts used must not have lost their water of crystallization, because in that case they quickly absorb water, and converting it into ice liberate caloric and obstruct the cooling. The salts and ice used should be pulverized so as to dissolve quickly. When extreme cold is required, the vessel containing the freezing mixture should be immersed in another vessel, containing also a freezing mixture, so as to retard the mixture under experiment from receiving heat from the vessel which contains it, and a sufficient quantity of the ingredients forming the freezing mixture should be used.

1473. *Greatest natural cold yet observed.*—The greatest natural cold of which any record has been kept, was that observed by Professor Hansteen between Krasnojarsk and Nishne-Udmiks in  $55^{\circ}$  N. lat., which he states amounted to  $-55^{\circ}$  (Reaum.?) =  $-91^{\circ}.75$  F.

At Jakutsk, the mean temperature of December is  $-44\frac{1}{2}^{\circ}$  F. In 1828, from January 1 to January 10, the mean temperature of that place was  $-58^{\circ}$ .

In the expedition to China, in December 1839, the Russian army experienced for several successive days a temperature of  $-41^{\circ}.8$  F.

1474. *Principle of fluxes.—Examples of their application.*—The same principle which explains the effect of freezing mixtures, is also applicable to the phenomena attending fluxes in metallurgy. *Fluxes* are certain bodies which, when mixed with others, cause them to fuse at lower temperatures than their

proper point of fusion. It is by this means that certain metals and metallic ores are fused, when exposed to the operation of blast furnaces. In a certain sense, salt may be said to be a flux for ice; but this term flux is usually limited in its application to bodies which are only fused at very elevated temperatures: for example, in enamelling, and in the manufacture of glass and of the paste by which precious stones are imitated, siliceous sand is employed in greater or less proportion, about one-third for enamel, and nearly three-fourths for plate glass. Now silica is not fused at any heat attainable by common furnaces. M. Gaudin lately succeeded in its fusion, by means of the oxy-hydrogen blow-pipe, and drew it into threads as fine as the filaments of silk. When combined, however, with proper fluxes, it fuses readily in the furnace. The fluxes used vary according to the purposes for which the silica is applied, but they consist generally of soda, potash, and lime, with the addition of lead for flint glass, and stannic acid for enamel. The compound which results from the mixture of these ingredients, by their exposure to intense heat, is reduced to a sort of pasty fusion, but can never be said to undergo positive liquefaction. Nevertheless, the beautiful transparency of Bohemian glass, plate glass, flint glass, and the factitious diamonds, show that the constituents must be combined in a very intimate manner.

Fine earthenware and porcelain are also fabricated by means of fluxes; for although fusion is not actually produced, nor is there the same intimate combination of the constituents as takes place in vitrefaction, still there is a partial combination, and an incipient fusion. The fluxes in this case consist also of soda, potash, lime, and sometimes magnesia, the soda and potash however being used in their combined form of feldspar.

1475. *Infusible bodies*.—Infusible bodies may be resolved into two classes, those which are refractory, and which alone can be properly said to be fusible, and those whose fusion is prevented by their previous chemical decomposition or composition. Before the invention of the oxy-hydrogen blowpipe, and other scientific expedients for the production of intense heat, the number of refractory substances was much more considerable than it is at present. Scarcely any body can be said to be absolutely infusible except charcoal, which under all its forms of pure carbon, anthracite, graphite, and diamond, has resisted fusion at the highest temperature which has yet been produced.

The term refractory, however, is still applied to those classes of substances which resist fusion by ordinary furnaces.

When certain compound bodies are exposed to an intense heat, they are resolved into their constituents before they attain the point of fusion; and in other cases simple bodies enter into chemical combination with others which surround them, or are in contact with them before the fusion takes place.

The fusion, however, may in some cases of both of these classes of bodies be effected by confining them in some envelope which will resist the separation of their constituents if they be compound, or exclude them from the contact with bodies with which they might combine if they be simple.

1476. *Marble may be fused.*—If marble be exposed under ordinary circumstances to an intense heat, it will be resolved into its constituents, lime and carbonic acid; but if it be confined in a strong gun-barrel, for example, it may be fused.

1477. *Organic bodies are decomposed before fusion.*—Almost all organic solids, except the resins and the fats, are infusible before they are decomposed; we cannot melt a piece of wood, a leaf, a flower, or a fruit; but after having evaporated their liquid constituents, and dried them, the influence of heat causes their constituents to enter into combination, and produces new substances, which are generally volatile, and which have nothing in common with the original substances.

1478. *Water separated from matter held in solution by congelation.*—When water holding any body in solution has its temperature sufficiently lowered, its congelation takes place in one or other of three ways: first, the water may congeal independently of the body which it holds in solution; secondly, the body which it holds in solution may congeal, leaving the water still liquid; thirdly, the water and the body it holds in solution may congeal together.

The congelation of the water independent of the substance it holds in solution is presented in the case of the very weak solutions. In this case, the point of congelation is always below the freezing point. Thus, if water hold in solution a small quantity of alcohol, acid, alkali, or salt, it will be necessary to reduce the whole to the freezing point to produce its congelation; but when ice has been formed upon it, this ice will consist of pure water, without the mixture of any proportion of the substances which the water held in solution. Thus, sea-water

freezes at  $27\frac{1}{2}^{\circ}$ , being  $4\frac{1}{2}^{\circ}$  below the freezing point of pure water; and if the ice produced upon it be withdrawn and melted, it will produce pure water. In the same manner, if weak wine be frozen, the ice formed upon it will be the ice of pure water, and the wine which still remains liquid will be proportionally stronger. This method is sometimes practised to give increased strength to wine.

1479. *Saturated solutions partially decomposed by cooling.*—Water is generally capable of holding in solution only a certain quantity of any solid substance, and when all the substance has been dissolved in it which it is capable of taking, the solution is called a saturated solution. Now, it is found that the quantity of solid matter of any kind which water is capable of holding in solution, increases with the temperature. Thus, water at  $212^{\circ}$  will hold more of any given salt in solution, than would water at  $50^{\circ}$ . Let us suppose, then, that a saturated solution of any salt is made at  $200^{\circ}$ . If this solution be allowed to cool, a part of the salt which it contains must return to the solid state, since at lower temperatures it cannot hold in solution the same quantity; and in proportion as the temperature of the solution falls, the quantity of solid matter which will be formed in it will increase. In this case, the cooling accomplishes a partial decomposition of the solution. If the cooling be accomplished suddenly, the salt is precipitated tumultuously and in a confused mass, without form or cohesion; but if the solution is allowed to cool slowly and without agitation, the molecules of the salt collect into regular crystals.

Even after the temperature of the solution has ceased to fall, the decomposition and crystallization will continue, if the vessel containing the solution be in a position favourable to superficial evaporation. The water which evaporates from the surface taking with it none of the salt, all that portion of salt with which it was combined will receive the solid form, and will collect into crystals; and this process may be continued until, by superficial evaporation, all the water shall have disappeared, and nothing be left in the vessel except a collection of crystals of the salt.

1480. *Anomalous case of anhydrous sulphate of soda.*—The solution of anhydrous sulphate of soda presents some remarkable exceptional phenomena. At the temperature of  $91^{\circ}4$  it has a maximum of saturation, that is to say, above this point the

proportion of salt which it contains diminishes instead of increasing as the temperature is raised. However, at the boiling point, it contains much more salt than at the common temperature. If the solution be boiled in a large tube, and when it is well purged of air the tube be closed at the top, so as to exclude the atmosphere, the cooling will take place without any solidification; but when the top of the tube is broken so as to admit the air, the salt is suddenly congealed in a mass, with so great a disengagement of heat, that the tube becomes warm to the touch.

1481. *Case in which the matter held in solution congeals with the water.*—In some cases the water and the salt which it holds in solution are solidified together. This happens when the salts contain their water of crystallization. The phenomena are produced in the same manner as in the case just described, with this difference, that the molecules of salt in collecting carry with them the molecules of the water of crystallization, which pass also to the solid state, taking the place which belongs to that in the crystals. Nevertheless, the solidification of the water disengaging in general much more latent heat than the solidification of the salt, the crystals undergo a less rapid increase, whether formed by mere cooling, or by evaporation of a part of the dissolving mass.

1482. *Dutch tears.*—When bodies liquefied by heat are suddenly cooled, some remarkable and exceptional phenomena are often produced. Thus, if large drops of glass in a state of fusion be let fall into a vessel of cold water, the solidification of their superficial parts is immediate; that of their interior is much more slow. There results from this a sort of forced and unnatural arrangement of the molecules of the drop, which explain the singular phenomenon produced by Dutch Tears, so called from the form they assume, as represented in *fig. 442*.



Fig. 442.

If the extremity of the tail of one of these be broken, in an instant the entire mass cracks, and is reduced to powder. This arises from the fact that, the glass not being cooled slowly and gradually, the molecules in solidifying have not had time to assume their natural position, and, being in a forced position, on the least disturbance separate.

1483. *Use of annealing in glass manufacture and pottery.*—

To prevent this, articles manufactured of glass are submitted to the process called annealing after their fabrication,—a process in which, being again raised to a certain temperature, they are allowed to cool very slowly. Pottery in general is submitted to the same process.

1484. *Tempering steel*.—The temper of steel is a quality analogous to this. Being heated almost to the point of fusion, and being plunged in water, it becomes as brittle as glass. In this state, it is said to have the highest temper. If it is tempered only at a cherry red, it is less hard and less brittle. This is what is called the ordinary temper. In short, it may be annealed in an infinite variety of degrees over a fire of small charcoal, according to the temper which it is desired to impart to it. The oxidation which it suffers at the surface indicates by the colour which it gives to it the degree of annealing which it has received: thus it sometimes acquires a blue colour and sometimes a straw colour, the latter colour indicating a harder and less elastic quality.

## CHAP. VIII.

### VAPORIZATION AND CONDENSATION.

1485. *Evaporation of liquids in free air*.—If a liquid be exposed in an open vessel, it will be gradually converted into vapour, which mixing with the atmosphere will be dissipated, and after a certain time the liquid will disappear. This phenomenon, called evaporation, was formerly explained by the supposition that the air had a certain affinity for the liquid in virtue of which the air *dissolved* it, just as water dissolves sugar or salt.

A conclusive proof of the falsehood of this hypothesis was presented by the fact, that the vaporization of the liquid takes place in a vacuum, and that the presence of air not only does not cause more of the liquid to be evaporated than would have been evaporated in its absence, but actually retards and obstructs the evaporation.

1486. *Apparatus for observing the properties of vapour*.—

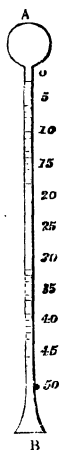

Fig. 443.

To be enabled to examine and observe with clearness and precision the mechanical properties of the vapour of any liquid, it is necessary to provide means by which such vapour can be separated from air and all other gases and vapours, since, being mixed with these, its properties would be modified, so that it would be difficult to determine what effects are due to the vapour, and what to the gases with which it is combined.

This object has been attained by apparatus, the principle of which we shall now explain.

Let A B, *fig. 443.*, be a glass bulb and tube, the bore of the tube being very small compared with the capacity of the bulb. Let the tube be widened into a sort of bell-shaped mouth at the end B, and let a graduated scale be engraved upon it, the zero being near the bulb.

Let the tube, held with the open end B upwards,

be filled with pure mercury well purged of air, as described in (714) *et seq.* Placing the finger on B to prevent the escape of the mercury or the entrance of air, let the tube be inverted, and the end B immersed in a trough of mercury, as represented in *fig. 444.* If it be immersed to such a depth that the height of the top of the bulb A above the level L L' of the mercury in the trough is less than the height of the barometric column, the mercury will not fall from the bulb, being sustained there by the atmospheric pressure.

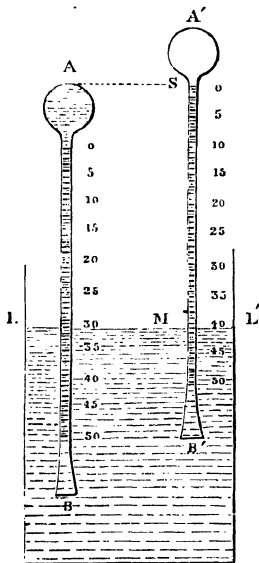

Fig. 444.

But if the bulb be raised to a greater height A above L L', the column of mercury will not rise with it, but will stand at the height of the barometric column.

Let the bulb be raised to such a height A, that the zero of the scale



engraved on the tube shall be at a height above  $L L'$  equal to the barometric column. In that case the level of the column of mercury in the tube will coincide with the zero of the scale, and the space in the bulb and tube above this level will be a vacuum. Let this space be  $s A'$ , and let  $s M$  represent the column of mercury which corresponds in height with the barometer.

Let  $C D$ , *fig. 445.*, be a small iron cylinder containing mercury, above which is a piston by which it can be pressed downwards.

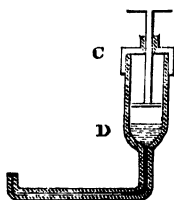

Fig. 445.

This piston is urged by a screw, so as to be capable of being moved with accuracy through any proposed space, however small. Attached to the bottom of the cylinder  $C D$  is a very fine tube  $D P$ , bent into a rectangular form so as to present its mouth upwards. This capillary tube is filled with the liquid, the vapour of which it is desired to submit to observation. By means of the screw acting on the piston,

any proposed quantity of this liquid can be expelled from the mouth  $P$  of the tube.

This instrument being immersed in the trough  $L L'$ , *fig. 444.*, and the mouth of the tube  $P$  being directed into the bell-shaped end of the tube  $B$ , a certain small quantity of the liquid is expelled by means of the screw, and issues from  $P$ . It rises by its relative levity through the mercury, and arrives at the top  $s$  of the column. There it *instantly disappears*, and at the same time the mercury falls to a lower level.

1487. *Vapour of a liquid an elastic, transparent, and invisible fluid like air.*—The cause of this will be easily understood. The minute drop of liquid which rises to the surface is converted into vapour on arriving there, and is diffused in that state throughout the entire capacity of the tube and bulb. It is transparent and invisible like air; and therefore, notwithstanding its pressure, the bulb and tube appear to be empty, as they would if they were filled with air.

1488. *How its pressure is indicated and measured.*—But this vapour being, like air, an elastic fluid, exercises a certain pressure upon the mercurial column  $s M$ , which pressure is manifested and measured by the fall of that column. The summit, which before stood at the zero of the scale, now stands

at a lower point, and the number of the scale indicating its position, expresses the pressure of the vapour in inches of mercury. Thus, if the summit *s* of the column stand at half an inch below zero, the pressure of the vapour in the bulb is such as would support a column of mercury half an inch in height.

Now let us suppose another small drop of the liquid to be injected by the apparatus *fig. 44*.<sup>5</sup> Like effects will ensue, and the summit *s* of the column will fall still lower, showing that the pressure of the vapour is augmented.

1489. *When a space is saturated with vapour.*—By repeating this process, it will be found, that when a certain quantity of the liquid has been injected, no more vapour will be produced, and the liquid will float on the summit *s* of the mercurial column without being vaporized. The summit of the column will not be further depressed.

It appears, therefore, that the space in the bulb and tube is then *saturated* with vapour. It has received all that it is capable of containing. That this is the case will be rendered manifest by elevating the tube. The summit *s* of the column still maintaining its height above *LL'*, a greater space will be obtained above *s*, and it will be accordingly found, that a portion of the liquid which previously floated on *s* will be vaporized, and if the tube be still more elevated, the whole will disappear.

Since during this process the height *s m* of the mercurial column in the tube remains unaltered, it follows that the pressure of the vapour remains the same.

By comparing the volume of the liquid ejected from *P*, *fig. 44*.<sup>5</sup>, with the volume of the tube and bulb filled by the vapour into which it is converted, the density of the vapour, or, what is the same, the column of vapour into which one unit of volume of the liquid is converted, may be ascertained.

There are, however, other circumstances connected with this process, which are not rendered apparent, and which it is important to observe and comprehend.

When the liquid rises to the surface of the mercurial column and expands into vapour, it absorbs a certain quantity of heat which becomes latent in it. This heat must be supplied by the tube, the bulb, and the mercury; and as the temperature of these does not permanently fall, this heat is replaced, and their temperature restored by the surrounding air. The

quantity of heat absorbed in the evaporation of the liquid will be presently shown. Meanwhile it must be observed, that the supply of the latent heat is essential to the evaporation of the liquid. If the mercury on which the liquid floats, and the glass by which it is inclosed, were absolute non-conductors, and could impart no heat whatever to the liquid, then the evaporation could not take place.

It appears from what has been explained, that when the space above the mercury has been charged with a certain quantity of liquid in the state of vapour, or, what is the same, when the vapour it contains has attained a certain density, all further evaporation ceases; and any liquid which may be injected will remain in the liquid state, floating on the mercury. So long as the temperature of the surrounding medium, and consequently that of the bulb and its contents, remain unaltered, and so long as any liquid remains floating on the mercury, the pressure and the density of the vapour in the bulb will be unaltered. If the bulb be raised, so as to give more space for the vapour, a proportionally increased quantity of the liquid will be vaporized; and if by depressing the tube the volume of the vapour be diminished, a corresponding part of it will return to the liquid state. In the one case, heat will be absorbed by the liquid evaporated; and in the other, heat will be developed by the vapour condensed. This heat is borrowed from the surrounding atmosphere in the one case, and imparted to it in the other; since, otherwise, the bulb and its contents must undergo a change of temperature, contrary to what was supposed.

1490. *Quantity of vapour in saturated space depends on temperature.*—But let us now consider what will be the effect of raising or lowering the temperature of the bulb and its contents. The bulb being charged with vapour, and a stratum of unevaporated liquid floating on the mercury, let the temperature of the medium surrounding the bulb be raised through any proposed number of degrees of the thermometric scale. This will be immediately followed by the evaporation of a part of the liquid floating on the mercury, and a depression of the column. An increased volume of vapour is therefore now contained in the bulb and tube; but if this increase of volume be compared with the increased quantity of liquid evaporated, it will be found to be less in proportion; and it consequently follows, that the density of

the vapour is augmented ; and since the column of mercury has been more depressed, and since this depression measures the pressure of the vapour, it follows that this pressure has been also augmented.

1491. *Relation between pressure, temperature, and density.*— Thus it appears that the pressure and density of the vapour produced from the liquid floating on the mercury are augmented as the temperature of the liquid is augmented, and consequently diminished as that temperature is diminished.

In short, a certain relation subsists between the temperature, pressure, and density, such that when any one of these are known, the other two can always be found. If this general relation were known, and could be expressed by an arithmetical formula, the pressure and density of the vapour corresponding to any proposed temperature, or the temperature corresponding to any proposed density or pressure, could always be ascertained by calculation. But the theory of heat has not supplied the means of determining this relation by any general principles ; and, consequently, the pressures and densities of the vapour of liquids at various temperatures have been determined only by experiment and observation.

1492. *Pressure, temperature, and density of the vapour of water.*— Different liquids at the same temperature produce vapours having different densities and pressures. But of all liquids, that of which the vaporization is of the greatest physical importance, and consequently that which has been the subject of the most extensive system of observations, is water.

If water be introduced above the mercurial column in the apparatus above described, and be exposed successively to various temperatures, the pressures and densities of the vapour it produces can be observed and ascertained.

It is thus found that, in all cases, water passing into the vaporous state undergoes an enormous enlargement of volume, and that this enlargement increases as the temperature at which the evaporation takes place is diminished. Thus, if the temperature be  $212^{\circ}$ , a cubic inch of water swells into 1696 cubic inches ; and if the temperature be  $77^{\circ}$ , it swells into 23090 cubic inches of vapour.

1493. *Vapour produced from water at all temperatures, however low.*— There is no temperature, however low, at which

water will not evaporate. If the bulb and tube be exposed to the temperature of  $32^{\circ}$ , the mercurial column in the tube will be lower than the barometric column by two-tenths of an inch, a small, but still observable quantity; and even if the temperature be reduced still lower, so that the liquid floating on the mercury shall become solid ice, there will still be a vapour in the bulb, of appreciable pressure and density. Thus, a piece of ice at the temperature of  $-4^{\circ}$ , (that is,  $36^{\circ}$  below the freezing point) produces a vapour whose pressure is represented by a column of mercury of a twentieth of an inch.

The relation between the temperature, pressure, and density of the vapour of water, from the lowest temperatures and pressures to temperatures corresponding to a pressure twenty-four times greater than that of the atmosphere, has been ascertained by direct observation; and by the comparison of these observations, an empirical formula has been found, which expresses the general relation of the temperature and pressure with such precision, within the range of the temperatures and pressures observed, that it may be applied without risk of any important error to the computation of the pressures, temperatures, and densities, through a certain range of the scale, beyond the limits to which observation and experiment have extended. In this way, the temperatures and densities of the vapour, corresponding to all pressures up to fifty times the pressure of the atmosphere, have been computed and tabulated.

1494. *Mechanical force developed in evaporation.*—When a liquid expands into vapour, it exerts a certain mechanical force, the amount of which depends on the pressure of the vapour, and the increased volume which the liquid undergoes in evaporation. Thus, if a cubic inch of a liquid swells by evaporation into 2000 cubic inches of vapour having a pressure of 10 lbs. per square inch, it is easy to show that a mechanical force is developed in such evaporation which is equivalent to 20,000 lbs. raised through one inch. For, if we imagine a cubic inch of the liquid confined in a tube, the bore of which measures a square inch, it will, when evaporated, fill 2000 inches of such tube, and in swelling into that volume will exert a pressure of 10 lbs., so that it would in fact raise a weight of 10 lbs. through that height. Now 10 lbs. raised through the height of 2000 inches, is equivalent to 20,000 lbs. raised through the height of one inch.

Since, however, it is customary to express the mechanical effect by the number of pounds raised through one foot, the mechanical effect produced in the evaporation of each cubic inch of a liquid will be found by multiplying the number which expresses the volume of vapour produced by the unit of volume of the liquid by the number expressing the pressure of the vapour in pounds per square inch, and dividing the product by 12.

In the following tables, the relation between the temperature, pressure, density, volume, and mechanical effect of the vapour of water are given as determined by observation so far as the pressure of twenty-four atmospheres, and by analogy from that to the pressure of fifty atmospheres.

TABLE I.

*Showing the Pressure, Volume, and Density of the Vapour of Water produced at the Temperatures expressed in the first Column, as well as the mechanical Effect developed in the Process of Evaporation.*

Temperature, Fahrenheit.	Pressure.		Volume of Vapour contain- ing Unit of Volume of Water.	Density of Vapour (Density of Water = 1).	Mechanical Effect in Lbs. raised 1 Foot.
	Inches of Mercury.	Lbs. per Square Inch.			
— 4°	0·052	0 03	650588	0·00000154	1395
5	0·074	0·04	470898	212	1423
14	0·104	0·05	342984	292	1451
23	0·144	0·07	251358	398	1480
32	0·199	0·10	182323	540	1483
33·8	0·212	0·10	174495	573	1514
35·6	0·226	0·11	164332	609	1519
37·4	0·241	0 12	154842	646	1525
39·2	0·257	0·13	145886	686	1531
41	0·274	0·13	137488	727	1536
42·8	0·291	0·14	129587	772	1542
44·6	0·310	0·15	122211	818	1549
46·4	0·330	0·16	115305	867	1555
48·2	0·351	0·17	108790	919	1559
50	0·373	0·18	102670	974	1565
51·8	0·397	0·19	969202	0·0·001032	1607
53·6	0·422	0·21	91564	1097	1577
55·4	0·448	0·22	86426	1157	1582
57·2	0·476	0·23	81686	1224	1588
59	0·505	0 25	77108	1290	1590
60·8	0 537	0·26	72913	1372	1598
62·6	0·570	0·28	68923	1451	1604
64·4	0·6 4	0·30	65201	1534	1610
66 2	0·641	0·31	61654	1622	1615
68	0·682	0·33	58224	1718	1621
69·8	0·721	0·35	55206	1811	1626
71·6	0·764	0·37	52260	1914	1632
73·4	0·810	0·40	49487	2021	1638
75·2	0·858	0·42	46777	2133	1644
77	0·909	0·45	44411	2252	1649
78·8	0·963	0·47	42084	2376	1655
80·6	1·019	0·50	39895	2507	1661
82·4	1·078	0·53	37838	2643	1667
84·2	1·143	0·56	35796	2794	1672

Temperature, Fahrenheit.	Pressure.		Volume of Vapour contain- ing Unit of Volume of Water.	Density of Vapour (Density of Water = 1).	Mechanical Effect in Lbs. raised 1 Foot.
	Inches of Mercury.	Lbs. per Square Inch.			
86°	1·206	0·59	34011	0·0002938	1678
87·8	1·276	0·63	32291	0·0003097	1684
89·6	1·349	0·66	30650	0·0003263	1689
91·4	1·425	0·70	29112	0·0003435	1694
93·2	1·506	0·74	27636	0·0003619	1700
95	1·591	0·77	26253	0·0003809	1706
96·8	1·683	0·82	24897	0·0004017	1712
98·6	1·773	0·87	23704	0·0004219	1717
100·4	1·873	0·92	22513	0·0004442	1722
102·2	1·974	0·97	21429	0·0004666	1728
104	2·087	1·02	20343	0·0004916	1734
105·8	2·196	1·08	19396	0·0005156	1740
107·6	2·315	1·13	18469	0·0005418	1746
109·4	2·439	1·20	17572	0·0005691	1751
111·2	2·584	1·27	16805	0·0006023	1774
113	2·707	1·33	15938	0·0006274	17·2
114·8	2·850	1·40	15185	0·0006585	1768
116·6	3·000	1·47	14472	0·0006910	1774
118·4	3·158	1·55	13809	0·0007242	1781
120·2	3·322	1·63	13154	0·0007602	1785
122	3·494	1·71	12546	0·0007970	1791
123·8	3·673	1·80	11971	0·0008354	1796
125·6	3·861	1·89	11424	0·0008753	1802
127·4	4·058	1·99	10901	0·0009174	1807
129·2	4·263	2·09	10410	0·0009606	1813
131	4·477	2·19	9946	0·0010054	1819
132·8	4·700	2·30	9501	0·0010525	1824
134·6	4·934	2·42	9082	0·0011011	1830
136·4	5·177	2·54	8680	0·0011523	1836
138·2	5·431	2·66	8303	0·0012044	1842
140	5·695	2·79	7937	0·0012599	1847
141·8	5·973	2·93	7594	0·0013179	1853
143·6	6·258	3·07	7267	0·0013760	18·8
145·4	6·558	3·21	6957	0·0014374	1864
147·2	6·869	3·37	6662	0·0015010	1869
149	7·193	3·53	6382	0·0015668	1875
150·8	7·530	3·69	6114	0·0016356	1881
152·6	7·881	3·86	5860	0·0017060	1887
154·4	8·246	4·04	5619	0·0017797	1893
156·2	8·624	4·23	5386	0·0018566	1898
158	9·019	4·42	5167	0·0019355	1904
159·8	9·427	4·62	4957	0·0020174	1909
161·6	9·852	4·83	4759	0·0021013	1915
163·4	10·293	5·05	4569	0·0021889	1921
165·2	10·749	5·27	4387	0·0022794	1926
167	11·223	5·50	4204	0·0023789	1928
168·8	11·715	5·74	4048	0·0024702	1937
170·6	12·224	5·99	3891	0·0025699	1943
172·4	12·752	6·25	3741	0·0026739	1949
174·2	13·298	6·52	3599	0·0027789	1955
176	13·862	6·80	3462	0·0028889	1963
177·8	14·449	7·08	3331	0·0030025	1966
179·6	15·055	7·38	3206	0·0031195	1972
181·4	15·680	7·69	3087	0·0032399	1977
183·2	16·328	8·00	2973	0·0033637	1983
185	16·996	8·33	2864	0·0034916	1989
186·8	17·688	8·67	2760	0·0036237	1994
188·6	18·401	9·02	2660	0·0037590	2000
190·4	19·138	9·38	2565	0·0038984	2 05
192·2	19·897	9·75	2474	0·0040417	2 11
194	20·680	10·14	2387	0·0041891	20·7
195·8	21·488	10·53	2304	0·0043405	2023
197·6	22·321	10·94	2224	0·0044956	2028
199·4	23·179	11·36	2148	0·0046556	2034
201·2	24·062	11·80	2075	0·0048201	2040
203	24·971	12·24	2005	0·0049886	2045
204·8	25·908	12·70	1938	0·0051613	2051
206·6	26·874	13·17	1873	0·0053388	2056
208·4	27·860	13·66	1812	0·0055191	2062
210·2	28·877	14·16	1751	0·0057055	2066
212	29·921	14·67	1696	0·0058955	2073

TABLE II.

Showing the Temperature, Volume, and Density of Vapour of Water, corresponding to Pressures of from 1 to 50 Atmospheres.

From 1 to 24 Atmospheres obtained by Observation.

„ 24 to 50

„

„

Analogy.

Pressure, Atmospheres.	Temperature, Fahrenheit.	Volume of Vapour produced by Unit of Volume of Water.	Density of Vapour (Density of Water = 1).	Pressure, Atmospheres.	Temperature, Fahrenheit.	Volume of Vapour produced by Unit of Volume of Water.	Density of Vapour (Density of Water = 1).
1	212	1696	0.0005895	13	380.66	163.74	0.006107
1½	233.96	1167.8	8563	14	386.96	153.10	6527
2	250.52	897.09	0.001147	15	392.90	144.00	6944
2½	263.84	731.39	13673	16	398.48	135.90	7359
3	275.18	619.19	16150	17	403.88	128.71	7769
3½	285.08	537.96	18589	18	408.92	122.28	8178
4	293.72	476.26	20997	19	413.78	116.51	8583
4½	300.38	427.18	23410	20	418.46	111.28	8986
5	307.58	388.16	25763	21	422.96	106.53	9387
5½	314.24	355.99	28091	22	427.28	102.19	9785
6	320.36	328.93	30402	23	431.42	98.21	0.010182
6½	326.30	305.98	32683	24	435.56	94.56	10575
7	331.70	286.12	34911	25	439.34	91.17	10668
7½	336.92	268.82	37217	30	457.16	77.50	12908
8	341.78	253.59	39434	35	472.64	68.20	14663
9	350.78	227.98	43865	40	486.50	60.8	16644
10	358.88	207.36	48226	45	499.10	54.06	18497
11	366.80	190.27	52557	50	510.62	49.31	20306
12	374.00	175.96	56834				

1495. *Vapour separated from a liquid may be dilated by heat like any gaseous body.* — In these tables the vapour is considered as being in the state of the greatest density which is compatible with its temperature. It must be remembered that vapour separated from the liquid may, by receiving heat from any external source, be raised like so much air, or other gaseous fluid, to any temperature whatever, and that the elevation of its temperature under such circumstances is attended with the same effects as atmospheric air. If it be so confined as to be incapable of expansion, its pressure will be augmented a  $\frac{1}{490}$ th part by each degree of temperature it receives; and if it be capable of expanding under an uniform pressure, then its volume will be augmented in the same ratio.

1496. *Peculiar properties of superheated vapour.* — Vapour which receives a supply of heat after it has been separated from the liquid, and which may therefore be denominated *superheated vapour*, has some important properties which distinguish it from the vapour which proceeds directly from the liquid.

The vapour which proceeds directly from a liquid by the



process of evaporation, contains no more heat than is essential to its maintenance in the vaporous form. If it lose any portion of this heat, a part of it will become liquid; and the more it loses, the more will return to the liquid state, until, being deprived of all the heat which it had received in the process of evaporation, the whole of the vapour will become liquid.

But, in the case of superheated vapour, the effects are different. Such vapour may lose a part of its heat and still continue to be vapour. In fact, no part of it can be reduced to the liquid state until it lose all the heat which had been imparted to it after evaporation.

1497. *Vapour cannot be reduced to the liquid state by mere compression.* — It is sometimes affirmed that vapour may, by mere mechanical compression, be reduced to the liquid state. This is an error. It is true neither in relation to vapour raised directly from liquids, nor of superheated vapour.

1498. *Vapour which has the greatest density due to its temperature under any given pressure, will have the greatest density at all other pressures, provided it do not gain or lose heat while the pressure is changed.* — If vapour raised directly from a liquid, at any proposed pressure, be, after separation from the liquid, either compressed into a diminished volume or allowed to expand into an increased volume, its temperature will be raised in the one case and lowered in the other; and, at the same time, its pressure will be augmented by the diminution and diminished by the augmentation of volume. It will be found, however, that the temperature, pressure, and volume will in every case be exactly those which the vapour would have had if it had been directly raised from the liquid at that temperature and pressure.

Thus, the vapour raised from water at the temperature of  $68^{\circ}$  has a volume 58224 times greater than the water that produced it (see Table I. p. 93.). Now let this vapour, being separated from the water, be compressed until it be reduced to a volume which is only 1696 times that of the water which produced it, and its temperature will rise to  $212^{\circ}$ , exactly that which it would have had if it had been directly raised from the water under the increased pressure to which it has been subjected.

In the same manner, whatever other pressure the vapour may be submitted to, it will still, after compression, continue to be vapour, and will be identical in temperature and volume

with the vapour which would be raised from the same liquid directly if evaporated under the increased pressure.

1499. *Compression facilitates the abstraction of heat by raising the temperature, and thus facilitates condensation.* — Although mere compression cannot reduce any part of a volume of vapour to the liquid state, it will facilitate such a change by raising the temperature of the vapour without augmenting the quantity of heat it contains, and thereby rendering it possible to abstract heat from it. Thus, for example, if a volume of vapour at the temperature of  $32^{\circ}$  be given, it may be difficult to convert any portion of it into a liquid, because heat cannot be easily abstracted from that which has already a temperature so low. But if this vapour, by compression, and without receiving any accession of heat, be raised to the temperature of  $212^{\circ}$ , it can easily be deprived of a part of its heat by placing it in contact with any conducting body at a lower temperature; and the moment it loses any part of its heat, however small, a portion of it will be reduced to the liquid state.

1500. *Permanent gases are superheated vapours.* — It may be considered as certain, that all that class of bodies which are denominated permanent gases are the superheated vapours of bodies which, under other thermal conditions, would be found in the liquid or solid state. It is easy to conceive a thermal condition of the globe, which would render it impossible that water should exist save in the state of vapour. This would be the case, for example, if the temperature of the atmosphere were  $212^{\circ}$  with its present pressure. A lower temperature, with the same pressure, would convert alcohol and ether into permanent gases.

1501. *Processes by which gases have been liquefied and solidified.* — The numerous experiments by which many of the gases hitherto regarded as permanent have been condensed and reduced to the liquid, and, in some cases, to the solid state, have further confirmed the inferences based on these physical analogies. The principle on which such experiments have in general been founded is, that if, by any means, the heat which a superheated vapour has received after having assumed the form of vapour can be taken from it, the condensation of a part of it must necessarily attend any further loss of heat, since, by what has been explained, it will be apparent that no heat will

remain in it except what is essential to its maintenance in the vaporous state.

The gas which it is desired to condense is first submitted to severe compression, by which its temperature is raised either by diminishing its specific heat or by developing heat that was previously latent in it. The compressed gas is at the same time surrounded by some medium of the most extreme cold; so that, as fast as heat is developed by compression, it is absorbed by the surrounding medium.

When, by such means, all the heat by which the gas has been surcharged has been abstracted, and when no heat remains save what is essential to the maintenance of the elastic state, the gas is in a thermal condition analogous to that of vapour which has been directly raised by heat from a liquid, and which has not received any further supply of heat from any other source. It follows, therefore, that any further abstraction of heat must cause the condensation of a corresponding portion of the gas.

1502. *Gases which have been liquefied.*—The following gases, being kept at the constant temperature of  $32^{\circ}$  by depriving them of heat as fast as their temperature was raised by compression, have been reduced to the liquid state. The pressures necessary to accomplish this are here indicated:—

Names of Gases condensed.	Pressure under which Condensation took place.
	Atmospheres.
Sulphurous acid - - - - -	1.5
Cyanogen gas - - - - -	2.3
Hydriodic acid - - - - -	4.0
Ammoniacal gas - - - - -	4.4
Hydrochloric acid - - - - -	8.0
Protoxide of azote - - - - -	37.0
Carbonic acid - - - - -	39.0

If these substances be regarded as liquids, the above pressures would be those under which they would vaporize at  $32^{\circ}$ . If they be regarded as vapours, they are the pressures under which they would be condensed at  $32^{\circ}$ .

M. Pouillet succeeded in condensing some of these gases at the following higher temperatures and greater pressures:—

Gas.	Temperature, Fahrenheit.	Pressure, Atmospheres.
Sulphurous acid - - - - -	$46^{\circ}4$	2.5
Ammoniacal gas - - - - -	50	5
Protoxide of azote - - - - -	$51.8$	43
Carbonic acid - - - - -	50	45

Hydrochloric acid has been reduced to a liquid at  $50^{\circ}$  under a pressure of 40 atmospheres.

1503. *Under extreme pressures, gases depart from the common law of the density being proportional to the pressure.* — In these experimental researches, it has been found that when the gases are submitted to extreme compression, and deprived of a large portion of the surcharged heat, they begin to depart from the general law in virtue of which the density of gaseous bodies at the same temperature is proportional to the compressing force, and they are found to acquire a density greater than that which they would have under this general law. This would appear, therefore, as a departure from the law, preliminary to the final change from the gaseous to the liquid state; and in this point of view, analogies have been observed which render it probable that the point of condensation of several of the gases not yet liquefied has been very nearly approached.

Thus, it has been found that the density of several of them, among which may be mentioned light carburetted hydrogen and olefiant gas (heavy carburetted hydrogen), has been sensibly greater than that due to the compressing force under extreme degrees of compression.

1504. *State of ebullition, boiling point.* — If heat be continually imparted to a liquid, its temperature will be augmented, but will only rise to a certain point on the thermometric scale. At that point it will remain stationary, until the whole of the liquid shall be converted into vapour. During this process, vapour will be formed in greater or less quantity throughout the entire volume of the liquid, but more abundantly at those parts to which the heat is applied. Thus if, as usually happens, the heat be applied at the bottom of the vessel containing the liquid, the vapour will be formed there in large bubbles, and will rise to the surface, producing that agitation of the liquid which has been called *boiling* or *ebullition*.

This limiting temperature is called the *boiling point* of the liquid.

Different liquids boil at different temperatures. The *boiling point* of a liquid is therefore one of its specific characters.

1505. *Boiling point varies with the pressure.* — Liquids in general being boiled in open vessels, are subject to the pressure of the atmosphere. If this pressure vary, as it does at dif-

ferent times and places, or if it be increased or diminished by artificial means, the boiling point will undergo a corresponding change. It will rise on the thermometric scale as the pressure to which the liquid is subject is increased, and will fall as that pressure is diminished.

The boiling point of water is  $212^{\circ}$ , when subject to a pressure expressed by a column of 30 inches of mercury. It is  $185^{\circ}$ , when subject to a pressure expressed by 17 inches of mercury.

In general, the temperatures at which water would boil under the pressures expressed in the second column of the table (1494) are expressed in the first column.

1506. *Experimental verification of this principle.* — Let water at the temperature of  $200^{\circ}$ , for example, be placed in a glass vessel, under the receiver of an air-pump, and let the air be gradually withdrawn. After a few strokes of the pump the water will boil; and if the gauge of the pump be observed, it will be found that its altitude will be about  $23\frac{1}{2}$  inches. Thus, the pressure to which the water is submitted has been reduced from the ordinary pressure of the atmosphere to a diminished pressure expressed by  $23\frac{1}{2}$  inches, and we find that the temperature at which the water boils has been lowered from  $212^{\circ}$  to  $200^{\circ}$ . Let the same experiment be repeated with water at the temperature of  $180^{\circ}$ , and it will be found that a further rarefaction of the air is necessary, but the water will at length boil. If the gauge of the pump be now observed, it will be found to stand at 15 inches, showing that at the temperature of  $180^{\circ}$  water will boil under half the ordinary pressure of the atmosphere. This experiment may be varied and repeated, and it will always be found that water will boil at that temperature which corresponds to the pressure given in the table.

1507. *At elevated stations water boils at low temperatures.* — It is well known, that as we ascend in the atmosphere, the pressure is diminished in consequence of the quantity of air we leave below us, and that, consequently, the barometer falls. It follows, therefore, that at stations at different heights in the atmosphere, water will boil at different temperatures; and that the boiling point at any given place must therefore depend on the elevation of that place above the surface of the sea. Hence the boiling point of water becomes an indication of the height of the station, or, in other words, an indication of the atmospheric

pressure, and thus the thermometer serves in some degree the purposes of a barometer.

1508. *Table of the boiling points of water at various places.*—In the following table the various temperatures are shown at which water boils in the different places therein indicated.

*Table of the boiling Points of Water at different Elevations above the Level of the Sea.*

Names of Places.	Above Level of Sea.	Mean Height of Barometer.	Thermometer.
	Feet.	Inches.	Degrees.
Farm of Antisana - - - - -	13455	17 87	187 4
Town of Micuipampa (Peru) - - - - -	11870	19 02	190 2
Quito - - - - -	9541	20 75	194 2
Town of Caxamarca (Peru) - - - - -	9384	20 91	194 5
Santa Fè de Bogota - - - - -	8731	21 42	195 6
Cuença (Quito) - - - - -	8639	21 50	195 8
Mexico - - - - -	7471	22 52	198 1
Hospice of St. Gothard - - - - -	6808	23 07	199 2
St. Veron (Maritime Alps) - - - - -	6693	23 15	199 4
Breuil (Valley of Mont Cervin) - - - - -	6585	23 27	199 6
Maurin (Lower Alps) - - - - -	6240	23 58	200 3
St. Rémi - - - - -	5265	24 45	202 1
Heas (Pyrenees) - - - - -	481 7	24 88	202 8
Gavanne (Pyrenees) - - - - -	4738	24 96	203 0
Briançon - - - - -	4285	25 39	203 9
Barège (Pyrenees) - - - - -	4164	25 51	204 1
Palace of San Ildefonso (Spain) - - - - -	3790	25 87	204 8
Baths of Mont d'Or (Auvergne) - - - - -	3412	26 26	205 7
Pontarlier - - - - -	2717	26 97	206 8
Madrid - - - - -	1995	27 72	208 0
Innspruck - - - - -	1857	27 87	208 4
Munich - - - - -	1765	27 95	208 6
Lausanne - - - - -	1663	28 08	208 9
Augsburg - - - - -	1558	28 19	209 1
Salzburg - - - - -	1483	28 27	209 1
Neuchâtel - - - - -	1437	28 31	209 3
Plombières - - - - -	1381	28 39	209 3
Clermont-Ferrand (Préfecture) - - - - -	1348	28 43	209 3
Geneva and Friburg - - - - -	1221	28 54	209 5
Ulm - - - - -	1211	28 58	209 7
Ratisbon - - - - -	1188	28 58	209 7
Moscow - - - - -	984	28 82	210 2
Gotha - - - - -	935	28 86	210 2
Turin - - - - -	755	29 06	210 4
Dijon - - - - -	712	29 14	210 6
Prague - - - - -	587	29 25	210 7
Mâcon (Saône) - - - - -	551	29 29	210 9
Lyons (Rhône) - - - - -	532	29 33	210 9
Cassel - - - - -	518	29 33	210 9
Göttingen - - - - -	440	29 41	211 1
Vienna (Danube) - - - - -	436	29 41	211 1
Milan (Botanic Garden) - - - - -	420	29 45	211 1
Bologna - - - - -	397	29 49	211 1
Parma - - - - -	305	29 57	211 3
Dresden - - - - -	295	29 61	211 3
Paris (Royal Observatory, first floor) - - - - -	213	29 69	211 5
Rome (Capitol) - - - - -	151	29 76	211 6
Berlin - - - - -	131	29 76	211 6

1509. *Latent heat of vapour.*—When a liquid is converted into vapour, a certain quantity of heat is absorbed and rendered latent in the vapour.

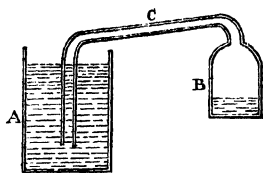

Fig. 446.

The vapour which proceeds from the liquid has the same temperature as the liquid. It can be shown, however, experimentally, that, weight for weight, it contains much more heat. To render this manifest, let B, *fig.* 446., be a vessel containing water, which is kept in the state of ebullition and at the temperature of  $212^{\circ}$

by means of a lamp, or any other source of heat. Let the steam be conducted by a pipe C to a vessel A, which contains a quantity of water at the temperature of  $32^{\circ}$ . The steam issuing from the pipe is condensed by the cold water, and mixing with it, gradually raises its temperature until it attains the temperature of  $212^{\circ}$ , after which the steam ceases to be condensed, and escapes in bubbles at the surface, as common air would if driven into the water from the pipe.

If the quantity of water in A be weighed before and after this process, its weight will be found to be increased in the ratio of 11 to 13. Thus 11 lbs. of water at  $32^{\circ}$ , mixed with 2 lbs. of water in the form of steam at  $212^{\circ}$ , have produced 13 lbs. of water at  $212^{\circ}$ , so that the 2 lbs. of water which were introduced in the form of steam at  $212^{\circ}$  have been changed from the vaporous to the liquid state, retaining however their temperature of  $212^{\circ}$ , and have given to 11 lbs. of water which were previously in A at  $32^{\circ}$  as much heat as has been sufficient to raise that quantity to  $212^{\circ}$ .

It follows, therefore, that any given weight of water in the form of steam at  $212^{\circ}$  contains as much heat latent in it as is sufficient to raise  $5\frac{1}{2}$  times its own weight of water from  $32^{\circ}$  to  $212^{\circ}$ , that is, through  $180^{\circ}$  of the thermometric scale.

If it be assumed that to raise a pound of water through  $180^{\circ}$  requires 180 times as much heat as to raise it one degree, it will follow that the quantity of latent heat contained in a pound of water in the form of steam at  $212^{\circ}$  is  $5\frac{1}{2} \times 180 = 990$  times as much as would raise a pound of water through one degree.

This fact is usually expressed by stating that steam at  $212^{\circ}$  contains  $990^{\circ}$  degrees of latent heat.

The same important fact can also be made manifest in the following manner. Let a lamp, or any source of heat which acts

in a regular and uniform manner, be applied to a vessel containing any given quantity of water which is at 32° when the process commences, and let the time be observed which the lamp takes to raise the water to 212°. Let the lamp continue to act in the same uniform manner until all the water has been converted into steam, and it will be found that the time necessary for such complete evaporation will be exactly 5½ times that which was necessary to raise the water from the freezing to the boiling point. In a word, it will require 5½ times as long an interval to convert any given quantity of water into steam as it will take to raise the same quantity of water, by the same source of heat, from the freezing to the boiling point; and consequently it follows, that 5½ times as much heat is absorbed in the evaporation of water, as is necessary to raise it without evaporation through 180° of temperature.

1510. *Different estimates of the latent heat of the vapour of water.*—Different experimental inquirers have estimated the heat rendered latent by water in the process of evaporation at 212° as follows:—

Watt	-	-	-	-	-	- 950°
Southern	-	-	-	-	-	- 945°
Lavoisier	-	-	-	-	-	- 1000°
Rumford	-	-	-	-	-	- 1004°·8
Desprez	-	-	-	-	-	- 955°·8
Regnault	-	-	-	-	-	- 967°·5
Fabre and Silbermann	-	-	-	-	-	- 964°·8

In round numbers, it may therefore be stated that as much heat is absorbed in converting a given quantity of water at 212° into steam as would be sufficient to raise the same quantity of water to the temperature of 1200° when not vaporized.

1511. *Heat absorbed in evaporation at different temperatures.*—It was observed at an early epoch in the progress of discovery, that the heat absorbed in vaporization was less as the temperature of the vaporizing liquid was higher. Thus a given weight of water vaporized at 212°, absorbs less heat than would the same quantity vaporized at 180°. It was generally assumed that the increase of latent heat, for lower as compared with higher temperatures, was equal to the difference of the sensible heats, and consequently, that the latent heat added to the sensible



heat, for the same liquid, must always produce the same sum. Thus, if water at  $212^{\circ}$  absorb in vaporization  $950^{\circ}$  of heat, water at  $262^{\circ}$  would only absorb  $900^{\circ}$ , and water at  $162^{\circ}$  would absorb  $1000^{\circ}$ .

The simplicity of this result rendered it attractive, and, as the general result of experiments appeared to be in accordance with it, it was generally adopted. M. Regnault has, however, lately submitted the question, not only of the latent heat of steam, but also its pressure, temperature, and density, to a rigorous experimental investigation, and has obtained results entitled to more confidence, and which show that the sum of the latent and sensible heats is not rigorously constant.

1512. *Latent heat of vapour of water ascertained by Regnault.* — The pressures and densities obtained by M. Regnault are in accordance with those given in (1494). The latent heats are given in the following table, where I have given their sums, and shown what does not seem to have been hitherto noticed, that they increase by a constant difference.

Temp.	Latent Heat.	Sum of Latent Heat and Sensible Heat.	Temp.	Latent Heat.	Sum of Latent Heat and Sensible Heat.
$32^{\circ}$	1092.6	1124.6	218	939.6	1187.6
50	1080.0	1130.0	266	927.0	1193.0
68	1067.4	1135.4	284	914.4	1198.4
86	1054.8	1140.8	302	901.8	1203.8
104	1042.2	1146.2	320	889.2	1209.2
122	1029.6	1151.6	338	874.8	1212.8
140	1017.0	1157.0	356	862.2	1218.2
158	1004.4	1162.4	374	849.6	1223.6
176	991.8	1167.8	392	835.2	1227.2
194	979.2	1173.2	410	822.6	1232.6
212	966.6	1178.6	428	808.2	1236.2
230	952.2	1182.2	446	793.8	1239.8

It appears, therefore, that the sum of the latent and sensible heats is not constant, but increases by a constant difference,—a difference however which, compared with the sum itself, is very small, and for limited ranges of the thermometric scale, when extreme accuracy is not required, may be disregarded.

1513. *Latent heat of other vapours ascertained by Fabre and Silbermann.*—The latent heat of the vapours of other liquids have been ascertained by MM. Fabre and Silbermann, and are given, as well as the specific heats, in the following table:—

Names of Substances.	Temperature.	Specific Heat.	Latent Heat.
	°		
Water - - - - -	212	1	964·8
Carburetted hydrogen - - - - -	392	0·49	108
Ditto - - - - -	482	0·50	108
Pyroligneous acid - - - - -	151·7	0·67	475·2
Alcohol, absolute - - - - -	172·4	0·64	374·4
" Valerianic - - - - -	172·4	0·59	217·8
" ethalic - - - - -	172·4	0·51	104·4
Ether, sulphuric - - - - -	100·4	0·50	163·8
" Valerianic - - - - -	236·3	0·52	124·2
Acid, formic - - - - -	212	0·65	304·2
" acetic - - - - -	248	0·51	183·6
" butyric - - - - -	327·2	0·41	207
" Valerianic - - - - -	347	0·48	187·2
Ether, acetic - - - - -	165·2	0·48	190·8
Butyrate of Methylène - - - - -	199·4	0·49	156·6
Essence of turpentine - - - - -	312·8	0·47	124·2
Térébène - - - - -	312·8	0·52	120·6
Oil of lemons - - - - -	329	0·50	126

1514. *Condensation of vapour.*—Since by continually imparting heat to any body in the liquid state it at length passes into the form of vapour, analogy suggests that by continually withdrawing heat from a body in the vaporous state, it must necessarily return to the liquid state; and this is accordingly generally true. The vapour being exposed to cold is deprived of a part of that heat which is necessary to sustain it in the aeriform state, and a part of it is accordingly restored to the liquid form, and this continues until by the continual abstraction of heat the whole of the vapour becomes liquid; and as a liquid, in passing to the vaporous form, undergoes an immense expansion or increase of bulk, so a vapour in returning to the liquid form undergoes a corresponding and equal diminution of bulk. A cubic inch of water, transformed into steam at 212°, enlarges in magnitude to nearly 1700 cubic inches. The same steam being reconverted into water, by abstracting from it the heat communicated in its vaporization, will be restored to its former bulk, and will form one cubic inch of water at 212°. Vapours arising from other liquids will undergo a like change, differing only in the degree of diminution of volume which they suffer respectively. The diminished space into which vapour is contracted when it passes into the liquid form, has caused this process to be called *condensation*.

1515. *Why vessels in which liquids are boiled are not destroyed by extreme heat.*—The absorption of heat in the process by which liquids are converted into vapour will explain why a vessel containing a liquid that is constantly exposed to the action

1517. *Method of warming dwelling-houses.*—In dwelling-houses where pipes convey cold water to different parts of the building, steam pipes carried through the building will enable hot water to be procured in every part of it with speed and facility. The cock of the steam pipe being immersed in a vessel containing cold water, the steam which escapes from it will be condensed by the water, which receiving the latent heat will soon be raised to any required temperature below the boiling point. Warm baths may thus be prepared in a few minutes, the water of which would require a long period to boil.

1518. *Effects of the temperatures of different climates on certain liquids.*—The variations of temperature incident to any part of the globe are included within narrow limits, and these limits determine the bodies which are found to exist there most commonly in the solid, liquid, or gaseous state.

A body whose boiling point is below the lowest temperature of the climate must always exist in the state of vapour or gas ; and one whose point of fusion is above the highest temperature must always be solid. Bodies whose point of fusion is below the lowest temperature, while their boiling point is above the highest temperature, will be permanent liquids. A body whose point of fusion is a little above the lowest limit of the

temperature, will exist generally as a liquid, but occasionally as a solid. Water in these climates is an example of this. A liquid, on the other hand, whose boiling point is a little below the highest limit of temperature, will generally exist in the liquid, but occasionally in the gaseous form. Ether in hot climates is an example of this, its boiling point being 98°.

Some bodies are only permanently retained in the liquid state by the atmospheric pressure. Ether and alcohol are examples of these. If these liquids be placed under the receiver of an air-pump, and the pressure of the air be partially removed, they will boil at the common temperature of the air.

## CHAP. IX.

## CONDUCTION. .

1519. *Good and bad conductors.*—When heat is imparted to one part of any mass of matter, the temperature of that part is raised above that of the other parts. This inequality, however, is only temporary. The heat gradually diffuses itself from particle to particle throughout the volume of the body, until a perfect equilibrium of temperature has been established. Different bodies exhibit a different facility in this gradual transmission of heat. In some it passes more rapidly from the hotter to the colder parts than in others. Those bodies in which it passes easily and rapidly, are *good conductors*. Those in which the temperature is equalized slowly, are *bad conductors*.

1520. *Experimental illustration of conduction.*—Let AB,

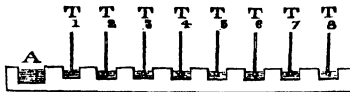

Fig. 447.

*fig. 447.*, be a bar of metal having a large cavity formed at its extremity A, and having a series of small cavities formed at

equal distances throughout its length at  $T_1$ ,  $T_2$ ,  $T_3$ , &c. Let the bulbs of a series of thermometers be immersed in mercury in these cavities severally. These thermometers will all indicate the same temperature, being that of the bar  $A B$ .

Let the large cavity  $A$ , at the end of the bar, be filled with mercury at a high temperature,  $400^\circ$  for example.

After the lapse of some minutes the thermometer  $T$  will begin to rise; after another interval the thermometer  $T_2$  will begin to be affected; and the others,  $T_3$ ,  $T_4$ , &c., will be successively affected in the same way; but the thermometer  $T_1$ , by continuing to rise, will indicate a higher temperature than  $T_2$ , and  $T_2$  a higher temperature than  $T_3$ , and so on. After the lapse of a considerable time, however, the thermometer  $T_1$  will become stationary. Soon afterwards  $T_2$ , having risen to the same point, will also become stationary; and, in the same manner, all the others having successively risen to the same point, will become stationary.

If several bars of different substances of equal dimensions be

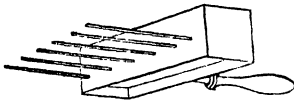

Fig. 448.

submitted to the same process, the thermometers will be more or less rapidly affected according as they are good or bad conductors.

An apparatus by which this is exhibited in a striking manner is represented in *fig. 448*. A series

of rods of equal length and thickness are inserted at the same depth in the side of a rectangular vessel, passing across the interior of the vessel to the opposite side. The rods, which are silver, copper, iron, glass, porcelain, wood, &c., are previously covered with a thin coating of wax, or any other substance which will melt at a low temperature. Boiling water or heated mercury is poured into the vessel, and imparts heat to those parts of the rods which extend across it. It is found that the heat as it passes by conduction along the rods, melts the wax from their surface. Those which are composed of the best conductors—silver, for example—will melt off the wax most rapidly; the less perfect conductors less rapidly; and on the rods composed of the most imperfectly conducting materials, such as glass or porcelain, the wax will not be melted beyond a very small distance from the point where the rod enters the vessel.

1521. *Table of conducting powers.*—By experiments con-

ducted on this principle, it has been found that the conducting powers of the subjoined substances are in the ratio here expressed, that of gold being 100.

Gold	-	-	-	100·00	Tin	-	-	-	30·38
Platinum	-	-	-	98·10	Lead	-	-	-	17·96
Silver	-	-	-	97·30	Marble	-	-	-	2·34
Copper	-	-	-	89·82	Porcelain	-	-	-	1·22
Iron	-	-	-	37·41	Brick earth	-	-	-	1·13
Zinc	-	-	-	36·37					

It is evident, therefore, that metals are the best conductors of heat, and in general the metals which have the greatest specific gravity are the best conductors, as will appear by comparing the preceding numbers with those given in the table of specific gravity (782). It is also found that among woods, with some exceptions, the conducting power increases with the density. The conducting power of nut wood, however, is greater than that of oak.

Bodies of a porous, soft, or spongy texture, and more especially those of a fibrous nature, such as wool, feathers, fur, hair, &c., are the worst conductors of heat.

1522. *Liquids and gases are non-conductors.*—Liquids are almost absolute non-conductors. Let a tall narrow glass vessel having a cake of ice at the bottom be filled with strong alcohol at 32°. Let two thermometers be immersed in it, one near the surface, and the other at half the depth. If the alcohol be inflamed at the surface, the thermometer near the surface will rise, but that which is at the middle of the depth will be scarcely affected, and the ice at the bottom will not be dissolved.

Bodies in the gaseous state are probably still more imperfect conductors than liquids.

1523. *Temperature equalized in these by circulation.*—The equilibrium of temperature is, however, maintained in liquid and gaseous bodies by other principles, which are more prompt in their action than the conductivity even of the solids which possess that quality in the highest degree. When the strata of fluids, whether liquid or gaseous, are heated, they become by expansion relatively lighter than those around them. If they have any strata above them, which generally happens, they rise by their buoyancy, and the superior strata descend. There are thus two systems of currents established, one ascending and

the other descending, by which the heat imparted to the fluid is transfused through the mass, and the temperature is equalized.

1524. *Conducting power diminished by subdivision and pulverization.* — The conducting power of all bodies is diminished by pulverizing them, or dividing them into fine filaments. Thus sawdust, when not too much compressed, is one of the most perfect non-conductors of heat. A casing of sawdust is found to be the most effectual method of preventing the escape of heat from the surface of steam boilers and steam pipes.

If, however, the sawdust be either much compressed on the one hand, or too loosely applied on the other, it is not so perfect a non-conductor. In the one case, the particles being brought into closer contact, transmit heat from one to another; and in the other case, the air circulating too freely among them, the currents are established by which the heat is transfused through the mass.

To produce, therefore, the most perfect non-conductor, the particles of the body must have naturally little conductivity, and they must be sufficiently compressed to prevent the circulation of currents of air among them, and not sufficiently compressed to give them a facility of transmitting heat from particle to particle by contact.

1525. *Beautiful examples of this principle in the animal economy.* — The animal economy presents numerous and beautiful examples of the fulfilment of these conditions. It is generally necessary to the well-being of the animal to have a temperature higher than that of the medium which it inhabits. In the animal organization, there is a principle by which heat is generated. This heat has a tendency to escape and to be dissipated at the surface of the body, and the rate at which it is dissipated depends on the difference between the temperature of the surface of the body and the temperature of the surrounding medium. If this difference were too great, the heat would be dissipated faster than it is generated, and a loss of heat would take place, which, being continued to a certain extreme, would destroy the animal.

Nature has provided an expedient to prevent this, which varies in its efficiency according to the circumstances of the climate and the habits of the animal.

1526. *Uses of the plumage of birds.* — The plumage of birds is composed of materials which are bad conductors of heat, and

are so disposed as to contain in their interstices a great quantity of air without leaving it space to circulate. For those species which inhabit the colder climates a still more effectual provision is made, for, under the ordinary plumage, which is adapted to resist the wind and rain, a still more fine and delicate down is found, which intercepts the heat which would otherwise escape through the coarser plumage. Perhaps the most perfect insulator of heat is swansdown.

1527. *The wool and fur of animals.*—The wool and fur of animals are provisions obviously adapted to the same uses. They vary not only with the climate which the species inhabits, but in the same individual they change with the season. In warm climates the furs are in general coarse and sparse, while in cold countries they are fine, close, light, and of uniform texture, so as to be almost impermeable to heat.

1528. *The bark of vegetables.*—The vegetable, not less than the animal kingdom, supplies striking illustrations of this principle. The bark, instead of being hard and compact, like the wood which it clothes, is porous, and in general formed of discontinuous laminæ and fibres, and for the reasons already explained is a bad conductor of heat, and thus prevents such a loss of heat from the surface of the wood under it as would be injurious to the tree.

A tree stripped of its bark perishes as an animal would if stripped of its fleece, or a bird of its plumage.

1529. *Properties of the artificial clothing of man.*—Man is endowed with faculties which enable him to fabricate for himself covering similar to that which nature has provided for other animals; and where his social condition is not sufficiently advanced for the accomplishment of this, his object is attained by the conquest of inferior animals whose clothing he appropriates.

Clothes are generally composed of some light non-conducting substances which protect the body from the inclement heat or cold of the external air. In summer clothing keeps the body cool; in winter, warm. Woollen substances are worse conductors of heat than cotton, cotton than silk, and silk than linen. A flannel shirt more effectually intercepts heat than cotton, and a cotton than a linen one.

1530. *Effects of snow on the soil in winter.*—What the plumage does for the bird, wool for the animal, and clothing for



the man, snow does in winter for the soil. The farmer and the gardener look with dismay at a hard and continued frost which is not preceded by a fall of snow. The snow is nearly a non-conductor, and, when sufficiently deep, may be considered as absolutely so. The surface may therefore fall to a temperature greatly below  $32^{\circ}$ , but the bottom in contact with the vegetation of the soil does not share in this fall of temperature, remaining at  $32^{\circ}$ , a temperature at that season not incompatible with the vegetable organization. Thus the roots and young shoots are protected from a destructive cold.

1531. *Matting upon exotics.*—The gardener who rears exotic vegetables and fruit-trees, protects them from the extreme cold of winter by coating them with straw, matting, moss, and other fibrous materials which are non-conductors.

1532. *Method of preserving ice in hot climates.*—If we would preserve ice from dissolving, the most effectual means would be to wrap it in blankets. Ice-houses may be advantageously surrounded with sawdust, which keeps them cold by *excluding* the heat, by the same property in virtue of which it keeps steam boilers warm by *including* the heat.

Air being a bad conductor of heat, ice-houses are sometimes constructed with double walls, having a space between them. This expedient is still more effectual, if the space be filled with loose sawdust.

1533. *Glass and porcelain vessels, why broken by hot water.*—Glass and porcelain are slow conductors of heat, which explains the fact that vessels of this material are so often broken by suddenly pouring hot water into them. If it be poured into a glass tumbler, the bottom, with which the water first comes in contact, expands, but the heat not passing freely to the upper part, this expansion is limited to the bottom, which is thus forced from the upper part and a crack is produced.

1534. *Wine-coolers.*—When wine-coolers have a double casing, the external space is filled with a non-conductor.

1535. *A heated globe cools inwards.*—When a solid body, a globe for example, is heated at the surface, the heat passes gradually from the surface to the centre. The temperature of the superficial stratum is greater, and the temperature of the centre less than those of the intermediate parts, and the temperature of the successive strata are gradually less proceeding from the surface to the centre.

But if the globe be previously heated, so as to have an uniform temperature from the centre to the surface, and be allowed to cool gradually, the superficial stratum will first fall some degrees below the stratum within it. This latter will fall below the next stratum proceeding inwards; and in the same way each successive stratum proceeding from the surface to the centre will attain a temperature a little lower than the stratum under it, the temperatures augmenting from the surface to the centre.

After an interval, of greater or less duration according to the magnitude of the globe, the conductability and specific heat of the matter of which it is composed, the temperature to which it had been raised, and the temperature of the medium, it will be reduced to an uniform temperature, which will be that of the surrounding medium.

1536. *Example of fluid metal cast in spherical mould.*—If a mass of fluid metal be cast in a spherical mould, the surface only will be solidified in the first instance. It will become a spherical shell, filled with liquid metal. As the cooling proceeds, the shell will thicken, and after an interval of time, the length of which will depend on the circumstances above mentioned, the ball will become solid to its very centre, the last portion solidified being that part of the metal which is at and immediately around the centre.

It is evident that the superficial stratum will first cease to be incandescent; and in the same way each successive stratum proceeding from the surface to the centre will cease to be incandescent before the stratum within it.

If in the process of cooling, and after the globe ceases to be red hot, it were cut through the centre, it would be found that the central parts would be still incandescent; and if its magnitude were sufficiently considerable, it would be found that even after the superficial stratum had been reduced to a moderate temperature, strata nearer the centre would be red hot, and the central part still fluid.

1537. *Cooling process may be indefinitely protracted.*—The interval which must elapse before the thermal equilibrium would be established, might be hours, days, weeks, months, years, or even a long succession of ages, according to the magnitude and physical qualities of the material composing the globe.

1538. *Example of the castings of the hydraulic press, which*

*raised the Britannia Bridge.*—The cylinder of the hydraulic press by which the tubes of the Britannia bridge were elevated was formed of a mass of fluid iron weighing 22 tons. This enormous casting, after being left in the mould for three days and nights, was still red hot at the surface. After standing to cool in the open air for ten days, it was still so hot that it could only be approached by men well inured to heat.

1539. *Example of streams of volcanic lava.*—The torrents of liquid lava which flow from volcanos become solid on their external surface only to a certain thickness. The lava in the interior of this shell still continues fluid. The stream of lava thus forms a vast tube, within which that portion of the lava still liquid flows for a long period of time. Months and even years sometimes elapse, before the thermal equilibrium of these volcanic masses is established.

1540. *Example of the earth itself.*—The globe of the earth itself presents a stupendous example of the play of these principles. The vicissitudes of temperature incidental to the surface extend to an inconsiderable depth. At the depth of an hundred feet in our climates, they are completely effaced. At this depth, the thermometer no longer varies with the seasons. In the rigour of winter, and the ardour of summer, it stands at the same point. This stratum, which is called the first stratum of invariable temperature, is found to be at Paris at the depth of 88·6 feet. The thermometer in the vaults under the Observatory at that depth has continued without variation at 11°82 cent. = 53°50 Fahr. for nearly two centuries.

1541. *Temperature increases with the depth.*—At greater depths the temperature increases, but is always invariable for the same depth. An increase of temperature takes place in descending, at the rate of one degree for every 54½ feet of depth. Thus the water which issues from the artesian wells at Grenelle near Paris, and which rises from a depth of 1800 feet, has a constant temperature of 27°·7 cent. = 82° Fahr.

It is apparent that the earth is a globe undergoing the gradual process of cooling, and that each stratum proceeding inwards towards the centre augments in temperature. It follows, therefore, that a part at least of the superficial heat of the earth proceeds from within. It is certain, nevertheless, by taking into account all the conditions of the question, that the cooling goes on so slowly, as to have no sensible influence on the tempera-

ture at the surface, which is therefore governed by the solar heat, and the heat of the medium or space in which our globe, in common with the other planets, moves. It has been computed that the quantity of central heat which reaches the surface in a year would not suffice to dissolve a cake of ice a quarter of an inch thick.

1542. *The earth was formerly in a state of fusion, and it is still cooling.*—The globe of the earth therefore manifesting the effects of a mass which, having been at some antecedent period at an elevated temperature, is undergoing the process of gradually cooling from the surface inwards, it is probable that its central parts may be still in a state of incandescence or fusion.

## CHAP. X.

### RADIATION.

1543. *Heat radiates like light.*—Heat, like light, is propagated through space by radiation in straight lines, and its rays, like those of light, are subject to transmission, reflection, and absorption by such bodies as they encounter in various degrees.

All that has been explained (896. *et seq.*) respecting the reflection of light from unpolished, perfectly and imperfectly polished surfaces, its refraction by transparent media, its interference, inflexion, and polarization, may, with little modification, be applied to the rays of heat submitted to like conditions.

1544. *Thermal analysis of solar light.*—It has been already shown that solar light is a compound principle, consisting of rays differing one from another, not only in their luminous qualities of colour and brightness, but also in their thermal and chemical properties (1076. *et seq.*).

Let ss, *fig.* 449., represent a pencil of solar light transmitted through a prism ABC, so as to be resolved into a divergent fan of rays, and to form a spectrum as described in (1053.) *et seq.* Let L and L' be the limits of the luminous spectrum. If the bulb of a thermometer be placed at L, it will not indicate any elevation of temperature; and if it be gradually moved down-

wards along the spectrum, it will not begin to be sensibly affected until it arrives at the boundary of the violet and blue

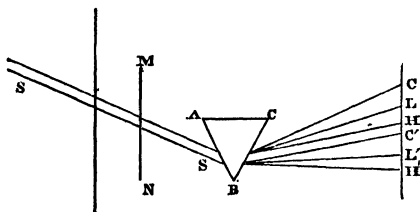

Fig. 449.

spaces, where it will show an increased temperature. As it is moved downwards from this point, the temperature will continue to increase until it is brought to the lower extremity  $L'$  of the luminous spectrum. If it be then removed below this point, instead of falling to the temperature of the medium around the spectrum, as might be expected, and as would in fact happen if no rays of heat transmitted through the prism passed below  $L'$ , it will descend slowly and gradually, and will in some cases even show an increased temperature to a certain small distance below  $L'$ . In fine, it will be found that the thermometer will not fall to the temperature of the surrounding medium until it arrives at a certain distance  $H'$  below  $L'$ , the extremity of the luminous spectrum.

1545. *Thermal solar rays differently refrangible.*—From this and other similar experiments, it is inferred that thermal rays which are not luminous, or at least not sensibly so, enter into the composition of solar light, and that these rays are differently refrangible, their mean refrangibility being less than the mean refrangibility of the luminous rays.

It has been explained (1077) that the chemical rays which enter into the composition of solar light are also differently refrangible, and have a mean refrangibility greater than that of the luminous rays.

1546. *Physical analysis of solar light—Three spectra.*—According to this view of the constitution of solar light, the prism  $ABC$  must be regarded as producing three spectra, a chemical spectrum  $CC'$ , a luminous spectrum  $LL'$ , and a thermal spectrum  $HH'$ . The luminous or chromatic spectrum, the only one visible, lies between, and is partly overlaid by, the other

two, the chemical spectrum extending a little above, and the thermal a little below it. If we imagine a screen  $mN$  placed before the prism, composed of a material pervious to the luminous, but impervious to the chemical and thermal rays, then the luminous spectrum  $LL'$  alone will remain, and neither a thermometer nor the chloride of silver, nor any other chemical substance, will be affected when exposed in it. If the screen  $mN$  be pervious only to the thermal rays, then the luminous and chemical rays will be intercepted, and the thermal spectrum  $HH'$  alone will be manifested. The thermometer exposed in it will indicate the variations of calorific influence already explained, showing the greatest thermal intensity at or near that point at which the red extremity of the luminous spectrum would have been found, had the luminous rays not been intercepted.

1547. *Relative refrangibility of the constituents of solar light vary with the refracting medium.*—If prisms composed of different materials be used, it will be found that the mean refrangibility of the thermal rays will vary according to the material of the prism and heat; consequently, the position of the point of greatest thermal intensity will be subject to a like variation.

If a hollow prism be filled with water or alcohol, the point of greatest thermal intensity will be about the middle of the yellow space of the luminous spectrum. If a prism of sulphuric acid, or a solution of corrosive sublimate, be used, it will be in the orange space. With a crown glass prism it will be in the red space; and with one of flint glass, a little below that space.

1548. *Invisible rays may be luminous, and all rays may be thermal.*—In the preceding explanation, the solar light is regarded as consisting of three distinct species of rays, the chemical, the luminous, and the thermal. It is not necessary, however, for the explanation of these phenomena, to adopt this hypothesis. The light may be considered as consisting of rays which, differing in refrangibility, possess the other physical qualities also in different degrees. So far as the sensibility of thermometers enables us to detect the thermal property, it ceases to exist at a certain point,  $HG$ , near the boundary of the blue and violet spaces; but the diminution of thermal intensity, in approaching this point, as indicated by the thermometer, is very gradual; and it cannot be denied, that a thermal influence may exist above that point, which is, nevertheless, too feeble to affect the thermoscopic tests which are used. In the same manner it

may be maintained, that a chemical influence may exist below the point  $c'$ , but too feeble to affect any of the tests which have been applied to it.

But it may be asked, if all the component rays possess all the properties in different degrees, how happens it that the chemical rays above  $L$ , and the thermal rays below  $L'$ , are not visible? To this it may be answered, that the presence of the luminous quality is determined by its effects on the eye; and the discovery of its presence must therefore depend on the sensibility of that organ. To pronounce that there are no luminous rays beyond the limits of the chromatic spectrum, would be equivalent to declaring the sensibility of the eye to be unlimited. Now, it is notorious that the sensibility of sight, in different persons, is different; and, even in the same individual, varies at different times. Circumstances render it highly probable that many inferior animals have a sensation of light, and a perception of visible objects, where the human eye has none; and it is therefore consistent with analogy to admit the possibility, if not the probability, that the invisible thermal rays below  $L'$ , and the invisible chemical rays above  $L$ , may be of the same nature as the other rays of the spectrum, all enjoying the luminous, thermal, and chemical properties in common, the apparent absence of these properties in the extreme rays being ascribable solely to the want of sufficient sensibility in the only tests of their presence which we possess.

Fortunately, however, the deductions of physical science, though they may be facilitated by these and other hypotheses, are not dependent on them, but on observed facts and phenomena, and cannot, consequently, be shaken by the failure of such theories.

1549. *Refraction of invisible thermal rays.*—If a hole be made in the screen upon which the prismatic spectrum is thrown, in the space  $L'H'$  below the red extremity of the spectrum upon which the invisible thermal rays fall, these rays will pass through it, and may be submitted to all the experiments on reflection, refraction, inflexion, interference, and polarization, which have been explained in relation to light. This has been done, and they have been found to manifest effects similar to those exhibited by luminous rays.

1550. *Heat radiated from each point on the surface of a body.*—It has been shown (902. *et seq.*) that when a body is either luminous, like the sun, or illuminated, like the moon, each point

upon its surface is an independent centre of radiation or *focus*, from which rays of light diverge or radiate in all directions. It is the same with regard to heat. All bodies, whatever be the state or condition, contain more or less of this physical principle; and rays of heat accordingly issue from every point upon their surface, as from a focus, and diverge or radiate in all directions through the surrounding space.

1551. *Why bodies are not therefore indefinitely cooled.*—This being the case, it would follow that by such continual and unlimited radiation, bodies would gradually lose their heat, and indefinitely fall in temperature. It must be considered, however, that such radiation being universal, each body, while it thus radiates heat, receives upon its surface the rays of heat which proceed from other bodies around it. So many of these rays as it absorbs tend to increase its temperature, and to replace the heat dispersed by its own radiation. There is thus between body and body a continual interchange of heat by radiation; and according as this interchange is equal or unequal, the temperature of the radiating body will rise or fall. If it radiate more than it absorbs, it will fall; if less, it will rise. If it absorb as much exactly as it radiates, its temperature will be maintained stationary.

1552. *Radiation is superficial or nearly so.*—Radiation takes place altogether from points either on the surface or at a very small depth below it. The circumstances which affect it have been made manifest by a beautiful series of experiments made by the late Sir John Leslie. The principles on which his mode of experimenting was founded, are easily explained.

1553. *Reflection of heat.*—Let a cubical canister of tin, *fig. 450.*, be placed in the axis of a parabolic metallic reflector *M*, in the focus *f* of which is placed the bulb of a sensitive differential thermometer. If the canister be placed with one of its sides at right angles to the axis of the reflector, and be filled with boiling water, the thermometer will instantly show an increase of temperature

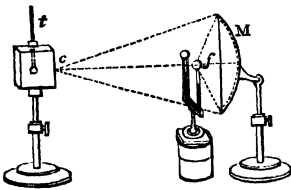

Fig. 450.

caused by the heat radiated from the surface of the canister, and collected into a focus upon the ball by the reflector.



The experiment may be varied by filling the canister with liquids at all temperatures, with snow and with freezing mixtures having various degrees of artificial cold. The surface of the canister may be varied in material by attaching to it different substances, such as paper, metallic foil, glass, porcelain, &c. It may be varied in texture by rendering it rough or smooth, and in colour by any colouring matter.

In this way the influence of all these physical conditions upon the radiation from the surface may be, and has been, ascertained.

The results of such experimental researches have been briefly as follows:—

1554. *Rate of radiation proportional to excess of temperature of radiator above surrounding medium.*—The rate at which the radiating body loses or gains temperature, other things being the same, is proportional to the difference between its own temperature and that of the surrounding medium, where this difference is not of very extreme amount.

1555. *Intensity inversely as square of distance.*—The intensity of the heat radiated is, like that of light, other things being the same, inversely as the square of the distance from the centre of radiation (907).

1556. *Influence of surface on radiating power.*—The radiating power varies with the nature of the surface, and its degree of polish or roughness.

In general, the more polished a surface is, the less will be its radiation. Whatever tarnishes or roughens the surface of metal, increases its radiation.

Metallic are in general less powerful radiators than non-metallic surfaces.

1557. *Reflection of heat.*—When the rays of heat encounter any surface, they are more or less reflected from it. Surfaces, therefore, in relation to heat, are perfect or imperfect, good or bad reflectors.

In the experiments above described, the reflecting powers of different surfaces were ascertained by constructing the concave reflector *M* of different materials, or by coating its surface variously, or, in fine, by submitting its surface to any desired physical conditions. Thus, when a reflector of glass is substituted for one of metal, the radiating surface of the canister remaining the same, it is found that the effect on the thermo-

meter is diminished. Glass is therefore a less perfect reflector than metal. If the surface of the reflector be coated with lampblack, no effect whatever is produced on the thermometer. Such a surface does not, therefore, reflect the thermal rays.

1558. *Absorption of heat.*—To determine the physical conditions which affect the absorbing power of a surface, it is only necessary, in the experiment above described, to vary the surface of the ball  $f$  of the thermometer, which is placed in the focus of the reflector, for, as the heat is radiated by  $c$  and reflected by  $m$ , it is absorbed by  $t$ .

By coating the ball of the thermometer, therefore, with metallic foil, paper, lampblack, and other substances, and by rendering it in various degrees rough and smooth, the effects of these modifications on the thermometer are rendered manifest, and the comparative absorbing powers are ascertained.

In this way it has been ascertained that the same physical conditions which increase the radiation and diminish the reflection, increase the absorption. The best radiators are the most powerful absorbers and the most imperfect reflectors.

1559. *Tabular statement of radiating and reflecting powers.*—The relative radiating, absorbing, and reflecting powers of various surfaces have been submitted to a still more rigorous analysis by M. Melloni, whose researches were greatly favoured by the fine climate of Naples, where they were principally made. The results are given in the following table, in the first column of which the numbers express the radiating and absorbing powers, that of a surface covered with the smoke of a lamp being expressed by 100. The absorbing power of this surface is complete. The reflecting power is, as will be observed, the complement of the absorbing power.

*Table showing the absorbing and reflecting Powers of various Surfaces according to the Experiments of Melloni.*

Names.	Radiating and absorbing Powers.	Reflecting Power.	Names.	Radiating and absorbing Powers.	Reflecting Power.
Smoke-blackened surface -	100	0	Metallic mirrors a little tar-		
Carbonate of lead - - -	100	0	nished - - - - -	17	83
Writing paper - - - -	98	2	„ nearly polished - - -	14	86
Glass - - - - -	90	10	Brass cast, imperfectly po-		
China ink - - - - -	85	15	lished - - - - -	11	89
Gumlac - - - - -	72	28	„ hammered, „	9	91
Silver foil on glass - -	27	73	„ cast, „ highly polished	7	93
Cast iron polished - -	25	75	„ cast, „	7	93
Mercury (nearly) - - -	23	77	Copper coated on iron - -	7	93
Wrought iron polished -	23	77	„ varnished - - - -	14	86
Zinc polished - - - -	19	81	„ hammered or cast - -	7	93
Steel, „	17	83	Gold plating - - - -	5	95
Platinum, thick coat, imper-			Gold deposited on polished		
fectly polished - - -	24	76	steel - - - - -	3	97
„ plate on copper - -	17	83	Silver, hammered and well		
„ leaves - - - - -	17	83	polished - - - - -	3	97
Tin - - - - -	14	86	Silver, cast, and well polished	3	97

1560. *Singular anomaly in the reflection from metallic surfaces.*—The numbers given in this table, which will be observed to differ considerably from those determined by Leslie and others, have been obtained by the recent elaborate experimental researches of MM. de la Provostaye and Desains. In these experiments an anomalous circumstance was observed on varying the angle of incidence of the thermal rays. It was found that, in the case of glass, the proportion of rays reflected increased with the angle of incidence, as happens with luminous rays, but that with polished metallic surfaces, the same proportion was reflected at all incidences up to  $70^\circ$ , and beyond this limit the proportion reflected, instead of increasing, as would have been expected, was greatly diminished.

1561. *Thermal equilibrium maintained by the interchange of heat by radiation and absorption.*—From all that has been here explained it will be apparent that the state of thermal equilibrium is maintained among any system of bodies by a continual interchange of heat by radiation and absorption. The heat which each body receives from others in its presence, it partly absorbs and partly reflects. Those rays which it absorbs tend to raise its temperature; and this temperature would soon rise above that which the thermal equilibrium requires, but that the body radiates heat from all points of its surface; and

the total quantity thus radiated is equal to the total quantity absorbed. If either of these quantities were permanently greater or less than the other, the temperature of the body would either indefinitely rise, or indefinitely fall, according as the heat absorbed or radiated might be in excess.

If a body, at any given temperature, be placed among other bodies, it will immediately affect them *thermally*, just as a candle brought into a room illuminates all bodies in its presence, with this difference, however, that if the candle be extinguished, no more light is diffused by it; but no body can be *thermally extinguished*. All bodies, however low be their temperature, contain heat, and therefore radiate it.

1562. *Erroneous hypothesis of radiation of cold*.—If a ball of ice be brought into the presence of a thermometer, the thermometer will fall; and hence it was erroneously inferred that the ice emitted *rays of cold*. The effect, however, is otherwise explained. The ice and the ball of the thermometer both radiate heat, and each absorbs more or less of what the other radiates towards it. But the ice being at a lower temperature than the thermometer, radiates less than the thermometer, and therefore the thermometer absorbs less than the ice, and consequently falls.

If the thermometer placed in presence of the ice had been at a lower temperature than the ice, it would, for like reasons, have risen. *The ice in that case would have warmed the thermometer.*

1563. *Transmission of heat*.—When rays of heat are incident on the surfaces of certain media, they penetrate them in greater or less quantity, according to the nature and properties of the medium, just as rays of light pass through bodies which are more or less transparent or diaphanous.

Media which are pervious to heat are said to be *diathermanous*, and those which are impervious are called *athermanous*.

Bodies are diathermanous in different degrees, or altogether athermanous, according to their various physical characters, their thickness, the state of their surface, the nature of the heat which is incident upon them, and other conditions.

1564. *Melloni's thermoscopic apparatus*.—Nearly all the knowledge we possess in this branch of the physics of heat is the result of the recent researches of M. Melloni. The thermoscopic apparatus contrived and applied with singular felicity

and success by him, consisted of a thermo-galvanic pile acting upon a highly sensitive galvanometer. It will be explained hereafter that if the thermal equilibrium be disturbed in certain metallic combinations, an electric current will be produced, the intensity of which will be proportional to the difference of temperature produced, and that the force of such a current can be measured by the deviation it produces in a magnetic needle, round which it is conducted spirally upon a coil of metallic wire coated with a non-conducting substance.

The general form and arrangement of this apparatus, and the manner of applying it to thermal researches, are represented in *figs. 451, 452, 453, and 454.*

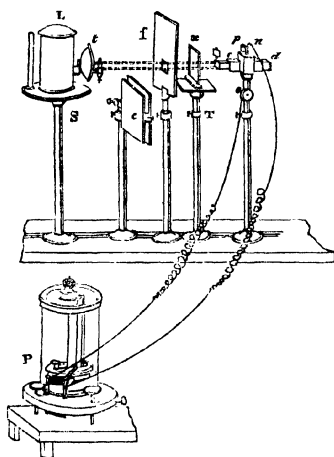

Fig. 451.

Upon the stand *s* is placed the source of heat which is submitted to experiment. Those which M. Melloni selected were a lamp *L*, with a concave reflector *t*; a spiral wire of platinum *II*, *fig. 452.*, rendered incandescent by the flame of a spirit-lamp; a plate of copper *I*, *fig. 453.*, blackened with smoke, and raised to the temperature of  $700^{\circ}$  by a spirit-lamp; and, in fine, a cubical canister *K*, *fig. 454.*, similar to those used by Leslie.

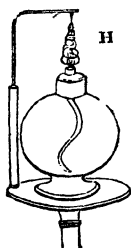

Fig. 452.

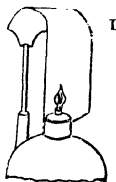

Fig. 453.

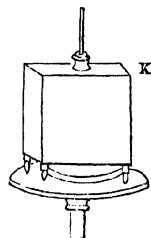

Fig. 454.

On the stand  $\tau$  was placed the body  $x$ , through which the rays of heat were to be transmitted, and which was formed into a thin plate. An athermanous screen  $f$  was interposed, having in it an aperture to limit the pencil of rays transmitted to  $x$ . Another athermanous screen was placed at  $c$ , movable upon a joint by which the pencil proceeding from the lamp could be intercepted or transmitted at pleasure.

The thermo-voltaic pile was placed at  $p$ , having one end presented to the thermal pencil, and movable in a case fitting it, in which it was capable of sliding. Its poles  $p$  and  $n$  were connected by conducting wires with the galvanometer, the needle of which indicated by its deflection the intensity of the heat by which the pile  $p$  was affected.

1565. *Results of Melloni's researches.*—The series of experiments made with this apparatus gave the remarkable, and in many respects unexpected, results which we shall now briefly state.

The only substance found to be perfectly diathermanous was rocksalt. Plates of this crystal transmit nearly all the heat which enters them, no matter from what source. Of the incident rays 7·7 per cent. are reflected from both surfaces of the plate, and the whole of the remaining 92·3 per cent. are transmitted. There is no absorption.

Bodies in general are less athermanous the higher the temperature of the radiator.

1566. *Transparent media not proportionally diathermanous.*—Media are not diathermanous in proportion as they are transparent. On the contrary, certain media which are nearly opaque are highly diathermanous, while others which are highly transparent are nearly athermanous. Thus, black glass and plates of smoked quartz so opaque that the disk of the sun in the meridian is barely visible through them, are much more diathermanous than plates of alum, which are very transparent; and plates of quartz smoked to opacity are more diathermanous than when clean and transparent. In like manner, black glass is more diathermanous than colourless glass.

1567. *Decomposition of heat by absorption.*—The thermal pencil is composed of rays, some of which are absorbed, and others transmitted by certain media. This effect is altogether analogous to that which is produced by coloured media on light. If a pencil of solar light be incident upon red glass, the

red rays alone will be transmitted, those of the other colours being absorbed ; but if the red light transmitted through such a plate be received upon a second red plate, there will be no further absorption, at least so far as depends on the colour of the light. In like manner, when a thermal pencil enters certain diathermanous media, a part of its rays are intercepted, others being transmitted. If these last be received upon another plate of the same diathermanous substance, they will pass freely through it without further absorption.

It is therefore inferred that such a medium decomposes by absorption the thermal pencil in the same manner as a coloured transparent medium decomposes by absorption a pencil of white light. This inference is confirmed by the fact that different partially diathermanous media absorb different constituents of the thermal pencil. Thus we may cause its entire absorption by causing it successively to pass through two media, each of which absorbs the rays transmissible by the other.

This is also analogous to the effects of coloured transparent media upon luminous pencils. If a pencil of solar light be successively incident upon two plates, one of red and the other of the complementary tint of bluish-green, it will be wholly absorbed, the second plate absorbing all the rays transmitted by the first.

1568. *Absorption not superficial, but limited to a certain depth.*—The partial absorption produced by such imperfectly diathermanous media is not effected at the surface. The rays are absorbed gradually as they pass through the medium. This, however, is not continual. All absorption ceases after they have passed through a certain thickness, and the rays transmitted by a plate of that thickness would, in passing through a second plate of the same substance, undergo no further absorption.

Glass and rock crystal are each partially diathermanous, the thermal rays transmitted and absorbed however being different. If a thermal pencil pass through a plate of glass of a certain thickness, a part of the rays composing it will be absorbed. If the rays transmitted be received on another similar plate of glass, they will be all or nearly all transmitted, no further absorption taking place. But if these rays thus transmitted by the glass be received upon a plate of rock crystal of sufficient thickness, a portion of them will be absorbed. Now if the glass and

the rock crystal had each the power of absorbing the rays transmitted by the other, their combination would be absolutely athermanous, just as two plates of coloured glass would be opaque, if each transmitted only the colours complementary to those transmitted by the other.

1569. *Physical conditions of diathermanism.*—It appears from the researches of Melloni, that the physical conditions which render bodies more or less diathermanous have no connection with those which affect their transparency. Water is one of the least diathermanous substances, although its transparency is so nearly perfect. If, therefore, it be desired to transmit light without heat, or with greatly diminished heat, it is only necessary to let the rays pass through water, by which they will be strained of a great part of their heat.

If the quantity of radiant heat transmitted through air be expressed by 100, the following numbers will express the quantity transmitted through an equal thickness of the substances named below.

Air - - - - -	- 100	Rape oil - - - - -	- 30
Rocksalt (transparent) - - - - -	- 92	Tourmaline (green) - - - - -	- 27
Flint glass - - - - -	- 67	Sulphuric ether - - - - -	- 21
Bisulphuret of carbon - - - - -	- 63	Gypsum - - - - -	- 20
Calcareous spar (transparent) - - - - -	- 62	Sulphuric acid - - - - -	- 17
Rock crystal - - - - -	- 62	Nitric acid - - - - -	- 15
Topaz, brown - - - - -	- 57	Alcohol - - - - -	- 15
Crown glass - - - - -	- 49	Alum, crystals - - - - -	- 12
Oil of turpentine - - - - -	- 31	Water - - - - -	- 11

It appears, therefore, that of all solid bodies rock salt is the most diathermanous, and alum the least so. Of all liquids, bisulphuret of carbon is the most, and water the least, diathermanous.

It is evident from this table, that bodies are not diathermanous and transparent in the same degree. Rocksalt is less transparent but more diathermanous than glass.

It has been found that the power of thermal rays to penetrate an imperfectly diathermanous body is augmented by raising the temperature of the radiator. This is rendered very apparent in the case of glass, which is much more diathermanous to heat radiated by a body at a very high than by one at a moderate temperature. This may explain the fact that bodies in general are more diathermanous to solar light than to light proceeding from artificial sources.



It is found that heat radiated by bodies which are in a state of ignition or incandescence penetrate diathermanous media more freely than those radiated by bodies which are not luminous. This is in accordance with the general principle already stated, that thermal rays penetrate diathermanous bodies more easily the higher is the temperature of the radiator.

Experiments on the thermal analysis of solar light were made by transmitting a pencil of solar light, either obtained directly or by reflection, through the aperture in the screen *f*, *fig. 451*.

1570. *Refraction, reflection, and polarization of heat.* — Experiments on the refraction, reflection, and polarization of heat were made, by placing on the stand *r*, *fig. 451*., prisms of various materials, reflecting surfaces, polariscopes, or double refracting crystals. The thermoscopic apparatus was in each case placed in such a position as to receive the deflected thermal pencil.

In this manner pencils of heat proceeding from various sources were submitted to the same effects of refraction, reflection, and polarization as have been already described in Book IX. with respect to light, and analogous results were obtained; the thermal rays being subject to the same general laws of reflection and refraction as prevail in relation to luminous rays.

1571. *Application of these principles to explain various phenomena.* — The general principles regulating the radiation, absorption, reflection, and transmission of heat, which have been here stated, serve to explain and illustrate various experimental facts and natural phenomena, as will appear from what follows: —

If two concave parabolic reflectors be placed as described in (946), any radiator of heat placed in the focus of either will produce a corresponding effect upon a thermometer placed in the focus of the other, the rays of heat issuing from the radiating body being twice reflected and collected into the focus of the second reflector, upon the principle explained in (946).

1572. *Experiment of radiated and reflected heat with pair of parabolic reflectors.* — Let *R* and *R'*, *fig. 455*., be two such reflectors. If lighted charcoal be placed in the focus *F* of one, it will ignite amadou or any other easily inflammable substance in the other, even though the distance between the reflectors be twenty or thirty feet.

If a sensitive thermometer, such as the differential thermo-

meter (1349), be placed at  $F'$ , it will show an increase or diminution of temperature, according as a hot or cold body is placed

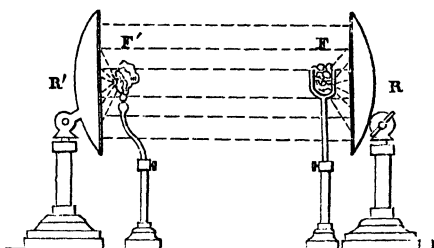

Fig. 454.

at  $F$ . If a small globe filled with hot water be placed there, an increase will be indicated; and if the globe be filled with snow or with a freezing mixture, a decrease will be manifested.

1573. *Materials fitted for vessels to keep liquids warm.*—Vessels intended to hold liquids at a higher temperature than that of the surrounding medium, should be constructed of materials which are bad radiators. Thus tea-urns, tea-pots, &c., are best adapted for their purpose when made of polished metal, and worst when of black porcelain. A tea-kettle keeps water hotter more effectually if clean and polished, than if covered with the black of soot and smoke. Polished fire-irons remain longer before a hot fire without being heated than rough unpolished ones.

1574. *Advantage of an unpolished stove.*—A polished stove is a bad radiator; one with a rough and blackened surface a good radiator. The latter is therefore better adapted for warming an apartment than the former.

1575. *Helmets and cuirasses should be polished.*—The helmet and cuirass worn by cavalry is a cooler dress than might be imagined, the polished metal being nearly a good radiator of heat, and throwing off the solar rays.

1576. *Deposition of moisture on window panes.*—When the external air, which generally happens, is at a lower temperature than the air included in the room, it will be observed that a deposition of moisture will be formed upon the inner surface of the panes of glass in the windows. This is produced by the

vapor suspended in the atmosphere of the room being condensed by the cold surface of the glass. If the external air in this case be at a temperature below  $32^{\circ}$ , the deposition on the inner surface of the glass will be congealed, and a rough coating of ice will be exhibited upon it.

Let two small pieces of tinfoil be fixed, one upon a part of the external surface of one of the panes, and the other upon the internal surface of another pane, in the evening; it will be found in the morning that that part of the internal surface of the pane upon which is placed the external foil will be nearly free from ice, while the surface of the internal foil will be more thickly covered with ice than the parts of the inner surface of the glass which are not covered with foil: these effects are easily explained by radiation. When the tinfoil is placed on the external surface, it reflects the heat which strikes on that surface, and protects that part of the surface which is covered from its action. The heat radiated from the objects in the room striking on the inner surface of the glass penetrates it, and encountering the foil attached to the exterior surface, is reflected by it through the glass, and its escape into the external atmosphere is intercepted; the portion of glass, therefore, opposite to the tinfoil, is subject to the action of the heat radiated from the chamber, but protected from the action of the external heat. The temperature of that part of the glass is therefore less depressed by the external atmosphere than the temperature of those parts which are not covered by tinfoil. Now glass being a bad conductor of heat, the temperature of that part opposite to the external foil does not immediately affect the remainder of the pane, and consequently we find that, while the remainder of the interior surface of the pane is thickly covered with ice, the portion opposite the tinfoil is comparatively free from it. On the contrary, when the tinfoil is applied on the internal surface, it reflects perfectly the heat radiated from the objects in the room, while it admits through the dimensions of the glass the heat proceeding from the external atmosphere. The portion of the glass, therefore, covered by the tinfoil, becomes colder than any other part of the pane, and the tinfoil itself partakes of this temperature, which is not raised by the effect of the radiation of objects in the room, because the tinfoil itself is a good reflector and a bad absorber. Hence the tinfoil presents a colder sur-

face to the atmosphere in the room, than any other part of the surface of the pane, and consequently receives a more abundant deposition of ice.

1577. *Principles which explain the phenomena of dew and hoar frost.*—A clear unclouded sky in the absence of the sun radiates but little heat towards the earth; consequently, if good radiators be exposed to such an aspect, they must suffer a fall of temperature, since they lose more by radiation than they receive.

Let a glass cup, for example, be placed in a silver basin, and exposed during a cold night to a clear sky; it will be found in the morning that a copious deposition of moisture will have been made on the glass, from which the silver vessel is perfectly free. Reversing the experiment, let a silver cup be placed in a glass basin, and similar results will ensue, the basin being perfectly covered with moisture, from which the cup is free. This is easily explained: the metal, being a bad radiator of heat, preserves its temperature; the glass, being a good radiator of heat, loses by radiation much more than it receives, and, consequently, its temperature falls, and it condenses the vapour in the air around it.

The result of experiments of this kind supplied Dr. Wells with his celebrated theory, by which he explained the phenomenon of dew.

According to what has been explained, it appears that the objects which are good radiators, exposed to a clear sky at night, will become colder than the surrounding atmosphere, and will consequently condense the water suspended in the air around them; while objects which are bad radiators will not do this. Grass, foliage, and other products of vegetation are in general good radiators. The vegetation, therefore, which covers the surface of the ground in an open country on a clear night will receive a deposition of moisture from the atmosphere; while the objects which are less perfect radiators, such as earth, stones, &c., do not in general receive such depositions. In the close and sheltered streets of cities, the deposition of dew is rarely observed, because there the objects are exposed to reciprocal radiation, and an interchange of heat takes place which maintains their temperature.

The effect of the radiation of foliage is strikingly manifested by the following example. Of two thermometers, one laid

among leaves and grass, and the other suspended at some height above them, the latter will be observed to fall at night many degrees below the former.

1578. *Dew not deposited under a clouded sky.*—In a cloudy night, dew is not deposited, because in this case, although vegetation radiates as perfectly as before, the clouds also radiate, and an interchange of heat takes place between them and the surface of the earth, by which the fall of temperature producing dew is prevented.

1579. *Production of artificial ice by radiation in hot climates.*—Artificial ice is sometimes produced in hot climates by the following process. A position is selected, not exposed to the radiation of surrounding objects, and a quantity of dry straw is spread on the ground, on which pans of porous earthenware are disposed in which the water to be cooled is placed. The water radiates heat to the firmament, and receives no heat in return. The straw upon which the vessels are placed, being a bad conductor, intercepts the heat, which would otherwise be imparted to the water in the vessels from the earth. The porous nature of the pans also allowing a portion of the water to penetrate them, produces a rapid evaporation, by which a considerable quantity of the heat of the water is carried off in a latent state by the vapour. Heat is thus dismissed at once by evaporation and radiation, and the temperature of the water in the pans is diminished until it attains the freezing point. In the morning the water is found frozen, and is collected and placed in cellars surrounded with straw or other bad conductor, which prevents its liquefaction.

## CHAP. XI.

### COMBUSTION.

1580. *Heat developed or absorbed in chemical combination.*—It has been already explained, that when two substances enter into chemical combination, so as to form a new compound, heat is generally either developed or absorbed, so that although the components before their union have the same temperature,

the temperature of the compound which results will be generally above or below this common temperature, and sometimes considerably so.

1581. *This effect explained by specific heat of compound being less or greater than that of components.*—If no change in the state of aggregation of the constituents is produced by their union, this phenomenon is explained by the specific heat of the compound being less or greater than that of the components, according as the temperature of the compound is greater or less than that of the components. If greater, it is because, the specific heat being less, the actual quantity of heat contained in the compound gives it a higher temperature; if less, because it gives it a lower temperature.

1582. *Or by heat being developed or absorbed by change of state.*—If the state of aggregation of either or both of the components be changed, heat which was latent becomes sensible, and raises the temperature of the compound; or heat which was sensible becomes latent, and lowers it. Thus when a solid mixed with a liquid is dissolved in it, the solid in liquefying absorbs and renders latent the same quantity of heat which would have been necessary to melt it. This heat being abstracted from the sensible heat of the compound lowers the temperature. This phenomenon has been already noticed in the case of freezing mixtures.

1583. *Combustion.*—But of all the cases in which heat is developed by chemical combination, the most important are those in which combustion is produced.

When the quantity of heat suddenly developed by the chemical combination of two bodies renders the compound luminous, the bodies are said to burn, and the phenomenon is called *combustion*. If the product of the combination be solid it is called *fire*; if gaseous, *flame*.

1584. *Flame.*—Flame, therefore, is gas rendered *white hot* by the excessive heat developed in the combination which produces it.

1585. *Agency of oxygen.*—It happens that, among the infinite variety of substances whose combination is productive of this class of phenomena, one of the two combining bodies is almost invariably oxygen gas. A few other substances, such as chlorine, bromine, and iodine, produce similar effects; but in all ordinary cases of combustion, and universally where that effect

is resorted to as a source of artificial heat, one of the combining substances is oxygen gas.

On this account this gas has been called a *supporter of combustion*.

1586. *Combustibles*.—The substances which combining with it produce the phenomenon of combustion are called *combustibles*.

1587. *Combustion explained*.—One of the circumstances which render combustion so ordinary a phenomenon, is the fact that the oxygen which forms one of the constituents of the atmosphere is either mechanically mixed in it, or, if chemically united, is held in combination by the weakest possible affinity. It therefore floats in the air in a state of almost complete freedom, ready to combine with any body for which it has the least affinity. When the temperature of a combustible, therefore, is so elevated as to weaken sufficiently its cohesion, its molecules enter into combination with the oxygen of the air, and heat and light, and all the effects of combustion, are manifested.

1588. *Temperature necessary to produce combustion*.—The temperature necessary to produce this combination is different for different substances; phosphorus combines with oxygen, and burns in the atmosphere if raised to 148°. Hydrogen gas will not burn till raised to incandescence. According to Sir H. Davy, the temperatures necessary to the combustion of the several combustibles here named are in the following order:—

- |                            |                           |
|----------------------------|---------------------------|
| 1. Phosphorus.             | 7. Sulphuretted hydrogen. |
| 2. Phosphoretted hydrogen. | 8. Alcohol.               |
| 3. Hydrogen and chlorine.  | 9. Wax.                   |
| 4. Sulphur.                | 10. Carbonic oxide.       |
| 5. Hydrogen and oxygen.    | 11. Carburetted hydrogen. |
| 6. Olefiant gas.           |                           |

The heat developed in the process of combustion is itself the means of sustaining and rendering continuous the combustion. If any source of heat of sufficient intensity be applied to the wick of a candle, the matter of the wick will combine with the oxygen of the air and will burn. The heat evolved in this combustion will dissolve the wax or tallow, which ascending through the meshes of the wick is converted into vapour, and being thus raised to the necessary temperature, enters into combustion; and so the process is continued so long as a supply of tallow or wax is conveyed to the wick.

1589. *Light of flame only superficial.*—It is evident the light of the flame is only superficial, that part alone being in combustion which is in contact with the air. The flame of a candle or lamp is therefore, so far as regards light, hollow. It is a column of gas with a luminous surface. As the gas within the surface rises, it gets into contact with the air and becomes luminous, and this continues until the column is brought to a point. Thus the flame of a candle or lamp gradually tapers until all the combustible vapour proceeding from the oil, wax, or tallow receives its due complement of oxygen from the air, and passes off. It speedily loses that high temperature which renders it luminous, and the flame terminates.

1590. *Illuminating power of combustibles.*—The light afforded by lamps or candles formed of different substances has different illuminating powers, according to the constituents of these substances and the heat developed in their combustion.

The light, however, is not proportional to the heat. Hydrogen gas, which develops in its combustion a very intense heat, produces but a feeble light.

1591. *Constituents of combustibles used for illumination.*—The chief constituents of the combustibles which are used for the purposes of illumination are carbon and hydrogen, and the whiteness of the flame is determined in a great degree by the proportion of carbon.

The combination in this case produces carbonic acid and water, the carbon combining with the oxygen to produce the former, and the hydrogen to produce the latter.

1592. *Spongy platinum rendered incandescent by hydrogen.*—If a jet of hydrogen gas be directed upon a small mass of spongy platinum, the metal will become incandescent, and will continue so as long as the gas acts upon it, without, however, suffering any permanent change.

An apparatus for producing an instantaneous light has been contrived on this principle. By turning a stop-cock communicating with a small bottle in which the gas is generated in the usual way, the jet of gas is thrown upon a small cup containing the spongy metal, which immediately becoming incandescent, is capable of lighting a match.

Some other metals, palladium, iridium, and rhodium, are susceptible of the same effect.

This effect has not been yet explained in a clear or satis-



factory manner. See Turner's Chemistry, by Liebig and Gregory, 8th edit. p. 542.

1593. *Quantity of heat developed by combustibles.*—The determination of the quantity of heat evolved by different combustibles, is a question not only of great scientific interest, but of considerable importance in the arts and manufactures. The mutual relation between the quantities of the combustible, the oxygen, and the heat developed, if accurately ascertained, could not fail to throw light, not only on the theory of combustion, but on the physics of heat in general. In the arts and manufactures, the due selection of combustible matter depends in a great degree upon the quantity of heat developed by a given weight in the process of combustion.

Nevertheless, there is no part of experimental physics in which less real progress has been made, and in which the process of investigation is attended with greater difficulties. Experiments were made on certain combustibles by Lavoisier and Laplace, by burning them in their calorimeter, and observing the quantity of ice dissolved by the heat which they evolved. Drs. Dalton and Crawford, Count Rumford and Despretz, as well as Sir H. Davy, made various experiments with a like object. It was not, however, until the subject was taken up by Dulong that any considerable progress in discovery was made. Unhappily, that eminent experimental inquirer died before his researches were completed. Much valuable information has been collected from his unfinished memoranda. The inquiry has since been resumed by MM. Favre and Silbermann, and has been prosecuted with much zeal and success. The estimates which they have obtained of the quantities of heat developed in the combustion of various substances, are found to be in general accordance with those which appear to have been obtained by Dulong, in the cases where they have operated on the same combustible. Thus, in the case of hydrogen, the most important of the substances under inquiry, Dulong found the heat developed to be expressed by 34601, while MM. Favre and Silbermann estimated it at 34462, with relation to the same thermal unit.

1594. *Table of the quantities of heat evolved in the combustion of various bodies.*—In the following table is given the heat developed in the combustions of the substances named in the first column; the thermal unit being the heat necessary to raise

a weight of water equal to that of the combustible one degree of the scale of Fahrenheit's thermometer.

Names of Substances.	Formule.	Quantity of Heat given by 1° of Combustion.
Hydrogen, at 15°	-	62,031·6
Carbon, from C to CO <sup>2</sup>	-	14,544·7
„ from sugar, from C to CO <sup>2</sup>	-	14,471·6
„ from gas retorts	-	14,485·1
Graphite, natural, No. 1.	-	14,060·7
„ from high mines, No. 1.	-	14,013·5
„ natural, No. 2.	-	14,006·7
Diamond	-	13,986·2
Graphite, from high mines, No. 2.	-	13,926·8
Diamond, heated	-	14,181·7
Oxide, from carbon, at CO <sup>2</sup>	-	4,324·9
Gas, marsh	C <sup>2</sup> H <sup>4</sup>	23,513·4
„ olefiant	C <sup>4</sup> H <sup>4</sup>	21,341·0
Paramylene	C <sup>10</sup> H <sup>10</sup>	20,683·8
Amylene	C <sup>20</sup> H <sup>20</sup>	20,346·3
„	C <sup>22</sup> H <sup>22</sup>	20,278·8
Cetine	C <sup>32</sup> H <sup>32</sup>	19,941·3
Metamyline	C <sup>40</sup> H <sup>40</sup>	19,671·3
Ether, sulphuric	HO <sup>2</sup> +C <sup>8</sup> H <sup>8</sup>	16,248·6
„ valeric	HO <sup>2</sup> +C <sup>20</sup> H <sup>20</sup>	18,338·4
Spirit of wood	HO <sup>2</sup> +C <sup>2</sup> H <sup>2</sup>	9,542·7
Alcohol	HO <sup>2</sup> +C <sup>4</sup> H <sup>4</sup>	12,931·2
„ valeric	HO <sup>2</sup> +C <sup>10</sup> H <sup>10</sup>	16,125·5
„ ethalic	HO <sup>2</sup> +C <sup>32</sup> H <sup>32</sup>	19,132·6
Acetone	C <sup>6</sup> H <sup>6</sup> +O <sup>2</sup>	13,149·0
Aldehyde, ethalic	C <sup>32</sup> H <sup>32</sup> O <sup>2</sup>	18,616·0
„ stearic	C <sup>38</sup> H <sup>38</sup> O <sup>2</sup>	18,892·8
Formiate of methylene	C <sup>4</sup> H <sup>1</sup> O <sup>4</sup>	7,555·3
Acetate „	C <sup>6</sup> H <sup>6</sup> O <sup>4</sup>	9,615·6
Formiate of alcohol	C <sup>6</sup> H <sup>6</sup> O <sup>4</sup>	9,502·2
Ether, acetic	C <sup>8</sup> H <sup>8</sup> O <sup>4</sup>	11,326·9
Butyrate of methylene	C <sup>50</sup> H <sup>10</sup> O <sup>4</sup>	12,237·3
Ether, butyric	C <sup>12</sup> H <sup>12</sup> O <sup>4</sup>	12,763·6
Valeriate of methylene	C <sup>14</sup> H <sup>14</sup> O <sup>4</sup>	13,276·1
„ alcohol	C <sup>11</sup> H <sup>14</sup> O <sup>4</sup>	14,102·8
Acetate of alcohol, valeric	C <sup>20</sup> H <sup>20</sup> O <sup>4</sup>	14,348·2
Ether, valaramilic	C <sup>20</sup> H <sup>20</sup> O <sup>4</sup>	15,378·5
Acid, formic	O <sup>4</sup> +C <sup>2</sup> H <sup>2</sup>	3,600·0
„ acetic	O <sup>4</sup> +C <sup>4</sup> H <sup>4</sup>	6,309·4
„ butyric	O <sup>4</sup> +C <sup>8</sup> H <sup>8</sup>	10,121·4
„ valeric	O <sup>4</sup> +C <sup>10</sup> H <sup>10</sup>	11,590·2
„ ethalic	O <sup>4</sup> +C <sup>32</sup> H <sup>32</sup>	16,956·0
„ stearic	O <sup>4</sup> +C <sup>38</sup> H <sup>38</sup>	17,676·0
„ phunic	C <sup>12</sup> H <sup>6</sup> O <sup>8</sup>	14,116·1
Terebene-	C <sup>20</sup> H <sup>16</sup>	19,193·4
Essence of turpentine	C <sup>20</sup> H <sup>16</sup>	19,533·6
„ citron	C <sup>20</sup> H <sup>16</sup>	19,726·2
Sulphur, native melted	-	3,968·0
„ at instant of crystallization	-	4,065·1
„ of carbon	-	6,120·9
Carbon burnt with peroxide of azote at 10°	-	20,084·2
Decomposition of peroxide of azote	-	19,962·9
„ „ water oxygenated, 1° oxygen	-	2,345·4
Decomposition of oxide of silver absorbs	-	- 39·8
Iceland spar for CO <sup>2</sup> and C to O, absorbs	-	- 554·6
Aragonite combined gives	-	+ 68·9
„ separated absorbs	-	- 554·6
„ separated after combination absorbs	-	- 483·6

## CHAP. XII.

## ANIMAL HEAT.

1595. *Temperature of organized bodies not in equilibrium with surrounding medium.*—Organized bodies in general present a striking exception to the law of equalization of temperature, since, with some rare exceptions, these bodies are never at the temperature of the medium which surrounds them. The human body, as is well known, has a permanent and invariable temperature much more elevated than that of the atmosphere. The animals of the polar regions are much warmer than the ice upon which they rest, and those which inhabit tropical climates colder in general than the air they respire. The temperature of the bodies of birds is not that of the atmosphere, nor of fishes that of the sea.

There is therefore, in organized bodies, some proper source of heat, or rather some provision by which heat and cold can be produced at need; for the ponderable matter which composes the bodies of these creatures must, like all ponderable matter, be subject to the general law of equilibrium of temperature. It is therefore necessary to ascertain what is the temperature of organized creatures; what are the quantities of heat which they evolve in a given time to maintain this temperature; and what is the physical apparatus by which that heat is elaborated.

1596. *Temperature of the blood in the human species.*—The temperature of the blood in the human species is found to be the same throughout the whole extent of the body, and is that which is indicated by a thermometer, whose bulb is placed under the tongue and held there until the mercurial column becomes stationary. This temperature is  $98^{\circ}6$ , subject to extremely small variations, depending on health, age, and climate.

1597. *Researches of Davy to determine the temperature of the blood.*—Dr. John Davy, Inspector of Army Hospitals, availed himself of the opportunities presented by his professional appointment, and of a voyage made by him to the East, to make an extensive and valuable series of observations on the temperature of the blood in man, in different climates, at different

ages, and among different races, as well as upon the inferior animals. These observations were made between 1816 and 1820.

The first series of observations were made during a voyage from England to Ceylon, and, therefore, under exposure to very various climates and temperatures. The temperature of the blood was observed by means of a sensitive thermometer applied under the tongue near its root, with every precaution necessary to ensure accuracy. The principal results obtained are collected and arranged in the following tables:—

TABLE I.

1598. *Showing the Temperatures of the Blood of 13 Individuals in different Climates.*

Age.	Air, 60°.	Air, 78°.	Air, 79°50°.	Air, 80°.
24	98·5	99	100	99·5
28	—	99·5	99·5	99·5
25	98·25	98·75	98·5	99·75
17	—	99	99	100
25	98	99	99	99·5
20	98·75	98	99·5	100
28	98·25	98·75	99	99·5
25	98	—	—	101
40	—	—	—	99·75
43	—	—	—	99
40	—	—	—	99·5
13	—	—	—	100
4	—	—	—	99·5

TABLE II.

*Showing the Temperatures of the Blood of 6 Individuals in different Climates.*

Age.	Air, 69°.	Air, 85°.	Air, 82°.	Air, 84°.
35	98	99	102	98·5
20	98	99	101	98
40	99	99	98·5	98
35	98	99·75	99	98
20	98	99·5	99	—
24	98	99·5	100	—

TABLE III.

*Showing the Temperatures of the Blood in the same Individual at different Hours of the Day.*

Hour.	Air.	Blood.	Sensation.
6 A. M.	60·5	98	Cool.
9	66	97·5	Cold.
1 P. M.	78	98·5	Cool.
4	79	98·5	Warm.
6	71	99	Warm.
11	69	98	Cool.

TABLE IV.

*Showing the Limits between which the Temperature of the Blood in different Races was observed to vary in India. Air, 75° to 81°.*

Races.	Temperature.	Races.	Temperature.
Cape Hottentots - -	96·5 to 99·5	Valdas - - -	98 to 98·5
Singalese - - -	100 101·5	African Negroes - -	98·5 99·5
Albinoes - - -	101 101·75	Malays - - -	98·5 99·5
Half caste - - -	100 102	Sepoys - - -	98 100
White Children - -	101 102	English - - -	98 101
Kandians - - -	97·5 99		

TABLE V.

*Showing the Temperature of the Blood observed in different Species of Animals.*

Name.	Air.	Temperature.	Place of Observation.
<i>Mammalia.</i>			
Monkey - - -	86°	104½	Colombo.
Pangolin - - -	80	90	—
Bat - - -	82	100	—
Vampyre - - -	70	100	—
Squirrel - - -	81	102	—
Rat - - -	80	102	—
Guinea-pig - - -	—	102	Chatham.
Hare - - -	80	100	Colombo.
Ichneumon - - -	81	103	—
Jungle cat - - -	80	99	—
Cur dog - - -	—	103	Kandy.
Jackal - - -	84	101	Colombo.
Cat - - -	60	101	London.
" - - -	79	102	Kandy.
Felix pardus - - -	81	102	Colombo.
Horse - - -	80	99·5	Kandy.
Sheep - - -	—	101 to 104	Scotland.
" - - -	67	103 to 104	Cape.
" - - -	78	104 to 105	Colombo.
Goat - - -	78	103 to 104	Colombo.
Ox - - -	Summer.	100	Edinburgh.
" - - -	80	102	Kandy.
Elk - - -	78	103	Mount Lavinia.
Hog - - -	75	105	Doombera.
" - - -	80	105	Mount Lavinia.
Elephant - - -	80	99·5	Colombo.
Porpoise - - -	72	100	Lat. N. 8° 23' at sea.
<i>Birds.</i>			
Falcon - - -	77·5	99	Colombo.
Screech-owl - - -	60	106	London.
Jackdaw - - -	85	107	Kandia.
Thrush - - -	60	119	London.
Sparrow - - -	80	108	Kandia.
Pigeon - - -	60	108	London.
" - - -	78	109·5	Mount Lavinia.
Jungle fowl - - -	78	107·5	Ceylon.
" - - -	83	108·5	—
Common fowl - - -	40	108·5	Edinburgh.
" - - -	78	110	Mount Lavinia.
" - - -	—	108	—
Guinea fowl - - -	—	110	—
Turkey - - -	—	109	—
Procellarea equinoxiale - - -	79	103·5 to 105·5	Lat. 2° 3'.

Name.	Air.	Temperature.	Place of Observation.
<i>P. capensis</i> - - - -	59	105.5	Lat. S. 34° 1' at sea.
Common hen - - - -	77	110	Mount Lavinia.
" cock - - - -	77	111	—
Chicken - - - -	77	111	—
Malay cock - - - -	—	110	—
Goose - - - -	—	106 to 107	—
Duck - - - -	—	110—111	—
Teal - - - -	—	108—109½	—
Snipe - - - -	83	98	Colombo.
Plover - - - -	—	105	Ceylon.
Peacock - - - -	83	105—108	Kornegalle.
<i>Amphibia.</i>			
Testudo midas - - - -	79.5	84	Lat. N. 2° 7'.
" - - - -	80	88.5	—
" - - - -	86	85	Colombo.
T. geometrica - - - -	61	62.5	Cape.
" - - - -	80	87	Colombo.
Rana ventricosa - - - -	80	77	Kandy.
Common frog - - - -	60	64	Edinburgh.
Iguana - - - -	82	82½	Colombo.
Serpents - - - -	81½	84½	—
" - - - -	82½	84½	—
<i>Fishes.</i>			
Shark - - - -	71½	77	Lat. S. 8° 23'.
Bonito - - - -	78	82*	Lat. S. 1° 14'.
Trout - - - -	56	58	Edinburgh.
" - - - -	56	58	L. Katrine.
Eel - - - -	51	51	Chatham.
Flying-fish - - - -	77	78	Lat. N. 6° 57'.
<i>Mollusca.</i>			
Oyster - - - -	82	82	Mount Lavinia.
Snail - - - -	76½	76 to 76½	Kandy.
<i>Crustacea.</i>			
Crayfish - - - -	80	79	Colombo.
Crab - - - -	72	72	Kandy.
<i>Insects.</i>			
Scarabæus pilularius - - - -	76	77	Kandy.
Glow-worm - - - -	73	74	—
Blatta orientalis - - - -	83	74—75	—
Gryllus hæmatopus ? - - - -	62	72½	Cape.
Apis ichneumonia ? - - - -	75	75	Kandy.
Papilio aganemnon - - - -	78	80	—
Scorpio ater - - - -	79	77½	—
Julus - - - -	80	78½	—

1599. *Deductions from these observations.*—The conclusions deduced from these observations and experiments are, that the temperature of man, although nearly constant, is not exactly so; that it is slightly augmented with the increased temperature of the climate to which the individual is exposed; that the temperature of the inhabitants of a warm climate is higher than those of a mild; and that the temperature of the different races of mankind is, *cæteris paribus*, nearly the same. This is the more remarkable, inasmuch as among those whose temperatures thus agree, there is scarcely any condition in common

\* This was the temperature of the heart, which lies near the surface. In the deeply-seated muscles the temperature was 99°.

except the air they breathe. Some, such as the Vaida, live almost exclusively on animal food; others, as the priests of Boodho, exclusively on vegetables; and others, as Europeans and Africans, on both.

1600. *Birds have the highest, and amphibia the lowest temperature.*—Of all animals birds have the highest temperature; mammalia come next; then amphibia, fishes, and certain insects. Mollusca, crustacea, and worms stand lowest in the scale of temperature.

1601. *Experiments of Breschet and Becquerel.*—Experiments were made by MM. Breschet and Becquerel to ascertain the variation of the temperature of the human body in a state of health and sickness. They employed for this purpose compound thermoscopic needles, composed of two different metals, which, being exposed to a change of temperature, indicated with great sensitiveness the sensible heat by which they were affected, by means of a galvanometer on a principle similar to the electroscopic apparatus used by M. Melloni, already described, (1564). The needles were adapted for use by the method of acupuncture.

1602. *Comparative temperature of blood in health and sickness.*—It was found that in a state of fever, the general temperature of the body sometimes rose from  $1^{\circ}8$  to  $3^{\circ}6$ .

It was also ascertained in several cases of local chronic and accidental inflammation, that the temperature of the inflamed part was a little higher than the general temperature of the body, the excess however never amounting to more than from  $1^{\circ}8$  to  $3^{\circ}6$ .

1603. *Other experiments by Breschet and Becquerel.*—It resulted from these researches that, in the dog, the arterial blood exceeds in temperature the venous by about  $1^{\circ}8$ . It was also found that the temperature of the bodies of the inhabitants of the valley of the Rhone and those of the Great St. Bernard, both men and inferior animals, were the same.

1604. *Experiments to ascertain the rate of development of animal heat.*—A series of experiments was made by Lavoisier and Laplace to determine, by means of their calorimeter already described, the quantity of heat developed in a given time by various animals; but more recently much more extensive researches in this department were made by Dulong, which have produced important results. In these experiments the animal

under examination was shut up in a copper cage sufficiently capacious to be left at ease, and being submerged in a glass vessel of water, the air necessary for respiration was supplied and measured by a gasometer, while the products of respiration were carried away through the water, to which they imparted their heat, and were afterwards collected and analyzed. Each experiment was continued for two hours. After the proper corrections had been applied, the heat developed by the animal was calculated by the heat imparted to the water.

Dulong determined these thermal quantities with great precision for numerous animals of different species, young and adult, carnivorous and frugivorous. The animals during the experiment being subject neither to inconvenience nor fatigue, it might be assumed the heat they lost was equal to that which they reproduced. On analyzing the products of respiration it was found that they were changed as air is which has undergone combustion. The oxygen of the atmospheric air which was introduced into the cage was in fact combined with carbon and formed carbonic acid. So far, therefore, as concerned this point, a real combustion may be considered as having taken place in the lungs. Thus much was inferred in general as to the source of animal heat from the discoveries of Lavoisier.

1605. *Total quantity of heat explained by chemical laws without any especial vital cause.*—It remained, however, to verify this discovery by showing that the exact quantity of heat evolved in the animal system could be accounted for by the chemical phenomena manifested in respiration; and this Dulong accomplished.

After having determined the quantity of heat lost by the animal, he calculated the quantity of heat produced by respiration. The air which was furnished to the animal was measured by the gasometer, and the changes which it suffered were taken into account by analyzing the products of combustion discharged through the water from the cage. These products were as follows :

1. The vapour of water.
2. Carbonic acid.
3. Azote.

The vapour of water analyzed gave a certain quantity of oxygen and hydrogen, the carbonic acid a certain quantity of



carbon and oxygen, and the azote was sensibly equal to the quantity of that gas contained in the atmospheric air supplied to the animal. It followed that the oxygen of the atmospheric air which had been supplied combined in the lungs partly with carbon and partly with hydrogen, producing by respiration carbonic acid and the vapour of the water, being exactly the products resulting from the combustion of a lamp or candle. Now the quantity of heat produced by the combustion of given quantities of carbon and hydrogen being taken and compared with the quantity of animal heat developed, as given by the heat imparted to the water, was found exactly to correspond; and thus it followed that the source of animal heat is the same as the source of heat in the common process of combustion.

When these researches were first made, it appeared that the quantity of heat actually developed in the animal system exceeded the quantity computed to result from the chemical change which the air suffered in respiration, and it was consequently inferred that the balance was due to a certain nervous energy or original source of heat existing in the animal organization independently of the common laws of physics. Dulong, however, had the sagacity to perceive that the phenomenon admitted of a more satisfactory and simple explanation, and succeeded at length in showing that the difference which had appeared between the quantity of heat developed in respiration, and the quantity due to the chemical changes which the air suffered in this process, was accounted for by the fact that the quantity of heat developed in the combustion of hydrogen and oxygen had been under-estimated, and that when the correct coefficient was applied, the quantity of heat due to chemical changes suffered by the air in respiration was exactly equal to the quantity of heat developed in the animal system.

## CHAP. XIII.

### THE SENSATION OF HEAT.

1606. *Indications of the senses fallacious.*—The senses, though appealed to by the whole world as the most unerring witnesses of the physical qualities of bodies, are found, when submitted

to the severe scrutiny of the understanding, not only not the best sources of exact information as to the qualities or degrees of the physical principles by which they are severally affected, but the most fallible guides that can be selected, often informing us of a quality which is absent, and of the absence of one which is present.

Nor should this be any matter of surprise. Our Maker in giving us organs of sense did not design to supply us with philosophical instruments. The eye, the ear, and the touch, though admirably adapted to serve our purposes, are not severally a telescope, a monochord, and a thermometer. An eye which would enable us to see the inhabitants of a planet, would ill requite its owner for that ruder power which guides him through the town he inhabits, and enables him to recognize the friends who surround him. The comparison of the instruments which are adapted for the uses of commerce and domestic economy with those destined for scientific purposes supply an appropriate illustration of these views. The delicate balance used by the chemist in determining the analysis of the bodies upon which he is engaged would, by reason of its very perfection and sensibility, be utterly useless in the hands of the merchant or the housewife. Each class of instruments has, however, its peculiar use, and is adapted to give indications with that degree of accuracy which is necessary, and required for the purposes to which it is applied.

1607. *Sense of touch a fallacious measure of heat.*—The touch is the sense by which we acquire a perception of heat. It is evident, nevertheless, that it cannot inform us of the quantity of heat which a body contains, much less of the relative quantities contained in any two bodies. In the first place, the touch is not affected by heat which exists in the latent state. Ice-cold water and ice itself have the same degree of cold to the touch, and yet it has been proved that the former contains  $140^{\circ}$  of heat more than the latter.

1608. *Its indications contradictory.*—But it may be said that even the thermometer does not in this case indicate the presence of the excess of heat in the liquid. The sense of feeling will however be found almost as fallacious as regards the temperature of bodies; for it is easy to show that the sense of warmth depends as much upon the condition of the part of the

body which touches or is surrounded by the warm or cold medium, as on the temperature of that medium itself.

If the two hands be plunged, one in water at the temperature of  $200^{\circ}$  and the other in snow, and being held there for a certain time are transferred to water of the intermediate temperature of  $100^{\circ}$ , this water will appear warm to one hand and cold to the other; warm to the hand which had been plunged in the snow, and cold to the hand which had been plunged in the water at  $200^{\circ}$ .

If on a hot day in summer we descend into a deep cave, it will feel cold; if we descend into the same deep cave on a frosty day in winter, it will feel warm; yet a thermometer in this case will prove that in the winter and in the summer it has exactly the same temperature.

1609. *These contradictions explained.*—These apparent anomalies are easily explained. The sensation of heat is relative. When the body has been exposed to a high temperature, a medium which has a lower temperature will feel cold, and when it has been exposed to a low temperature it will feel warm.

If in a room raised to a high temperature, as in a vapour or hot-air bath, we touch with the hand different objects, they will appear to have very different temperatures; a woollen carpet will feel cold, marble slabs warm, and metal objects very hot. If, on the other hand, we are in a room at a very low temperature, all these properties will be reversed; the carpet will feel warm, the marble slabs cold, and the metallic objects colder still.

These effects are easily explained. A woollen carpet is a non-conductor of heat. When surrounding objects are at a more elevated temperature than that of the body, the woollen carpet partaking in this temperature will when touched feel cool, because, being a non-conductor of heat, the heat which pervades it does not pass freely to the part of the body which touches it. A marble slab being a better conductor, and a metallic object a still better, the heat will pass from them more freely to the part of the body which touches them, and they accordingly appear hotter.

But if the room be at a temperature much lower than the body, then when we touch the woollen carpet the heat does not pass from our body to the carpet because it is a non-conductor, and as we do not lose heat the carpet feels warm; but when

we touch the marble, and still more a metallic object, the heat passes more and more freely from our body to these objects, and being sensible of a loss of heat more or less rapid, we feel cold.

1610. *Examples of the fallacious impressions produced by objects on the touch.*—When we plunge in a cold bath, we are accustomed to imagine that the water is colder than the air and surrounding objects; but if a thermometer be immersed in the water, and another suspended in the air, they will indicate the same temperature. The apparent cold of the water arises from the fact that it abstracts from our bodies heat more rapidly than air does, being a denser fluid and a greater number of particles of it coming into contact at once with the surface of the body. A linen feels colder than a cotton, and a cotton colder than a flannel shirt, yet all the three are at exactly the same temperature. Linen is a better conductor of heat than cotton, and cotton than flannel, and, consequently, the heat passes more freely through the first than the second, and through the second than the third.

The sheets of a bed feel cold, and the blankets warm, and yet they are of the same temperature,—a fact which is explained in the same manner.

The air which is impelled against a lady's face by her fan feels cold, while the same air at rest around her feels warm; yet it is certain that the temperature of the air is not lowered by being put in motion. The apparent coolness is explained in this case by a slight evaporation, which is effected upon the skin by the motion given to the air by the fan.

1611. *Feats of fire-eaters explained.*—Some of the feats performed by quacks and fire-eaters in exposing their bodies to fierce temperatures may be easily explained upon this principle. When a man goes into an oven raised to a very high temperature, he takes care to place under his feet a cloth or mat made of wool or other non-conducting substance upon which he may stand with impunity at the proposed temperature. His body is surrounded with air raised it is true to a very high temperature, but the extreme tenuity of this fluid causes all that portion of it in contact with the body at any given time to produce but a slight effect in communicating heat. The exhibitor always takes care to be out of contact with any good conducting substance, and when he exhibits the effect produced by

the oven in which he is enclosed upon other objects, he takes as much care to place them in a situation very different from that which he himself has occupied. He exposes them to the effect of metal or other good conductors.

Meat has been exhibited dressed in the apartment with the exhibitor. A metal surface is in this case provided, and probably raised to a much higher temperature than the atmosphere in which the exhibitor is placed.

## BOOK THE SECOND.

## MAGNETISM.

## CHAP. I.

## DEFINITIONS AND PRIMARY PHENOMENA.

1612. *Natural magnets — Loadstone.* — Certain ferruginous mineral ores are found in various countries, which being brought into proximity with iron manifest an attraction for it. These are called NATURAL MAGNETS OR LOADSTONES; the former term being derived from MAGNESIA, a city of Lydia, in Asia Minor, where the Greeks first discovered and observed the properties of these minerals.

1613. *Artificial magnets.* — The same property may be imparted to any mass of iron having any desired magnitude or form, by processes which will be explained hereafter. Such pieces of iron having thus acquired these properties are called ARTIFICIAL MAGNETS; and it is with these chiefly that scientific experiments are made, since they can be produced in unlimited quantity of any desired form and magnitude, and having the magnetic virtue within practical limits in any desired degree.

1614. *Neutral line or equator — Poles.* — This attractive power, which constitutes the peculiar character of the magnet, whether natural or artificial, is not diffused uniformly over every part of its surface. It is found to exist in some parts with much greater force than in others, and on a magnet a certain line is found where it disappears. This line divides the magnet into two parts or regions, in which the attractive power prevails in varying degrees, its energy augmenting with the distance from the neutral line just mentioned.

This neutral line thus dividing the magnet into two different regions of attraction may be called the EQUATOR of the magnet.

The two regions of attraction separated by the equator are called the poles of the magnet.

Sometimes this term *pole* is applied, not generally to the two parts into which the magnet is divided by the equator, but to two points upon or within them, which are the centres of all the magnetic attractions exercised by the surface, in the same manner as the centre of gravity is the centre of all the gravitating forces which act upon the particles of a body.

1615. *Experimental illustration of them.*— The neutral line and the varying attraction of the parts of the surface of the magnet which it separates may be manifested experimentally as follows. Let a magnet, whether natural or artificial, be rolled in a mass of fine iron filings. They will adhere to it, and will collect in two tufts on its surface, separated by a space upon which no filings will appear. The thickness with which the filings are collected will increase as the distance from the space which is free from them is augmented.

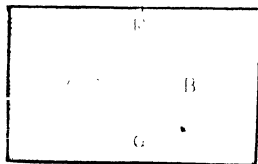

Fig. 456.

being represented by EQ, and the poles by A and B.

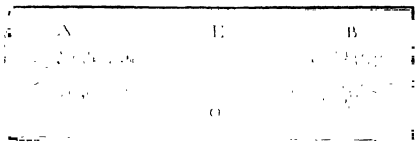

Fig. 457.

1616. *Experimental illustration of the distribution of the magnetic force.*— The variation of the attraction of different parts of the magnet may also be illustrated as follows. Let a magnet, whether natural or artificial, be placed under a plate of glass or a sheet of paper, and let iron filings be scattered on the paper or glass over the magnet by means of a sieve, the paper or glass being gently agitated so as to give free motion to the particles.

They will be observed to affect a peculiar arrangement corresponding with and indicating the neutral line or equator and the poles of the magnet as represented in *fig. 458.*, where EQ is the equator, and A and B the poles of the magnet.

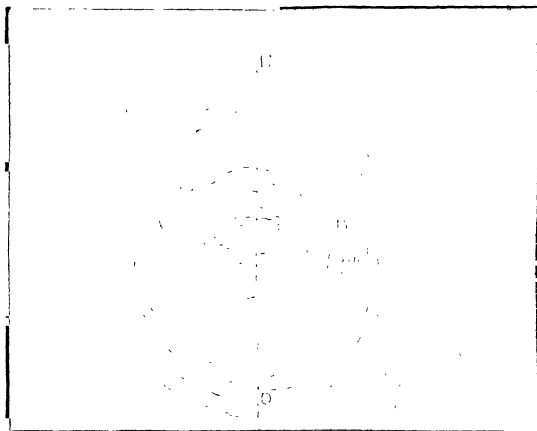

Fig. 458.

1617. *Varying intensity of magnetic force indicated by a pendulum.*—The varying intensity of the attraction of different parts of the surface of the magnet may be ascertained by presenting such surface to a small ball of iron suspended by a fibre of silk so as to form a pendulum. The attraction of the surface will draw this ball out of the perpendicular to an extent greater or less, according to the energy of the attraction. If the equator of the magnet be presented to it, no attraction will be manifested, and the force of the attraction indicated will be augmented according as the point presented to the pendulum is more distant from the equator and nearer to the pole.

1618. *Curve representing the varying intensity.*—This varying distribution of the attractive force over the surface of a magnet may be represented by a curve whose distance from the magnet varies proportionally to the intensity of this force. Thus if, in *fig. 459.*, EQ be the equator and A and B the poles of the magnet, the curve ECDF may be imagined to be drawn in such a manner that the distance of its several parts from the bar EB shall be everywhere proportional to the intensity of the



attractive force of the one pole, and a similar curve  $EC'D'F'$  will in like manner be proportional to the varying attractions

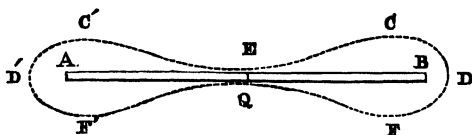

Fig. 459.

of the several parts of the other pole. These curves necessarily touch the magnet at the equator  $EQ$ , where the attraction is nothing, and they recede from it more and more as their distance from the equator increases.

1619. *Magnetic attraction and repulsion.*— If two magnets, being so placed as to have free motion, be presented to each other, they will exhibit either mutual attraction or mutual repulsion, according to the parts of their surfaces which are brought into proximity. Let  $E$  and  $E'$ , *fig. 460.*, be two magnets,

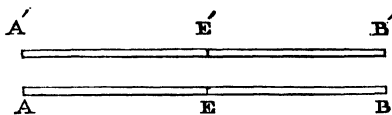

Fig. 460.

their poles being respectively  $AB$  and  $A'B'$ . Let the two poles of each of these be successively presented to the same pole of a third magnet. It will be found that one will be attracted and the other repelled. Thus, the poles  $A$  and  $A'$  will be both attracted, and the poles  $B$  and  $B'$  will be both repelled by the pole of the third magnet, to which they are successively presented.

1620. *Like poles repel, unlike attract.*— The poles  $A$  and  $A'$ , which are both attracted, and the poles  $B$  and  $B'$ , which are both repelled by the same pole of a third magnet, are said to be *like poles*; and the poles  $A$  and  $B'$ , and  $B$  and  $A'$ , one of which is attracted and the other repelled by the same pole of a third magnet, are said to be *unlike poles*.

Thus the two poles of the same magnet are always unlike poles, since one is always attracted, and the other repelled by the same pole of any magnet to which they are successively presented.

If two like poles of two magnets, such as A and A' or B and B', be presented to each other, they will be mutually repelled; and if two unlike poles, as A and B' or B and A', be presented to each other, they will be mutually attracted.

Thus it is a general law of magnetic force, that like poles mutually repel and unlike poles mutually attract.

1621. *Magnets arrange themselves mutually parallel with poles reversed.*—If a magnet AB be placed in a fixed position on a horizontal plane, and another magnet be suspended freely at its equator E' by a fibre of untwisted silk, the point of suspension being brought so as to be vertical over the equator E of the fixed magnet, the magnet suspended being thus free to revolve round its equator E' in a horizontal plane, it will so revolve, and will oscillate until at length it comes to rest in a position parallel to the fixed magnet AB; the like poles, however, being in contrary directions, that is to say, the pole A' which is similar to A being over B, and the pole B' which is similar to B being over A. This phenomenon follows obviously from what has been just explained; for if the magnet A' B' be turned to any other direction, the arm EB attracting the unlike arm E' A', and at the same time the arm EA attracting the unlike arm E' B', the suspended magnet A' B' will be under the operation of forces which have been already described (160), and which are called a *couple*, consisting of two equal and contrary forces whose combined effect is to turn the magnet round E' as a centre. When, however, the magnet A' B' ranges itself parallel to AB, the like poles being in contrary directions, the forces exerted balance each other, since the pole A attracts B' as much as the pole B attracts A'.

1622. *Magnetic axis.*—It has been already stated that certain points within the two parts into which a magnet is divided by the equator, which are the centres of magnetic force, are the magnetic poles. A straight line joining these two points is called the *magnetic axis*.

1623. *How ascertained experimentally.*—If a magnet have a symmetrical form, and the magnetic force be uniformly diffused through it, its magnetic axis will coincide with the geometrical axis of its figure. Thus, for example, if a cylindrical rod be uniformly magnetized, its magnetic axis will be the axis of the cylinder; but this regular position of the magnetic axis does not always prevail, and as its direction is of considerable im-

portance, it is necessary that its position may in all cases be determined. This may be done by the following expedient:—

Let the magnet, the direction of whose axis it is required to ascertain, be suspended as already described, with its equator exactly over that of a fixed magnet resting upon a horizontal plane. The suspended magnet will then settle itself into such a position that its magnetic axis will be parallel to the magnetic axis of the fixed magnet which is under it. Its position when thus in equilibrium being observed, let it be reversed in the stirrup, so that without changing the position of its poles, its under side shall be turned upwards, and *vice versa*. If after this change the direction of the bar remains unaltered, its magnetic axis will coincide with its geometrical axis; but if, as will generally happen, it take a different direction after being reversed, then the true direction of the magnetic axis will be intermediate between its directions before and after reversion.

To render this more clear, let  $AB$ , *fig. 461.*, be the geometrical axis of a regularly shaped prismatic magnet, and let it be required to discover the direction of its magnetic axis. Let  $ab$  be the poles, and the line  $MN$  passing through them therefore its magnetic axis.

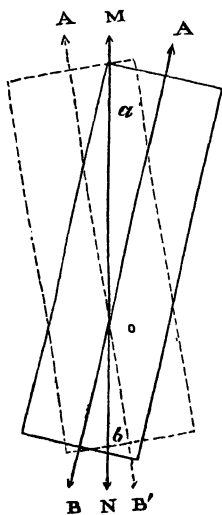

Fig. 461.

and, consequently, the magnetic axis  $MN$  will bisect the angle  $A o A'$ , formed by the geometric axis of the magnet in its second position.

1624. *Hypothesis of two fluids, boreal and austral.*—These various phenomena of attraction and repulsion, with others which will presently be stated, have been explained by different suppositions, one of which assumes that all bodies susceptible of magnetism are pervaded by a subtle imponderable fluid, which is compound, consisting of two constituents called, for reasons which will hereafter appear, the *austral fluid* and the *boreal fluid*. Each of these is self-repulsive; but they are reciprocally attractive, that is to say, the austral fluid repels the austral, and the boreal the boreal; but the austral and boreal fluids reciprocally attract.

1625. *Condition of the natural or unmagnetized state.*—When a body pervaded by the compound fluid is in its natural state and not magnetic, the two fluids are in a state of combination, each molecule of the one being combined by attraction with a molecule of the other; consequently, in such state, neither attraction nor repulsion is exercised, inasmuch as whatever is attracted by a molecule of the one is repelled by a molecule of the other which is combined with it.

1626. *Condition of the magnetized state.*—When a body is magnetic, and manifests the powers of attraction and repulsion such as have been described, the magnetic fluid which pervades it is decomposed, the austral fluid being directed on one side of the equator, and the boreal fluid on the other. That side of the equator towards which the austral fluid is directed is the *austral*, and that towards which the boreal fluid is directed is the *boreal pole* of the magnet.

If the austral poles of two magnets be presented to each other, they will mutually repel, in consequence of the mutual repulsion of the fluids which predominate in them; and the same effect will take place if the boreal poles be presented to each other. If the austral pole of the one magnet be presented to the boreal pole of another, mutual attraction will take place, because the austral and boreal fluids, though separately self-repulsive, are reciprocally attractive.

It is in this manner that the hypothesis of two self-repulsive and mutually attractive fluids supplies an explanation of the general magnetic law, that like poles repel and unlike poles attract.

It must be observed that the attraction and repulsion in this hypothesis are imputed not to the matter composing the mag-

netic body, but to the hypothetical fluids by which this matter is supposed to be pervaded.

1627. *Coercive force*.—The force with which the particles of the austral and boreal fluids are combined, varies in different bodies, in some being so slight that their decomposition is readily effected, in others being so energetic that it is only accomplished with considerable difficulty. It is found that in bodies where the decomposition of the magnetic fluids is resisted, its recombination is also resisted, and that where the fluids are separated with difficulty, when once separated they are recombined with difficulty.

This force, by which the decomposition and recombination of the constituents of the magnetic fluid are resisted, is called the coercive force.

A different and more probable hypothesis for the explanation of the phenomena will be explained hereafter.

1628. *Coercive force insensible in soft iron—most active in highly tempered steel*.—Of the magnetic bodies, that in which the coercive force is most feeble is soft iron, and that in which it is manifested with greatest energy is highly tempered steel.

It might indeed be assumed hypothetically that the magnetic fluid pervades all bodies whatsoever, but that its coercive force in bodies which are said to be unsusceptible of magnetism is such as to yield to no method of decomposition yet discovered.

1629. *Magnetic substances*.—The only substances in which the magnetic fluid has been decomposed, and which are therefore susceptible of magnetism, are iron, nickel, cobalt, chromium, and manganese, the first being that in which the magnetic property is manifested by the most striking phenomena.

## CHAP. II.

### MAGNETISM BY INDUCTION.

1630. *Soft iron rendered temporarily magnetic*.—If the extremity of a bar of soft iron be presented to one of the poles of a magnet, this bar will itself become immediately magnetic. It will manifest a neutral line and two poles, that pole which is in contact with the magnet being of a contrary name to the pole



contact, as represented in *fig.* 463., the extremity *A* of the first being presented to the boreal pole *b* of the fixed magnet, then each bar of the series will be rendered magnetic. The attraction of the boreal fluid at *b* will decompose the magnetic fluid of the bar *AB*, attracting the austral fluid towards *A*, and repelling the boreal fluid towards *B*. The boreal fluid thus driven towards *B* will produce a like decomposition of the fluid in the second bar *A'B'*, the austral fluid being attracted towards *A'* and the boreal repelled towards *B'*; and like effects will be produced upon the next bar *A''B''*, and so on.

If the bars be brought gradually closer together, the intensity of the magnetism thus developed will be increased, and will continue to be increased until the bars are brought into contact.

1632. *Induction.*—This process, by which magnetism is developed by magnetic action at a distance, is called *induction*; and the bars *AB*, *A'B'*, &c. are said to be *magnetized by induction*.

1633. *Magnets with poles reversed neutralize each other.*—If a second magnet of equal intensity with the first be laid upon *a b* with its poles reversed, so that its austral pole will coincide with *b* and its boreal with *a*, the bars *AB*, *A'B'*, *A''B''* magnetized by induction will instantly be reduced to their natural state, and deprived of the magnetic influence. This is easily explained. The attraction of the pole *b*, which draws towards it the austral and repels the boreal fluids of the bar *AB*, is neutralized by the attraction and repulsion of the austral pole of the second magnet laid upon it, which repels the austral fluid of the bar *AB* with a force equal to that with which the boreal fluid of the pole *b* attracts it, and attracts the boreal fluid with as much force as that with which the pole *b* repels it. Thus the attraction and repulsion of the two poles of the combined magnets neutralize

each other, and the fluids which were decomposed in the bar  $AB$  spontaneously recombine; and the same effects take place in the other bars.

All these effects may be rendered experimentally manifest by submitting the bars  $AB, A'B', A''B''$  to any of the tests already explained.

1634. *A magnet broken at its equator produces two magnets.*—It might be supposed, from what has been stated, that if a magnetic bar were divided at its equator, two magnets would be produced, one having austral and the other boreal magnetism, so that one of them would attract an austral and repel a boreal pole, while the other would produce the contrary attraction and repulsion. This, however, is not found to be the case. If a magnet be broken in two at its equator, two complete magnets will result, having each an equator at or near its centre, and two poles, austral and boreal; and if these be again broken, other magnets will be formed, each having an equator and two poles as before; and in the same manner, whatever be the number of parts, and however minute they be, into which a magnet is divided, each part will still be a complete magnet, with an equator and two poles.

1635. *Decomposition of magnetic fluid not attended by its transfer between pole and pole.*—It follows from this, that it cannot be supposed that the decomposition of the magnetic fluid which is produced when a body is magnetized, is attended with an actual transfer of the constituent fluids towards those regions of the magnet which are separated by its equator. It cannot, in a word, be assumed that the boreal fluid passes to one, and the austral fluid to the other side of the equator; for if this were the case, the fracture of the magnet at the equator would leave the two parts, one surcharged with austral and the other with boreal fluid, whereas by what has been just stated it is apparent that after such division both parts will possess both fluids.

1636. *The decomposition is molecular.*—The decomposition which takes place is therefore inferred to be accomplished spontaneously in each molecule which composes the magnet; each molecule is invested by an atmosphere composed of the two fluids, and the decomposition takes place in these atmospheres, the boreal fluid passing to one side of the molecule, and the austral fluid to the other. When a bar is magnetized, therefore, the material molecules which form it are invested with the magnetic



fluids, but the austral fluids are all presented towards the austral pole, and the boreal fluids towards the boreal pole. When the bar is not magnetic, but in its natural state, the two fluids surrounding each molecule are diffused through each other and combined, neither prevailing more at one side than the other.

1637. *Coercive force of iron varies with its molecular structure.*—Iron in different states of aggregation possesses different degrees of coercive force to resist the decomposition and re-composition of the magnetic fluid. Soft iron, when pure, is considered to be divested altogether of coercive force, or at least it possesses it in an insensible degree. In a more impure state, or when modified in its molecular structure by pressure, percussion, torsion, or other mechanical effects, it acquires more or less coercive power, and accordingly resists the reception of magnetism, and when magnetism has been imparted to it, retains it with a proportional force. Steel has still more coercive force than iron, and steel of different tempers manifests the coercive force in different degrees, that which possesses it in the highest degree being the steel which is of the highest temper, and which possesses in the greatest degree the qualities of hardness and brittleness.

1638. *Effect of induction on hard iron or steel.*—If a bar of hard iron or steel be placed with its end in contact with a magnet in the same manner as has been already described with respect to soft iron, it will exhibit no magnetism; but if it be kept in contact with the magnet for a considerable length of time, it will gradually acquire the same magnetic properties as have been described in respect to bars of soft iron,—with this difference, however, that having thus acquired them, it does not lose them when detached from the magnet, as is the case with soft iron. Thus it would appear, that it is not literally true that a bar of steel when brought into contact with the pole of a magnet receives no magnetism, but rather that it receives magnetism in an insensible degree; for if continued contact impart sensible magnetism, it must be admitted that contact for shorter intervals must impart more or less magnetism, since it is by the accumulation of the effects produced from moment to moment that the sensible magnetism manifested by continued contact is produced.

It appears, therefore, that the coercive energy of the bar of steel resists the action of the magnet, so that while the pole of

the magnet accomplishes the decomposition of the magnetic fluid in a bar of soft iron instantaneously, or at least in an indefinitely small interval of time, it accomplishes in a bar of steel the same decomposition, but only after a long protracted interval, the decomposition proceeding by little and little, from moment to moment during such interval.

Various expedients, as will appear hereafter, have been contrived, by which the decomposition in the case of steel bars having a great coercive force is expedited. These consist generally in moving the pole of the magnet successively over the various points of the steel bar, upon which it is desired to produce the decomposition, the motion being always made with the contact of the same pole, and in the same direction. The pole is thus made to act successively upon every part of the surface of the bar to be magnetized, and being brought into closer contact with it acts more energetically; whereas when applied to only one point, the energy of its action upon other points is enfeebled by distance, the intensity of the magnetic attraction diminishing, like that of gravity, in the same proportion as the square of the distance increases.

Since steel bars having once received the magnetic virtue in this manner retain it for an indefinite time, artificial magnets can be produced by these means of any required form and magnitude.

1639. *Forms of magnetic needles and bars.*—Thus a magnetic needle generally receives the form of a lozenge, as represented in *fig. 464.*, having a conical cap of agate at its centre, which is supported upon a pivot in such a manner as that the needle is free to turn in a horizontal plane, round the pivot as a centre. In this case the weight of the needle must be so regulated as to be in equilibrium on the pivot.

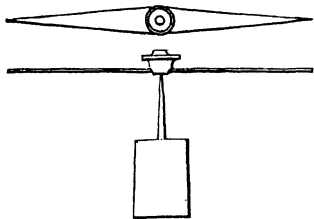

Fig. 464.

Bar magnets are pieces of steel in the form of a cylinder or prism whose length is considerable compared with their depth or thickness. In producing such magnets certain processes are necessary, which will be explained hereafter.

1640. *Compound magnet.*—Several bar magnets, equal and

similar in magnitude, being placed one upon the other with their corresponding poles together, form a compound magnet.

1641. *Effects of heat on magnetism.*—It is evident from what has been stated respecting the various degrees of coercive force manifested by the same metal in different states of aggregation, that the magnetic qualities depend upon molecular arrangement, and that the same body in different molecular states will exhibit different magnetic properties.

Since the elevation or depression of temperature by producing dilatation and contraction affects the molecular state of a body, it might be expected to modify also its magnetic properties, and this is accordingly found to be the case.

1642. *A red heat destroys the magnetism of iron.*—If a magnet, no matter how powerful, natural or artificial, be raised to a red heat, it will lose altogether its magnetic virtue. The elevation of temperature and the molecular dilatation consequent upon it destroys the coercive force and allows the recombination of the magnetic fluid. When after such change the magnet is allowed to cool, it will continue divested of its magnetic qualities. These effects may, however, be again imparted to it by the process already mentioned.

1643. *Different magnetic bodies lose their magnetism at different temperatures.*—M. Pouillet found that this phenomenon is produced at different temperatures for the different bodies which are susceptible of magnetism. Thus the magnetism of nickel is effaced when it is raised to the temperature of 660°, iron at a cherry red, and cobalt at a temperature much more elevated.

1644. *Heat opposed to induction.*—But not only does increased temperature deprive permanent magnets of their magnetism, but it renders even soft iron insusceptible of magnetism by induction, for it is found that soft iron rendered incandescent does not become magnetic when brought into contact or contiguity with the pole of a magnet.

1645. *Induced magnetism rendered permanent by hammering and other mechanical effects.*—If a bar of soft iron when rendered magnetic by induction be hammered, rolled, or twisted, it will retain its magnetism. It would follow, therefore, that the change of molecular arrangement produced by these processes confers upon it a coercive force which it had not previously.

1646. *Compounds of iron differently susceptible of magnetism.*—Compounds of iron are in general more or less susceptible of magnetism, according to the proportion of iron they contain.

Exceptions, however, to this are presented in the peroxide, the persulphate, and some other compounds containing iron in small proportion, in which the magnetic virtue is not at all present.

1647. *Compounds of other magnetic bodies not susceptible.*—Nickel, cobalt, chromium, and manganese are the only simple bodies which, in common with iron, enjoy the magnetic property, and this property completely disappears in most of the chemical compounds of which they form a part.

Magnetism, however, has been rendered manifest under a great variety of circumstances connected with the development of electricity which will be fully explained in a subsequent Book.

1648. *Magnets with consequent points.*—In the production of artificial magnets it frequently happens that a magnetic bar has more than one equator, and consequently more than two poles. This fact may be experimentally ascertained by exposing successively the length of a bar to any of the tests already explained. Thus, if presented to the test pendulum, it will be attracted with a continually decreasing force as it approaches each equator, and with an increasing force as it recedes from it. If the bar be rolled in iron filings, they will be attached to it in a succession of tufts separated by spaces where none are attached, indicating the equators.

If it be placed under a glass plate or sheet of paper on which fine iron filings are sprinkled, they will arrange themselves according to a series of concentric curves, as represented in *fig. 465.*

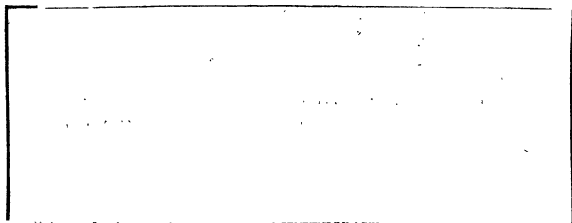

Fig. 465.

It is evident that the magnetic bar in this case is equivalent to a succession of independent magnets placed pole to pole.

The equators in these cases are called *consequent points*.

### CHAP. III.

#### TERRESTRIAL MAGNETISM.

1649. *Analogy of the earth to a magnet.*—If a small and sensitive magnetic needle, suspended by a fibre of silk so as to be free to assume any position which the attractions that act upon it may have a tendency to give to it, be carried over a magnetic bar from end to end, it will assume in different positions different directions, depending on the effect produced by the attractions and repulsions exercised by the bar upon it.

Let  $ab$ , *fig.* 466., be such a needle, the thread of suspension  $oe$  being first placed vertically over the equator  $E$  of the magnetic

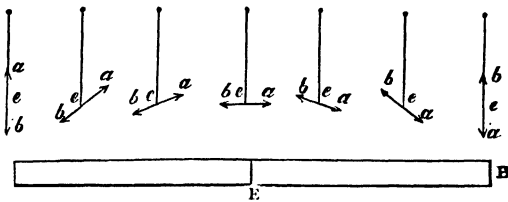

Fig. 466.

bar  $AB$ . The austral magnetism of  $AE$  will attract the boreal magnetism of  $be$  and will repel the austral magnetism of  $ae$ ; and in like manner the boreal magnetism of  $BE$  will attract the austral magnetism of  $ae$  and will repel the boreal magnetism of  $be$ . These attractions and repulsions will moreover be respectively equal, since the distances of  $ae$  and  $be$  from  $BA$  and  $BE$  are equal. The needle  $ab$  will therefore settle itself parallel to the bar  $AB$ , the pole  $a$  being directed to  $B$ , and the pole  $b$  being directed to  $A$ .

If the suspending thread  $oe$  be removed towards  $A$  to  $pe$ , the attraction of  $A$  upon  $b$  will become greater than the at-

traction of  $B$  upon  $a$ , because the distance of  $A$  from  $b$  will be less than the distance of  $B$  from  $a$ ; and, for a like reason, the repulsion of  $A$  upon  $a$  will be greater than the repulsion of  $B$  upon  $b$ . The needle  $ab$  will therefore be affected as if the end  $b$  were heavier than  $a$ , and it will throw itself into the inclined position represented in the figure, the pole  $a$  inclining downwards.

If it be carried still further towards  $A$ , the inequality of the attractions and repulsions increasing in consequence of the greater inequality of the distances of  $a$  and  $b$  from  $A$  and  $B$ , the inclination of  $b$  downwards will be proportionally augmented, as represented at  $r'$ .

In fine, when the thread of suspension is moved to a point  $r''$  over the pole  $A$ , the needle will become vertical, the pole  $b$  attracted by  $A$  pointing downwards.

If the needle be carried in like manner from  $E$  to  $B$ , like effects will be manifested, as represented in the figure, the pole  $a$  inclining downwards arising from the same causes.

A magnetic needle similarly suspended, carried over the surface of the earth in the directions north and south, undergoes changes of direction such as would be produced, on the principles explained above, if the globe were a magnet having its poles at certain points, not far distant from its poles of rotation.

To render this experimentally evident, it will be necessary to be provided with two magnetic instruments, one mounted so that the needle shall have a motion in a horizontal plane round a vertical axis, and the other so that it shall have a motion in a vertical plane round a horizontal axis.

1650. *The azimuth compass.*—The instrument called the azimuth compass consists of a magnetic bar or needle balanced on a vertical pivot, so as to be capable of turning freely in a horizontal plane, the point of the needle playing in a circle, of which its pivot is the centre.

The instrument is variously mounted and variously designated, according to the circumstances and purpose of its application.

When used to indicate the relative *bearings* or horizontal directions of distant objects, whether terrestrial or celestial, a graduated circle is placed under the needle and concentric with it. The divisions of this circle indicate the bearings of any distant object in relation to the direction of the needle.

The pivot in this form of compass is rendered vertical by means of a plumb-line or spirit-level.

1651. *The mariner's compass.*— When the azimuth compass is used for the purpose of navigation, the pivot supporting the needle is fixed in the bottom of a cylindrical box, which is closed at the top by a plate of glass, so as to protect it from the air. The magnetic bar is attached to the under side of a circular card, upon which is engraved a radiating diagram, which divides the circle into thirty-two parts called points. The compass box is suspended so as to preserve its horizontal position undisturbed by the motion of the vessel, by means of two concentric hoops called gimbals, one a little less than and included within the other. It is supported at two points upon the lesser hoop, which are diametrically opposite, and this lesser hoop itself is supported by two points upon the greater hoop, which are also diametrically opposite, but at right angles to the former. By these means the box, being at liberty to swing in two planes at right angles to each other, will maintain itself horizontal, and will therefore keep the pivot supporting the needle vertical, whatever be the changes of position of the vessel.

This arrangement is represented in *fig. 467.*, a vertical section of the compass box being given in *fig. 468.*

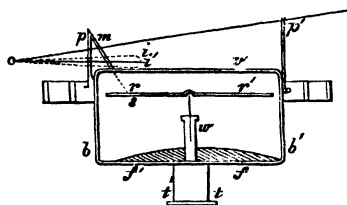

Fig. 467.

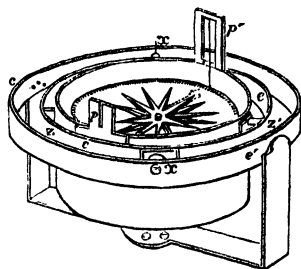

Fig. 468.

The sides of the cylindrical box are  $bb'$ , its bottom  $ff'$ , and the glass which covers it  $v$ . The magnetic bar or needle is supported on a vertical pivot by means of a conical cup, and can be raised and lowered at pleasure by means of a screw  $w$ . The compass card is represented in section at  $rr'$ , *fig. 467.*, and the divisions upon it marked by radiating lines called the *rose* are represented in *fig. 468.*

Two narrow plates,  $p$  and  $p'$ , are attached to the sides of the box so as to be diametrically opposed. In  $p$  there is a narrow vertical slit. In  $p'$  there is wider vertical slit, along which is stretched vertically a thin wire. The eye placed at  $o$  looks through the two slits, and turns the instrument round its support until the object of observation is intersected by the vertical wire, extended along the slit  $p'$ . Provisions are made in the instrument by which the direction thus observed can be ascertained relatively to that of the needle <sup>wa</sup>. The angle included between the direction of the observ<sup>that</sup> object, and that of the needle, is the *bearing* of the object re<sup>quat</sup>ly to the needle. <sup>w it</sup>

The compass box is suspended within the hoop <sup>to the</sup>  $ee'$ , at two points  $z z'$  diametrically opposed, and the hoop  $ee'$  is itself suspended within the fixed hoop  $cc'$ , at two points  $x x'$ , also diametrically opposed, but at right angles to  $z z'$ .

1652. *The dipping needle.*—The apparatus represented in *fig. 469.*, called the *dipping needle*, consists of a magnetic needle  $ee$ , supported and balanced on a horizontal axis, and playing therefore in a vertical plane. The angles through which it turns are indicated by a graduated circle  $ll'$ , the centre of which coincides with the axis of the needle, and the frame which supports it has an azimuth motion round a vertical axis, which is indicated and measured by the graduated horizontal circle  $zz'$ . The instrument is adjusted by means of a spirit-level, and regulating screws inserted in the feet.

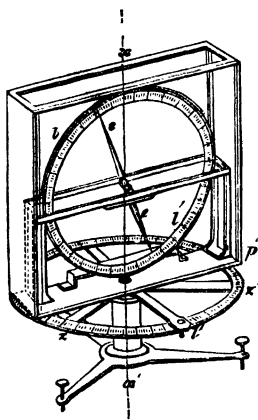

Fig. 469.

1653. *Analysis of magnetic phenomena of the earth.*—Supplied with these instruments, it will be easy to submit to observation the magnetic phenomena manifested at different parts of the earth.

If the azimuth compass be placed anywhere in the northern hemisphere, at London for example, the needle will take a certain position, forming an angle with the terrestrial meridian, and directing one pole to a point a certain number of degrees west



of the north, and the other to a point a like number of degrees east of the south. If it be turned aside from this direction, it will when liberated oscillate on the one side and the other of this direction, and soon come to rest in it.

Since an unmagnetized needle would rest indifferently in any direction, this preference of the magnetized needle to one particular direction must be ascribed to a magnetic force exerted by the earth attracting one of the poles of the needle in one direction, and the other pole in the opposite direction.

That this is not the casual attraction of unmagnetic ferruginous matter contained within the earth, is proved by the fact that, if the direction of the needle be reversed, it will, when liberated, make a pirouette upon its pivot, and after some oscillations resume its former direction.

This remarkable property is reproduced in all parts of the earth, on land and water, and equally on the summits of lofty mountains, in the lowest valleys, and in the deepest mines.

1654. *Magnetic meridian.*—The direction thus assumed by the horizontal needle, in any given place, is called the **MAGNETIC MERIDIAN** of that place.

The direction of a needle which would point due north and south is the **TRUE MERIDIAN**, or the **TERRESTRIAL MERIDIAN** of the place.

1655. *Declination or variation.*—The angle formed by the **MAGNETIC MERIDIAN** and the **TERRESTRIAL MERIDIAN** is called sometimes the **VARIATION**, and sometimes the **DECLINATION** of the needle. We shall adopt by preference the latter term.

The declination is said to be **EASTERN** or **WESTERN**, according as the pole of the needle, which is directed northwards, deviates to the east or to the west of the terrestrial meridian.

1656. *Magnetic polarity of the earth.*—To explain these phenomena, therefore, the globe of the earth itself is considered as a magnet, whose poles attract and repel the poles of the horizontal needle, each pole of the earth attracting that of an unlike name, and repelling that of a like name.

If, therefore, the northern pole of the earth be considered as that which is pervaded by boreal magnetism, and the southern pole by austral magnetism, the former will attract the austral and repel the boreal pole, and the latter will attract the boreal and repel the austral pole of the needle. Hence it will follow that the pole of the needle which is directed northwards is the

austral, and that which is directed southwards is the boreal pole.

1657. *Change of direction of the dipping-needle.*—It was shown in (1649) that when a needle which is free to play in a vertical plane was carried over a magnet, it rested in the horizontal position only when suspended vertically over the equator of the magnet, and its austral and boreal poles were inclined downwards, according as the needle was suspended at the boreal or austral side of the equator, and that this inclination was augmented as the distance from the equator at which the needle was suspended was increased. Now it remains to be seen whether any phenomenon analogous to this is presented by the earth.

For this purpose is the dipping-needle, *fig. 469.*, be arranged with its axis at *any* angles to the direction of the needle of the azimuth compass. It will then be found, that in general the dipping-needle *will* not rest in a horizontal position, but will assume a direction inclined to the vertical line, as represented in the figure, one pole being presented downwards, and the other upwards.

The angle which the lower arm of the needle makes with the horizontal line is called the *dip*.

If this apparatus be carried in this hemisphere northwards, in the direction in which a horizontal needle would point, the austral pole will be inclined downwards, and the dip will continually increase; but if it be carried southwards, the dip will continually diminish. By continuing to transport it southwards, the dip continually diminishing, a station will at length be found where the needle will rest in the horizontal position. If it be carried further southwards, the boreal pole will begin to turn downwards; in other words, the dip will be south instead of north, and as it is carried further southwards, this dip will continue to increase.

If the needle be carried northwards, in this hemisphere the dip continually augmenting, a station will at length be attained where the needle will become vertical, the austral pole being presented downwards, and the boreal pole upwards.

In the same manner, in the southern hemisphere, if the needle be carried southwards, a station will at length be attained where it will become vertical, the boreal pole being presented downwards, and the austral pole pointing to the zenith.

*Complete analogy of the earth to a magnet.*—By comparing these results with those which have been already described in the case where the needle was carried successively over a magnetic bar, the complete identity of the phenomena will be apparent, and it will be evident that the earth and the needle comport themselves in relation to each other exactly as do a small and a great magnet, over which it might be carried, the point where the needle is horizontal being over the magnetic equator, and those two points where it is vertical being the magnetic poles.

1658. *The magnetic equator.*—The needle being brought to that point where it rests horizontal, the magnetic equator will be at right angles to its direction. By transporting it successively in the one or the other direction thus indicated, the successive points upon the earth's surface where the needle rests horizontal, and where the dip is nothing, will be ascertained. The line upon the earth traced by this point is the magnetic equator.

*Its form and position not regular.*—This line is not, as might be expected, a great circle of the earth. It follows a course crossing the terrestrial equator from south to north, on the west coast of Africa, near the island of St. Thomas, at about  $7^{\circ}$  or  $8^{\circ}$  long. E., in a direction intersecting the equator at an angle of about  $12^{\circ}$  or  $13^{\circ}$ . It then passes across Africa towards Ceylon, and intersects that island near the point of the Indian promontory. It keeps a course from this of from  $8^{\circ}$  to  $9^{\circ}$  of N. lat. through the Indian Archipelago, and then gradually declining towards the line again intersects it at a point in the Pacific Ocean in long.  $170^{\circ}$  W., the angle at which it intersects the line being more acute than at the other point of intersection. It then follows a course a few degrees south of the line, and striking the west coast of South America near Lima, it crosses the South American continent, attaining the greatest south latitude near Bahia; and then again ascending towards the line, traverses the Atlantic and strikes the coast of Africa, as already stated, near the island of St. Thomas.

The magnetic equator, unlike the ecliptic, is not any regular curve, but follows the course we have just indicated in a direction slightly sinuous.

*Variation of the dip, going north or south.*—It has been

explained, that proceeding from north or south, from the magnetic equator, the needle dips on the one side or on the other, the dip increasing with the distance from the magnetic equator to which the needle is transported north or south.

*Lines of equal dip.*—The lines of equal dip, therefore, may be considered as bearing the same relation to the magnetic equator, which parallels of latitude bear to the terrestrial equator, being arranged nearly parallel to the former, though not in a manner so regular as in the case of parallels of latitude.

1659. *Magnetic meridians.*—If the horizontal needle be transported north or south, following a course indicated by its direction, it will be carried over a magnetic meridian. These magnetic meridians, therefore, bear to the magnetic equator a relation analogous to those which terrestrial meridians bear to the terrestrial equator, but, like the lines of equal dip, they are much more irregular.

1660. *Method of ascertaining the declination of the needles.*—Astronomy supplies various methods of determining in a given place the declination of the needle. It may be generally stated that this problem may be solved by observing any object whose angular distance from the true north is otherwise known, and comparing the direction of such object with the direction of the needle. Let P, *fig.* 470., be the place of observation; let PN be the direction of the true north, or, what is the same, the direction of the terrestrial meridian; and let PN' be the direction of the magnetic needle, or, what is the same, the magnetic meridian. The angle  $NP N'$  will then be the declination of the needle, being the angle formed by the terrestrial and magnetic meridians (1655).

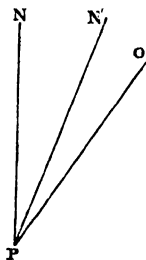

Let O be any object seen on the horizon in the direction PO; the angle  $OP N$  is called the true azimuth of this object, and the angle  $OP N'$  is called its magnetic azimuth.

This magnetic azimuth may always be observed by means of an azimuth compass.

If, then, an object be selected whose true azimuth is otherwise known, the declination of the needle may be determined by taking the difference between the true and magnetic azimuths of the object.

There are numerous celestial objects of which the azimuths are either given in tables, or may be calculated by rules and formulæ supplied by astronomy; such, for example, as the sun and moon at the moments they rise or set, or when they are at any proposed or observed altitudes. By the aid of such objects, which are visible occasionally at all places, the declination of the needle may be found.

*Local declinations.*—At different places upon the earth's surface the needle has different declinations. In Europe its mean declination is about  $17^\circ$ , increasing in going westward.

1661. *Lines of no declination called agonic lines.*—There are two lines on the earth's surface which have been called AGONIC LINES, upon which there is no declination; and where, therefore, the needle is directed along the terrestrial meridian. One of these passes over the American and the other over the Asiatic continent, and the former has consequently been called the AMERICAN and the latter the ASIATIC AGONIC. These lines run north and south, but do not follow the course of meridians.

It has been ascertained that their position is not fixed, but is liable to sensible changes in considerable intervals of time.

1662. *Declination in different longitudes, at equator, and in lat.  $45^\circ$ .*—In proceeding in either direction, east or west from these lines, the declination of the needle gradually increases, and becomes a maximum at a certain intermediate point between them. On the west of the Asiatic agonic the declination is west, on the east it is east.

At present the declination in England is about  $24^\circ$  W.; in Boston in the U. States it is  $5\frac{1}{2}^\circ$  W. Its mean value in Europe is  $17^\circ$  W. At Bonn it is  $20^\circ$ , at Edinburgh  $26^\circ$ , Iceland  $38^\circ$ , Greenland  $50^\circ$ , Königsberg  $13^\circ$ , and St. Petersburg  $6^\circ$ .

The following table, however, will exhibit more distinctly the variation of the declination in different parts of the globe. The longitudes expressed in the first column are measured westward from the meridian of Paris, and the declinations given in the second column are those which are observed on the terrestrial equator, those in the third column corresponding to the mean latitude of  $45^\circ$ .

*Table of the Declinations of the magnetic Needle in different Longitudes, and in Lat.=0 and Lat.=45°.*

Longitudes West of the Meridian of Paris.	Declinations.		Longitudes West of the Meridian of Paris.	Declinations.	
	Lat.=0.	Lat.=45°.		Lat.=0.	Lat.=45°.
0	19° W	22° W	190	9° E	11° E
10	19 W	25 W	200	8 E	8 E
20	16 W	26 W	210	5 E	4 E
30	11 W	25 W	220	3 E	2 E
40	4 W	24 W	230	2 E	1 E
50	3 E	24 W	240	0	1 W
60	5 E	20 W	250	0	0
70	8 E	11 W	260	1 E	3 E
80	10 E	3 W	270	3 E	4 E
90	10 E	4 E	280	0	4 E
100	8 E	11 E	290	0	4 E
110	6 E	17 E	300	2 W	2 E
120	5 E	18 E	310	7 W	1 W
130	8 E	19 E	320	11 W	5 W
140	6 E	19 E	330	13 W	10 W
150	6 E	19 E	340	17 W	14 W
160	7 E	19 E	350	18 W	17 W
170	9 E	17 E	360	19 W	22 W
180	10 E	14 E			

1663. *Isogonic lines.*—Lines traced upon the globe at a point at which the magnetic needle has the same declinations, are called ISOGONIC LINES. These, as well as the ISOCLINIC LINES, or lines of equal dip, are irregular in their arrangement, and not very exactly ascertained.

1664. *Local dip.*—The local variations of the dip are also imperfectly known. In Europe it ranges from 60° to 70°. In 1836 the dip observed at the undermentioned places was as follows:—

Pekin	-	-	-	54°	49'
Rome	-	-	-	61°	42'
Brussels	-	-	-	68°	32'
St. Petersburg	-	-	-	71°	
St. Helena	-	-	-	14°	50'
Rio de Janeiro	-	-	-	13°	30'

1665. *Position of magnetic poles.*—The determination of the precise position of the magnetic poles, or the points where the dip is 90°, is attended with considerable difficulty, inasmuch as for a considerable distance round that point the dip is nearly 90°. Hansteen considered that there were grounds for supposing that there were two magnetic poles in each hemisphere. One of these in the northern hemisphere he supposed to be west of Hudson's Bay in 80° lat. N., and 96° long. W.; and the other in Northern Asia in 81° lat. N., and 116 long. E. The two

southern magnetic poles he supposed to be situate near the southern pole. This supposition, however, appears to be at present abandoned, and the observations of GAUSS lead to the conclusion that there is but one magnetic pole in each hemisphere.

In the northern voyages made between 1829 and 1833, Sir James Ross found the dipping-needle to stand vertical in the neighbourhood of Hudson's Bay at  $70^{\circ} 5' 17''$  lat. N., and  $114^{\circ} 55' 18''$  long. W. The dipping-needle, according to the observations of Sir James Ross, was nowhere absolutely vertical, departing from the vertical in all cases by a small angle, amounting generally to one minute of a degree. This, however, might be ascribed to the error of observation, or the imperfection of instruments exposed to such a climate.

The existence of the magnetic pole, however, at or near the point indicated, was proved by carrying round it at a certain distance a horizontal needle, which always pointed to the spot in whatever direction it was carried. Gauss has fixed the position of the magnetic pole in the southern hemisphere by theory at  $72^{\circ} 35'$  lat. S., and  $152^{\circ} 30'$  long. E.

1666. *Magnetic poles not antipodal.*—It will be perceived, therefore, that the magnetic poles, unlike the terrestrial poles, are not antipodal to each other; or, in other words, they do not form the extremities of the same diameter of the globe: they are not even on the same meridian. If Gauss's statement be assumed to be correct, the southern magnetic pole is on a meridian  $152^{\circ} 30'$  E. of the meridian of Greenwich, and therefore  $207^{\circ} 30'$  W. of that meridian, whereas the northern magnetic pole is on a meridian  $114^{\circ} 55' 18''$  W. The angle, therefore, under the two meridians passing through the two poles will be about  $92\frac{1}{2}^{\circ}$ . It would follow, therefore, that these points lie upon terrestrial meridians nearly at right angles to each other, and that upon these they are at nearly equal distances from the terrestrial poles; the distance of the northern magnetic pole from the northern terrestrial pole being nearly  $20^{\circ}$ , and the distance of the southern magnetic pole from the southern terrestrial pole being about  $17\frac{1}{2}^{\circ}$ .

1667. *Periodical variations of terrestrial magnetism.*—It appears, from observations made at intervals of time more or less distant for about two centuries back, that the magnetic condition of the earth is subject to a periodical change; but neither the quantity nor the law of this change is exactly known. It was not until recently that magnetic observations

were conducted in such a manner as to supply the data necessary for the development of the laws of magnetic variation, and they have not been yet continued a sufficient length of time to render these laws manifest.

Independently of observation, theory affords no means of ascertaining these laws, since it is not certainly known what are the physical causes to which the magnetism of the earth must be ascribed.

In the following table are given the declinations of the needle observed at Paris between the years 1580 and 1835, and the dip between the years 1671 and 1835.

*Table of Declinations observed at Paris.*

Year.	Declination.	Year.	Declination.
1580	11° 30' E	1816	22° 25' W
1618	8	1817	22 19
1663	0	1823	22 23
1678	1 30 W	1824	22 23
1700	8 10	1825	22 22
1780	19 55	1827	22 20
1785	22	1828	22 5
1805	22 5	1829	22 12
1813	22 28	1832	22 3
1814	22 34	1835	22 4

*Table of the Dip observed at Paris.*

Year.	Dip.	Year.	Dip.
1671	73°	1819	68° 25'
1754	72 15'	1820	68 20
1776	72 25	1821	68 14
1780	71 48	1822	68 11
1791	70 52	1823	68 8
1798	69 51	1825	68 0
1806	69 12	1826	68 0
1810	68 50	1829	67 41
1814	68 36	1831	67 40
1816	68 40	1835	67 24
1818	68 35		

1668. *Intensity of terrestrial magnetism.*—The intensity of terrestrial magnetism, like that of a common magnet, may be estimated by the rate of vibration which it produces in a magnetic needle submitted to its attraction. This method of determining the intensity of magnetic force is in all respects analogous to those by which the intensity of the earth's attraction is determined by a common pendulum (549). The same needle being exposed to a varying attraction will vary its rate



of vibration, the force which attracts it being proportional to the square of the number of vibrations which it makes in a given time. Thus, if at one place it makes ten vibrations per minute, and in another only eight, the magnetic force which produces the first will be to that which produces the second rate of vibration, as 100 to 64.

1669. *Increases from equator to poles.*—In this manner it has been found that the intensity of terrestrial magnetism is least at the magnetic equator, and that it increases gradually in approaching the poles.

1670. *Isodynamic lines.*—Those parts of the earth where the magnetic intensities are equal are called *isodynamic lines*, and resemble in their general arrangement, without however coinciding with them, the isoclinic curves or magnetic parallels of equal dip.

1671. *Their near coincidence with isothermal lines.*—It has been found that there is so near a coincidence between the isodynamic and the isothermal lines, that a strong presumption is raised that terrestrial magnetism either arises from terrestrial heat, or that these phenomena have at least a common origin.

1672. *Equatorial and polar intensities.*—It appears to follow from the general result of observations made on the intensity of terrestrial magnetism, that its intensity at the poles is to its intensity at the equator nearly in the ratio of 3 to 2.

1673. *Effect of the terrestrial magnetism on soft iron.*—If anything were wanted to complete the demonstration that the globe of the earth is a true magnet, it would be supplied by the effects produced by it upon substances susceptible of magnetism, but which are not yet magnetized. It has been already shown that when a bar of soft iron is presented to the pole of a magnet, its natural magnetism is decomposed, the austral fluid being attracted to one extremity, and the boreal fluid repelled to the other, so that the bar of soft iron becomes magnetized, and continues so as long as it is exposed to the influence of the magnet. Now, if a bar of soft iron be presented to the earth in the same manner, precisely the same effects will ensue. Thus, if it be held in the direction of the dipping-needle, so that one of its ends shall be presented in the direction of the magnetic attraction of the earth, it will become magnetic, as may be proved by any

of the tests of magnetism already explained. Thus, if a sensitive needle be presented to that end of the bar which in the northern hemisphere is directed downwards, austral magnetism will be manifested, the boreal pole of the needle being attracted, and the austral pole repelled. If the needle be presented to the upper end of the bar, contrary effects will be manifested; and if it be presented to the middle of the bar, the neutral line or equator will be indicated. If the bar be now inverted, the upper end being presented downwards, and *vice versâ*, still parallel to the dipping-needle, its poles will also be inverted, the lower, which previously was boreal, being austral, and *vice versâ*.

If the bar be held in any other direction, inclined obliquely to the dipping-needle, the same effects will be manifested, but in a less degree, just as would be the case if similarly presented to an artificial magnet; and, in fine, if it be held at right angles to the direction of the dipping-needle, no magnetism whatever will be developed in it.

1674. *Its effects on steel bars.*—If the same experiments be made with bars of hard iron or steel, no sensible magnetism will at first be developed; but if they be held for a considerable time in the same position, they will at length become magnetic, as would happen under like conditions with an artificial magnet. Iron and steel tools which are hung up in workshops in a vertical position are found to become magnetic, an effect explained by this cause.

1675. *Diurnal variation of the needle.*—Besides the changes in the magnetic state of the earth, the periods of which are measured by long intervals of time, there are more minute and rapid changes depending apparently upon the vicissitudes of the seasons and the diurnal changes.

The magnitude of the diurnal variation depends upon the situation of the place, the day, and the season, but is obviously connected with the function of solar heat. At Paris it is observed that during the night the needle is nearly stationary; at sunrise it begins to move, its north pole turning westwards, as if it were repelled by the influence of the sun. About noon, or more generally between noon and three o'clock, its western variation attains a maximum, and then it begins to move eastward, which movement continues until some time between nine and eleven o'clock at night, when the needle resumes the

position it had when it commenced its western motion in the morning.

The amplitude of this diurnal range of the needle is, according to Cassini's observations, greatest during summer and least during winter. Its mean amount for the months of April, May, June, July, August, and September is stated at from 13 to 15 minutes; and for the months of October, November, December, January, and March, at from 8 to 10 minutes. There are, however, occasionally, days upon which its range amounts to 25 minutes, and others when it does not surpass 5 or 6 minutes. Cassini repeated his magnetic observations in the cellars constructed under the Paris observatory at a depth of about a hundred feet below the surface, and therefore removed from the immediate influence of the light and heat of the day. The amplitude of the variations, and all the peculiarities of the movement of the needle here, were found to be precisely the same as at the surface.

In more northern latitudes, as, for example, in Denmark, Iceland, and North America, the diurnal variations of the needle are in general more considerable and less regular. It appears, also, that in these places the needle is not stationary during the night, as in Paris, and that it is towards evening that it attains its maximum westward deviation. On the contrary, on going from the north towards the magnetic equator the diurnal variations diminish, and cease altogether on arriving at this line. It appears, however, according to the observations of Captain Duperrey, that the position of the sun north or south of the terrestrial equator has a perceptible influence on the oscillation of the needle.

On the south of the magnetic equator the diurnal variations are produced, as might be expected, in a contrary manner; the northern pole of the magnet turns to the east at the same hours that, in the northern hemisphere, it turns to the west.

It has not yet been certainly ascertained whether in each hemisphere these diurnal variations of the needle correspond in the places where the eastern and western declinations also correspond.

The dip is also subject to certain diurnal variations, but much smaller in their range than in the case of the horizontal needle.

As a general result of these observations it may be inferred,

that if a magnetic needle were suspended in such a manner as to be free to move in any direction whatever, it would, during twenty-four hours, move round its centre of suspension in such a manner as to describe a small cone, whose base would be an ellipse or some other curve more or less elongated, and whose axis is the mean direction of the dipping-needle.

1676. *Disturbances in the magnetic intensity.*—The intensity as well as the direction of the magnetic attraction of the earth at a given place are subject to continual disturbances, independently of those more regular variations just mentioned.

These disturbances are in general connected with the electrical state of the atmosphere, and are observed to accompany the phenomena of the aurora borealis, earthquakes, volcanic eruptions, sudden vicissitudes of temperature, storms, and other atmospheric disturbances.

1677. *Influence of aurora borealis.*—During the appearance of the aurora borealis in high latitudes, a considerable deflection of the needle is generally manifested, amounting often to several degrees. So closely and necessarily is magnetic disturbance connected with this atmospheric phenomenon, that practised observers can ascertain the existence of an aurora borealis by the indications of the needle, when the phenomenon itself is not visible.

## CHAP. IV.

### MAGNETIZATION.

1678. *Effects of induction.*—The process by which artificial magnets are produced are all founded upon the property of induction (Ch. II.). When one of the poles of a magnet is presented to any body which is susceptible of magnetism, it will have a tendency to decompose the magnetic fluid in the body to which it is presented, attracting one of its constituents and repelling the other. If the coercive force by which the fluids are combined be greater than the energy of the attraction of the magnet, no decomposition will take place, and the body to which

the magnet is presented will not be magnetized, but the coercive force with which the fluids are united will be rendered more feeble, and the body will be more susceptible of being magnetized than before.

If, however, the energy of the magnetic force of the magnet presented to it be greater than the coercive force with which the fluids are united, a decomposition will take place, which will be more or less in proportion as the force of the magnet exceeds in a greater or less degree the coercive force which unites the magnetic fluids.

1679. *Their application in the production of artificial magnets.*—These principles being well understood, the methods of producing artificial magnets will be easily rendered intelligible.

It has been already explained, that pure soft iron is almost, if not altogether, divested of coercive force, so that a bar of this substance is converted into a magnet instantaneously when the pole of a magnet is presented to it; but the absence of coercive force, which renders this conversion so prompt, is equally efficacious in depriving the bar of its magnetism the moment the magnet which produces this magnetism is removed.

1680. *Best material for artificial magnets.*—Soft iron, therefore, is inapplicable when the object is to produce permanent magnetism. The material best suited for this purpose is steel, especially that which has a fine grain, a uniform structure, and is free from flaws. It is necessary that it should have a certain degree of hardness, and that this should be uniform through its entire mass. If the hardness be too great, it is difficult to impart to it the magnetic virtue; if not great enough, it loses its magnetism for want of sufficient coercive force. To render steel bars best fitted for artificial magnets, it has been found advantageous to confer upon them in the first instance the highest degree of temper, and thus to render them as hard and brittle as glass, and then to anneal them until they are brought to a straw or violet colour.

1681. *Best form for bar magnets.*—The intensity of artificial magnets depends also, to some extent, upon their form and magnitude. It has been ascertained, that a bar magnet has the best proportion when its thickness is about one-fourth and its length twenty times its breadth.

1682. *Horse-shoe magnets.*—Bar magnets are sometimes

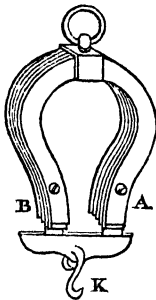

Fig. 471.

shaped in the form of a horse-shoe, and are hence called **HORSE-SHOE MAGNETS**, as represented in *fig. 471*. When magnets are constructed in this form, the distance between the two poles ought not to be greater than the thickness of the bar of which the magnet consists. The surface of the steel forming both bars, in horse-shoe magnets, should be rendered as even and as well polished as possible.

1683. *Methods of producing artificial magnets by friction.*—Two methods of imparting magnetism by friction are known as those of **DUHAMEL** and **ÆPINUS**. The former is sometimes called the *method of single touch*, and the latter the *method of double touch*.

1684. *Method of single touch.*—The method of Duhamel, or of single touch, is practised as follows. The bar  $A'B'$ , *fig. 472.*,

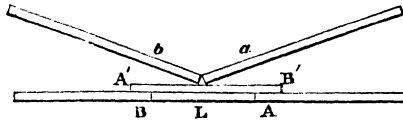

Fig. 472.

which is to be magnetized, is laid upon a block of wood  $L$  projecting at each end a couple of inches. Under the ends are placed the opposite poles  $A$  and  $B$  of two powerful magnets, so as to be in close contact with the bar to be magnetized. The influence of the pole  $A$  will be to attract the boreal fluid of the bar towards the end  $B'$ , and to repel the austral fluid towards the end  $A'$ ; and the effect of the pole  $B$  will be similar, that is to say, to repel the boreal fluid towards the end  $B'$ , and to attract the austral towards the end  $A'$ . It is evident, therefore, that if the coercive force of the magnetism of the bar  $A'B'$  be not greater than the force of the magnets  $A$  and  $B$ , a decomposition will take place by simple contact, and the bar  $A'B'$  will be converted into a magnet, having its austral pole at  $A'$  and its boreal pole at  $B'$ ; and, indeed, this will be accomplished even though the coercive force of the bar  $A'B'$  be considerable, if it be left a sufficient length of time under the influence of the magnets  $A$  and  $B$ .

But without waiting for this, its magnetization may be accomplished immediately by the following process. Let two bar magnets  $a$  and  $b$  be placed in contact with the bar  $A'B'$ , to be magnetized near its middle point, but without touching each other, and let them be inclined in opposite directions to the bar  $A'B'$ , at angles of about  $30^\circ$ , as represented in the figure. Let the bar which is applied on the side  $B'$  have its austral pole, and that which is applied on the side  $A'$  its boreal pole in contact with the bar  $A'B'$ , and to prevent the contact of the two bars  $a$  and  $b$ , let a small piece of wood, lead, copper, or other substance not susceptible of magnetism, be placed between them. Taking the two bars  $a$  and  $b$ , one in the right and the other in left hand, let them now be drawn in contrary directions, slowly and uniformly along the bar  $A'B'$ , from its middle to its extremities, and being then raised from it, let them be again placed as before, near its middle point, and drawn again uniformly and slowly to its extremities; and let this process be repeated until the bar  $A'B'$  has been magnetized.

It is evident that the action of the two magnetic poles  $a$  and  $b$  will be to decompose the magnetic fluid of the bar  $A'B'$ , and that in this they are aided by the influence of the magnets  $A$  and  $B$ , which enfeeble, as has been already shown, the coercive force.

This method is applicable with advantage to magnetize, in the most complete and regular manner, compass needles, and bars whose thickness does not exceed a quarter of an inch.

1685. *Method of double touch.*—When the bars exceed this thickness, this method is insufficient, and that of *Æpinus*, or the method of double touch, is found more effectual. This method is practised as follows.

The bars  $a$  and  $b$  are placed as before, but instead of being held in the two hands are attached to a triangle, by which they are maintained permanently in their position, and held together.

Being placed at the centre of the bar  $A'B'$ , they are moved together first to one extremity  $B'$ , and then back along the length of the entire bar to the other extremity  $A'$ . They are then again drawn over the bar to  $B'$ , and so backwards and forwards continuously until the bar is magnetized. The operation is always terminated when the bars have passed over that half of the bar  $A'B'$  opposite to that upon which the motion commenced. Thus if the operation commenced by moving the

united bars  $a b$  from the centre to the end  $b'$ , it will be terminated when they are moved from the extremity  $a'$  to the middle.

1686. *Inapplicable to compass needles and long bars.*—By this method a greater quantity of magnetism is developed than in that of Duhamel, but it should never be employed for magnetizing compass needles or bars intended for delicate experiments, since it almost always produces magnets with poles of unequal force, and frequently gives them consequent points (1648), especially when the bars have considerable length.

1687. *Magnetic saturation.*—Since the coercive force proper to each body resists the recomposition of the magnetic fluids, it follows that the quantity of magnetism which a bar or needle is capable of retaining permanently, will be proportional to this coercive force. If, by the continuance of the process of magnetization and the influence of very powerful magnets, a greater development of magnetism be produced than corresponds with the coercive force, the fluids will be recomposed by the mutual attraction until the coercive force resists any further recomposition. The tendency of the magnetic fluids to unite being then in equilibrium with the coercive force, no further recomposition will take place, and the bar will retain its magnetism undiminished.

When the bar is in this state, it is said to be magnetized to *saturation*.

It has been generally supposed that when bars are surcharged with magnetism they lose their surplus and fall suddenly to the point of saturation, the recomposition of the fluids being instantaneous.

M. Pouillet, however, has shown that this recomposition is gradual, and after magnetization there is even in some cases a reaction of the fluids which is attended with an increase instead of a diminution of magnetism. He observes that it happens not unfrequently that the magnetism is not brought to permanent equilibrium with the coercive force for several months.

1688. *Limit of magnetic force.*—It must not be supposed that by the continuance of the processes of magnetization which have been described above, an indefinite development of magnetism can be produced. When the resistance produced by the coercive force to the decomposition of the fluids becomes equal to the decomposing power of the magnetizing bars, all further increase of magnetism will cease.



It is remarkable that if a bar which has been magnetized to saturation by magnets of a certain power be afterwards submitted to the process of magnetization by magnets of inferior power, it will lose the excess of its magnetism and fall to the point of saturation corresponding to the magnets of inferior power.

1689. *Influence of the temper of the bar on the coercive force.*—Let a bar of steel tempered at a bright red heat be magnetized to saturation, and let its magnetic intensity be ascertained by the vibration of a needle submitted to its attraction. Let its temper be then brought by annealing to that of a straw colour, and being again magnetized to saturation, let its magnetic intensity be ascertained. In like manner, let its magnetic intensities at each temper from the highest to the lowest be observed. It will be found that the bars which have the highest temper have the greatest coercive force, and therefore admit of the greatest development of magnetism, but even at the lowest tempers they are still, when magnetized to saturation, susceptible of a considerable magnetic force.

Although highly tempered steel has this advantage of receiving magnetism of great intensity, it is, on the other hand, subject to the inconvenience of extreme brittleness, and consequent liability to fracture. A slight reduction of temper causes but a small diminution in its charge of magnetism, and renders it much less liable to fracture.

1690. *Effects of terrestrial magnetism on bars.*—It has been already shown that the inductive power of terrestrial magnetism is capable of developing magnetism in iron bars, and, under certain conditions, of either augmenting, diminishing, or even obliterating the magnetic force of bars already magnetized. In the preservation of artificial magnets, therefore, this influence must be taken into account.

According to what has been explained, it appears that if a magnetic bar be placed in the direction of the dipping-needle in this hemisphere, the earth's magnetism will have a tendency to attract the austral magnetism downwards, and to repel the boreal upwards. If, therefore, the austral pole of the bar be presented downwards, this tendency will preserve or even augment the magnetic intensity of the bar. But if the magnet be in the inverted position, having the boreal pole downwards, opposite effects will ensue. The austral fluid being attracted

downwards, and the boreal driven upwards, a recombination of the fluids will take place, which will be partial or complete according to the coercive force of the bar. If the coercive force of the bar exceed the influence of terrestrial magnetism, the effect will be only to diminish the magnetic intensity of the bar; but if not, the effect will be the recomposition of the magnetic force and the reduction of the bar to its natural state; but if the bar be still held in the same position, the continued effect of the terrestrial magnet will be again to decompose the natural magnetism of the bar, driving the austral fluid downwards and repelling the boreal upwards, and thus reproducing the magnetism of the bar with reversed polarity.

1691. *Means of preserving magnetic bars from these effects by armatures or keepers.*—It is evident, therefore, that when it is desired to preserve magnetized bars unaltered, they must be protected from these effects of the terrestrial magnet, and the manner of accomplishing this is by means of **ARMATURES OR KEEPERS.**

When the magnetic bars to be preserved are straight bars of equal length, they are laid parallel to each other, their ends corresponding, but with poles reversed, so that the austral pole of each shall be in juxtaposition with the boreal pole of the other, as represented in *fig. 473.*

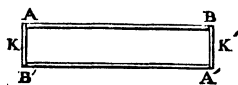

Fig. 473.

A bar of soft iron called the keeper is applied as represented at  $\kappa$ , in contact with the two opposite poles  $A$  and  $B'$ , and another similar bar  $\kappa'$  in contact with  $A'$  and  $B$ , so as to complete the parallelogram. In this arrangement the action of the poles  $A$  and  $B'$  upon the keeper  $\kappa$  is to decompose its magnetism, driving the austral fluid towards  $B'$  and the boreal fluid towards  $A'$ . The boreal fluid of  $\kappa$  exercises a reciprocal attraction upon the austral fluid of  $A$ , and the austral fluid of  $\kappa$  exercises a corresponding attraction upon the boreal fluid of  $B'$ . Like effects are produced by the keeper  $\kappa'$  at the opposite poles  $A'$  and  $B$ .

In this manner the decomposition of the fluids in the two bars  $AB$  and  $A'B'$  is maintained by the action of the keepers  $\kappa$  and  $\kappa'$ .

If the magnet have the horse-shoe form, this object is attained by a single keeper, as represented in *fig. 471.*

The keeper  $\kappa$  is usually formed with a round edge, so as to

touch the magnet only in a line, and not in a surface, as it would do if its edge were flat. It results from experience that a keeper kept in contact in this manner for a certain length of time with a magnet, augments the attractive force, and appears to *feed*, as it were, the magnetism.

1692. *Magnetism may be preserved by terrestrial induction.*—Magnetic needles, suspended freely so as to obey the attraction of terrestrial magnetism, do not admit of being thus protected by keepers; but neither do they require it, for the austral pole of the needle being always directed towards the boreal pole of the earth, and the boreal pole of the needle towards the austral pole of the earth, the terrestrial magnet itself plays the part of the keeper, continually attracting each fluid towards its proper pole of the magnet, and thus maintaining its magnetic intensity.

1693. *Compound magnets.*—Compound magnets are formed by the combination of several bar magnets of similar form and equal magnitude, laid one upon another, their corresponding poles being placed in juxtaposition.

A compound horse-shoe magnet, such as that represented in *fig. 471.*, is formed in like manner of magnetized bars, superposed on each other and similar in form, their corresponding poles being placed in juxtaposition. These bars, whether straight or in the horse-shoe form, are separately magnetized before being combined by the methods already explained.

In the case of the horse-shoe magnet a ring is attached to the keeper, and another to the top of the horse-shoe, *fig. 471.*, so that the magnet being suspended from a fixed point, weights may be attached to the keeper tending to separate it from the magnet.

In this way horse-shoe magnets often support from ten to twenty times their own weight.

1694. *Magnetized tracings on a steel plate.*—If the pole of a magnet be applied to a plate of steel of about one-tenth of an inch thick and of any superficial magnitude, such as a square foot, and be moved slowly upon it, tracing any proposed figure, the line traced upon the steel plate will be rendered magnetic, as will be indicated by sprinkling steel filings upon the plate. They will adhere to those points over which the magnet has been passed, and will assume the form of the figure traced upon the plate.

1695. *Influence of heat on magnetic bars.*—The influence of

heat upon magnetism, which was noticed at a very early period in the progress of magnetic discovery, has lately been the subject of a series of experimental researches by M. Kupffer, from which it appears that a magnetic bar when raised to a red heat does not lose its magnetism suddenly at that temperature, but parts with it by slow degrees as its temperature is raised. This curious fact was ascertained by testing the magnetism of the bar, by the means explained in (1668), at different temperatures, when it was found that at different degrees of heat it produced different rates of oscillation of the test needle.

It was also ascertained that, in order to deprive a magnetic bar of all its magnetism when raised to a given temperature, a certain length of time was necessary.

Thus a magnetic bar plunged in boiling water, and retained there for ten minutes, lost only a portion of its magnetism, and after being withdrawn and again plunged in the water for some length of time, it lost an additional portion of its attractive force; and by continuing in the same manner its immersion for the same interval, its magnetic force was gradually diminished, a part still, however, remaining after seven or eight such immersions.

A magnetic bar, when raised to a red heat, not only loses its magnetism, but it becomes as incapable of receiving magnetism from any of the usual processes of magnetization, as would be any substance the most incapable of magnetism.

*Astatic needle.*—All magnets freely suspended being subject to the influence of terrestrial magnetism, the effects produced upon them by other causes are necessarily compounded with those of the earth. Thus, if a magnetic needle be exposed to the influence of any physical agent, which, acting independently upon it, would cause its north pole to be directed to the east, the pole, being at the same time affected by the magnetism of the earth, which acting alone upon it would cause it to be directed to the north, will take the intermediate direction of the north-east. When, in such cases, the exact effect of the earth's magnetism on the direction of the needle is known, and the compound effect is observed, the effect of the physical agent by which the needle is disturbed may generally be eliminated and ascertained. It is, nevertheless, often necessary to submit a magnetic needle to experiments, which require that it should be rendered independent of the directive influence of the earth's magnetism, and

expedients have accordingly been invented for accomplishing this.

A needle which is not affected by the earth's magnetism is called an **ASTATIC NEEDLE**.

A magnetic needle freely suspended over a fixed bar magnet will have a tendency, as already explained, to take such a position that its magnetic axis shall be parallel to that of the fixed magnet, the poles being reversed. Now if the fixed magnet be placed with its magnetic axis coinciding with the magnetic meridian, the poles being reversed with relation to those of the earth, its directive influence on the needle will be exactly contrary to that of the earth. While the earth has a tendency to turn the austral pole of the needle to the north, the magnet has a tendency to turn it to the south. If these tendencies be exactly equal, the needle will totally lose its polarity, and will rest indifferently in any direction in which it may be placed.

As the influence of the bar magnet on the needle increases as its distance from it is diminished, and *vice versâ*, it is evident that it may always be placed at such a distance from it, that its directive force shall be exactly equal to that of the earth.

In this case, the needle will be rendered astatic.

A needle may also be rendered astatic by connecting with it a second needle, having its magnetic axis parallel and its poles reversed, both needles having equal magnetic forces. The compound needle thus formed being freely suspended, the directive power of the earth on the one will be equal and contrary to its directive power on the other, and it will consequently rest indefinitely in any direction.

It is in general, however, almost impracticable to ensure the exact equality of the magnetism of two needles thus combined. If one exceed the other, as is generally the case, the compound will obey a feeble directive force equal to the difference of their magnetism.

## BOOK THE THIRD.

## ELECTRICITY.

## CHAP. I.

## ELECTRICAL ATTRACTIONS AND REPULSIONS.

1696. *Electrical effects.*—If a glass tube being well dried be briskly rubbed with a dry woollen cloth, the following effects may be produced.

The tube, being presented to certain light substances, such as feathers, metallic leaf, bits of light paper, filings of cork or pith of elder, will attract them.

If the friction take place in the dark, a bluish light will be seen to follow the motions of the cloth.

If the glass be presented to a metallic body, or to the knuckle of the finger, a luminous spark accompanied by a sharp cracking sound, will pass between the glass and the finger.

On bringing the glass near the skin, a sensation will be produced like that which is felt when we touch a cobweb.

The same effects will be produced by the cloth with which the glass is rubbed as by the glass itself.

An extensive class of bodies submitted to the same kind of mutual friction produce similar effects.

1697. *Origin of the name Electricity.*—The physical agency from which these and like phenomena arise has been called ELECTRICITY, from the Greek word *ἤλεκτρον* (electron), signifying amber, that substance having been the first in which the property was observed by the ancients.

To study the laws which govern electrical forces, let an apparatus be provided, called an electric pendulum, consisting of a small ball *B'*, *fig.* 474., about the tenth of an inch in diameter, turned from the pith of elder, and suspended, as represented in the figure, by a fine silken thread attached to a convenient stand.

If the glass tube, after being rubbed as above described, be brought into contact successively with two pith balls thus suspended, and then separated from them, a property will be imparted to the balls in virtue of which they will be repelled by the glass tube when it is brought nearer them, and they will in like manner repel each other when brought into proximity.

Thus, if the glass tube *s*, *fig.* 474., be brought nearer the ball *B'*, the ball will depart from its vertical position, and will incline itself from the tube in the position *B*.

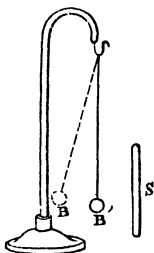

Fig. 474.

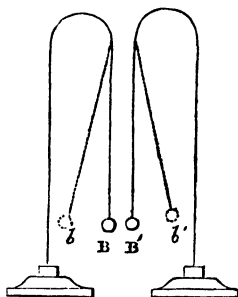

Fig. 475.

If the two balls, being previously brought into contact with the tube, be placed near each other, as in *fig.* 475., they will incline from each other, departing from the vertical positions *B* and *B'*, and taking the positions *b* and *b'*.

1698. *The electric fluid.*—These effects are explained by the supposition that a subtle and imponderable fluid has been developed upon the glass tube which is self-repulsive; that by touching the balls, a portion of this fluid has been imparted to them, which is diffused over their surface, and which, for reasons that will hereafter appear, cannot escape by the thread of suspension; that the fluid remaining on the glass tube repels this fluid diffused on the balls, and therefore repels the balls themselves which are invested by the fluid; and, in fine, that the fluid diffused on the one ball repels and is repelled by the fluid diffused on the other ball, and that the balls being covered by the fluid are reciprocally repelled.

A vast body of phenomena, the most important of which will be described in the following chapters, have converted this supposition into a certainty, accepted by all scientific authorities.

The fluid producing these effects is called the **ELECTRIC FLUID**.

1699. *Positive and negative electricity*.—If the hand which holds the cloth be covered with a dry silk glove, the cloth, after the friction with the glass, will exhibit the same effects as above described. If it be brought into contact with the balls and separated from them, it will repel them, and the balls themselves will repel each other.

It appears, therefore, that by the friction the electric fluid is at the same time developed on the glass and on the cloth.

If after friction the glass be brought into contact with one ball *B*, *fig. 475.*, and the cloth with the other *B'*, other effects will be observed. The glass, when presented to the ball *B'*, will attract it, and the cloth presented to the ball *B* will attract it.

The balls, when brought near each other, will now exhibit mutual attraction instead of repulsion.

It follows, therefore, that the electric fluid developed by friction on the cloth differs from that developed on the glass, inasmuch as instead of being characterized by reciprocal repulsion they are mutually attractive.

The supposition, therefore, which has been briefly stated above will require modification.

1700. *Hypothesis of a single electric fluid*.—According to some, the effect of the friction is to deprive the cloth of a portion of its natural charge of electricity, and to surcharge the glass with what the cloth loses; and accordingly the glass is said to be *positively*, and the cloth *negatively* electrified.

On this supposition, bodies in their natural state have always a certain charge or dose of the electric fluid, the repulsive effect of which is neutralized by the attraction exercised by the body upon it. The electric equilibrium which constitutes this natural state may be deranged, either by overcharging the body with the electric fluid, or by withdrawing from it a part of what it naturally possesses. In the former case, the repulsion of the surplus charge not being neutralized by the attraction of the body takes effect. In the latter case, the attraction of the body being more than equal to the repulsion of the charge of electricity upon it, will take effect upon any electricity which may come within the sphere of its action.

This, which is called the **SINGLE FLUID THEORY**, was the hypothesis adopted by **FRANKLIN**, and after him by most English



electricians until recently, when phenomena were developed in experimental researches, of which it failed to afford a satisfactory explanation; and, accordingly, the hypothesis of two fluids, which was generally received on the Continent, has found more favour also in England.

1701. *Hypothesis of two fluids.*—According to the THEORY OF TWO FLUIDS, bodies in their natural or unelectrified state are charged with a compound electric fluid consisting of two constituent, called by some the VITREOUS and RESINOUS, and by others the POSITIVE and NEGATIVE, fluids. These fluids are each self-repulsive, but are mutually attractive. When they pervade a body in equal quantity, their mutual attractions, neutralizing each other, keep them in repose, like equal weights suspended from the arms of a balance. When either is in excess, the body is positively or negatively electrified, as the case may be, the attraction or repulsion of the surplus of the redundant fluid being effective.

1702. *Results of scientific research independent of these hypotheses.*—Since the language in which the phenomena of electricity are described and explained must necessarily have relation to these hypotheses, it has been necessary in the first instance thus briefly to state them. It must, however, be remembered, that the question of the validity of these theories does not affect the conclusions which will be deduced from observation, the proper use of hypotheses being limited to their convenience in supplying a nomenclature to the science and in grouping and classifying the phenomena.

1703. *Hypothesis of two fluids preferred.*—The hypothesis of two fluids supplying, on the whole, the most complete and satisfactory explanation of the phenomena, is that which we shall here generally adopt; but we shall retain the terms POSITIVE and NEGATIVE electricity, which, though they are derived originally from the theory of a single fluid, are generally adopted by scientific writers who adhere to the other hypothesis.

1704. *Explanation of the above effects produced by the pith balls.*—We are then to consider that when the glass tube and woollen cloth are submitted to mutual friction, their natural electricities are decomposed, the positive fluid passing to the glass, and the negative to the cloth. The glass thus becomes surcharged with positive, and the cloth with negative, electricity.

The pith ball B, *fig. 475.*, touched by the glass, receives the

positive fluid from it, and the pith ball  $B'$  touched by the cloth receives the negative fluid from it. The ball  $B$  therefore becomes positively, and the ball  $B'$  negatively, electrified by contact.

Since the contrary electricities are mutually attractive, the balls  $B$  and  $B'$  in this case attract each other; and, since like electricities are mutually repulsive, the glass rod repels the ball  $B$ , and the cloth repels the ball  $B'$ .

1705. *Electricity developed by various bodies.*—A numerous class of bodies, when submitted to friction, produce effects similar to those described in the case of glass and woollen cloth.

If a stick of resin or sealing-wax be rubbed by a woollen cloth, like effects will follow: but, in this case, the electricity of the wax or resin will be contrary to that of the glass, as may be rendered manifest by the pith balls. If  $B$  be electrified by contact with the glass, and  $B'$  by contact with the resin or wax, they will attract each other, exactly as they did when  $B'$  was electrified by contact with the cloth rubbed upon the glass.

It appears, therefore, that while glass is positively, resin is negatively, electrified by the friction of woollen cloth.

1706. *Origin of the terms vitreous and resinous fluids.*—It was this circumstance which gave the name of VITREOUS electricity to the POSITIVE, and RESINOUS electricity to the NEGATIVE fluid. This nomenclature is, however, faulty; inasmuch as there are certain substances by the friction of which glass will be negatively electrified, and others by which resin will be positively electrified.

When a woollen cloth is rubbed on resin or wax which, as has been stated, it electrifies negatively, it is itself electrified positively; since the natural fluid being decomposed by the friction, and the negative element going to the resin, the positive element must be developed on the cloth.

Thus it appears that the woollen cloth may be electrified by friction either positively or negatively, according as it is rubbed upon resin or upon glass.

1707. *No certain test to determine which of the bodies submitted to friction receives positive, and which negative, electricity.*—In general, when any two bodies are rubbed together, electricity is developed, one of them being charged with the positive, and the other with the negative, fluid. A great number of experimental researches have from time to time been

undertaken, with a view to the discovery of the physical law which determines the distribution of the constituent electric fluids in such cases between the two bodies, so that it might in all cases be certainly known which of the two would be positively, and which negatively, electrified. These inquiries, however, have hitherto been attended with no clear or certain general consequences.

It has been observed, that hardness of structure is generally attended with a predisposition to receive positive electricity. Thus, the diamond, submitted to friction with other stones or with glass, becomes positively electrified. Sulphur, when rubbed with amber, becomes negatively electrified, the amber being consequently positive; but if the amber be rubbed upon glass or diamond, it will be negative.

It is also observed that when heat is developed by the friction of two bodies, that which takes most heat is negatively, and the other positively, electrified.

In short, the decomposition of the electricity and its distribution between the rubbing bodies is governed by conditions infinitely various and complicated.

An elevation of temperature will frequently predispose a body to take negative, which would otherwise take positive, electricity. An increase of polish of the surface produces a predisposition for the positive fluid. The colour, the molecular arrangement, the direction of the fibres in a textile substance, the direction in which the friction takes place, the greater or less pressure used in producing it, all affect more or less in particular cases the interchange of the fluids and the relative electricities of the bodies. Thus, a black silk ribbon rubbed on one of white silk takes negative electricity. If two pieces of the same ribbon be rubbed transversely, one being stationary and the other moved upon it, the former takes positive, the latter negative, electricity. *Æpinus* found that copper and sulphur rubbed together, and two similar plates of glass, evolved electricity, but that the interchange of the fluids was not always the same. There are substances, *disthène*, for example, which, when submitted to friction, develop positive electricity at some parts, and negative at other parts of their surface, although their structure and the state of the surface be perfectly uniform.

1708. *Classification of positive and negative substances.*—Of all known substances, a cat's fur is the most susceptible of

positive, and probably sulphur of negative electricity. Between these extreme substances others might be so arranged, that any substance in the list being rubbed upon any other, that which holds the higher place will be positively, and that which holds the lower place negatively, electrified. Various lists of this kind have been proposed, one of which is as follows:—

- |   |   |
|---|---|
| <ol style="list-style-type: none"> <li>1. Fur of a cat.</li> <li>2. Polished glass.</li> <li>3. Woollen cloth.</li> <li>4. Feathers.</li> <li>5. Wood.</li> </ol> | <ol style="list-style-type: none"> <li>6. Paper.</li> <li>7. Silk.</li> <li>8. Gum lac.</li> <li>9. Rough glass.</li> </ol> |
|---|---|

Pfaff gives the following:—

- |   |   |
|---|---|
| <ol style="list-style-type: none"> <li>1. Fur of a cat.</li> <li>2. Diamond.</li> <li>3. Fur of a dog.</li> <li>4. Tourmaline.</li> <li>5. Glass.</li> <li>6. Wool.</li> <li>7. Paper.</li> </ol> | <ol style="list-style-type: none"> <li>8. White silk.</li> <li>9. Black silk.</li> <li>10. Sealing-wax.</li> <li>11. Colophon.</li> <li>12. Amber.</li> <li>13. Sulphur.</li> </ol> |
|---|---|

Ritter proposes the following:—

- |  |  |
|--|--|
| <ol style="list-style-type: none"> <li>1. Diamond.</li> <li>2. Zinc.</li> <li>3. Glass.</li> <li>4. Copper.</li> <li>5. Wool.</li> </ol> | <ol style="list-style-type: none"> <li>6. Silver.</li> <li>7. Black silk.</li> <li>8. Grey silk.</li> <li>9. Grey manganeseous earth.</li> <li>10. Sulphur.</li> </ol> |
|--|--|

1709. *Method of producing electricity by glass and silk with amalgam.*—Experience has proved that the most efficient means of developing electricity in great quantity and intensity is by the friction of glass upon a surface of silk or leather smeared with an amalgam composed of tin, zinc, and mercury mixed with some unctuous matter. Two parts of tin, three of zinc, and four of mercury, answer very well. Let some fine chalk be sprinkled on the surface of a wooden cup, into which the mercury should be poured hot. Let the zinc and tin melted together be then poured in, and the box being closed and well shaken, the amalgam may be allowed to cool. It is then finely pulverized in a mortar, and being mixed with unctuous matter may be applied to the rubber.

## CHAP. II.

## CONDUCTION.

1710. *Conducting power.*—Bodies differ from each other in a striking manner in the freedom with which the electric fluid moves upon them. If the electric fluid be imparted to a certain portion of the surface of glass or wax, it will be confined strictly to that portion of the surface which originally receives it, by contact with the source of electricity; but if it be in like manner imparted to a portion of the surface of a metallic body, it will instantaneously diffuse itself uniformly over the entire extent of such metallic surface, exactly as water would spread itself uniformly over a level surface on which it is poured.

1711. *Conductors and non-conductors.*—The former class of bodies, which do not give free motion to the electric fluid on their surface, are called NON-CONDUCTORS; and the latter, on which unlimited freedom of motion prevails, are called CONDUCTORS.

1712. *Classification of conductors according to the degrees of their conducting power.*—Of all bodies the most perfect conductors are the metals. These bodies transmit electricity instantaneously, and without any sensible obstruction, provided their dimensions are not too small in relation to the quantity of electricity imparted to them.

The bodies named in the following series possess the conducting power in different degrees in the order in which they stand, the most perfect conductor being first, and the most perfect non-conductor last in the list. The black line divides the most imperfect conductors from the most imperfect non-conductors, but it must be observed that the position of this line is arbitrary, the exact relative position of many of the bodies composing the series not being certainly ascertained. The series, however, will be useful as indicating generally the bodies which have the conducting and non-conducting property in a greater or less degree.

All the metals.  
Well-burnt charcoal.  
Plumbago.  
Concentrated acids.

Powdered charcoal.  
Dilute acids.  
Saline solutions.  
Metallic ores.

Animal fluids.  
 Sea-water.  
 Spring-water.  
 Rain-water.  
 Ice above 13° Fahrenheit.  
 Snow.  
 Living vegetables.  
 Living animals.  
 Flame.  
 Smoke.  
 Steam.  
 Salts soluble in water.  
 Rarefied air.  
 Vapour of alcohol.  
 Vapour of ether  
 Moist earth and stones.  
 Powdered glass.  
 Flowers of sulphur.

---

Dry metallic oxides.  
 Oils, the heaviest the best.  
 Ashes of vegetable bodies.  
 Ashes of animal bodies.  
 Many transparent crystals, dry.  
 Ice below 13° Fahrenheit.  
 Phosphorus.  
 Lime.  
 Dry chalk.  
 Native carbonate of barytes.  
 Lycopodium.

Caoutchouc.  
 Camphor.  
 Some siliceous and argillaceous stones.  
 Dry marble.  
 Porcelain.  
 Dry vegetable bodies.  
 Baked wood.  
 Dry gases and air.  
 Leather.  
 Parchment.  
 Dry paper.  
 Feathers.  
 Hair.  
 Wool.  
 Dyed silk.  
 Bleached silk.  
 Raw silk.  
 Transparent gems.  
 Diamond.  
 Mica.  
 All vitrifications.  
 Glass.  
 Jet.  
 Wax.  
 Sulphur.  
 Resins.  
 Amber.  
 Gum-lac.

1713. *Insulators*.—Good non-conductors are also called **INSULATORS**, because when any body suspended by a non-conducting thread, or supported on a non-conducting pillar, is charged with electricity, such charge will be retained, since it cannot escape by the thread or pillar, which refuses a passage to it in virtue of its non-conducting quality.

Thus, a globe of metal supported on a glass pillar or suspended by a silken cord being charged with electricity, will retain the charge; whereas, if it were supported on a metallic pillar, or suspended by a metallic wire, the electricity would pass away by its free motion over the surface of the pillar or the wire.

1714. *Insulating stools*.—Stools formed with glass legs are called **INSULATING STOOLS**, because any body charged with electricity and placed upon them will retain its electric charge.

1715. *Electrics and non-electrics obsolete terms*.—Conducting bodies were formerly called **NON-ELECTRICS**, and non-conducting bodies were called **ELECTRICS**, from the supposition that the latter were capable of being electrified by friction, but the former not.

The incapability of conductors to be electrified by friction was, however, afterwards shown to be only apparent, and accordingly the use of these terms has been discontinued.

If a rod of metal be submitted to friction, the electricity evolved is first diffused over its entire surface in consequence of its conducting property, and thence it escapes by the hand of the operator which holds it, and which, though not as perfect a conductor as the metal, is sufficiently so to carry off the electricity, so as to leave no sensible trace of it on the metal.

But if the metal rod be suspended by a dry silken thread (which is a good non-conductor), or be supported on a pillar of glass, and then be struck several times with the fur of a cat, it will be found to be negatively electrified, the fur which strikes it being positively electrified.

1716. *Two persons reciprocally charged with contrary electricity when placed on insulating stools.*—In like manner, two persons standing on insulating stools, if one strike the other two or three times with the fur of a cat, he that strikes will have his body positively, and he that is struck negatively, electrified, as may be ascertained by the method already explained, of presenting to them successively the pith ball B, *fig.* 474., previously charged with positive electricity. It will be repelled by the body of him that strikes, and attracted by that of him who is struck.

But if the same experiment be made without placing the two persons on insulating stools, the same effects will not ensue, because, although the electricities are developed as before by the action of the fur, it immediately escapes through the feet to the ground.

1717. *The atmosphere a non-conductor.*—Atmospheric air must manifestly belong to the class of non-conductors, for if it gave a free passage to electricity, the electrical effects excited on the surface of any body surrounded with it would soon pass away; and no electrical phenomena of a permanent nature could be produced, unless the bodies were removed from the contact of the air. It is found, however, that resin and glass, when excited by friction, retain their electricity for a considerable time.

1718. *Rarefied air a conductor.*—Air, however, when rarefied, loses in a great degree its non-conducting property; and an

electrified body soon loses its electricity if placed in the exhausted receiver of an air-pump.

The electric fluid may therefore be considered as forming a coating upon the surface of electrified bodies, and as being held upon them by the tension or pressure of the surrounding air.

1719. *Use of the silk string which suspends pith balls.*—In the experiments described in (1697) *et seq.* with the pith balls, the silken string by which they are suspended acts as an insulator. The pith of elder being a conductor, the electric fluid is diffused over the ball; but the silk being a non-conductor, it cannot escape. If the ball were suspended by a metallic wire attached to a stand composed of any conducting matter, the electricity would escape, and the effects described would not ensue. But if the metallic wire were attached to a glass rod or other non-conductor, the same effects would be produced. In that case the electricity would be diffused over the wire as well as over the ball.

1720. *Water a conductor.*—Water, whether in the liquid or vaporous form, is a conductor, though of an order greatly inferior to the metals. This fact is of great importance in electrical phenomena. The atmosphere contains suspended in it always more or less aqueous vapour, the presence of which impairs its non-conducting property. Hence, electrical experiments always succeed best in cold and dry weather.

Hence it appears why the most perfect non-conductors lose their virtue if their surface be moist, the electricity passing by the conducting power of the moisture.

1721. *Insulators must be kept dry.*—This circumstance also shows why it is necessary to dry previously the bodies on which it is desired to develop electricity by friction.

It will be apparent from what has been explained, that it would be more correct to designate bodies as good and bad conductors in various degrees, than as conductors and non-conductors. There exists no body which, strictly speaking, is either an absolute conductor or absolute non-conductor.

1722. *No certain test to distinguish conductors from non-conductors.*—No relation has been discovered between the physical conditions which determine the conduction of light and heat, and those which determine the conduction of electricity. Electricity is transmitted, not like light and heat, through the



interior dimensions of bodies, but only on their surfaces. Glass, which is an almost perfect conductor of light, is a non-conductor of heat and electricity. Sealing-wax, which is a non-conductor of electricity, is also a non-conductor of light and heat. The metals, on the other hand, are conductors of heat and electricity, but are non-conductors of light. Water is a conductor of electricity and light, but a non-conductor of heat.

1723. *Conducting power variously affected by temperature.*—The conducting power of bodies is affected in different ways by their temperature. In the metals it is diminished by elevation of temperature; but in all other bodies, and especially in liquids, it is augmented. Some substances, which are non-conductors in the solid state, become conductors when fused. Sir H. Davy found that glass raised to a red heat became a conductor; and that sealing-wax, pitch, amber, shell-lac, sulphur, and wax became conductors when liquefied by heat.

The manner in which electricity is communicated from one body to another depends on the conducting property of the body imparting and the body receiving it.

1724. *Effects produced by touching an electrified body by a conductor which is not insulated.*—If the surface of a non-conducting body, glass, for example, be charged with electricity, and be touched over a certain space, as a square inch, by a conducting body which is not insulated, the electricity which is diffused on the surface of contact will pass away by the conductor, but no other part of the electricity with which the body is charged will escape. A *patch* of the surface corresponding with the magnitude of the conductor will alone be stripped of its electricity.

The non-conducting property of the body will prevent the electricity which is diffused over the remainder of its surface from flowing into the space thus drained of the fluid by the conductor.

But if the body thus charged with electricity, and touched by a conductor not insulated, be a conductor, the effects produced will be very different. In that case, the electricity which covers the surface of contact will first pass off; but the moment the surface of contact is thus drained of the fluid which covered it, the fluid diffused on the surrounding surface will flow in and likewise pass off, and thus all the fluid diffused over the entire surface of the body will rush to the surface of con-

tact and escape. These effects, though, strictly speaking, successive, will be practically instantaneous; the time which elapses between the escape of the fluid which originally covered the surface of contact, and that which rushes from the most remote parts to the surface of contact, being inappreciable.

1725. *Effect produced when the touching conductor is insulated.*—If a conducting body which is insulated and charged with electricity, be brought into contact with another conducting body, which is also insulated and in its natural state, the electricity will diffuse itself over the surfaces of both conductors in proportion to their relative magnitudes.

If  $s$  express the superficial magnitude of an insulated conducting body,  $E$  the quantity of electricity with which it is charged, and  $s'$  the superficial magnitude of the other insulated conductor with which it is brought into contact, the charge  $E$  will, after contact, be shared between the two conductors in the ratio of  $s$  to  $s'$ ; so that

$$E \times \frac{s}{s+s'} = \text{the charge retained by } s,$$

$$E \times \frac{s'}{s+s'} = \text{the charge received by } s'.$$

1726. *Why the earth is called the common reservoir.*—If the second conductor  $s'$  be the globe of the earth,  $s'$  will bear a proportion to  $s$  which, practically speaking, is infinite; and consequently the quantity of electricity remaining on  $s$ , expressed by

$$E \times \frac{s}{s+s^n}$$

will be nothing. Hence the body  $s$  loses its entire charge when put in conducting communication with the ground.

An electrified body being a conductor, is therefore reduced to its natural state when put into electric communication with the ground, and the earth has been therefore called the *common reservoir*, to which all electricity has a tendency to escape, and to which it does in fact always escape, unless its passage is intercepted by non-conductors.

1727. *Electricity passes by preference on the best conductors.*—If several different conductors be simultaneously placed in contact with an insulated electrified conductor so as to form a

communication between it and the ground, the electricity will always escape by the best conductor. Thus, if a metallic chain or wire be held in the hand, one end touching the ground and the other being brought into contact with the conductor, no part of the electricity will pass into the hand, the chain being a better conductor than the flesh of the hand. But if, while one end of the chain touch the conductor, the other be separated from the ground, then the electricity will pass into the hand, and will be rendered sensible by a convulsive shock.

## CHAP. III.

### INDUCTION.

1728. *Action of electricity at a distance.*—If a body A charged with electricity of either kind be brought into proximity with another body B in its natural state, the fluid with which A is surcharged will act by attraction and repulsion on the two constituents of the natural electricity of B, attracting that of the contrary, and repelling that of the same kind. This effect is precisely similar to that produced on the natural magnetic fluid in a piece of iron when the pole of a magnet is presented to it.

If the body B in this case be a non-conductor, the electric fluid having no free mobility upon its surface, its decomposition will be resisted, and the body B will continue in its natural state notwithstanding the attraction and repulsion exercised by A on the constituents of its natural electricity. But if B be a conductor, the fluids having freedom of motion on its surface, the fluid similar to that with which B is charged will be repelled to the side most distant from B, and the contrary fluid will be attracted to the side next to B. Between these regions a neutral line will separate those parts of the body B over which the two opposite fluids are respectively diffused.

1729. *Induction defined.*—This action of an electrified body exerted at a distance upon the electricity of another body is called INDUCTION, and is evidently analogous to that which produces similar phenomena in the magnetic bodies (1630).

1730. *Experimental exhibition of its effects.*—To render it experimentally manifest, let  $s$  and  $s'$ , *fig. 476.*, be two metallic

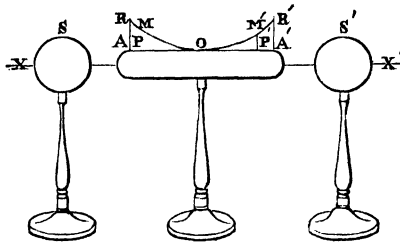

Fig. 476.

balls supported on glass pillars; and let  $AA'$  be a metallic cylinder similarly mounted, whose length is ten or twelve times its diameter, and whose ends are rounded into hemispheres. Let  $s$  be strongly charged with positive, and  $s'$  with negative electricity, the cylinder  $AA'$  being in its natural state.

Let the balls  $s$  and  $s'$  be placed near the ends of the cylinder  $AA'$ , their centres being in line with its axis, as represented in the figure. The positive electricity of  $s$  will now attract the negative, and repel the positive constituent of the natural electricity of  $AA'$ , so as to separate them, drawing the negative fluid towards the end  $A$ , and repelling the positive fluid towards the end  $A'$ . The negative electricity of  $s'$  will produce a like effect, repelling the negative electricity of  $AA'$  towards  $A$ , and drawing the positive towards  $A'$ .

Since the cylinder  $AA'$  is a conductor, and therefore the fluids have freedom of motion on its surface, this decomposition will take effect, and the half  $OA$  of the cylinder next to  $s$  will be charged with negative, and the half  $OA'$  next to  $s'$  with positive electricity.

That such is in fact the condition of  $AA'$  may be proved by presenting a pith ball (1697) pendulum charged with positive electricity to either half of the cylinder. When presented to  $OA'$  it will be repelled, and when presented to  $OA$  it will be attracted.

If the two balls  $ss'$  be gradually removed to increased but equal distances from the ends  $A$  and  $A'$ , the recomposition of the fluids will gradually take place; and when the balls are altogether

removed the cylinder  $AA'$  will recover its natural state, the fluids which had been separated by the action of the balls being completely recombined by their mutual attraction.

Let a metallic ring  $n'$ , *fig. 477.*, be supported on a rod or hook of glass  $n$ , and let two pith balls  $b b'$  be suspended from it by fine wires, so that when hanging vertically they shall be in contact. Let a ball of metal  $r$ , strongly charged with positive electricity, be placed over the ring  $n'$  at a distance of eight or ten inches above it. The presence of this ball will immediately cause the pith balls to repel each other, and they will diverge to increased distances the nearer the ball  $r$  is brought to the ring  $n'$ . If the ball  $r$  be gradually raised to greater distances from the ring, the balls  $b b'$  will gradually approach each other, and will fall to their position of rest vertically under the ring when the ball  $r$  is altogether removed.

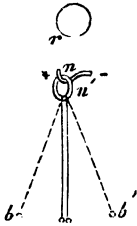

*Fig. 477.*

If the charge of electricity of the balls  $s$  and  $s'$ , *fig. 476.*, or of the ball  $r$ , *fig. 477.*, be gradually diminished, the same effect will be produced as when the distance is gradually increased; and, in like manner, the gradual increase of the charge of electricity will have the same effect as the gradual diminution of the distance from the conductor on which the action takes place.

If the ring  $n'$ , the balls  $b b'$ , and the connecting wire be first feebly charged with negative electricity, and then submitted to the inductive action of the ball  $r$  charged with positive electricity, placed, as before, above the ring, the following effects will ensue. When the ball  $r$  approaches the ring, the balls  $b b'$ , which previously diverged, will gradually collapse until they come into contact. As the ball  $r$  is brought still nearer to  $n'$ , they will again diverge, and will diverge more and more, the nearer the ball  $r$  is brought to the ring.

These various effects are easily and simply explicable by the action of the electricity of the ball  $r$  on that of the ring. When it approaches the ring, the positive electricity with which it is charged decomposes the natural electricities of the ring, repelling the positive fluid towards the balls. This fluid combining with the negative fluid with which the balls are charged, neutralizes it, and reduces them to their natural state: while this effect is gradually produced, the balls  $b b'$  lose their divergence

and collapse. But when the ball  $r$  is brought still nearer to the ring, a more abundant decomposition of the natural fluid is produced, and the positive fluid repelled towards the balls is more than enough to neutralize the negative fluid with which they are charged; and the positive fluid prevailing, the balls again diverge with positive electricity.

These effects are aided by the attraction exerted by the positive electricity of the ball  $r$  on the negative fluid with which the balls  $b b'$  are previously charged.

If the electrified ball, instead of being placed above the ring, be placed at an equal distance below the balls  $b b'$ , a series of effects will be produced in the contrary order, which the student will find no difficulty in analysing and explaining.

If the ball  $r$  be charged with negative electricity, it will produce the same effects when presented above the ring as when, being charged with positive electricity, it is presented below it.

In all cases whatever, the conductor whose electrical state has been changed by the proximity of an electrified body returns to its primitive electrical condition when the disturbing action of such body is removed; and this return is either instantaneous or gradual, according as the removal of the disturbing body is instantaneous or gradual.

1731. *Effects of sudden inductive action.*—It appears, therefore, that sudden and violent changes in the electrical condition of a conducting body may take place, without either imparting to or abstracting from such body any portion of electricity. The electricity with which it is invested before the inductive action commences, and after such action ceases, is exactly the same; nevertheless, the decomposition and recomposition of the constituent fluids, and their motion more or less sudden over it and through its dimensions, are productive often of mechanical effects of a very remarkable kind. This is especially the case with imperfect conductors, which offer more or less resistance to the reunion of the fluids.

1732. *Example in the case of a frog.*—Let a frog be suspended by a metallic wire which is connected with an insulated conductor, and let a metallic ball, strongly charged with positive electricity, be brought under without, however, touching it. The effects of induction already described will ensue. The positive fluid will be repelled from the frog towards the insulated

conductor, and the negative fluid will be attracted towards it, so that the body of the frog will be negatively electrified; but this taking place gradually as the electrified ball approaches, is attended with no sensible mechanical effect.

If the electrified ball, however, be suddenly discharged, by connecting it with the ground by a conductor, an instantaneous revulsion of the electric fluids will take place between the body of the frog and the insulated conductor with which it is connected; the positive fluid rushing from the conductor, and the negative fluid from the frog, to recombine in virtue of their mutual attraction. This sudden movement of the fluids will be attended by a convulsive motion of the limbs of the frog.

1733. *Inductive shock of the human body.*—If a person stand close to a large conductor strongly charged with electricity, he will be sensible of a shock when this conductor is suddenly discharged. This shock is in like manner produced by the sudden recomposition of the fluids in the body of the patient, by the previous inductive action of the conductor.

1734. *Development of electricity by induction.*—A conductor may be charged with electricity by an electrified body, though the latter shall not lose any of its own electricity or impart any to the conductor so electrified. For this purpose, let the conductor to be electrified be supported on a glass pillar so as to insulate it, and let it then be connected with the ground by a metallic chain or wire. If it be desired to charge it with positive electricity, let a body strongly charged with negative electricity be brought close to it without touching it. On the principles already explained, the negative electricity of the conductor will be repelled to the ground through the chain or wire; and the positive electricity will, on the other hand, be attracted from the ground to the conductor. Let the chain or wire be then removed, and, afterwards, let the electrified body by whose inductive action the effect is produced be removed. The conductor will remain charged with positive electricity.

It may in like manner be charged with negative electricity, by the inductive action of a body charged with positive electricity.

## CHAP. IV.

## ELECTRICAL MACHINES.

1735. *Parts of electrical machines.*—An electrical machine is an apparatus by means of which electricity is developed and accumulated in a convenient manner for the purposes of experiment.

All electrical machines consist of three principal parts, the rubber, the body on whose surface the electric fluid is evolved, and one or more insulated conductors, to which this electricity is transferred, and on which it is accumulated.

The rubber is a cushion stuffed with hair, bearing on its surface some substance, which by friction will evolve electricity. The body on which this friction is produced is glass, so shaped and mounted as to be easily and rapidly moved against the rubber with a continuous motion. This object is attained by giving the glass the form either of a cylinder revolving on its geometrical axis, or of a circular plate revolving in its own plane on its centre.

The conductors are bodies having a metallic surface and a great variety of shapes, and always mounted on insulating pillars, or suspended by insulating cords.

1736. *The common cylindrical machine.*—A hollow cylinder of glass *A B*, *fig. 478.*, is supported in bearings at *c*, and made to

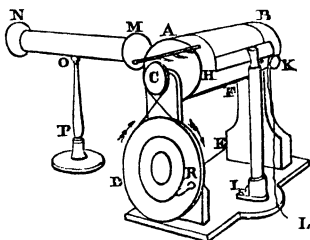

Fig. 478.

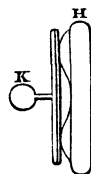

Fig. 479.

revolve by means of the wheels *c* and *D* connected by a band, a handle *R* being attached to the greater wheel. The cushion *H*, represented separately in *fig. 479.*, is mounted on a glass pillar,



and pressed with a regulated force against the cylinder by means of springs fixed behind it. A chain  $\kappa I$ , *fig. 478.*, connects the cushion with the ground. A flap of black silk equal in width to the cushion covers it, and is carried over the cylinder, terminating above the middle of the cylinder on the opposite side.

The conductor is a cylinder of thin brass  $m N$ , the ends of which are parts of spheres greater than hemispheres. It is supported by a glass pillar  $o P$ . To the end of the conductor next the cylinder is attached a row of points represented separately in *fig. 480*, which are presented close to the surface of the cylinder, but without touching it. The extent of this row of points corresponds with that of the rubber.

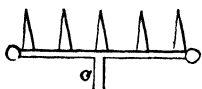

Fig. 480.

As the efficient performance of the machine depends in a great degree on the good insulation of the several parts, and as glass is peculiarly liable to collect moisture on its surface which would impair its insulating virtue, it is usual to cover the insulating pillars of the rubber and conductor, and all that part of the cylinder which lies outside the cushion and silk flap, with a coating of resinous varnish, which, while its insulating property is more perfect than that of glass, offers less attraction to moisture.

To explain the operation of the machine, let us suppose that the cylinder is made to revolve by the handle  $\kappa$ . Positive electricity is developed upon the cylinder, and negative electricity on the cushion. The latter passes by the conducting chain to the ground. The former is carried round under the flap, on the surface of the glass, until it arrives at the points projecting from the conductor. There it acts by induction (1729) on the natural electricity of the conductor, attracting the negative electricity to the points and repelling the positive fluid. The negative electricity issuing from the points combines with and neutralizes the positive fluid diffused on the cylinder, the surface of which, after it passes the points, is therefore restored to its natural state, so that when it arrives again at the cushion it is prepared to receive by friction a fresh charge of the positive fluid.

It is apparent, therefore, that the effect produced by the operation of this machine is a continuous decomposition of the natural electricity of the conductors, and an abstraction from it of just so much negative fluid as compensates for that which

escapes by the cushion and chain  $\kappa L$  to the earth. The conductor is thus as it were drained of its negative electricity by a stream of that fluid, which flowing constantly from the points passes to the cylinder, and thence by the cushion and chain to the earth. The conductor is therefore left surcharged with positive electricity.

1737. *Nairne's cylinder machine.*—This apparatus, which is adapted to produce at pleasure either positive or negative electricity, is similar to the last, but has a second conductor  $MF$ , *fig. 481.*, in connection with the cushion. When it is desired to collect positive electricity, the conductor  $MF$  is put in connection with the ground, and the machine acts as that described above. When it is desired to collect negative electricity, the conductor  $M'B$  is put in connection with the ground, and the conductor  $MF$  is insulated. In this case a stream of positive electricity flows continually from  $MF$  through the cushion to the cylinder, and thence by the conductor  $M'B$  to the ground, leaving the conductor  $MF$  charged with negative electricity.

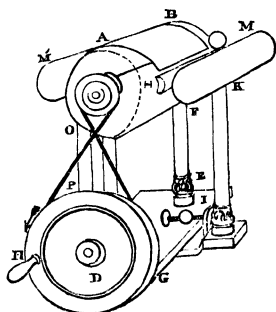

Fig. 481.

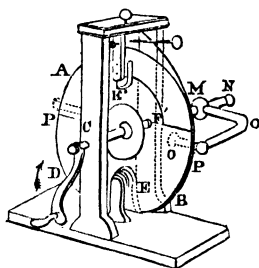

Fig. 482.

1738. *Common plate machine.*—This apparatus consists of a circular plate of glass  $AB$ , *fig. 482.*, mounted as represented in the figure. It is embraced between two pair of cushions at  $E$  and  $E'$ , a corresponding width of the glass being covered by a silk sheathing extending to  $F'$ , where the points of the conductors are presented. The handle being turned in the direction of the arrow, and the cushions being connected by conducting chains with the ground, positive electricity is developed on the glass, and neutralized as in the cylinder machine, by the negative electricity received by induction from the con-

ductors, which consist of a long narrow cylinder, bent into a form to adapt it to the plate. It is represented at  $MN$ , a branch  $MO$  being carried parallel to the plate and bent into the form  $MOPQ$ , so that the part  $PQ$  shall be presented close to the plate under the edge of the silk flap. A similar branch of the conductor extends on the other side, terminating just above the edge of the lower silk flap.

The principle of this machine is similar in all respects to that of the common cylinder machine. With the same weight and bulk, the extent of rubbing surface, and consequently the evolution of electricity, is much greater than in the cylinder machines.

1739. *Armstrong's hydro-electrical machine.*—A new species of electric machine has resulted from the accidental observation of an electric shock produced by the contact of a jet of high pressure steam issuing from a boiler at Newcastle-on-Tyne in 1840. Mr. Armstrong of that place took up the inquiry, and succeeded in contriving a machine for the production and accumulation of the electricity by the agency of steam. Professor Faraday investigated the theory of the apparatus, and showed that the origin of the electrical development was the friction of minute aqueous particles produced by the partial condensation of the steam against the surface of the jet from which the steam issued.

The hydro-electric machine has since been constructed in various forms and dimensions.

Let a cylindrical boiler  $a$ , *fig.* 483., whose length is about twice its diameter, be mounted on glass legs  $v$ , so as to be in a state of insulation.

$f$  is the furnace door, the furnace being a tube within the boiler.

$s$  is the safety-valve.

$h$  is the water-gauge, a glass tube indicating the level of the water in the boiler.

$r$  a regulating valve, by which the escape of steam from the boiler may be controlled.

$t$  a tube into which the steam rushes as it escapes from  $r$ .

$e$  three or more jet pipes, through which the steam passes from  $t$ , and from the extremities of which it issues in a series of parallel jets.

$d$  a condensing box, the lower half of which contains water at the common temperature.

*g* the chimney.

*g'* an escape pipe for the vapour generated in the condensing box *d*.

*b* the conductor which takes from the steam the electricity which issues with it from the jet pipes *e*.

*k* the knob of the conductor from which the electricity may be received and collected for the purpose of experiment.

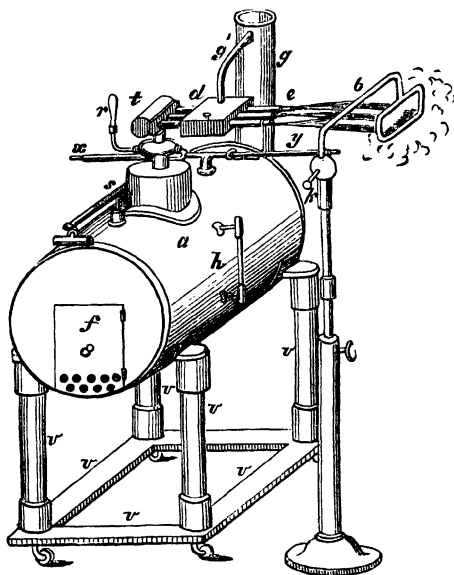

Fig. 483.

The jet pipes *e* traverse the middle of the condensing box *d*, above the surface of the water contained in it. Meshes of cotton thread surround these tubes within the box, the ends of which are immersed in the water. The water is drawn up by the capillary action of these threads, so as to surround the tubes with a moist coating, which by its low temperature produces a slight condensation of the steam as it passes through that part of the tube.

The fine aqueous particles thus produced within the tube are carried forward with the steam, and on issuing through the jet pipe rub against its sides. This friction decomposes the natural

electricity, the negative fluid remaining on the jet, and the positive being carried out with the particles of water, and imparted by them to the conductor *b*.

It will be apparent that in this arrangement the interior surface of the jet plays the part of the rubber of the ordinary machine, and the particles of water that of the glass cylinder or plate, the steam being the moving power which maintains the friction.

In order to ensure the efficiency of the friction, the conduit provided for the escape of the steam is not straight but angular.

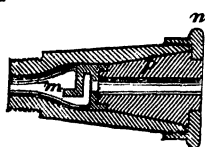

Fig. 483 *a*.

A section of the jet pipe near its extremity is represented in *fig. 483 a*. The steam issuing from the box *b* encounters a plate of metal *m* which intercepts its direct passage to the mouth of the jet. It is compelled to turn downwards, pass under the edge of this plate, and, rising behind it, turn again into the escape pipe, which is a tube formed of particle wood enclosed with in the metal pipe *n*.

It is found that an apparatus thus constructed, the length of the boiler being 32 inches and its diameter 16 inches, will develop as much electricity in a given time as three common plate machines, whose plates have a diameter of 40 inches, and are worked at the rate of 60 revolutions per minute.

A machine on this principle, and on a great scale of magnitude, was erected by the Royal Polytechnic Institution of London, the boiler of which was 78 inches long, and 42 inches diameter. The maximum pressure of the steam at the commencement of the operation was sometimes 90 lbs. per sq. inch. This, however, fell to 40 lbs. or less. Sparks have been obtained from the conductor at the distance of 22 inches.

1740. *Appendages to electrical machines*.—To facilitate the performance of experiments, various accessories are usually provided with these machines.

1741. *Insulating stools*.—Insulating stools, constructed of strong, hard wood, well baked and dried, and supported on legs of glass coated with resinous varnish, are useful when it is required to keep for any time any conducting body charged with electricity. The body is placed on one of these stools while it is being electrified.

Thus, two persons standing on two such stools, may be

charged, one with positive, and the other with negative, electricity. If, when so charged, they touch each other, the contrary electricities will combine, and they will sustain a nervous shock proportionate to the quantity of electricity with which they were charged.

1742. *Discharging rods.*—Since it is frequently necessary to observe the effects of points and spheres, pieces such as *figs.* 484, 485. are provided, to be inserted in holes in the conductors; also metallic balls, *figs.* 486, 487., attached to glass handles for cases in which it is desired to apply a conductor to an electrified body without allowing the electricity to pass to the hand of the operator. With these rods the electricity may be taken from a conductor gradually by small portions, the ball taking by each contact only such a fraction of the whole charge as corresponds to the ratio of the surface of the ball to the surface of the conductor.

1743. *Jointed dischargers.*—To establish a temporary connection between two conductors, or between a conductor and the ground, the jointed dischargers, *figs.* 488, 489., are useful. The distance between the balls can be regulated at pleasure by means of the joint or hinge by which the rods are united.

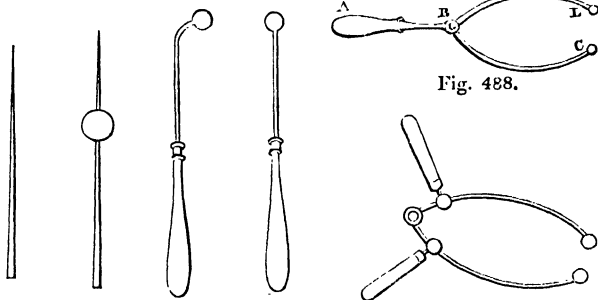

Fig. 484. Fig. 485. Fig. 486. Fig. 487.

Fig. 489.

1744. *Universal discharger.*—The universal discharger, an instrument of considerable convenience and utility in experimental researches, is represented in *fig.* 490. It consists of a wooden table to which two glass pillars A and A' are attached. At the summit of these pillars are fixed two brass joints capable of revolving in a horizontal plane. To these joints are at-

tached brass rods  $CC'$ , terminated by balls  $DD'$ , and having glass handles  $EE'$ . These rods play on joints at  $BB'$ , by which they can be moved in vertical planes.

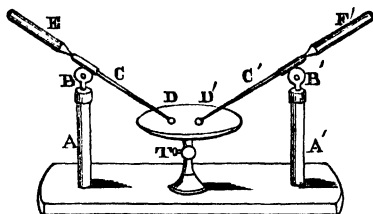

Fig. 490.

The balls  $DD'$  are applied to a wooden table sustained on a pillar capable of having its height adjusted by a screw  $T$ . On the table is inlaid a long narrow strip of ivory extending in the direction of the balls  $DD'$ . These balls  $DD'$  can be unscrewed, and one or both may be replaced by forceps, by which may be held any substance through which it is desired to transmit the electric charge. One of the brass rods  $C$  is connected by chain or a wire with the source of electricity, and the other with the ground.

The electricity is transmitted by bringing the balls  $DD'$  with the substance to be operated on between them, within such a distance of each other as will cause the charge to pass from one to the other through the introduced substance.

## CHAP. V.

### CONDENSER AND ELECTROPHOROUS.

1745. *Reciprocal inductive effects of two conductors.*—If a conductor  $A$  communicating with the ground be placed near another conductor  $B$  insulated and charged with a certain quantity of electricity  $E$ , a series of effects will ensue by the reciprocal inductive power of the two conductors, the result of which will be that the quantity of electricity with which  $B$  is charged will be augmented in a certain proportion, depending on the distance between the two conductors through which the

inductive force acts. The less this distance is the more energetic the induction will be, and the greater the augmentation of the charge of the conductor B.

To explain this, we are to consider that the electricity  $\epsilon$ , acting on the natural electricity of A, repels a certain quantity of the fluid of the same name to the earth, retaining on the side of A next to B the fluid of the contrary name. This fluid of a contrary name thus developed in A reacts upon the natural electricity of B, and produces a decomposition in the same manner, augmenting the charge  $\epsilon$  by the fluid of the same name decomposed, and expelling the other fluid to the more remote side of B. This increased fluid in B again acts upon the natural electricity of A, producing a further decomposition; and this series of reciprocal inductive actions producing a succession of decompositions in the two conductors, and accumulating a *tide* of contrary electricities on the sides of the conductors which are presented towards each other, goes on through an indefinite series of reciprocal actions, which, nevertheless, are accomplished in an inappreciable interval of time; so that, although the phenomenon in a strict sense is *physically* progressive, it is *practically* instantaneous.

To obtain an arithmetical measure of the amount of the augmentation of the electrical charge produced in this way, let us suppose that a quantity of electricity on B, which we shall take as the unit, is capable of decomposing on A a quantity which we shall express by  $m$ , and which is necessarily less than the unit, because nothing short of actual contact would enable the electricity of B to decompose an equal quantity of the electricity of A.

If, then, the unit of positive electricity act from B upon A, it will decompose the natural electricity, expelling a quantity of the positive fluid expressed by  $m$ , and retaining on the side next to B an equal quantity of the negative fluid. Now, this negative fluid  $m$  acting on the natural electricity of B at the same distance will produce a proportionate decomposition, and will develop on the side of B next to A an additional quantity of the positive fluid, just so much less than  $m$  as  $m$  is less than 1. This quantity will therefore be  $m \times m$ , or  $m^2$ .

This quantity  $m^2$  of positive fluid again acting by induction on A, will develop, as before, a quantity of negative fluid expressed by  $m^2 \times m$ , or  $m^3$ . And in the same manner



this will develop on B an additional quantity of positive fluid expressed by  $m^3 \times m$ , or  $m^4$ . These inductive reactions being indefinitely repeated, let the total quantity of positive electricity developed on B be expressed by P, and the total quantity of negative electricity developed on A by N, we shall have

$$\begin{aligned} P &= 1 + m^2 + m^4 + m^6 + \dots \dots \dots \&c. \text{ ad inf.} \\ N &= m + m^3 + m^5 + m^7 + \dots \dots \dots \&c. \text{ ad inf.} \end{aligned}$$

Each of these is a geometrical series; and, since  $m$  is less than 1, they are decreasing series. Now, it is proved in arithmetic, that although the number of terms in such series be unlimited, their sum is finite, and that the sum of the unlimited number of terms composing the first series is  $\frac{1}{1-m^2}$ , and that of the second  $\frac{m}{1-m^2}$ . We shall therefore have

$$P = \frac{1}{1-m^2}, \quad N = \frac{m}{1-m^2}.$$

In this case we have supposed the original charge of the conductor B to be the unit. If it consist of the number of units expressed by E, we shall have

$$P = \frac{E}{1-m^2}, \quad N = \frac{m \times E}{1-m^2}.$$

It follows, therefore, that the original charge E of the conductor B has been augmented in the ratio of 1 to  $1-m^2$  by the proximity of the conductor A.

The less is the distance between the conductors A and B, the more nearly  $m$  will be equal to 1, and therefore the greater will be the ratio of 1 to  $1-m^2$ , and consequently the greater will be the augmentation of the electrical charge of B produced by the presence of A.

For example, suppose that A be brought so near B, that the positive fluid on B will develop nine-tenths of its own quantity of negative fluid on A. In that case  $m = \frac{9}{10} = 0.9$ . Hence it appears, that  $1-m^2 = 1-0.81 = 0.19$ ; and, consequently, the charge of B will be augmented in the ratio of 0.19 to 1, or of 19 to 100.

1746. *Principle of the condenser.*—In such cases the electricity is said to be CONDENSED on the conductor B by the in-

ductive action of the conductor A, and apparatus constructed for producing this effect are called **CONDENSERS**.

1747. *Dissimulated or latent electricity*.—The electricity developed in such cases on the conductor A is subject to the anomalous condition of being incapable of passing away, though a conductor be applied to it. In fact, the conductor A in the preceding experiment is supposed to be connected with the earth by conducting matter, such as a chain, metallic column, or wire. Yet the charge of electricity N does not pass to the earth as it would immediately do if the conductor B were removed.

In like manner, all that portion of the positive fluid P which is developed on B by the inductive action of A, is held there by the influence of A, and cannot escape even if the conductors be applied in contact with it.

Electricity thus developed upon conductors and retained there by the inductive action of other conductors, is said to be *latent* or *dissimulated*. It can always be set *free* by the removal of the conductors by whose induction it is dissimulated.

1748. *Free electricity*.—Electricity, therefore, which is developed independently of induction, or which, being first developed by induction, is afterwards liberated from the inductive action, is distinguished as *free electricity*.

In the process above described, that part of the charge P of the conductor B which is expressed by E, and which was imparted to B before the approach of the conductor A, is *free*, and continues to be free after the approach of E. If a conductor connected with the earth be brought into contact with B, this electricity E will escape by it; but all the remaining charge of B will remain, so long as the conductor A is maintained in its position.

If, however, E be discharged from B, the charge which remains will not be capable of retaining in the dissimulated state so great a quantity of negative fluid on A as before. A part will be accordingly set free, and if A be maintained in connection with the ground it will escape. If A be insulated, it will be charged with it still, but in a free state.

If this free electricity be discharged from A, the remaining charge will not be capable of retaining in the latent state so large a quantity of positive fluid on B as previously, and a part of what was dissimulated will accordingly be set free, and may be discharged.

In this manner, by alternate discharges from the one and the other conductor, the dissipated charges may be gradually liberated and dismissed, without removing the conductors from one another or suspending their inductive action.

1749. *Forms of condensers.*—Condensers are constructed in various forms, according to the strength of the electric charges they are intended to receive. Those which are designed for strong charges require to have the two conductors separated by a non-conducting medium of some considerable thickness, since, otherwise, the attraction of the opposite fluids diffused on A and B would take effect; and they would rush to each other across the separating space, breaking their way through the insulating medium which divides them. In this case, the distance between A and B being considerable, the condensing power will not be great, nor is it necessary to be so, since the charges of electricity are by the supposition not small or feeble.

In case of feeble charges, the space separating the conductors may be proportionally small, and, consequently, the condensing power will be greater.

Condensers are usually constructed with two equal circular plates, either of solid metal or having a metallic coating.

1750. *Collecting and condensing plates.*—The plate corresponding to the conductor A in the preceding paragraphs is called the CONDENSING PLATE, and that which corresponds to B the COLLECTING PLATE. The collecting plate is put in communication with the body whose electrical state it is required to examine by the agency of the condenser, and the condensing plate is put in communication with the ground.

1751. *Cuthbertson's condenser.*—A form of condenser contrived by Cuthbertson is represented in *fig.* 491. The collecting plate B is supported on a glass pillar, and communicates by a chain attached to the hook D with the source of electricity under examination. The condensing plate A is supported on a brass pillar, movable on a hinge, and communicating with the ground. By means of the hinge the disk A may be moved to or from B. The space between the plates in this case may be merely air, or, if strong charges are used, a plate of glass may be interposed.

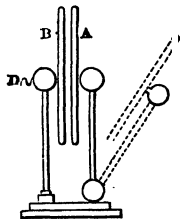

Fig. 491.

When used for feeble charges, it is usual to

cover the condensing plate with a thin coating of varnished silk, or simply with a coating of resinous varnish. An instrument thus arranged is represented in *fig. 492.*, where  $b b'$ , the condensing plate, is a disk of wood coated with varnished silk  $t t'$ . The collecting plate  $c c'$  has a glass handle  $m$ , by which it may be raised, and a rod of metal  $a b$  by which it may be put in communication with the source of electricity under examination.

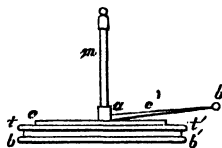

Fig. 492.

The condensing plate in this case has generally sufficient conducting power when formed of wood, but may be also made of metal, and, instead of varnished silk, it may be coated with gum-lac, resin, or any other insulator.

When the plate  $c c'$  has received its accumulated charge, its connection with the source of electricity is broken by removing the rod  $a b$ ; and the plate  $c c'$  being raised from the condensing plate, the entire charge upon it becomes free, and may be submitted to any electroscopic test.

1752. *The electrophorous.*—A small charge of free electricity may by the agency of induction be made to produce a charge of indefinite amount, which may be imparted to any insulated conductor. This is effected by the *electrophorous*, an instrument consisting of a circular cake, composed of a mixture of shell-lac, resin, and Venice turpentine, cast in a tin mould  $A B$ , *fig. 493.* Upon this is laid a circular metallic disk  $c$ , rather less in diameter than  $A B$ , having a glass handle.

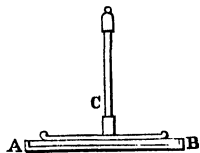

Fig. 493.

Before applying the disk  $c$ , the resinous surface is electrified negatively by striking it several times with the fur of a cat. The disk  $c$  being then applied to the cake  $A B$ , and the finger being at the same time pressed upon the disk  $c$  to establish a communication with the ground through the body of the operator, a decomposition takes place by the inductive action of the negative fluid on the resin. The negative fluid escapes from the disk  $c$  through the body of the operator to the ground, and a positive charge remains, which is prevented from passing to the resin partly by the thin film of air which will always remain between them even when

the plate c rests upon the resin, and partly by the non-conducting virtue of the resin.

When the disk c is thus charged with positive electricity kept latent on it by the influence of the negative fluid on A B, the finger being previously removed from the disk c, let it be raised from the resin and the electricity upon it, before dissipated, will become free, and may be imparted to any insulated conductor adapted to receive it.

The charge of negative electricity remaining undiminished on the resin A B, the operation may be indefinitely repeated; so that an insulated conductor may then be charged to any extent, by giving to it the electric fluid drop by drop thus evolved on the disk c by the inductive action of A B.

This is the origin of the name of the apparatus.

## CHAP. VI.

### ELECTROSCOPES.

1753. *General principle of electroscopes.*—Electroscopes in general consist of two light conducting bodies freely suspended, which hang vertically and in contact, in their natural state. When electricity is imparted to them they repel each other, the angle of their divergence being greater or less according to the intensity of the electricity diffused on them. These electroscopic substances may be charged with electricity either by direct communication with the electrified body, in which case their electricity will be similar to that of the body; or they may be acted upon inductively by the body under examination, in which case their electricity may be either similar or different from that of the body, according to the position in which the body is presented to them. In some cases, the electroscope consists of a single light conductor to which electricity of a known species is first imparted, and which will be attracted or repelled by the body under examination when presented to it, according as the electricities are like or unlike.

These instruments vary infinitely in form, arrangement, mode

of application, and sensitiveness, according to the circumstances under which they are placed, and the intensities of the electricities of which they are expected to detect the presence, measure the intensity, or indicate the quality. In electroscopes, as in all other instruments of physical inquiry, the most delicate and sensitive is only the most advantageous in those cases in which much delicacy and precision are required. A razor would be an ineffectual instrument for felling timber.

1754. *Pith ball electroscope.*—One of the most simple and generally useful electroscopic instruments is the pendulous pith ball already mentioned (1697), the action of which may now be more fully explained. When an electrified body is presented to such a ball suspended by a silken thread, it acts by induction upon it, decomposing its natural fluid, attracting the constituent of the contrary name to the side of the ball nearest to it, and repelling the fluid of the same name to the side most remote from it. The body will thus act at once by attraction and repulsion upon the two fluids; but since that of a contrary name which it attracts is nearer to it than that of the same name which it repels, and equal in quantity, the attraction will prevail over the repulsion, and the ball will move towards the electrified body. When it touches it, the fluid of a contrary name, which is diffused round the point of contact, combining with the fluid diffused upon the body, will be neutralized, and the ball will remain charged with the fluid of the same name as that with which the body is electrified, and will consequently be repelled by it. Hence it will be understood why, as already mentioned, the pith ball in its neutral state is first attracted to an electrified body, and after contact with it repelled by it.

1755. *The needle electroscope.*—The electric needle is an electroscopic apparatus, somewhat less simple, but more sensitive than the pendulum. It consists of a rod of copper terminated by two metallic balls B and B', *fig.* 494., which are formed hollow in order to render them more light and sensitive. At the middle point of the rod which connects them is a conical cup, formed of steel or agate, suspended upon a fine point, so that the needle is exactly balanced, and capable of turning freely round the point of support in a horizontal plane,

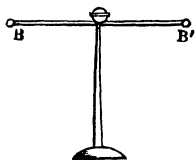

Fig. 494.

like a magnetic needle. A very feeble electrical action exerted upon either of the balls B or B' will be sufficient to put the needle in motion.

1756. *Coulomb's electroscope*. — The electroscope of Coulomb, better known as the balance of torsion, is an apparatus still more sensitive and delicate for indicating the existence and intensity of electrical force. A needle  $gg'$ , *fig. 495.*, formed of gum-lac, is suspended by a fibre of raw silk  $f$ . At one extremity it carries a small disk  $e$ , coated with metallic foil, and is so balanced at the point of suspension, that the needle resting horizontally is free to turn in either direction round the point of suspension. When it turns, it produces a degree of torsion or twist of the fibre which suspends it, the reaction of which measures the force which turns the needle. The thread is fixed at the top to a small windlass  $t$ , by which the needle can be raised or lowered, and the whole is included in a glass cage, to preserve the apparatus from the disturbance of the air. Upon this glass cage, which is cylindrical, is a graduated circle  $dd'$ , which measures the angle through which the needle is deflected. In the cover of

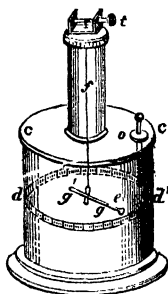

Fig. 495.

the cage an aperture  $o$  is made, through which may be introduced the electrified body whose force it is desired to indicate and measure by the apparatus.

1757. *Quadrant electrometer*. — This instrument, which is generally used as an indicator on the conductors of electrical machines, consists of a pillar  $AB$ , *fig. 496.*, of any conducting substance, terminated at the lower extremity by a ball  $B$ . A rod, also a conductor, of about half the length, terminated by a small pith ball  $D$ , plays on a centre  $C$  in a vertical plane, having behind it an ivory semicircle graduated. When the ball  $B$  is charged with electricity, it repels the pith ball  $D$ , and the angle of repulsion measured on the graduated arc supplies a rough estimate of the intensity of the electricity.

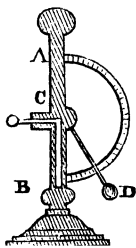

Fig. 496.

1758. *Gold leaf electroscope*. — A glass cylinder  $ABCD$ , *fig.*

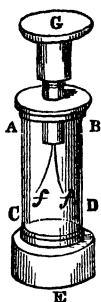

Fig. 497. 497., is connected to a brass stand *E*, and closed at the top by a circular plate *A B*. The brass top *G* is connected by a metallic rod with two slips of gold leaf *f*, two or three inches in length, and half an inch in breadth. In their natural state they hang in contact, but when electricity is imparted to the plate *G*, the leaves becoming charged with it indicate its presence, and in some degree its intensity, by their divergence. On the sides of the glass cylinder opposite the gold leaves are attached strips of tinfoil, communicating with the ground. When the leaves diverge so much as to touch the sides of the cylinder, they give up their electricity to the tinfoil, and are discharged. This instrument may also be affected inductively. If the electrified body be brought near to the plate *G*, its natural electricity will be decomposed; the fluid of the same name as that with which the body is charged will be repelled, will accumulate in the gold leaves, and will cause them to diverge.

1759. *Condensing electroscopie*.—The condenser applied to the electroscopie supplies an instrument which has the same analogy to the common electroscopie as the compound has to the simple microscope. An electroscopie with such an appendage is represented in *fig. 498*. The condenser is screwed on the top, the condensing plate communicating with the electroscopie, and the collecting plate being laid over it. When the collecting plate is put into communication with the source of electricity to be examined, a charge is produced by induction in the condensing plate under it, and a charge of a contrary name is collected in the electroscopie, the leaves of which will diverge in this case with an electricity similar in name to that of the body under examination.

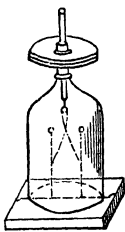

Fig. 498.

In the use of instruments of such extreme sensitiveness, many precautions are necessary to guard against disturbances, which would interfere with their indications, and expose the observer to errors. The plates of the condenser in some experiments may be exposed to chemical action, which, as will hereafter appear, is always combined with the development of electricity. In such cases, the condenser of the electroscopie should be composed of



gilt plates. The apparatus is sometimes included in a glass case, to protect it from atmospheric vicissitudes; and to preserve it from hygrometric effects, a cup of quicklime is placed in the case to absorb the humidity. The plates of the condenser attached to electroscopes vary from four to ten inches in diameter. When greater dimensions are given to them, it is difficult to make them with such precision as to ensure the exact contact of their surfaces.

Becquerel used plates of glass twenty inches in diameter, accurately ground together with emery, and coated with thin tin-foil. This apparatus had great sensibility, but as the metal was very oxidable, the results were disturbed by chemical effects not easily avoided. A coating of platinum or gold would have been more free from disturbing action.

## CHAP. VII.

### THE LEYDEN JAR.

THE inductive principle which has supplied the means in the case of the condenser of detecting and examining quantities of electricity so minute and so feeble as to escape all common tests, has placed, in the Leyden jar, an instrument at the disposal of the electrician by which artificial electricity may be accumulated in quantities so unlimited as to enable him to copy in some of its most conspicuous effects the lightning of the clouds.

To understand the principle of the Leyden jar, which at one time excited the astonishment of all Europe, it is only necessary to investigate the effect of a condenser of considerable magnitude placed in connection, not with feeble, but with energetic sources of electricity, such as the prime conductor of an electrical machine. In such case it would be evidently necessary that the collecting and condensing plates should be separated by a non-conducting medium of sufficient resistance to prevent the union of the powerful charges with which they would be invested.

Let A B, *fig.* 499., represent the collecting plate of such a con-

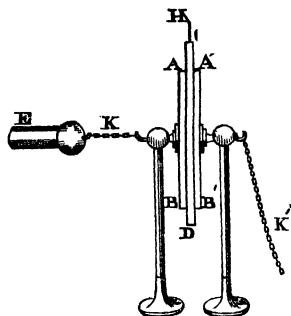

Fig. 499.

denser, connected by a chain  $\kappa$  with the conductor  $E$  of an electric machine; and let  $A'B'$  be the condensing plate connected by a chain  $\kappa'$  with the ground. Let  $CD$  be a plate of glass interposed between  $A'B'$  and  $AB$ .

Let  $e$  express the quantity of electricity with which a superficial unit of the conductor  $E$  is charged. It follows that  $e$  will also express the *free* electricity on every superficial unit of the collecting plate  $AB$ ; and if the total charge on each

superficial unit of  $AB$ , free and dissipated, be expressed by  $a$ , we shall, according to what has been already explained, have

$$a = \frac{e}{1 - m^2}.$$

The charge on the superficial unit of the condensing plate  $A'B'$  being expressed by  $a'$ , we shall have

$$a' = m \times a = \frac{m \times e}{1 - m^2},$$

which will be wholly dissipated.

If  $s$  express the common magnitude of the two plates  $A'B'$  and  $AB$ , and  $E$  express the entire quantity of electricity accumulated on  $AB$ , and  $E'$  that accumulated on  $A'B'$ , we shall have

$$E = S \times a = \frac{S \times e}{1 - m^2}.$$

$$E' = S \times a' = \frac{S \times m \times e}{1 - m^2}.$$

It is evident, therefore, that the quantity of electricity with which the plates  $AB$  and  $A'B'$  will be charged, will be augmented, firstly, with the magnitude ( $s$ ) of the plates; secondly, with the intensity ( $e$ ) of the electricity produced by the machine upon the conductor  $E$ ; and thirdly, with the thinness of the glass plate  $CD$  which separates the plates  $A'B'$  and  $AB$ . The thinner this plate is, the more nearly equal to 1 will be the number  $m$ , and consequently the less will be  $1 - m^2$ , and the greater the quantity  $E$ .

When the machine has been worked until  $e$  ceases to increase, the charge of the plates will have attained its maximum. Let the chains  $\kappa$  and  $\kappa'$  be then removed, so that the plates  $A B$  and  $A' B'$  shall be insulated, being charged with the quantities of electricity of contrary names expressed by  $E$  and  $E'$ .

If a metallic wire  $w$ , or any other conductor, be now placed so as to connect the plate  $A B$  with the plate  $A' B'$ , the free electricity on the former passing along the conductor  $w$  will flow to the plate  $A' B'$ , where it will combine with or neutralize a part of the dissimulated fluid. This last being thus diminished in quantity, will retain by its attraction a less quantity of the fluid on  $A B$ , a corresponding quantity of which will be liberated, and will therefore pass along the conductor  $w$  to the plate  $A' B'$ , where it will neutralize another portion of the dissimulated fluid; and this process of reciprocal neutralization, liberation, and conduction will go on until the entire charge  $E'$  upon the plate  $A' B'$  has been neutralized by a corresponding part of the fluid  $E$  originally diffused on the plate  $A B$ .

Although these effects are strictly progressive, they are practically instantaneous. The current of free electricity flows through the conductor  $w$ , neutralizes the charge  $E'$ , and liberates all the dissimulated part of  $E$  in an interval so small as to be quite inappreciable. In whatever point of view the power of conduction may be regarded, a sudden and violent change in the electrical condition of the conductor  $w$  must attend the phenomenon. If the conductor  $w$  be regarded merely as a channel of communication, a sort of pipe or conduit through which the electric fluid passes from  $A B$  to  $A' B'$ , as some consider it, so large an afflux of electricity may be expected to be attended with some violent effects. If, on the other hand, the opposite fluids are reduced to their natural state, by decomposing successively the natural electricity of the parts of the conductor  $w$ , and taking from the elements of the decomposed fluid the electricities necessary to satisfy their respective attractions, a still more powerful effect may be anticipated from so great and sudden a change.

Such phenomena are accordingly found to be attended with some of the most remarkable effects presented in the whole domain of physical research. If the charge  $E$  be sufficiently strong, and the intermediate conductor  $w$  be thin metallic wire, it will be instantly rendered incandescent, and may even be

fused. If the human body be made the conducting medium, however inconsiderable the charge may be, an effect is produced on the nerves which is to most persons extremely disagreeable, and if the charge be considerable, it may even have the effect of destroying animal life.

In order to divest these principles of whatever is adventitious, and to bring their general character more clearly into view, we have here presented them in a form somewhat different from that in which they are commonly exhibited in electrical experiments. The phenomenon which has just been explained, consisting merely in the communication of powerful charges of electricity of contrary kinds, on the opposite faces of glass or other non-conductor, by means of metal maintained in contact with the glass, it is evident that the form of the glass and of the metal in contact with it have no influence on the effects. Neither has the thickness or volume of the metal any relation to the results. Thus the glass, whose opposite faces are charged, may have the form of a hollow cylinder or sphere, or of a common flask or bottle, and the metal in contact with it need not be massive or solid plates, but merely a coating of metallic foil.

1760. *The Leyden jar.*—In experimental researches, therefore, the form which is commonly given to the glass, with a view to develop the above effects, is that of a cylinder or jar, A B, *fig. 500.*, having a wide mouth and a flat bottom. The shaded part terminating at C is a coating of tinfoil placed on the bottom and sides of the jar, a similar coating being attached to the corresponding parts of the interior surface. To improve the insulating power of the glass it is coated above the edge of the tinfoil with a varnish of gum-lac, which also renders it more proof against the deposition of moisture. A metallic rod, terminated in a ball D, descends into the jar, and is jointed in contact with the inner coating.

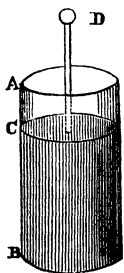

Fig. 500.

This apparatus is generally known by the name of the Leyden phial, the experiments produced with it having been first exhibited at the city of Leyden, in Holland.

To understand the action of this apparatus it is only necessary to consider the inner coating and the metallic rod as

representing the metallic surface  $A B$ , *fig.* 499., and the outer surface  $A' B'$ , the jar itself playing the part of the intervening non-conducting medium. If the ball  $D$  be put in communication by a metallic chain with the conductor of the electric machine, and the external coating  $C B$  with the ground, the jar will become charged with electricity, in the same manner and on the same principles exactly as has been explained in the case of the metallic surfaces  $A' B'$  and  $A B$ , *fig.* 499.

If, when a charge of electricity is thus communicated to the jar, the communication between  $D$  and the conductor be removed, the charge will remain accumulated on the inner coating of the jar. If in this case a metallic communication be made between the ball  $D$  and the outer coating, the two opposite electricities on the inside and outside of the jar will rush towards each other and will suddenly combine. In this case there is no essential distinction between the functions of the outer and inner coating of the jar, as may be shown by connecting the inner coating with the ground and the outer coating with the conductor. For this purpose, it is only necessary to place the jar upon an insulating stool, surrounding it by a metallic chain in contact with its outer coating, which should be carried to the conductor of the machine; while the ball  $D$ , which communicates with the inner coating, is connected by another chain to the ground. In this case the electricity will flow from the conductor to the outer coating, and will be accumulated there by the inductive action of the inner coating, and all the effects will take place as before.

If, after the jar is thus charged, the communication between the outer coating and the conductor be removed, and a metallic communication be made between the inner and outer coating, the electricities will, as before, rush towards each other and combine, and the jar will be restored to its natural state.

To charge the jar internally, it will be sufficient to hold it with the hand in contact with the external coating, presenting the ball  $D$  to the conductor of the machine. The electricity will flow from the conductor to the inner coating, and the external coating will act inductively, being connected through the hand and body of the operator with the earth.

1761. *Effect of the metallic coating.*—The metallic coatings of the jar have no other effect than to conduct the electricity to the surface of the glass, and when there, to afford it a free

passage from point to point. Any other conductor would, abstractedly considered, serve the same purpose; and metallic foil is selected only for the facility and convenience with which it may be adapted to the form of the glass, and permanently attached to it. That like effects would attend the use of any other conductor may be easily shown.

1762. *Water may be substituted for the metallic coating.*— Let a glass jar be partially filled with water, and hold it in the hand by its external surface. Let a chain or rod connected with the conductor of an electric machine be immersed in the water. A stream of electricity will flow from the machine to the water, exactly as it did from the machine to the inner coating of the jar; and the inductive action of the hand communicating through the body of the operator with the ground, will produce a charge of electricity in the water upon exactly the same principle as the inductive action of the external coating of the jar communicated the charge of electricity on the internal coating. If, after the charge has been communicated in the water, the operator plunge his other hand in the water, so as to form a communication between the water within the jar and the hand applied to its external surface, the opposite electricities will rush towards each other through the hand of the operator, and their motion will be rendered sensible by a strong nervous convulsion.

1763. *Experimental proof that the charge adheres to the glass and not to the coating.*—The electricity with which the jar is charged in this case resides, therefore, on the glass, or on the conductor by which it passes to the glass, or is shared by these.

To determine where it resides, it is only necessary to provide means of separating the jar from the coating after it has been charged, and examining the electrical state of the one and the other. For this purpose let a glass jar be provided, having a loose cylinder of metal fitted to its interior, which can be placed in it or withdrawn from it at pleasure, and a similar loose cylinder fitted to its exterior. The jar being placed in the external cylinder, and the internal cylinder being inserted in it, let it be charged with electricity by the machine in the manner already described. Let the internal cylinder be then removed, and let the jar be raised out of the external cylinder. The two cylinders being then tested by an electroscopic apparatus, will

be found to be in their natural state. But if an electroscope be brought within the influence of the internal or external surface of the glass jar, it will betray the presence of the one or the other species of electricity. If the glass jar be then inserted in another metallic cylinder made to fit it externally, and a similar metallic cylinder made to fit it internally be inserted in it, it will be found to be charged as if no change had taken place. On connecting by metallic communication the interior with the exterior, the opposite electricities will rush towards each other and combine. It is evident, therefore, that the seat of the electricity, when a jar is charged, is not the metallic coating, but the surface of the glass under it.

1764. *Improved form of Leyden jar.*—An improved form of the Leyden jar is represented in *fig. 501*. Besides the provisions which have been already explained, there is attached to this jar a hollow brass cup *c* cemented into a glass tube. This tube passes through the wooden disk which forms the cone of the jar, and is fastened to it. It reaches to the bottom of the jar. A communication is formed between *c* and the internal coating by a brass wire terminating in the knob *d*. This wire, passing loosely through a small hole in the top, may be removed at pleasure for the purpose of cutting off the communication between the cup and the interior coating. This wire does not extend quite to the bottom of the jar, but the lower part of the tube is coated with tinfoil, which is in contact with the wire, and extends to the inner coating of the jar.

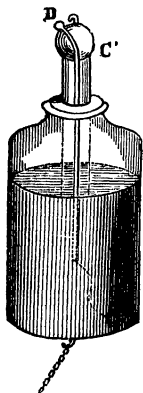

Fig. 501.

At the bottom of the jar a hook is provided, by which a chain may be suspended so as to form a communication between the external coating and other bodies. When a jar of this kind is once charged, the wire may be removed or allowed to fall out by inverting the jar, in which case the jar will remain charged, since no communication exists between its internal and external coating; and as the internal coating is protected from the contact of the external air, the absorption of electricity in this case is prevented. An electric charge may thus be transferred from place to place, and preserved for any length of time.

In the construction of cylindrical jars it is not always possible to obtain glass of uniform thickness, for which reason jars are sometimes provided of a spherical form.

1765. *Charging a series of jars by cascade.*—In charging a single jar, an unlimited number of jars, connected together by conductors, may be charged with very nearly the same quantity of electricity. For this purpose let the series of jars be placed on insulating stools, as represented in *fig. 502.*, and let *c* be

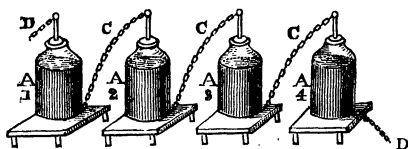

Fig. 502.

metallic chains connecting the external coating of each jar with the internal coating of the succeeding one. Let *D* be a chain connecting the first jar with the conductor of the chain, and *D'* another chain connecting the last jar with the ground. The electricity conveyed to the inner coating of the first jar *A* acts by induction on the external coating of the first jar, attracting the negative electricity to the surface, and repelling the positive electricity through the chain *c* to the inner coating of the second jar. This charge of positive electricity in the second jar acts in like manner inductively on the external coating of this jar, attracting the negative electricity there, and repelling the positive electricity through the chain *c* to the internal coating of the third jar; and in the same manner the internal coating of every succeeding jar in the series will be charged with positive electricity, and its internal coating with negative electricity. If, while the series is insulated, a discharger be made to connect the inner coating of the first with the outer coating of the last jar, the opposite electricities will rush towards each other, and the series of jars will be restored to their natural state.

1766. *Electric battery.*—When several jars are thus combined to obtain a more energetic discharge than could be formed by a single jar, the system is called an *electric battery*, and the method of charging it, explained above, is called *charging by cascade.*



After the jars have been thus charged, the chains connecting the outer coating of each jar with the inner coating of the succeeding one are removed, and the knobs are all connected one with another by chains or metallic rods, so as to place all the internal coatings in electric connection, and the outer coatings are similarly connected. By this expedient the system of jars is rendered equivalent to a single jar, the magnitude of whose coated surface would be equal to the sum of all the surfaces of the series of jars. The battery would then be discharged by placing a conductor between the outer coating of any of the jars and one of the knobs.

If  $s$  express the total magnitude of the coating of the series of jars, the total charge of the battery will be expressed approximately by

$$E = \frac{s \times e}{1 - m^2}.$$

1767. *Common electric battery.*—It is not always convenient, however, to practise this method. The jars composing the battery are commonly placed in a box, as represented in *fig. 503.*, coated on the inside with tinfoil, so as to form a metallic communication between the external coating of all the jars. The knobs, which communicate with their internal coating, are connected

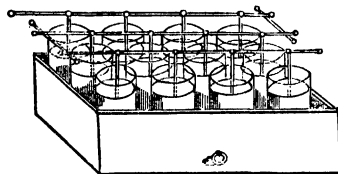

Fig. 503.

by a series of metallic rods in the manner represented in the figure; so that there is a continuous metallic communication between all the internal coatings. If the metallic rods which thus communicate with the inner coating be placed in communication with the conductor of a machine, while the box containing the jars

is placed in metallic communication with the earth, the battery will be charged according to the principles already explained in the case of a single jar, and the force of its charge will be equal to the force of the charge of a single jar, the magnitude of whose external and internal coating would be equal to the sum of the internal and external coating of all the jars composing the battery.

1768. *Method of indicating and estimating the amount of*

*the charge.*—In charging a jar or a battery there is no obvious means by which the amount of the charge imparted to the jar can be indicated. It is to be considered that the internal coating is, in effect, a continuation of the conductor; and if the jars had no external coating, the communication of the internal coating with the conductor would be attended with no other effect than the distribution of the electricity over the conductor and the internal coating, according to the laws of electrical equilibrium; but the effect of the external coating is to dissimulate or render latent the electricity as it flows from the conductor, so that the repulsion of the part of it which remains free is less than the expansive force of the electricity of the conductor, and a stream of the fluid continues to flow accordingly from the conductor to the internal coating; and this process continues until the increasing force of the free electricity on the internal coating of the jars becomes so great, that the force of the fluid on the condenser can no longer overcome it, and thus the flow of electricity to the jars from the conductor will cease.

It follows, therefore, that during the process of charging the jars, the depth or tension of the electricity on the conductor is just so much greater than that of the free electricity on the interior of the jars, as is sufficient to sustain the flow of electricity from the one to the other; and as this is necessarily so extremely minute an excess as to be insensible to any measure which could be applied to it, it may be assumed that the depth of electricity on the conductor is always equal to that of the free electricity on the interior of the jars. If  $e$  therefore express the actual depth of the electric fluid at any time on the interior coating,  $(1 - m^2) \times e$  will express the depth of the free electricity; and since, throughout the process,  $m$  does not change its value, it follows that the actual depth of electricity, and therefore the actual magnitude of the charge, is proportionate to the depth of free electricity on the interior of the jar, which is sensibly the same as the depth of free electricity on the conductor. It follows, therefore, that the magnitude of the charge, whether of a single jar or several, will always be proportionate to the depth of electricity on the conductor of the machine from which the charge is derived. If, therefore, during the process of charging a jar or battery, an electrometer be attached to the conductor, this instrument will at first give indications of a very feeble elec-

tricity, the chief part of the fluid evolved being dissipated on the inside of the jars; but as the charge increases, the indications of an increased depth of fluid on the conductor become apparent; and at length, when no more fluid can pass from the conductor to the jars, the electrometer becomes stationary, and the fluid evolved by the machine escapes from the points or into the circumjacent air.

The quadrant electrometer, described in (1757), is the indicator commonly used for this purpose, and is inserted in a hole on the conductor. When the pith ball attains its maximum elevation, the charge of the jars may be considered as complete. The charge which a jar is capable of receiving; besides being limited by the strength of the glass to resist the mutual attraction of the opposite fluids, and the imperfect insulating force of that part of the jar which is not coated, is also limited by the imperfect insulating force of the air itself. If other causes, therefore, allowed an unlimited flow of electricity to the jar, its discharge would at length take place by the elasticity of the free electricity within it surmounting the confining pressure of the air, and accordingly the fluid of the interior would pass over the mouth of the jar, and unite with the opposite fluid of the exterior surface.

## CHAP. VIII.

### LAWS OF ELECTRICAL FORCES.

1769. *Electric forces investigated by Coulomb.* — It is not enough to ascertain the principles which govern the decomposition of the natural electricity of bodies, and the reciprocal attraction and repulsion of the constituent fluids. It is also necessary to determine the actual amount of force exerted by each fluid in repelling fluid of the like or attracting fluid of the opposite kind, and how the intensity of this attraction is varied by varying the distance between the bodies which are invested by the attracting or repelling fluids.

By a series of experimental researches, which rendered his name for ever memorable, COULOMB solved this difficult and

delicate problem, measuring with admirable adroitness and precision these minute forces by means of his electroscope or balance of torsion, already described (1756).

1770. *Proof-plane*.—The electricity of which the force was to be estimated was taken up from the surface of the electrified body upon a small circular disk *c*, *fig. 504.*, coated with metallic foil, and attached to the extremity of a delicate rod or handle *AB* of gum-lac. This disk, called a *PROOF-PLANE*, was presented to the ball suspended in the electrometer of torsion (1756), and the intensity of its attraction or repulsion was measured by the number of degrees through which the suspending fibre or wire was twisted by it.



*Fig. 504.* The extreme degree of sensibility of this apparatus may be conceived, when it is stated that a force equal to the 340th part of a grain was sufficient to turn it through 360 degrees; and since the reaction of torsion is proportional to the angle of torsion, the force necessary to make the needle move through one degree would be only the 122,400th part of a grain. Thus this balance was capable of dividing a force equal to a single grain weight into 122,400 parts, and rendering the effect of each part distinctly observable and measurable.

1771. *Law of electrical force similar to that of gravitation*.—By these researches it was established, that the attraction and repulsion of the electric fluids, like the force of gravitation, and other physical influences which radiate from a centre, vary according to the common law of the *inverse square of the distance*; that is to say, the attraction or repulsion exerted by a body charged with electricity, or, to speak more correctly, by the electricity with which such a body is charged, increases in the same proportion as the square of the distance from the body on which it acts is diminished, and diminishes as the square of that distance is increased.

In general, if  $f$  express the force exerted by any quantity of electric fluid, positive or negative, at the unit of distance,  $\frac{f}{D^2}$  will express the force which the same quantity of the same fluid will exert at the distance  $D$ .

In like manner, if the quantity of fluid taken as the unit exercise at the distance  $D$  the force expressed by  $\frac{f}{D^2}$ , the quantity

expressed by  $E$ , will exert at the same distance  $D$  the force expressed by

These formulæ have been tested by numerous experiments made under every possible variety of conditions, and have been found to represent the phenomena with the greatest precision.

1772. *Distribution of the electric fluid on conductors.*—The distribution of electricity upon conductors can be deduced as a mathematical consequence of the laws of attraction and repulsion which have been explained above, combined with the property in virtue of which conductors give free play to these forces. The conclusions thus deduced may further be verified by the *proof plane* and electrometer of torsion, by means of which the fluid diffused upon a conductor may be *gauged*, so that its depth or intensity at every point may be exactly ascertained; and such depths and intensities have accordingly been found to accord perfectly with the results of theory.

1773. *It is confined to their surfaces.*—Numerous facts suggest the conclusion that the electricity with which a conductor is charged is either superficial, or very nearly so.

If an electrified conductor be pierced with holes a little greater than the proof plane (*fig. 504.*) to different depths, that plane, inserted so as to touch the bottom of these holes, will take up no electricity.

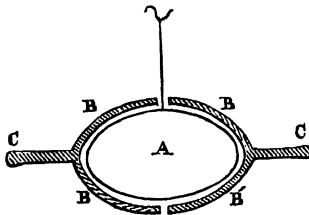

Fig. 505.

If a spheroidal metallic body  $A$ , *fig. 505.*, suspended by a silken thread, be electrified, and two thin hollow caps  $BB$  and  $B'B'$  made to fit it, coated on their inside surface with metallic foil, and having insulating handles  $CC'$  of gum-lac, be applied to it, on withdrawing them the spheroid will be deprived of its elec-

tricity, the fluid being taken off by the caps.

Although it follows, from these and other experimental tests, as well as from theory, that the diffusion of electricity on con-

ductors is nearly superficial, it is not absolutely so. If one end of a metallic rod, coated with sealing-wax, be presented to any source of electricity, the fluid will be received as freely from the other end, as if its surface were not coated with a non-conductor. It follows from this that the electricity must pass along the rod sufficiently within the surface of the metal which is in contact with the wax to be out of contact with the wax, which, by its insulating virtue, would arrest the progress of the fluid.

1774. *How the distribution varies.*—It remains, however, to ascertain how the intensity of the fluid, or its depth on different parts of a conductor, varies.

There are some bodies whose form so strongly suggests the inevitable uniformity of distribution as to render demonstration needless. In the case of a sphere, the symmetry of form alone indicates the necessity of an uniform distribution. If, then, the fluid be regarded as having an uniform depth on every part of a conducting sphere, exactly as a liquid might be uniformly diffused over the surface of the globe, the total quantity of fluid will be expressed by multiplying its depth by the superficial area of the globe.

1775. *Distribution on an ellipsoid.*—If the electrified conductor be not a globe, but an elliptical spheroid, such as  $AA'$ , *fig. 506.*, the fluid will be found to be accumulated in greater quantity at the small ends  $A$  and  $A'$  than at the sides  $BB'$ , where there is less curvature. This unequal distribution of the fluid is represented by the dotted line in the figure.

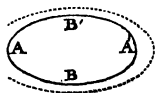

Fig. 506.

It follows from theory, and it is confirmed by observation, that the depth of the fluid at  $A$  and  $A'$  is greater than at  $BB'$  in the ratio of the longer axis  $AA'$  of the ellipse to the shorter axis  $BB'$ .

If, therefore, the ellipsoid be very elongated, as in *fig. 506.*, the depth of the fluid at the ends  $A$  and  $A'$  will be proportionally greater.

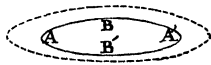
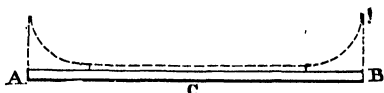

Fig. 507.

1776. *Effects of edges and points.*—If the conductor be a flat disk, the depth of the fluid will increase from its centre towards its edges. The depth will, however, not vary sensibly near the centre, but will augment rapidly in ap-

proaching the edge, as represented in *fig. 508.*, where A and B are the edges, and C the centre of the disk, the depth of the fluid being indicated by the dotted line.



*Fig. 508.*

It is found in general that the depth of the fluid increases in a rapid proportion in approaching the edges, corners, and extremities, whatever be the shape of the conductor. Thus, when a circular disk or rectangular plate has any considerable magnitude, the depth of the electricity is sensibly uniform at all parts not contiguous to the borders; and whatever be the form, whether round or square, if only it be terminated by sharp angular edges, the depth will increase rapidly in approaching them.

If a conductor be terminated, not by sharp angular edges, but by rounded sides or ends, then the distribution will become more uniform. Thus, if a cylindrical conductor of considerable diameter have hemispherical ends, the distribution of the electricity upon it will be nearly uniform; but if its ends be flat, with sharp angular edges, then an accumulation of the fluid will be produced contiguous to them. If the sides of a flat plate of sufficient thickness be rounded, the accumulation of fluid at the edges will be diminished.

The depth of the fluid is still more augmented at corners where the increase of depth due to two or more edges meet and are combined; and this effect is pushed to its extreme limit if any part of a conductor have the form of a POINT.

The pressure of the surrounding air being the chief, if not the only force, which retains the electric fluid on a conductor, it is evident that if at the edges, corners, or angular points, the depth be so much increased that the elasticity of the fluid exceeds the restraining pressure of the atmosphere, the electricity must escape, and in that case will issue from the edge, corner, or point, exactly as a liquid under strong pressure would issue from a *jet d'eau*.

1777. *Experimental illustration of the effect of a point.*—Let *r*, *fig. 509.*, be a metallic point attached to a conductor *c*, and let

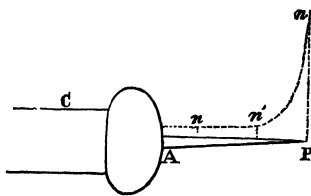

Fig. 509.

the perpendicular  $n$  express the thickness or density of the electric fluid at that place; this thickness will increase in approaching the point  $P$ , so as to be represented by perpendiculars drawn from the respective points of the curve  $n, n', n''$  to  $AP$ , so that its density at  $P$  will be expressed by the

perpendicular  $n''P$ . Experience shows that in ordinary states of the atmosphere a very moderate charge of electricity given to the conductor  $c$  will produce such a density of the electric fluid at the point  $P$  as to overcome the pressure of the atmosphere, and to cause the spontaneous discharge of the electricity.

The following experiments will serve to illustrate this escape of electricity from points.

Let a metallic point, such as  $AP$ , *fig. 509.*, be attached to a conductor, and let a metallic ball of two or three inches in diameter, having a hole in it corresponding to the point  $P$ , be stuck upon the point. If the conductor be now electrified, the electricity will be diffused over it, and over the ball which has been stuck upon the point  $P$ . The electric state of the conductor may be shown by a quadrant electrometer being attached to it. Let the ball now be drawn off the point  $P$  by a silk thread attached to it for the purpose, and let it be held suspended by that thread. The electricity of the conductor  $c$  will now escape by the point  $P$ , as will be indicated by the electrometer, but the ball suspended by the silk thread will be electrified as before.

1778. *Rotation produced by the reaction of points.*—Let two wires  $AB$  and  $CD$ , *fig. 510.*, placed at right angles, be supported by a cap  $E$  upon a fine point at the top of an insulating stand, and let them communicate by a chain  $F$  with a conductor kept constantly electrified by a machine. Let each of the four arms of the wires be terminated by a point in a horizontal direction at right angles to the wire, each point being turned in the same direction, as represented in the figure. When the electricity comes from the conductor to the wires, it will escape from the wires at these four points

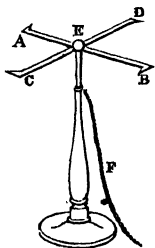

Fig. 510.



respectively; and the force with which it leaves them will be attended with a proportionate recoil, which will cause the wire to spin rapidly on the centre *E*.

1779. *Another experimental illustration of this principle.*—An apparatus supplying another illustration of this principle is

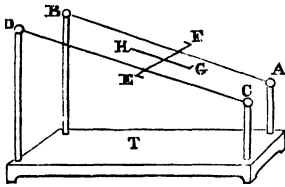

Fig. 511.

represented in *fig. 511.*: a square wooden stand *T* has four rods of glass inserted in its corners, the rods at one end being less in height than those at the other. The tops of these rods having metal wires *AB* and *CD* stretched between them, across these wires another wire *EF* is placed, having

attached to it at right angles another wire *GH*, having two points turned in opposite directions at its extremities, so that when *GH* is horizontal these two points shall be vertical, one being presented upwards, and the other downwards. A chain from *A* communicates with a conductor kept constantly electrified by a machine.

The electricity coming from the conductor by the chain, passes along the system of wires, and escapes at the points *G* and *H*. The consequent recoil causes the wire *GH* to revolve round *EF* as an axis, and thereby causes *EF* to roll up the inclined plane.

1780. *Electrical orrery.*—An apparatus called the *electrical orrery* is represented in *fig. 512.* A

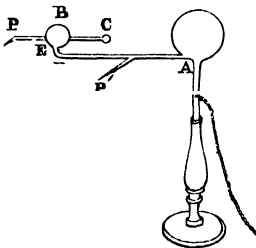

Fig. 512.

metallic ball *A* rests upon an insulating stand by means of cap within it, placed upon a fine metallic point forming the top of the stand.

From the ball *A* an arm *DA* proceeds, the extremity of which is turned up at *E*, and formed into a fine point.

A small ball *B* rests by means of a cap on this point, and attached to it are two arms extended in opposite directions, one terminated with a small ball *C*, and the other by a point *P* presented in the horizontal direction at right angles to the arm. Another point *P'*, attached at right angles to the arm *DA*, is likewise presented

in the horizontal direction. By this arrangement the ball *A* together with the arm *DA* is capable of revolving round the insulating stand, by which motion the ball *B* will be carried in a circle round the ball *A*. The ball *B* is also capable at the same time of revolving on the point which supports it, by which motion the ball *C* will revolve round the ball *B* in a circle. If electricity be supplied by the chain to the apparatus, the balls *A* and *B* and the metallic rods will be electrified, and the electricity will escape at the points *P* and *P'*. The recoil produced by this escape will cause the rod *DA* to revolve round the insulating pillar, and at the same time the rod *PC* together with the ball *B* to revolve on the extremity of the arm *DA*. Thus, while the ball *B* revolves in a circular orbit round the ball *A*, the ball *C* revolves in a smaller circle round the ball *B*, the motion resembling that of the moon and earth with respect to the sun.

## CHAP. IX.

## MECHANICAL EFFECTS OF ELECTRICITY.

1781. *Attractions and repulsions of electrified bodies.*—If a body charged with electricity be placed near another body, it will impress upon such body certain motions, which will vary according as the body thus affected is a conductor or a non-conductor; according as it is in its natural state or charged with electricity; and in fine, if charged with electricity, according as the electricity is similar or opposite to that with which the body acting upon it is charged.

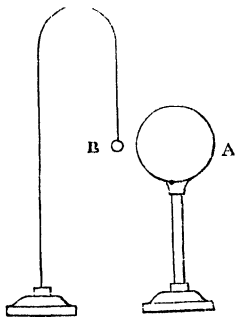

Fig. 513.

Let *A*, *fig. 513.*, be the body charged with electricity, which we shall suppose to be a metallic ball supported on an insulating column. Let *B* be the body upon which it acts, which we shall suppose to be a small ball suspended by a fine silken thread. We shall consider successively the cases above mentioned.

1782. *Action of an electrified body*

*on a non-conductor not electrified.*—1°. Let B be a non-conductor in its natural state.

In this case no motion will be impressed on B. The electricity with which A is charged will act by attraction and repulsion on the two opposite fluids which compose the natural electricity of B, attracting each molecule of one by exactly the same force as it repels the molecule of the other. No decomposition of the fluid will take place, because the insulating property of B will prevent any motion of the fluids upon it, and will therefore prevent their separation. Each compound molecule therefore being at once attracted and repelled by equal forces, no motion will take place.

1783. *Action of an electrified body on a non-conductor charged with like electricity.*—2°. Let B be charged with electricity similar to that with which A is charged.

In this case B will be repelled from A. For, according to what has been explained above, the forces exerted on the natural electricity of B will be in equilibrium, but the electricity of A will repel the similar electricity with which B is charged; and since this fluid cannot move upon the surface of B because of its insulating virtue, and cannot quit the surface because of the restraining pressure of the surrounding air, it must adhere to the surface, and, being repelled by the electricity of A, must carry with it the ball B in the direction of such repulsion. The ball B therefore will incline from A, and will rest in such a position that its weight will balance the repulsive force.

1784. *Its action on a non-conductor charged with opposite electricity.*—3°. Let B be charged with electricity opposite to that with which A is charged.

In this case B will be attracted towards A, the distribution of the fluid upon it not being changed, for the same reasons as in the last case.

1785. *Its action on a conductor not electrified.*—4°. Let B be a conductor in its natural state.

In this case the action of the fluid on A attracting one constituent of the natural electricity of B, and repelling the other, will tend to decompose and separate them; and since the conducting virtue of B leaves free play to the movement of the fluids upon it, this attraction and repulsion will take effect, the attracted fluid moving to the side of B nearest to A, and the repelled fluid to the opposite side.

To render the explanation more clear, let us suppose that **A** is charged with positive electricity.

In that case, the negative fluid of **B** will accumulate on the side next **A**, and the positive fluid on the opposite side. The negative fluid will therefore be nearer to **A** than the positive fluid; and since the force of the attraction and repulsion increases as the square of the distance is diminished (1771), and since the quantity of the negative fluid on the side next **A** is equal to the quantity of positive fluid on the opposite side, the attraction exerted on the former will be greater than the repulsion exerted on the latter; and since the fluids are prevented from leaving **B** by the restraining pressure of the air, the fluids carrying with them the ball **B** will be moved towards **A** and will rest in equilibrium, when the inclination of the string is such that the weight of **B** balances and neutralizes the attraction.

If **A** were charged with negative electricity, the same effects would be produced, the only difference being that, in that case, the positive fluid on **B** would accumulate on the side next **A**, and the negative fluid on the opposite side.

Thus it appears that a conducting body in its natural state is always attracted by an electrified body, with whichever species of electricity it be charged.

1786. *Its action upon a conductor charged with like electricity.* — 5°. Let **B** be a conductor charged with electricity similar to that with which **A** is charged.

In this case the effect produced on **B** will depend on the relative strength of the charges of electricity of **A** and **B**.

The electricity of **A** will repel the free electricity of **B**, and cause it to accumulate on the side of **B** most remote from **A**. But it will also decompose the natural electricity of **B**, attracting the fluid of the contrary kind to the side near **A**, and repelling the fluid of the same kind to the opposite side. It will follow from this, that the quantity of the fluid of the same name accumulated at the opposite side of **B** will be greater than the quantity of fluid of the contrary name collected at the side near **A**. While, therefore, the latter is more attracted than the former, by reason of its greater proximity, it is less attracted by reason of its lesser quantity. If these opposite effects neutralize each other,—if it lose as much force by its inferior quantity as it gains by its greater proximity, the attractions and repulsions of **A** on **B** will neutralize each other, and the ball **B** will not

move. But if the quantity of electricity with which B is charged be so small that more attraction is gained by proximity than is lost by quantity, then the ball B will move towards A. If, however, the quantity of electricity with which B is charged be so great that the effect prevail over that of distance, the ball B will be repelled.

It follows, therefore, from this, that in order to ensure the repulsion of the ball B in this case, the charge of electricity must be so strong as to prevail over that attraction which would operate on the ball B if it were in its natural state. A very small electrical charge is, however, generally sufficient for this.

1787. *Its action upon a conductor charged with opposite electricity.*—6°. Let B be charged with electricity of a contrary name to that with which A is charged.

In this case B will always be attracted towards A, for the attraction exerted on the fluid with which it is charged will be added to that which would be exerted on it if it were in its natural state.

The free electricity on B will be attracted to the side next A, and the natural fluid will be decomposed, the fluid of the same name accumulating on the side most remote from A, and the fluid of the contrary name collecting on the side nearest to A, and there uniting with the free fluid with which B is charged. There is therefore a greater quantity of fluid of the contrary name on that side, than of the same name on the opposite side. The attraction of the former prevails over the repulsion of the latter therefore at once by greater quantity and greater proximity, and is consequently effective.

1788. *Attractions and repulsions of pith balls explained.*—What has been explained above will render more clearly understood the attractions and repulsions manifested by pith balls before and after their contact with electrified bodies (1697). Before contact, the balls, being in their natural state, and being composed of a conducting material, are always attracted, whatever be the electricity with which the body to which they are presented is charged (1785); but after contact, being charged with the like electricity, they are repelled (1786).

When touched by the hand, or any conductor which communicates with the ground, they are discharged and restored to their natural state, when they will be again attracted.

If they be suspended by wire or any other conducting thread,

and the stand be a conductor communicating with the ground, they will lose their electricity the moment they receive it.

The electric fluid in passing through bodies, especially if they be imperfect conductors, or if the space they present to the fluid bear a small proportion to its quantity, produces various and remarkable mechanical effects, displacing the conductors sometimes with great violence.

1789. *Strong electric charges rupture imperfect conductors.*—*Card pierced by discharge of jar.*—The current of electricity discharged from a Leyden jar will penetrate several leaves of paper or card.

A method of exhibiting this effect is represented in *fig. 514.*

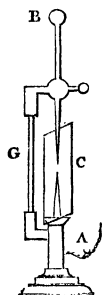

Fig. 514.

The chain *A* communicates with the outside coating of the jar. The card *C* is placed in such a position that two metallic points touch it on opposite sides, terminating near each other. The pillar *G*, being glass, intercepts the electricity. The ball of the discharger being put in communication with the inside coating of the jar, is brought into contact with the ball *B*, so that the two points which are on opposite sides of the card, being in connection with the two coatings of the jar, are charged with contrary fluids, which exert on each other such an attraction that they rush to each other, penetrating the card, which is found in this case pierced by a hole larger than that

produced by a common pin.

It is remarkable that the *burr* produced on the surface of the card is in this case convex *on both sides*, as if the matter producing the hole, instead of passing through the card from one side to the other, had either issued from the middle of its thickness, emerging at each surface, or as if there were two distinct prevailing substances passing in contrary directions, each elevating the edges of the orifice in issuing from it.

The accordance of this effect with the hypothesis of two fluids is apparent.

1790. *Curious fact observed by M. Tremery.*—A fact has been noticed by M. Tremery for which no explanation has yet been given. That observer found that when the two points on opposite sides of the card are placed at a certain distance, one above the other, the hole will not be midway between them. When the experiment is made in the

atmosphere, the hole will always be nearer to the negative fluid. When the apparatus is placed under the receiver of an air-pump, the hole approaches the positive fluid as the rarefaction proceeds.

If several cards be placed between the knobs of the universal discharger (1744), they may be pierced by a strong charge of a jar or battery, having more than one square foot of coated surface.

1791. *Wood and glass broken by discharge.*—A rod of wood half an inch thick may be split by a strong charge transmitted in the direction of its fibres, and other imperfect conductors pierced in the same manner.

If a leaf of writing-paper be placed on the stage of the discharger, the electricity passed through it will tear it.

The charge of a jar will penetrate glass. An apparatus for exhibiting this effect is shown in *fig. 515*. It may also be exhibited by transmitting the charge through the side of a phial, *fig. 516*.

A strong charge passed through water scatters the liquid in all directions around the points of discharge, *fig. 517*.

1792. *Electrical bells.*—The alternate attraction and repulsion of electrified conductors is prettily illustrated by the *electrical bells*.

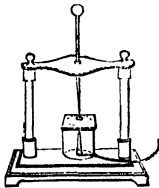

Fig. 515.

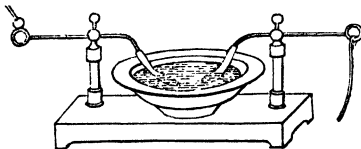

Fig. 517.



Fig. 516.

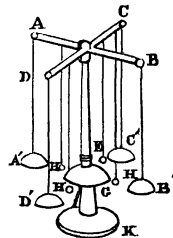

Fig. 518.

AB and CD, *fig. 518*., are two metal rods supported on a glass pillar. From the ends of these rods four bells A' B' C' D' are

suspended by metallic chains. A central bell *G* is supported on the wooden stand which sustains the glass pillar *EF*, and this central bell communicates by a chain *GK* with the ground. From the transverse rods are also suspended, by silken threads, four small brass balls *H*. The transverse rods being put in communication with the conductor of an electrical machine, the four bells *A' B' C' D'* become charged with electricity. They attract and then repel the balls *H*, which when repelled strike the bell *G*, to which they give up the electricity they received by contact with the bells *A' B' C' D'*, and this electricity passes to the ground by the chain *G*. The bells will thus continue to be tolled as long as any electricity is supplied by the conductor to the bells *A' B' C' D'*.

1793. *Repulsion of electrified threads.*—Let a skein of linen thread be tied in a knot at each end, and let one end of it be attached to some part of the conductor of the machine. When the machine is worked the threads will become electrified and will repel each other, so that the skein will swell out into a form resembling the meridians drawn upon a globe.

1794. *Curious effect of repulsion of pith ball.*—Let a metallic point be inserted into one of the holes of the prime conductor, so that, in accordance with what has explained, a jet of electricity may escape from it when the conductor is electrified. Let this jet, while the machine is worked, be received on the interior of a glass tumbler, by which the surface of the glass will become charged with electricity.

If a number of pith balls be laid upon a metallic plate communicating with the ground, and the tumbler be placed with its mouth upon the plate, including the balls within it, the balls will begin immediately leaping violently from the metal and striking the glass, and this action will continue till all the electricity with which the glass was charged has been carried away.

This is explained on the same principle as the former experiments. The balls are attracted by the electricity of the glass, and when electrified by contact, are repelled. They give up their electricity to the metallic plate from which it passes to the ground; and this process continues until no electricity remains on the glass of sufficient strength to attract the balls.

1795. *Electrical dance.*—Let a disk of pasteboard or wood, coated with metallic foil, be suspended by wires or threads of



linen from the prime conductor of an electrical machine, and let a similar disk be placed upon a stand capable of being adjusted to any required height. Let this latter disk be placed immediately under the former, and let it have a metallic communication with the ground. Upon it place small coloured representations in paper, of dancing figures, which are prepared for the purpose. When the machine is worked, the electricity with which the upper disk will be charged will attract the light figures placed on the lower disk, which will leap upwards; and after touching the upper disk and being electrified, will be repelled to the lower disk, and this jumping action of the figures will continue so long as the machine is worked. An electrical dance is thus exhibited for the amusement of young persons.

1796. *Curious experiments on electrified water.*—Let a small metallic bucket B, *fig. 519.*, be suspended from the prime conductor of a machine, and let it have a capillary tube CD of the siphon form immersed in it; or let it have a capillary tube inserted in the bottom; the bore of the tube being so small, that water cannot escape from it by its own pressure. When the machine is put in operation, the particles of water becoming electrified, will repel each other, and immediately an abundant stream will issue from the tube; and as the particles of water after leaving the tube still exercise

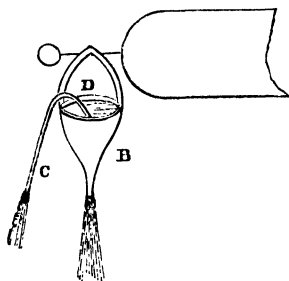

Fig. 519.

a reciprocal repulsion, the stream will diverge in the form of a brush.

If a sponge saturated with water be suspended from the prime conductor of the machine, the water, when the machine is first worked, will drop slowly from it; but when the conductor becomes strongly electrified, it will descend abundantly, and in the dark will exhibit the appearance of a shower of luminous rain.

1797. *Experiment with electrified sealing-wax.*—Let a piece of sealing-wax be attached to the pointed end of a metallic rod; set fire to the wax, and when it is in a state of fusion blow out the flame, and present the wax within a few inches of the prime conductor of the machine. Strongly electrified myriads

of fine filaments will issue from the wax towards the conductor, to which they will adhere, forming a sort of net-work resembling wool. This effect is produced by the positive electricity of the conductor decomposing the natural electricity of the wax; and the latter being a conductor when in a state of fusion, the negative electricity is accumulated in the soft part of the wax near the conductor, while the positive electricity escapes along the metallic rod. The particles of wax thus negatively electrified being attracted by the conductor, are drawn into the filaments above mentioned.

1798. *Electrical see-saw.*—The electrical see-saw *ab*, fig. 520., is a small strip of wood covered over with silver leaf or tinfoil, insulated on *c* like a balance.

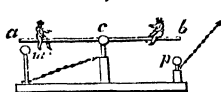

Fig. 520.

A slight preponderance is given to it at *a*, so that it rests on a wire having a knob *m* at its top; *p* is a similar metal ball insulated. Connect *p* with the interior, and *m* with the exterior coating of the jar, charge it, and the see-saw motion of *ab* will commence from causes similar to those which excited the movements of the pith balls.

## CHAP. X.

### THERMAL EFFECTS OF ELECTRICITY.

1799. *A current of electricity passing over a conductor raises its temperature.*—If a current of electricity pass over a conductor, as would happen when the conductor of an electrical machine is connected by a metallic rod with the earth, no change in the thermal condition of the conductor will be observed, so long as its transverse section is so considerable as to leave sufficient space for the free passage of the fluid. But, if its thickness be diminished, or the quantity of fluid passing over it be augmented, or, in general, if the ratio of the fluid to the magnitude of the space afforded to it be increased, the conductor will be found to undergo an elevation of temperature, which will be greater the greater the quantity of the electricity and the less the space supplied for its passage.

1800. *Experimental verification.*—*Wire heated, fused, and burned.*—If a piece of wire of several inches in length be placed upon the stage of the universal discharger (1744), a feeble charge transmitted through it will sensibly raise its temperature. By increasing the strength of the charge, its temperature may be elevated to higher and higher points of the thermometric scale; it may be rendered incandescent, fused, vaporized, and, in fine, burned.

With the powerful machine of the Taylerian Museum at Haarlem, Van Marum fused pieces of wire above 70 feet in length.

Wire may be fused in water; but the length which can be melted in this way is always less than in air, because the liquid robs the metal of its heat more rapidly than air.

A narrow ribbon of tinfoil, from 4 to 6 inches in length, may be volatilized by the discharge of a common battery. The metallic vapour is in this case oxidized in the air, and its filaments float like those of a cobweb.

1801. *Thermal effects are greater as the conducting power is less.*—These thermal effects are manifested in different degrees in different metals, according to their varying conducting powers. The worst conductors of electricity, such as platinum and iron, suffer much greater changes of temperature by the same charge than the best conductors, such as gold and copper. The charge of electricity, which only elevates the temperature of one conductor, will sometimes render another incandescent, and will volatilize a third.

1802. *Ignition of metals.*—If a fine silver wire be extended between the rods of the universal discharger (1744), a strong charge will make it burn with a greenish flame. It will pass off in a greyish smoke. Other metals may be similarly ignited, each producing a flame of a peculiar colour. If the experiments be made in a receiver, the products of the combustion being collected, will prove to be the metallic oxides.

If a gilt thread of silk be extended between the rods of the discharger, the electricity will volatilize or burn the gilding, without affecting the silk. The effect is too rapid to allow the time necessary for the heat to affect the silk.

A strip of gold or silver leaf placed between the leaves of paper, being extended between the rods of the discharger, will be burnt by a discharge from a jar having two square feet of

coating. The metallic oxide will in this case appear on the paper as a patch of purple colour in the case of gold, and of grey colour in that of silver.

A spark from the prime conductor of the great Haarlem machine burnt a strip of gold leaf twenty inches long by an inch and a half broad.

1803. *Effect on fulminating silver.*—The heat developed in the passage of electricity through combustible or explosive substances, which are imperfect conductors, causes their combustion or explosion.

A small quantity of fulminating silver placed on the point of a knife, explodes if brought within a few feet of the conductor of an electrical machine in operation. In this case the explosion is produced by induction.

1804. *Electric pistol.*—The electrical pistol or cannon is charged with a mixture of hydrogen and oxygen gases, in the proportion necessary to form water. A conducting wire terminated by a knob is inserted in the touch-hole, and the gases are confined in the barrel by the bullet. An electric spark imparted to the ball at the touch-hole, causes the explosion of the gases. This explosion is produced by the sudden combination of the gases, and their conversion into water, which, in consequence of the great quantity of heat developed, is instantly converted into steam of great elasticity, which, by its expansion, forces the bullet from the barrel in the same manner as do the gases which result from the explosion of gunpowder.

1805. *Ether and alcohol ignited.*—Ether or alcohol may be fired by passing through it an electric discharge. Let cold water be poured into a wine-glass, and let a thin stratum of ether be carefully poured upon it. The ether being lighter will float on the water. Let a wire or chain connected with the prime conductor of the machine be immersed in the water, and, while the machine is in action, present a metallic ball to the surface of the ether. The electric charge will pass from the water through the ether to the ball, and will ignite the ether. Or, if a person standing on an insulating stool, and holding in one hand a metal spoon filled with ether, present the surface of the ether to a conductor, and at the same time apply the other hand to the prime conductor of a machine in operation, the electricity will pass from the prime conductor through the body of the person to the spoon, and from the spoon through

the ether, to the conductor to which the ether is presented, and in so passing will ignite the ether.

1806. *Resinous powder burned.* — The electric charge transmitted through fine resinous powder, such as that of colophony, will ignite it. This experiment may be performed either by spreading the powder on the stage of the discharger (1744), or by impregnating a hank of cotton with it; or, in a still more striking manner, by sprinkling it on the surface of water contained in an earthenware saucer.

1807. *Gunpowder exploded.* — Gunpowder may, in like manner, be ignited by electricity. This experiment is most conveniently exhibited by placing the powder in a small wooden cup, and conducting the electric charge along a moist thread, six or seven inches long, attached to the arm of the discharger, which is connected with the negative coating of a jar, and the charge, in its passage from one rod of the discharger to the other, will ignite the powder.

1808. *Electric mortars.* — The electric mortar, *fig. 521.*, is an apparatus by which the gunpowder is ignited by passing an electric charge through it. The mixed gases may also be used in this instrument.



Fig. 521.

Common air or gas, not being explosive, is heated so suddenly and intensely by transmitting through it an electric charge, that it will expand so as to project the ball from the mortar.

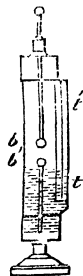

Fig. 522.

1809. *Kinnersley's electrometer.* — Kinnersley's electric thermometer, *fig. 522.*, is an instrument intended to measure the degree of heat developed in the passage of an electric charge by the expansion of air. The discharge takes place between the two balls *bb'* in the glass cylinder, and the air confined in the cylinder being heated expands, presses upon the liquid contained in the lower part of the cylinder, and causes the liquid in the tube *tt'* to rise. The variation of the column of liquid in the tube *tt'* indicates the elevation of temperature.

## CHAP. XI.

## LUMINOUS EFFECTS OF ELECTRICITY.

1810. *Electric fluid not luminous.*—The electric fluid is not luminous. An insulated conductor, or a Leyden jar or battery, however strongly charged, is never luminous so long as the electric equilibrium is maintained and the fluid continues in repose. But if this equilibrium be disturbed, and the fluid move from one conductor to another, such motion is, under certain conditions, attended with luminous phenomena.

1811. *Conditions under which light is developed by an electric current.*—One of the conditions necessary to the development of light by the motion of the electric fluid is, that the electricity should have a certain intensity. If the conductor of an ordinary electric machine while in operation be connected with the ground by a thick metallic wire, the current of the fluid which flows along the wire to the ground will not be sensibly luminous; but if the machine be one of great power, such for example as the Taylerian machine of Haarlem, an iron wire of 60 or 70 feet long communicating with the ground and conducting the current will be surrounded by a brilliant light. The intensity of the electricity necessary to produce this effect depends altogether on the properties of the medium in which the fluid moves. Sometimes electricity of feeble intensity produces a strong luminous effect, while in other cases electricity of the greatest intensity develops no sensible degree of light.

It has been already explained that the electric fluid with which an insulated conductor is charged is retained upon it only by the pressure of the surrounding air. According as this pressure is increased or diminished, the force necessary to enable the electricity to escape will be increased or diminished, and in the same proportion.

When a conductor A in communication with the ground approaches an insulated conductor B charged with electricity, the natural electricity of B will be decomposed, the fluid of the same name as that which charges A escaping to the earth, and the fluid of the opposite name accumulating on the side of B

next to A. At the same time, according to what has been explained (1785), the fluid on A accumulates on the side nearest to B. These two *tides* of electricity of opposite kinds exert a reciprocal attraction, and nothing prevents them from rushing together and coalescing, except the pressure of the intervening air. They will coalesce, therefore, so soon as their mutual attraction is so much increased as to exceed the pressure of the air.

This increase of mutual attraction may be produced by several causes. *First*, by increasing the charge of electricity upon the conductor A, for the pressure of the fluid will be proportional to its depth or density. *Secondly*, by diminishing the distance between A and B, for the attraction increases in the same ratio as the square of that distance is diminished; and *thirdly*, by increasing the conducting power of either or both of the bodies A and B, for by that means the electric fluids, being more free to move upon them, will accumulate in greater quantity on the sides of A and B which are presented towards each other. *Fourthly*, by the form of the bodies A and B, for according to what has been already explained (1776), the fluids will accumulate on the sides presented to each other in greater or less quantity, according as the form of those sides approaches to that of an edge, a corner, or a point.

When the force excited by the fluids surpasses the restraining force of the intervening air, they force their passage through the air, and, rushing towards each other, combine. This movement is attended with light and sound. A light appears to be produced between the points of the two bodies A and B, which has been called the *electric spark*, and this luminous phenomenon is accompanied by a sharp sound like the crack of a whip.

1812. *The electric spark*.—The luminous phenomenon called the electric spark does not consist, as the name would imply, of a luminous point which moves from the one body to the other. Strictly speaking, the light manifests no progressive motion.



Fig. 523.

It consists of a *thread of light*, which for an instant seems to connect the two bodies, and in general is not extended between them in one straight unbroken direction like a thread which might be

stretched tight between them, but has a zig-zag form resembling more or less the appearance of lightning, *fig. 523*.

1813. *Electric aigrette*.—If the part of either of the bodies A or B which is presented to the other have the form of a point, the electric fluid will escape, not in the form of a spark, but as an *aigrette* or brush light, the diverging rays of which sometimes have the length of two or three inches. A very feeble charge is sufficient to cause the escape of the fluid when the body has this form (1776).

1814. *The length of the spark*.—If the knuckle of the finger or a metallic ball at the end of a rod held in the hand be presented to the prime conductor of a machine in operation, a spark will be produced, the length of which will vary with the power of the machine.

By the *length of the spark* must be understood the greatest distance at which the spark can be transmitted.

A very powerful machine will so charge its prime conductor that sparks may be taken from it at the distance of 30 inches.

1815. *Discontinuous conductors produce luminous effects*.—Since the passage of the electricity produces light wherever the metallic continuity, or more generally wherever the continuity of the conducting material is interrupted, these luminous effects may be multiplied by so arranging the conductors that there shall be interruptions of continuity arranged in any regular or desired manner.

1816. *Various experimental illustrations*.—If a number of metallic beads be strung upon a thread of silk, each bead being separated from the adjacent one by a knot on the silk so as to break the contact, a current of electricity sent through them will produce a series of sparks, a separate spark being produced between every two successive beads. By placing one end of such a string of beads in contact with the conductor of the machine, and the other end in metallic communication with the ground, a chain of sparks can be maintained so long as the machine is worked.

The string of beads may be disposed so as to form a variety of fancy designs, which will appear in the dark in characters of light.

Similar effects may be produced by attaching bits of metallic foil to glass. Sparkling tubes and plates are contrived in this





Fig. 524.

manner, by which amusing experiments are exhibited. A glass plate is represented in *fig. 524.* by which a word is made to appear in letters of light in a dark room.

The letters are formed by attaching lozenge-shaped bits of tinfoil to the glass, disposed in the proper form. In the same manner designs may be formed on the inner surface of glass tubes, or, in fine, of glass vessels of any form.

In these cases the luminous characters may be made to appear in lights of various colours, by using spangles of different metals, since the colour of the spark varies with the metal.

1817. *Effect of rarefied air.* — When the electric fluid passes through air, the brilliancy and colour of the light evolved depends on the density of the air. In rarefied air the light is more diffused and less intense, and acquires a reddish or violet colour. Its colour, however, is affected, as has been just stated, by the nature of the conductors between which the current flows. When it issues from gold the light is green, from silver red, from tin or zinc white, from water deep yellow inclining to orange.

It is evident that these phenomena supply the means of producing electrical apparatus by which an infinite variety of beautiful and striking luminous effects may be produced.



Fig. 525.

When the electricity escapes from a metallic point in the dark, it forms an aigrette, *fig. 525.*, which will continue to be visible so long as the machine is worked.

The luminous effect of electricity in rarefied air is exhibited by an apparatus, *fig. 526.*, consisting of a glass

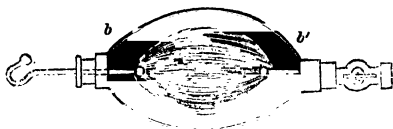

Fig. 526.

receiver *bb'*, which can be screwed upon the plate of an air-pump and partially exhausted. The electric current passes

between two metallic balls attached to rods, which slide in air-tight collars in the covers of the receiver *bb'*.

It is observed that the aigrettes formed by the negative fluid are never as long or as divergent as those formed by the positive fluid, an effect which is worthy of attention as indicating a distinctive character of the two fluids.

1818. *Experimental imitation of the auroral light.*—This phenomenon may be exhibited in a still more remarkable manner by using, instead of the receiver *bb'*, a glass tube two or three inches in diameter, and about thirty inches in length. In this case a pointed wire being fixed to the interior of each of the caps, one is screwed upon the plate of the air-pump, while the external knob of the other is connected by a metallic chain with the prime conductor of the electrical machine. When the machine is worked in the dark, a succession of luminous phenomena will be produced in the tube, which bear so close a resemblance to the aurora borealis as to suggest the most probable origin of that meteor. When the exhaustion of the tube is nearly perfect, the whole length of the tube will exhibit a violet red light. If a small quantity of air be admitted, luminous flashes will be seen to issue from the two points attached to the caps. As more and more air is admitted, the flashes of light which glide in a serpentine form down the interior of the tube will become more thin and white, until at last the electricity will cease to be diffused through the column of air, and will appear as a glimmering light at the two points.

1819. *Phosphorescent effect of the spark.*—The electric spark leaves upon certain imperfect conductors a trace which continues to be luminous for several seconds, and sometimes even so long as a minute after the discharge of the spark. The colour of this species of phosphorescence varies with the substances on which it is produced. Thus white chalk produces an orange light. With rock crystal the light first red turns afterwards white. Sulphate of barytes, amber, and loaf sugar render the light green, and calcined oyster-shell gives all the prismatic colours.

1820. *Leichtenberg's figures.*—The spark in many cases produces effects which not only confirm the hypothesis of two fluids, but indicate a specific difference between them. One of these has been already noticed. The experiment known as

Leichtenberg's figures presents another example of this. Let two Leyden jars be charged, one with positive, the other with negative electricity; and let sparks be given by their knobs to the smooth and well-dried surface of a cake of resin. Let the surface of the resin be then slightly sprinkled with powder of *Semen lycopodii*, or flowers of sulphur, and let the powder thus sprinkled be blown off. A part will remain attached to the spots where the electric sparks were imparted. At the spot which received the positive spark, the adhering powder will have the form of a radiating star; and at the point of the negative spark it will have that of a roundish clouded spot.

1821. *Experiments indicating specific differences between the two fluids.*—If lines and figures be traced in like manner on the cake of resin, some with the positive and some with the negative knob, and a powder formed of a mixture of sulphur and minium be first sprinkled over the cake and then blown off, the adhering powder will mark the traces of the two fluids imparted by the knobs, the traces of the positive fluid being yellow, and those of the negative red. In this case the sulphur is attracted by the positive electricity, and is therefore itself negative; and the minium by the negative electricity, and is therefore itself positive. The mechanical effects of the two fluids are also different, the sulphur powder being arranged in divergent lines, and the minium in more rounded and even traces.

Let two Leyden jars, one charged with positive and the other with negative electricity, be placed upon a plate of glass coated at its under surface with tinfoil at a distance of six or eight inches asunder, and let the surface of the glass between them be sprinkled with *semen lycopodii*. Let the jars be then moved towards each other, and let their inner coatings be connected by a discharging rod applied to their knobs. A spark will pass between their outer coatings through the powder, which it will scatter on its passage. The path of the positive fluid will be distinguishable from that of the negative fluid, as before explained, by the peculiar arrangement of the powder; and this difference will disappear near the point where the two fluids meet, where a large round speck is sometimes seen bounded by neither of the arrangements which characterize the respective fluids.

1822. *Electric light above the barometric column.*—The

electric light is developed in every form of elastic fluid and vapour when its density is very inconsiderable. A remarkable example of this is presented in the common barometer. When the mercurial column is agitated so as to oscillate in the tube, the space in the tube above the column becomes luminous, and is visibly so in the dark. This phenomenon is caused by the effect of the electricity developed by the friction of the mercury and the glass upon the atmosphere of mercurial vapour which fills the space above the column in the tube.

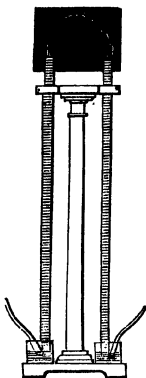

Fig. 527.

1823. *Cavendish's electric barometer.*—The electric barometer of Cavendish, *fig. 527.*, illustrates this in a striking manner. Two barometers are connected at the top by a curved tube, so that the spaces above the two columns communicate with each other. When the in-

strument is agitated so as to make the columns oscillate, electric light appears in the curved tube.

1824. *Luminous effects produced by imperfect conductors.*—The electric spark or charge transmitted by means of the universal discharger and Leyden jar or battery through various imperfect conductors, produces luminous effects which are amusing and instructive.

Place a small melon, citron, apple, or any similar fruit on the stand of the discharger; arrange the wires so that their ends are not far asunder, and at the moment when the jar is discharged the fruit becomes transparent and luminous. One or more eggs may be treated in the same manner if a small wooden ledge be so contrived that their ends may just touch, and the spark can be sent through them all. Send a charge through a lump of pipe-clay, a stick of brimstone, or a glass of water, or any coloured liquid, and the entire mass of the substance will for a short time be rendered luminous. As the phosphorescent appearance induced is by no means powerful, it will be necessary that these experiments should be performed in a dark room, and indeed the effect of the other luminous electrical phenomena will be heightened by darkening the room.

1825. *Attempt to explain electric light,—the thermal hypothesis.*—No explanation of the physical cause of the electric

spark, or of the luminous effects of electricity, has yet been proposed which has commanded general assent. It appears certain, for the reasons already stated, and from a great variety of phenomena, that the electric fluids themselves are not luminous. The light, therefore, which attends their motion must be attributed to the media, or the bodies through which or between which the fluids move. Since it is certain that the passage of the fluids through a medium develops heat in greater or less quantity in such medium, and since heat, when it attains a certain point, necessarily develops light, the most obvious explanation of the manifestation of light was to ascribe it to a momentary and extreme elevation of temperature, by which that part of the medium, or the body traversed by the fluid, becomes incandescent.

According to this hypothesis, the electric spark and the flash of lightning are nothing more than the particles of air, through which the electricity passes, rendered luminous by intense heat. There is nothing in this incompatible with physical analogies. Flame we know to be gas rendered luminous by the ardent heat developed in the chemical combinations of which combustion is the effect.

1826. *Hypothesis of decomposition and recombination.* — According to another hypothesis, first advanced by Ritter and afterwards adopted by Berzelius, Oersted, and Sir H. Davy, the electric fluids have strictly speaking no motion of translation whatever, and never in fact desert the elementary molecules of matter of which, according to the spirit of this hypothesis, they form an essential part. Each molecule or atom composing a body is supposed to be primitively invested with an atmosphere of electric fluid, positive or negative, as the case may be, which never leaves it. Bodies are accordingly classed as electro-positive or electro-negative, according to the fluid attracted to their atoms. Those atoms which are positive attract so much negative fluid, and those which are negative so much positive fluid, as is sufficient to neutralize the forces of their proper electricities, and then the atoms are unelectrized and in their natural state.

When a body is charged with positive electricity, its atoms act by induction upon the atoms of adjacent bodies, and these upon the atoms next beyond them, and so on. The fluids in the series of atoms through which the electricity is supposed to

pass, assumes a polar arrangement such as that represented in *fig. 528*.



Fig. 528.

The first atom of the series being surcharged with + electricity acts by induction on the second, and decomposes its natural electricity, the negative fluid being attracted to the side near the first atom, and the positive repelled to the side near the third atom. The same effect is produced by atom 2 on atom 3, by atom 3 on atom 4, and so on. The surplus positive fluid on 1 then combines with and neutralizes the negative fluid on 2; and, in like manner, the positive fluid on 2 combines with and neutralizes the negative fluid on 3, and so on until the last atom of the series is left surcharged with positive electricity.

Such is the hypothesis of decomposition and recombination which is at present in most general favour with the scientific world.

The explanation which it affords of the electric spark and other luminous electric effects, may be said to consist in transferring the phenomenon to be explained from the bodies themselves to their component atoms, rather than in affording an explanation of the effect in question, inasmuch as the production of light between atom and atom by the alternate decomposition and recombination of the electricities stands in as much need of explanation as the phenomenon proposed.

1827. *Cracking noise attending electric spark*.—The sound produced by the electric discharge is obviously explained by the sudden displacement of the particles of the air, or other medium through which the electric fluid passes.

## CHAP. XII.

### PHYSIOLOGICAL EFFECTS OF ELECTRICITY.

1828. *Electric shock explained*.—The material substances which enter into the composition of the bodies of animals are

generally imperfect conductors. When such a body, therefore, is placed in proximity with a conductor charged with electricity, its natural electricity is decomposed, the fluid of a like name being repelled to the side more remote from, and the fluid of the contrary name being attracted to the side nearest to, the electrified body. If that body be very suddenly removed from or brought near to the animal body, the fluids of the latter will suddenly suffer a disturbance of their equilibrium, and will either rush towards each other to recombine, or be drawn from each other, being decomposed; and owing to the imperfection of the conducting power of the fluids and solids composing the body, the electricity in passing through it will produce a momentary derangement, as it does in passing through air, water, paper, or any other imperfect conductor. If this derangement do not exceed the power of the parts to recover their position and organization, a convulsive sensation is felt, the violence of which is greater or less according to the force of electricity and the consequent derangement of the organs; but if it exceed this limit, a permanent injury, or even death, may ensue.

1829. *Secondary shock*.—It will be apparent from this, that the nervous effect called the *electric shock* does not require that any electricity be actually imparted to, abstracted from, or passed through the body. The momentary derangement of the natural electricity is sufficient to produce the effect with any degree of violence.

The shock produced thus by induction, without transmitting electricity through the body, is sometimes called the *secondary shock*.

The physiological effects of electricity are extremely various, according to the quantity and intensity of the charge, and according to the part of the body affected by it, and according to the manner in which it is imparted.

1830. *Effect produced on the skin by proximity to an electrified body*.—When the back of the hand is brought near to the glass cylinder of the machine, at the part where it passes from under the silk flap, and when therefore it is strongly charged with electricity, a peculiar sensation is felt on the skin, resembling that which would be produced by the contact of a cobweb. The hairs of the skin being negatively electrified by induction, are attracted and drawn against their roots with a slight force.

1831. *Effect of the sparks taken on the knuckle.*—The effect of the shock produced by a spark taken from the prime conductor by the knuckle is confined to the hand; but with a very powerful machine, it will extend to the elbow.

1832. *Methods of limiting and regulating the shock by a jar.*—The effects of the discharge of a Leyden jar extend through the whole body. The shock may, however, be limited to any desired part or member by placing two metallic plates connected with the two coatings of the jar on opposite sides of the part through which it is desired to transmit the shock.

1833. *Effect of discharges of various force.*—The violence of the shock depends on the magnitude of the charge, and may be so intense as to produce permanent injury. The discharge of a single jar is sufficient to kill birds, and other smaller species of animals. The discharge of a moderate-sized battery will kill rabbits, and a battery of a dozen square feet of coated surface will kill a large animal, especially if the shock be transmitted through the head.

1834. *Phenomena observed in the autopsy after death by the shock.*—When death ensues in such cases, no organic lesion or other injury or derangement has been discovered by the autopsy; nevertheless, the violence of the convulsions which are manifested when the charge is too feeble to destroy life, indicates a nervous derangement as the cause of death.

1835. *Effects of a long succession of moderate discharges.*—A succession of electric discharges of moderate intensity, transmitted through certain parts of the body, produce alternate contraction and relaxation of the nervous and muscular organs, by which the action of the vascular system is stimulated and the sources of animal heat excited.

1836. *Effects upon a succession of patients receiving the same discharge.*—The electric discharge of a Leyden jar may be transmitted through a succession of persons placed hand in hand, the first communicating with the internal, and the last with the external coating of the jar.

In this case, the persons placed at the middle of the series sustain a shock less intense than those placed near either extremity,—another phenomenon which favours the hypothesis of two fluids.

1837. *Remarkable experiments of Nollet, Dr. Watson, and others.*—A shock has in this manner been sent through a



regiment of soldiers. At an early period in the progress of electrical discovery, M. Nollet transmitted a discharge through a series of 180 men; and at the convent of Carthusians a chain of men being formed extending to the length of 5400 feet, by means of metallic wires extended between every two persons composing it, the whole series of persons was affected by the shock at the same instant.

Experiments on the transmission of the shock were made in London by Dr. Watson, in the presence of the Council of the Royal Society, when a circuit was formed by a wire carried from one side of the Thames to the other over Westminster Bridge. One extremity of this wire communicated with the interior of a charged jar, the other was held by a person on the opposite bank of the river. This person held in his other hand an iron rod, which he dipped in the river. On the other side near the jar stood another person, holding in one hand a wire communicating with the exterior coating of the jar, and in the other hand an iron rod. This rod he dipped into the river, when instantly the shock was received by both persons, the electric fluid having passed over the bridge, through the body of the person on the other side, through the water across the river, through the rod held by the other person, and through his body to the exterior coating of the jar. Familiar as such a fact may now appear, it is impossible to convey an adequate idea of the amazement bordering on incredulity with which it was at that time witnessed.

### CHAP. XIII.

#### CHEMICAL AND MAGNETIC EFFECTS OF ELECTRICITY.

1838. *Phenomena which supply the basis of the electro-chemical theory.*—If an electric charge be transmitted through certain compound bodies they will be resolved into their constituents, one component always going in the direction of the positive, and the other of the negative fluids. This class of phenomena has supplied the basis of the electro-chemical hypothesis already briefly noticed (1826). The constituent which goes to the posi-

tive fluid is assumed to consist of atoms which are electrically negative, and that which goes to the negative fluid, as consisting of atoms electrically positive.

1839. *Faraday's experimental illustration of this.*—This class of phenomena is more prominently developed by voltaic electricity, and will be more fully explained in the following Book. For the present it will therefore be sufficient to indicate an example of this species of decomposition by the electricity of the ordinary machine. The following experiment is due to Professor Faraday.

Lay two pieces of tinfoil  $\tau \tau'$ , *fig. 528. a*, on a glass plate, one being connected with the prime conductor of the machine, and

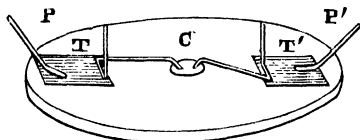

Fig. 528 a.

the other with the ground. Let two pieces of platinum wire  $PP'$ , resting on the tinfoil, be placed with their points on a drop of the solution of the sulphate of copper  $c$ , or on a piece of bibulous paper wetted with sulphate of indigo in muriatic acid, or iodide of potassium in starch, or litmus paper wetted with a solution of common salt or of sulphate of soda, or upon turmeric paper containing sulphate of soda.

In all these cases the solutions are decomposed: in the first, the copper goes to the positive wire; in the second the indigo is bleached by the chlorine discharged at the same wire; in the third the iodine is liberated at the same wire; in the fourth the litmus paper is reddened by the acid evolved at the positive wire, and when muriatic is used, it is bleached by the chlorine evolved at the same wire; and, in fine, in the fifth case, the turmeric paper is reddened by the alkali evolved at the negative wire.

1840. *Effect of an electric discharge on a magnetic needle.*—When a stream of electricity passes over a steel needle or bar of iron, it produces a certain modification in its magnetic state. If the needle be in its natural state it is rendered magnetic. If it be already magnetic its magnetism is modified,

being augmented or diminished in intensity, according to certain conditions depending on the direction of the current and the position of the magnetic axis of the needle; or it may have its magnetism destroyed, or even its polarity reversed.

This class of phenomena, like the chemical effects just mentioned, are, however, much more fully developed by voltaic electricity; and we shall therefore reserve them to be explained in the following Book. Meanwhile, however, the following experiments will show how common electricity may develop them.

1841. *Experimental illustration of this.*—Place a narrow strip of copper, about two inches in length, on the stage of the universal discharger, and over it place a leaf of any insulating material, upon which place a sewing needle transversely to the strip of copper. Transmit several strong charges of electricity through the copper. The needle will then be found to be magnetized, the end lying on the right of the current of electricity being its north pole.

If the same experiment be repeated, reversing the position of the needle, it will be demagnetized. But by repeating the electric discharges a greater number of times, it will be magnetized with the poles reversed.

## BOOK THE FOURTH.

## VOLTAIC ELECTRICITY.

## CHAP. I.

## SIMPLE VOLTAIC COMBINATION.

1842. *Discovery of galvanism.*—In tracing the progress of physical science, the greatest discoveries are frequently found to originate, not in the sagacity of observers, but in circumstances altogether fortuitous. One of the most remarkable examples of this is presented by Voltaic Electricity. Speaking of the voltaic pile, Arago, in his *Eloge de Volta*, says, that “this immortal discovery arose in the most immediate and direct manner, from an indisposition with which a Bolognese lady was affected in 1790, for which her medical adviser prescribed *frog-broth.*”

Galvani, the husband of the lady, was Professor of Anatomy in the University of Bologna. It happened that several frogs, prepared for cooking, lay upon the table of his laboratory, near to which his assistant was occupied with an electrical machine. On taking sparks from time to time from the conductor, the limbs of the frogs were affected with convulsive movements resembling vital action.

This was the effect of the inductive action of the electricity of the conductor upon the highly electroscopic organs of the frogs; but Galvani was not sufficiently conversant with this branch of physics to comprehend it, and consequently regarded it as a new phenomenon. He proceeded to submit the limbs of frogs to a course of experiments, with the view to ascertain the cause of what appeared to him so strange. For this purpose, he dissected several frogs, separating the legs, thighs, and lower part of the spinal column from the remainder, so as to lay bare the lumbar nerves. He then passed *copper* hooks through that part of the dorsal column which remained above the junction of the thighs, without any scientific object, but merely

for the convenience of suspending them until required for experiment. It chanced, also, that he suspended these *copper* hooks upon the *iron* bar of the balcony of his window, when, to his inexpressible astonishment, he found that whenever the wind or any other accidental cause brought the muscles of the leg into contact with the iron bar, the limbs were affected by convulsive movements similar to those produced by the sparks taken from the conductor of the electric machine.

This fact, reproduced and generalized, supplied the foundation of the theory of animal electricity propounded by Galvani, and for a considerable time universally accepted. In this theory it was assumed, that in the animal economy there exists a specific source of electricity; that at the junction of the nerves and muscles this electricity is decomposed, the positive fluid passing to the nerve, and the negative to the muscle; and that, consequently, the nerve and muscle are in a state of relative electrical tension, analogous to that of the internal and external coatings of a charged Leyden jar. When, under these circumstances, rods of metal *z c*, *fig. 529.*, are applied, one to the nerve, and the other to the muscle, the opposite electricities rush towards each other along the conducting rods; a discharge of the nerve and muscle takes

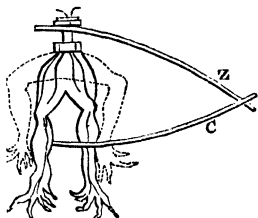

Fig. 529.

place, like that of the Leyden jar; and this momentary derangement of the electrical condition of the organ produces the convulsive movement.

1843. *Volta's correction of Galvani's theory.*—Volta, then Professor of Natural Philosophy at Como, and afterwards at Pavia, repeating the experiments of Galvani, overturned

his theory by various ingenious experimental tests, one of which consisted in showing that the effects of the electric shock were equally produced when both metallic rods were applied to the muscle, neither touching the nerve. He contended that Galvani, in taking the nerve and muscle to represent the coatings of the Leyden jar, and the metallic rods the discharging conductor, had precisely inverted the truth, for that the rods represented the jar, and the nerve and muscle the conductor.

If the rods, as Galvani supposed, played the part of the metallic conductor, communicating between the opposite elec-

tricitities imputed to the nerve and muscle, a single rod of one uniform metal would serve this purpose, not only as well, but better than two rods of different metals; whereas, the presence of *two different metals in contact*, was essential to the development of the phenomenon.

In fine, Volta maintained, and ultimately proved, that the electricity decomposed, was not that of the nerve and muscle, but that of the metallic rods; that the seat of the decomposition was not the junction of the nerve and muscle, but the junction of the two metals; that the positive and negative fluids passed, not upon the nerve and muscle, but upon the iron and copper forming the rods flowing in opposite directions from their point of junction; and that, in fine, the nerve and muscle, or the latter alone, served merely as the conductor by which the opposite electricities developed on the metals were recomposed, exactly as they would if placed between the internal and external coatings of a charged Leyden jar.

1844. *Theory of animal electricity exploded.*—After a conflict of some years' duration, the animal electricity of Galvani fell before the irresistible force of the reasoning and experiments of Volta, whose theory obtained general acceptance. This form of electric agency has since been denominated indifferently, GALVANISM OR VOLTAIC ELECTRICITY.

1845. *Contact hypothesis of Volta.*—According to the hypothesis of Volta, now known as the CONTACT THEORY, any two different metals, or, more generally, any two different bodies which are conductors of electricity, being placed in contact, a spontaneous decomposition of their natural electricity will be effected at their surface of contact, the positive fluid moving from such surface and diffusing itself over the one, and the negative moving in the contrary direction and diffusing itself over the other, the surface of contact constituting a neutral line separating the two fluids.

1846. *Electro-motive force.*—This power of electric decomposition was called by Volta, ELECTRO-MOTIVE FORCE.

Different bodies placed in contact manifest different electro-motive forces, the energy of the electro-motive force being measured by the quantity of electricity decomposed.

*Its direction and intensity.*—The electro-motive force acts on the two fluids in opposite directions, but it will be convenient to designate its direction by that of the positive fluid.

To indicate, therefore, the electro-motive force developed when any two conductors are placed in contact, it is necessary to assign the energy and direction of such force, which is done by showing the intensity of the electricity developed, and the conductor towards which the positive fluid is directed.

1847. *Classification of bodies according to their electro-motive property.* — Although the results of experimental research are not in strict accordance on these points, the electric tensions produced by the mere contact of heterogeneous conductors being in general so feeble as to elude the usual electroscopic tests, it has nevertheless been found, that bodies may be arranged so that any one placed in contact with another holding a lower place in the series, will receive the positive fluid, the lower receiving the negative fluid, and so that the electro-motive force of any two shall be greater the more distant they are from each other in the series. How far the results of experimental researches are in accordance on these points, will be seen by comparing the following series of electromoters given by Volta, Pfaff, Henrici, and Pecelet : —

Volta.	Pfaff.	Henrici.	
Zinc.	Zinc.	Zinc.	Zinc.
Lead.	Lead.	Lead.	Lead.
Tin.	Cadmium.	Tin.	Tin.
Iron.	Tin.	Antimony.	Bismuth.
Copper.	Iron.	Bismuth.	Antimony.
Silver.	Bismuth.	Iron.	Iron.
Graphite.	Cobalt.	Brass.	Copper.
Charcoal.	Arsenic.	Copper.	Silver.
Crystallized Amber.	Copper.	Silver.	Gold.
	Antimony.	Mercury.	Platinum.
	Platinum.	Gold.	
	Gold.	Platinum.	
	Mercury.		
	Silver.		
	Charcoal.		

To which Pfaff adds the following mineral substances in the order here given : Argentum vitreum (vitreous silver ore), sulphurous pyrites, cuprum mineralisatum pyritaceum (yellow copper ore), galena, crystallized tin, niccolum sulphuratum arsenicum pyritaceum (arsenical mundick), molydena, protoxyde of uranium, oxyde of titanium, graphite, wolfram (tungstate of iron and manganese), gypsum stillatium, crystallized amber, peroxyde of lead (?).

It is to be understood, that, according to the results of the experimental researches of the observers above named, the

electro-motive force produced by the contact of any two of the bodies in the preceding series will be directed from that which holds the lower to that which holds the higher place, and that the energy of such electro-motive force will be greater the more remote the one body is from the other in the series.

1848. *Relation of electro-motive force to susceptibility of oxydation.*—The mere inspection of these several series will suggest the general conclusion, that the electro-motive force is directed from the less to the more oxydable body, and that the more the one exceeds the other in its susceptibility of oxydation, the more energetic will be the electro-motive force. Thus, a combination of zinc with platinum produces more electro-motive energy than a combination of zinc with any of the more oxydable metals.

If several electromoters of the series be placed in contact in any order, the total electro-motive force developed is found to be the same as if the first were immediately in contact with the last. The intermediate elements are therefore in this case inefficient.

1849. *Analogy of electro-motive action to induction.*—It appears, therefore, that when two pieces of different metals taken from the series of electromoters, such as zinc and copper for example, are brought into contact, an electric state is produced in their combined mass similar to that which would be produced by placing an insulated conductor charged with positive electricity near the copper side of the combination. The inductive action of such a conductor would decompose the natural electricity of the combined mass, attracting the negative fluid to the side near the conductor, that is, to the copper element, and repelling the positive fluid to the opposite side, that is, to the zinc element. But this is precisely the effect of the electro-motive force of the two metals as already described.

Let *z* and *c*, *fig. 530.*, be cylinders of zinc and copper placed end to end. The former will, by the contact, be charged with positive, and the latter with negative electricity. Let the two cylinders, being insulated, be separated, and the one will be positively, and the other negatively electrified; but in this case the intensity of the electricity deve-

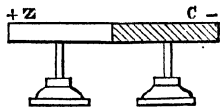

Fig. 530.



loped upon them will be so feeble, that it cannot be rendered manifest by any of the ordinary electroscopic tests. Let it, however, be imparted to the collecting plate of a powerful condensing electroscope, and, after the two cylinders *z* and *c* are discharged, let them be again placed in contact. They will be again charged by their electro-motive action, and their charges may, as before, be imparted to the collecting plates of the electroscopes; and this process may be repeated until the electricities of each kind accumulated in the plates of the electroscopes becomes sensible.

1850. *Electro-motive action of gases and liquids.*—Several German philosophers have recently instituted elaborate experimental researches to determine the electro-motive action of liquids, and even of gases, on solids and on each other. The labours of Pfaff have been especially directed to this inquiry, and have enabled him to arrive at the following general conclusions respecting the electro-motive force developed by the contact of solid with liquid conductors.

The electro-motive force produced by the contact of alkaline liquids with the metals, is generally directed from the metal to the liquid, and its energy is greater the higher is the place held by the metal in the series of electromoters (1847). Thus, tin, antimony, and zinc, in contact with caustic potash, caustic soda, or ammonia, have a more energetic action than platinum, bismuth, or silver.

The electro-motive force of nitric acid in contact with a metal, is invariably directed from the acid to the metal. In this acid, iron and platinum are the most powerful, and zinc the most feeble electromoters.

Sulphuric and hydrochloric acid, in contact with those metals which stand at the head of the series (1847), develop a force directed from the acid to the metal, and in contact with those at the lowest part of the series, produce a force directed from the metal to the acid. Thus, these acids in contact with the less oxydable metals, as gold, platinum, copper, give an electro-motive force directed from the acid to the metal; but in contact with the more oxydable, as antimony, tin, or zinc, give a force directed from the metal to the acid.

When the metals are placed in contact with weak acid, or saline solutions generally, the electro-motive force is directed from the metal to the liquid, the energy of the force being in

general greater the higher is the place of the metal in the series of electrometers (1847). In the case of the metals holding the lowest places in the series, the electro-motive force is in some instances directed with feeble intensity from the liquid to the metal.

1851. *Differences of opinion as to the origin of electro-motive action.*—Since the date of the discoveries of Volta to the present day, opinion has been divided in the scientific world as to the actual origin of that electrical excitation which is here expressed by the term electro-motive force, and which, as has been explained, Volta ascribed to the mere mechanical contact of heterogeneous conductors. Some have contended—and among them many of the most eminent recent discoverers in this branch of physics—that the real origin of the electro-motive force is the chemical action which takes place between the solid and liquid conductors; and that, in the cases where there is an apparent development of electricity by the contact of heterogeneous solid conductors, its real source has been the unperceived chemical action of moisture on the more oxydable electrometer. Others, without disputing the efficacy of chemical action, maintain that it is a secondary agent, merely exciting the electro-motive energy of the solid conductors. Thus, Martens holds that liquids are not properly electrometers at all, but rather modify the electro-motive force of the metals in contact with them; so that they may be considered as sometimes augmenting and sometimes diminishing the effect of the two metals. It is admitted by the partisans of the theory of contact, that the liquids which most powerfully influence the electro-motive force of the solids are those which act chemically on them with greatest energy. But it is contended, that liquids which produce no chemical change on the metal with which they are in contact, do nevertheless affect its electro-motive action.

It fortunately happens, that this polemic can produce no obstacle to the progress of discovery, nor can it affect the certitude of the general conclusions which have been based upon observed facts; while, on the other hand, the spirit of the opposition arising from the conflicting theories, has led to experimental results of the highest importance.

Whatever, therefore, be the origin of the electricity developed under the circumstances which have been described, we shall

continue to designate it by the term electro-motive force, by which it was first denominated by its illustrious discoverer; and we shall invariably designate as the direction of this force that which the positive fluid takes in passing from one element to another in the voltaic combination.

1852. *Polar arrangement of the fluids in all electro-motive combinations.*—In every voltaic combination, therefore, the effect of the electro-motive force is a *polar* arrangement of the decomposed fluids; the positive fluid being driven towards that extremity of the system to which the electro-motive force is directed, and the negative fluid retiring towards the other extremity.

1853. *Positive and negative poles.*—These extremities are therefore denominated the **POLES** of the system; that towards which the electro-motive force is directed, and where the positive fluid is collected, being the **POSITIVE**, and the other the **NEGATIVE** pole.

1854. *Electro-motive effect of a liquid interposed between two solid conductors.*—When a liquid conductor is placed in contact with and between two solid conductors, an electrical condition is induced, the nature of which will be determined by the quantities and direction of the electro-motive forces developed at the two surfaces of contact. The several varieties of condition presented by such a voltaic arrangement are represented in *fig. 531.* to *fig. 536.*

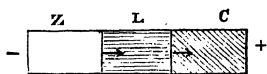

Fig. 531.

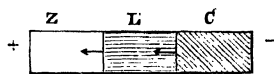

Fig. 532.



Fig. 533.

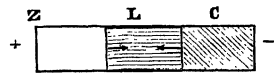

Fig. 534.

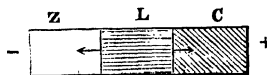

Fig. 535.

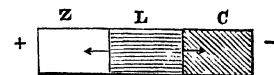

Fig. 536.

Let *z* and *c* represent the solid, and *l.* the liquid conductors; and let the arrows directed from the two surfaces of contact represent in each case the direction of the electro-motive forces.

If the electro-motive forces be both directed to the same pole, as in *figs.* 531, 532., that pole receiving all the positive fluid transmitted by the conductors will be the positive pole, and the other, receiving all the negative fluid transmitted, will be the negative pole.

The quantity of electricity with which each pole will be charged, will be the sum of the quantities developed by the electro-motive forces at the two surfaces, diminished by the sum of the quantities intercepted by reason of the imperfect conducting power of the liquid and solids, and by reason of the quantity intercepted in passing from the liquid to the solid conductors at their common surface.

If the electro-motive forces be directed to opposite poles, that pole to which the more energetic is directed will be the positive pole. The varieties of conditions presented by this case are represented in *figs.* 533, 534, 535, and 536. Each pole in these cases receives positive fluid from one surface, and negative from the other. That to which the more energetic electro-motive force is directed receives more positive than negative fluid, and is therefore charged with positive fluid equal to their difference, and is, consequently, the positive pole. The other receives more negative than positive fluid, and is, consequently, the negative pole.

In the case represented in *fig.* 533., the electro-motive force between *z* and *L* is the more energetic. A greater quantity of positive fluid is received by *c* from the surface *zL* than of negative fluid from the surface *CL*, and the surplus of the former above the latter constitutes the free electricity of the positive pole *c*. In like manner, the quantity of negative fluid received by the pole *z* from the surface *zL* predominates over the quantity of positive fluid received from the surface *CL*, and the surplus of the former over the latter constitutes the free electricity of the negative pole *z*.

The like reasoning, *mutatis mutandis*, will be applicable to *figs.* 534., 536., in which the electro-motive force between *z* and *L* is the more energetic, and to *fig.* 535., in which the electro-motive force between *c* and *L* is the more energetic.

In all these cases, the quantity of electricity with which the poles are charged is the difference between the actual quantities developed by the two electro-motive forces, diminished by the

difference between the quantities intercepted by the imperfection of the conduction of the liquid and solid, and in passing through the surface which separates the liquid and solid conductors.

1855. *Electro-motive action of two liquids between two solids.* — The quantity of electricity developed may be augmented by placing different liquid conductors in contact with the two solid conductors. In this case, however, it is necessary to provide some expedient by which the two liquids, without being allowed to intermingle, may nevertheless be in contact, so that the electricities transmitted from the electro-motive surfaces may pass freely from the one liquid to the other. This may be accomplished by separating the liquids by a diaphragm or partition composed of some porous material, which is capable



Fig. 537.

of imbibing the liquids without being sufficiently open in its texture to allow the liquids to pass in any considerable quantity through it. A partition of unglazed porcelain is found to answer this purpose perfectly. Such an arrangement is represented in *fig. 537.*, where *z* and *c* are the solid electromotors, *L* and *L'* the two liquids, and *P* the porous partition separating them.

1856. *Practical examples of such combinations.* — As a practical example of the application of these principles, let the liquid *L*, *fig. 531.*, be concentrated sulphuric acid placed between a plate of zinc *z*, and a plate of copper *c*. In this case the electro-motive force is directed from *z* to *L*, and from *L* to *c*; and, consequently, the tension of the negative electricity on *z*, and the positive electricity on *c*, will be the sum of the tensions transmitted from the two surfaces, and *z* will be the negative, and *c* the positive pole (1854).

If the liquid be a dilute solution of acid or salt, or a strong alkaline liquid, the electro-motive forces are both directed from the metal to the liquid, but that of the zinc is more energetic than that of the copper; consequently *z*, *fig. 533.*, will in this case be the negative, and *c* the positive pole, the energy of the combination being proportional to the difference of the two electro-motive forces.

If the liquid be concentrated nitric acid, the electro-motive forces will be both directed from the liquid to the metals. In this case the zinc *z*, *fig. 535.*, being the more feeble electromoter,

the copper element *c* will be the positive, and the zinc *z* the negative pole.

If two different liquids be interposed between plates of the same metal, the conditions which affect the development of electricity may be determined by similar reasoning.

If *z* and *c*, *fig.* 537., be two plates of the same metal, and *L* and *L'* be two liquids, between which and the metal there are unequal electro-motive forces, the effect of such an arrangement will be a polar development, the positive pole being that to which the electro-motive forces are directed if they have a common direction, and that of the more energetic if they act in opposite directions. The intensity of the charge at the poles will be in the one case the sum, and in the other the difference of the quantities of fluid transmitted.

As a practical example of the application of this principle, let the metals *z* and *c* be both platinum, and let *L* be an alkaline solution, and *L'* concentrated nitric acid. In this case the electro-motive forces will be directed from *z* to *L*, and from *L'* to *c*, and the effect of the arrangement will be similar to that represented in *fig.* 531.

1857. *Most powerful combinations determined.*—The most powerful voltaic arrangements are produced by taking two metals from the extremes of the electro-motive series (1847), and interposing between them two liquids, the electro-motive force of one being directed from the metal to the liquid, and of the other from the liquid to the metal, and so selecting the liquids, subject to this latter condition, as to have the greatest possible electro-motive action on the respective metals.

Observing these principles, voltaic combinations of extraordinary power have been produced by interposing dilute sulphuric *L*, *fig.* 537., and concentrated nitric acid *L'*, between zinc *z*, and carbon or platinum *c*. In such a combination, strong electro-motive forces are developed, directed from the zinc to the acids, and from the acids to the carbon or platinum. The zinc is therefore the negative, and the carbon or platinum the positive pole of the system.

1858. *Form of electro-motive combination.*—We have selected the form of parallel plates or columns, which has been supposed in the arrangements here described, merely because of the clearness and simplicity which it gives to the exposition of the principles upon which all voltaic combinations act. This

form, although it was that of the earliest voltaic systems, and is still in some cases adhered to, is neither essential to the principle of such arrangements, nor convenient where the development of great force is required. In order to obtain as great an extent of electro-motive surface in as small a volume as is practicable, the form of hollow cylinders of varying diameters, placed concentrically in cylindrical vessels a little larger, and containing the exciting liquid, is now generally preferred.

1859. *Volta's first combination.*—The simple arrangements first adopted by Volta consisted of two equal discs of metal, one of zinc, and the other of copper or silver, with a disc of cloth or bibulous card, soaked in an acid or saline solution, between them. These were usually laid, with their surfaces horizontal, one upon the other.

1860. *Wollaston's combination.*—The late Dr. Wollaston proposed an arrangement, in which the copper plate was bent into two parallel plates, a space between them being left for the insertion of the zinc plate, the contact of the plates being prevented by the interposition of bits of cork or other non-conductor. The system thus combined was immersed in dilute acid contained in a porcelain vessel.

1861. *Hare's spiral arrangement.*—This consists of two metallic plates, one of zinc and the other of copper, of equal length, rolled together into the form of a spiral, a space of a quarter of an inch being left between them. They are maintained parallel without touching, by means of a wooden cross at top and bottom, in which notches are provided at proper distances, into which the plates are inserted, the two crosses having a common axis. This combination is let into a glass or porcelain cylindrical vessel of corresponding magnitude, containing the exciting liquid.

This arrangement has the great advantage of providing a very considerable electro-motive surface with a very small volume.

The exciting liquid recommended for these batteries when great power is desired, is a solution in water of  $2\frac{1}{4}$  per cent of sulphuric, and 2 per cent of nitric acid. A less intense but more durable action may be obtained by a solution of common salt, or of 3 to 5 per cent of sulphuric acid only.

1862. *Amalgamation of the zinc.*—Whatever be the form

of the arrangement, its force and uniformity of action will be promoted by amalgamating the zinc element, which may be best accomplished in the following manner.

Immerse the rough plate or cylinder of zinc in a solution of sulphuric acid containing from 12 to 16 per cent. of acid, until the thin film of oxide which usually collects on the surface of the metal be dissolved. Then wash it well in water, and immerse it in a dilute solution of the nitrate of mercury. After a short time a perfectly uniform amalgam will be formed on the surface of the zinc. Let the zinc be then washed in water and rubbed dry with saw-dust.

1863. *Cylindrical combination with one fluid.*—Voltaic systems of the cylindrical form usually consist of two hollow cylinders of different metals, one of which, however, is always zinc. The exciting liquid being placed in a cylindrical vessel a little longer than the greater of the two hollow metallic cylinders, these are immersed in it concentrically with it and with each other. A part of each projecting from the top of the vessel becomes the pole of the system.

Such a combination is represented in vertical section in *fig. 538.*, where *vv* is a vessel of glazed porcelain, containing the acid or saline solution, *zz* is a hollow cylinder of zinc, and *cc* a similar hollow cylinder of copper, each being open at both ends, and separated from each other by a space of a quarter to half an inch. Strips of metal *cp* and *zn* represent the poles, that connected with the zinc being the negative, and that connected with the copper being the positive pole.

In some cases the porcelain vessel *vv* is dispensed with, and the acid solution is placed in a cylindrical copper vessel, in

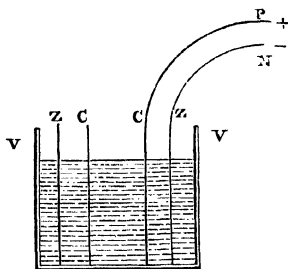

Fig. 538.

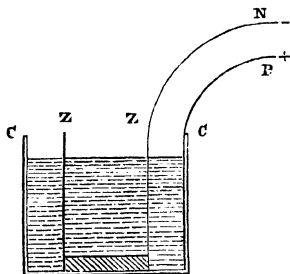

Fig. 539.



1864. *Cylindrical combinations with two fluids.*—Cylindrical arrangements with two exciting liquids are made in the following manner.

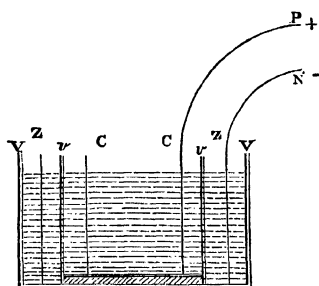

Fig. 540.

The hollow cylinder of zinc *z z*, open at both ends as already described, is placed in a vessel of glazed porcelain *v v*, *fig. 540*. Within this is placed a cylindrical vessel *v v*, of unglazed porcelain, a little less in diameter than the zinc *z z*, so that a space of about a quarter of an inch may separate their surfaces. In this vessel *v v*, is inserted a cylinder *c c* of platinum, open

at the ends, and a little less than *v v*, so that their surfaces may be about a quarter of an inch asunder. Dilute sulphuric acid is then poured into the vessel *v v*, and concentrated nitric acid into *v v*. According to what has been already explained (1857), *P* proceeding from the platinum will then be the positive, and *N* proceeding from the zinc the negative pole.

1865. *Grove's battery.*—This arrangement is known as GROVE'S BATTERY. Various modifications have been suggested with the view to increase the electro-motive surface of the platinum and economize expense. Grüel suggests the use of thin platinum, attached by platinum wires to a central axis, from which from 4 to 6 leaves or flaps diverge. Poggendorf proposes a single leaf of platinum, greater in breadth than the diameter of the vessel *v v* in the ratio of about 3 to 2, and bent into the form of an S, so as to pass freely into it. Pfaff proposes to coat the inner surface of the vessel *v v* with leaf platinum. Peschel affirms, after having tried this expedient, that it is less effective than the former.

In these systems it is recommended to use a solution of sulphuric acid containing from 10 to 25 per cent. of acid, and nitric acid of the specific gravity of 1.33.

1866. *Bunsen's battery.*—The voltaic system known as

**BUNSEN'S**, is similar to the preceding, substituting charcoal for platinum. The charcoal cylinder used for this purpose, is made from the residuum taken from the retorts of gas-works. A strong porous mass is produced by repeatedly baking the pulverized coke, to which the required form is easily imparted. Messrs. Deleuil and Son, of Paris, have fabricated batteries on this principle with great success. I have one at present in use consisting of fifty pairs of zinc and carbon cylinders, the zinc being  $2\frac{1}{2}$  inches diameter, and 8 inches high, which performs very satisfactorily.

The electro-motive forces of Grove's and Bunsen's batteries are considered to be, *ceteris paribus*, equal.

1867. *Daniel's constant battery*.—The voltaic arrangement known as Daniel's constant battery consists of a copper cylindrical vessel *c c*, *fig. 541.*, widening near the top *ad*. In this

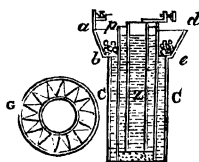

Fig. 541.

is placed a cylindrical vessel of unglazed porcelain *p*. In this latter is placed the hollow cylinder of zinc *z*, already described. The space between the copper and porcelain vessels is filled with a saturated solution of the sulphate of copper, which is maintained in a state of saturation by crystals of the salt placed in the wide cup *abcd*, in the bottom of which is a grating composed of wire carried in a zigzag direction between two concentric rings, as represented in plan at *g*. The vessel *p*, containing the zinc, is filled with a solution of sulphuric acid, containing from 10 to 25 per cent. of acid when greater electro-motive power is required, and from 1 to 4 per cent. when more moderate action is sufficient.

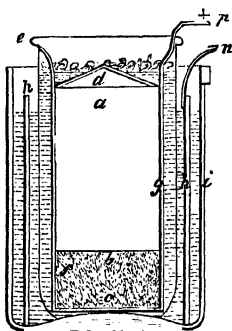

Fig. 542.

1868. *Pouillet's modification of Daniel's battery*.—The following modification of Daniel's system was adopted by M. Pouillet in his experimental researches. A hollow cylinder *a*, *fig. 542.*, of thin copper, is ballasted with sand *b*, having a flat bottom *c*, and a conical top *d*. Above this cone the sides of the copper cylinders are continued, and terminate in a flange *e*. Between this

flange and the base of the cone, and near the base, is a ring of holes. This copper vessel is placed in a bladder which fits it loosely like a glove, and is tied round the neck under the flange *e*. The saturated solution of the sulphate of copper is poured into the cup above the cone, and, flowing through the ring of holes, fills the space between the bladder and the copper vessel. It is maintained in its state of saturation by crystals of the salt deposited in the cup.

This copper vessel is then immersed in a vessel of glazed porcelain *i*, containing a solution of the sulphate of zinc or the chloride of sodium (common salt). A hollow cylinder of zinc *h*, split down the side so as to be capable of being enlarged or contracted at pleasure, is immersed in this solution surrounding the bladder. The poles are indicated by the conductors *p* and *n*, the positive proceeding from the copper, and the negative from the zinc.

M. Pouillet states that the action of this apparatus is sustained without sensible variation for entire days, provided the cup above the cone *d* is kept supplied with the salt, so as to maintain the solution in the saturated state.

1869. *Advantages and disadvantages of these several systems.*—The chief advantage of Daniel's system is that from which it takes its name, its *constancy*. Its power, however, in its most efficient state, is greatly inferior to that of the carbon or platinum systems of Bunsen and Grove. A serious practical inconvenience, however, attends all batteries in which concentrated nitric acid is used, owing to the diffusion of nitrous vapour, and the injury to which the parties working them are exposed by respiring it. In my own experiments with Bunsen's batteries the assistants have been often severely affected.

In the use of the platinum battery of Grove, the nuisance produced by the evolution of nitrous vapour is sometimes mitigated by enclosing the cells in a box, from the lid of which a tube proceeds which conducts these vapours out of the room.

In combinations of this kind, Dr. O'Shaugnessy substituted gold for platinum, and a mixture of two parts by weight of sulphuric acid to one of saltpetre for nitric acid.

1870. *Smee's battery.*—The voltaic combination called SMEE'S BATTERY, consists of a porcelain vessel *A*, *fig. 543.*, containing an acid solution, which may be about 15 per cent. of sulphuric acid in water. A plate of iron or silver *s*, whose surfaces are

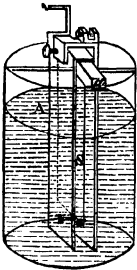

Fig. 543.

*platinized* by a certain chemical process, is suspended from a bar of wood *a*, between two plates of zinc *z*, suspended from the same bar without contact with the plate *s*. The electro-motive action is explained on the same principle as the combinations already described. Mr. Smee claims, as an advantage for this system, its great simplicity and power, the quantity of electricity evolved being, *ceteris paribus*, very great, and the manipulation easy.

1871. *Wheatstone's system*.—Professor Wheatstone has proposed the combination represented in *fig. 544*. A cylindrical vessel *vv*, of unglazed and half-baked red earthenware, is placed in another *vv* larger one of glazed porcelain or glass. The vessel *vv* is filled with a pasty amalgam of zinc, and the space between the two vessels is filled with a saturated solution of sulphate of copper. In the latter solution is immersed a thin cylinder of copper *cc*.

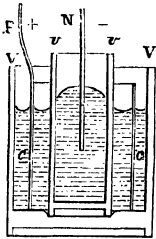

Fig. 544.

A rod or wire of copper *N* is plunged in the amalgam. The electro-motive forces of this system are directed from the amalgam to the copper solution; so that *v* proceeding from the copper cylinder is the positive, and *N* proceeding from the amalgam, is the negative pole.

The action of this system is said to be constant, like that of Daniel, so long at least as the vessel *vv* allows equally free passage to the two fluids, and the state of saturation of the copper solution is maintained.

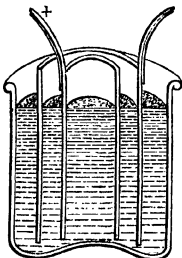

Fig. 545.

1872. *Bagration's system*.—A voltaic arrangement suggested by the Prince Bagration, and said to be well adapted to galvano-plastic purposes, consists of parallel hollow cylinders, *fig. 545*, of zinc and copper, immersed in sand contained in a porcelain vessel. The sand is kept wet by a solution of hydrochlorate of ammonia.

1873. *Becquerel's system*.—M. Becquerel has applied the principle of two

fluids and a single metal, explained in (1856) in the following manner:—

A porcelain vessel *v*, *fig. 546.*, contains concentrated nitric acid. A glass cylinder *t*, to which is attached a bottom of unglazed porcelain, is immersed in it. This cylinder contains a solution of common salt. Two plates of platinum are immersed, one in the nitric acid, and the other in the solution of salt. The electro-motive forces take effect, the conduction being maintained through the porous bottom of the glass vessel *t*, the positive pole being that which proceeds from the nitric acid, and the negative that which proceeds from the salt.

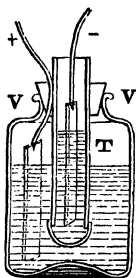

Fig. 546.

1874. *Schonbein's modification of Bunsen's battery.*—M. Schonbein proposes the following modification of Bunsen's system. In a vessel of cast-iron rendered passive, he places a mixture of three parts of concentrated nitric with one of sulphuric acid. In this he immerses the cylindrical vessel of unglazed porcelain which contains the zinc, immersed in a weak solution of sulphuric acid. In this arrangement the cast-iron vessel plays the part of Bunsen's cylinder of charcoal. The positive pole is therefore that which proceeds from the cast-iron vessel, and the negative that which is connected with the zinc.

1875. *Grove's gas electro-motive apparatus.*—We shall conclude this synopsis of the simple voltaic combinations with the gas electro-motive apparatus of Mr. Grove, one of the most curious and interesting that has been contrived. Two glass tubes *h* and *o*, *fig. 547.*, are inverted in a vessel containing water slightly acidulated with sulphuric acid. Hydrogen gas *h* is admitted into one of these, and oxygen *o* into the other in the usual way. A narrow strip of platinum passes at the top of each tube through an aperture which is hermetically closed around it, the strip descending near to the bottoms of the tubes. An electro-motive force is developed between the platinum and the gases, which is directed from the platinum to the oxygen, and from the hydrogen to the platinum. The end of

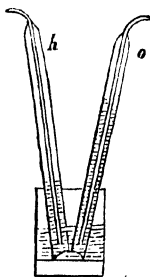

Fig. 547.

the platinum which issues from the hydrogen is therefore the positive, and that which issues from the oxygen the negative, pole of the system.

## CHAP. II.

### VOLTAIC BATTERIES.

1876. *Volta's invention of the pile.*—Whatever may be the efficacy of simple combinations of electromoters compared one with another, the electricity developed even by the most energetic among them is still incomparably more feeble than that which proceeds from other agencies, and indeed so feeble that without some expedient by which its power can be augmented in a very high ratio, it would possess very little importance as a physical agent. Volta was not slow to perceive this; but having also a clear foresight of the importance of the consequences that must result from it if its energy could be increased, he devoted all the powers of his invention to discover an expedient by which this object could be attained, and happily not without success.

He conceived the idea of uniting together in a connected and continuous series, a number of simple electro-motive combinations, in such a manner that the positive electricity developed by each should flow towards one end of the series, and the negative towards the other end. In this way he proposed to multiply the power of the extreme elements of the series by charging them with all the electricity developed by the intermediate elements.

In the first attempt to realize this conception, circular discs of silver and copper of equal magnitude (silver and copper coin served the purpose), were laid one over the other, having interposed between them equal discs of cloth or pasteboard soaked in an acid or saline solution. A pile was thus formed which was denominated a VOLTAIC PILE; and although this arrangement was speedily superseded by others found more convenient, the original name was retained.

Such arrangements are still called VOLTAIC PILES, and

sometimes VOLTAIC BATTERIES, being related to a simple voltaic combination in the same manner as a Leyden battery is to a Leyden jar.

1877. *Explanation of the principle of the pile.*—To explain the principle of the voltaic battery, let us suppose several simple voltaic combinations,  $z^1L^1C^1$ ,  $z^2L^2C^2$ ,  $z^3L^3C^3$ ,  $z^4L^4C^4$ , *fig. 548.*, to be placed, so that the negative poles  $z$  shall all

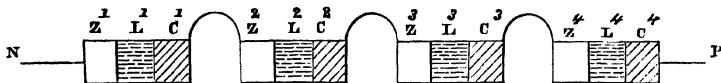

Fig. 548.

look to the left, and the positive  $c$  to the right. Let the metallic plates  $c$  be extended, and bent into an arc, so as to be placed in contact with the plates  $z$ . Let the entire series be supposed to stand upon any insulating support, and let the negative pole  $z^1$  of the first combination of the series be put in connection with the ground by a conductor.

If we express by  $\mathcal{E}$  the quantity of positive electricity developed by  $z^1L^1C^1$ , the negative fluid escaping by the conductor, this fluid  $\mathcal{E}$  will pass to  $c^1$ , and from thence along the entire series to the extremity  $c^4$ . The combination  $z^1L^1C^1$  acts in this case as the generator of electricity in the same manner as the cushion and cylinder of an electrical machine, and the remainder of the series  $z^2L^2C^2$ , &c., plays the part of the conductor, receiving the charge of fluid from  $z^1L^1C^1$ .

The second combination  $z^2L^2C^2$  being similar exactly to the first, evolves an equal quantity of electricity  $\mathcal{E}$ , the negative fluid passing through  $z^1L^1C^1$ , and the conductor to the ground. The positive fluid passes from  $z^2L^2C^2$  to the succeeding combinations to the end of the series.

In the same manner, each successive combination acts as a generator of electricity, the negative fluid escaping to the ground by the preceding combinations and the conductor, and the positive fluid being diffused over the succeeding part of the series.

It appears, therefore, that the conductor  $P$  connected with the last combination of the series must receive from each of the four combinations an equal charge  $\mathcal{E}$  of positive fluid; so that the depth or quantity of electricity upon it will be four times

that which it would receive from the single combination  $z^1L^1C^1$  acting alone and unconnected with the remainder of the series.

In general, therefore, the intensity of the electricity received by a conductor attached to the last element of the series, will be as many times greater than that which it would receive from a single combination as there are combinations in the series. If the number of combinations composing the series be  $n$ , and  $E$  be the intensity of the electricity developed by a single combination, then  $n \times E$  will be the intensity of the electricity produced at the extremity of the series.

It has been here supposed, that the extremity  $z^1$  of the series is connected by the conductor  $N$  with the ground. If it be not so connected, and if the entire series be insulated, the distribution of the fluids developed will be different. In that case, the conductor  $P$  will receive the positive fluid propagated from each of the electro-motive surfaces to the right, and the conductor  $N$  will receive the negative fluid propagated from each of these surfaces to the left, and each will receive as many times more electricity than it would receive from a single combination as there are simple combinations in the series. If, therefore,  $E'$  express the quantity of fluid which each conductor  $P$  and  $N$  would receive from a single combination  $z^1L^1C^1$ , then  $n \times E'$  will be the quantity it would receive from a series consisting of  $n$  simple combinations.

Since two different metals generally enter with a liquid into each combination, it has been usual to call these voltaic combinations PAIRS; so that a battery is said to consist of so many PAIRS.

On the Continent these combinations are called ELEMENTS; and the voltaic pile is said to consist of so many ELEMENTS, each element consisting of two metals and the interposing liquid.

1878. *Effect of the imperfect liquid conductors.*—In what precedes we have considered that all the electricity developed by each pair is propagated without resistance or diminution to the poles  $P$  and  $N$  of the pile. This, however, could only occur if the materials composing the pile through which the electricity must be transmitted were perfect conductors. Now, although the metallic parts may be regarded as practically perfect con-



ductors, the liquid through which the electricity must be transmitted in passing from one metallic element to another is not only an imperfect conductor, but one whose conducting power is subject to constant variation. A correction would therefore be necessary in applying the preceding reasoning, the electricity received by the poles P and N being less than  $n \times E'$ , by that portion which is intercepted or lost in transmission through the liquid conductors. The amount of the resistance to conduction proceeding from the conductors, liquid and metallic, by which the electricity evolved at the generating surfaces is transmitted to the poles of the pile, has not been ascertained with any clearness or certainty.

Professor Ohm, who has investigated the question of the resistance of the conductors composing a battery to the propagation of the electricity through them, maintains that the intensity of the electricity transmitted to the poles of the pile is "directly as the sum of the electro-motive forces, and inversely as the sum of all the impediments to conduction." We do not find, however, that this law has been so developed and verified by observation and experiment as to entitle it to a place in elementary instruction.

1879. *Method of developing electricity in great quantity.*—If the object be to obtain a great quantity of electricity, the elements of the pile should be combined by connecting the poles of the same name with common conductors. Thus, if all the positive poles be connected by metallic wires with one conductor, and all the negative poles with another, these conductors will be charged with as much electricity as would be produced by a single combination, of which the generating surfaces would be equal to the sum of the generating surfaces of all the elements of the series; but the intensity of the electricity thus developed would not be greater than that of the electricity developed by a single pair.

1880. *Distinction between quantity and intensity important.*—It is of great importance to distinguish between the quantity and the intensity of the electricity evolved by the pile. The quantity depends on the magnitude of the sum of all the surfaces of the electromoters. The intensity depends on the number of pairs composing the series. The quantity is measured merely by the actual quantity of each fluid received at

the poles. The intensity is proportional, *cæteris paribus*, to the number of pairs transmitting electricity to the same pole, the fluids being superposed at the poles, and the intensity being produced by such superposition.

Voltaic piles have been composed and constructed in a great variety of forms by combining together the various simple electro-motive combinations which have been described in the last chapter.

1881. *Volta's first pile*.—The first pile constructed by Volta was formed as follows:—A disc of zinc was laid upon a plate of glass. Upon it was laid an equal disc of cloth or pasteboard soaked in acidulated water. Upon this was laid an equal disc of copper. Upon the copper were laid in the same order three discs of zinc, wet cloth, and copper, and the same superposition of the same combinations of zinc, cloth, and copper was continued until the pile was completed. The highest disc (of copper) was then the positive, and the lowest disc (of zinc) the negative pole, according to the principles already explained.

It was usual to keep the discs in their places by confining them between rods of glass.

Such a pile, with conducting wires connected with its poles, is represented in *fig. 549*.

1882. *The couronne des tasses*.—The next arrangement proposed by Volta formed a step towards the form which the pile definitively assumed, and is known under the name of

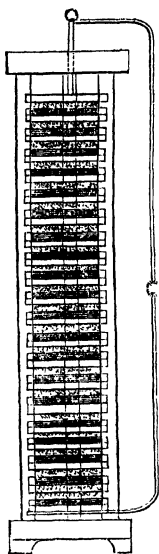

Fig. 549.

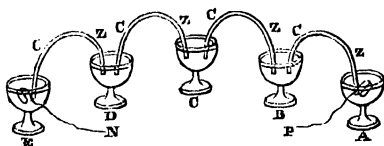

Fig. 550.

the *COURONNE DES TASSES* (*ring of cups*): this is represented in *fig. 550.*, and consists of a series of cups or glasses con-

taining the acid solution. Rods of zinc and copper  $z c$ , soldered together end to end, are bent into the form of arcs, the ends being immersed in two adjacent cups, so that the metals may succeed each other in one uniform order. A plate of zinc, to which a conducting wire  $N$  is attached, is immersed in the first; and a similar plate of copper, with a wire  $P$ , in the last cup. The latter wire will be the positive, and the former the negative, pole.

1883. *Cruikshank's arrangement.*—The next form of voltaic pile proposed was that of Cruikshank, represented in *fig. 551*. This consisted of a trough of glazed earthenware divided into parallel cells corresponding in number and magnitude to the pairs of zinc and copper plates which were attached to a bar of wood, and so connected that, when immersed in the cells, each copper plate should be in connexion with the zinc plate of the next cell. The plates were easily raised from the trough when the battery was not in use. The trough contained the acid solution.

1884. *Wollaston's arrangement.*—In order to obtain within the same volume a greater extent of electro-motive surface, Dr. Wollaston doubled the copper plate round the zinc plate, without however allowing them to touch. In this case the copper plates have twice the magnitude of the zinc plates. The system, like the former, is attached to a bar of wood, and being similarly connected, are either let down into a trough of earthenware

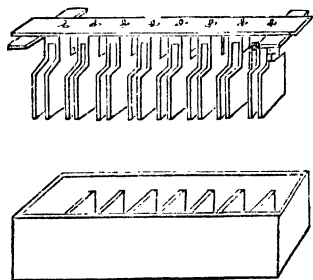

Fig. 551.

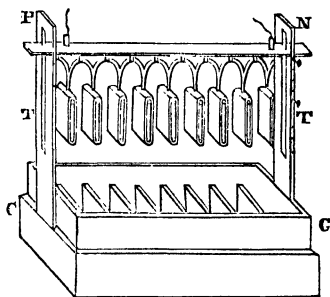

Fig. 552.

divided into cells, as represented in *fig. 552.*, or into separate glass or porcelain vessels, as represented in *fig. 553*. The latter

method has the advantage of affording greater facility for discharging and renewing the acid solution.

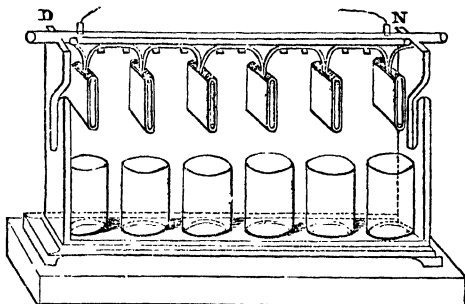
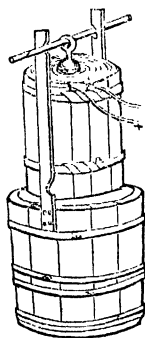
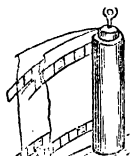

Fig. 553.

1885. *Heliacal pile of Faculty of Sciences at Paris.*— The heliacal pile is a voltaic arrangement adapted to produce electricity of low tension in great quantity. This pile, as constructed for the Faculty of Sciences at Paris under the direction of M. Pouillet, consists of a cylinder of wood *b*, *fig. 554*, of about four inches diameter and fifteen inches long, on which is rolled spirally two thin leaves of zinc and copper separated by small bits of cloth, and pieces of twine extended parallel to each other, having a thickness a little less than the cloth. A pair is formed in this manner, having a surface of sixty square feet. A single combination of this kind evolves electricity in large quantity, and a battery composed of twenty pairs is an agent of prodigious power.



The method of immersing the combination in the acid solution is represented in *fig. 555*.

1886. Piles are formed by connecting together a number of any of the simple electro-motive combinations described in the last chapter, the conditions under which they are connected being always the same, the positive pole of each combination being put in metallic connexion with the negative pole of the succeeding one.

When the combinations are cylindrical, it is convenient to set them in a framing, which will prevent the accidental fracture or strain of the connexions. A battery of ten pairs of Grove's or Bunsen's is represented with its proper connexions in *fig. 556*.

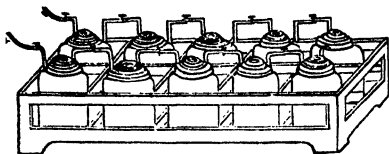

Fig. 556.

1887. *Conductors connecting the elements.*—Whatever be the form or construction of the pile, its efficient performance requires that perfect metallic contact should be made and maintained between the elements composing it by means of short and good conductors. Copper wire, or, still better, strips cut from sheet copper from half an inch to an inch in breadth, are found the most convenient material for these conductors, as well as for the conductors which carry the electricity from the poles of the pile to the objects to which it is to be conveyed. In some cases, these conducting wires or strips are soldered to metallic plates, which are immersed in the exciting liquid of the extreme elements of the pile, and which, therefore, become its poles. In some cases, small mercurial cups are soldered to the poles of the pile, in which the points of the conducting wires, being first scraped, cleaned, and amalgamated, are immersed. Many inconveniences, however, attend the use of quicksilver, and these cups have lately been very generally superseded by simple clamps constructed in a variety of forms, by means of which the conducting wires or strips may be fixed in metallic contact with the poles of the pile, with each other, or with any object to which the electricity is required to be conveyed. Where great precaution is considered necessary to secure perfect contact, the extremities of the conductors at the points of connexion are sometimes gilt by the electrotyping process, which may always be done at a trifling cost. I have

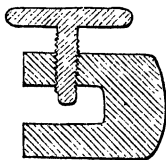

Fig. 557.

not, however, in any case found this necessary, having always obtained perfect contact by keeping the surfaces clean, and using screw clamps of the form in *fig. 557*. This is represented in its proper magnitude.

1888. *Pile may be placed at any distance from place of experiment.*—It is generally

found to be inconvenient in practice to keep the pile in the room where the experiments are made, the acid vapours being injurious in various ways, especially where nitric acid is used. It is therefore more expedient to place it in any situation where these vapours have easy means of escaping into the open air, and where metallic objects are not exposed to them. The situation of the pile may be at any desired distance from the place where the experiments are made, communication with it being maintained by strips of sheet copper as above described, which may be carried along walls or passages, contact between them being made by doubling them together at the ends which are joined, and nailing the joints to the wall. They should of course be kept out of contact with any metallic object which might divert the electric current from its course. I have myself a large pile placed in an attic connected by these means with a lower room in the house, by strips of copper which measure about fifty yards.

1839. *Memorable piles: Davy's pile at the Royal Institution.* — Among the apparatus of this class which have obtained celebrity in the history of physical science, may be mentioned the pile of 2000 pairs of plates, each having a surface of 32 square inches, at the Royal Institution, with which Davy effected the decomposition of the alkalies, and the pile of the Royal Society of nearly the same magnitude and power.

1890. *Napoleon's pile at Polytechnic School.* — In 1808, the Emperor Napoleon presented to the Polytechnic School at Paris a pile of 600 pairs of plates, having each a square foot of surface. It was with this apparatus that several of the most important researches of Gay Lussac and Thénard were conducted.

1891. *Children's great plate battery.* — Children's great plate battery consisted of 16 pairs of plates constructed by Wollaston's method, each plate measuring 6 feet in length and  $2\frac{2}{3}$  feet in width, so that the copper surface of each amounted to 32 square feet; and when the whole was connected, there was an effective surface of 512 square feet.

1892. *Hare's deflagrator.* — The pile of Dr. Hare of Philadelphia, called a deflagrator, was constructed on the heliacal principle, and consisted of 80 pairs, each zinc surface measuring 54 square inches, and each copper 80 square inches.

1893. *Stratingh's deflagrator.* — Stratingh's deflagrator con-

sisted of 100 pairs on Wollaston's method. Each zinc surface measured 200 square inches. It was used either as a battery of 100 pairs or as a single combination (1879), presenting a total electromotive surface of 277 square feet of zinc and 544 of copper.

1894. *Pepys' pile at London Institution.* — Mr. Pepys constructed an apparatus for the London Institution, each element of which consisted of a sheet of copper and one of zinc, measuring each fifty feet in length and two feet in width. These were wound round a rod of wood with horsehair between them. Each bucket contained fifty-five gallons of the exciting liquid.

1895. *Powerful batteries on Daniel and Grove's principles.* — These and all similar apparatus, powerful as they have been, and memorable as the discoveries in physics are to which several of them have been instrumental, have fallen into disuse, except in certain cases, where powerful physiological effects are to be produced; since the invention of the piles of two liquids, which, with a number of elements not exceeding forty, and a surface not exceeding 100 square inches each, evolve a power equal to the most colossal of the apparatus above described.

The most efficient voltaic apparatus are formed by combining Daniel's, Grove's, or Bunsen's single batteries, connecting their opposite poles with strips of copper as already described. Grove's battery, constructed by Jacobi of St. Petersburg, consists of 64 platinum plates, each having a surface of 36 square inches; so that their total surface amounts to 16 square feet. This is considered to be the most powerful voltaic apparatus ever constructed. According to Jacobi's estimate, its effect is equal to a Daniel's battery of 266 square feet, or to a Hare's deflagrator of 5500 square feet.

1896. *Dry piles.* — The term DRY PILE was originally intended to express a voltaic pile composed exclusively of solid elements. The advantages of such an apparatus were so apparent, that attempts at its invention were made at an early stage in the progress of electrical science. In such a pile, neither evaporation nor chemical action taking place, the elements could suffer no change; and the quantity and intensity of the electricity evolved would be absolutely uniform and invariable, and its action would be perpetual.

1897. *Deluc's pile*. — The first instrument of this class constructed was the dry pile of Deluc, subsequently improved by Zamboni. This apparatus is prepared by soaking thick writing-paper in milk, honey, or some analogous animal fluid, and attaching to its surface by gum a thin leaf of zinc or tin. The other side of the paper is coated with peroxide of manganese. Leaves of this are superposed, the sides similarly coated being all presented in the same direction, and circular discs are cut of an inch diameter by a circular cutter. Several thousands being laid over one another, are pressed into a close and compact column by a screw, and the sides of the column are then thickly coated with gum-lac.

The origin of the electromotive force of the pile is various. Besides the contact of heterogeneous substances, chemical action intervenes in several ways. The organic matter acts upon the zinc as well as upon the manganese, reducing the latter to a lower state of oxidation.

1898. *Zamboni's pile*. — Piles, having two elements only, have been constructed by Zamboni. These consist of one metal and one intermediate conductor, either dry or moist. If the former, the discs are of silver paper laid with their metal faces all looking the same way; if the latter, a number of pieces of tinfoil, with one end pointed and the other broad, are laid in two watch-glasses which contain water, in such a manner, that the pointed part lies in one glass and the broad part in the other. After some time, they develop at their poles a feeble electricity, which they retain for several days, the metal pole being positive in the dry pile, and the pointed end of the zinc in the moist one.

1899. *Piles of a single metal*. — Piles of a single metal have been constructed by causing one surface to be exposed to a chemical action different from the other. This may be effected by rendering one surface smooth and the other rough. A pile of this kind has been made with sixty or eighty plates of zinc of four square inches surface. These are fixed in a wooden trough parallel to each other, their polished faces looking the same way, and an open space of the tenth to the twentieth of an inch being left between them, these spaces being merely occupied by atmospheric air. If one extremity of this apparatus be put in communication with the ground, the other pole will sensibly affect an electroscope.



In this case, the electromotive action takes place between the air and the metal.

1900. *Ritter's secondary piles.* — The secondary piles, sometimes called RITTER'S PILES, consist of alternate layers of homogeneous metal plates, between which some moist conducting substance is interposed. When they stand alone, no electromotive force is developed; but, if they be allowed to continue for a certain time in connexion with the poles of a battery, and then disconnected, positive electricity will be found to be accumulated at that end which was connected with the positive pole, and negative electricity at the other end; and this polar condition will continue for a certain time, which will be greater the less the electrical tension imparted. This phenomenon has not been satisfactorily explained, but would seem to arise from the low conducting power of the strata of liquid interposed between the plates.

### CHAP. III.

#### VOLTAIC CURRENTS.

1901. *The voltaic current.* — The voltaic pile differs from the electrical machine inasmuch as it has the power of constantly reproducing whatever electricity may be drawn from it by conductors placed in connexion with its poles, without any manipulation, or the intervention of any agency external to the pole itself. So prompt is the action of this generating power, that the positive and negative fluids pass from the respective poles through such conductors in a continuous and unvarying stream, as a liquid would move through pipes issuing from a reservoir. The pile may indeed be regarded as a reservoir of the electric fluids, with a provision by which it constantly replenishes itself.

If two metallic wires be connected at one end with the poles  $r$  and  $n$ , *fig. 558.*, of the pile, and at the other with any conductor  $o$ , through which it is required to transmit the electricity evolved in the pile, the positive fluid will pass from  $r$

along the wire to o, and the negative fluid in like manner from n to o. The positive fluid will therefore form a stream or

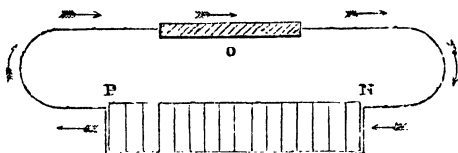

Fig. 558.

current from P through o to N, and the negative fluid a contrary current from N through o to P.

It might be expected that the combination of the two opposite fluids in equal quantity would reduce the wire to its natural state; and this would, in fact, be the case, if the fluids were in repose upon the wire, which may be proved by detaching at the same moment the ends of the wires from the poles P and N. The wires and the conductor o will, in that case, show no indication of electrical excitement. If the wire be detached only from the negative pole N, it will be found, as well as the conductor o, to be charged with positive electricity; and if it be detached from the positive pole P, they will be charged with negative electricity, the electricity in each case being in repose. But when both ends of the wire are in connexion with the poles P and N, the fluids, being in motion in contrary directions along the wire and intermediate conductors, impart to these qualities which show that they are not in the natural or unelectrified state, but which have nothing in common with the qualities which belong to bodies charged with the electric fluid in repose. Thus, the wire or conductor will neither attract nor repel pith balls, nor produce any electroscopic effects. They will, however, produce a great variety of other phenomena, which we shall presently notice.

The state of the electricities in thus passing between the poles of the piles through a metallic wire or other conductor exterior to the pile, is called a **VOLTAIC CURRENT**.

1902. *Direction of the current.* — Although, according to what has been stated, this current consists of two streams flowing in contrary directions, it receives its denomination exclusively from the positive fluid; and, accordingly, the **DIREC-**

**TION OF THE CURRENT** is always from the positive pole through the wire or other conductor to the negative pole.

It is necessary, however, to observe, that in passing through the pile itself from element to element, it moves from the negative pole to the positive pole. The direction and course of the current is indicated in *fig. 558.* by the arrows.

1903. *Poles of the pile, how distinguished.*—In designating the poles of the pile, much confusion and obscurity, and consequent difficulty to students, has arisen from identifying the poles of the pile with the extreme plates of metal composing it. In the piles first constructed by Volta, the last plate at the positive end was zinc, and the last at the negative end copper; and such an arrangement was often retained at more recent periods. Hence the positive pole was called the *zinc pole*, and the negative pole the *copper pole*. The extreme plates being afterwards dispensed with, the final plate at the positive end became copper, and that at the negative end zinc; and, consequently, the positive pole was then the copper pole, and the negative pole the zinc pole.

This confusion, however, may be avoided, by observing that the poles, positive or negative, are not dependent on the plates or cylinders of metal with which the pole may terminate, but on the direction of the electromotive forces of its elements. In general, in a pile composed of zinc and copper elements, the zinc plates of each pair all *look towards* the positive pole, and the copper plates towards the negative pole. It must, however, be observed, that, in the ordinary arrangement, one element of a pair is placed at each extremity of the pile, and constitutes its pole, the pair being only completed when the poles are united by the conducting wire. Thus, the pole to which the copper elements look, terminates in a zinc plate in contact with the exciting liquid, but not with the adjacent copper plate; and the pole to which the zinc plates look terminates in like manner with a copper plate in contact with the exciting liquid, but not with the adjacent zinc plate. The single extreme plates of zinc and copper thus forming the poles of the pile being connected by the conducting wire, form, in fact, a pair through which the current passes exactly as it passes through any other pair in the series.

1904. *Voltaic circuit.*—When the poles are thus connected by the conducting wire, the **VOLTAIC CIRCUIT** is said to be

complete, and the current continually flows, as well through the pile as through the conducting wire. In this state the pile constantly evolves electricity at its electromotive surfaces, to feed and sustain the current; but if the voltaic circuit be not completed by establishing a continuous conductor between pole and pole, then the electricity *will not be in motion*, no current will flow; but the wire or other conductor which is in connexion with the positive pole will be charged with positive, and that in connexion with the negative pole will be charged with negative electricity, of a certain feeble tension, and in a state of repose. Since, in such case, the electricity with which the pile is charged has no other escape than by the contact of the surrounding atmosphere, the electromotive force is in very feeble operation, having only to make good that quantity which is dissipated by the air. The moment, however, the voltaic circuit is completed, the pile enters into active operation, and generates the fluid necessary to sustain the current.

These are points which it is most necessary that the student should thoroughly study and comprehend; otherwise, he will find himself involved in great obscurity and perplexity as he attempts to proceed.

1905. *Case in which the earth completes the circuit.*—If the conducting wires connected with the poles P and N, instead of being connected with the conductor o, *fig. 558.*, be connected with the ground, the *earth itself* will take the place and play the part of the conductor o in relation to the current. The positive fluid will in that case flow by the wire P E, *fig. 559.*, and the

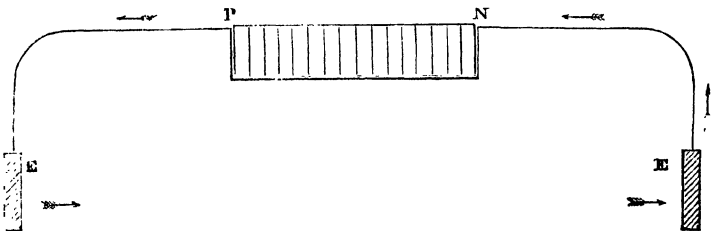

Fig. 559.

negative fluid by the wire N E to the earth E; and the two fluids will be transmitted through the earth E E in contrary directions,

exactly in the same manner as through the conductor *o*. In this case, therefore, the voltaic circuit is completed by the *earth itself*.

1906. *Methods of connecting the poles with the earth*.—In all cases, in completing the circuit, it is necessary to ensure perfect contact wherever two different conductors are united. We have already explained the application of mercurial cups and metallic clamps for this purpose, where the conductors to be connected are wires or strips of metal. When the earth is used to complete the circuit, these are inapplicable. To ensure the unobstructed flow of the current in this case, the wire is soldered to a large plate of metal, having a surface of several square feet, which is buried in the moist ground, or, still better, immersed in a well or other reservoir of water.

In cities, where there are extensive systems of metallic pipes buried for the conveyance of water or gas, the wires proceeding from the poles *P* and *N* may be connected with these.

There is no practical limit to the distance over which a voltaic current may in this manner be carried, the circuit being still completed by the earth. Thus, if while the pile *P N*, *fig.* 559., is at London, the wire *P E* is carried to Paris or Vienna (being insulated throughout its entire course), and is put in communication with the ground at the latter place, the current will return to London through the earth *E E* as surely and as promptly as if the points *E E* were only a foot asunder.

1907. *Various denomination of currents*.—Voltaic currents which pass along wires are variously designated, according to the form given to the conducting wire. Thus they are RECTILINEAR CURRENTS when the wire is straight; INDEFINITE CURRENTS when it is unlimited in length; CLOSED CURRENTS when the wire is bent so as to surround or inclose a space; CIRCULAR OR SPIRAL CURRENTS when the wire has these forms.

1908. *The electric fluid forming the current not necessarily in motion*.—Although the nomenclature which has been adopted to express these phenomena implies that the electric fluid has a motion of translation along the conductor similar to the motion of liquid in a pipe, it must not be understood that the existence of such motion of the electric fluid is necessarily assumed, or that its non-existence, if proved, could disturb the reasoning

or shake the conclusions which form the basis of this branch of physics. Whether an actual motion of translation of the electric fluid along the conductor exist or not, it is certain that the *effect* which would attend such a motion is propagated along the conductor; and this is all that is essential to the reasoning. It has been already stated, that the most probable hypothesis which has been advanced for the explanation of the phenomena rejects the motion of translation, and supposes the effect to be produced by a series of decompositions and recompositions of the natural electricity of the conductor (1826).

1909. *Method of coating the conducting wires.*—When the wires by which the current is conducted are liable to touch other conductors, by which the electricity may be diverted from its course, they require to be coated with some non-conducting substance, under and protected by which the current passes. Wires wrapped with silk or linen thread may be used in such cases, and they will be rendered still more efficient if they are coated with a varnish of gum-lac.

When the wires are immersed in water, they may be protected by enclosing them in caoutchouc or gutta percha.

If they are carried through the air, it is not necessary to surround them with any coating, the tension of the voltaic electricity being so feeble, that the pressure of the air and its non-conducting quality are sufficient for its insulation.

1910. *Supports of conducting wire.*—When the wire is carried through the air to such distances as would render its weight too great for its strength, it requires to be supported at convenient intervals upon insulating props. Rollers of porcelain or glass, attached to posts of wood, are used for this purpose in the case of telegraphic wires.

1911. *Ampère's reotrope to reverse the current.*—In experimental inquiries respecting the effects of currents, it is frequently necessary to reverse the direction of a current, and sometimes to do so suddenly, and many times in rapid succession. An apparatus for accomplishing this, contrived by Ampère, and which has since undergone various modifications, has been denominated a *commutator*, but may be more appropriately named a *REOTROPE*, the Greek words *ρέος* (*reos*) signifying a current, and *τρόπος* (*tropos*), a turn.

Let two grooves *rr*, *fig.* 560., about half an inch in width

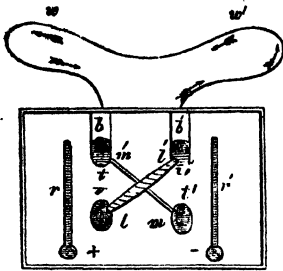

Fig. 560.

ties, be masticated on their surfaces with resin, so as to render them non-conductors.

These grooves and cavities being filled with mercury, let the apparatus represented in *fig.* 561. be placed upon the board. A horizontal axis *aa'* moves in two holes *oo'* made in the upright pieces *pp'*. It carries four rectangular pieces of metal *c, c', d, d'*, so adapted, that when they are pressed downwards one leg of each will dip into the mercury in the groove, and the other into the adjacent cavity. The arms uniting the rectangular metallic

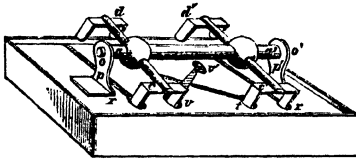

Fig. 561.

pieces are of varnished wood, and are therefore non-conductors. When this apparatus is in the position represented in the figure, it will connect the groove *r* with the cavity *v*, and the groove *r'* with the cavity *t*. When the ends *dd'* are depressed, and therefore *cc'* elevated, it will connect the groove *r* with the cavity *t'*, and the groove *r'* with the cavity *t*.

The conductor which proceeds from the positive pole of the pile is immersed in the mercury in *r*, and that which comes from the negative pole is immersed in the mercury in *r'*. Two strips of copper *bb'* connect the mercury in the cavities *t'* and *v'*, with the wire *ww'* which carries the current.

The apparatus being arranged as represented in *fig.* 560., the current will pass from the pile to the mercury in *r*; thence to *v* by the conductor *c*; thence to *v'* by the diagonal strip of metal *ll*; thence to *w* by the metal *b'*, and will pass along the

and depth, be cut in a board, and between them let four small cavities *v, t, v', t'* be formed. Let these cavities be connected diagonally in pairs by strips of copper *ll* and *mm'*, having at the place where they cross each other a piece of cloth or other non-conducting substance between them, so as to prevent the electricity from passing from one to the other. Let the grooves *r* and *r'*, and the four cavities, be masticated on their surfaces with resin, so as to render them non-conductors.

These grooves and cavities being filled with mercury, let the apparatus represented in *fig.* 561. be placed upon the board. A horizontal axis *aa'* moves in two holes *oo'* made in the upright pieces *pp'*. It carries four rectangular pieces of metal *c, c', d, d'*, so adapted, that when they are pressed downwards one leg of each will dip into the mercury in the groove, and the other into the adjacent cavity. The arms uniting the rectangular metallic

pieces are of varnished wood, and are therefore non-conductors. When this apparatus is in the position represented in the figure, it will connect the groove *r* with the cavity *v*, and the groove *r'* with the cavity *t*. When the ends *dd'* are depressed, and therefore *cc'* elevated, it will connect the groove *r* with the cavity *t'*, and the groove *r'* with the cavity *t*.

The conductor which proceeds from the positive pole of the pile is immersed in the mercury in *r*, and that which comes from the negative pole is immersed in the mercury in *r'*. Two strips of copper *bb'* connect the mercury in the cavities *t'* and *v'*, with the wire *ww'* which carries the current.

The apparatus being arranged as represented in *fig.* 560., the current will pass from the pile to the mercury in *r*; thence to *v* by the conductor *c*; thence to *v'* by the diagonal strip of metal *ll*; thence to *w* by the metal *b'*, and will pass along the





cessity often arising of indicating a sort of secondary pole, more or less remote from the pile by which the current enters and leaves certain conductors, Dr. Faraday has proposed the use of the term **ELECTRODES** to express these. Thus in the reotrope of Ampère, the electrodes would be the mercury in the grooves  $r' r'$ , *fig. 560*. In the reotrope of Pohl, the electrodes would be the ends of the horizontal axis **P** and **M**.

This term electrode has reference, however, more especially to the chemical properties of the current, as will appear hereafter.

1914. *Floating supports for conducting wire.*— It happens frequently in experimental researches respecting the effects of forces affecting voltaic currents or developed by them, that the wire upon which the current passes requires to be supported or suspended in such a manner as to be capable of changing its position or direction in accordance with the action of such forces. This object is sometimes attained by attaching the wire, together with a small vessel containing zinc and copper plates immersed in dilute acid, to a cork float, and placing the whole apparatus on water or other liquid, on which it will be capable of floating and assuming any position or direction which the forces acting upon it may have a tendency to give to it.

1915. *Ampère's apparatus for supporting movable currents.*— A more convenient and generally useful apparatus for this purpose, however, is that contrived by Ampère; which consists of two vertical copper rods  $v v'$ , *fig. 564*, fixed in a wooden stage  $\tau \tau'$ , the upper parts being bent at right angles and terminated in two mercurial cups  $y y'$ , one below the other in the same vertical line. The horizontal parts are rolled with silk or coated with gum-lac, to prevent the electricity passing from

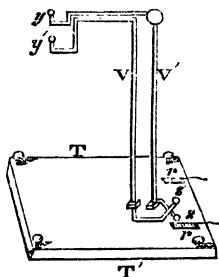

Fig. 564.

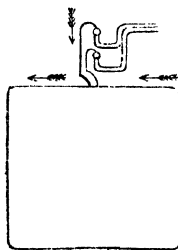

Fig. 565.

one to the other. Two small cavities  $rr'$  filled with mercury, being connected with the poles of a battery, become the electrodes of the apparatus. These may be connected at pleasure with two mercurial cups  $ss'$ , which are in metallic communication with the rods  $v v'$ . The reotrope may be applied to this apparatus, so as to reverse the connexions when required.

The wire which conducts the current is so formed at its extremities as to rest on two points in the cups  $yy'$ , and to balance itself so as to be capable of revolving freely round the vertical line passing through  $yy'$  as an axis.

A wire thus arranged is represented in *fig. 565.*, having its ends resting in the cups  $yy'$ , the current passing from the cup  $y'$  through the wire, and returning to the cup  $y$ . If the reotrope be reversed, it will pass from  $y$  through the wire and return to  $y'$ .

## CHAP. IV.

### RECIPROCAL INFLUENCE OF RECTILINEAR CURRENTS AND MAGNETS.

1916. *Mutual action of magnets and currents.* — When a voltaic current is placed near a magnetic needle, certain motions are imparted to the needle or to the conductor of the current, or to both, which indicate the action of forces exerted by the current on the poles of the needle, and reciprocally by the poles of the needle on the current. Other experimental tests show that the magnets and currents affect each other in various ways; that the presence of a current increases or diminishes the magnetic intensity, imparts or effaces magnetic polarity, produces temporary magnetism where the coercive force is feeble or evanescent, or permanent polarity where it is strong; that magnets reciprocally affect the intensity and direction of currents, and produce or arrest them.

1917. *Electro-magnetism.* — The body of these and like phenomena, and the exposition of the laws which govern them, constitute that branch of electrical science which has been denominated ELECTRO-MAGNETISM.

To render clearly intelligible the effects of the mutual action of a voltaic current and a magnet, it will be necessary to consider separately the forces exerted between the current and each of the magnetic poles; for the motions which ensue, and the forces actually manifested, are the resultants of the separate actions of the two poles.

1918. *Direction of the mutual forces exerted by a rectilinear current and the pole of a magnet.*—To simplify the explanation, we shall, in the first instance, consider only the case of rectilinear currents.

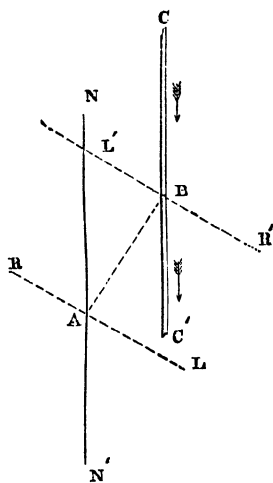

Fig. 566.

Let  $cc'$ , *fig. 566.*, represent the wire along which a voltaic current passes, directed from  $c$  to  $c'$ , as indicated by the arrows. Let  $nn'$  be a straight line which is parallel to the current  $cc'$ , and which passes through the magnetic pole. We shall call this the line of direction of the magnetic pole. Let a plane be imagined to pass through these lines  $cc'$  and  $nn'$ , and let a line  $ab$  be drawn in this plane at right angles to  $cc'$  and  $nn'$ .

The force exerted by the current upon the magnetic pole, and reciprocally the force exerted by the magnetic pole upon the current, will have a direction at right angles to the plane passing through the direction  $cc'$  of the current, and

the line of direction  $nn'$  of the magnetic pole.

Thus the line of direction  $nn'$  will be impelled by a force in the direction of the line  $lr$ , and the current  $cc'$  by a force in the direction of the line  $l'r'$ ; these lines  $lr$  and  $l'r'$  being understood to be drawn at right angles to the plane passing through  $cc'$  and  $nn'$ .

But it is necessary to show in which direction on the lines  $lr$  and  $l'r'$  these forces respectively act.

This direction will depend on and vary with the *name* of the magnetic pole and the *direction* of the current on the line  $cc'$ .

If we suppose the magnetic pole to be an *austral* or *north* pole, and the current to *descend* on the line  $c c'$ , as indicated by the arrows, let an observer be imagined to stand with his person in the direction  $c c'$  of the current, looking towards  $N N'$ , and the current consequently passing from his head to his feet. In such case the direction of the force impressed by the current on the line  $N N'$  will be directed to the *right* of such observer, that is, from A towards R.

If the observer stand in the direction of the line of direction  $N N'$  of the magnetic pole, looking towards the current  $c c'$ , the force impressed by the magnetic pole upon the current will, as before, be directed to his *right*, that is, from B towards R'.

If the magnetic pole of which  $N N'$  is the line of direction be a boreal or south pole, these directions will be reversed, each line  $N N'$  and  $c c'$  being impelled to the *left* of the observer, who looks from the other line. Thus, in such case,  $N N'$  will be impelled by a force directed from A towards L, and  $c c'$  by a force directed from B towards L'.

If the current ascend on the line  $c c'$ , the directions of the forces will be the reverse of those produced by a descending current. Thus, when the current ascends, the line  $N N'$  will be impelled to the *left* of the observer at  $c c'$  if the pole be *austral* or *north*, and to his *right* if it be boreal or south; and in the same case the current  $c c'$  will be likewise impelled to the *left* of the observer at  $N N'$  if the pole be *austral* or *north*, and to his *right* if it be *boreal* or *south*.

To impress the memory with these various effects, it will be sufficient to retain the directions of the forces produced between a descending current and a north magnetic pole. The directions will be the same for an ascending current and a south magnetic pole; they will be reversed for a descending current and south pole, or for an ascending current and north pole.

Thus if the lines of direction of the current and the pole be supposed to be both perpendicular to the surface of this paper, and that the line of direction of the pole pass through the paper at P, and that of the current at C, the directions of the forces impressed on the lines of direction of the current and the pole for a descending current and north magnetic pole, or an ascending current and a south magnetic pole, are indicated by the arrows in *fig. 567.*, and their directions for a descending

current and south magnetic pole, or an ascending current and a north magnetic pole, are indicated in *fig. 568*.



Fig. 567.

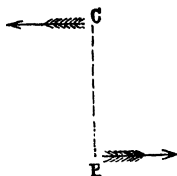

Fig. 568.

For example, if a current descend on a vertical wire, and the austral or north pole of a magnet be placed so that its line of direction shall be to the north of the current, the wire of the current will be impelled by a force directed to the *west*, and the line of direction of the magnetic pole by a force directed to the *east*.

If the current ascend, or if the pole be a south pole, the wire of the current will be impelled to the *east*, and the line of direction of the pole to the *west*.

1919. *Circular motion of magnetic pole round a fixed current.*—If the line of direction of the current be fixed, and that of the magnetic pole be movable, but so connected with the line of the current as to remain always at the same distance from it, the line of direction of the pole will be capable only of moving round the surface of a cylinder whose axis is the direction of the current. In this case the force impressed by the current on the line of direction of the pole, being always at right angles to that line, and always on the same side of it as viewed from the current, will impart to the line of direction of the pole a motion of continued rotation round the current as an axis. This rotation, as viewed on the side from which the current flows, will be in the same direction as the motion of the hand of a watch, where the pole is north, as represented in *fig. 569.*, and in the contrary direction as represented in *fig. 570.*, where the pole is south.

1920. *Circular motion of a current round a magnetic pole.*—A similar motion of continued rotation will be imparted to the wire conducting the current if the line of direction of the magnetic pole be fixed, and the wire be similarly connected with it. In this case the motion imparted by a north pole on

a descending current is represented in *fig. 569.*, and that impressed by a south pole in *fig. 570.*

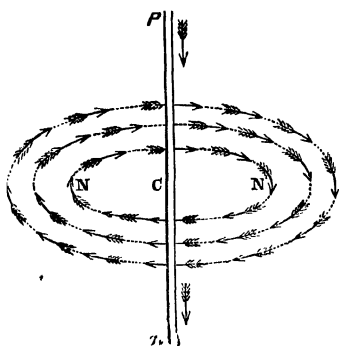

Fig. 569.

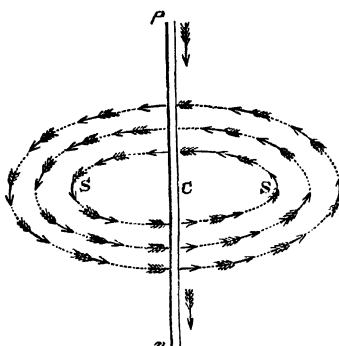

Fig. 570.

1921. *Apparatus to illustrate experimentally these effects.*—A great variety of apparatus and experimental expedients has been contrived to illustrate and verify these laws.

1922. *Apparatus to exhibit the direction of the force impressed by a rectilinear current on a magnetic pole.*—To demonstrate the direction of the force impressed by a rectilinear

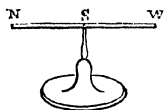

Fig. 571.

current on a magnetic pole, let a light bar, *fig. 571.*, of ivory, or any other substance not susceptible of magnetism, made flat at the upper surface, be balanced like a compass needle on a fine point, so as to be free to move round it in an horizontal plane. Let a magnetic needle, *ns*, be placed upon one arm of it, so that one of the poles, the boreal *s* for example, be exactly over the point of support; and let a counterpoise, *w*, be placed upon the other arm. Let the magnet be rendered astatic, so as not to be affected by the earth's magnetism by any of the methods already explained (1695).

Let the needle thus suspended be supposed to play round *s*, *fig. 572.*, in the plane of the paper, and let a voltaic current pass downwards along a wire perpendicular to the paper, *c* representing the intersection of such wire with the paper. The needle, after some oscillations, will come to rest in the position

s N, so that its direction shall be at right angles to the line CN, drawn from the current to the pole N, and so that the centre s shall be to the left of N as viewed from c.

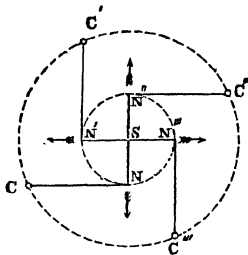

Fig. 572.

It follows, from what has been already explained, that the force exerted by the current c on the pole N has the direction indicated by the arrow from s to N. This force is therefore directed to the *right* of N as viewed from c.

If the wire carrying the current be moved round the circle c' c'' c''', the pole N will follow it, assuming always such positions, N', N'', N''', that sN', sN'', sN''' shall be at right angles to c'N', c''N'', c'''N'''. It follows, therefore, that whatever position may be given to the current, it will exert a force upon the austral or north pole N of the magnet, the direction of which will be at right angles to the line drawn from the current to the pole, and to the *right* of the pole as viewed from the current.

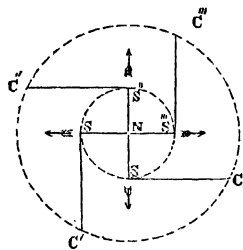

Fig. 573.

If the position of the needle be reversed, the pole N being placed at the centre of motion, the same phenomena will be manifested, but in this case the needle will place itself to the *right* of the pole s as viewed from the current c, as represented in *fig. 573*. It follows therefore, in this case, that whatever position be given to the current, it will exert a force upon the boreal or south pole of the magnet, the direction of which will be at right angles to the line drawn from the current to the pole, and to the *left* of the pole as viewed from the current.

The current has here been supposed to *descend* along the wire. If it ascend the effects will be reversed. It will exert a force on the austral pole directed to the *left*, and on the boreal pole one directed to the *right*.

1923. *Apparatus to measure intensity of this force.*—Having indicated the conditions which determine the *directions* of the

forces reciprocally exerted between magnetic poles and a current, it is necessary to explain those which affect their *intensity*.

Let *sN*, *fig. 574.*, be an astatic needle affected by the current

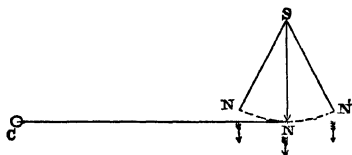

*Fig. 574.*

*c*, whose direction is perpendicular to the paper, as already explained. If *N* be displaced it will oscillate on the one side and the other of its position of rest, and its oscillations will be governed

by the laws already explained in the case of the pendulum (256). The intensity of the force impressed on it in the direction of the arrows by the current *c*, will be proportional to the squares of the number of vibrations per minute.

1924. *Intensity varies inversely as the distance.*—If the distance of *c* from *N* be varied, it will be found that the square of the number of vibrations per minute will increase in the same proportion as the distance *cN* is diminished, and *vice versa*. It follows, therefore, that the force impressed by the current on the pole is increased in the same ratio as the distance of the current from the pole diminishes, and *vice versa*.

In the case here contemplated, the length of the wire carrying the current being considerable, each part of it exercises a separate force on *N*, and the entire force exerted is consequently the resultant of an infinite number of forces, just as the weight of a body is the resultant of the forces separately impressed by gravity on its component molecules. LAPLACE has shown that the indefinitely small parts into which the current may be supposed to be divided, exert forces which are to each other in the inverse ratio of the squares of their distances from the pole, and that by the composition of these a resultant is produced, which varies in the inverse proportion of the distances as indicated by observation.

From what has been stated, it is evident that if the current

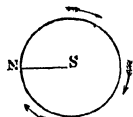

*Fig. 575.*

*fig. 575.* be placed at the centre *s* of the circle round which the north pole of a magnet is free to move, it will impart to the pole a continuous motion of rotation in that circle. If the current be supposed to move downwards, the pole *N* will be constantly driven to the right as viewed from



the centre *s* (1918), and consequently the magnet will move in the direction of the hand of a watch, as indicated by the arrows.

If the north pole *N* be placed at the centre, as in *fig. 576.*, the current still descending, the force exerted on the south pole *s* will be constantly directed to the left as viewed from the centre, and the magnet will accordingly move contrary to the hand of a watch, as indicated by the arrows.

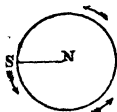

Fig. 576.

If the current ascend, these motions will be reversed, the north pole moving contrary, and the south according to the hand of a watch, as indicated in *figs. 577., 578.*

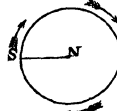

Fig. 577.

*Descending current acting on north pole (fig. 575.).*

*Descending current acting on south pole (fig. 576.).*

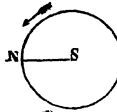

Fig. 578.

*Ascending current acting on south pole (fig. 577.).*

*Ascending current acting on north pole (fig. 578.).*

1925. *Case in which the current is within, but not at the centre of the circle in which the pole revolves.*—If the current be within the circle described by the free pole, but not at its centre, the pole will still revolve; but the force which impels it will not be uniform, as it is when the current is at the centre. Since the force exerted by the current on the pole is inversely as its distance from the pole, that force will be necessarily uniform when the current is at the centre, the distance of the pole from it being always the same. But when the current is within the circle at a point *c*, *fig. 579.*, different from the centre,



Fig. 579.

the distance *CN* will vary, and the force exerted on *N* will vary in the inverse proportion, increasing as the distance is diminished, and decreasing as the distance is increased. The rotation will nevertheless equally take place, and in the same direction as when the current *c* is at the centre.

1926. *Action of a current on a magnet, both poles being free.*—Having thus explained the mutual action of the current, and

each pole of the needle separately, we shall now consider the case in which a magnetic needle suspended as usual on its centre is exposed to the action of the current.

1927. *Case in which the current is outside the circle described by the poles.*—Let *c*, *figs.* 580, 581., as before, be a descending current placed outside the circle in which the poles of the needle *ns* play. The forces exerted by the current on the two poles *n* and *s* have in this case opposite effects on the needle, and consequently it will turn in the direction of that which has the greater effect, and will be in equilibrium when the effects are equal.

If the poles be placed at *n'* and *s'*, *fig.* 580., the force exerted on them will move *n'* towards *n*, and *s'* towards *s*, and the needle will turn in the direction of the arrows by the combined effects of both forces. When *n'* arrives at *n''*, the force being in the direction *on''* will be ineffective; but the force acting on *s''*, the opposite pole, will continue to turn the needle towards the position *ns*, where it is at right angles to *co*. After passing *n''*, the force on *n* is effective in opposition to that on *s*, but in a very small degree, so that the effect on *s* preponderates until the needle arrives at the position *sn*. Here, the poles *n* and *s* being equally distant from *c*, the forces are equal,

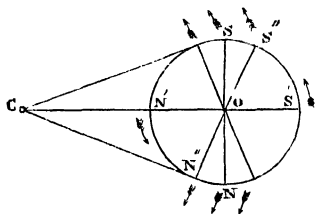

Fig. 580.

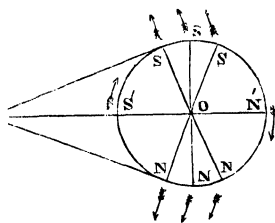

Fig. 581.

and being equally inclined to *sn*, have equal effects in opposite directions. The needle is therefore held in equilibrium. If the needle be moved beyond this position, the effect of the force on *n* predominating over that of the force on *s*, the needle will be brought back to the position *sn*, and will oscillate on the one side and the other of this direction, showing that it is the position of stable equilibrium (299).

If the pole *s* be placed at *s'*, *fig.* 581., the effects on the two

poles  $s'$  and  $n'$  will, as before, combine to turn the needle as indicated by the arrows, moving the south pole towards  $s$ , and the north towards  $n$ .

It follows, therefore, that a downward current  $c$  acting as in *figs. 580, 581.* outside the circle described by the poles, will throw the needle into a direction  $sn$  at right angles to the line  $co$  drawn from the current to the centre of the needle, the north pole being on the *right* as viewed from the current.

An ascending current will produce the contrary effects, the north pole being thrown to the *left* as viewed from the current.

1928. *Case in which the current passes through the circle.*—

If the current pass through the circle described by the poles, the needle will rest indifferently in any direction that may be given to it. In this case, *fig. 582.*, let  $c$  be the current. The

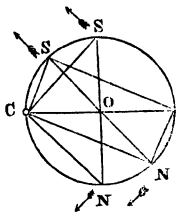

Fig. 582.

forces it exerts on  $s$  and  $n$  being in the inverse ratio of the distances, that which affects  $s$  will be to that which affects  $n$  as  $cn$  is to  $cs$ . The moment of the force on  $s$  will therefore be  $cn \times cs$ , and the moment of the force on  $n$  will be  $cs \times cn$ . These moments being equal, the forces must be in equilibrium (426), and the needle will therefore remain at rest whatever position be given to it.

1929. *Case in which the current passes within the circle.*—Let the current pass within the circle described by the poles. In this case the effects of the current on the two poles  $s$  and  $n$  is opposite in every position. If the pole be

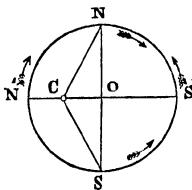

Fig. 583.

at  $n'$ , *fig. 583.*, the point of the circle nearest to  $c$ , the force on  $n'$  being greater than the force on  $s'$  in the ratio of  $cs'$  to  $cn'$  (1923), the effect of the force on  $n'$  will predominate, and  $n'$  will be moved towards  $n$ , and  $s'$  towards  $s$ . The effects on  $n$  will continue to predominate until they arrive at the position  $ns$ , where the effects become equal and the needle is in equilibrium; for here

the distances of  $s$  and  $n$  from  $c$  being equal, the forces are equal; and since they are equally inclined to the needle, they have equal effects to turn it in contrary directions. After passing  $n$ , the effect on  $s$  predominates; the needle will be brought back

to the position NS, and will oscillate on the one side and the other, indicating stable equilibrium (299).

If the needle be placed with the pole  $s'$  at the point nearest to  $C$ , *fig. 584.*, the effect on  $s'$  predominating,  $s'$  will be moved towards  $s$ , and  $N'$  towards  $N$ , and the needle will attain the same position as in the former case.

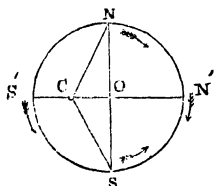

Fig. 584.

It follows, therefore, that when a descending current passes within the circle described by the poles, as represented in *figs. 583, 584.*, the needle will be thrown

into a direction  $SN$  at right angles to the line  $CO$  drawn from the current to the centre of the needle, the north pole pointing to the *left* as viewed from the current.

An ascending current will produce the contrary effect, throwing the north pole to the right.

It will be observed that the direction of the poles, when the current is *within* the circle, is opposite to its direction when it is outside the circle.

1930. *Apparatus to illustrate electro-magnetic rotation.*— A variety of interesting and instructive apparatus has been contrived to illustrate experimentally the reciprocal forces manifested between currents and magnets. These may be described generally as exhibiting a magnet revolving round a current, or a current revolving round a magnet, or each revolving round the other, impelled by the forces which the current and the poles of the magnet exert upon each other. It will be conducive to brevity in describing these effects to designate a motion of rotation which is from left to right, or according to that of the hand of a watch, as *direct rotation*, and the contrary as *retrograde rotation*. It will therefore follow from what has been explained, that if  $N$  and  $s$  express the north and south poles of the magnet, and  $A$  and  $D$  express an ascending and descending current, the rotation of each round the other in every possible case will be as follows :

	· <i>Direct.</i>
$s,$	
$N, A$	}
$s, D$	
	<i>Retrograde.</i>

We shall classify the apparatus according to the particular manner in which they exhibit the action of the forces.

1931. *To cause either pole of a magnet to revolve round a fixed voltaic current.*—Let two bar magnets be bent into the

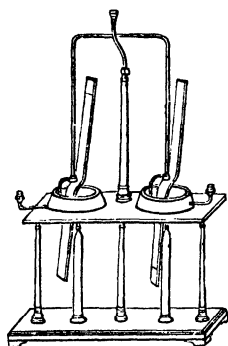

Fig. 585.

form shown in *fig. 585.*, so that a small part at the middle of their length shall be horizontal. Under this part an agate cap is fixed, by which the magnet is supported on a pivot. Above the horizontal part a small cup containing mercury is fixed. The magnets are thus free to revolve on the pivots. A small circular canal of mercury surrounds each magnet a little below the rectangular bend, into which the amalgamated point of a bent wire dips. These wires are connected with two vertical rods, which, turning at right angles above, terminate in a small cup

containing mercury. Two similar mercurial cups communicate with the circular mercurial canals. If the upper cup be put in communication with the positive pole of a battery, and the lower cups with the negative pole, descending currents will be established on the vertical rods; and if the upper cup be put in communication with the negative, and the lower with the positive, the currents will ascend. The two magnets may be placed either with the same or opposite poles uppermost. The currents pass from the vertical rods to the mercury in the circular canals, thence to the lower cups, and thence to the negative poles.

When the descending current passes on the rods, the north pole of the magnet revolves with direct, and the south pole with retrograde motion. When the current ascends, these motions are reversed.



Fig. 586.

1932. *To cause a moveable current to revolve round the fixed pole of a magnet.*—Let a glass vessel, *fig. 586.*, be nearly filled with mercury. Let a metallic wire suspended from a hook over its centre be capable of revolving while its end rests upon the surface of the mercury. A rod of metal enters at the bottom of the vessel, and is in contact with a magnetic bar fixed vertically in the centre of the vessel. When one of the poles of the

battery is put in communication with the moveable wire, and the other with the fixed wire connected with the magnet, a current will pass along the moveable wire, either *to* the mercury or *from* it, according to the connexion made with the poles of the battery; and the moveable wire will revolve round the magnet, touching the surface of the mercury with a motion direct or retrograde, according as the current descends or ascends, and according to the name of the magnetic pole fixed in the centre (1930).

Let  $z z'$ , *fig. 587.*, represent a section of a circular trough containing mercury, having an opening at the centre, in which is inserted a metallic rod, terminating at the top in a mercurial cup  $c$ . A wire at  $ab b' a'$  is bent so as to form three sides of a rectangle, the width  $b b'$  corresponding with the diameter of the circular trough  $z z'$ . A point is attached to the middle of  $b b'$ , which rests in the cup  $c$ , so that the rectangle is balanced on the rod  $t$ , and capable of revolving on the pivot as a centre.

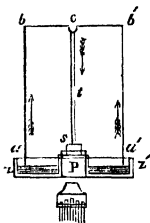

Fig. 587.

If the mercury in the circular trough be connected by a wire with the negative, while the cup  $c$  is connected with the positive pole of a battery, descending currents will be established along the vertical wires  $ba$  and  $b'a'$ ; and if the connexions be reversed, these currents will ascend.

If, when these currents are established, the pole of a magnet be applied under the centre  $p$ , it will act upon the vertical currents, and will cause the rectangular wire at  $ab b' a'$  to revolve round  $c$ , with a motion direct or retrograde, according to the direction of the current and the name of the magnetic pole (1920).

The points of contact of the revolving wires with the mercury may be multiplied by attaching the ends  $aa'$  of the wires to a metallic hoop, the edge of which will rest in contact with the metal; or the wires  $ab$  and  $a'b'$  may be altogether replaced by a thin copper cylinder balanced on a point in the cup at  $c$ .

Another apparatus for illustrating this is represented in *fig. 588.* A bar magnet is fixed vertically in the centre of a circular trough containing mercury. A light and hollow cy-

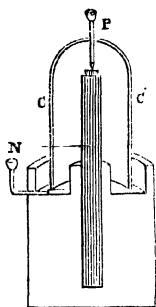

Fig. 588.

linder of copper is suspended on a point resting in an agate cup placed on the top of the magnet, and having a vertical wire proceeding from it, which terminates in a small mercurial cup P at the top. Another wire connects the mercury in the trough with a mercurial cup N. When the cups P and N are put in communication with the poles of the battery, a current is established on the sides of the copper cylinder C C, and rotation takes place as already described.

A double apparatus of this kind, erected on the two poles of a horse-shoe magnet, is represented in *fig. 589*.

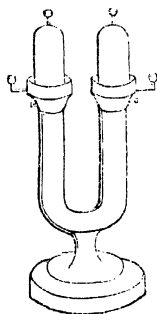

Fig. 589.

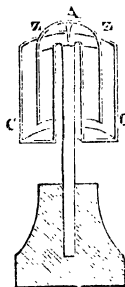

Fig. 590.

1933. *Ampère's method*.— Ampère adopted the following method of exhibiting the revolution of a current round a magnet. A double cylinder of copper, C C, *fig. 590.*, about  $2\frac{1}{2}$  in. diameter and  $2\frac{1}{2}$  in. high, is supported on the pole of a bar magnet by a plate of metal passing across the upper orifice of the inner cylinder. A light cylinder of zinc Z Z, supported on a wire arch A, is introduced between the inner and outer cylinders of copper, a steel point attached to the wire arch resting upon the plate by which the copper cylinders are supported. On introducing dilute acid between the copper cylinders, electromotive action takes place, the current passing from the zinc to the acid, thence to the copper, and thence

through the pivot to the zinc. The zinc being in this case free to revolve, while the copper is fixed, and the current descending on the former, the rotation will be direct or retrograde according as the magnetic pole is north or south.

If the copper were free to revolve as well as the zinc, it would turn in the contrary direction, since the current ascends upon it, while it descends on the zinc. Mr. J. Marsh modified Ampère's apparatus, so as to produce this effect by substituting a pivot, resting in a cup at the top of the magnet, for the metallic arch by which, in the former case, the copper vessel was sustained.

A double arrangement of this kind is given in *fig. 591.*, where the double cylinders are supported on pivots on the two poles of a horse-shoe magnet. The rotation of the corresponding cylinders on the two opposite magnetic poles will be in contrary directions.

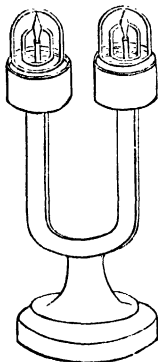

Fig. 591.

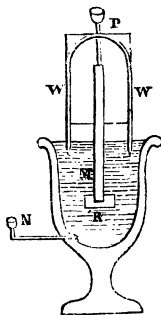

Fig. 592.

1934. *To make a magnet turn on its own axis by a current parallel to it.*—The tendency of the conductor on which a current passes to revolve round a magnet will not the less exist, though the current be so fixed to the magnet as to be incapable of revolving without carrying the magnet with it. In *fig. 592.*, the magnet *M* is sunk by a platinum weight *P*; its upper end being fixed to the copper cylinder *ww*, a current passing from *P* to *N* causes the cylinder to rotate, carrying with it the magnet.



Since a magnetic bar is itself a conductor, it is not necessary to introduce any other; and a current passing along the bar will give rotation to it. An apparatus for exhibiting this effect is represented in *fig. 593.*, where a magnetic bar is supported in the vertical position between pivots which play in agate cups. A circular mercurial canal is placed at the centre of the magnet, and another round the lower pivot. Mercurial cups communicate with these two canals. When these cups are put in communication with the poles of a battery, the current will pass between the two canals along the lower pole of the magnet, in the one direction or the other, according to the mode of connexion; and the magnet will turn on its own axis with a direct or retrograde rotation, according to

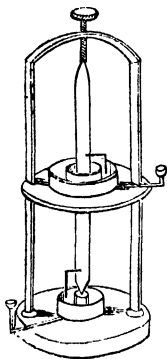

Fig. 593.

the name of the pole on which the current runs, and to the direction of the current.

## CHAP. V.

### RECIPROCAL INFLUENCE OF CIRCULATING CURRENTS AND MAGNETS.

If a wire  $PABCDN$ , *figs. 594., 595.*, be bent into the form of any geometrical figure, the extremities being brought near each other

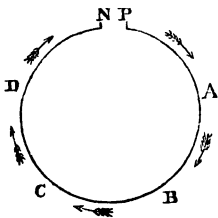

Fig. 594.

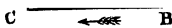

Fig. 595.

without actually touching, a current entering one extremity and departing from the other, is called a **CIRCULATING CURRENT.**

1935. *Front and back of circulating current.* — If such a current be viewed on opposite sides of the figure formed by the wire, it will appear to circulate in different directions, on one side *direct*, and on the other *retrograde* (1930). That side on which it appears *direct* is called the **FRONT**, and the other the **BACK** of the current.

1936. *Axis of current.* — If the current have a regular figure having a geometrical centre, a straight line drawn through this centre perpendicular to its plane is called the **AXIS** of the current.

1937. *Reciprocal action of circulating current and magnetic pole.* — To determine the reciprocal influence of a circulating current and a magnetic pole placed anywhere upon its axis, let

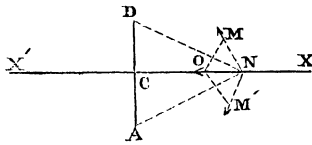

Fig. 596.

the axis be  $XCX'$ , *fig. 596.*, the plane of the current being at right angles to the paper, A being the point where it ascends, and D the point where it descends through the paper.

1°. Let N be a *north* magnetic pole placed in *front* of the current.

The part of the current at D will exert a force on N in the direction  $NM'$  at right angles to  $DN$ , and the part at A will exert an equal force in the direction  $NM$  at right angles to  $AN$ . These two forces being compounded, will be equivalent to a single force  $NO$  (152) directed from N along the axis *towards* the current.

It may be shown that the same will be true for every two points of the current which are diametrically opposed.

2°. Let a *south* magnetic pole  $s$ , *fig. 597.*, be similarly placed in *front* of a circulating current.

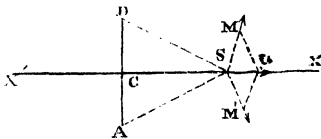

Fig. 597.

it a force in the direction  $sM$  perpendicular to  $sD$  and to the left of  $s$  as viewed from D, and the part A will exert an equal force in the direction  $sM'$  to the right of  $s$  as viewed from A. These two equal

forces will have a resultant  $so$  directed *from* the current; and the same will be true of every two points of the current which are diametrically opposed.

If the magnetic pole be placed at the *back* of the current, the contrary effects ensue.

The same inferences may be deduced with respect to any circulating current which has a centre, that is, a point within it which divides into two equal parts all lines drawn through it terminating in the current.

It may therefore be inferred generally that *when a magnetic pole is placed upon the axis of a circulating current, attraction or repulsion is produced between it and the current; attraction when a NORTH pole is before, or a SOUTH pole BEHIND, and repulsion when a SOUTH pole is before, or a north pole BEHIND.*

1938. *Intensity of the force vanishes when the distance of the pole bears a very great ratio to the diameter of current.*— Since the intensity of the attraction between the component parts of the current and the pole decreases as the square of the distance is increased, and since the lines NM and NM', *fig. 596.*, and SM and SM', *fig. 597.*, form with each other a greater angle as the distance of the pole from the current is increased, it is evident that when the diameter AD of the current bears an inconsiderable ratio to the distance of the pole N or S from it, the attraction or repulsion ceases to produce any sensible effect.

1939. *But the directive power of the pole continues.*— This, however, is not the case with relation to the *directive power* of the pole upon the current. The tendency of the forces impressed by the pole upon the current is always to bring the plane of the current at right angles to the line drawn from the pole to its centre. There is, in short, a tendency of the line of direction of the pole to take a position coinciding with or parallel to the axis of the current, and this coincidence may be produced either by the change of position of the pole or of the plane of the current, or of both, according as either or both are free to move.

1940. *Spiral and heliacal currents.*— The force exerted by a circulating current may be indefinitely augmented by causing the current to circulate several times round its centre or axis. If the wire which conducts the current be wrapped with silk or coated with any non-conducting varnish, so as to prevent the electricity from escaping from coil to coil when in contact, circulating currents may be formed round a common centre or axis in a ring, a spiral, a helix, or any other similar form, so

that the forces exerted by all their coils on a single magnetic pole may be combined by the principle of the composition of force; and hence an extensive class of electro-magnetic phenomena may be educed, which supply at the same time important consequences and striking experimental illustrations of the laws of attraction and repulsion which have been just explained.

1941. *Expedients to render circulating currents moveable.*—*Ampère's and Delarive's apparatus.*—Two expedients have been practised to render a circulating current moveable.

1. By the apparatus of AMPÈRE already described (1915), the wire conducting the current being bent at the ends, as represented in *fig. 598.*, may be supported in the cups *yy'* as represented in *fig. 564.*, so that its plane being vertical, it shall be capable of revolving round the line *yy'* as an axis. By this arrangement the plane of the current can take any direction at right angles to an horizontal plane, but it is not capable of receiving any progressive motion.

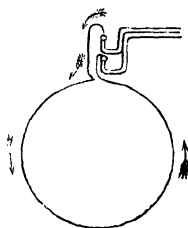

Fig. 598.

2. The latter object is attained by the floating apparatus of M. Delarive.

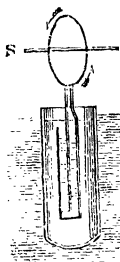

Fig. 599.

Let a coated wire be formed into a circular ring composed of several coils. Let one end of it be attached to a copper cell, *fig. 599.*, and the other to a slip of zinc which descends into this cell. The cell being filled with acidulated water, a current will be established through the wire in the direction of the arrows. The copper cell may be inclosed in a glass vessel, or attached to a cork so as to float upon water, and thus be free to assume any position which the forces acting upon the current may tend to give it.

1942. *Rotatory motion imparted to circular current by a magnetic pole.*—If a magnetic north pole be presented in front of a circular current, *fig. 598.*, suspended on Ampère's frame, *fig. 564.*, the ring will turn on its points of suspension until its axis pass through the pole. If the pole be carried round in a circle, the plane of the ring will revolve with a corresponding

motion, always presenting the front of the current to the pole, the axis of the current passing through the pole.

If a south magnetic pole be presented to the back of the current, like effects will be produced.

If a north magnetic pole be presented to the back, or a south to the front of the current, the ring will, on the least disturbance, make half a revolution round its points of suspension, so as to turn its point to the north and its back to the south magnetic pole.

1943. *Progressive motion imparted to it.*—If *c*, *fig.* 600.,

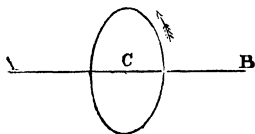

Fig. 600.

represent a floating circular current, a north magnetic pole placed anywhere on its axis will cause the ring conducting it to move in that direction in which its front is presented; for if the pole be before it at *A* it will attract the current, and if behind it at *B* it will repel it (1937). In either case the ring will move in the direction in which its front looks.

If a south magnetic pole be similarly placed, it will cause the current to move in the contrary direction; for if it be placed before the current at *A* it will repel it, and if *behind* it at *B* it will attract it. In either case the ring will move in the direction to which the back of the current looks.

1944. *Reciprocal action of the current on the pole.*—If the magnetic pole be moveable and the current fixed, the motion impressed on the pole by the action of the current will have a direction opposite to that of the motion which would be impressed on the current, being moveable, by the pole being fixed. A north magnetic pole placed on the axis of a fixed circular current will therefore be moved along the axis in that direction in which the back of the current looks, and a south magnetic pole in that direction in which the front looks.

1945. *Action of a magnet on a circular floating current.*—

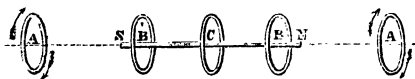

Fig. 601.

If a bar magnet *s n*, *fig.* 601., be placed in a fixed position with its magnetic axis in the direction of a floating circular current *A*, its north pole *N* being directed to the front of the current, the current will be attracted by *N* and repelled by *s*; but the force exerted by *N* will predominate in

consequence of its greater proximity to  $A$ , and the current will accordingly move from  $A$  towards  $N$ . After it passes  $N$ , the bar passing through the centre of the ring, it will be repelled by  $N$  and also by  $s$  (1937); but so long as it is between  $N$  and the centre  $C$  of the bar, as at  $B$ , the repulsion of  $N$  will predominate over that of  $s$  in consequence of the greater proximity of  $N$ , and the current will move towards  $C$ . Passing beyond  $C$  to  $B'$ , the repulsion of  $s$  predominates over that of  $N$ , and it will be driven back to  $C$ , and after some oscillations on the one side and the other it will come to rest in stable equilibrium, with its centre at the centre of the magnet, its plane at right angles to it, the front looking towards  $s$  and the back towards  $N$ .

1946. *Reciprocal action of the current on the magnet.*—If the current be fixed and the magnetic bar moveable, the latter will move in a direction opposite to that with which the current would move, the bar being fixed. Thus, if the current were fixed at  $A$ , the bar would move to it in the direction of  $NA$ , and the pole  $N$  passing through the ring, the bar would come to rest, after some oscillations, with its centre at the centre of the ring.

1947. *Case of instable equilibrium of the current.*—If the ring were placed with its centre at  $C$  and its front directed to  $N$ , it would be in instable equilibrium, for if moved through any distance, however small, towards  $N$  or  $s$ , the attraction of the pole towards which it is moved would prevail over that of the other pole which is more distant, and the ring would consequently be moved to the end of the bar and beyond that point, when, being still attracted by the nearest pole, it would soon be brought to rest. It would then make a half revolution on its axis and return to the centre of the bar, where it would take the position of stable equilibrium.

All these are consequences which easily follow from the general principles of attraction and repulsion established in (1937).

1948. *Case of a spiral current.*—If the wire which conducts the current be bent into the form of a spiral, *fig. 602.*, each convolution will exert the force of a circular current, and the effect of the whole will be the sum of the forces of all the convolutions. Such a spiral will therefore be subject to the conditions of attraction and repulsion which affect a circular current (1937).



Fig. 602.

1949. *Circular or spiral currents exercise the same action as a magnet.*—In general it may be inferred that circulating currents exercise on a magnetic pole exactly the same effects as would be produced by another magnet, the FRONT of the current playing the part of a SOUTH pole, and the BACK that of a NORTH pole.

1950. *Case of heliacal current.*—It has been shown that a helix or screw is formed by a point which is at the same time affected by a circular and progressive motion, the circular motion being at right angles to the axis of the helix, and the progressive motion being in the direction of that axis (496). In each convolution the thread of the helix makes one revolution, and at the same time progresses in the direction of the axis through a space equal to the distance between two successive convolutions.

1951. *Method of neutralizing the effect of the progressive motion of such a current.*—If a current therefore be transmitted on a heliacal wire, it will combine the characters of a circular and rectilinear current. The latter character, however, may be neutralized or effaced by transmitting a current in a contrary direction to the progression of the screw, on a straight wire extended along the axis of the helix. This rectilinear current being equal, parallel, and contrary in direction to the progressive component of the heliacal current, will have equal and contrary magnetic properties, and the forces which they exert together on any magnetic pole within their influence will counteract each other.

1952. *Right-handed and left-handed helices.*—Helices are



Fig. 603.



Fig. 604.

of two forms: those in which the wire turns like the thread of a corkscrew, that is, in the direction of the hands of a watch, *fig. 603.*; and those in which it turns in a contrary direction, *fig. 604.*

1953. *Front of current on each kind.*—If a current traverse a right-handed helix, its front will be directed to the end at which it enters, and in the left-handed helix to the end at which it departs.

1954. *Magnetic properties of heliacal currents—their poles determined.*—Hence it follows, that in a right-handed heliacal current, the end at which the current enters, and which is the positive pole, has the magnetic properties of a south pole; and in a left-handed helix this end has the properties of a north pole.

1955. *Experimental illustration of these properties.*—The magnetic properties of spiral and heliacal currents may be illustrated experimentally by means of Ampère's arrangement, *fig.* 564., or by a floating apparatus constructed on the same principle as that represented in *fig.* 599.

The manner of forming spiral currents adapted to Ampère's apparatus is represented in *figs.* 605. and 606. In *fig.* 605. the

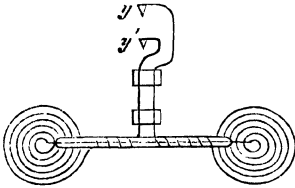

Fig. 605.

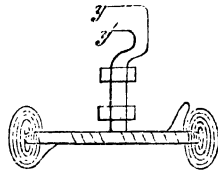

Fig. 606.

spirals are both in the same plane, passing through the axis of suspension  $yy'$ . In *fig.* 606. they are in planes parallel to this axis, and at right angles to the line joining their centres, which is therefore their common axis.

1956. *The front of a circulating current has the properties of a south, and the back those of a north, magnetic pole.*—According to what has been explained, the front of such a spiral current will have the properties of a south magnetic pole, and will therefore attract and be attracted by the north, and repel and be repelled by the south pole of a magnet. If the spirals in *fig.* 605., therefore, be so connected with the poles of a voltaic system, as to present their fronts on the same side, they will be both attracted by the north pole, and both repelled by the south pole of a magnet presented to them, that which is nearer to the magnet being more attracted or repelled than the other. If the magnetic pole be equally distant from them, they will be in equilibrium, and the equilibrium will be stable if they are both repelled, and instable if they are both attracted by the magnet.

To demonstrate this, let  $s$ , *fig.* 607., be the south pole of a magnet placed in front of the two spirals, whose centres are at  $A$  and  $B$ , equally distant from  $s$ . It is evident that a perpendicular  $so$  drawn from  $s$  to  $AB$  will in this case pass through the middle of  $AB$ . The pole  $s$  will therefore, according to what



has been already explained, repel the two spirals with equal

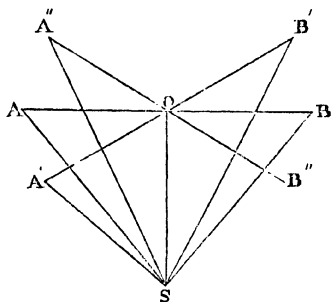

Fig. 607.

forces. If the spirals be removed from this position to the positions  $A'B'$ ,  $A'$ , being nearer to  $s$  than  $B'$ , will be repelled by a greater force, and therefore  $A'$  will be driven back towards  $A$ , and  $B'$  towards  $B$ . In like manner, if they were removed to the positions  $A''B''$ , the force repelling  $B''$  would be greater than that which repels  $A''$ , and therefore  $B''$  will be driven

back to  $B$ , and  $A''$  to  $A$ .

It follows, therefore, that the position of equilibrium of  $AB$  is in this case such that the system will return to it after the slightest disturbance on the one side or the other, and is therefore stable.

If the pole  $s$  were the north pole, it would attract both currents, and in that case  $A'$  would be more strongly attracted than  $B'$ , and  $B''$  than  $A''$ , and consequently the spirals would depart further from the position  $A$  after the least disturbance. The equilibrium would therefore be instable.

It will be found, therefore, that when a NORTH POLE is presented BEFORE, or a south pole BEHIND, such a pair of spiral currents, the system, *fig. 605.*, will, on the least disturbance from the position of instable equilibrium, turn on its axis  $yy'$  through half a revolution, presenting the fronts of the currents to the south pole, and will there come to rest after some oscillations.

In the position of stable equilibrium, the front of the currents must therefore be presented to the south pole of the magnet, or the back to the north pole.

1957. *Adaptation of an heliacal current to Ampère's and Delarive's apparatus.*

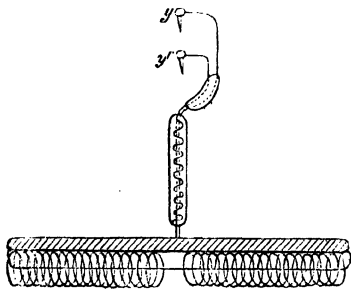

Fig. 608.

—The manner of adapting an heliacal current to Ampère's arrangement, *fig. 564.*, is represented in *fig. 608.*,

and the manner of adapting it to the floating method is represented in *fig. 609*.

The positive wire is carried down from *y*, *fig. 608*., and then coiled into an helix from the centre to the extremity. Thence it is carried in a straight direction through the centre of the helix to the other extremity, from whence it is again conducted in heliacal coils back to the centre, where it is bent upwards and terminates at the negative pole *y'*. In one half of the helix the current therefore enters at the centre and issues from the extremity, and in the other half it enters at the extremity and issues from the centre.

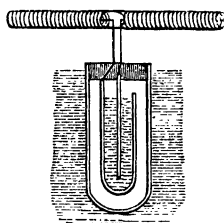

Fig. 609.

If the helices be both right-handed, therefore, the end from which the current issues will have the properties of a north, and that at which it enters those of a south, magnetic pole. If they be both left-handed, this position of the poles will be reversed (1954).

The wire which is carried straight along the axis neutralizes that component of the heliacal current, which is parallel to the axis, leaving only the circular elements effective (1951).

These properties may be experimentally verified by presenting either pole of a magnetic bar to one or the other end of the heliacal current. The same attractions and repulsions will be manifested as if the helix were a magnet.

1958. *Action of an heliacal current on a magnetic needle placed in its axis.*—If  $\Pi\Pi'$  represent an heliacal current, the front of

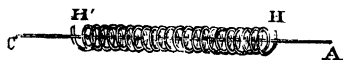

g. 610.

which looks towards  $A$ , a north magnetic pole placed anywhere in its axis, either within the limits of the helix or beyond its

extremities, will be urged by a force directed from  $A$  towards  $c$ . Between  $A$  and  $\Pi$  it will be attracted by the combined forces of the fronts of all the convolutions of the helix. Between  $\Pi$  and  $\Pi'$  it will be attracted by the fronts of those convolutions which are to the left of it, and repelled by the backs of all those to its right. Beyond  $\Pi'$  towards  $c$ , it will be repelled by the backs of all the convolutions. In all positions, therefore, it will, if free, be moved from right to left, or in a

direction contrary to that towards which the front of the current is directed.

If the pole were fixed and the current moveable, the helix would move from right to left, or in that direction towards which the front of the current looks.

If a magnetic needle  $SN$ , *fig.* 611., be placed in the centre of the axis of an helical current, with its poles equidistant from the extremities, the south pole  $s$  being presented towards that end  $F$  to which the front of the currents looks, it will be in equilibrium, the pole  $N$  being repelled towards  $B$ , and the pole  $s$  to-

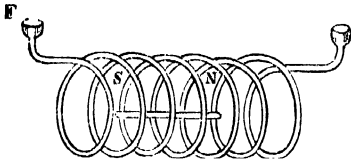

Fig. 611.

wards  $F$  by equal forces; for in this case the pole  $N$  will be attracted towards  $B$  by all the convolutions of the helix between  $N$  and  $B$ , and will be repelled in the same direction by all the convolutions between  $N$  and  $F$ ; while the pole  $s$  will in like manner be attracted towards  $F$  by all the convolutions between  $s$  and  $F$ , and repelled in the same direction by all the convolutions between  $s$  and  $B$ .

The needle  $SN$ , being thus impelled by two equal forces directed *from* its centre, will be in stable equilibrium.

If the directions of the poles were reversed, they would be impelled by two equal forces directed from its extremities towards its centre, and the equilibrium would be instable.

When the magnetic needle is sufficiently light, and the helical current sufficiently powerful, a curious effect may be observed, if the needle be placed within the helix so as to rest upon the lower parts of the wire. Before the current is transmitted, the needle will rest on the wires under the position  $SN$  represented in *fig.* 611.; but the moment the connexion with the battery is made, and the current established, it will start up and place itself in the middle of the axis of the helix, as in the figure, where it will remain suspended in the air without any visible support.

## CHAP. VI.

## ELECTRO-MAGNETIC INDUCTION.

1959. *Inductive effect of a voltaic current upon a magnet.*—The forces which a voltaic current impresses upon the poles of a permanent magnet, being similar in all respects to those with which the same poles would be affected by another magnet, it may be expected that the natural magnetism of an unmagnetized body would be decomposed, and polarity imparted to it by the approach of a voltaic current, in the same manner as by the approach of a magnet. Experiment accordingly confirms this consequence of the analogy suggested by the phenomena. It is, in fact, found that a voltaic current is capable of decomposing the natural magnetism of magnetic bodies, and of magnetizing them as effectually as the most powerful magnets.

*Soft iron rendered magnetic by voltaic currents.*—If the wire upon which a voltaic current flows be immersed in filings of soft iron, they will collect around it, and attach themselves to it in the same manner as if it were a magnet, and will continue to adhere to it so long as the current is maintained upon it; but the moment the connexions with the battery are broken, and the current suspended, they will drop off.

*Sewing needles attracted by current.*—Light steel sewing needles being presented to the wire conducting a current will instantly become magnetic, as will be apparent by their assuming a position at right angles to the wire, as a magnetic needle would do under like circumstances. When the current is suspended or removed, the needles will in this case retain the magnetism imparted to them.

1960. *Magnetic induction of an heliacal current.*—To exhibit these phenomena with greater effect and certainty, the needles should be exposed to the influence not of one, but of several currents, or of several parts of the same current flowing at right angles to them. This is easily effected by placing them within an heliacal current.

Let a metallic wire coated with silk or other non-conductor

be rolled heliacally on a glass tube, *fig. 612.*, and the current being made to pass along the wire, let a needle or bar of steel or hard iron be placed within the tube. It will *instantaneously* acquire all the magnetism it is capable of receiving under these circumstances.

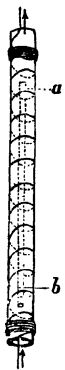

On testing the needle it will be found that its boreal or south pole is at that end to which the front of the current is presented; and, consequently, for a right-handed helix, it will be towards the positive, and for a left-handed helix towards the negative pole. It appears, therefore, that the needle acquires a polarity identical with that which the helix itself is proved to possess.

1961. *Polarity produced by the induction of heliacal current.*—In the case of the right-handed helix, represented in *fig. 612.*, the current passes in the direction indicated by the arrows, and consequently the austral pole will be at *a* and the boreal pole at *b*. In the case of the left-handed helix, *fig. 613.*, the position of these poles *a* and *b* is reversed in relation to the direction of the current, but the boreal pole *b* is in both cases at that end to which the front of the current looks.

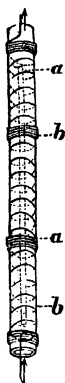

Fig. 613.

1962. *Consequent points produced.*—If the helix be reversed once or oftener in passing along the tube, being alternately right-handed and left-handed, as represented in *fig. 614.*, a *consequent point* will be produced upon the bar at each change of direction of the helix.

1963. *Inductive action of common electricity produces polarity.*—It is not only by the induction of the voltaic current that magnetic polarity may be imparted. Discharges of common electricity transmitted along a wire, especially if it have the form of an helix, will produce like effects. If the wire be straight, the influence is feeble. Sparks taken from the prime conductor produce sensible effects on very fine needles; but if the wire be placed in actual contact with the conductor at one end and the cushion at the other, so that a constant current shall pass along it from the conductor to the cushion, no effect is produced. The effect produced by the spark is augmented as the spark is more intense and taken at a greater distance from the conductor.

If the wire be formed into an helix, magnetic polarity will be produced by a continuous current, that is, by actually connecting the ends of the wire with the conductor and the cushion; but these effects are much more feeble than those produced under like circumstances by the spark.



All these effects are rendered much more intense when the discharge of a Leyden jar, and still more that of a Leyden battery, is transmitted along the wire.

When these phenomena were first noticed, it was assumed that the polarity thus imparted by common electricity must necessarily follow the law which prevails in the case of a voltaic current, and that in the case of helices the boreal or south pole would be presented towards the front of the current. Savary,

Fig. 614. however, showed that the effects of common electricity obey a different principle, and thus established a fundamental distinction between the voltaic current and the electric discharge.

1964. *Conditions on which a needle is magnetized positively and negatively.* — When an electric discharge is transmitted along a straight wire, a needle placed at right angles to the wire acquires sometimes the polarity of a magnetic needle, which under the influence of a voltaic current would take a like position; that is to say, the austral or north pole will be to the right of an observer who looks at the needle from the current, his head being in the direction from which the current flows. The needle is in this case said to be magnetized *positively*. When the opposite polarity is imparted to the needle, it is said to be magnetized *negatively*.

1965. *Results of Savary's experiments.* — Savary showed that needles are magnetized by the discharge of common electricity, positively or negatively, according to various conditions, depending on the intensity of the discharge, the length of the conducting wire, supposing it to be straight, its diameter, the thickness of the needles, and their coercive force. In a series of experiments, in which the needles were placed at distances from the current increasing by equal increments, the magnetization was alternately positive and negative; when the needle was in contact with the wire, it was positive; at a small distance negative, at a greater distance no magnetization was produced; a further increase of distance produced positive

magnetism ; and after several alternations of this kind, the magnetization ended in being positive, and continued positive at all greater distances.

The number and frequency of these alternations are dependent on the conditions above-mentioned, but no distinct law showing their relation to those conditions has been discovered. In general it may be stated, that the thinner the wire which conducts the current, the lighter and finer the needles, and the more feeble their coercive force is, the less numerous will be those periodical changes of positive and negative magnetization. It is sometimes found, that when these conditions are observed, the magnetization is positive at all distances, and that the periodic changes only affect its intensity.

Similar effects are produced upon needles placed in tubes of wood or glass, upon which an heliacal current is transmitted. In these cases, the mere variation in the intensity of the discharge produces considerable effect.

1966. *Magnetism imparted to the needle affected by the non-magnetic substance which surrounds it.* — Savary also ascertained a fact which, duly studied, may throw much light on the theory of these phenomena. The quantity of magnetism imparted to a needle by an electric discharge, and the character of its polarity, positive or negative, are affected by the non-magnetic envelope by which the needle is surrounded. If a needle be inserted in the axis of a very thick cylinder of copper, an heliacal current surrounding the cylinder will not impart magnetism to it. If the thickness of the copper envelope be gradually diminished, the magnetization will be manifested in a sensible degree, and it will become more and more intense as the thickness of the copper is diminished. This increase, however, does not continue until the copper envelope disappears, for when the thickness is reduced to a certain limit, a more intense magnetization is produced than when the uncovered needle is placed within the helix.

Envelopes of tin, iron, and silver placed around the needle are attended with analogous effects, that is to say ; when they consist of very thin leaf metal they increase the quantity of magnetism which can be imparted to the needles by the current ; but when the metallic envelope is much thicker, they prevent the action of the electric discharge altogether. Cylinders formed of metallic filings do not produce these effects, while cylinders

formed of alternate layers of metallic and non-metallic substances do produce them. It is inferred from this that solutions of continuity at right angles to the axis of the needle, or to that of the cylinder, have an influence on the phenomena.

1967. *Formation of powerful electro-magnets.*—The inductive effect of a spiral or heliacal current on soft iron is still more energetic than on steel or other bodies having more or less coercive force. The property enjoyed by soft iron, of suddenly acquiring magnetism from any external magnetizing agent, and as suddenly losing its magnetism upon the suspension of such agency, has supplied the means of producing the temporary magnets which are known under the name of ELECTRO-MAGNETS.

The most simple form of electro-magnet is represented in *fig. 615*. It is composed of a bar of soft iron bent into the form of a horse-shoe, and of a wire wrapped with silk, which is coiled first on one arm, proceeding from one extremity to the bend of the horse-shoe, and then upon the other from the bend to the other extremity, care being taken that the convolutions of the spiral shall follow the same direction in passing from one leg to the other, since, otherwise, consequent points would be produced. An armature is applied to the

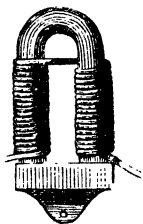

*Fig. 615.*

ends of the horse-shoe, which will adhere to them so long as a voltaic current flows upon the wire, but which will drop off the moment that such current is discontinued.

1968. *Conditions which determine the force of the magnet.*—The force of the electro-magnet will depend on the dimensions of the horse-shoe and the armature, the intensity of the current, and the number of convolutions with which each leg of the horse-shoe is wrapped.

1969. *Electro-magnet of Faculty of Sciences at Paris.*—In 1830 an electro-magnet of extraordinary power was constructed under the superintendence of M. Pouillet at Paris. This apparatus, represented in *fig. 616*., consists of two horse-shoes, the legs of which are presented to each other, the bends being turned in contrary directions. The superior horse-shoe is fixed in the frame of the apparatus, the inferior being attached to a cross-piece which slides in vertical grooves formed in the



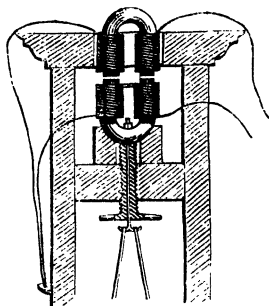

Fig. 616.

sides of the frame. To this cross-piece a dish or plateau is suspended in which weights are placed, by the effect of which the attraction which unites the two horse-shoes is at length overcome. Each of the horse-shoes is wrapped with 10,000 feet of covered wire, and they are so arranged that the poles of contrary names shall be in contact. With a current of moderate intensity the apparatus is capable of supporting a weight of several tons.

1970. *Form of electro-magnets in general.*—It is found more convenient generally to construct electro-magnets of two straight bars of soft iron, united at one end by a straight bar transverse to them, and attached to them by screws, so that the form of the magnet ceases to be that of a horse-shoe, the end at which the legs are united being not curved but square. The conductor of the heliacal current is usually a copper wire of extreme tenuity.

1971. *Electro-magnetic power applied as a mechanical agent.*—The property of electro-magnets by which they are capable of suddenly acquiring and losing the magnetic force has supplied the means of obtaining a mechanical agent which may be applied as a mover of machinery. An electro-magnet and its armature, such as that represented in *fig. 615.*, or two electro-magnets such as those represented in *fig. 616.*, are placed so that when the electric current is suspended they will rest at a certain distance asunder, and when the current passes on the wire they will be drawn into contact by their mutual attraction. When the current is again suspended they will separate. In this manner, by alternately suspending and transmitting the current on the wire which is coiled round the electro-magnet, the magnet and its armature, or the two magnets, receive an alternate motion to and from each other similar to that of the piston of a steam-engine, or the foot of a person who works the treddle of a lathe. This alternate motion is made to produce one of continued rotation by the same mechanical expedients as are used in the application of any other moving power.

The force with which the electro-magnet and its armature attract each other, determines the power of the electro-motive machine, just as the pressure of steam on the piston determines the power of a steam-engine. This force, when the magnets are given, varies with the nature and magnitude of the galvanic pile which is employed.

1972. *Electro-motive power applied in the workshop of M. Froment.*—The most remarkable and beautiful application of electro-motive power as a mechanical agent which has been hitherto witnessed is presented in the workshops of M. Gustave Froment, of Paris, so celebrated for the construction of instruments of precision. It is here applied in various forms to give motion to the machines contrived by M. Froment for dividing the limbs of astronomical and surveying instruments and microscopic scales. The pile used for the lighter description of work is that of Daniel, consisting of about 24 pairs. Simple arrangements are made by means of commutators, reometers, and reotropes, for modifying the current indefinitely in quantity, intensity, and direction. By merely turning an index or lever in one direction or another, any desired number of pairs may be brought into operation, so that a battery of greater or less intensity may be instantly made to act, subject to the major limit of the number of pairs provided. By another adjustment, the copper elements of two or more pairs, and at the same time their zinc elements, may be thrown into connexion, and thus the whole pile, or any portion of it, may be made to act as a single pair, of enlarged surface. By another adjustment, the direction of the current can be reversed at pleasure. Other adjustments, equally simple and effective, are provided, by which the current can be turned on any particular machine, or directed into any room that may be required.

The pile used for heavier work, is a modification of Bunsen's charcoal battery, in which dilute sulphuric acid is used in the porous porcelain cell containing the charcoal, as well as in the cell containing the zinc. By this expedient the noxious fumes of the nitric acid are removed, and although the strength of the battery is diminished, sufficient power remains for the purposes to which it is applied.

The forms of the electro-motive machines constructed by

M. Froment are very various. In some the magnet is fixed and the armature moveable; in some both are moveable.

In some there is a single magnet and a single armature. The power is in this case intermittent, like that of a single acting steam-engine, or of the foot in working the treddle of a lathe, and the continuance of the action is maintained in the same manner by the inertia of a fly-wheel.

In other cases two electro-magnets and two armatures are combined, and the current is so regulated, that it is established on each during the intervals of its suspension on the other. This machine is analogous in its operation to the double-acting steam-engine, the operation of the power being continuous, the one magnet attracting its armature during the intervals of suspension of the other. The force of these machines may be augmented indefinitely, by combining the action of two or more pairs of magnets.

Another variety of the application of this moving principle, presents an analogy to the rotatory steam-engine. Electro-magnets are fixed at equal distances round a wheel, to the circumference of which the armatures are attached at corresponding intervals. In this case the intervals of action and intermission of the currents are so regulated, that the magnets attract the armatures obliquely, as the latter approach them, the current, and consequently the attraction, being suspended the moment contact takes place. The effect of this is, that all the magnets exercise forces which tend to turn the wheel on which the armatures are fixed constantly in the same direction, and the force with which it is turned is equal to the sum of the forces of all the electro-magnets which act simultaneously.

This rotatory electro-motive machine is infinitely varied, not only in its magnitude and proportions, but in its form. Thus in some the axle is horizontal, and the wheel revolves in a vertical plane; in others the axle is vertical, and the wheel revolves in an horizontal plane. In some the electro-magnets are fixed, and the armatures moveable with the wheel; in others both are moveable. In some the axle of the wheel which carries the armatures is itself moveable, being fixed upon a crank or excentric. In this case the wheel revolves within another, whose diameter exceeds its own by twice the length of the crank, and within this circle it has an hypocycloidal motion.

Each of these varieties of the application of this power, as yet novel in the practical operations of the engineer and manufacturer, possesses peculiar advantages or convenience, which render it more eligible for special purposes.

1973. *Electro-motive machines constructed by him.* — To render this general description of M. Froment's electro-motive machines more clearly understood, we shall add a detailed explanation of two of the most efficient and useful of them.

In the machine represented in *fig. 617.*, *a* and *b* are the two legs of the electro-magnet; *cd* is the transverse piece uniting

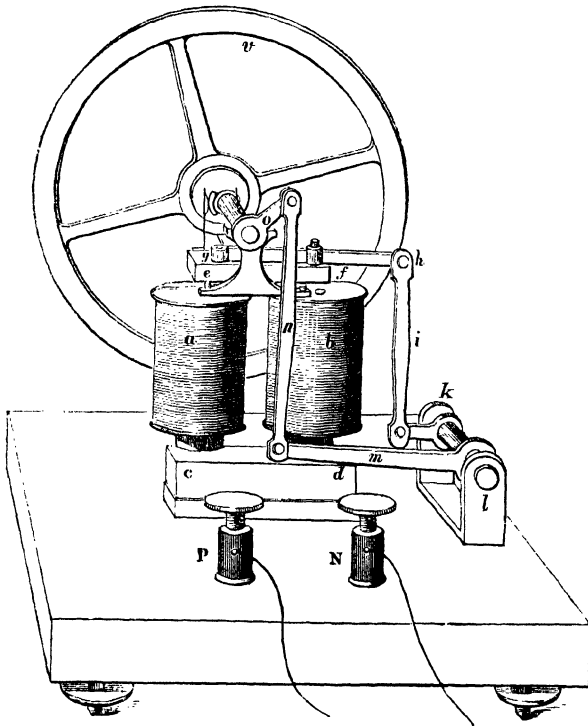

Fig. 617.

them, which replaces the bend of the horse-shoe; *ef* is the armature confined by two pins on the summit of the leg *a*

(which prevent any lateral deviation), the end  $f$  being jointed to the lever  $gh$ , which is connected with a short arm projecting from an axis  $k$  by the rod  $i$ . When the current passes round the electro-magnet, the lever  $f$  is drawn down by the attraction of the leg  $b$ , and draws with it the lever  $gh$ , by which  $i$  and the short lever projecting from the axis  $k$  are also driven down. Attached to the same axis  $k$  is a longer arm  $m$ , which acts by a connecting rod  $n$  upon a crank  $o$  and a fly-wheel  $v$ . When the machine is in motion, the lever  $gh$  and the armature  $f$  attached to it recover their position by the momentum of the fly-wheel, after having been attracted downwards. When the current is again established, the armature  $f$  and the lever  $gh$  are again attracted downwards, and the same effects ensue. Thus, during each half-revolution of the crank  $o$ , it is driven by the force of the electro-magnet acting on  $f$ , and during the other half-revolution it is carried round by the momentum of the fly-wheel. The current is suspended at the moment the crank  $o$  arrives at the lowest point of its play, and is re-established when it returns to the highest point. The crank is therefore impelled by the force of the magnet in the descending half of its revolution, and by the momentum of the fly-wheel in the ascending half.

The contrivance called a *distributor*, by which the current is alternately established and suspended at the proper moments, is represented in *fig.* 618., where  $y$  represents the transverse section of the axis of the fly-wheel;  $r$ , a spring which is kept in constant contact with it;  $x$ , an excentric fixed on the same axis  $y$ , and revolving with it and  $r'$  another spring similar to  $r$ , which is acted upon by the excentric, and is thus allowed to press against the axis  $y$  during half the revolution, and removed from contact with it during the other half-revolution. When the spring  $r'$  presses on the axis  $y$  the current is established; and when it is removed from it the current is suspended.

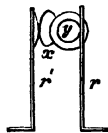

Fig. 618.

It is evident that the action of this machine upon the lever attached to the axis  $k$  is exactly similar to that of the foot on the treddle of a lathe or a spinning-wheel; and as in these cases, the impelling force being intermittent, the action is unequal, the velocity being greater during the descending motion of the crank  $o$  than during its ascending motion. Although the inertia of the fly-wheel diminishes this inequality by absorbing

a part of the moving power in the descending motion, and restoring it to the crank in the ascending motion, it cannot altogether efface it.

Another electro-motive machine of M. Froment is represented in elevation in *fig. 619.*, and in plan in *fig. 620.* This machine

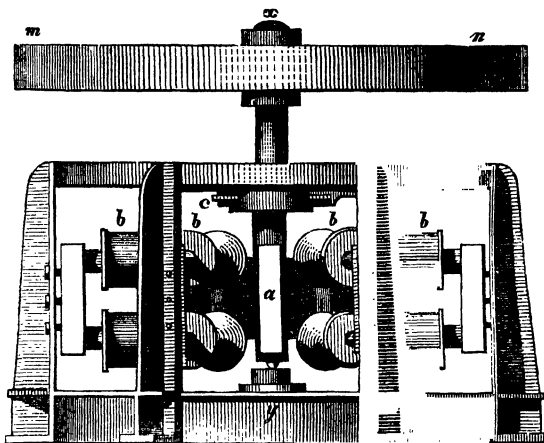

Fig. 619.

has the advantage of producing a perfectly regular motion of rotation, which it retains for several hours without sensible change.

A drum, which revolves on a vertical axis  $xy$ , carries on its circumference eight bars of soft iron  $a$  placed at equal distances asunder. These bars are attracted laterally, and always in the same direction, by the intermitting action of six electro-magnets  $b$ , mounted in a strong hexagonal frame of cast iron, within which the drum revolves. The intervals of action and suspension of the current upon these magnets are so regulated that it is established upon each of them at the moment one of the bars of soft iron  $a$  is approaching it, and it is suspended at the moment the bar begins to depart from it. Thus the attraction accelerates the motion of the drum upon the approach of the piece  $a$  towards the magnet  $b$ , and ceases to act when the piece  $a$  arrives in face of  $b$ . The action of each of the six impelling forces upon each of the eight bars of soft iron attached to the

drum is thus intermitting. During each revolution of the drum, each of the eight bars *a* receives six impulses, and there-

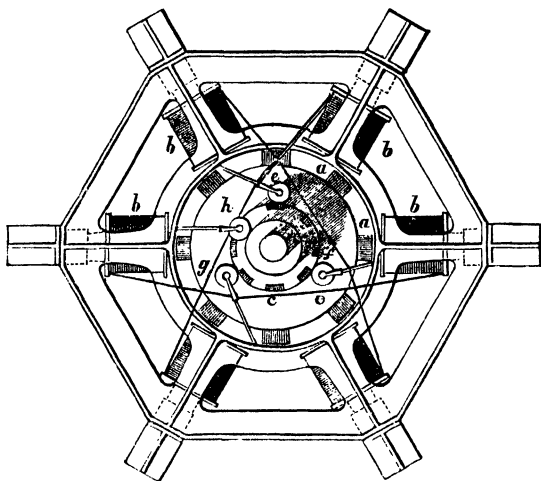

Fig. 620.

fore the drum itself receives forty-eight impulses. If we suppose the drum to make one revolution in four seconds, it will therefore receive a succession of impulses at intervals of the twelfth part of a second, which is practically equivalent to a continuous force.

The intervals of intermission of the current are regulated by a simple and ingenious apparatus. A metallic disc *c* is fixed upon the axis of rotation. Its surface consists of sixteen equal divisions, the alternate divisions being coated with non-conducting matter. A metallic roller *h*, which carries the current, presses constantly on the surface of this disc, to which it imparts the current. Three other metallic rollers *efg* press against the edge of the disc, and, as the disc revolves, come alternately into contact with the conducting and non-conducting divisions of it. When they touch the conducting divisions, the current is transmitted; when they touch the non-conducting divisions, the current is interrupted.

Each of these three rollers *efg* is connected by a conducting wire with the conducting wires of two electro-magnets diame-

trically opposed, as is indicated in *fig.* 620., so that the current is thus alternately established and suspended on the several electro-magnets, as the conducting and non-conducting divisions of the disc pass the rollers *e*, *f*, and *g*.

M. Froment has adapted a regulator to this machine, which plays the part of the governor of the steam-engine, moderating the force when the action of the pile becomes too strong, and augmenting it when it becomes too feeble.

A divided circle *mn*, *fig.* 619., has been annexed to the machine at the suggestion of M. Pouillet, by which various important physical experiments may be performed.

1974. *Applied as a sonometer.*—This machine has been applied with much success as a *sonometer*, to ascertain and register directly the number of vibrations made by sonorous bodies in a given time.

1975. *Momentary current by induction.*—If a wire A, on which a voltaic current is transmitted, be brought into proximity with and parallel to another wire B, the ends of which are in metallic contact either with each other, or with some continuous system of conductors, so as to form a *closed circuit*, the electric equilibrium of the wire B will be disturbed by the action of the current A, and a current will be produced upon B in a direction opposite to that which prevails on A. This current will, however, be only momentary. After an instant the wire B will return to its natural state.

If the wire A, still carrying the current, be then suddenly removed from the wire B, the electric equilibrium of B will be again disturbed, and as before, only for a moment; but in this case the current momentarily produced on B will have the same direction as the current on A.

If the contact of the extremities of the wire B, or either of them with each other, or with the intermediate system of conductors which complete the circuit, be broken, the approach or removal of the current A will not produce these effects on the wire B.

If, instead of moving the wire A to and from B, the wires, both in their natural state, be placed parallel and near to each other, and a current be then suddenly transmitted on A, the same effect will be produced on B as if A, already bearing the current, had been suddenly brought into proximity with B. And in the same way it will be found that if the current es-



established on A be suddenly suspended, the same effect will be produced as if A, still bearing the current, were suddenly removed.

These phenomena may be easily exhibited experimentally, by connecting the extremities of the wire A with a voltaic pile, and the extremities of B with the wires of a reoscope. So long as the current continues to pass without interruption on A, the needle of the reoscope will remain at rest, showing that no current passes on B. But if the contact of A with either pole of the pile be suddenly broken, so as to stop the current, the needle of the reoscope will be deflected for a moment in the direction which indicates a current similar in direction to that which passed on A, and which has just been suspended; but this deflection will only be momentary. The needle will immediately recover its position of rest, indicating that the cause of the disturbance has ceased.

If the extremity of A be then again placed suddenly in contact with the pile, so as to re-establish the current on A, the needle of the reoscope will again be deflected, but in the other direction, showing that the current produced on B is in the contrary direction to that which passes on A, and, as before, the disturbance will only be momentary, the needle returning immediately to its position of rest.

These momentary currents are therefore ascribed to the inductive action of the current A upon the natural electricity of the wire B, decomposing it and causing for a moment the positive fluid to move in one direction, and the negative in the other. It is to the *sudden presence* and the *sudden absence* of the current A, that the phenomena must be ascribed, and not to any action depending on the commencement of the passage of the current on A, or on its discontinuance, because the same effects are produced by the *approach* and *withdrawal* of A while it carries the current, as by the *transmission* and *discontinuance* of the current upon it.

1976. *Experimental illustration.*—The most convenient form of apparatus for the experimental exhibition of these momentary currents of induction, consists of two wires wrapped with silk, which are coiled round a cylinder or roller of wood or metal, as represented in *fig. 621*. The ends are separated in leaving the roller, so that those of one wire may be carried to the pile, and those of the other to the reoscope. The effect of

the inductive action is augmented in proportion to the length of the wires brought into proximity, other things being the same. It is found that the wire B, which receives the inductive action, should be much finer and longer than that, A, which bears the primary current. Thus, for example, while

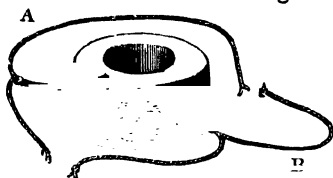

Fig. 621.

150 feet of wire No. 18. were used for A, 2000 feet of No. 26. were used for B.

The effect of the induction is greatly augmented by introducing a cylinder of soft iron, or, still better, a bundle of soft iron wires, into the core of the roller. The current on A renders this mass of soft iron magnetic, and it reacts by induction on the wires conducting the currents.

1977. *Momentary currents produced by magnetic induction.*—Since, as has been shown, a magnetic bar and an heliacal current are interchangeable, it may naturally be inferred that if an heliacal current produces by induction momentary currents upon an heliacal wire placed in proximity with it, a magnet must produce a like effect. Experiment has accordingly confirmed this inference.

1978. *Experimental illustrations.*—Let the extremities of a

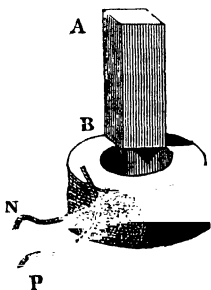

Fig. 622.

covered wire coiled on a roller, *fig. 622.*, be connected with a reoscope, and let the pole of a magnet AB be suddenly inserted in the core of the coil. A momentary deflection of the needles will be produced, similar to that which would attend the sudden approach of the end of an heliacal current having the properties of the magnetic pole which is presented to the coil. Thus the *boreal* pole will produce the same deflection as the *front*, and the *austral* pole as the *back* of an heliacal current.

In like manner, the sudden removal of a magnetic pole from proximity with the heliacal wire will produce a momentary current on the wire, similar to that which would be produced by the sudden removal of an heliacal current having like magnetic properties.

The sudden presence and absence of a magnetic pole within the coil of wire on which it is desired to produce the induced current may be caused more conveniently and efficiently by means of the effects of magnetic induction on soft iron. The manner of applying this principle to the production of the induced current is as follows:—

Let *a b*, *fig. 623.*, be a powerful horse-shoe magnet, over which is placed a similar shoe of soft iron, round which the conducting wire is coiled in the usual manner, the direction of the coils being reversed in passing from one leg of the horse-shoe to the other, so that the current in passing on each leg may have its front presented in opposite directions. The extremities of the wire are connected with those of a reoscope at a sufficient distance from the magnet to prevent its indications from being disturbed by the influence of the magnet.

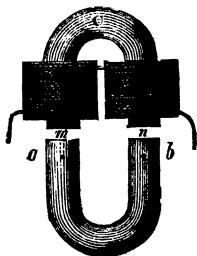

Fig. 623.

If the poles *ab* of the magnet be suddenly brought near the ends of the legs of the horse-shoe *mcn*, the needle of the reoscope will indicate the existence of a momentary current on the coil of wire, the direction of which will be opposite to that which would characterize the magnetic polarity imparted by induction to the horse-shoe *mcn*. If the magnet *ab* be then suddenly removed, so as to deprive the horse-shoe *mcn* of its magnetism, the reoscope will again indicate the existence of a momentary current, the direction of which will now, however, be that which characterizes the polarity imparted to the horse-shoe *mcn*.

It appears, therefore, as might be expected, that the sudden decomposition and recombination of the magnetic fluids in the soft iron contained within the coil has the same effect as the sudden approach and removal of a magnet.

1979. *Inductive effects produced by a permanent magnet revolving under an electro-magnet.*—If the magnet *ab* were mounted so as to revolve upon a vertical axis passing through the centre of its bend, and therefore midway between its legs, its poles might be made to come alternately under the ends of the horse-shoe *mcn*, the horse-shoe *mcn* being stationary. During each revolution of the magnet *ab*, the polarity imparted by magnetic induction to the horse-shoe would be reversed.

When the austral pole  $a$  passes under  $m$ , and therefore the boreal pole under  $n$ ,  $m$  would acquire boreal and  $n$  austral polarity. After making half a revolution  $b$  would come under  $m$ , and  $a$  under  $n$ , and  $m$  would acquire by induction austral and  $n$  boreal polarity. The momentary currents produced in the coils of wire would suffer corresponding changes of direction consequent as well on the commencement as on the cessation of each polarity, austral and boreal.

To trace these vicissitudes of the inductive current produced upon the wire, it must be considered that the commencement of austral polarity in the leg  $m$ , and that of boreal polarity in the leg  $n$ , give the same direction to the momentary inductive current, inasmuch as the wire is coiled on the legs in contrary directions. In the same manner it follows that the commencement of boreal polarity in  $m$ , and of austral polarity in  $n$ , produce the same inductive current.

The same may be said of the direction of the inductive currents consequent on the cessation of austral and boreal polarity in each of the legs. The cessation of austral polarity in  $m$ , and of boreal polarity in  $n$ , or the cessation of boreal polarity in  $m$ , and of austral polarity in  $n$ , produce the same inductive current. It will also follow, from the effects of the current and the reversion of the coils in passing from one leg to the other, that the inductive current produced by the cessation of either polarity on one leg of  $mcn$  will have the same direction as that produced by the commencement of the same polarity in the other.

If the magnet  $ab$  were made to revolve under  $mcn$ , it would therefore follow that during each revolution four momentary currents would be produced in the wire, two in one direction during one semi-revolution, and two in the contrary direction during the other semi-revolution. In the intervals between these momentary currents the wire would be in its natural state.

It has been stated that if the extremities of the wire were not in metallic contact with each other, or with a continuous system of conductors, these inductive currents would not be produced. This condition supplies the means of producing in the wire an intermitting inductive current constantly in the same direction. To accomplish this, it will be only necessary to contrive means to *break the contact* of either extremity of the coil with the

intermediate conductor during the same half of each successive revolution of the magnet. By this expedient the contact may be maintained during the half revolution in which the commencement of austral polarity in the leg  $m$ , and of boreal in the leg  $n$ , and the cessation of boreal polarity in the leg  $m$ , and of austral in the leg  $n$ , respectively take place. All these changes produce momentary currents having a common direction. The contact being broken during the other semi-revolution, in which the commencement of boreal polarity in  $m$ , and of austral in  $n$ , and the cessation of austral polarity in  $m$ , and of boreal in  $n$ , respectively take place, the contrary currents which would otherwise attend these changes will not be produced.

1980. *Use of a contact breaker.*—If it be desired to reverse the direction of the intermitting current, it will be only necessary to contrive a *contact breaker* which will admit of such an adjustment that the contact may be maintained at pleasure, during either semi-revolution of the magnet  $ab$ , while it is broken during the other.

1981. *Magneto-electric machines.*—Such are the principles on which is founded the construction of magneto-electric machines, one form of which is represented in *fig. 624*. The purpose of this apparatus is to produce by magnetic induction an intermitting current constantly in the same direction, and to contrive means by which the intervals of intermission shall succeed each other so rapidly that the current shall have practically all the effects of a current absolutely continuous.

A powerful compound horse-shoe magnet  $A$  is firmly attached by bolts and screws upon an horizontal bed, beyond the edge of which its poles  $a$  and  $b$  extend. Under these is fixed an electro-magnet  $xy$ , with its legs vertical, and mounted so as to revolve upon a vertical axis. The covered wire is coiled in great quantity on the legs  $xy$ , the direction of the coils being reversed in passing from one leg to the other; so that if a voltaic current were transmitted upon it, the ends  $x$  and  $y$  would acquire opposite polarities.

The axis upon which this electro-magnet revolves has upon it a small grooved wheel  $f$ , which is connected by an endless cord or band  $n$ , with a large wheel  $R$  driven by a handle  $m$ . The relative diameters of the wheels  $R$  and  $f$  is such that an extremely rapid rotation can be imparted to  $xy$  by the hand applied at  $m$ .

The two extremities of the wire proceeding from the legs *x* and *y* are pressed by springs against the surfaces of two rollers, *c* and *d*, fixed upon the axis of the electro-magnet. These

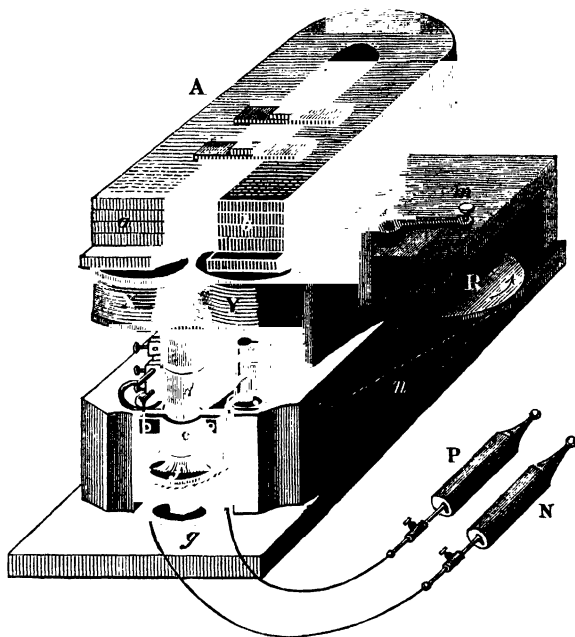

Fig. 624.

rollers themselves are in metallic connexion with a pair of handles *P* and *N*, to which the current evolved in the wire of the electro-magnet *xy* will thus be conducted.

If the electro-magnet *xy* be now put in rotation by the handle *m*, the handles *P* and *N* being connected by any continuous conductor, a system of intermitting and alternately contrary currents will be produced in the wire and in the conductor by which the handles *P* and *N* are connected. But if the rollers *c* and *d* are so contrived that the contact of the ends of the wire with them shall be only maintained during a semi-revolution in which the intermitting currents have a common direction, then the current transmitted through the conductor connecting the handles *P* and *N* will be intermitting, but not

contrary; and by increasing the velocity of rotation of the electro-magnet  $xy$ , the intervals of intermission may be made to succeed each other with indefinite celerity, and the current will thus acquire all the character of a continuous current.

The contrivances by which the rollers  $c$  and  $d$  are made to break the contact, and re-establish it with the necessary regularity and certainty, are various. They may be formed as *eccentrics*, so as to approach to and recede from the ends of the wire as they revolve, touching them and retiring from them at the proper moments. Or, being circular, they may consist alternately of conducting and non-conducting materials. Thus one half of the surface of such roller may be metal, while the other is wood, horn, or ivory. When the end of the wire touches the latter the current is suspended, when it touches the former it is maintained.

1982. *Effects of this machine—its medical use.*—All the usual effects of voltaic currents may be produced with this apparatus. If the handles  $r$  and  $n$  be held in the hands, the arms and body become the conductor through which the current passes from  $r$  to  $n$ . If  $xy$  be made to revolve, shocks are felt, which become insupportable when the motion of  $xy$  acquires a certain rapidity.

If it be desired to give local shocks to certain parts of the body, the hands of the operator, protected by non-conducting gloves, direct the knobs at the ends of the handles to the parts of the body between which it is desired to produce the voltaic shock.

1983. *Inductive effects of the successive convolutions of the same helix.*—The inductive effect produced by the commencement or cessation of a current upon a wire, forming part of a closed circuit placed near and parallel to it, would lead to the inference that some effect may be produced by one coil of an heliacal current upon another at the moment when such current commences or ceases. At the moment when the current commences, it might be expected that the inductive action of one coil upon another, having a tendency to produce a momentary current in a contrary direction, would mitigate the initial intensity of the actual current, and that at the moment the current is suspended the same inductive action, having a tendency to produce a momentary current in the same direction, would, on the contrary, have a tendency to augment the intensity of the actual current.

The phenomena developed when the contact of a closed circuit is made or broken, are in remarkable accordance with these anticipations.

If the wires which connect the poles of an ordinary pile, consisting of a dozen pairs, be separated or brought together, a very feeble spark will be visible, and no sensible change in the intensity of this spark will be produced when the length of the wire compassing the circuit is augmented so much as to amount to 150 or 200 yards. If this wire be folded or coiled in any manner, so long as the parts composing the folds or coils are distant from each other by a quarter of an inch or more, no change of intensity will be observed. But if the wire be coiled round a roller or bobbin, so that the successive convolutions may be only separated from each other by the thickness of the silk which covers them, a very remarkable effect will ensue. The spark produced when the extremities of the wire are brought together will still be faint; but that which is manifest when, after having been in contact, they are suddenly separated, will have an incomparably greater length, and a tenfold or even a hundredfold splendour. The shock produced, if the ends of the wire be held in the hands when the contact is broken, has also a great intensity.

1984. *Effects of momentary inductive currents produced upon revolving metallic discs: researches of Arago, Herschel, Babbage, and Faraday.*—It was first ascertained by Arago that if a circular disc of metal revolve round its centre in its own plane under a magnetic needle, the needle will be deflected from the magnetic meridian, and the extent of its deflection will be augmented with the velocity of rotation of the disc. By increasing gradually that velocity, the needle will at length be turned to a direction at right angles to the magnetic meridian. If the velocity of rotation be still more increased, the needle will receive a motion of continuous rotation round its centre in the same direction as that of the disc.

That this fact does not proceed from any mechanical action of the disc upon the intervening stratum of air, is proved by the fact that it is produced in exactly the same manner where a screen of thin paper is interposed between the needle and the disc.

Sir John Herschel and Mr. Babbage made a series of experiments to determine the relative power of discs composed of



different metals to produce this phenomenon. Taking the action of copper, which is the most intense, as the unit, the following are the relative forces determined for discs of other metals:—

Copper	-	-	-	1.00	Lead	-	-	-	0.25
Zinc	-	-	-	0.93	Antimony	-	-	-	0.09
Tin	-	-	-	0.46	Bismuth	-	-	-	0.02

Professor Barlow ascertained that iron and steel act more energetically than the other metals. The force of silver is considerable, that of gold very feeble. Mercury holds a place between antimony and bismuth.

Herschel and Babbage found that if a slit were made in the direction of a radius of the disc it lost a great part of its force; but that when the edges of such a slit were soldered together with any other metal, even with bismuth, which itself has a very feeble force, the disc recovered nearly all its force.

The motion of rotation of the needle is an effect which would result from a force impressed upon it parallel to the plane of the disc and at right angles to its radii. It was also ascertained, however, that the disc exercises on the needle forces parallel to its own plane in the direction of its radii, and also perpendicular to its plane.

A magnetic needle, mounted in the manner of a dipping-needle, so as to play on a horizontal axis in a vertical plane, was placed over the revolving disc, so that the plane of its play passed through the centre of the disc. The pole of the needle which was presented downwards was attracted to or repelled from the centre of the disc according to its distance from that point. Placed immediately over the centre, no effect, either of attraction or repulsion was manifested. As it was moved from the centre along a radius, attraction to the centre was manifested. This attraction was diminished rapidly as the distance from the centre was increased, and, at a certain point, it became nothing, the pole of the needle resting in its natural position. Beyond this distance repulsion was manifested, which was continued even beyond the limits of the disc. These phenomena indicate the action of a force directed parallel to the plane of the disc and in the direction of its radii.

A magnetic needle was suspended vertically by one of its extremities, and, being attached to the arm of a very sensitive balance, was accurately counterpoised. It was then placed suc-

cessively over different parts of the disc, and was found to be every where *repulsed*, whichever pole was presented downwards. These phenomena indicate the action of a repulsive force directed at right angles to the plane of the disc.

All these phenomena have been explained with great clearness and felicity by Dr. Faraday, by the momentary inductive currents produced upon the disc by the action of the poles of the magnet, and the reaction of those currents on the moveable poles themselves. By the principles which have been explained (1977), it will be apparent that upon the parts of the disc which are approaching either pole of the magnet, momentary currents will be produced in directions contrary to those which would prevail upon an electro-magnetic helix substituted for the magnet, and having a similar polarity; while upon the parts receding from the pole, momentary currents will be produced, having the same direction.

These currents will attract or repel the poles of the magnet according to the principles explained and illustrated in (1977); and thus all the motions, and all the attractions and repulsions described above, will be easily understood.

## CHAP. VII.

### INFLUENCE OF TERRESTRIAL MAGNETISM ON VOLTAIC CURRENTS.

1985. *Direction of the earth's magnetic attraction.*—The laws which regulate the reciprocal action of magnets and currents in general being understood, the investigation of the effects produced by the earth's magnetism on voltaic currents becomes easy, being nothing more than the application of these laws to a particular case. It has been shown that the magnetism of the earth is such, that in the northern hemisphere the austral pole of a magnet freely suspended is attracted in the direction of a line drawn in the plane of the magnetic meridian, and inclined below the horizon at an angle which increases gradually in going from the magnetic equator, where it is nothing, to the magnetic pole, where it is  $90^\circ$ . In this part of Europe the direction of the lower pole of the dipping-needle, and therefore

of the magnetic attraction of the earth, is that of a line drawn in the magnetic meridian at an angle of about  $70^\circ$  below the horizon, and therefore at an angle of about  $20^\circ$ , with a vertical line presented downwards.

1986. *In this part of the earth it corresponds to that of the boreal pole of an artificial magnet.* — Now, since the magnetism of the earth in this part of the globe attracts the austral pole of the needle, it must be similar to that of the boreal or southern pole of an artificial magnet (1656). To determine, therefore, its effects upon currents, it will be sufficient to consider it as a southern magnetic pole, placed below the horizon in the direction of the dipping-needle, at a distance so great that the directions in which it acts on all parts of the same current are practically parallel.

1987. *Direction of the force impressed by it upon a current.* — To ascertain the direction, therefore, of the force impressed by terrestrial magnetism on a current, let a line be imagined to be drawn from any point in the current parallel to the dipping-needle, and let a plane be imagined to pass through this line and the current. According to what has been explained of the reciprocal action of magnets and currents, it will follow that the direction of the force impressed on the current will be that of a line drawn through the same point of the current perpendicular to this plane.

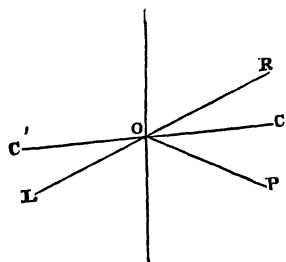

Fig. 625.

Let  $cc'$ , *fig. 625.*, be the line of direction of the current, and draw  $OP$  parallel to the direction of the dip. Let  $LOR$  be a line drawn through  $O$ , at right angles to the plane passing through  $OP$  and  $cc'$ . This line will be the direction of the force impressed by the magnetism of the earth on the current  $cc'$ . If the current pass from  $c$  to  $c'$ , this force will be directed from  $O$  towards  $L$ , since the effect produced is that of a southern magnetic pole placed in the line  $OP$ . If the current pass from  $c'$  to  $c$ , the direction of the force impressed on it will be from  $O$  towards  $R$  (1918).

It follows, therefore, that the force which acts upon the current is always in a plane perpendicular to the dipping-needle. This plane intersects the horizontal plane in a line

directed to the magnetic east and west, and therefore perpendicular to the magnetic meridian; and it intersects the plane of the magnetic meridian in a line directed north and south, making, in this part of the earth, an angle with the horizon of  $20^\circ$  elevation towards the north, and depression towards the south.

1988. *Effect of terrestrial magnetism on a vertical current.*—If the current be vertical, the plane passing through its direction and that of the dipping-needle will be the magnetic meridian. The force impressed upon the current will therefore be at right angles to the plane of the magnetic meridian, and directed *eastward* when the current *descends*, and *westward* when it *ascends*.

1989. *Effect upon a horizontal current directed north and south.*—If the current be horizontal, and in the plane of the magnetic meridian, and therefore directed in the line of the magnetic north and south, the force impressed on it will be directed to the magnetic east and west, and will therefore be also horizontal. It will be directed to the *east*, if the current pass from *north* to *south*; and to the *west*, if it pass from *south* to *north*. This will be apparent, if it be considered that the effect of the earth's magnetism is that of a *south* magnetic pole placed *below the current*.

1990. *Case of an horizontal current directed east and west.*—If the current be horizontal and at right angles to the magnetic meridian, the force impressed on it will be directed north and south in the plane of the magnetic meridian, and inclined to the horizontal plane at an angle of  $20^\circ$  in this part of the earth. This may be resolved into two forces, one vertical and the other horizontal (154). The former will have a tendency to remove the current from the horizontal plane, and the latter will act in the horizontal plane in the direction of the magnetic north and south. It will be directed from the *south* to the *north*, if the current pass from *west* to *east*, and from the *north* to the *south*, if the current pass from *east* to *west*. This will also be apparent, by considering the effect produced upon a horizontal current by a south magnetic pole placed below it.

1991. *Case of a horizontal current in any intermediate direction.*—If a horizontal current have any direction intermediate between the magnetic meridian and a plane at right angles to it, the force impressed on it, being still at right angles

to the dipping-needle, and being inclined to the horizontal plane at an angle less than  $20^\circ$ , may be resolved into other forces (154), one of which will be at right angles to the current, and will be directed to the left of the current, as viewed from below by an observer whose head is in the direction from which the current passes (1918).

1992. *Effect of the earth's magnetism on a vertical current which turns round a vertical axis.*—It follows, from what has been here proved, that if a *descending* vertical rectilinear current be so suspended as to be capable of turning freely round a vertical axis, the earth's magnetism will impress upon it a force directed from west to east in a plane at right angles to the magnetic meridian; and it will therefore move to such a position, that the plane passing through the current and the axis round which it moves shall be at right angles to the magnetic meridian, the current being to the *east* of the axis.

If the current *ascend*, it will for like reasons take the position in the same plane to the *west* of the axis, being then urged by a force directed from *east* to *west*.

1993. *Effect on a current which is capable of moving in a horizontal plane.*—If a vertical current be supported in such a manner that, retaining its vertical direction, it shall be capable of moving freely in a horizontal plane in any direction whatever, as is the case when it floats on the surface of a liquid, the earth's magnetism will impart to it a continuous rectilinear motion in a direction at right angles to the plane of the magnetic meridian, and directed *eastward* if the current *descend*, and *westward* if it *ascend*.

If a horizontal rectilinear current be supported, so as to be capable of revolving in the horizontal plane round one of its extremities as a centre, the earth's magnetism will impart to it a motion of continued rotation, since it impresses on it a force always at right angles to the current, and directed to the same side of it. If in this case the current flow *towards* the centre round which it revolves, the rotation imparted to it will be *direct*; if *from* the centre, retrograde, as viewed from above (1920).

1994. *Experimental illustrations of these effects.*—*Pouillet's apparatus.*—A great variety of experimental expedients have been contrived to verify these consequences of the principle of the influence of terrestrial magnetism on currents.

To exhibit the effects of the earth's magnetism on vertical currents, M. Pouillet contrived an apparatus consisting of two circular canals, represented in their vertical section in *fig.* 626.,

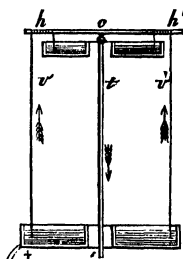

Fig. 626.

one placed above the other, the lower canal having a greater diameter than the upper. In the opening in the centre of these canals a metallic rod  $t$  is fixed in a vertical position, supporting a mercurial cup  $c$ . A rod  $hh'$ , composed of a non-conducting substance, is supported in the cup  $c$  by a point at its centre. The vertical wires  $vv'$  are attached to the ends of the rod  $hh'$ , and terminate in points, which are turned downwards, so as to dip into the liquid contained in the upper canal, while their lower extremities dip into the liquid contained in the lower canal. A bent wire connects the mercury contained in the cup  $c$  with the liquid in the upper canal.

The liquid on the upper and lower canals is acidulated water or mercury. If the liquid in the lower canal be put in communication with the positive, and the rod  $t$  with the negative pole, the current will pass from that canal up the two vertical wires  $vv'$ , thence to the liquid in the upper canal, thence by the connecting wire to the mercury in the cup  $c$ , and thence by the rod  $t$  to the negative pole.

By this arrangement the two vertical currents  $vv'$ , which both ascend, are moveable round the rod  $t$  as an axis.

When this apparatus is left to the influence of the earth's magnetism, the currents  $vv'$  will be affected by equal and parallel forces directed westward at right angles to the magnetic meridian (1988). The equal and parallel forces being at equal distances from the axis  $t$ , will be in equilibrium in all positions (421), and the wires will therefore be astatic (1695).

If the point of the wire  $v'$  at  $h'$  be raised from the upper canal, the current on  $v'$  will be suspended. In that case, the wire  $v$  being impelled by the terrestrial magnetism westward at right angles to the magnetic meridian, the system will take a position at right angles to that meridian, the wire on which the current passes being to the west of the axis  $t$ . If the point at  $h'$  be turned down so as to dip into the liquid, and the point at  $h$  be turned up so as to suspend the current on  $h$  and establish

that on  $h'$ , the system will make half a revolution and will place the wire  $h'$  on which the current runs to the west of  $t$ .

If by the *reotrope* the connexions with the poles of the battery be reversed, the currents on  $vv'$  will descend instead of ascending. In that case the system will be astatic as before, so long as both currents are established on the wires  $vv'$ . But if the connexion of either with the superior canal be removed, the wire on which the remaining current passes being impelled eastwards, the system will take a position in the plane of the magnetic meridian, the wire on which the current runs being east of the axis  $t$ .

When the currents on the wires  $vv'$  are both passing, the system will be astatic only so long as the currents are equally intense, and both in the same plane with the axis  $t$ . If while the latter condition is fulfilled one of the wires be even in a small degree thicker than the other, it will carry a stronger current, and in that case it will turn to the magnetic east or west, according as the currents descend or ascend, just as though the current on the other wire were suppressed; for in this case the effective force is that due to the difference of the intensities of the currents acting on that which is the stronger.

If the two wires be not in the same plane with the axis, the forces which act upon them being equal, and parallel to the plane of the magnetic meridian, the position of equilibrium will be that in which the plane passing through them will be parallel to the latter plane.

The position of equilibrium will be subject to an infinite variety of changes, according as the plane of the wires  $vv'$ , their relative thickness, and their distances from the axis of rotation are varied, and in this way a great number of interesting experiments on the effects of the earth's magnetism may be exhibited.

1995. *Its application to show the effect of terrestrial magnetism on a horizontal current.*—To show experimentally the effect of the earth's magnetism on a horizontal current, M. Pouillet contrived an arrangement on a similar principle,

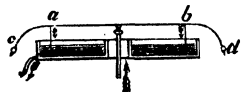

Fig. 627.

consisting of a circular canal, the vertical section of which is represented in *fig. 627*. A horizontal wire  $ab$  is supported by a point at its centre which rests in a mercurial cup fixed upon a

metallic rod, like *t*, *fig.* 626. Two points, *a* and *b*, project from the wire and dip into the liquid in the canal, the small weights *c* and *d* being so adjusted as to keep the wire *ab* exactly balanced.

If the central rod be connected with the positive, and the liquid in the canal with the negative pole, the current will ascend on the central rod, and will pass along the horizontal wire in both directions from its centre to the points *a* and *b*, by which it will pass to the liquid in the canal, and thence to the negative pole. If by the reotrope the connexions be reversed and the names of the poles changed, the current will pass from *a* and *b* to the centre, and thence by the central rod to the negative pole.

In the former case, the wire *ab* will revolve with *retrograde*, and in the latter with *direct* rotation, in accordance with what has been already explained (1918).

1996. *Its effect on vertical currents shown by Ampère's apparatus.*—If a rectangular current, such as that represented in *fig.* 595., be suspended in Ampère's frame, *fig.* 564., it will, when left to the influence of terrestrial magnetism, take a position at right angles to the magnetic meridian, the side on which the current descends being to the east. For in this case the horizontal currents which pass on the upper and lower sides of the rectangle, being contrary in direction, will have a tendency to revolve, one with direct, and the other with retrograde motion round *yy'*. These forces, therefore, neutralize each other. The vertical descending current will be attracted to the east, and the ascending current to the west (1992).

1997. *Its effect on a circular current shown by Ampère's apparatus.*—If a circular current, such as that represented in *fig.* 594., be suspended in Ampère's frame, *fig.* 564., and submitted to the influence of terrestrial magnetism, each part of it may be regarded as being compounded of a vertical and horizontal component. The horizontal components in the upper semicircle, flowing in a direction contrary to those in the lower semicircle, their effects will neutralize each other. The vertical components will descend on one side and ascend on the other. That side on which they *descend* will be attracted to the *east*, and that at which they *ascend* to the *west*; and, consequently, the current will place itself in a plane at right angles to the magnetic meridian, its front being presented to the south.

1998. *Its effect on a circular or spiral current shown by*



*Delarive's floating apparatus.*—If a circular or spiral current be placed on a floating apparatus, it will assume a like position at right angles to the magnetic meridian, with its point to the south; and the same will be true of any circulating current.

1999. *Astatic currents formed by Ampère's apparatus.*—To construct a system of currents adapted to Ampère's frame, which shall be astatic, it is only necessary so to arrange them that there shall be equal and similar horizontal currents running in contrary directions, and equal and similar vertical currents in the same direction, and that the latter shall be at equal distances from the axis on which the system turns; for in that case the horizontal elements, having equal tendencies to make the system revolve in contrary directions, will equilibrate, and the vertical elements being affected by equal and parallel forces at equal distances from the axis of rotation, will also equilibrate.

By considering these principles, it will be evident that the system of currents represented in *fig. 628.*, adapted to Ampère's frame, *fig. 564.*, is astatic.

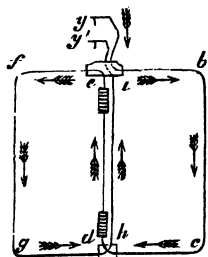

Fig. 628.

2000. *Effect of earth's magnetism on spiral currents shown by Ampère's apparatus.*—If the arrangement of spiral currents represented in *fig. 605.* be so disposed that the current after passing through one only of the two spirals shall return to the negative pole, the earth's magnetism will affect it so as to bring it into such a

position that its plane will be at right angles to the magnetic meridian. If the descending currents be on the side of the spiral more remote from the axis of motion, the system will arrange itself so that the spiral on which the current flows shall be to the *east* of the axis. If the descending currents be on the side nearer to the axis, the spiral on which the current flows will throw itself to the *west* of the axis. In each case, the front of the current is presented to the magnetic south, and the descending currents are on the east side of the spiral.

If the current pass through both spirals in *fig. 605.*, and their fronts be on the same side, the earth's magnetism will throw them into the plane at right angles to the magnetic meridian, their fronts being presented to the south.

If their fronts be on different sides, the system will be astatic, and will rest in any position independent of the earth's magnetism, which in this case will produce equal and contrary effects on the two spirals.

If the system of spiral currents represented in *fig.* 606. be suspended in Ampère's frame, subject to the earth's magnetism, the fronts of the currents being on the same side of the two spirals, it will take such a position that the centres of the two spirals will be in the magnetic meridian, their planes at right angles to it, and the fronts of the currents presented to the south. If in this case the fronts of the currents be on opposite sides, the system will be astatic.

2001. *Effect on an horizontal current shown by Pouillet's apparatus.* — The rotation of the horizontal current produced with the apparatus *fig.* 627., may be accelerated, retarded, arrested, or inverted by presenting the pole of an artificial magnet above or below it, at a greater or less distance. A south magnetic pole placed below it, or a north magnetic pole above, producing forces identical in direction with those produced by terrestrial magnetism, will accelerate the rotation in a greater or less degree, according to the power of the artificial magnet, and the greater or less proximity of its pole to the centre of rotation of the current.

A north magnetic pole presented below, or a south pole above the centre of rotation, producing forces contrary in their direction to those resulting from the earth's magnetism, will retard, arrest, or reverse the rotation according as the forces exerted by the magnet are less than, equal to, or greater than those impressed by terrestrial magnetism.

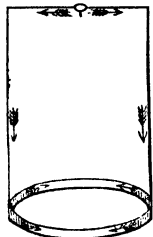

Fig. 629.

If the system of currents represented in *fig.* 629. be suspended on Pouillet's apparatus, represented in *fig.* 626., it will receive a motion of continued rotation from the influence of the earth's magnetism. In this case the vertical currents being in the same direction will be in equilibrium (1994); and the horizontal currents passing either from the centre of the upper horizontal wire to the extremities, or *vice versâ*, according to the mode of connexion, will receive a motion of rotation direct or retrograde (1995). This motion of rotation may be affected in the manner above described by the

pole of a magnet applied in the centre of the lower circular canal, *fig. 626*.

2002. *Effect of terrestrial magnetism on an heliacal current shown by Ampère's apparatus.* — An heliacal current such as that represented in *fig. 608.*, being mounted on Ampère's frame, or arranged upon a floating apparatus, *fig. 609.*, will be acted on by the earth's magnetism. The several convolutions will, like a single circulating current, take a position at right angles to the magnetic meridian, their fronts being presented to the south. The axis of the helix will consequently be directed to the magnetic north and south; and it will, in fine, exhibit all the directive properties of a magnetic needle, the end to which the front of the currents is directed being its south pole.

If such a current were mounted on a horizontal axis at right angles to the plane of the magnetic meridian, it would, under the influence of the earth's magnetism, take the direction of the dipping-needle, the front of the currents corresponding in direction to the south pole of the needle.

2003. *The dip of a current illustrated by Ampère's rectangle.* — The phenomenon of the dip may also be experimentally illustrated by Ampère's electro-magnetic rectangle, *fig. 630.*, which consists of a horizontal axis *xv*, which is a tube of wood or other non-conductor, at right angles to which is fixed a

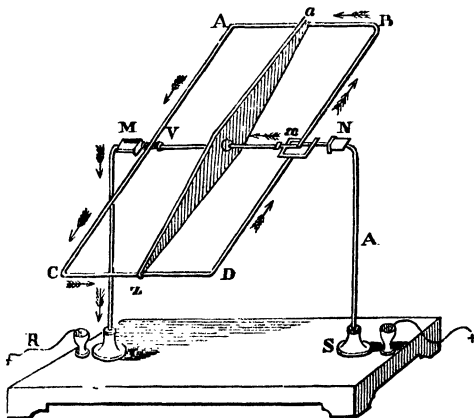

Fig. 630.

lozenge-shaped bar  $az$ , composed also of a non-conductor. Upon this cross is fixed the rectangle  $ABDC$ , composed of wire. The rectangle rests by steel pivots at  $M$  and  $N$  on metallic plates, which communicate by wires with the mercurial cups at  $s$  and  $r$ . These latter being placed in connexion with the poles of a voltaic battery, the current will pass from the positive cup  $s$  up the pillar and round the rectangle, as indicated by the arrows. At  $x$  it passes along a wire through the tube  $xv$  to  $v$ , and thence by the steel point, the plate  $M$ , and the pillar, to the negative cup  $r$ .

The axis  $MN$  being placed at right angles to the magnetic meridian, and the connexions established, the rectangle will be immediately affected by the earth's magnetism, and after some oscillations, will settle into a position at right angles to the direction of the dipping-needle.

In this case the forces impressed by the earth's magnetism on the parts of the current forming the sides  $AC$  and  $BD$ , will pass through the axis  $MN$ , and will therefore be resisted. The forces impressed on  $AB$  and  $CD$  will be equal, and will act at the middle points  $a$  and  $z$ , at right angles to  $AB$  and  $CD$ , and in a plane at right angles to the direction of the dip. These forces will therefore be in directions exactly opposed to each other when the line  $az$  takes the direction of the dip, and will therefore be in equilibrium.

## CHAP. VIII.

### RECIPROCAL INFLUENCE OF VOLTAIC CURRENTS.

2004. *Results of Ampère's researches.* — The mutual attraction and repulsion manifested between conductors charged with the electric fluids in repose, would naturally suggest the inquiry whether any analogous reciprocal actions would be manifested by the same fluids in motion. The experimental analysis of this question led Ampère to the discovery of a body of phenomena which he had the felicity of reducing to general laws. The mathematical theory raised upon these laws has supplied the means by which phenomena, hitherto scattered and unconnected,

and ascribed to a diversity of agents, are traced to a common source.

Although the limits within which a treatise so elementary as this manual is necessarily confined excludes any detailed exposition of these beautiful physico-mathematical researches, they cannot be altogether passed over in silence. We shall therefore give as brief an exposition of them as is compatible with their great importance, and that clearness without which all exposition would be useless.

2005. *Reciprocal action of rectilinear currents.*—If two rectilinear currents be parallel, they will attract or repel each other according as they flow in the same or opposite directions.

This is verified experimentally by the apparatus represented in *fig. 631.*, which is on the principle of Ampère's frame. The

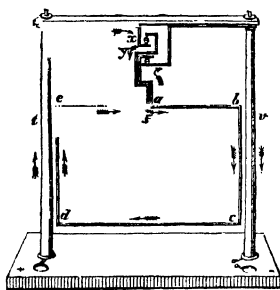

Fig. 631.

mercurial cup marked + receives the current from the positive pole. The current passes as indicated by the arrows upwards on the pillar *t*, and thence to the cup *x*, from which it flows round the rectangle, returning to the cup *y*, and thence to the pillar *v*, by which it descends to the cup, which is connected with the negative pole.

If the rectangle thus arranged be placed with its plane at any angle with the plane of the pillars *t* and *v*, upon which the ascending and descending currents pass, it will turn upon its axis until its plane coincides with the plane of the pillars *t* and *v*, the side of the rectangle *de* on which the current ascends being next the pillars *t*, on which it ascends. If by means of the *reotrope* (1911) the connexion be reversed, so that the current shall descend on *t* and *de*, and shall ascend on *v* and *bc*, it will still maintain its position. But if the connexions at *x* and *y* be reversed, the connexions of the cups + and - remaining unchanged, the current will descend on *ed* while it ascends on *t*, and will ascend on *bc* while it descends on *v*. In this case *t* will repel *de* and attract *bc*, and *v* will repel *bc* and attract *de*, and accordingly the rectangle will make a half revolution, and *bc* will place itself near *t*, and *de* near *v*.

2006. *Action of a spiral or heliacal current on a rectilinear*

*current.*—A sinuous, spiral, or heliacal current, provided its convolutions are not considerable in magnitude, impresses on another current in its neighbourhood the same force as a straight current would produce, whose direction would coincide with the axis of the sinuous or spiral current. This is proved experimentally by the fact that a spiral current which has a returning straight current passing along its axis, will exercise no force either of attraction or repulsion on a straight current parallel to it. Now since on suspending the spiral current the straight current will attract or repel a parallel straight current, it follows that the spiral current exactly neutralizes the effect of the straight current flowing in the opposite direction, and consequently it will be equivalent to a straight current flowing in the same direction.

2007. *Mutual action of diverging or converging rectilinear currents.*—Rectilinear currents which diverge from or converge to a common point mutually attract. Those, one of which diverges, and the other converges, mutually repel; that is to

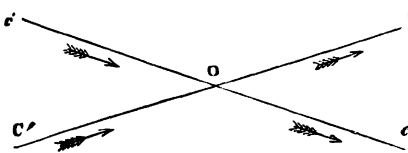

Fig. 632.

say, if two rectilinear currents  $cc'$  and  $cc'$ , *fig. 632.*, which intersect at  $o$ , both flow towards or from  $o$ , they will mutually attract; but if one flow towards, and the other from  $o$ , they will mutually repel. The currents, being supposed to flow in the direction of the arrows,  $oc$  and  $oc'$  will mutually attract, as will also  $oc'$  and  $oc$ ; while  $oc'$  and  $oc$  will repel, as will also  $oc$  and  $oc'$ .

If the wires conducting the currents were moveable on  $o$  as a pivot, they would accordingly close, the angle  $c'oc$  diminishing until they would coincide.

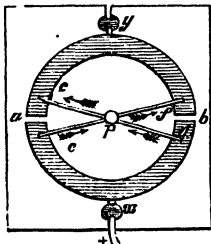

Fig. 633.

2008. *Experimental illustration of this.*—This may be experimentally illustrated by the apparatus represented in *fig. 633.* in plane, and in *fig. 634.* in section, consisting of a circular canal filled with mercury or acidulated water separated into two parts by partitions at  $a$  and  $b$ . Two wires  $cd$  and  $ef$ , suspended

on a central pivot, move freely one over and independent of the other, like the hands of a watch, the points being at right angles, so as to dip into the canal. The mercurial cup  $x$  being supposed to be connected with the positive, and  $y$  with the negative pole, the current passing to the



Fig. 634.

liquid will flow along the wires as indicated by the arrows from the liquid in one section to that of the other, and will pass to the negative cup  $y$ . When the wires  $cd$  and  $ef$  thus carrying the current are left to their mutual influence, the angle they form will close, and the directions of the wires will coincide, so that the currents shall flow in the same direction upon them.

In these and all similar experiments, the phenomena will necessarily be modified by the effects produced by the earth's magnetism. In some cases the apparatus can be rendered astatic (1695); and in others, the effect due to the terrestrial magnetism being known, can be allowed for, so that the phenomena under examination may be eliminated.

2009. *Mutual action of rectilinear currents which are not in the same plane.*—If two rectilinear currents be not in the same plane, their directions cannot intersect although they are not parallel. In this case a line may always be drawn, which is at the same time perpendicular to both. To assist the imagination in conceiving such a geometrical combination, let a vertical rod be supposed to be erected, and from two different points of this rod let lines be drawn horizontally, but in different directions, one, for example, pointing to the north, and the other to the east. If voltaic currents pass along two such lines, they will mutually attract, when they flow *both to* or *both from* the vertical rod; they will mutually repel, when one flows *to* the vertical rod and the other *from* it.

In either case the mutual action of such currents will have a tendency to turn them into the same plane and to parallelism.

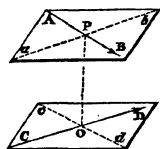

Fig. 635.

If they mutually attract, their lines of direction turning round the vertical line will take a position parallel to each other, and at the same side of that line. If they mutually repel, they will turn on the vertical line in contrary directions, and will take a position parallel to each other, but at opposite sides of it.

In *fig. 635.*,  $AB$  and  $CD$  represent two currents which are not in

the same plane. Let  $PO$  be the line which intersects them both at right angles, and let planes be supposed to pass through their directions respectively, which are parallel to each other, and at right angles to  $PO$ . If, in this case,  $CD$  be fixed and  $AB$  moveable, the latter will be turned into the direction  $ab$  parallel to  $CD$ ; or if  $CD$  were free and  $AB$  fixed,  $CD$  would take the position  $cd$ ; if both were free they would take some position parallel to each other; and if free to change their planes, they would mutually approach and coalesce. It follows from this, that if the direction of either of the two currents be reversed, the directions of the forces they exert on each other will be also reversed; but if the directions of both currents be reversed, the forces they exert on each other will be unaltered.

2010. *Mutual action of different parts of the same current.*—Different parts of the same current exercise on each other a repulsive force. This will follow immediately as a consequence of the general principle which has been just established. Since a repulsive action takes place between  $oc$  and  $oc'$ , *fig. 632.*, and such action is independent of the magnitude of the angle  $coc'$ , it will still take place, however great that angle may be, and will therefore obtain when the angle  $oc'c$  becomes equal to  $180^\circ$ ; that is, when  $oc'$  forms the continuation of  $CO$ , or coalesces with  $oc'$ . Hence, between  $oc$  and  $oc'$  there exists a mutually repulsive action.

2011. *Ampère's experimental verification of this.*—Independently of this demonstration, M. Ampère has reduced the repulsive action of different parts of the same rectilinear current to the following experimental proof:—

Let  $ABCD$ , *fig. 636.*, be a glass or porcelain dish, separated into two divisions by a partition  $AC$ , also of glass; and let it be

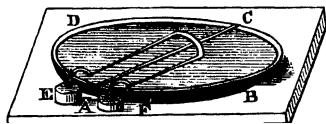

Fig. 636.

filled with mercury on both sides of  $AC$ . Let a wire, wrapped with silk, be formed into two parallel pieces united, by a semicircle whose plane is at right angles to that of the straight parallel parts, and let these two parallel straight parts be placed floating on the surface of the mercury at each side of the partition  $AC$ , over which the semicircle passes. The mercury in the divisions of the dish is in metallic communication with the mercurial cups  $E$  and  $F$  placed in the direction of



the straight arms of the floating conductor. When the cups **E** and **F** are put in connexion with the poles of a voltaic battery, a current will pass from the positive cup to the end of the floating conductor, from that along the arm of the conductor, then across the partition by the semicircle, then along the other floating arm, and from thence through the mercury to the negative cup. There is thus on each side of the partition a rectilinear current, one part of which passes upon the mercury, and the other part upon the straight arm of the floating conductor. When the current is thus established, the floating conductor will be repelled to the remote side of the dish. This repulsion is effected by that part of the straight current which passes upon the mercury acting on that part which passes along the wire.

2012. *Action of an indefinite rectilinear current on a finite rectilinear current at right angles to it.*—A finite rectilinear current *ab*,

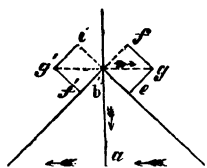

Fig. 637.

*fig. 637.*, which is perpendicular to an indefinite rectilinear current *cd* lying all at the same side of it, will be acted on by a force tending to move it parallel to itself, either in the direction of the indefinite current, or in the contrary direction, according to the relative di-

rections of the two currents.

If the finite current do not meet the indefinite current, let its line of direction be produced till it meets it at *a*. Take any two points *c* and *d* on the indefinite current at equal distances from *a*, and draw the lines *cb* and *db* to any point on the finite current.

*First case.* Let the finite current be directed *towards* the indefinite current. Hence the point *b* will be attracted by *d* and repelled by *c* (2007); and since  $db = cb$ , the attraction will be equal to the repulsion. Let the equal lines *be* and *bf* represent this attraction and repulsion. By completing the rectangle, the diagonal *bg* will represent the resultant of these forces; and this line *bg* is parallel to *cd*, and the resultant is contrary in direction to the indefinite current.

The same may be proved of the action of all points on the indefinite current on the point *b*, and the sum of all these resultants will be the total action of the indefinite current on *b*.

The same may be proved respecting the action of the definite current on all the points of the indefinite current.

Hence the current  $ab$  will be urged by a system of forces acting at all its points parallel to  $cd$ , and in a contrary direction.

*Second case.* Let the finite current be directed *from* the indefinite current. The point  $b$  will then be attracted by  $c$  and repelled by  $d$ , and the resultant  $bg'$  will be contrary to its former direction.

Hence the current  $ab$  will be urged by a system of forces parallel to  $cd$ , and in the same direction as the indefinite current.

Since the action of the two currents is reciprocal, the indefinite current will be urged by a force in its line of direction, either according or contrary to its direction, as the finite current runs *from* or *towards* it.

2013. *Case in which the indefinite current is circular.*—If the indefinite current  $cd$  be supposed to be bent into a circular form so as to surround a cylinder, on the side of which is placed the vertical current  $ab$ , it is evident that the same reciprocal action will take place; but in that case the motion imparted will be one of rotation round the axis of the cylinder as a centre.

2014. *Experimental verification of these principles.*—These principles are experimentally verified by the apparatus, *fig. 638.*,

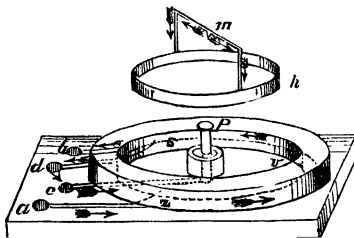

Fig. 638.

where  $azsb$  represents a ribbon of copper coated with silk and carried round the copper circular canal  $v$ . A conductor connects the mercurial cup  $c$  with the central metallic pillar which supports a mercurial cup  $p$ . In this cup the metallic point  $m$  is placed. The mercurial cup  $d$  is in metallic communication

with the acidulated water in the circular canal  $v$ . A hoop of metal  $h$  is supported by the point  $m$  by means of the rectangular wire, and is so adjusted that its lower edge dips into the liquid in the canal  $v$ .

Let the mercury in  $a$  be connected with the positive pole of the battery, and the mercury in  $d$  with the negative pole. The current entering at  $a$  will pass round the circular canal upon

the coated ribbon of copper, and, arriving at *b*, it will pass to *c* by a metallic ribbon or wire connecting these cups. From *c* it will pass to the central pillar, and thence to the cup *p*. It will then pass from *m* as a centre in both directions on the wire, and will descend to the hoop *h*, from which it will pass into the liquid in the canal *v*, and thence to the cup *d*, with which the liquid is in metallic communication, and, in fine, from *d* it will pass to the negative pole of the battery.

By this arrangement, therefore, a circular current flows round the exterior surface of the vase *v*, while two descending currents constantly flow upon the wire at right angles to this circular current. The circular current being fixed, and the vertical currents being moveable, the latter will receive a motion of continued rotation by the action of the former; and in the case here supposed, this rotation will be in a direction contrary to the direction of the circular current. If the connexions be reversed by the reotrope, the direction of the circular current will be reversed, but at the same time that of the vertical currents on the wire will be also reversed; and, consequently, no change will take place in the direction of the rotation. These changes of direction of the two currents neutralize each other. But if, while *d* is still connected with the negative pole, *b* be connected with the positive pole, the connexion between *b* and *c* being removed, and a connexion between *a* and *c* being established, then the direction of the circular current being from *s* to *z* will be reversed; while that of the vertical currents remains still the same, the direction of the rotation will be reversed.

2015. *To determine in general the action of an indefinite rectilinear current on a finite rectilinear current.*—*First.* Let

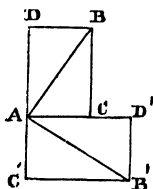

Fig. 639.

it be supposed that the finite current *AB*, *fig. 639.*, has a length so limited that all its points may be considered as equally distant from the indefinite current, and therefore equally acted on by it. In this case the current *AB* may be replaced by two currents, *AD* perpendicular and *AC* parallel to the indefinite current, and the action of the indefinite current on *AB* will be equivalent to its combined actions on *AD* and *AC*.

If *A* be supposed to be the positive end of the finite current, it will also be the positive end of the component currents *AD*

and  $AC$ . Supposing the indefinite current parallel to  $AC$  to run in the same direction as  $AC$ , then  $AD$  will be urged in the direction  $AC$  (2012), and  $AC$  in the direction  $AC'$ , by forces proportional to  $AD$  and  $AC$ . Hence, if  $AD' = AD$ , and  $AC' = AC$ ,  $AD'$  and  $AC'$  will express in magnitude and direction the two forces which act on the component currents. The resultant of these two forces  $AD'$  and  $AC'$  will be the diagonal  $AB'$ , which is evidently perpendicular to  $AB$  and equal to it.

*Secondly.* Let the finite current have any proposed length, and from its positive end  $A$ , *fig.* 640., let a line  $AO$  be drawn perpendicular to the indefinite current  $x'x$ , this current being supposed to run from  $x'$  to  $x$ .

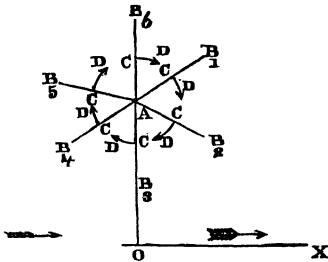

Fig. 640.

If the distance  $OA$  be greater than  $AB$ , that current  $AB$ , whatever be its position, will lie on the same side of  $x'x$ , and the action of  $x'x$  on every small element of  $AB$  will be perpendicular to  $AB$ , as has been just demonstrated.

The current  $AB$  will therefore be acted on by a system of parallel forces perpendicular to its direction. The resultant of these forces will be a single force equal to their sum, and parallel to their common direction. Hence the indefinite current  $x'x$  will act on the finite current  $AB$  by a single force  $R$  in the direction  $CD$ .

If the current  $AB$  be supposed to assume successively different positions,  $B_1, B_2, B_3, \&c.$ , around its positive end  $A$ , the line  $CD$  will represent in each position the direction of the action of the current  $x'x$  upon it.

It is evident that when the indefinite current runs from  $x'$  to  $x$ , the action on the finite current is such as would cause it to turn round its positive end  $A$  with a direct, or round its negative end  $B$  with a retrograde rotation.

If the indefinite current run from  $x$  to  $x'$ , the direction of its action on  $AB$ , and the consequent motions of  $AB$ , would be reversed.

The point  $C$  of the current  $AB$  at which the resultant  $R$  acts will vary with the position of the current  $AB$ , approaching more towards  $x'x$  as  $AB$  approaches the position  $AB_3$ ; but in every position this resultant must be between  $A$  and  $B$ . The force

producing the rotation therefore having a varying moment, the rotation will not be uniform.

If the distance  $OA$  be very great compared with  $AB$ , the resultant  $R$  will be sensibly constant, and will act at the middle point of  $AB$ .

In this case, if the middle point of  $AB$  be fixed, no rotation can take place.

If the distance  $OA$  be less than  $AB$ , the current  $AB$  will in certain positions intersect  $x'x$ , *fig.* 641., and a part will be at

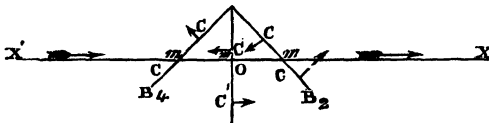

Fig. 641.

one side and a part at the other. In this case the action on  $AB$ , in all positions in which it lies altogether above  $x'x$ , is the same as in the former case.

When it crosses  $x'x$ , as in the positions  $AB_2$ ,  $AB_3$ ,  $AB_4$ , the action is different. In that case the forces which act on  $Am$ , and those which act on  $mB$ , are in contrary directions, and their resultant is in the one direction or in the other, according as the sum of the forces acting on one part is greater or less than the sum of the forces acting on the other part. If  $Am$  be in every position of  $AB$  greater than  $mB$ , then the resultant will be in every position in the same direction as if the current  $AB$  did not cross  $x'x$ ; and if the point  $A$  were fixed, a motion of continued rotation would take place, in the same manner as in the former case, except that the impelling force would be diminished as the line  $AB$  would approach the position  $AB_3$ .

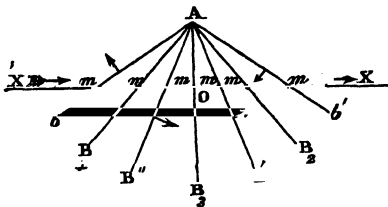

Fig. 642.

But if  $AO$  be less than half  $AB$ , the circumstances will be different. In that case there will be two positions  $AB_2$  and  $AB_4$ , *fig.* 642., at equal distances from  $AB_3$ , at which the line  $AB$  will be bisected by  $x'x$ .

In all positions of  $AB$  not included between  $AB_2$  and  $AB_4$ ,

the action of the indefinite current upon it takes place in the same direction as in the former cases.

But in the positions  $AB'$  and  $AB''$ , where  $mB'$  and  $mB''$  are greater than  $mA$ , the forces acting on  $mB'$  and  $mB''$  exceed those acting in the contrary direction on  $mA$ , and consequently the resultant of the forces on  $AB$  in all positions between  $AB_2$  and  $AB_4$  is contrary to its direction in every other position of the line  $AB$ .

In the positions  $AB_2$  and  $AB_4$  the resultant of the forces in one direction on  $Am$  is equal and contrary to the resultant of the forces on  $Bm$ . There will in these positions be no tendency of the current  $AB$  to move except round its middle point.

If the indefinite current  $x'x$  pass through  $A$ , *fig. 643.*, the resultants of its action on  $AB$  will be in contrary directions above and below  $x'x$ , and will in each case tend to turn the current  $AB$  round the point  $A$  so as to make it coincide in direction with the indefinite current  $x'x$ .

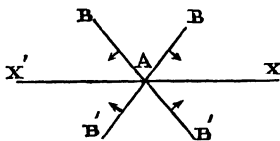

Fig. 643.

2016. *Experimental illustration of these principles.*— These effects may be illustrated experimentally by means of the apparatus, *fig. 638.*, already described. The circular current surrounding the canal  $v$  being removed, and the currents on the wire  $m$  being continued, let an indefinite rectilinear current be conducted under the apparatus at different distances from the vertical line passing through the pivot, and the effects above described will be exhibited.

2017. *Effect of a straight indefinite current on a system of diverging or converging currents.*— If any number of finite rectilinear currents diverge from or converge to a common centre, the system will be affected by an indefinite current near it, in the same manner as a single radiating current would be affected.

Thus if a number of straight and equal wires have a common extremity, and are traversed by currents flowing between that extremity, and the circumference of the circle in which their other extremities lie, an indefinite current  $x'x$  placed in the plane of the circle, as represented in *fig. 644.*, will cause the radiating system of currents to revolve in the one direction or the other, as indicated by the arrows in the figures.

2018. *Experimental illustration of this action.*— These actions may be shown experimentally, by putting a vertical

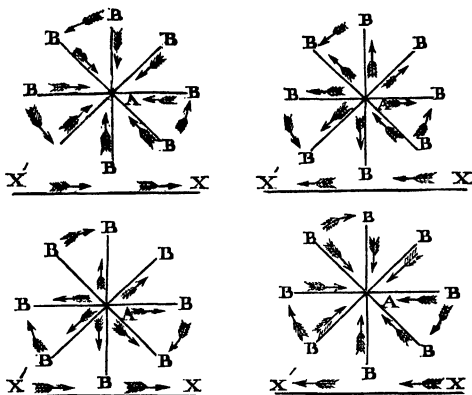

Fig. 644.

wire, *fig. 645.*, in communication with the centre of a shallow circular metallic vessel of mercury *v*, and another wire *N*, communicating with the outside of the vessel, into communication with the poles of a battery: diverging currents will be transmitted through the mercury in the one direction or the other, according to the connexion; and if a straight conducting wire *CD*, conveying a powerful electric current, is brought near the vessel, a rotation will be imparted to the mercury, the direction

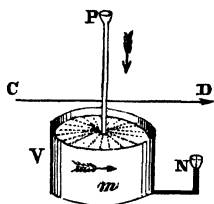

Fig. 645.

of which will be in conformity with the principles just explained. Davy used a powerful magnet instead of the straight wire.

2019. *Consequences deducible from this action.*— The following consequences respecting the action of finite and indefinite rectilinear currents will readily follow from the principles which have been established.

When a finite vertical conductor *AB*, moveable round an axis *oo'*, is subjected to the action of an indefinite horizontal current *mn*, the plane *ABO'o* will place itself in the position *o'o'b'a'*, when the vertical current descends, and the horizontal current runs from *N* to *M*, *fig. 646.*

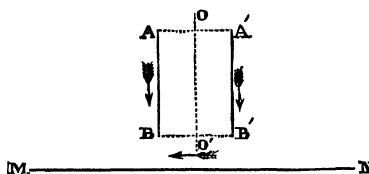

Fig. 646.

When two vertical conductors  $AB$  and  $A'B'$  are moveable round a vertical axis  $OO'$ , and connected together, they will remain in equilibrium, whatever be their position, if they are both traversed by currents of the same intensity in the same direction, provided that the indefinite rectilinear current which acts upon them be at such a distance and in such a position that its distances from the points  $B$  and  $B'$  may be considered always equal. When the wires  $AB$  and  $A'B'$  are traversed by currents in opposite directions, one ascending and the other descending, the system will then turn on its axis  $OO'$  until the vertical plane through  $AB$  and  $A'B'$  becomes parallel to  $MN$ , the descending current being on that side from which the indefinite current flows.

2020. *Action of an indefinite straight current on a circulating current.*—The circulating current,  $A$ , fig. 647., is affected by the

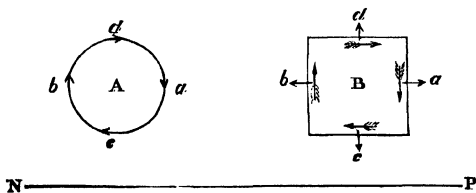

Fig. 647.

indefinite current  $PN$  in the same manner as would be affected the rectangular current  $B$ . The current  $PN$  affects the *descending* side  $a$  by a force *contrary* to, and the ascending side  $b$  by an equal force *according* with, its own direction (2012). In the same manner it affects the sides  $c$  and  $d$  with forces in contrary directions, one *towards*, and the other *from*,  $PN$ . But the side  $c$ , being nearer to  $PN$  than  $d$ , is more strongly affected;



and consequently the attraction, in the case represented in *fig. 646.*, will prevail over the repulsion. If the direction of either the rectilinear or circulating current be reversed, the repulsion will prevail over the attraction.

Thus it appears, that an indefinite current flowing from *right to left*, under a circulating current having *direct* rotation, or one moving from left to right under a circulating current having retrograde rotation, will produce attraction; and two currents moving in the contrary directions will produce repulsion.

If the current *A* be fixed upon an horizontal axis *ab* on which it is capable of revolving, that side *c* at which the current moves in the same direction as *PN* will be attracted downwards, and the plane of the current will take a position passing through *PN*, the side *c* being nearest to that line.

If the current *A* be fixed upon the line *cd* as an axis, it will turn into the same position, the side *b* on which the current ascends being on the side towards which the current *PN* is directed.

2021. *Case in which the indefinite straight current is perpendicular to the plane of the circulating current.*—If the rectilinear

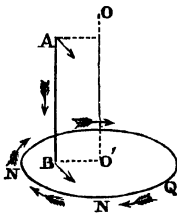

Fig. 648.

current *AB*, *fig. 648.*, be perpendicular to the circular current *QNN*, and within it, and be moveable round the central line *oo'*, a motion of rotation will be impressed upon it contrary to that of the circular current. This

may be experimentally verified by an apparatus constructed on the principles represented in *fig. 649.*, consisting of a wire frame supported and balanced on a central point in a mercurial cup. The current passing between this point and the liquid in a circular canal will ascend or descend on the vertical wires according to the arrangement of the connexions. The circular current may be produced by surrounding the circular canal with a metallic wire, or ribbon coated with a non-conductor, upon which the current may be transmitted in the usual way. The wire frame will revolve upon the central point with direct or retrograde rotation, according to the directions of the currents. If the current

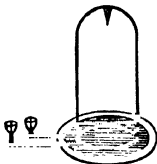

Fig. 649.

ascend on the wires, they will revolve in the same direction as the circular current; if it descend, in the contrary direction.

The circular current may also be produced by a spiral current placed under the circular canal, and the wire frame may be replaced by a light hollow cylinder, supported on a central point. The spiral in this case may be moveable and the cylinder fixed, or *vice versâ*, and the reciprocal actions will be manifested.

2022. *Case in which the straight current is oblique to the plane of the circulating current.*—Like effects will be produced

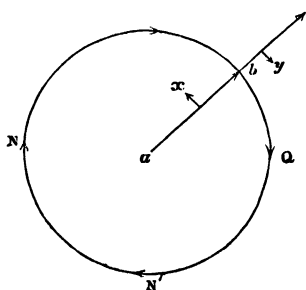

Fig. 650.

when the rectilinear current, instead of being perpendicular to the plane of the circular current, is oblique to it.

Let the rectilinear current *ac*, *fig. 650.*, be parallel to the plane of the circular current *NQ*. If the current flow from *a* to *c*, the part *ab* which is within the circle will be affected by force opposite to the direction of the nearest part of the current *NQ*, and the part *bc* outside the circle will be affected by a force in the same direction. If the current flow from *c* to *a*, contrary effects will ensue.

If in this case the straight current be limited to *ab*, and be capable of revolving round *a* in a plane parallel to that of the circle, it will receive a motion of rotation in the same or in a contrary direction to that of the circulating current, accordingly as it flows from *b* to *a*, or from *a* to *b*. If the straight current be limited to *bc*, it will, under the circumstances, receive rotation in the contrary direction. If, in fine, it extend on both sides of the circle, it will rotate in the one direction or the other, according as the internal or external part predominates.

2023. *Reciprocal effects of curvilinear currents.*—The mutual influence of rectilinear and curvilinear currents being understood, the reciprocal effects of curvilinear currents may be easily traced. Each small part of such current may be regarded as a short rectilinear current, and the separate effects of such elementary parts being ascertained, the effects of the entire extent of the curvilinear currents will be the resultants of these partial forces.

2024. *Mutual action of curvilinear currents in general.*—An endless variety of problems arise from the various forms that curvilinear currents may assume, the various positions they may have in relation to each other, and the various conditions which may restrain their motions. The solution of all such problems, however, presents no other difficulties than those which attend the due application of the geometrical and mechanical principles already explained in each particular case.

To take as an example one of the most simple of the infinite variety of forms under which such problems are presented, let the centres of two circular currents be fixed; the planes of the currents being free to assume any direction whatever, they will turn upon their centres until they come into the same plane, the parts of the currents which intersect the line joining their centres flowing in the same direction. It is evident that upon the least disturbance from this position, they will be brought back to it by the mutual attraction of the parts of the circles on the sides which are near each other. This is therefore their position of stable equilibrium, and it is evident that the fronts of the currents in this position are on opposite sides of their common plane.

## CHAP. IX.

### VOLTAIC THEORY OF MAGNETISM.

2025. *Circulating currents have the magnetic properties.*—From what has been proved, it is apparent that an heliacal current has all the properties of a magnet. Such currents exert the same mutual attraction and repulsion, have the same polarity, submitted to the influence of terrestrial magnetism have the same directive properties, and exhibit all the phenomena of variation and dip as are manifested by artificial and natural magnets. And it is evident that these properties depend on the *circulating* and not on the *heliacal* character of the current, inasmuch as the effect of the progression of the helix being neutralized by carrying the current back in a straight direction along its axis, the phenomena instead of being disturbed are still more regular and certain.

These properties of circulating currents have been assumed by Ampère as the basis of his celebrated theory of magnetism, in which all magnetic phenomena are ascribed to the presence of currents circulating round the constituent molecules of natural and artificial magnets, and around the earth itself.

Let a bar magnet be supposed to be cut by a plane at right angles to its length. Every molecule in its section is supposed to be invested by a circulating current, all these currents revolving in the same direction, and consequently their fronts being presented to the same extremity of the bar. The forces exerted by all the currents thus prevailing around the molecules of the same section may be considered as represented by a single current circulating round the bar, and the same being true of all the transverse sections of the bar, it may be regarded as being surrounded by a series of circulating currents all looking in the same direction, and circulating round the bar. That end of the bar towards which the fronts of the currents are presented will have the properties of a south or boreal pole, and the other end those of a north or austral pole.

2026. *Magnetism of the earth may proceed from currents.*—In this theory the globe of the earth is considered to be traversed by electric currents parallel to the magnetic equator. The forces exerted by the currents circulating in each section of the earth, like those in the section of an artificial magnet, are considered as represented by a single current equivalent in its effect, and which is called the *mean current of the earth*, at each place upon its surface. The magnetic phenomena indicate that the direction of this mean current at each place is in a plane at right angles to the dipping-needle, and that it is directed in this plane from east to west, and at right angles to the magnetic meridian.

2027. *Artificial magnets explained on this hypothesis.*—In bodies such as iron or steel, which are susceptible of magnetism, but which are not magnetized, the currents which circulate round the constituent molecules are considered to circulate in all possible planes and all possible directions, and their forces thus neutralize each other. Such bodies, therefore, exert no forces of attraction or repulsion on each other. But, when such bodies are magnetized, the fronts of some or all of these currents are turned in the same direction, and their forces, instead of being opposed, are combined. The more

perfect the magnetization is, the greater proportion of the currents will thus be presented in the same direction, and the magnetization will be perfect when all the molecular currents are turned towards the same direction.

2028. *Effect of the presence or absence of coercive force.*—If the body thus magnetized be destitute of all coercive force, like soft iron, the currents which are thus temporarily turned by the magnetizing agent in the same direction will fall into their original confusion and disorder when the influence of that agent is suspended or removed, and the body will consequently lose the magnetic properties which had been temporarily imparted to it. If, on the contrary, the body magnetized have more or less coercive force, the accordance conferred upon the direction of the molecular currents is maintained with more or less persistence after the magnetizing agency has ceased; and the magnetic properties accordingly remain unimpaired until the accordance of the currents is deranged by some other cause.

2029. *This hypothesis cannot be admitted as established until the existence of the molecular currents shall be proved.*—To establish this theory according to the rigorous principles of inductive science, it would be necessary that the actual existence of the molecular voltaic currents, which form the basis of the theory, should be proved by some other evidence than the class of effects which they are assumed to explain. Until such proof shall be obtained, they cannot be admitted to have the character of a *vera causa*, and the theory must be regarded as a mere hypothesis, more or less probable, and more or less ingenious, which may be accepted provisionally as affording an explanation of the phenomena, and thus reducing magnetism to the dominion of electricity.

## CHAP. X.

### REOSCOPES AND REOMETERS.

2030. *Instruments to ascertain the presence and to measure the intensity of currents.*—It has been shown that when a voltaic current passes over a magnetic needle freely suspended, it

will deflect the needle from its position of rest, the quantity of this deflection depending on the force, and its direction on the direction of the current.

If the needle be astatic, and consequently have no directive force, it will rest indifferently in any direction in which it may be placed. In this case the deflecting force of the current will have no other resistance to overcome than that of the friction of the needle on its pivot; and if the deflecting force of the current be greater than this resistance, the needle will be deflected, and will take a position at right angles to the current, its north pole being to the left of the current (1918).

If the needle be not astatic it will have a certain directive force, and, when not deflected by the current, will place itself in the magnetic meridian. If, in this case, the wire conducting the current be placed over and parallel to the needle, the poles will be subject at once to two forces; the directive force tending to keep them in the magnetic meridian, and the deflecting force of the current tending to place them at right angles to that meridian. They will, consequently, take an intermediate direction, which will depend on the relation between the directive and deflecting forces. If the latter exceed the former, the needle will incline more to the magnetic east and west; if the former exceed the latter, it will incline more to the magnetic north and south. If these forces be equal, it will take a direction at an angle of  $45^\circ$  with the magnetic meridian. The north pole of the needle will, in all cases, be deflected to the left of the current (1918).

If while the directive force of the needle remains unchanged the intensity of the current vary, the needle will be deflected at a greater or less angle from the magnetic meridian, according as the intensity of the current is increased or diminished.

2031. *Expedient for augmenting the effect of a feeble current.*—It may happen that the intensity of the current is so feeble as to be incapable of producing any sensible deflection even on the most sensitive needle. The presence of such a current may, nevertheless, be detected, and its intensity measured, by carrying the wire conducting it first over and then under the needle, so that each part of the current shall exercise upon the needle a force tending to deflect it in the same direction. By this expedient the deflecting force exercised by the current on the needle is doubled.

Such an arrangement is represented in *fig. 651*. The wire passes from *n* to *z* over, and from *y* to *x* under the needle; and it is evident from what has been explained (1918), that the part *zn* and the part *yx* exercise deflecting forces in the same direction on the poles of the needle, both tending to deflect the north or austral pole

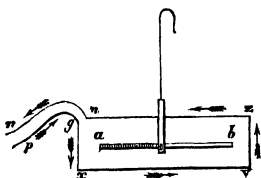

Fig. 651.

*a* to the left of a person who stands at *z* and looks towards *n*. It may be shown in like manner that the vertical parts of the current *gx* and *yz* have the same tendency to deflect the north pole *a* to the left of a person viewing it from *z*.

2032. *Method of constructing a reoscope, galvanometer, or multiplier.* — The same expedient may be carried further. The wire upon which the current passes may be carried any number of times round the needle, and each successive coil will equally augment its deflecting force. The deflecting force of the simple current will thus be multiplied by twice the number of coils. If the needle be surrounded with an hundred coils of conducting wire, the force which deflects it from its position of rest will be two hundred times greater than the deflecting force of the simple current.

The wire conducting the current must in such case be wrapped with silk or other non-conducting coating, to prevent the escape of the electricity from coil to coil.

Such an apparatus has been called a *multiplier*, in consequence of thus multiplying the force of the current. It has been also denominated a *galvanometer*, inasmuch as it supplies the means of measuring the force of the galvanic current.

We give it by preference the name *reoscope* or *reometer*, as indicating the presence and measuring the intensity of the current.

To construct a *reometer*, let two flat bars of wood or metal be united at the ends, so as to leave an open space between them of sufficient width to allow the suspension and play of a magnetic needle. Let a fine metallic wire of silver or copper, wrapped with silk, and having a length of eighty or a hundred feet, be coiled longitudinally round these bars, leaving at its extremities three or four feet uncoiled, so as to be conveniently placed in connexion with the poles of the voltaic apparatus from which

the current proceeds. Over the bars on which the conducting wire is coiled, is placed a dial upon which an index plays, which is connected with the magnetic needle suspended between the bars, and which has a common motion with it, the direction of the index always coinciding with that of the needle. The circle of the dial is divided into  $360^\circ$ , the index being directed to  $0^\circ$  or  $180^\circ$ , where the needle is parallel to the coils of the conducting wire.

Such an instrument, mounted in the usual manner and covered by a bell-glass to protect it from the disturbances of the air, is represented in *fig. 652*.

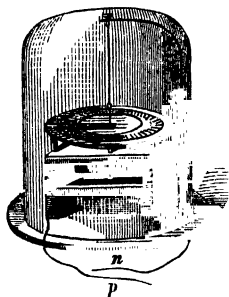

Fig. 652.

The needle is usually suspended by a single filament of raw silk. If the length of wire necessary for a single coil be six inches, fifty feet of wire will suffice for a hundred coils. To detect the presence of very feeble currents, however, a much greater number of coils are frequently necessary, and in some instruments of this kind there

are several thousand coils of wire.

2033. *Nobili's reometer*. — Without multiplying inconveniently the coils of the conducting wire, Nobili contrived a reoscope which possesses a sensibility sufficient for the most delicate experimental researches. This arrangement consists of two magnetic needles fixed upon a common centre parallel to each other, but with their poles reversed as represented in

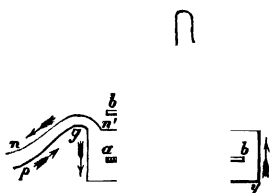

Fig. 653.

*fig. 653*. If the directive forces of these needles were exactly equal, such a combination would be astatic; and although it would indicate the presence of an extremely feeble current, it would supply no means of measuring the relative forces of two such currents. Such

an apparatus would be *reoscopic*, but not *reometric*. To impart to it the latter property, and at the same time to confer on it a high degree of sensibility, the needles are rendered a little, and but a little, unequal in their directive force. The directive force of the combination being the difference of the



directive forces of the two needles, is therefore extremely small, and the system is proportionately sensitive to the influence of the current.

2034. *Differential reometer.*—In certain researches a differential reometer is found useful. In this apparatus two wires of exactly the same material and diameter are coiled round the instrument, and two currents are made to pass in opposite directions upon them so as to exercise opposite deflecting forces on the needle. The deviation of the needle in this case measures the difference of the intensities of the two currents.

2035. *Great sensitiveness of these instruments illustrated.*—The extreme sensitiveness and extensive utility of these reoscopic apparatus will be rendered apparent hereafter. Meanwhile it may be observed that if the extremities *p* and *n* of the conducting wires be dipped in acidulated water, a slight chemical action will take place, which will produce a current by which the needle will be visibly affected.

In all cases it is easy to determine the direction of the current by the direction in which the north pole of the needle is deflected.

## CHAP. XI.

### THERMO-ELECTRICITY.

2036. *Disturbance of the thermal equilibrium of conductors produces a disturbance of the electric equilibrium.*—If a piece

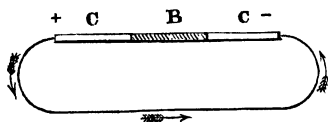

Fig. 654.

of metal *B*, *fig. 654.*, or other conductor, be interposed between two pieces *C*, of a different metal, the points of contact being reduced to different temperatures, the natural electricity at these points will be decomposed, the positive fluid passing in one direction, and the negative fluid in the other.

If the extremities of the pieces *C* be connected by a wire, a constant current will be established along such wire. The intensity of this current will be invariable so long as the temperatures of the points of contact of *B* with *C* remain the

same; and it will in general be greater, the greater the difference of these temperatures. If the temperatures of the points of contact be rendered equal, the current will cease.

These facts may be verified by connecting the extremities of *c* with the wires of any reoscopic apparatus. The moment a difference of temperature is produced at the points of contact, the needle of the reoscope will be deflected; the deflection will increase or diminish with every increase or diminution of the difference of the temperatures; and if the temperatures be equalized, the needle of the reoscope will return to its position of rest, no deflection being produced.

2037. *Thermo-electric current.* — A current thus produced is called a *thermo-electric current*. Those which are produced by the ordinary voltaic arrangements are called for distinction *hydro-electric currents*, a liquid conductor always entering the combination.

2038. *Experimental illustration.* — A convenient and simple apparatus for the experimental illustration of a thermo-electric current is represented in *fig. 655.*, consisting of a narrow strip

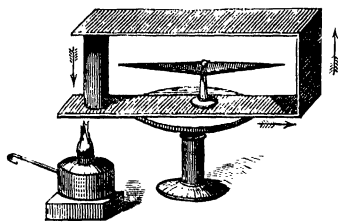

Fig. 655.

of copper bent so as to form three sides of a rectangle, the fourth part of which is a cylinder of bismuth, about half an inch in diameter, which is soldered at both ends to the copper so as to ensure perfect contact. A magnetic needle is placed within the rectangle, which is directed

in the plane of the magnetic meridian, so that the needle, when undisturbed by the current, shall rest in the direction of the rectangle, its north pole pointing to the zinc cylinder.

If a lamp be placed under the end of the bismuth cylinder, so as to raise its temperature above that of the upper end, the needle will be immediately deflected, and the deflection will increase as the difference of the temperatures of the lower and upper end of the zinc cylinder is increased.

2039. *Conditions which determine the direction of the current.* — When the temperature of the lower end of the bismuth cylinder is more elevated than that of the upper end, the north pole of the needle is deflected towards the east, from which it

appears that the current in this case flows from the upper to the lower end of the cylinder, and passes round the rectangle in the direction represented by the arrows.

If the heat be applied to the upper end of the bismuth, or, what is the same, if cold be applied to the lower end, the north pole of the needle will be deflected to the west, showing that the direction of the current will be reversed, the positive fluid always flowing towards the warmer end of the bismuth.

2040. *A constant difference of temperature produces a constant current.*—If means be taken to maintain the extremities of the bismuth at a constant difference of temperature, the needle will maintain a constant deflection. Thus, if one end of the bismuth be immersed in boiling water and the other in melting ice, so that their temperatures shall be constantly maintained at  $212^{\circ}$  and  $32^{\circ}$ , the deflection of the needle will be invariable. If the temperature of the one be gradually lowered, and the other gradually raised, the deflection of the needle will be gradually diminished; and when the temperatures are equalized, the needle will resume its position in the magnetic meridian.

2041. *Different metals have different thermo-electric energies.*—This property, in virtue of which a derangement of the electric equilibrium attends a derangement of the thermal equilibrium, is common to all the metals, and, indeed, to conductors generally; but, like other physical properties, they are endowed with it in very different degrees. Among the metals, bismuth and antimony have the greatest thermo-electric energy, whether they are placed in contact with each other, or with any other metal. If a bar of either of these metals be placed with its extremities in contact with the wires of a reometer, a deflection of the needle will be produced by the mere warmth of the finger applied to one end of the bar. If the finger be applied to both ends, the deflection will be redressed, and the needle will return to the magnetic meridian.

It has been ascertained that if different parts of the same mass of bismuth or antimony be raised to different temperatures, the electric equilibrium will be disturbed, and currents will be established in different directions through it, depending on the relative temperatures. These currents are, however, much less intense than in the case where the derangement of temperature is produced at the points of contact or junction of different conductors.

2042. *Pouillet's thermo-electric apparatus.*—M. Pouillet

has with great felicity availed himself of these properties of thermo-electricity to determine some important and interesting properties of currents. The apparatus constructed and applied by him in these researches is represented in *fig. 656*.

Two rods *A* and *B* of bismuth, each about sixteen inches in length and an inch in thickness, are bent at the ends at right angles, and being supported on vertical stands are so arranged that the ends *CD* and *EF* may be let down into cups. The cups *C* and *E* are filled with melting ice, and *D* and *F* with boiling water, so that the ends *C* and *E* are kept at the constant temperature of  $32^{\circ}$ , and the ends *D* and *F* at the constant temperature of  $212^{\circ}$ .

A differential reometer (2033) is placed at *M*. Two conducting circuits are formed either of one or several wires, one com-

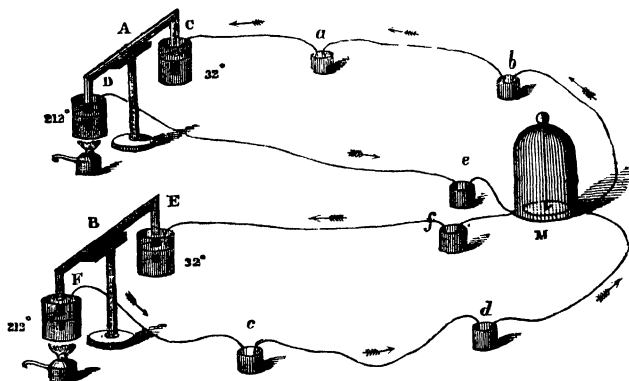

Fig. 656.

mencing from *F*, and after passing through the wire of the reometer *M*, returning to *E*; the other commencing from *D*, and after passing through the wire of the reometer in a contrary direction to the former, returning to *C*. The wires conducting the current are soldered to the extremities *C*, *D*, *E*, *F* of the bismuth rods, which are immersed in the cups.

If the two currents thus transmitted, the one between *F* and *E*, and the other between *D* and *C*, have equal intensities, the needle of the reometer *M* will be undisturbed; but if there be any difference of intensity, its quantity and the wire on which the excess prevails will be indicated by the quantity and direction of the deflection of the needle.

The successive wires along which the current passes are brought into metallic contact by means of mercurial cups, *a*, *b*, *c*, *d*, &c., into which their ends are immersed.

The circuits through which the current passes may be simple or compound. If simple, they consist of wire of one uniform material and thickness. If compound, they consist of two or more wires differing in material, thickness, or length.

The wire composing a simple circuit is divided into two lengths, one extending from *D* or *F* to the cup *e* or *d*, where the current enters the convolutions of the reometer, and the other extending from the cup *b* or *f*, where the current issues from the reometer to *C* or *E*, where it returns to the thermo-electric source. The wires composing a compound current may consist of a succession of lengths, the current passing from one to another by means of the metallic cups. Thus, as represented in the figure, the wires *Fc*, *cd*, and *fE*, forming, with one wire of the reometer, one circuit, and the wires *De*, *ba*, and *aC*, forming with the other wire of the reometer the other circuit, may differ from each other in material, in thickness, and in length.

The currents pass as indicated by the arrows, from the extremity of the bismuth which has the higher temperature through the wires to the extremity which has the lower temperature.

2043. *Relation between the intensity of the current and the length and section of the conducting wire.* — If the two circuits be simple and be composed of similar wires of equal lengths, the intensity of the two currents will be found to be equal, the needle of the reometer being undisturbed. But if the length of the circuit be greater in the one than in the other, the intensities will be unequal, that current which passes over the longest wire having a less intensity in the exact proportion in which it has a greater length.

If the section of the wire composing one circuit be greater than that of the wire composing the other circuit, their lengths being equal, the current carried by the wire of greater section will be more intense than the other in exactly the proportion in which the section is greater.

If the wire composing one of two simple circuits have a length less than that composing the other, and a section also less in the same proportion than the section of the other, the currents passing over them will have the same intensity, for the excess

of intensity due to the lesser length of the one is compensated by the excess due to the greater section of the other.

In general, therefore, if  $i$  and  $i'$  express the intensities of the two currents transmitted from  $D$  and  $F$ , *fig.* 656., over two simple circuits of wire of the same metal, whose sections are respectively  $s$  and  $s'$ , and whose lengths are  $L$  and  $L'$ , we shall have :

$$i : i' :: \frac{s}{L} : \frac{s'}{L'} ;$$

that is to say, the intensities are directly as the sections and inversely as the lengths of the wire.

If two simple circuits be compared, consisting of wires of different metals, this proportion will no longer be maintained, because in that case wires of equal length and equal section will no longer give the currents equal intensities, because they will not have equal conducting powers. That circuit which, being alike in other respects, is composed of the metal of greatest conducting power, will give a current of proportionally greater intensity. The relative intensities, therefore, of the currents carried by wires of different metals of equal length and thickness are the exponents of the relative conducting powers of these metals.

In general, if  $c$  and  $c'$  express the conducting powers of the metals composing two simple circuits, we shall have :

$$i : i' :: c \times \frac{s}{L} : c' \times \frac{s'}{L'}$$

2044. *Conducting powers of metals.*—M. Pouillet ascertained on these principles the conducting powers of the following metals relatively to that of distilled mercury taken at 100:—

Metals.						Conducting Power.
Mercury	-	-	-	-	-	100
Iron	-	-	-	-	-	600 to 700
Steel	-	-	-	-	-	500 to 800
Brass	-	-	-	-	-	200 to 900
Platinum	-	-	-	-	-	850
Copper	-	-	-	-	-	3800
Gold	-	-	-	-	-	3900
Silver	-	-	-	-	-	5200
Palladium	-	-	-	-	-	5800

2045. *Current passing through a compound circuit of uniform intensity.*—The current which passes through a compound

circuit is found to have an uniform intensity throughout its entire course. In passing through a length of wire, which is a bad conductor, its intensity is neither greater nor less than upon one which is a good conductor, and its intensity on pieces of unequal section and unequal length is in like manner exactly the same.

2046. *Equivalent simple circuit.*—A simple circuit composed of a wire of any proposed metal and of any proposed thickness can always be assigned upon which the current would have the same intensity as it has on any given compound circuit; for by increasing the length of such circuit the intensity of the current may be indefinitely diminished, and by diminishing its length the intensity may be indefinitely increased. A length may therefore be always found which will give the current any required intensity.

The length of such a standard wire which would give the current of a simple circuit the same intensity as that of a compound circuit, is called the *reduced length* of the compound circuit.

2047. *Ratio of intensities in two compound circuits.*—It is evident, therefore, that the intensities of the currents on two compound circuits are in the inverse ratio of their *reduced lengths*, for the wires composing such reduced lengths are supposed to be of the same material and to have the same thickness.

2048. *Intensity of the current on a given conductor varies with the thermo-electric energy of the source.*—In all that has been stated above, we have assumed that the source of thermo-electric agency remains the same, and that the changes of intensity of the current are altogether due to the greater or less facility with which it is allowed to pass along the conducting wires from one pole of the thermo-electric source to the other. But it is evident, that with the same conducting circuit, whether it be simple or compound, the intensity of the current will vary either with the degree of disturbance of the thermal equilibrium of the system or with the thermo-electric energy of the substance composing the system.

In the case already explained, the ends of the cylinders A and B have been maintained at the fixed temperatures of 32° and 212°. If they had been maintained at any other fixed temperatures, like phenomena would have been manifested, with this difference only, that with the same circuit the intensity of the

current would be different, since it would be increased if the difference of the temperature of the extremities were increased, and would be diminished if that difference were diminished.

In like manner, if, instead of bismuth, antimony, zinc, or any other metal were used, the same circuit and the same temperatures of the ends C and D or E and F would exhibit a current of different intensity, such difference being due to the different degree of thermo-electric agency with which the different metals are endowed.

The relative thermo-electric agency of different sources of these currents, whether it be due to a greater or less disturbance of the thermal equilibrium, or to the peculiar properties of the substance whose temperature is deranged, or, in fine, to both of these causes combined, is in all cases proportional to the intensity of the current which it produces in a wire of given material, length, and thickness, or in general to the intensity of the current it transmits through a given circuit.

The relative thermo-electric energy of two systems may be ascertained by placing them as at A and B, *fig.* 656., and connecting them by simple circuits of similar wire with the differential reometer. Let the lengths of the wires composing the two circuits be so adjusted, that the currents passing upon them shall have the same intensity. The thermo-electric energy of the two systems will then be in the direct ratio of the lengths of the circuits.

2049. *Thermo-electric piles.*—The intensity of a thermo-electric current may be augmented indefinitely by combining together a number of similar thermo-electric elements, in a manner similar to that adopted in the formation of a common voltaic battery. It is only necessary, in making such arrangement, to dispose the elements so that the several partial currents shall all flow in the same direction.

Such an arrangement is represented in *fig.* 657., where the two metals (bismuth and copper, for example) composing each

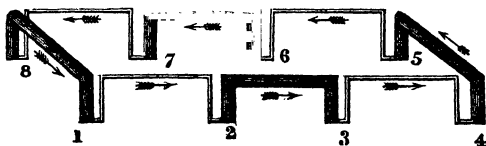

Fig. 657.



thermo-electric pair are distinguished by the thin and thick bars. If the points of junction marked 1, 3, 5, &c. be raised to  $212^{\circ}$ , while the points 2, 4, 6, &c. are kept at  $32^{\circ}$ , a current will flow from each of the points 1, 3, 5, &c. towards the points 2, 4, 6, &c. respectively, and these currents severally overlaying each other, exactly as in the voltaic batteries, will form a current having the sum of their intensities.

2050. *Thermo-electric pile of Nobili and Melloni.*—Various expedients have been suggested for the practical construction of such thermo-electric piles, one of the most efficient of which is that of MM. Nobili and Melloni. This pile is composed of a series of thin plates of bismuth and antimony, bent at their extremities, so that when soldered together they have the form

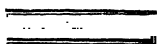

Fig. 658.

and arrangement indicated in *fig.* 658. The spaces between the successive plates are filled by pieces of pasteboard, by which the combination acquires sufficient solidity, and the plates are retained in their position without being pressed into contact with each other. The pile thus formed is mounted in a frame as represented in *fig.* 659., and its poles are connected

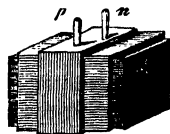

Fig. 659.

with two pieces of metal by which the current may be transmitted to any conductors destined to receive it. It will be perceived that all the points of junction of the plates of bismuth and antimony which are presented at the same side of the frame are alternate in their order, the 1st, 3rd, 5th, &c. being on one side, and the 2nd, 4th, 6th, &c. on the other. If, then, one side be exposed to any source of heat or cold from which the other is removed, a corresponding difference of temperature will be produced at the alternate joints of the metal, and a current of proportionate intensity will flow between the poles *p* and *n* upon any conductor by which they may be connected.

It is necessary, in the practical construction of this apparatus, that the metallic plates composing it should be all of the same length, so that when combined the ends of the system where the metallic joints are collected should form an even and plain surface, which it is usual to coat with lampblack, so as to augment its absorbing power, and at the same time to render it more even and uniform.

This was the form of thermo-electric pile used by M. Melloni

in the series of experimental researches adverted to in 1564, and the manner in which it was applied is exhibited in all its details in *fig.* 451., where *pn* are the poles of the system, and *p* the reometer through which the current is transmitted.

## CHAP. XII.

## ELECTRO-CHEMISTRY.

2051. *Decomposing power of a voltaic current.* — When a voltaic current of sufficient intensity is made to pass through certain bodies consisting of constituents chemically combined, it is found that decomposition is produced attended by peculiar circumstances and conditions. The compound is resolved into two constituents, which appear to be transported in contrary directions, one *with* and the other *against* the course of the current. The former is disengaged at the place where the current leaves, and the other at the place where it enters the compound.

All compounds are not resolvable into their constituents by this agency, and those which are are not equally so; some being resolved by a very feeble current, while others yield only to one of extreme intensity.

2052. *Electrolytes and electrolysis.* — Bodies which are capable of being decomposed by an electric current have been called ELECTROLYTES, and decomposition thus produced has been denominated ELECTROLYSIS.

2053. *Liquids alone susceptible of electrolysis.* — To render electrolysis practicable, the molecules of the electrolyte must have a perfect freedom of motion amongst each other. The electrolyte must therefore be liquid. It may be reduced to this state either by solution or fusion.

2054. *Faraday's electro-chemical nomenclature.* — It has been usual to apply the term poles either to the terminal elements of the pile, or to the extremities of the wire or other conductor by which the current passes from one end and enters the other. These are not always identical with the points at which the current enters and leaves an electrolyte. The same

current may pass successively through several electrolytes, and each will have its point of entrance and exit; but it is not considered that the same current shall have more than two poles. These and other considerations induced Dr. Faraday to propose a nomenclature for the exposition of the phenomena of electrolysis, which has to some extent obtained acceptance.

2055. *Positive and negative electrodes.* — He proposed to call the points at which the current enters and departs from the electrolyte, **ELECTRODES**, from the Greek word *ὁδός* (*odos*), a path or way. He proposed further to distinguish the points of entrance and departure by the terms **ANODE** and **KATHODE**, from the Greek words *ἀνοδος* (*anodos*), *the way up*, and *κάθοδος* (*kathodos*), *the way down*.

2056. *Only partially accepted.* — Dr. Faraday also gave the name **IONS** to the two constituents into which an electrolyte is resolved by the current, from the Greek word *ἰων* (*Ion*), *going* or *passing*, their characteristic property being the tendency to pass to the one or the other electrode. That which passes to the positive electrode, and which therefore moves against the current, he called the **ANION**; and that which passes to the negative electrode and therefore moves with the current, he called the **KATHION**. These terms have not, however, obtained acceptance. Neither have the terms “Anode” and “Kathode,” positive and negative electrode, or positive and negative pole, being almost universally preferred.

The constituent of an electrolyte which moves with the current is distinguished as the *positive* element, and that which moves against it as the *negative* element. These terms are derived from the hypothesis that the constituent which appears at the positive electrode, and which moves, or seems to move towards it after decomposition, is attracted by it as a particle negatively electrified would be; while that which appears at the negative electrode is attracted to it as would be a particle positively electrified.

2057. *Composition of water.* — To render intelligible the process of electrolysis, let us take the example of water, the first substance upon which the decomposing power of the pile was observed. Water is a binary compound, whose simple constituents are the gases called oxygen and hydrogen. Nine grains weight of water consist of eight grains of oxygen and one grain of hydrogen.

The specific gravity of oxygen being sixteen times that of hydrogen (779), it follows that the volumes of these gases which compose water are in the ratio of two to one, so that a quantity of water which contains as much oxygen as in the gaseous state would have the volume of a cubic inch, contains as much hydrogen as would, under the same pressure, have the volume of two cubic inches.

The combination of these gases, so as to convert them into water, is determined by passing the electric spark taken from a common machine through a mixture of them. If eight parts by weight of oxygen and one of hydrogen, or, what is the same, one part by measure of oxygen and two of hydrogen, be introduced into the same receiver, on passing through them the electric spark an explosion will take place; the gases will disappear, and the receiver will be filled first with steam, which being condensed, will be presented in the form of water. The weight of water contained in the receiver will be equal precisely to the sum of the weight of the two gases.

These being premised, the phenomena attending the electrolysis of water may be easily understood.

2058. *Electrolysis of water.*—Let a glass tube, closed at one end, be filled with water slightly acidulated, and stopping the open end, let it be inverted and immersed in similarly acidulated water contained in any open vessel. The column in the tube will be sustained there by the atmospheric pressure as the mercurial column is sustained in a barometric tube; but in this case the tube will remain completely filled, no vacant space appearing at the top, the height of the column being considerably less than that which would balance the atmospheric pressure. Let two platinum wires be connected with the poles of a voltaic pile, and let their extremities, being immersed in the vessel containing the tube, be bent so as to be presented upwards in the tube without touching each other. Immediately small bubbles of gas will be observed to issue from the points of the wires, and to rise through the water and collect in the top of the tube, and this will continue until the entire tube is filled with gas, by the pressure of which the water will be expelled from it. If the tube be now removed from the vessel, and the gas be transferred to a receiver, so arranged that the electric spark may be transmitted through it, on such transmission the gas will be reconverted into water.

The gases, therefore, evolved at the points of the wire, which in this case are the *electrodes*, are the constituents of water; and since they cannot combine to form water, except in the definite ratio of 1 to 2 by measure, they must have been evolved in that exact portion at the electrodes.

2059. *Explanation of this phenomenon by the electro-chemical hypothesis.*— This phenomenon is explained by the supposition that the voltaic current exercises forces directed upon each molecule of the water, by which the molecules of oxygen are impelled or attracted towards the positive electrode, and therefore against the current, and the molecules of hydrogen towards the negative electrode, and therefore with the current. The electro-chemical hypothesis is adopted by different parties in different senses.

According to some, each molecule of oxygen is invested with an atmosphere of negative, and each molecule of hydrogen with an atmosphere of positive electricity, which are respectively inseparable from them. When these gases are in their free and uncombined state, these fluids are neutralized by equal doses of the opposite fluids received from some external source, since otherwise they would have all the properties of electrified bodies, which they are not observed to have. But when they enter into combination, the molecule of oxygen dismisses the dose of positive electricity, and the molecule of hydrogen the dose of negative electricity which previously neutralized their proper fluids; and these latter fluids then exercising their mutual attraction, cause the two gaseous molecules to coalesce and to form a molecule of water.

When decomposition takes place, a series of opposite effects are educed. The molecule of oxygen after decomposition is charged with its natural negative, and the molecule of hydrogen with its natural positive fluid, and these molecules must borrow from the decomposing agent or some other source the doses of the opposite fluids which are necessary to neutralize them. In the present case, the molecule of oxygen is reduced to its natural state by the positive fluid it receives at the positive electrode, and the molecule of hydrogen by the negative fluid it receives at the negative electrode.

The electro-chemical hypothesis is, however, differently understood and differently stated by different scientific authorities.

It is considered by some that the decomposing forces in the case of the voltaic current are the attractions and repulsions which the two opposite fluids developed at the electrodes exercise upon the atmospheres of electric fluid, which are assumed in this theory to surround and to be inseparable from the molecules of oxygen and hydrogen which compose each molecule of water, the resultants of these attractions and repulsions being two forces, one acting on the oxygen and directed towards the positive electrode, and the other acting on the hydrogen and directed towards the negative electrode. Others, with Dr. Faraday, deny the existence of these attractions, and regard the electrodes as mere paths by which the current enters and leaves the electrolyte, and that the effect of the current in passing through the electrolyte is to propel the molecules of oxygen and hydrogen in contrary directions, the latter in the direction of the current, and the former in the contrary direction; and that this, combined with the series of decompositions and recompositions imagined by Grotthus, which we shall presently explain, supplies the most satisfactory exposition of the phenomena.

Our limits, however, compel us to dismiss these speculations, and confine our observations rather to the facts developed by experimental research, using, nevertheless, the language derived from the theory for the purposes of explanation.

2060. *Method of electrolysis which separates the constituents.*

—The process of electrolysis may be so conducted that the constituent gases shall be developed and collected in separate receivers.

The apparatus represented in *fig.* 660., contrived by Mitscherlich, is very convenient for the exhibition of this and other electrolytic phenomena. Two glass tubes *o* and *h*, about half an inch in diameter, and 6 or 8 inches in length, are closed at the top and open at the bottom, having two short lateral tubes projecting from them, which are stopped by corks, through which pass two platinum wires which terminate within the tubes in a small brush of fine platinum wire, which may with advantage be surrounded at the ends with spongy platinum. The tubes *o*, *h* being uni-

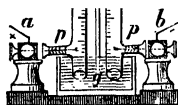

Fig. 660.

formly cylindrical and conveniently graduated, are filled with acidulated water, and immersed in a cistern of similarly acidulated water *g*.

If the external extremities of the platinum wires be connected by means of binding screws *a* and *b*, or by mercurial cups with wires which proceed from the poles of a voltaic arrangement, their internal extremities will become electrodes, and electrolysis will commence. Oxygen gas will be evolved from the positive, and hydrogen from the negative electrode, and these gases will collect in the two tubes, the oxygen in the tube *o* containing the positive, and the hydrogen in the tube *h* containing the negative electrode. The graduated scales will indicate the relative measures of the two gases evolved, and it will be observed that throughout the process the quantity of gas in the tube *h* is double the quantity in the tube *o*. If the gases be removed from the tubes to other receivers and submitted to chemical tests, one will be found to be oxygen and the other hydrogen.

2061. *How are the constituents transferred to the electrodes?* — In the apparatus *fig.* 660., the tubes containing the electrodes are represented as being near together. The process of electrolysis, however, will equally ensue when the cistern *g* is a trough of considerable length, the tubes *o* and *h* being at its extremities. It appears, therefore, that a considerable extent of liquid may intervene between the electrodes without arresting the process of decomposition. The question then arises, where does the decomposition take place? At the positive electrode, or at the negative electrode, or at what intermediate point? If it take place at the positive electrode, a constant current of hydrogen must flow from that point through the liquid to the negative electrode; if at the negative electrode a like current of oxygen must flow from that point to the positive electrode; and if at any intermediate point, two currents must flow in contrary directions from that point, one of oxygen to the positive, and one of hydrogen to the negative electrode. But no trace of the existence of any such currents has ever been found. Innumerable expedients have been contrived to arrest the one or the other gas in its progress to the electrode without success; and therefore the strongest physical evidence supports the position that neither of these constituent gases do actually exist in the separate state at any part of the electrolyte, except at

the very, electrodes themselves at which they are respectively evolved.

If this be assumed, then it will follow that the molecules of oxygen and hydrogen evolved at the two electrodes were not previously the component parts of the same molecule of water. The molecule of oxygen evolved at the positive electrode must be supplied by a molecule of water contiguous to that electrode, while the molecule of hydrogen simultaneously evolved at the negative electrode must have been supplied by another molecule of water contiguous to the latter electrode. What then becomes of the molecule of hydrogen dismissed by the former, and the molecule of oxygen dismissed by the latter? Do they coalesce and form a molecule of water? But such a combination would again involve the supposition of currents of gas passing through the electrolyte, of the existence of which no trace has been observed.

2062. *Solution of the hypothesis of Grotthus.*—The only hypothesis which has been proposed presenting any satisfactory explanation of the phenomena is that of Grotthus, in which a series of decompositions and recompositions are supposed to take place between the electrodes. Let  $\text{OH}$ ,  $\text{O}'\text{H}'$ ,  $\text{O}''\text{H}''$ , &c., represent a series of molecules of water ranged between the positive electrode  $\text{P}$  and the negative electrode  $\text{N}$ .



When  $\text{OH}$  is decomposed and  $\text{o}$  is detached in a separate state at  $\text{P}$ , the positive fluid inseparable from  $\text{H}$ , according to the electro-chemical hypothesis, being no longer neutralized by an opposite fluid, attracts the negative fluid of  $\text{o}'$ , and repels the positive fluid of  $\text{H}'$ , and decomposing the molecule of water  $\text{O}'\text{H}'$ , the molecule  $\text{o}'$  coalesces with  $\text{H}$  and forms a molecule of water. In like manner,  $\text{H}'$  decomposes  $\text{O}''\text{H}''$ , and combines with  $\text{o}''$ ;  $\text{H}''$  decomposes  $\text{O}'''\text{H}'''$ , and combines with  $\text{o}'''$ ; and  $\text{H}'''$  decomposes  $\text{O}''''\text{H}''''$ , and combines with  $\text{o}''''$ ; and, in fine,  $\text{H}''''$  is disengaged at the negative electrode  $\text{N}$ . Thus, as the series of decompositions and recompositions proceeds, the molecules of oxygen are disengaged at the positive electrode  $\text{P}$ , and those of hydrogen at the negative electrode  $\text{N}$ .

In this hypothesis it is further supposed, as already stated, that the molecule of oxygen  $\text{o}$ , disengaged at the positive electrode  $\text{P}$ , receives from that electrode a dose of positive electri-



city, which being equal in quantity to its own proper negative electricity, neutralizes it; and, in like manner, the molecule of hydrogen  $H'''$ , disengaged at the negative electrode  $N$ , receives from it a corresponding dose of negative electricity which neutralizes its own positive electricity. It is thus that the two gases, when liberated at the electrodes, are in their natural and unelectrified state.

2063. *Effect of acid and salt on the electrolysis of water.*—In the electrolysis of water as described above, the acid held in solution undergoes no change. It produces, nevertheless, an important influence on the development of the phenomena. If the electrodes be immersed in pure water, decomposition will only be produced when the current is one of extraordinary intensity. But if a quantity of sulphuric acid even so inconsiderable as one per cent. be present, a current of much less intensity will effect the electrolysis; and by increasing the proportion of acid gradually from one to ten or fifteen per cent., the decomposition will require a less and less intense current.

It appears, therefore, that the acid without being itself affected by the current, renders the water more susceptible of decomposition. It seems to lessen the affinity which binds the molecules of oxygen and hydrogen, of which each molecule of water consists.

Various other acids and salts soluble in water produce the same effect.

The electrolyte, properly speaking, is therefore in these cases the water alone. The bath in which the electrodes are immersed, and in which the phenomena of the electrolysis are developed, may contain various substances in solution; but so long as these are not directly affected by the current, they must not be considered as forming any part of the electrolyte, although they not only influence the phenomena as above stated, but are also involved in important secondary phenomena, as will presently appear.

*Cases in which the matter of the electrodes combines with the constituents of the electrolyte.*—The process of the electrolysis of water has been presented here in its most simple form, no other effect save the mere decomposition of the electrolyte being educed. If, however, the platinum electrodes which have no sensible affinity for the constituents of water be replaced by electrodes composed of any metal having a stronger

affinity for oxygen, other phenomena will be developed. The oxygen dismissed by the water at the positive electrode, instead of being liberated, will immediately enter into combination with the metal of the electrode, forming an oxyde of that metal. This oxyde may adhere to the electrode, forming a crust upon it. In that case, if the oxyde be a conductor, it will itself become the electrode. If it be not a conductor it will impede and finally arrest the course of the current, and put an end to the electrolysis. If it be soluble in water it will disappear from the electrode as fast as it is formed, being dissolved by the water ; and in that case the water will become a solution of the oxyde, the strength of which will be gradually increased as the process is continued.

If the water composing the bath hold an acid in solution, for which the oxyde thus formed at the positive electrode has an affinity, the oxyde will enter into combination with the acid, and will form a salt which will either be dissolved or precipitated, according as it is soluble or not in the bath.

While the oxygen disengaged from the water at the positive electrode undergoes these various combinations, the hydrogen is frequently liberated in the free state at the negative electrode, and may be collected and measured. In such case it will always be found that the quantity of the hydrogen developed at the negative electrode is the exact equivalent of the oxygen which has entered into combination with the metal at the positive electrode, and also that the quantity of the metal oxydated is exactly that which corresponds with the quantities of the two gases which are disengaged, and with the quantity of water which is decomposed.

2064. *Secondary action of the hydrogen at the negative electrode.*—In some cases the hydrogen is not developed in the form of gas at the negative electrode, but in its place the pure metal which is the base of the oxyde dissolved in the bath, is deposited there. In such cases the phenomena become more complicated, but nevertheless sufficiently evident. The hydrogen developed at the negative electrode, instead of being disengaged in the free state, attracts the oxygen from the oxyde, and combining with it forms water, liberating at the same time the metallic base of the oxyde which is deposited on the negative electrode.

Thus there is in such cases both a decomposition and a re-

composition of water. It is decomposed at the one electrode to produce the oxyde, and recomposed at the other electrode to reduce or decompose the same oxyde.

2065. *Its action on bodies dissolved in the bath.*— This effect of the hydrogen developed at the negative electrode is not limited to the oxyde or salt produced by the action of the positive electrode. It will equally apply to any metallic oxyde or salt which may be dissolved in the bath. Thus, while the oxygen may be disengaged in a free state and collected in the gaseous form over the positive electrode, the hydrogen developed at the negative electrode may reduce and decompose any metallic salt or oxyde which may have been previously dissolved in the bath.

2066. *Example of zinc and platinum electrodes in water.*— To render this more clear, let it be supposed that while the negative electrode is still platinum, the positive electrode is a plate of zinc, a metal eminently susceptible of oxydation. In this case no gas will appear at the zinc, but the protoxyde of that metal will be formed. This substance being insoluble in water will adhere to the electrode if the bath contain pure water; but if it be acidulated, with sulphuric acid for example, the protoxyde so soon as it is formed will combine with the sulphuric acid, producing the salt called the sulphate of zinc, or more strictly the sulphate of the oxyde of zinc. This being soluble, will be dissolved in the bath.

2067. *Secondary effects of the current.*— In all these cases the primary and, strictly speaking, the only effect of the current is the decomposition of water, and the only substances affected by the electric agency are the constituents, oxygen and hydrogen, of the water decomposed. All the other phenomena are secondary and subsequent to the electrolysis, and depend not on the current but on the affinities of the electrodes and of the substances held in solution by the electrolyte for the constituents of the electrolyte and for each other. The phenomena, however, though successive as regards the physical agencies which produce them, are practically simultaneous in their manifestation, and are often so complicated and interlaced in their mutual relations and dependencies, that it is extremely difficult to discover a clear and certain analysis of them.

2068. *Compounds which are susceptible of electrolysis.*— The electrolysis of water is, in all its circumstances and con-

ditions, a type and example of the phenomena attending the decomposition of other compounds by the same agency.

Compounds are susceptible of electrolysis or not, according to the nature, properties, and proportion of their constituents.

It has been ascertained by direct experiment that most of the simple bodies are capable of being disengaged from compounds of which they may be constituents by electrolysis, and analogy renders it probable that all of them have this property. Those which have not yet been ascertained to be capable of elimination by this agency, include nitrogen, carbon, phosphorus, boron, silikon, and aluminium. The difficulty of obtaining these substances in compounds of a form adapted to electrolysis, has alone rendered them exceptions to the otherwise universally ascertained law.

2069. *Electrolytic classification of the simple bodies.*— Attempts have been made to classify bodies according to the tendencies they manifest to pass to the one or the other electrode in the process of electrolytic decomposition, those which evince the strongest tendency to go to the positive electrode being considered in the highest degree electro-negative, and those which show the strongest tendency to go to the negative electrode in the highest degree electro-positive. Although experimental research has not yet supplied very extensive or accurate data for such a classification, the following proposed by Berzelius will be found useful as indicating in a general manner the electrical characters of a large number of simple bodies, subject, however, to such corrections and modifications as further experiment and observation may suggest.

2070. I. ELECTRO-NEGATIVE BODIES.

1. Oxygen.	8. Selenium.	15. Antimony.
2. Sulphur.	9. Arsenic.	16. Tellurium.
3. Nitrogen.	10. Chromium.	17. Columbium.
4. Chlorine.	11. Molydenum.	18. Titanium.
5. Iodine.	12. Tungsten.	19. Silicon.
6. Fluorine.	13. Boron.	20. Osmium.
7. Phosphorus.	14. Carbon.	21. Hydrogen.

2071. II. ELECTRO-POSITIVE BODIES.

1. Potassium.	7. Magnesium.	13. Zinc.
2. Sodium.	8. Glucinium.	14. Cadmium.
3. Lithium.	9. Yttrium.	15. Iron.
4. Barium.	10. Aluminium.	16. Nickel.
5. Strontium.	11. Zirconium.	17. Cobalt.
6. Calcium.	12. Manganese.	18. Cerium.

19. Lead.	23. Copper.	27. Platinum.
20. Tin.	24. Silver.	28. Rhodium.
21. Bismuth.	25. Mercury.	29. Iridium.
22. Uranium.	26. Palladium.	30. Gold.

All the bodies named in the first series are supposed to be negative with relation to those in the second. Each of the bodies in the first series is negative, and each of the bodies in the second positive, with relation to those which follow.

The meaning is, that if an electrolyte composed of any two of the bodies in the first list be submitted to the action of the current, that which stands first in the list will go to the positive electrode; if an electrolyte composed of any body in the first and another in the second list be electrolyzed, the former will go to the positive electrode; and, in fine, if an electrolyte composed of any two of the bodies named in the second list be electrolyzed, the first named will go to the negative electrode.

It has been objected that sulphur and nitrogen occupy too high a place in the negative series, these bodies being less negative than chlorine and fluorine, and that hydrogen ought rather to be placed in the positive series.

2072. *The order of the series not certainly determined.* — It must be observed that the order of the simple bodies in these series has not been determined in all cases by the direct observation of the phenomena of the electrolysis. It has been in many cases only inferred from the analogies suggested by their chemical relations.

2073. *Electrolytes which have compound constituents.* — When the constituents of an electrolyte are compound bodies, the decomposition proceeds in the same manner as with those binary compounds whose constituents are simple. Most of the salts which have been submitted to experiment prove to be electrolytes, the acid constituent appearing at the positive, and the base at the negative electrode. Acids are therefore in general regarded as electro-negative bodies analogous to oxygen, and alkalis and oxydes electro-positive bodies analogous to hydrogen.

2074. *According to Faraday, electrolytes whose constituents are simple can only be combined in a single proportion.* — It appears to result from the researches of Faraday, that two simple bodies cannot combine in more than one proportion so as to form an electrolyte.

When hydrochloric acid, whose constituents are chlorine and hydrogen, is submitted to the current, electrolysis ensues, the chlorine appearing at the positive and the hydrogen at the negative electrode.

The protochlorides of the metals composed of the metallic base and one equivalent of chlorine are also easily electrolyzed, the chlorine always appearing at the positive electrode; but the perchlorides of the same metals which contain two or more equivalents of chlorine are not susceptible of electrolyzation.

In general, compounds which consist of two simple elements are only electrolyzable when their constituents are single equivalents. Hence sulphuric acid which has three, and nitric acid which has five equivalents of oxygen, are neither of them susceptible of electrolyzation.

2075. *Apparent exceptions explained by secondary action.*—In the investigation of the chemical phenomena which attend the transmission of the current through liquid compounds, results will be occasionally observed which will at first seem incompatible with this law. But in these cases the phenomena are invariably the consequences, not of electrolysis, but of secondary action. Thus, nitric acid submitted to the current is decomposed, losing one equivalent of its oxygen, and reduced to nitrous acid. In this case the real electrolyte is the water, which always exists in more or less quantity in the acid. This water being decomposed, the oxygen is delivered at the positive electrode, and the hydrogen developed at the negative electrode attracts from the nitric acid one equivalent of its oxygen, with which it combines and forms water, reducing the nitric to nitrous acid.

Ammonia, which consists of one equivalent of nitrogen and three of hydrogen, is not properly an electrolyte, though in solution it is decomposed by the secondary action of the current. In this case, as in the former, the real electrolyte is the water in which the ammonia is dissolved. Nitrogen and not oxygen is disengaged at the positive electrode. The oxygen, which is the primary result of the electrolysis of the water, attracts the hydrogen of the ammonia, with which it reproduces water and liberates the nitrogen.

2076. *Secondary effects favoured by the nascent state of the constituents: results of the researches of Becquerel and Crosse.*—It is a general law in chemistry that substances in the

nascent state, that is, when just disengaged from compounds with which they have been united, are in a condition most favourable for entering into other combinations. This explains the great facility with which the constituents of electrolytes combine with the electrodes where even a feeble affinity prevails, and also the various secondary effects. When oxygen is evolved against copper, iron, or zinc, chlorine against gold, or sulphur against silver at the electrode, oxydes of copper, iron, or zinc, chloride of gold, or sulphuret of silver are readily formed. If the current producing these changes be of very feeble intensity, so that the new compounds are very slowly formed, so slowly as more to resemble growth than strong chemical action, they will assume the crystalline structure. In this manner Becquerel and Crosse have succeeded in obtaining artificially mineral crystals, and exhibiting on a small scale effects similar to those which are in progress on a scale so vast in the mineral veins which pervade the crust of the globe, and which, doubtless, result from feeble electric currents established for countless centuries in its strata by the vicissitudes of temperature and other physical causes.

2077. *The successive action of the same current on different vessels of water.* — If the same current be conducted successively through a series of vessels containing acidulated water, by connecting the water in each vessel with the water in the succeeding vessel by platinum wires I, I', I'', I''', &c., as represented in *fig. 661.*, the current will enter each vessel at the ex-

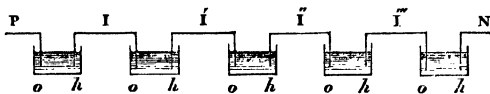

Fig. 661.

tremity *o*, and will depart from it at the extremity *h*. The water in each vessel will in this case constitute a separate electrolyte, and will be decomposed by the current. The ends *o* will be all positive, and the ends *h* all negative electrodes. Oxygen will be disengaged at all the ends *o*, and hydrogen at all the ends *h*; and if the gases disengaged be collected, the same quantity of oxygen will be found to be disengaged at the ends *o*, and the same quantity of hydrogen at the ends *h*, the volume of the latter being double that of the former. The weight of the

oxygen produced will be eight times that of the hydrogen, and the weight of the water decomposed will be nine times that of the hydrogen.

2078. *The same current has an uniform electrolytic power.* — Since it is ascertained by reometric instruments that the same current has everywhere the same intensity, it follows that this constant intensity is attended with an electrolytic power of corresponding uniformity. From this and other similar results it is inferred that the quantity of electricity which passes in a current is proportional to the quantity of a given electrolyte which the current decomposes.

2079. *Voltameter of Faraday.* — On this ground Faraday gave the name of VOLTAMETER to an apparatus similar in principle to that described in (2060.), taking water as the standard electrolyte by which the quantity of electricity necessary to effect the decomposition of any other electrolytes might be measured. Thus, if it is found that a current which decomposes in a given time an ounce of water, will in the same time decompose two ounces of one electrolyte (A), and three ounces of another electrolyte (B), it is inferred that the quantity of electricity necessary to decompose a given weight of A is half that which would decompose an equal weight of water, and that the quantity necessary to decompose a given weight of B is a third of that which would decompose the same weight of water, and, in fine, that the quantities of electricity necessary to decompose equal weights of A and B are in the ratio of 3 to 2.

2080. *Effect of the same current on different electrolytes — Faraday's law.* — If the series of vessels represented in fig. 661., connected by metallic conductors 1, 1', &c., instead of containing water, contain a series of different electrolytes, each electrolyte will be decomposed exactly as it would be if it were the only electrolyte through which the current passed. Let us suppose that the first vessel of the series which the current enters from r contains water, and that means are provided by which the quantities of oxygen and hydrogen liberated at o and h shall be indicated, and that in like manner the quantities of the constituents of each of the other electrolytes disengaged at the respective electrodes can be determined. It will then be found that for every grain weight of hydrogen liberated in the first vessel, the number of grains weight of each of the consti-



tments of the several electrolytes disengaged will be expressed by their respective chemical equivalents.

Thus, if  $e, e', e'', e'''$ , &c. be the chemical equivalents of the several constituents of the series of electrolytes, that of hydrogen being the unit, and if  $h$  express the number of grains weight of hydrogen evolved in the voltameter tube over the first vessel in a given time, then the number of grains weight of each of the constituents of the several electrolytes which shall be evolved in the same time will be

$$e \times h, e' \times h, e'' \times h, e''' \times h, \&c., \&c.$$

2081. *It comprises secondary results.* — This remarkable law extends not only to the direct results of electrolysis, but also to all the secondary effects of the current. Thus, it applies to the quantities of the several metallic electrodes which combine with the constituents which are the immediate results of the electrolysis, and also to all combinations and decompositions which result from the affinities which may exist between the results primary or secondary of the electrolysis and any foreign substances which the electrolyte may hold in solution.

2082. *Practical example of its application.* — As a practical example of the application of this electro-chemical law, let us suppose the first vessel which the current enters at  $r$  to contain water, the next iodide of potassium, the succeeding one protochloride of tin, the next hydrochloric acid, and the last sulphate of soda. The current will severally decompose these, the oxygen, iodine, chlorine and acid appearing at the five positive electrodes, and the hydrogen, potassium, tin and soda at the five negative electrodes. If the electrode against which the oxygen is evolved be zinc, the oxyde of zinc will result as a secondary product; and if the electrode against which the chlorine is evolved be gold, the chloride of that metal will likewise be produced by secondary action. The chemical equivalents of the several substances involved in this process are as follows:—

Hydrogen	-	-	-	-	-	1·00
Oxygen	-	-	-	-	-	8·00
Water	-	-	-	-	-	9·00
Iodine	-	-	-	-	-	126·30
Potassium	-	-	-	-	-	39·26
Iodide of potassium	-	-	-	-	-	165·56
Chlorine	-	-	-	-	-	35·47

Tin - - - - -	57·90
Protochloride of tin - - - - -	93·37
Hydrochloric acid - - - - -	36·47
Sulphuric acid - - - - -	40·10
Soda - - - - -	31·30
Sulphate of soda - - - - -	71·40
Zinc - - - - -	32·30
Gold - - - - -	199·20
Oxide of zinc - - - - -	40·30
Chloride of gold - - - - -	234·67

It will follow, therefore, from the general electrolytic law above stated, that for every grain of hydrogen evolved at the negative electrode in the first vessel, the following will be the quantities of the chemical results produced in the several vessels:—

I. Oxygen evolved at positive electrode - - - - -	8·00
Water decomposed - - - - -	9·00
Zinc oxydated - - - - -	32·30
Oxide of zinc produced - - - - -	40·30
II. Iodine evolved at the positive electrode - - - - -	126·30
Potassium evolved at the negative electrode - - - - -	39·26
Iodide decomposed - - - - -	165·56
III. Chlorine evolved at the positive electrode - - - - -	35·47
Tin evolved at the negative electrode - - - - -	57·90
Gold combined at positive electrode - - - - -	199·20
Chloride of gold produced - - - - -	234·67
Protochloride of tin decomposed - - - - -	93·37
IV. Chlorine evolved at positive electrode - - - - -	35·47
Hydrogen evolved at negative electrode - - - - -	1·00
Hydrochloric acid decomposed - - - - -	36·47
V. Sulphuric acid evolved at positive electrode - - - - -	40·10
Soda evolved at negative electrode - - - - -	31·30
Sulphate decomposed - - - - -	71·40

2083. *Sir H. Davy's experiments showing the transfer of the constituents of electrolytes through intermediate solutions.*— If the series of vessels containing different electrolytes be connected by liquid conductors by means of capillary siphons, instead of the metallic conductors by which they are supposed to be connected in the cases just described, phenomena are produced, respecting which a remarkable discordance has arisen between the highest scientific authorities.

From some of the early experiments of Sir H. Davy, confirmed by those of Gautherot, Hesinger, and Berzelius, it appeared that the voltaic current was not only capable of decom-

posing various classes of chemical compounds, but of transferring or decanting their constituents successively through two or more vessels, to bring them to the respective electrodes at which they are liberated. Davy pushed this inquiry to its extreme limits, and by various experiments, characterised by all that address for which he was so remarkable, arrived at certain general results which we shall now briefly state.

Let a series of cups

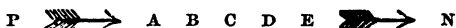

be connected by capillary siphons, which may be conveniently formed of the fibres of asbestos or amianthus. Let any electrolyte, a solution of a neutral salt for example, be placed in C, and let the other cups be filled with distilled water. Let a plate of platinum connected with the positive pole of a voltaic battery be immersed in the cup A, and a similar plate connected with the negative pole be immersed in E. The voltaic current will then enter the series of cups at A, and passing successively from cup to cup through the siphons, will issue from them at E, as indicated by the arrows. Let the water in the cups A, B, D and E be tinged by the juice of red cabbage, the property of which is to be rendered *red* by the presence of an *acid*, and *green* by that of an *alkali*.

The current thus established will, according to Sir H. Davy, decompose the salt in the cup C. The acid will be transported through the two siphons, and the water in B to the positive electrode in A, where it will be liberated, and will enter into solution with the tinged water. At the same time the alkali will pass through the two siphons, and the cup D to the negative electrode, and will enter into solution with the water in D.

The presence of the acid in A and of the alkali in E will be rendered manifest by the red colour imparted to the contents of the former, and the green to the latter.

2083\*. *While being transferred they are deprived of their chemical property.*—Although to arrive at A and E respectively, the acid must pass through B and the alkali through E, their presence in these intermediate cups is not manifested by any change of colour. It was therefore inferred by Sir H. Davy, that so long as the constituents of the salt are under the immediate influence of the current, they lose their usual

properties, and only recover them when dismissed at the electrodes by which they have been respectively attracted.

If the direction of the current be reversed, so that it shall enter at E and issue from A, the constituents of the salt will be transported back to the opposite ends of the series, the acid which had been deposited in A, will be transferred successively through the cups B, C, D, and the intermediate siphons to the cup E, and the alkali in the contrary direction from E through D, C, B, and the siphons to A. This will be manifested by the changes of colour of the infusions. The liquid in A which had been reddened by the acid, will first recover its original colour, and then become green according as the ratio of the acid to the alkali in it is diminished; and in like manner the infusion in E, which had been rendered green by the alkali, will gradually recover its primitive colour, and then become red as the proportion of the acid to the alkali in it is augmented.

During these processes no change of colour will be observed in the intermediate cups B and D.

The intermediate cups B and D being filled with various chemical solutions for which the constituents of the salt had strong affinities, and with which under any ordinary circumstances they would immediately enter into combination, these constituents nevertheless invariably passed through the intermediate vessels without producing any discoverable effect upon their contents. Thus, sulphuric acid passed in this manner through solutions of ammonia, lime, potash, and soda, without affecting them. In like manner hydrochloric and nitric acids passed through concentrated alkaline menstrua without any chemical effect. In a word, acids and alkalis having the strongest mutual affinities, were thus reciprocally made to pass each through the other without manifesting any tendency to combination.

2084. *Exception in the case of producing insoluble compounds.* — Strontia and baryta passed in the same way through muriatic and nitric acids, and reciprocally these acids passed with equal facility through solutions of strontia and baryta. But an exception was encountered when it was attempted to transmit strontia or baryta through a solution of sulphuric acid, or *vice versâ*. In this case the alkali was arrested *in transitu* by the acid, or the acid by the alkali, and the salt resulting from their combination was precipitated in the intermediate cup.

The exception therefore generalised included those cases in which bodies were attempted to be transmitted through menstrua for which they have an affinity, and with which they would form an insoluble compound.

2085. *This transfer denied by Faraday.*—This transmission of chemical substances through solutions with which they have affinities by the voltaic current, those affinities being rendered dormant by the influence of the current which appeared to be established by the researches of Davy, published in 1807, and since that period received by the whole scientific world as an established principle, has lately been affirmed by Dr. Faraday to be founded in error. According to Faraday no such transfer of the constituents of a body decomposed by the current can or does take place. He maintains that in all cases of electrolysis it is an absolutely indispensable condition that there be a continuous and unbroken series of particles of the electrolyte between the two electrodes at which its constituents are disengaged. Thus, when water is decomposed, there must be a continuous line of water between the positive electrode at which the oxygen is developed and the negative electrode at which the hydrogen is disengaged. In like manner, when the sulphate of soda or any other salt is decomposed, there must be a continuous line of particles of the salt between the positive electrode at which the acid appears and the negative electrode at which the alkali is deposited.

Dr. Faraday affirms, that in Davy's celebrated experiments, in which the acid and alkaline constituents of the salt appear to be drawn through intermediate cups containing pure water or solutions of substances foreign to the salt, the decomposition and apparent transfer of the constituents of the salt could not have commenced until, by capillary attraction, a portion of the salt had passed over through the siphons, so that a continuous line of saline particles was established between the electrodes. Dr. Faraday admits such a transfer of the constituents as may be explained by the series of decompositions and recompositions involved in the hypothesis of Grotthuis.

2086. *Apparent transfer explained by him on Grotthuis' hypothesis.*—It is also admitted by Dr. Faraday, that when pure water intervenes between the metallic conductors proceeding from the pile and the electrolyte, decomposition may ensue, but he considers that in this case the true electrodes

are not the extremities of the metallic conductors, but the points where the pure water ends and the electrolyte begins, and that accordingly in such cases the constituents of the electrolyte will be disengaged, not at the surfaces of the metallic conductors, but at the common surfaces of the water and the electrolyte. As an example of this he produces the following experiment. Let a solution of the sulphate of magnesia be covered with pure water, care being taken to avoid all admixture of the water with the saline solution. Let a plate of platinum proceeding from the negative pole of a battery be immersed in the water at some distance from the surface of the solution on which the water rests, and at the same time let the solution be put in metallic communication with the positive pole of the battery. The decomposition of the sulphate will speedily commence, but the magnesia, instead of being deposited on the platinum plate immersed in the water, will appear at the common surface of the water and the solution. The water, therefore, and not the platinum, is in this case the negative electrode.

2087. *Faraday thinks that conduction and decomposition are closely related.*—Dr. Faraday maintains that the connection between conduction and decomposition, so far as relates to liquids which are not metallic, is so constant that decomposition may be regarded as the chief means by which the electric current is transmitted through liquid compounds. Nevertheless, he admits, that when the intensity of a current is too feeble to effect decomposition, a quantity of electricity is transmitted sufficient to affect the reoscope.

In accordance with those principles, Faraday affirms that water which conducts the electric current in its liquid state, ceases to do so when it is congealed, and then it also resists decomposition, and in fine ceases to be an electrolyte. He holds that the same is true of all electrolytes.

2088. *Maintains that non-metallic liquids only conduct when capable of decomposition by the current.*—The connection between decomposition and conduction is further manifested, according to Dr. Faraday, by the fact that liquids which do not admit of electro-chemical decomposition, do not give passage to the voltaic current. In short, that electrolytes are the only liquid non-metallic conductors.

2089. *Faraday's doctrine, not universally accepted*—*Pouil-*

*let's observations.* — These views of Dr. Faraday have not yet obtained general acceptance ; nor have the discoveries of Davy of the transfer and decantation of the constituents of electrolytes through solutions foreign to them, been yet admitted to be overthrown. Peschel and other German authorities in full possession of Faraday's views and the results of his experimental researches, still continue to reproduce Davy's experiments, and to refer to their results and consequences as established facts. Pouillet, writing in 1847, and also in possession of Faraday's researches, which he largely quotes, maintains nevertheless the *transport* of the constituents under conditions more extraordinary still, and more incompatible with Faraday's doctrine than any imagined by Davy. In electrochemical decomposition he says, — "There is at once separation and transport. Numberless attempts have been made to seize the molecule of water which is decomposed, or to arrest *en route* the atoms of the constituent gases before their arrival at the electrodes, but without success. For example, if two cups of water, one containing the positive and the other the negative wire of a battery, be connected by any conductor, singular phenomena will be observed. If the intermediate conductor be metallic, decomposition will take place independently in both cups" (as already described), "but if the intermediate conductor be the human body, as when a person dips a finger of one hand into the water in one cup, and a finger of the other hand into the other, the decomposition will sometimes proceed as in the case of a metallic connection ; but more generally oxygen will be disengaged at the wire which enters the positive cup, and hydrogen at the wire which enters the negative cup, no gases appearing at the fingers immersed in the one and the other. It would thus appear that one or other of the constituent gases must pass through the body of the operator in order to arrive at the pole at which it is disengaged. And even when the two cups are connected by a piece of ice, the decomposition proceeds in the same manner, one or other gas appearing to pass through the ice, since they are disengaged at the poles in the separate cups in the same manner."\*

2090. *Davy's experiments repeated and confirmed by Becquerel.* — The experiments of Davy, in which the transfer of

\* Pouillet, *Elements de Physique*. Ed. 1847, vol. i. p. 598.

the constituents of an electrolyte through water and through solutions for which these constituents have affinities, was demonstrated, have been repeated by Becquerel, who has obtained the same results. The capillary siphons used by Becquerel were glass tubes filled with moistened clay. He also found that the case in which the constituent transferred would form an insoluble compound with the matter forming the intermediate solution, forms an exception to this principle of transfer; but he observed that this only happens when the intensity of the current is insufficient to decompose the compound thus formed in the intermediate solution.\*

2091. *The electrodes proved to exercise different electrolytic powers by Pouillet.* — The question whether the decomposing agency resides altogether at one or at the other electrode, or is shared between them, has been recently investigated by M. Pouillet.

Let three tubes of glass having the form of the letter U, *fig. 662.*, be prepared, each of the vertical arms being about five inches long, and half an inch in diameter. Let the curved part of the tubes connecting the legs have a diameter of about the twentieth of an inch when the solutions used are good conductors, but the same diameter as the tubes themselves when the conducting power is more imperfect. In this

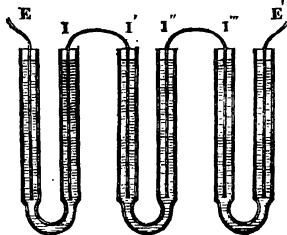

Fig. 662.

latter case, however, the results are less exact and satisfactory.

Let platinum wire  $E$  and  $E'$  proceeding from the poles of a voltaic battery be plunged in the first and last tubes, and let the intermediate tubes be connected by similar wires  $II'$  and  $I''I'''$ . Let acidulated water be poured into the tube  $EI$ , and the solutions on which the relative effects of the two electrodes are to be examined, into the other tubes  $II''$  and  $I'''E'$ . After the electrolysis has been continued for a certain time, the quantity of the solution decomposed in each leg may be ascertained by submitting the contents of each leg to analysis. The quantity remaining undecomposed being thus ascertained and sub-

\* Becquerel, *Traité de Physique*, vol. ii. p. 330. Ed. 1844.



tracted from the original quantity, the remainder will be the quantity decomposed, since the fluids are prevented from intermixing to any sensible extent by the smallness of the connecting tube, and by being nearly at the same level during the process. It may be assumed that the decomposing agencies of the two electrodes will be proportional to the quantities of the solutions decomposed in the legs in which they are respectively immersed.

2092. *Case in which the negative electrode alone acts.* — The current being first transmitted through a voltameter to indicate the actual quantity of electricity transmitted, the tubes  $E_1$ ,  $E_1'$  and  $E_1''$  were filled, the first with a solution of the chloride of gold, the next with the chloride of copper, and the third with the chloride of zinc. After the lapse of a certain interval the contents of the tubes were severally examined, and it was found that the solutions in legs in which the positive electrodes were immersed had suffered no decomposition. The quantities of the chlorides contained in them respectively were undiminished, while the chloride in each of the legs containing the negative electrodes was diminished by exactly the quantity corresponding to the metal deposited in the negative wire, and the chlorine transferred to the positive leg.

It was therefore inferred that in these cases the entire decomposing agency must be ascribed to the negative electrode.

The same results were obtained for the other metallic chlorides.

2093. *Cases in which the electrodes act unequally.* — The alkaline chlorides showed somewhat different properties. In the case of the chloride of magnesium the agency of the negative was found to be greater than that of the positive electrode, but it was not exclusively efficacious. In the cases of the chlorides of potassium, sodium, barium, &c., the agency was also shared by the true electrodes, but the agency of the positive electrode was found to be greater than the negative in the ratio of about three to one.

2094. *Liquid electrodes* — *Series of electrolytes in immediate contact.* — In general, the electrodes by which the current enters and departs from an electrolyte, are solid and most frequently metallic conductors. In an experiment already cited (2086.), Faraday has shown that water may become an electrode, and Pouillet in some recent experiments has succeeded

in generalising this result, and has shown not only that the current may be transmitted to and received from an electrolyte by liquid conductors, but that a series of different electrolytes may become mutual electrodes, the current passing immediately from one to the other without any intermediate conductor, solid or liquid, and that each of them shall be electrolysed. Thus suppose that the series of electrolytes are expressed by

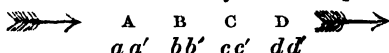

the current as indicated by the arrows entering A, and departing from D, and being supposed to have sufficient intensity to effect the electrolysis of all the solutions. Let the electro-negative constituents be expressed by  $a, b, c, d$ , and the electro-positive by  $a', b', c', d'$ . It is evident that the points at which any two succeeding solutions touch, will be at the same time the negative electrode of the first, and the positive electrode of the second, and that, consequently, the positive constituent of the first and the negative constituent of the second will be disengaged at this point, and being in the nascent state will be under the most favourable conditions to combine in virtue of their affinities, and so to form new compounds as secondary effects. Thus, the common surface of A and B will be the negative electrode of A, and the positive electrode of B, because it is at this surface that the current departs from A and enters B, and accordingly the electro-positive constituent  $a'$  of A, and the electro-negative constituent  $b$  of B, will be developed at this common surface, and if they have affinity, will enter into combination.

2095. *Experimental illustration of this.* — These principles may be experimentally illustrated and verified by placing the

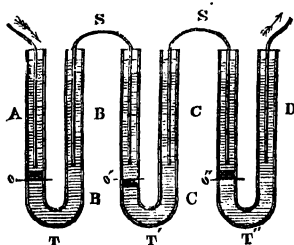

Fig. 663.

electrolytic solutions in U-shaped tubes T, T', T'', as represented in *fig. 663*. Let two electrolytic solutions A and B be introduced into the first tube T, so carefully as to prevent them from intermixing, and let their common surface be at  $e$ . In like manner let the solutions B and C be introduced into the tube T', and the solutions C and D into the

tube  $\tau''$ , their common surfaces being at  $o'$  and  $o''$ . Let the legs of the tubes  $\tau$  and  $\tau'$ , which contain the solution B, be connected by a glass siphon containing the same solution, and the legs of the tubes  $\tau'$  and  $\tau''$ , containing the solution C, be similarly connected. Let the positive wire of a battery be immersed in A, and the negative wire in D, the current being sufficiently intense to electrolyse all the solutions.\*

In this case  $o$  will be the positive electrode of B, and the negative electrode of A,  $o'$  the positive electrode of C, and the negative electrode of B, and  $o''$  the positive electrode of D, and the negative electrode of C.

If A be pure water, B the chloride of zinc, the water being decomposed, oxygen will be disengaged at the positive wire, and hydrogen at the common surface  $o$ . The chloride being also decomposed, the chlorine, its electro-negative constituent, will be disengaged at  $o$ , where it will enter into combination with the hydrogen, and form hydrochloric acid, the presence of which may be ascertained by the usual tests. The oxyde of zinc, the electro-positive constituent of B, will be disengaged at  $o'$ , and will form a compound with the electro-negative constituent of C, and so on.

2096. *Electrolysis of the alkalis and earths.*—The decomposing power of the voltaic current had not long been known before it became, in the hands of Sir H. Davy and his successors, the means of resolving the alkalis and earths, before that time considered as simple bodies, into their constituents. This class of bodies was shown to be oxydised metals. When submitted to such conditions as enabled a strong voltaic current to pass through them, oxygen was liberated at the positive electrode, and the metallic base appeared at the negative electrode.

2097. *The series of new metals.*—A new series of metals was thus discovered, which received names derived from those of the alkalis and earths of which they formed the bases. Thus, the metallic base of potash was called POTASSIUM, that of soda, SODIUM, that of lime, CALCIUM, that of silica, SILICIUM, and so on.

\* This is not the experimental arrangement adopted by M. Pouillet. It has occurred to me, as a method of exhibiting his principle under a more general form and somewhat more clearly and satisfactorily than his apparatus, in which the siphons  $s, s'$  have no place.

In many cases it is difficult to maintain those metals in their simple state, owing to their strong affinity for oxygen. Thus potassium, if exposed to the atmosphere at common temperatures, enters directly into combination with the air, and burns. When it is desired to collect and preserve it in the metallic state it is decomposed by the current in contact with mercury, with which it enters into combination, forming an amalgam. It is afterwards separated by distillation from the mercury, and preserved in the metallic state under the oil of naphtha, in a glass tube hermetically closed, the air being previously expelled.

2098. *Schœnbein's experiments on the passivity of iron.*— Among the effects of the voltaic current which have been not satisfactorily or not at all explained, are those by which iron, under certain conditions, is enabled to resist oxydation even when exposed to agents of the greatest power; such, for example, as nitric acid. The most remarkable researches on this subject are those of Schœnbein. In his experiments, the wires proceeding from the poles of the battery were immersed in two mercurial cups, which we shall call P and N. A bath of water B, acidulated with about 8 per cent. of sulphuric acid, was then connected with the cup N by a platinum wire. A piece of iron wire was placed with one extremity in P, and the other in the bath B. No oxydation was manifested at the end immersed in the bath, and no hydrogen was evolved at the platinum wire. In fine, no electrolysis took place.

Several circumstances were found to restore to the iron its oxydable property, and to establish the electrolysis of the liquid in the bath, but only for a short interval of a few seconds. These circumstances were:— 1. The contact for a moment of the platinum and iron wires in the bath. 2. The momentary suspension of the current by breaking the contact at any point of the circuit. 3. The contact of any oxydable metal, such as zinc, tin, copper, or silver, with the iron in the bath. 4. The momentary diversion of a portion of the current, by connecting the cups P and N by a copper wire, without breaking the connections of the original circuit. 5. By agitating the end of the iron wire in the bath.

If in connecting P and B by the iron wire the wire be first immersed in B, oxydation will take place for some seconds after the other acid is immersed in P.

The intensity of the current diverted by connecting the cups P and N by a copper wire, can be varied at pleasure by varying the length and section of the connecting wire (2063.). When such a derived current is established, several curious and interesting phenomena are observed. When the derived current has great intensity, no effect is produced upon the iron. Upon gradually diminishing the intensity of the derived current, the iron becomes *active*, that is, susceptible of oxydation. With a less intensity it again becomes *passive*, and the oxydation ceases. As the derived current is gradually reduced to that intensity at which the iron becomes permanently *passive*, there are several successive periods during which it is alternately *active* and *passive*, the intervals between these periods being less and less. In the apparatus of Schœnbein the iron became permanently active when the copper wire conducting the derived current was half a line thick, and from 6 inches to 16 feet long.

These effects are reproduced with all the oxacids, but are not manifested either with the hydracids or the Haloid salts.

2099. *Other methods of rendering iron passive.* — Iron may be rendered passive also by placing it as the positive electrode in a solution of acetate of lead with a current of ordinary intensity. The iron should be immersed in the solution for about half a minute to a depth of about half an inch. A wire thus treated being washed clean, acquires the permanently passive property, even though the part immersed in the solution has not been coated with the peroxyde of lead. And in this case the conditions above stated under which it recovers momentarily its active character, become inoperative.

Iron thus *galvanised* acquires to a great degree the virtue of platinum and the other highly negative metals, and for many purposes may be substituted for them. Thus Schœnbein has constructed voltaic batteries of passive iron and zinc.

The iron wire used for telegraphic purposes is rendered passive by this process.

2100. *Tree of Saturn.* — The well known experiment of the TREE OF SATURN presents a remarkable example of the effect of a feeble current of long continuance. A bundle of brass wires is passed through a hole made longitudinally through the centre of a bottle cork, and fitted tightly in it so as to diverge in a sort of cone from the bottom of the cork. A plate of zinc is

then tied round the wires at the point where they diverge from the cork, so as to be in contact with all the wires. The wires and cork are then introduced into a glass flask containing a limpid solution of the acetate of lead, and the top of the cork luted over to prevent the admission of air. The zinc and brass thus immersed in the solution form a voltaic pair, and a current passes through the solution from the zinc to the wire. The water of the solution is slowly decomposed, the oxygen combining with the zinc, and the hydrogen attracting the oxygen from the oxyde of lead, and reproducing water, while the metallic lead attaches itself to the wires. The acetic acid liberated by the secondary decomposition of the acetate of lead, enters into combination with the oxyde of zinc, and produces the acetate of that metal, which passes into solution in the water. The contents of the flask are gradually converted into a solution of the acetate of zinc, and the metallic lead, the process being very slow, is crystallised in a variety of beautiful forms upon the divergent brass wire.

2101. *Davy's method of preserving the copper sheathing of ships.* — The method proposed by Sir H. Davy to preserve from corrosion the copper sheathing of ships, depends on the long-continued action of feeble currents. The copper is united with a mass of zinc, iron, or some more oxydable metal, so as to form a voltaic combination. The sea-water being a weak solution of salt, a feeble permanent current is established between the more and less oxydable metals, passing through the water from the latter to the former, and causing its slow decomposition. The oxygen combines with the protecting metal, and the hydrogen disengaged on the copper, decomposes the salts held in solution in the sea water, attracting their oxyde constituents, such as lime, magnesia, &c., which are deposited upon the copper in a rough crust. Upon the coating thus formed collect marine vegetation, shells, and other substances. Thus, while the copper sheathing is preserved from corrosion, there arises the counteracting circumstance of an appendage to the hull of the ship, which impedes its sailing qualities.

2102. *Chemical effects produced in voltaic batteries.* — The fluids interposed between the solid elements of all forms of voltaic arrangements may be regarded as electrolytes, the solid elements in contact with them being the electrodes. In all arrangements in which one acid solution is interposed between

two solids, one of which is more oxydable than the other, the primary chemical effect is the decomposition of the water of the solution, the oxygen being disengaged upon the more and the hydrogen upon the less oxydable metal. The partisans of the chemical origin of the current contend, that in this case the oxygen gives up its negative electricity to the more oxydable, and the hydrogen its positive to the less oxydable metal, so that if those metals be connected by a metallic wire outside the system, a current will be established on the wire, directed from the less to the more oxydable metal, which is found to be in effect what actually takes place.

The secondary effects are very various and complicated, and are in accordance with the principles of electrolytic action already explained. The first is the production of an oxyde of the more oxydable metal. If the liquid element be an acid solution, this oxyde will, in general, enter into combination with the acid, forming a salt which will be the next secondary effect. The hydrogen evolved against the less oxydable metal, may either be liberated in the gaseous state, or attract an equivalent of oxygen from one of the substances dissolved in the liquid element, thereby reproducing water, and decomposing the substances thus attacked.

2103. *Effect of amalgamating the zinc.*—The advantage which attends the amalgamation of the zinc (1862.), in batteries in which that metal is used, is, that it is thus protected from the direct action of the acid by which the metal would be consumed, without contributing to the supply of the current. Zinc being a metal eminently susceptible of oxydation, would be affected by the acid even in the weakest solutions, and a portion of the metal more or less according to the strength of the solution would be oxydated, a corresponding quantity of the acid being decomposed. This would produce the twofold inconvenience of the ineffectual consumption of both the metal and the acid. By the process of amalgamation the surface of the zinc is coated with a thin stratum of amalgam, which is proof against the acid, and which on the other hand increases the susceptibility of the metal to combine with the oxygen disengaged from the water by the current.

2104. *Effects in Smee's battery.*—The preceding observations are more or less applicable to all the single fluid arrangements described in (1858.) to (1863.), as well as to Smee's

system (1870.). It has been found that the intensity of the current in the system of Smee, has been greatly augmented by *platinisation* of the surface of the metal used as the negative pole of the system. The process by which this effect is produced is as follows. The surface of the metal being scraped quite clean, it is immersed in a solution of the double chloride of potassium and platinum, and being connected with the negative pole of a battery, of which the positive pole is connected with the solution by a plate of platinum immersed in it, electrolysis takes place, platinum being deposited on the negative electrode as a secondary result. The positive platinum electrode is meanwhile attacked by the chlorine, and dissolved so as to maintain the solution in the proper state of saturation.

Mr. Smee, after trying plates of iron and silver, substituted for them plates of platinum, the surface of which was platinised by this process, and an improved action ensued. M. Bouquillon substituted for them a plate of copper, upon the surface of which a rough coating of copper was first deposited by a similar process, and upon this a coating of silver, over which a coating of platinum was deposited. By this means the plate is stated to have acquired in the highest degree the power of liberating the hydrogen, and stimulating the current.

2105. *In Wheatstone's battery.*—In the system of Wheatstone (1871.), in which a single fluid, a saturated solution of sulphate of copper, is used as the exciting fluid, the water of the solution is electrolysed. The oxygen combines with the zinc of the amalgam, and forms as a secondary result an oxyde. The hydrogen disengaged upon the copper acts upon the sulphate, whose constituents are sulphuric acid and the protoxyde of copper. It attracts the oxygen from the protoxyde, with which it combines, forming water. The metallic copper and the acid are both liberated, the latter entering into combination with the oxyde of zinc, and forming the sulphate of that oxyde. For each equivalent of zinc oxydated, there is therefore an equivalent of metallic copper, and an equivalent of the sulphate of the oxyde of zinc produced.

2106. *In the two fluid batteries.*—In batteries in which two fluids separated by a porous diaphragm are interposed between the solid elements, chemical effects somewhat more complicated are exhibited, and indeed authorities are not in accordance as to the principles on which the phenomena are explicable.



2107. *Grove's battery*.—In the case of Grove's battery (1865.), the primary phenomenon is the decomposition of the water of the two solutions which is effected through the cylinder of porous porcelain, the oxygen being disengaged upon the zinc, and the hydrogen upon the platinum. The secondary effects are—1. The oxydation of the zinc. 2. The combination of the oxyde with the acid, producing sulphate of zinc, which is deposited in the acid solution. 3. The combination of the hydrogen with one equivalent of the oxygen of the nitric acid, by which water is reproduced, and the *nitric* reduced to *nitrous* acid, which is evolved in the gaseous state.

2108. *Bunsen's battery*.—The same phenomena are manifested in the battery of Bunsen (1866.), which differs from that of Grove only in the substitution of the carbon for the platinum element.

2109. *Daniel's battery*.—The theory of the chemical phenomena developed in the operation of Daniel's constant battery (1867.), has not been clearly determined. During the performance of the apparatus metallic copper is deposited on the copper cylinder *cc*, *fig.* 541., which contains the solution of the sulphate of copper. The solution itself would become gradually less concentrated, but it is maintained in a state of saturation by the continual dissolution of the salt, which rests upon the wire grating *g*, and the sulphate of the oxyde of zinc accumulates in the cylinder *pp*. The fluid in this vessel *pp*, which is at the beginning a weak solution of sulphuric acid, is gradually converted into a solution of the sulphate of zinc, which is stated by Pfaff, Paggendorf, and others to be nearly as effective as an exciting fluid as the original acid solution. The electromotive virtue of the zinc in this case is therefore but little, and that of the copper not at all impaired by the continued action of the battery.

The chemical changes which are effected in this battery may be explained as follows. A double electrolysis may be imagined as a primary effect, that of the water contained in the two solutions, the electrolytic action being transmitted through the intermediate porous cylinder and that of the sulphate, the acid constituent being transmitted to the zinc through the porous cylinder, and through the solution contained in it in the same manner as the constituents of the electrolyte in Davy's experiments (2082.), were transmitted through the capillary

siphons and the intermediate solutions. The secondary phenomena would be as follows:—The hydrogen of the decomposed water developed on the copper in a nascent state, would attract the oxygen of the oxyde of copper also developed on the copper in a nascent state by the decomposition of the salt. Water would thus be reproduced in a quantity equal to that lost by decomposition, and the metallic copper of the oxyde would be deposited on the copper cylinder. The solution of the sulphate being reduced below saturation by the amount of the salt thus decomposed, an equal quantity would be received by dissolution from the salt in G, which would restore it to the state of saturation. Meanwhile the acid constituent of the salt would be transferred to the zinc, where it would combine with the oxyde of that metal formed by its combination with the oxygen of the decomposed water developed upon it, and the sulphate of the oxyde would be formed, which would be dissolved in the solution, leaving the amalgamated zinc free to the further operation of the current.

This interpretation of the phenomena cannot be admitted by those who, with Dr. Faraday, reject the principle of the transfer of an electrolyte through a menstruum foreign to it, unless indeed it be assumed that some small portions of the sulphate must pass through the porous cylinder, and mix with the acid solution.

However this may be, we are not aware that any other satisfactory explanation has been proposed for the phenomena developed in this battery.

## CHAP. XIII.

### ELECTRO-METALLURGY.

2110. *Origin of this art.*—The decomposing power of the voltaic current applied to solutions of the salts and oxydes of metals has supplied various processes to the industrial arts, which inventors, improvers, and manufacturers have denominated galvanoplastic, electroplastic, galvanotype, electrototype, and electroplating and gilding. These processes and their re-

sults may be comprehended under the more general denomination, **ELECTRO-METALLURGY**.

2111. *The metallic constituent deposited on the negative electrode.*—If a current of sufficient intensity be transmitted through a solution of a salt or oxyde, having a metallic base, it will be understood, from what has been already explained, that while the oxygen or acid is developed at the positive electrode, the metal will be evolved either by the primary or secondary action of the current at the negative electrode, and being in the nascent state, will have a tendency to combine with it, if there be an affinity, or to adhere to it by mere cohesion, if not.

2112. *Any body may be used as the negative electrode.*—The bodies used as electrodes must be *superficially* conductors, since otherwise the current could not pass between them; but subject to this condition, they may have any material form or magnitude which is compatible with their immersion in the solution. If the body be metallic, its surface has necessarily the conducting property. If it be formed of a material which is a non-conductor, or an imperfect conductor, the power of conduction may be imparted to its surface by coating it with finely powdered black lead and other similar expedients. This process is called *metallising* the surface.

2113. *Use of a soluble positive electrode.*—By the continuance of the process of decomposition the solution would be rendered gradually weaker, and the deposition of the metal would go on more slowly. This inconvenience is remedied by using, as the positive electrode, a plate of the same metal, which is deposited on the negative electrode. The acid or oxygen liberated in the decomposition, in this case, enters into combination with the metal of the positive electrode, and produces as much salt or oxyde, as is decomposed at the other electrode, which salt or oxyde being dissolved as fast as it is formed, maintains the solution at a nearly uniform degree of strength.

2114. *Conditions which affect the state of the metal deposited.*—The state of the metal disengaged at the negative electrode depends on the intensity of the current, the strength of the solution, its acidity, and its temperature, and the regulation of these conditions in each particular case, will require much practical skill on the part of the operator, since few general rules can be given for his direction.

In the case, for example, of a solution of one of the salts of

copper, a feeble current will deposit on the electrode a coating of copper so malleable that it may be cut with a knife. With a more intense current the metal will become harder. As the intensity of the current is gradually augmented, it becomes successively brittle, granulous, crystalline, rough, pulverulent, and in fine loses all cohesion,—practice alone will enable the operator to observe the conditions necessary to give the coating deposited on the electrode the desired quality.

2115. *The deposit to be of uniform thickness.*—It is in all cases desirable, and in many indispensable, that the metallic coating deposited on the electrode shall have an uniform thickness. To insure this, conditions should be established which will render the action of the current on every part of the surface of the electrode uniform, so that the same quantity of metal may be deposited in the same time. Many precautions are necessary to attain this object. Both electrodes should be connected at several points with the conductors, which go to the poles of the battery, and they should be presented to each other so that the intermediate spaces should be as nearly as possible equal, since the intensities of the currents between point and point vary with the distance. The deposition of the metal is also much influenced by the form of the body. It is in general more freely made on the salient and projecting parts, than in those which are sunk.

2116. *Means to prevent absorption of the solution by the electrode.*—If the body on which the metallic deposit is made be one which is liable to absorb the solution, a coating of some substance must be previously given to it which shall be impervious to the solution.

2117. *Non-conducting coating used where partial deposit is required.*—When a part only of a metallic or other conducting body is desired to be coated with the metallic deposit, all the parts immersed not intended to be so coated are protected by a coating of wax, tallow, or other non-conductor.

2118. *Application of these principles to gilding, silvering, &c.*—The most extensive and useful application of these principles in the arts is the processes of gilding and silvering articles made of the baser metals. The article to be coated with gold being previously made perfectly clean, is connected with the negative pole of the battery, while a plate of gold is connected with its positive pole. Both are then immersed in a bath consisting of

a solution of the chloride of gold and cyanide of potassium, in proportions which vary with different gilders. Practice varies also as to the temperature and strength of the solution. The chloride is decomposed, the metallic base being deposited as a coating on the article connected with the negative pole, and the chloride combining with a corresponding portion of the gold connected with the positive pole, and reproducing the chloride which is dissolved in the bath as fast as it is decomposed, thus maintaining the strength of the solution.

A coating of silver, copper, cobalt, nickel, and other metals is deposited by similar processes.

2119. *Cases in which the coating is inadhesive.* — When the article on which the coating is deposited is metallic, the coating will in some cases adhere with great tenacity. In others, the result is less satisfactory; as, for example, where gold is deposited on iron or steel. In such cases the difficulty may be surmounted by first coating the article with a metal which will adhere to it, and then depositing upon this the definitive coating.

2120. *Application to gilding, silvering, or bronzing objects of art.* — The extreme tenuity with which a metallic coating may be deposited by such processes, supplies the means of imparting to various objects of art the external appearance and qualities of any proposed metal, without impairing in the slightest degree their most delicate forms and lineaments. The most exquisitely moulded statuette in plaster may thus acquire all the appearance of having been executed in gold, silver, copper, or bronze, without losing any of the artistic details on which its beauty depends.

2121. *Production of metallic moulds of articles.* — If it be desired to produce a metallic mould of any object, it is generally necessary to mould it in separate pieces, which being afterwards combined, a mould of the whole is obtained. That part intended to be moulded is first rubbed with sweet oil, blacklead, or some other lubricant, which will prevent the metal deposited from adhering to it, without separating the mould from the surface, in so sensible a degree as to prevent the perfect correspondence of the mould with the original. All that part not intended to be moulded is invested with wax or other material, to intercept the solution. The object being then immersed, and the electrolysis established, the metal will be deposited on the

exposed surface. When it has attained a sufficient thickness the object is withdrawn from the solution, and the metallic deposit detached. It will be found to exhibit, with the utmost possible precision, an impression of the original. The same process being repeated for each part of the object, and the partial moulds thus obtained being combined, a metallic mould of the whole will be produced.

2122. *Production of objects in solid metal.* — To reproduce any object in metal it is only necessary to fill the mould of it, obtained by the process above explained, with the solution of the metal of which it is desired to form the object, the surface of the mould being previously prepared, so as to prevent adhesion. The solution is then put in connection with the positive pole of the pile, while the mould is put in connection with the negative pole. The metal is deposited on the mould, and when it has attained the necessary thickness the mould is detached, and the object is obtained.

In general, however, it is found more convenient to mould the object to be reproduced in metal by the ordinary processes in wax, plaster of paris, or fusible alloy. When they are made in wax, plaster, or any non-conducting material, their inner surfaces must be rubbed with black-lead, to give them the conducting power. When the deposit is made of the necessary thickness, the mould is broken off or otherwise detached.

Statues, statuettes, and bas-reliefs in plaster can thus be reproduced in metal with the greatest facility and precision, at an expense not much exceeding that of the metal of which they are formed.

2123. *Reproduction of stereotypes and engraved plates.* — A mould in plaster of paris or wax being taken from a wood engraving and a stereotype plate, a stereotype may be obtained from the mould by the processes above described. Stereotypes by the ordinary processes of casting in type metal are, however, produced at less expense.

Copper or steel engraved plates may be multiplied by like methods. A mould is first taken, which exhibits the engraving in relief. A metallic plate deposited upon this by the electrolytic process will reproduce the engraved plate.

2124. *Metallising textile fabrics.* — The electro-metallurgic processes have been extended by ingenious contrivances to other substances besides metal. Thus a coating of metal may

be deposited on cloth, lace, or other woven fabric, by various ingenious expedients, of which the following is an example: — On a plate of copper attach smoothly a cloth of linen, cotton, or wool, and then connect the plate with a negative pole of a voltaic battery, immerse it in a solution of the metal with which it is to be coated, and connect a piece of the same metal with the positive pole; decomposition will then commence, and the molecules of metal, as they are separated from the solution, must pass through the cloth in advancing to the copper to which the cloth is attached. In their passage through the cloth they are more or less arrested by it. They insinuate themselves into its pores, and, in fine, form a complete metallic cloth. Lace is metallised in this way by first coating it with plumbago, and then subjecting it to the electro-metallurgic process.

Quills, feathers, flowers, and other delicate fibrous substances may be metallised in the same way. In the case of the most delicate of these the article is first dipped into a solution of phosphorus and sulphate of carbon, and is well wetted with the liquid. It is then immersed in a solution of nitrate of silver. Phosphorus has the property of reviving silver and gold from their solutions. Consequently, the article is immediately coated with a very attenuated fibre of the metal.

2125. *Glyphography*. — If a thin stratum of wax or other soft substance be spread upon a plate of metal, any subject or design may be engraved upon the coating without more labour than would be expended on a pencil drawing. When the engraving is thus made on the wax it is subjected to the electrotype process, by which a sheet of copper or other metal is deposited upon it. When this is detached it exhibits in relief the engraving, from which impressions may be produced in the same manner as from a wood engraving, to which it is altogether analogous.

2126. *Reproduction of Daguerreotypes*. — One of the most remarkable and unexpected applications of the electrotype process is to Daguerreotypes. The picture being taken upon the plate by the usual process of Daguerreotype, a small part of the back is cleaned with sand-paper, taking care not to allow the face of the plate to be touched. A piece of wire is then soldered to the part of the back thus prepared. The plate is then immersed in a solution of copper, and connected with the

battery, the back being protected by a coating of wax. After a deposit of sufficient depth has been made upon the face of the plate, it is withdrawn from the solution, and the plate of copper deposited being detached, exhibits the picture with an expression softer and finer than the original. By this process when conducted with skill, several copies may be taken from the same Daguerreotype.

If the electrotype copy thus obtained be passed through a weak solution of the cyanide of gold and potassium in connexion with a weak battery, a beautiful golden tint will be imparted to the picture, which serves to protect it from being tarnished.

## CHAP. XIV.

### ELECTRO-TELEGRAPHY.

2127. *Common principle of all electric telegraphs.* — Of all the applications of electric agency to the uses of life, that which is transcendently the most admirable in its effects, and the most important in its consequences, is the electric telegraph. No force of habit, however long continued, no degree of familiarity can efface the sense of wonder which the effects of this most marvellous application of science excite.

The electric telegraph, whatever form it may assume, derives its efficiency from the three following conditions: —

1. A power to develop the electric fluid continuously, and in the necessary quantity.

2. A power to convey it to any required distance without being injuriously dissipated.

3. A power to cause it, after arriving at such distant point, to make written or printed characters, or some sensible signs serving the purpose of such characters.

The apparatus from which the moving power by which these effects are produced is derived, is the voltaic pile or galvanic battery. This is to the electric telegraph what a boiler is to a steam engine. It is the generator of the fluid by which the action of the machine is produced and maintained.

We have therefore first to explain how the electric fluid,



generated in the apparatus just explained, can be transmitted to a distance without being wasted or dissipated in any injurious degree *en route*.

If tubes or pipes could be constructed with sufficient facility and cheapness, through which the subtle fluid could flow, and which would be capable of confining it during its transit, this object would be attained. As the galvanic battery is analogous to the boiler, such tubes would be analogous in their form and functions to the steam-pipe of a steam engine.

2128. *Conducting wires*.—If a wire, coated with a non-conducting substance capable of resisting the vicissitudes of weather, were extended between any two distant points, one end of it being attached to one of the extremities of a galvanic battery, a stream of electricity would pass along the wire—*provided the other end of the wire were connected by a conductor with the other extremity of the battery*.

To fulfil this last condition, it was usual, when the electric telegraphs were first erected, to have a second wire extended from the distant point back to the battery in which the electricity was generated. But it was afterwards discovered that the EARTH ITSELF was the best, and by far the cheapest and most convenient, conductor which could be used for this returning stream of electricity. Instead, therefore, of a second wire, the extremity of the first, at the distant point to which the current is sent, is attached to a large metallic plate, measuring five or six square feet, which is buried in the earth. A similar plate, connected with the other extremity of the battery, at the station from which the current is transmitted, is likewise buried in the earth, and it is found that the returning current finds its way back through the earth from the one buried plate to the other buried plate.

The manner in which the wires are carried from station to station is well known. Every one is familiar with the lines of wire extended along the side of the railways. These wires are generally galvanised so as to resist oxydation, and are of sufficient thickness to bear the tension to which they are submitted. They are suspended on posts, erected at intervals of sixty yards, being at the rate of thirty to a mile.

To each of these poles are attached as many tubes or rollers of porcelain or glass as there are wires to be supported. Each wire passes through a tube, or is supported on a roller; and the

material of the tubes or rollers being among the most perfect of the class of non-conducting substances, the escape of the electricity at the points of contact is impeded.

In some cases, as, for example, in the streets of London, it is found inconvenient to carry the wires on elevated posts. In such cases they are wrapped with cotton thread, coated with a mixture of tar, resin, and grease, which produces a good non-conductor, or are surrounded with gutta percha, which is better still, are packed together in a leaden or other metallic pipe, and are then buried in the ground.

2129. *Telegraphic signs*.—The current being by these means transmitted instantaneously from any station to another, connected with it by such conducting wires, it is necessary to select among the many effects which it is capable of producing, such as may be fitted for telegraphic signs.

There are a great variety of properties of the current which supply means of accomplishing this. If it can be made to affect any object in such a manner as to cause such object to produce any effect sensible to the eye, the ear, or the touch, such effect may be used as a *sign*; and if it be capable of being *varied*, each distinct *variety* of which it is susceptible may be adopted as a *distinct sign*. Such signs may then be taken as signifying the letters of the alphabet, the digits composing numbers, or such single words as are of most frequent occurrence.

The rapidity and precision of the communication will depend on the rate at which such signs can be produced in succession, and on the certainty and accuracy with which their appearance at the place of destination will follow the action of the producing cause at the station from which the despatch is transmitted.

These preliminaries being understood, it remains to show what effects of the electric current are available for this purpose.

These effects are:—

I. The power of the electric current to deflect a magnetic needle from its position of rest.

II. The power of the current to impart temporary magnetism to soft iron.

III. The power of the current to decompose certain chemical solutions.

2130. *Signs made with the needle system.* — Let us now see how these three properties have been made instrumental to the transmission of intelligence to a distance.

We have explained how a magnetic needle over which an electric current passes will be deflected to the right or to the left, according to the direction given to the current. Now, it is always easy to give the current the one direction or the other, or to suspend it altogether, by merely changing the end of the galvanic trough with which the wires are connected, or by breaking the contact.

A person, therefore, in London, having command over the end of a wire which extends to Edinburgh, and is there connected with a magnetic needle, in the manner already described, can deflect that needle to the right or to the left at will.

Thus a single wire and a magnetic needle are capable of making at least two signals.

By repeating the same signals a greater or less number of times, and by variously combining them, signs may be multiplied; but it is found more convenient to provide two or more wires affecting different needles, so as to vary the signs by combination, without the delay attending repetition.

Such is, in general, the nature of the signals adopted in the electric telegraphs in ordinary use in England, and in some other parts of Europe.

It may aid the conception of the mode of operation and communication if we assimilate the apparatus to the dial of a clock with its two hands. Let us suppose that a dial, instead of carrying hands, carried two needles, and that their north poles, when quiescent, both pointed to twelve o'clock. When the galvanic current is conducted under either of them, the north pole will turn either to three o'clock or to nine o'clock, according to the direction given to the current.

Now, it is easy to imagine a person in London governing the hands of such a clock erected in Edinburgh, where their indications might be interpreted according to a way previously agreed upon. Thus, we may suppose that when the needle No. 1. turns to nine, the letter A is expressed; if it turn to three, the letter B is expressed. If the needle No. 2. turn to nine o'clock, the letter C is expressed; if it turn to three, the letter D. If both needles are turned to nine, the letter E is

expressed ; if both to three, the letter F. If No. 1. be turned to nine, and No. 2. to three, the letter G is expressed ; if No. 2. be turned to nine, and No. 1. to three, the letter H, and so forth.

2131. *Telegraphs operating by an electro-magnet.* — Telegraphs depending on the second and third principles adverted to above, have been brought into extensive use in America, the needle system being in no case adopted there.

The power of imparting temporary magnetism to soft iron by the electric current has been applied in the construction of telegraphs in a great variety of forms ; and indeed it may be stated generally that there is no form of telegraph whatever in which the application of this property can be altogether dispensed with.

To explain the manner in which it is applied, let us suppose the conducting wire at the station of transmission, London for example, to be so arranged that its connexion with the voltaic battery may, with facility and promptitude, be established and broken at the will of the agent who transmits the despatch. This may be effected by means of a small lever acting like the key of a pianoforte, which being depressed by the finger, transmits the current. The current may thus be transmitted and suspended in as rapid alternation as the succession of notes produced by the action of the same key of a pianoforte.

At the station to which the despatch is transmitted, Edinburgh for example, the conducting wire is coiled spirally round a piece of soft iron, which has no magnetic attraction so long as the current does not pass along the wire, but which acquires a powerful magnetic virtue so long as the current passes. So instantaneously does the current act upon the iron, that it may be made alternately to acquire and lose the magnetic property several times in a second.

Now let us suppose this soft iron to be placed under an iron lever, like the key of a pianoforte, so that when the former has acquired the magnetic property, it shall draw this key down as if it were depressed by the finger, and when deprived of the magnetic property, it will cease to attract it, and allow it to recover its position of rest. It is evident in this case that movements would be impressed by the soft iron, rendered magnetic, on the key at Edinburgh simultaneous and exactly identical with the movements impressed by the finger of the

agent upon the key in London. In fact, if the key in Edinburgh were the real key of a pianoforte, the agent in London could strike the note and repeat it as often and with such intervals as he might desire.

This lever at Edinburgh, which is worked by the agent in London, may, by a variety of expedients, be made to act upon other moveable mechanism, so as to make visible signals, or to produce sounds, to ring a bell or strike a hammer, or to trace characters on paper by means of a pen or pencil, so as actually to write the message, or to act upon common moveable type so as to print it. In fine, having once the power to produce a certain mechanical effect at a distant station, the expedients are infinitely various, by which such mechanical effect may be made subservient to telegraphic purposes.

2132. *Morse's system.* — The telegraph of Morse, extensively used in the United States, affords an example of this. To comprehend its mode of operation, let us suppose the lever on which the temporary magnet acts to govern the motion of a pencil or style under which a ribbon of paper is moved with a regulated motion by means of clockwork. When the current passes, the style is pressed upon the paper, and when the current is suspended, it is raised from it. If the current be maintained for an interval more or less continued, the style will trace a line on the ribbon, the length of which will be greater or less according to the duration of the current. If the current be maintained only for an instant, the style will merely make a dot upon the ribbon. Lines, therefore, of varying lengths, and dots separated by blank spaces, will be traced upon the ribbon of paper as it passes under the style, and the relative lengths of these lines, their combinations with each other and with the dots, and the lengths of the blank intervening spaces, are altogether under the control of the agent who transmits the despatch.

It is easy to imagine how a conventional alphabet may be formed by such combinations of lines and dots.

Provisions are made, so that the motion of the paper does not begin until the message is about to be commenced, and ceases when the message is written. This is easily accomplished. The cylinders which conduct the band of paper are moved by wheel-work and a weight properly regulated. The motion is imparted by a detent detached by the action of the magnet, which stops the motion when the magnet loses its virtue.

2133. *Electro-chemical telegraphs.*—The following description of the telegraph of Mr. Bain will convey some idea of the general principle on which all forms of electro-chemical telegraphs are based :—

Let a sheet of writing paper be wetted with a solution of prussiate of potash, to which a little nitric and hydrochloric acid have been added. Let a metallic desk be provided corresponding in magnitude with the sheet of paper, and let this desk be put in communication with a galvanic battery so as to form its negative pole. Let a piece of steel or copper wire forming a pen be put in connection with the same battery so as to form its positive pole. Let the sheet of moistened paper be now laid upon the metallic desk, and let the steel or copper point which forms the positive pole of the battery be brought into contact with it. The galvanic circuit being thus completed, the current will be established, the solution with which the paper is wetted will be decomposed at the point of contact, and a blue or brown spot will appear. If the pen be now moved upon the paper, the continuous succession of spots will form a blue or brown line, and the pen being moved in any manner upon the paper, characters may be thus written upon it as it were in blue or brown ink.

In this manner, any kind of writing may be inscribed upon the paper, and there is no other limit to the celerity with which the characters may be written, save the dexterity of the agent who moves the pen, and the sufficiency of the current to produce the decomposition of the solution in the time which the pen takes to move over a given space of the paper.

The electro-chemical pen, the prepared paper, and the metallic desk being understood, we shall now proceed to explain the manner in which a communication is written at the station where it arrives.

The metallic desk is a circular disk, about twenty inches in diameter. It is fixed on a central axis, with which it is capable of revolving in its own plane. An uniform movement of rotation is imparted to it by means of a small roller, gently pressed against its under surface, and having sufficient adhesion with it to cause the movement of the disk by the revolution of the roller. This roller is itself kept in uniform revolution by means of a train of wheel-work, deriving its motion either from a weight or main spring, and regulated by a governor or fly. The rate at which the disk revolves may be varied at the discretion of the superintendent, by shifting the position of the roller towards the centre; the nearer to the centre the roller is placed, the more rapid will be the motion of rotation. The moistened paper being placed on this disk, we have a circular sheet kept in uniform revolution.

The electro-chemical pen, already described, is placed on this paper at a certain distance from its centre. This pen is supported by a pen-holder, which is attached to a fine screw extending from the centre to the circumference of the desk in the direction of one of its radii.

On this screw is fixed a small roller, which presses on the surface of the desk, and has sufficient adhesion with it to receive from it a motion of revolution. This roller causes the screw to move with a slow motion in a direction from the centre to the circumference, carrying with it the electro-chemical pen. We have thus two motions, the circular motion carrying the moistened paper which passes under the pen, and the slow rectilinear motion of the pen itself directed from the centre to the circumference. By the combination of these two motions, it is evident that the pen will trace upon the paper a spiral curve, commencing at a certain distance from the centre,

and gradually extending towards the circumference. The intervals between the successive coils of this spiral line will be determined by the relative velocities of the circular disk, and of the electro-chemical pen. The relation between these velocities may likewise be so regulated, that the coils of the spiral may be as close together as is consistent with the distinctness of the traces left upon the paper.

Now, let us suppose that the galvanic circuit is completed in the manner customary with the electric telegraph, that is to say, the wire which terminates at the point of the electro-chemical pen is carried from the station of arrival to the station of departure, where it is connected with the galvanic battery, and the returning current is formed in the usual way by the earth itself. When the communication between the wire and the galvanic battery at the station of departure is established, the current will pass through the wire, will be transmitted from the point of the electro-chemical pen to the moistened paper, and will, as already described, make a blue or brown line on this paper. If the current were continuous and uninterrupted, this line would be an unbroken spiral, such as has been already described; but if the current be interrupted at intervals, during each such interval, the pen will cease to decompose the solution, and no mark will be made on the paper. If such interruption be frequent, the spiral, instead of being a continuous line, will be a broken one, consisting of lines interrupted by blank spaces. If the current be allowed to act only for an instant of time, there will be a blue or brown dot upon the paper; but if it be allowed to continue during a long interval, there will be a line.

Now, if the intervals of the transmission and suspension of the current be regulated by any agency in operation at the station of departure, lines and dots corresponding precisely to these intervals, will be produced by the electro-chemical pen on the paper, and will be continued regularly along the spiral line already described. It will be evident, without further explanation, that characters may thus be produced on the prepared paper corresponding to those of the telegraphic alphabet already described, and thus the language of the communication will be written in these conventional symbols.

There is no other limit to the celerity with which a message may be thus written, save the sufficiency of the current to effect the decomposition while the pen passes over the paper, and the power of the agency used at the station of departure to produce, in rapid succession, the proper intervals in the transmission and suspension of the current.

But the prominent feature of this system is the extraordinary celerity of which it is susceptible. In an experiment performed by M. Le Verrier and Dr. Lardner before Committees of the Institute and the Legislative Assembly at Paris, despatches were sent a thousand miles, at the rate of nearly 20,000 words an hour.\*

\* Lardner on the Great Exhibition, p. 89. et seq.

## CHAP. XV.

CALORIFIC, LUMINOUS, AND PHYSIOLOGICAL EFFECTS OF THE  
VOLTAIC CURRENT.

2134. *Conditions on which calorific power of current depends.*—When a voltaic current passes over a conductor, an elevation of temperature is produced, the amount of which will depend on the quantity and intensity of the electricity transmitted, upon the conductability of the material composing the conductor, and upon the magnitude of the space which it offers for the passage of the electric fluid. Although the conditions which determine this development of heat are not ascertained with much certainty or precision, it may be stated generally that the quantity of heat produced is augmented with the quantity of the fluid transmitted, and the obstacles opposed to its passage. A given current, therefore, will develop less heat on good than on bad conductors, and on those having a large than on those having a small transverse section.

The development of heat, so far as it depends on the current itself, appears to increase in a much larger ratio with the quantity, than with the intensity, of the electric fluid. Thus, while it is greatly augmented by increasing the extent of surface of the elements of the pile, it is very little affected by augmenting their number. For a like reason it is greatly augmented by selecting the elements from the extremes of the electromotive series (1847), since in that case the quantities of electricity developed are increased in proportion to the electromotive energy of the exciting surfaces.

When a voltaic current of a certain intensity passes along a metallic wire, the wire becomes heated. If the intensity of the current be increased, the wire will become incandescent, and will, by a further increase of the force of the current, be fused, or burned.

The same current which will produce only a slight elevation of temperature upon a wire of a certain diameter, will render a finer wire incandescent, and will fuse or burn one which is still finer.

2135. *Calorific effects: Hare's and Children's deflagrators.*—



The calorific power of a battery depending chiefly on the extent of the heating surface, and the electromotive energy of its elements, those forms which, within a given volume, present the most extensive surfaces, such as Hare's spiral arrangement (1861), and others, on a like principle, contrived by Children and Strating, and denominated *deflagrators*, and the systems of Grove (1865) and Bunsen (1866), in which platinum or carbon is combined with zinc, and excited by two fluids, are the most efficient. With piles of the latter kind, consisting of ten to twenty pairs, the development of heat is so considerable that substances which resist the most powerful blast-furnaces are easily fused and burned. Extraordinary effects are produced by this calorific agency. Metallic wire, submerged in water, is rendered incandescent, and may be fused either in vacuo or in an atmosphere of any gas, such as azote or carbonic acid, which is not a supporter of combustion.

2136. *Wollaston's thimble battery*.—A combination thus designated, which has acquired a sort of historical scientific interest, is represented in its actual size in *fig. 664*.

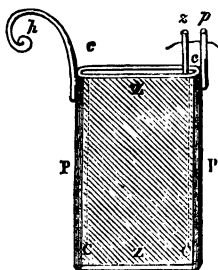

Fig. 664.

A strip of thin silver or platinum leaf *p*, is bent double, so as to include between its folds a plate *z* of amalgamated zinc, the distance between the surfaces being about the twentieth of an inch. The surfaces are kept separated by small bits of cork thrust between them. Two short copper wires, one *z*, attached to the zinc, and the other, *p*, to the platinum, form the

poles of the combination, and when these are connected by a wire a voltaic current will pass from *p* to *z*. Each of these polar wires has a fine slit made in it, into which an extremely fine platinum wire is inserted, extending between *z* and *p*, the intervening length between these points being not more than the tenth of an inch. The wire handle *h* is provided, to enable the operator to immerse the apparatus in a wine-glass, containing a solution composed of three parts of water and one of sulphuric acid. The current which will then be established upon the wire between *p* and *z* will render it incandescent.

2137. *Experimental illustration of the conditions which effect calorific power of a current*.—If the poles of a powerful

battery be connected by iron or platinum wire from two to three feet in length, the metal will become incandescent. If its length or thickness be diminished it will fuse or burn. If its length or thickness be increased it will acquire first a darker degree of incandescence, and then will be only heated without being rendered luminous. The same current which will render iron or platinum wire incandescent or fuse it, will only raise the temperature of silver or copper wire of the same length and thickness without rendering it incandescent. If, on the other hand, the iron or platinum be replaced by tin or lead of much greater length or thickness, these metals will be readily fused by the same current.

These phenomena are explained by the different conductivity of these different metals, silver and copper being among the best, and lead and tin being among the worst metallic conductors of electricity.

If two pointed pencils of thick platinum wire, being connected with the poles of the battery, be presented point to point, so that the current may pass between them, they will be fused at the points and united, as though they were soldered together. This effect will equally be produced under water.

2138. *Substances ignited and exploded by the current.* — Combustible or explosive substances, whether solid or liquid, may be ignited by the heat developed in transmitting a current through them. Ether, alcohol, phosphorus, and gunpowder present examples of this.

2139. *Application of this in civil and military engineering.* — This property has been applied with great advantage in engineering operations, for the purpose of springing mines, an operation which may thus be effected with equal facility under water. Experiments made by the Russian military engineers at St. Petersburg, and by the English at Chatham, have demonstrated the advantage of this agency in military operations, more especially in the springing of subaqueous mines.

In the course of the construction of the South Eastern Railway it was required to detach enormous masses of the cliff near Dover, which, by the direct application of human labour, could not have been accomplished, save at an impracticable cost. Nine tons of gunpowder, deposited in three charges, at from fifty to seventy feet from the face of the cliff, were fired by a conducting wire, connected with a powerful battery, placed at

1000 feet from the mine. The explosion detached 600,000 tons weight of chalk from the cliff. It was proved that this might have been equally effected at the distance of 3000 feet.

2140. *Jacobi's experiments on conduction by water.*—Jacobi instituted a series of experiments with a view to ascertain how far water might be substituted for a metallic conductor for telegraphic purposes. He first established (as Peschel states) a conduction of this nature between Oranienbaum and an arm of the Gulph of Finland, a distance of 5600 feet, one half through water, and the other through an insulated copper wire, three-fourths of a line in diameter, which was carried over a dam, so that the entire length of the connexion was 11,200 feet. The electric current was excited by a Grove's battery of twenty-four pairs, and a common voltaic pile of 150 six-inch plates. A zinc plate of five square feet was sunk in the sea from one pole of the battery, and at the opposite end of the connecting wire a similar plate was sunk in a canal joining the sea. Charcoal points were used for completing the circuit of the Grove's battery; these, and also a fine platinum wire, were made red-hot, and these phenomena appeared to be more intense than when copper wires were used as conductors. In a later experiment he employed a similar conduction, the distance in this case being 9030 feet, namely, from the winter palace of the emperor to the Fontanka, near the Obuchowski bridge. One of the conductors was a copper wire carried under ground, the other was the Neva itself, in which a zinc plate five square feet was sunk beneath the surface of the river. At the other extremity a similar zinc plate was immersed in a small pond, whose level was five or six feet above the Fontanka, from which it was separated by a flood-gate. The battery consisted of twenty-five small Daniell's constant batteries, by means of which, notwithstanding the great extent of water, all the galvanic and magnetic phenomena were produced. At Lenz's suggestion, a different species of conduction was tried between the same stations. A connexion was established with a point of the iron roof of the winter palace, which was connected with the ground by means of conducting rods, and the current was carried equally well along the moist earth.

2141. *Combustion of the metals.*—If thin strips of metal or common metallic leaf be placed in connexion with the poles of a battery, it will undergo combustion, the colour of the

flame varying with the metal, and in all cases displaying very striking and brilliant effects. Gold thus burned gives a bluish-white light, and produces a dark brown oxyde. Silver burns with a bright sea-green flame, and copper with a bluish-green flame, mingled with red sparks, and emits a green smoke. Zinc burns with a dazzling white light, tin with red sparks, and lead with a purple flame. These phenomena are produced with increased splendour, if the metal to be burned attached to one pole be brought into contact with mercury connected with the other pole.

2142. *Spark produced by the voltaic current.*— Bring nearly together the amalgamated ends of the polar wires, while the battery is in a state of activity; a small, white, starlike spark will be seen accompanied by a crackling noise like that which attends the emission of a feeble electrical spark.

Plunge the end of one of the wires into a small vessel of mercury, and bring the other near the surface of the metal. A similar spark is emitted just before the point touches the mercury, on which a small black speck may be seen where the spark struck it.

The spark obtained from an amalgamated point is visible under water or in the flame of a candle.

Fasten a fine sewing-needle to the end of one of the wires, and touch the other pole with the free end of the needle; a starlike red spark will be emitted. A continued stream of these sparks may be obtained by connecting a small round or triangular file with one pole, and presenting to it and removing from it with great rapidity the point of a copper wire attached to the other pole.

Coat the ends of the connecting wires with soot, by holding them in the flame of an oil lamp, and the sparks will be both larger and brighter; they will be obtained of the greatest intensity by holding the points of the wires in the flame opposite to each other.

Nobili says, that, in performing experiments of this kind he obtained the brightest sparks by connecting the two ends of the battery with a long spiral copper wire, or with a wire insulated by being wound round with silk.

2143. *The electric light.*— Of all the luminous effects produced by the agency of electricity, by far the most splendid is the light produced by the passage of the current proceeding

from a powerful battery between two pencils of hard charcoal presented point to point. The charcoal being an imperfect conductor is rendered incandescent by the current, and being infusible at any temperature hitherto attained, the degree of splendour of which its incandescence is susceptible has no other practical limit except the power of the battery.

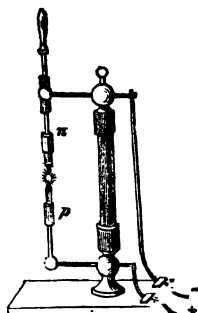

Fig. 665.

The charcoal best adapted for this experiment is that which is obtained from the residuum of the coke in retorts of gas works. This is hardened and formed into pencil-shaped pointed cylinders, from two to four inches in length, and mounted as represented in *fig. 665.*, where *p* and *r*, the two metallic pencil-holders, are in metallic connexion with the poles of the pile, and so mounted that the charcoal pencils fixed in them can at pleasure be made to approach each other until their points come into contact, or to recede from each other to any necessary distance. When they are brought



Fig. 666.

into contact, the current will pass between them, and the charcoal will become intensely luminous. When separated to a short distance, a splendid flame will pass between them of the form represented in *fig. 666.* It will be observed that the form of the flame is not symmetrical with relation to the two poles, the part next the positive point having the greatest diameter, and the diameter becoming gradually less in approaching the negative point.

2144. *Action of a magnet on the electric flame.*— If the pole of a bar magnet be presented to this flame it will immediately affect it as it would affect a moveable current, and will, even at a considerable distance, throw it into the curved form represented in *fig. 667.*, the curvature being turned to the one side or the other according as the austral or boreal pole is presented to the flame. The action of the magnet may, in such cases, be so intense as to extinguish the flame altogether, just as a blast of air would extinguish the flame of a candle.



Fig. 667.

This fact renders it probable, if not certain, that the earth's

magnetism exerts a similar influence on a larger scale upon the electrical phenomena of the atmosphere, especially on those which are manifested in its more elevated regions, and which, because of the more rarefied state of the air, have more diffusion.

2145. *Incandescence of charcoal by the current not combustion.* — It would be a great error to ascribe the light produced in charcoal pencils to the combustion of that substance. None of the consequences or effects of combustion attend the phenomena, no carbonic acid is produced, nor does the charcoal undergo any diminution of weight save a small amount due to mere mechanical causes. On the contrary, at the points where the calorific action is most intense, it becomes more hard and dense. But what negatives still more clearly the supposition of combustion is, that the incandescence is still more intense in a vacuum, or in any of the gases that do not support combustion, than in the ordinary atmosphere.

Peschel states that, instead of two charcoal pencils, he has laid a piece of charcoal, or well burnt coke, upon the surface of mercury, connected with one pole of the battery, while he has touched it with a piece of platinum connected with the other pole. In this manner he obtained a light whose splendour was intolerable to the eye.

2146. *Electric lamps of Messrs. Foucault, Deleuil, and Dubosc-Soleil.* — M. Foucault first applied the electric light produced by charcoal pencils as a substitute for the lime light in the gas microscope. Further improvements in these arrangements have been made more recently by M. Deleuil and M. Dubosc-Soleil, the eminent philosophical instrument makers of Paris. The effect of these improvements is to supply a self-acting adjustment by which the current passing between the charcoal pencils, and consequently the splendour of the light, is rendered uniform, or nearly so. This is accomplished by the agency of electro-magnets, which are so affected by the current, that they act upon a mechanism which regulates the distance of the charcoal points so as to maintain the uniformity of the current.

2147. *Method of applying the heat of charcoal to the fusion of refractory bodies and the decomposition of the alkalis.* — This is accomplished by substituting for the charcoal pencil, *p*, *fig.* 665., a piece of charcoal in the form of a small cup, as represented in *fig.* 668.

A small piece of the substance to be acted on is placed in the charcoal cup s, and the electric flame is made to play upon it by bringing it into proximity with the pencil above it. In this way gold or platinum may be fused, or even burned. If a small piece of soda or potash be placed in the cup s, its decomposition will be effected by the flame, and small globules of sodium or potassium will be produced in the cup, which will launch themselves towards the point of



Fig. 668.

the pencil, undergoing at the same time combustion, and thus reproducing the alkali.

2148. *Physiological effects of the current.*—This class of effects is found to consist of three successive phases: *first*, when the current first commences to pass through the members affected by it; *secondly*, during its continuance; and, *thirdly*, at the moment of its cessation. A sharp convulsive shock attends the first and last; and the intermediate period is marked by a continued series of lesser shocks rapidly succeeding each other. The shock of a voltaic battery has been said to be distinguished from that produced by a Leyden jar, inasmuch as the latter is felt less deeply, affecting only our external organs, and being only instantaneous in its duration; while the latter pervades the system, propagating itself through the whole course of the nerves which extend between its points of admission and departure.

It appears that the physiological effect of the current depends altogether on its intensity, and little or not at all upon its quantity. This is proved by the fact, that the effect of a battery of small plates is as great as one consisting of the same number of large plates. A single pair, however extensive be its surface, produces no sensible shock. To produce any sensible effect, from ten to fifteen pairs are necessary. A battery of 50 to 100 pairs gives a pretty strong convulsive shock. If the hands, previously wetted with salted water, grasp two handles, like those represented at P and N, *fig.* 624., connected with such a battery, violent shuddering of the fingers, arms, and chest will be produced; and if there be any sore or tender parts of the skin, a pricking or burning sensation will be produced there.

The voltaic shock may be transmitted through a chain of persons in the same manner as the electric shock, if their hands

which are joined be well moistened with salted or acidulated water, to increase the conducting power of the skin.

As the strongest phases of the shock are the moments of the commencement and cessation of the current, any expedient which produces a rapid intermission of the current will augment its physiological effect. This may be accomplished by various simple mechanical expedients, by which the contact of the conductors connecting the poles may be made and broken in rapid succession ; but no means are so simple and effectual for the attainment of this object, as the contrivances for the production of the magneto-electro current described in (1981), which, in fact, is exactly the rapidly intermitting current here required.

2149. *Medical application of the voltaic shock* — The influence of the galvanic shock on the nervous system in certain classes of malady has been tried with more or less success, and apparatus have been contrived for its convenient application, both generally and locally, to the system. The most convenient form of apparatus for this purpose is the magneto-electric machine, represented in *fig.* 624. This has been recently improved by certain medical practitioners in Paris, where it is extensively used. Expedients are applied to it by which the operator can measure and regulate the force of the shock with the greatest certainty and precision. This is accomplished by surrounding the arms of the electro-magnet with loose cylinders or gloves of thin copper, which may be moved so as to uncoil the arms to a greater or less extent, and thus increase or diminish the force of the induced current.

2150. *Effect on bodies recently deprived of life.* — This class of phenomena is well known, and, indeed, was the origin of the discovery of galvanism. Galvani's original experiment on the limbs of a frog, already noticed (1842), has often been repeated. Bailey substituted for the legs of the frog those of the grasshopper, and obtained the same results.

Experiments made on the bodies of men and inferior animals recently deprived of life have afforded remarkable results. Aldini gave violent action in this way to the various members of a dead body. The legs and feet were moved rapidly, the eyes opened and closed, and the mouth, cheeks, and all the features of the face were agitated by distortions. Dr. Ure connected one of the poles of a battery with the supraorbital nerve of a man cut down after hanging for an hour, and con-



nected the other pole with the nerves of the heel. On completing the circuit the muscles are described to have been moved with a fearful activity, so that rage, anguish, and despair, with horrid smiles, were successively expressed by the countenance.

This agency has been used occasionally with success as an expedient for restoring suspended animation.

The bodies and members of inferior animals recently killed are susceptible of the same influence, though in a less degree. The current sent through the claw of a lobster recently torn from the body, will cause its instant contraction.

*Effect of the shock upon a leech.*— If a half-crown piece be laid upon a sheet of amalgamated zinc, a leech placed upon the coin will betray no sense of a shock, until, by moving, some part of it comes into contact with the zinc. The connexion being thus established, the leech will receive a shock, as will be rendered manifest by the sudden recoil of the part which first touches the zinc.

2151. *Excitation of the nerves of taste.*— If a metallic plate, connected with one pole of the battery, be applied to the end of the tongue, and another wetted with salted water, and connected with the other pole, be applied to any part of the face, the metal on the tongue will excite a peculiar taste, acid or alkaline, according as it is connected with the positive or negative pole. This is explained by the decomposition of the saliva by the current.

2152. *Excitation of the nerves of sight.*— If a metallic plate, wetted with salted or acidulated water, be applied at or near the eyelids, and another be applied at any other part of the person, a peculiar flash or luminous appearance will be perceived the moment the plates are put into connexion with the poles of a battery. The sensation will be reproduced, but with less intensity, the moment the connexion is broken. A like effect, but less intense, is produced, when the current is transmitted through the cheek and gums.

2153. *Excitation of the nerves of hearing.*— If the wires connected with the poles of a battery be placed in contact with the interior of the two ears, a slight shock will be felt in the head at the moment when the connexion is made or broken, and a roaring sound will be heard so long as the connexion is maintained.

2154. *Supposed sources of electricity in the animal organisation.* — Although Galvani's theory of animal electricity did not survive its author, the supposition that there exists in the organisation of animals a source of electrical action has never been abandoned. Humboldt and Pfaff discovered traces of electrical development in connecting the nerve and muscle of a frog. Reoscopic tests have indicated the presence of a current, when two remote portions of a nerve, or of the muscle belonging to it, are brought into connexion. Dr. Donné of Paris thinks that there is a source of electrical excitement between the inner and outer skins. He placed the inner and outer skins of the mouth in connexion by a platinum wire, upon which the presence of a feeble current was detected by a reoscope. Dr. Wilson Philip showed that in certain cases a voltaic current might perform the functions of the nerves. Having destroyed the action of some of the nerves leading to the stomach of a dog, he restored their suspended action by connecting the severed ends with a voltaic current.

2155. *Electrical fishes.* — The most conspicuous example of the development of electricity in the animal organization is presented by certain species of fish. Of these ELECTRICAL FISHES there are seven genera: —

- |                                |                                  |
|--------------------------------|----------------------------------|
| 1. <i>Torpedo narko</i> risso. | 5. <i>Silurus electricus</i> .   |
| 2. „ <i>unimaculata</i> .      | 6. <i>Tetraodon electricus</i> . |
| 3. „ <i>marmorata</i> .        | 7. <i>Gymnotus electricus</i> .  |
| 4. „ <i>galvanii</i> .         |                                  |

No observations sufficiently exact and extensive have yet supplied the data necessary to determine the source of the vast quantities of electricity which these creatures are capable of developing at will. There is nothing in the phenomena observed which countenances the supposition that the electricity is the result either of mechanical, thermal, or chemical causes analogous to those which have been already explained. When it is therefore stated to arise from a physiological action peculiar to the organization of the animal, a name is merely given to an unknown agency. In the absence, therefore, of any reasonable theory, we are compelled to limit ourselves to a mere statement of the phenomena.

2156. *Properties of the torpedo; observations of Walsh.* — According to the observations of Walsh, who first submitted this animal to exact inquiry, the following are its effects: —

If the finger or the palm of the hand be applied to any part of the body of the animal out of the water, a shock will be felt similar to that produced by a voltaic pile.

If, instead of applying the hand directly, a good conductor, such as a rod of metal several feet in length, be interposed, the shock will still be felt.

If non-conductors be interposed, the shock is not felt.

If the continuity of the interposed conductor be anywhere broken, the shock is not felt.

The shock may be transmitted along a chain of several persons with joined hands, but in this case the force of the shock is rapidly diminished as the number of persons is increased. In this case the first person of the chain should touch the torpedo on the belly, and the last on the back.

When the animal is in the water, the shocks are less intense than in the air.

It is evident that the development of electricity is produced by a voluntary action of the animal. It often happens that in touching it no shock is felt. But when the observer irritates the animal, shocks of increasing intensity are produced in very rapid succession. Walsh counted as many as fifty electrical discharges produced in this way in a minute.

2157. *Observations of Becquerel and Breschet.*—In a series of observations and experiments made on the torpedos of Chioggia near Venice by MM. Becquerel and Breschet, it was ascertained that when the back and belly were connected by the wires of a sensitive reoscope, a current was indicated as passing from the back to the belly. They also found that the animal could at will transmit the current between any two points of its body.

2158. *Observations of Matteucci.*—In a series of experiments made on the torpedos of the Adriatic, M. Matteucci confirmed the results obtained by MM. Becquerel and Breschet, and also succeeded in obtaining the spark from the current passing between the back and belly.

2159. *The electric organ.*—In the several species of fish endowed with this quality, the structure of the organ in which the electric fluids are developed is alike, differing only in its form, magnitude, and position. In the torpedo, which has been submitted to the most rigorous examination; it consists of two parts symmetrically arranged at each side of the head and

resting against the gills. They fill all the thickness which separates the two coats of the skin. On dissection it is proved to consist of an extremely open cellular tissue, having the form of a cylinder, or, more exactly, that of a five or six-sided prism. It has been compared to the cellular structure of the honeycomb, only that the partitions, instead of being thin membranes, are fibres separated and extended in different directions.

Four or five hundred of these prisms are commonly counted in each organ. Hunter in one case found 1182. They are nearly at right angles to the surface of the skin, to which they are strongly attached at the ends. When the structure of each of these prisms is examined, they are found to consist of a multitude of thin plates whose planes are perpendicular to the axis of the prism, separated from each other by strata of mucous matter, and forming a combination resembling the original galvanic pile.

Four bundles of nerves of considerable volume are distributed in the organ, and, according to Matteucci, the seat of the electrical power is at their origin.

# I N D E X.

- ABSORPTION of heat, 121.  
Agonic lines, 172.; American, 172.; Asiatic, 172.  
Air, rarefied, a conductor of electricity, 198.  
Alcohol, congelation of, 81.  
Alloys, liquefaction of, 73.  
Ampère, method to reverse galvanic current, 301.; apparatus for supporting moveable currents, 304.; method of exhibiting revolution of galvanic current round a magnet, 318.; electro-magnetic rectangle, 362.  
Animal heat, 138.  
Animals, wool and fur of, their uses, 111.  
Anion, 394.  
Annealing, use of, 85.  
Anode, 394.  
Arago's electro-magnetic researches, 351.  
Armatures, 185.  
Armstrong's hydro-electrical machine, 210.  
Astatic needle, 187.  
Athermanous media, 123.  
Atmosphere, low temperature of, superior strata of, 54.; non-conductor of electricity, 198.  
Attraction, magnetic, 152.; electric, 189, 241.  
Aurora borealis, influence of on magnetic needle, 179.  
Austral fluid, 155.  
Axis, magnetic, 153.; of circulating galvanic current, 321.  
Azimuth compass, 165.  
Babbage's electro-magnetic researches, 351.  
Bagration's galvanic system, 283.  
Bain's electro-chemical telegraph, 436.  
Balance-wheels, compensation of, 30.  
Bar, magnetic, 161.  
Battery, electric, 231.; voltaic, 280, 440.  
Beccarel's galvanic system, 283.; electro-chemical researches, 405.  
Bells, electric, 246.  
Birds, plumage of, its uses, 110.  
Blood, temperature of in human species, 138.  
Boiling point, 10, 99.  
Boreal fluid, 155.  
Buildings, metallic, 27.; warming, 38, 46, 106.; ventilation of, 38.  
Bulb, thermometric, 7.; liable to permanent charge of capacity, 15.  
Bunsen's galvanic battery, 280.  
Calcium, 418.  
Caloric, 5.  
Calorimeter, 48.  
Calorimetry, 47.; method of solving calorimetric problems, 48.  
Cavendish's electric barometer, 259.  
Centigrade scale, 11.  
Chemical effects of electricity, 264.  
Chemistry, electro-, 393.  
Children's great galvanic plate pile, 293.  
Circuit, voltaic, 298. See *Electricity*.  
Clothing, its properties, 111.  
Cold, greatest natural, 81.  
Combustibles, 3, 134.; illuminating power of, 135.; constituents of, 135.; quantity of heat developed by, 136.  
Combustion, 3, 132.; agency of oxygen in, 133.; combustibles, 134.; explained, 134.; temperature necessary to produce, 134.; illuminating power of combustibles, 135.; constituents of combustibles, 135.  
Compass, azimuth, 165.; mariner's, 166.  
Compensators, 27.  
Compression of vapour, 96.  
Coercive force, 156.  
Coin, why stamped, not cast, 76.  
Condensation, 2, 86.; of vapour, 105.  
Condenser, electric, 214.; principle of, 216.; forms of Cuthbertson's, 218.  
Conduction, heat, 107.; electricity, 196.; magnetic, 3, 107.; electric, 196.  
Conductibility, 3.  
Conductors, heat, 4.; good and bad, 107.; electric, 196, 237.; connecting galvanic elements, 292.  
Congelation, 2, 67.; latent heat rendered sensible by, 65.; points of, 74.; of alcohol, 81.  
Contraction, 1, 29.; of solids, 26.; of mercury in cooling, 76.  
Coulomb's electroscope, 222.  
Couronne des tasses, 289.  
Crosse's electro-chemical researches, 406.  
Cruikshank's galvanic arrangement, 290.  
Currents, atmospheric, cause of, 41.; voltaic, 296. See *Electricity*;—rectilinear, 300.; indefinite, 300.; closed, 300.; circular or spiral, 300.; circulating, 320.; spiral and helical, 322.; thermo-electric, 385.  
Cuthbertson's electric condenser, 2, 218.  
Dance, electric, 247.  
Daniel's constant galvanic battery, 281, 294.  
Davy, galvanic pile, 293.; experiments in electro-chemistry, 409.; method of preserving copper sheathing, 421. See *Electricity*.  
Declination, 168.; in different longitudes, 172.; observed at Paris, 175.  
Deflagrator, galvanic, 293, 439.  
Delarive's floating electro-magnetic apparatus, 323.  
Deluc's galvanic pile, 295.  
Density, effect of relation of different strata of same liquid, 44.; relation of specific heat to, 53.  
Dew, principles of, 131.

- Dialthermanous media**, 4. 123.
- Dilatation**, 1. 29.; of mercury, rate of, 13.; of solids, 22.; of gases, 31.; of gases differs with change of pressure and temperature, 34.; of liquids, 42.; rates of, of liquids, 43.
- Dip**, lines of equal, 171.; local, 173.; observed at Paris, 175.
- Dipping-needle**, 167.
- Discharging-rod**, 213.
- Distributor, electro-magnetic**, 340.
- Dutch tears**, 85.
- Earth**, temperature of globe of, 114.; analogy of, to magnet, 164. 170.; direction of magnetic attraction of, 353.; magnetism, 379.
- Ebullition**, 99.
- Electrical attractions and repulsions**, 189.
- Electrical machines**, 207. See *Machines*.
- Electric lamps**, 445.
- Electric light**, 443.
- Electricity**, 189.; attraction and repulsion, 189.; origin of name, 189.; fluid, 190.; positive and negative, 191.; single electric fluid, 191.; two fluids, 192.; vitreous and resinous and positive and negative fluids, 192.; developed by various bodies, 193.; positive and negative substances, 194.; method of producing by glass and silk, 195.; conduction, 196.; conductors and non-conductors, 196.; insulators, 197.; insulating stools, 197.; induction, 202.; electrical machines, 207.; condenser and electrophorus, 214.; dissipated or latent, 217.; free, 217.; electroscopes, 220.; Leyden jar, 224.; charging a series of jars by cascade, 231.; electric battery, 231.; laws of electrical forces, 234.; proof plane, 235.; electrical orrery, 240.; mechanical effects of, 241.; attractions and repulsions of electrified bodies, 241.; electrical bells, 246.; electric dance, 247.; electrical saw, 249.; thermal effects of, 249.; ignition of metals, 250.; electric pistol, 251.; gunpowder exploded, 252.; Kinnersley's electrometer, 252.; luminous effects of, 253.; electric spark, 254.; imitation of auroral light, 257.; Leichtenberg's figures, 257.; experiments, indicating difference between the two fluids, 258.; Cavendish's electric barometer, 259.; thermal hypothesis, 259.; physiological effects of, 261.; chemical and magnetic effects of, 264.; Voltaic, 67.; discovery of galvanism, 67.; contact hypothesis of Volta, 269.; electro-motive force, 269.; classification of bodies as to electro-motive property, 270.; electro-motive action of gases and liquids, 272.; polar arrangement of fluids in electro-motive combinations, 274.; positive and negative poles, 274.; Volta's first combination, 278.; Wollaston's combination, 278.; Hare's spiral arrangement, 278.; cylindrical combination with one fluid, 279.; with two fluids, 280.; Grove's battery, 280.; Bunsen's battery, 280.; Daniel's constant battery, 281.; Pouillet's modification, 281.; Smee's battery, 282.; Wheatstone's system, 283.; Bagnat's system, 283.; Becquerel's system, 283.; Schönbein's modification of Bunsen's battery, 284.; Grove's gas electro-motive apparatus, 284.; Volta's invention of the pile, 285.; Couronne de stasses, 289.; Cruikshank's arrangement, 290.; Wollaston's arrangement, 290.; heliacal pile of Faculty of Sciences at Paris, 291.; conductors connecting the elements, 292.; memorable piles, 293.; Davy's pile, 293.; Napoleon's pile, 293.; Children's great plate battery, 293.; Hare's deflagrator, 293.; Stratingh's deflagrator, 293.; Pepsy's pile, 294.; batteries on Daniel and Grove's principles, 294.; dry piles, 294.; Deluc's pile, 295.; Zamboni's pile, 295.; piles of a single metal, 295.; Ritter's secondary piles, 296.; Voltaic currents, 296.; direction of current, 297.; poles of pile, 298.; voltaic circuit, 298.; method of coating conducting wires, 301.; supports of wires, 301—304.; Ampère's method to reverse current, 301.; Pohl's reotrope, 303.; electrodes, 303.; Ampère's apparatus for supporting moveable currents, 304.; reciprocal influence of rectilinear currents and magnets, 305.; electro-magnetism, 305.; effect of shock on bodies recently deprived of life, 447.; on a leech, 447.; excitation of nerves of taste, 448.; of nerves of sight, 448.; of nerves of hearing, 448.; supposed sources of electricity in animal organization, 448.; electrical fishes, 449.; properties of the torpedo, 449.; the electric organ, 450.
- Electricity, thermo-**, 384.; thermo-electric current, 385.; Pouillet's thermo-electric apparatus, 386.; conducting powers of metals, 389.; thermo-electric piles, 391.; electro-chemistry, 393.; electrolytes and electrolysis, 393.; Faraday's electro-chemical nomenclature, 393.; positive and negative element, 394.; electrolysis of water, 395.; Mitscherlich's apparatus, 397.; compounds susceptible of electrolysis, 402.; electro-negative bodies, 403.; electro-positive bodies, 403.; researches of Becquerel and Crosse, 405.; Faraday's voltameter, 407.; Faraday's law, 407.; Sir H. Davy's experiments, 409.; Faraday's doctrine, 412.; Pouillet's observations, 414.; Davy's experiments confirmed by Becquerel, 414.; liquid electrodes, 415.; electrolysis of the alkalis and earths, 418.; the series of new metals, 418.; Schönbein's experiments on the passivity of iron, 419.; tree of Saturn, 420.; Davy's method of preserving copper sheathing, 421.; calorific, luminous, and physiological effects of voltaic current, 438.; Hare and Children's deflagrators, 439.; Wollaston's thimble battery, 440.; Jacobi's experiments on conduction by water, 441.; combustion of the metals, 442.; electric light, 443.; electric lamps, 445.
- Electrodes**, 303. 394.
- Electro-chemistry**, 393.
- Electrolysis**, 393.; compounds, susceptible of, 402.
- Electrolytic classification of the simple bodies**, 403.
- Electrolytes**, 393.
- Electro-magnets**, 335.
- Electro-magnetism**: apparatus to exhibit direction of force impressed by a rectilinear current on a magnetic pole, 309.; apparatus to measure intensity of such force, 310.; apparatus to illustrate electro-magnetic rotation, 315.; Ampère's method, 318.; reciprocal influence of circulating currents and magnets, 320.; circulating current, 320.; axis of current, 321.; spiral and heliacal currents, 322.; Ampère's and

- Delarive's apparatus, 323; instable equilibrium of current, 325; right-handed and left-handed helices, 326; electro-magnetic induction, 331; Savary's experiments, 333; electro-magnets, 335; electro-magnetic power employed as a mechanical agent, 336; electro-motive power applied by M. Froment, 337; electro-motive machines constructed by him, 339; distributor, 340; regulator, 343; use of a contact breaker, 348; magneto-electric machines, 348; effects of momentary inductive currents produced upon revolving metallic disks, 351; researches of Arago, Herschel, Babbage, and Faraday, 351; influence of terrestrial magnetism on voltaic currents, 353; direction of earth's magnetic attraction, 353; Pouillet's apparatus to exhibit effects of earth's magnetism, 357; Ampère's rectangle, 362; reciprocal influence of voltaic currents, 363; voltaic theory of magnetism, 378; roscopes and reometers, 380; differential reometer, 384.
- Electro-magnetic induction, 331.
- Electro-metallurgy, 425; production of metallic moulds, 428; production of objects in solid metal, 428; reproduction of stereotypes and engraved plates, 429; metallizing textile fabrics, 429; glypography, 430; reproduction of Daguerreotype, 430.
- Electro-motive force, 269.
- Electro-negative bodies, 403.
- Electro-positive bodies, 403.
- Electrophorous, 214—219.
- Electroscopes, 220; pith-ball, 221; needle, 221; Coulomb's, 222; quadrant, 222; gold leaf, 222; condensing, 223.
- Electro-telegraphy, 431; conducting wires, 432; earth best conductor, 432; telegraphic signs, 433; Morse's system, 436; electro-chemical telegraphy, 436; Bain's telegraph, 436.
- Element, positive, 394; negative, 394.
- Equator, magnetic, 149, 170.
- Evaporation, 86; mechanical force developed in, 92; heat absorbed in, 103.
- Faraday's electro-magnetic researches, 351; electro-chemical nomenclature, 393; voltameter, 407; electro-chemical law, 407. See *Electricity*.
- Fire-eaters, feats of, explained, 147.
- Fireplaces, 39.
- Fishes, electric, 449.
- Flame, 133.
- Fluid, magnetic, 155; electric, 190; positive, 192; negative, 192; vitreous, 192; resinous, 192; experiments indicating specific difference between two electric, 258.
- Fluxes, 81; principle of, 81; application, 81.
- Forces (electrical), laws of, 234.
- Freezing mixtures, 77, 80; apparatus, 79.
- French metrical system, 44.
- Froment's electro-magnetic machines, 337.
- Frost (hoar), principles of, 131.
- Fusion 2; latent heat of, 70; points of, 70; substances which soften before, 77; infusible bodies, 82.
- Galvanism, 269.
- Galvanometer, 382.
- Gases, dilatation of, 31; liquefaction of, 55; permanent, 97; solidification of, 97; under extreme pressures, 99; non-conductors of heat, 109.
- Graduation of thermometers, 9; of pyrometers, 18.
- Gravity, specific, of liquid, 43.
- Grove's galvanic battery, 280, 294; gas electro-motive apparatus, 284.
- Hare's deflagrator, 293.
- Hare's spiral galvanic arrangement, 278.
- Harrison's pendulum, 28.
- Heat, 1. 5; sensible, 1.; insensible, 1., latent, 1. 65. 101.; heating liquid, 45; does not descend in liquid, 45; propagation of, through liquid by currents, 45; quantitative analysis of, 47.; specific, 47. 58.; uniform and variable, 48.; development and absorption of by chemical combination, 56. 132.; specific of simple gases equal under same pressure, 57.; relation between specific and atomic weight, 57.; rendered latent in liquefaction, 65.; latent rendered sensible by congelation, 65.; latent, of fusion, 70.; absorbed in evaporation at different temperatures, 103.; radiation of, 115.; reflection of, 119. 128.; absorption of, 121.; transmission of, 128.; decomposition of by absorption, 125.; refraction of, 128.; polarization of, 128.; quantity of developed by combustibles, 136.; animal, 138.; experiments to ascertain rate of development of animal, 142.; total quantity of animal explained by chemical laws, 143.; sensation of, 144.; touch, fallacious measure of, 145.
- Helical galvanic pile of Paris, 291.
- Helices. See *Electricity*.
- Herschel's electro-magnetic researches, 351.
- Hydraulic press, Britannia bridge, casting of, 113.
- Ice, method of preserving, 112.; production of artificial, 79. 132.
- Incandescence, 2.
- Induction, magnetic, 156; electric, 202; effects of, 179; electro-magnetic, 331.
- Influence of voltaic currents and magnets, 305, 303.
- Influence of terrestrial magnetism on voltaic currents, 353.
- Infusible bodies, 82.
- Inlaying, metallic, 27.
- Insulating stools, 197, 212.
- Insulators, 197.
- Isogonic lines, 173.
- Jacobi's experiments on electric conduction by water, 441.
- Kathion, 394.
- Kathode, 394.
- Keepers, 185.
- Kinnorsley's electrometer, 252.
- Lamp, Argand, 40.; electric, 445.
- Laplace's calorimeter, 48.
- Lavoisier's calorimeter, 48.
- Leyden jar, 224; improved form of, 230.
- Light, solar, thermal analysis of, 115.; physical analysis of, 116.; electric, 443.
- Lines of equal dip, 171.; agonic, 172.; isogonic, 173.; isodynamic, 176.
- Liquefaction, 2. 67.; of gases, 55. 97.; thermal phenomena attending, 63.; facility of

- proportional to latent heat, 72.; of alloys, 73.
- Liquids, dilatation of, 42.; effects of temperatures of different climates on, 106.; non-conductors of heat, 109.; materials fitted for vessels to keep warm, 129.
- Loadstone, 149.
- Luminous effects of electricity, 253.
- Machines, electrical, 207.; parts of, 207.; common cylindrical, 207.; Nairne's cylinder, 209.; common plate, 209.; Armstrong's hydro-electrical, 210.; appendages to, 212.
- Magnetic effects of electricity, 264.
- Magnetism, 149.; equator, 149. 170.; poles, 149.; pendulum, 151.; attraction and repulsion, 152.; axis, 153.; boreal and austral fluids, 155.; coercive force, 156.; substances, 156.; induction, 156.; decomposition of fluid, 159.; effects of heat on, 162.; terrestrial, 164.; meridian, 168. 171.; declination or variation, 168.; variation of dip, 170.; lines of equal dip, 171.; agonic lines, 172.; isogonic lines, 173.; local dip, 173.; position of magnetic poles, 173.; intensity of terrestrial, 175.; isodynamic lines, 176.; diurnal variation of needle, 177.; influence of aurora borealis, 179.; voltaic theory of, 378. See *Electricity*.
- Magnetization, 179.; effects of induction, 179.; method of single touch, 181.; of double touch, 182.; magnetic saturation, 182.; limit of magnetic force, 183.; effects of terrestrial magnetism on bars, 184.; armatures or keepers, 185.; compound magnets, 186.; influence of heat on magnetic bars, 186.; astatic needle, 187.
- Magnets, electric machines, 348. See *Electricity*.
- Magnets, natural, 149.; artificial, 149. 180.; compound, 161. 186.; with consequent points, 163.; best material, form, and method of producing artificial, 180.; electro-magnet, 335. See *Electricity*.
- Marble, fusible, 83.
- Mariner's compass, 166.
- Matting on exotics, its use, 112.
- Mechanical effects of electricity, 241.
- Melloni's thermoscopic apparatus, 123.; thermo-electric pile, 392.
- Mercury, preparation of, for thermometer, 7.; introduction in tube, 8.; rate of dilatation of, 13.; qualities which render it a convenient thermoscopic fluid, 15.
- Meridian, magnetic, 168. 171.; true, 168.; terrestrial, 168.
- Metals, weldable, 77.; ignition of, by electricity, 250.; electric conducting power of, 389.; new, 418.
- Mitscherlich's electro-chemical apparatus, 397.
- Moisture, deposit of on windows, 129.
- Moulds for casting metal, 26.; electro-metallurgic, 428.
- Morse's electric telegraph, 436.
- Multiplier, electro-magnetic, 382.
- Nairne's cylinder electrical machine, 209.
- Napoleon, galvanic pile, 293.
- Needle, magnetic, 161.; dipping, 167.; diurnal variation of, 179.; influence of aurora borealis on, 179.; astatic, 187.
- Nobili's reometer, 383.; Thermo-electric pile, 392.
- Non-conductors, electric, 196.
- Oils, congelation of, 76.
- Orrery, electric, 240.
- Oxygen, its agency in combustion, 133.
- Pendulum, compensating, 27.; Harrison's gridiron, 28.; magnetic, 151.
- Pepys' galvanic pile, 294.
- Physiological effects of electricity, 261.
- Phosphorus, congelation of, 76.
- Piles, galvanic. See *Electricity*.—Thermo-electric, 391.
- Pistol, electric, 251.
- Platinum rendered incandescent, 135.
- Pohl's reotrope, 303.
- Point, standard, in thermometer, 9.; freezing, 10.; boiling, 10. 99.; of fusion, 70.; of congelation, 74.; consequent, 163.; electric conductors with, 237.; consequent, electro-magnetic, 332.
- Polarization, heat, 128.
- Poles, magnetic, 149. 168.; position of magnetic, 173.; electric, positive and negative, 274.; of galvanic pile, 298.
- Potassium, 418.
- Pouillet's modification of Daniel's battery, 281.; apparatus to exhibit effects of earth's magnetism, 357.; thermo-electric apparatus, 386.
- Pressure, 31.
- Proof-plane, 235.
- Pyrometer, 3. 18.; graduation of, 18.
- Radiation, 4. 115.; rate of heat, 120.; intensity of, 120.; influence of surface on, 120.; radiating powers, 121.
- Reaumur's scale, 12.
- Red-hot, 2.
- Regnault's tables of specific heat, 58.
- Regulator, electro-magnetic, 343.
- Reflection, heat, 4. 119. 128.; reflecting powers, 121.
- Refraction, heat, 5. 128.; light, 116.
- Refractory bodies, 73.
- Reometer, 380.; differential, 384.
- Reoscope, 380.
- Reotrope, Pohl's, 303.
- Repulsion, magnetic, 152.; electric, 189. 241.
- Ritter, secondary galvanic piles, 296.
- Rod (discharging), 213.
- Roofs, metallic, 27.
- Scale: thermometric, 9.; centigrade, 11.; Reaumur, 12.
- Schönbein's modification of Bunsen's battery, 284.; experiments on the passivity of iron, 419.
- Sensation of heat, 144.
- See-saw (electric), 249.
- Simple voltaic combination, 267.
- Smee's galvanic battery, 282.
- Snow, perpetual, line of, 55.; effect of on soil, 111.
- Sodium, 418.
- Solar light, 115.
- Solids, dilatation of, 22.; contraction of, 26.
- Solidification, 2. 63.; of gases, 97.
- Sonometer, application of electro-magnetic machine as, 343.
- Specific heat, 47.; relation of to density, 83.



- Standard points (thermometer), 9.  
 Steam, high pressure, expansion of, 54.  
 Steel, tempering, 86.  
 Stools, insulating, 197. 212.  
 Stoves, 39.; unpolished, advantage of, 129.  
 Stratingh's galvanic deflagrator, 293.  
 Structures, metallic, 27.  
 Substances, magnetic, 156.  
 Sulphur, fusion of, 74.  
 Syringe, fire, 53.
- Temperature, 5. 31.; methods of computing according to different scales, 12.; of greatest density, 44.; method of equalization of, 51.; in liquids and gases, 109.; of globe of earth, 114.; necessary to produce combustion, 134.; of blood in human species, 138.; of blood in animals, 140. See *Heat*.  
 Terrestrial magnetism, 164.; influence of on voltaic currents, 353.  
 Thermal unit, 47.  
 Thermo-electricity, 384. See *Electricity*.  
 Thermometer, 3.; mercurial, 6.; tube, 7.; bulb, 7.; self-registering, 16.; spirit of wine, 16.; air, 16.; differential, 17.  
 Thermometry, 5, 47.  
 Thermoscopic bodies, 3. 6.; apparatus, 123.  
 Torpedo, electrical properties of, 449.  
 Tree of Saturn, 420.  
 Tube (thermometric), 7.
- Unit (thermometric), 11.; thermal, 47.
- Vaporization, 2. 86.  
 Vapor, 86.; apparatus for observing properties of, 86.; elastic, transparent, and invisible, 88.; how pressure of indicated and measured, 88.; relation between its pressure, temperature, and density, 91.; mechanical force of, 92.; dilatible by heat, 95.; properties of super-heated, 95.; cannot be reduced to liquid by mere compression, 96.; compression of, 96.; latent heat of, 101.  
 Variation, 168.; diurnal of needle, 177.  
 Ventilation of buildings, 38.  
 Vernier, 21.  
 Voltaic batteries, 285. See *Electricity*.  
 Voltaic currents, 296. 363.  
 Voltaic electricity, 67. See *Electricity*.  
 Volta's first galvanic combination, 278.; invention of the pile, 285.  
 Voltaic piles, 285.  
 Voltaic theory of magnetism, 378.  
 Voltmeter (Faraday's), 407.
- Warming buildings, 38. 46. 106.  
 Water, solidification of, 63.; liquid below 32°, 68.; pressure, temperature, and density of the vapour of water, 91.; vapour produced from at all temperatures, 91.; mechanical force of vapor of, 93.; temperature, volume, and density of vapor of, corresponding to atmospheric pressures, 95.; latent heat of vapor of, 103, 104.; a conductor of electricity, 199.; composition of, 394.; electrolysis of, 395.  
 Weight, atonic, 57.  
 Wheatstone's galvanic system, 283.  
 Wine coolers, 112.  
 Wires (electric), 301. 304.  
 Wollaston's galvanic combination, 278—290.; thimble battery, 440.
- Zamboni's galvanic pile, 295.  
 Zero of thermometric scale, 10.

THE END OF THE SECOND COURSE.

# NATURAL PHILOSOPHY, CHEMISTRY, &c.

**A HANDBOOK OF NATURAL PHILOSOPHY AND ASTRONOMY.** By **DIONYSIUS LARDNER**, formerly Professor of Natural Philosophy and Astronomy in University College, London. The First Course in One Volume, large 12mo., price 12s. 6d. cloth, illustrated by 422 Engravings on Wood, contains:—

Mechanics,	Hydraulics,	Sound,
Hydrostatics,	Pneumatics,	Optics.

The Second Course, also in One Volume, large 12mo., with upwards of 200 Illustrations, contains:—

Heat,	Magnetism,
Common Electricity,	Voltaic Electricity.

\*\* The Third Course (completing the Work) will contain  
**ASTRONOMY and METEOROLOGY.**

“We have much pleasure in recommending Dr. Lardner’s ‘Handbook of Natural Philosophy;’ it is one of the best popular scientific works that has yet appeared.”—*English Journal of Education.*

“Our examination of the work leads us to speak most favourably of it as a handbook for students; it will be a useful addition to the library of every medical student, as well as a serviceable guide to all who are about to commence the study of physics.”—*Medical Gazette.*

**THE STEAM ENGINE, STEAM NAVIGATION, ROADS AND RAILWAYS.** Explained and Illustrated. A New and Cheaper Edition, revised and completed to the present time. By **DIONYSIUS LARDNER, D.C.L.**, formerly Professor of Natural Philosophy and Astronomy in University College, London. One Vol. 12mo. Illustrated with Wood Engravings, 8s. 6d. cloth.

In former editions, much space was occupied by historical and biographical matter, as well as by the description of engines which have long since become obsolete, and which, not forming a necessary link in the chain of invention, may be considered as superfluous in a work of this description. The space has been in the present edition more usefully occupied by other matter.

The second and third parts are completely new. In the third chapter of the second part will be found a review of the progress of Steam Navigation, from its first establishment in 1812 to the present day.

**RAILWAY ECONOMY; OR, THE NEW ART OF TRANSPORT.** Its Management, Prospects, and Relations, Commercial, Financial, and Social; with an Exposition of the Practical Results of the Railways in operation in the United Kingdom, on the Continent, and in America. By **DIONYSIUS LARDNER, D.C.L.** 1 vol., large 12mo., 12s.

**CONTENTS:—**Influence of Improved Transport on Civilisation. Retrospect of the Progress of Transport. The Organisation of a Railway Administration. The Way and Works. Locomotive Power. Carrying Stock. Stations. Clearing House. Passenger Traffic. Goods Traffic. The Expenses. Receipts, Tariffs, and Profits. Accidents on Railways. Electric Telegraph. Inland Transport in the United States. Belgian Railways. French Railways. German Railways. Railways in Russia, Italy, and Spain. Comparison of Railway Transport in different Countries. Relation of Railways to the State.

**SKETCH OF THE ORIGIN and PROGRESS OF STEAM NAVIGATION.** By BENNET WOODCROFT, Professor of Machinery in University College, London. With 17 Lithographic Plates, fcp. 4to., 12s. cloth.

**THE PNEUMATICS OF HERO OF ALEXANDRIA ;** from the original Greek. Translated for and Edited by BENNET WOODCROFT, Professor of Machinery in University College, London. Fcp. 4to. 12s. 6d. cloth.

**FAMILIAR LETTERS ON CHEMISTRY,** in its Relations to Physiology, Dietetics, Agriculture, Commerce, and Political Economy. By JUSTUS VON LIEBIG. A New and Cheap Edition, revised throughout, with many Additional Letters. Complete in One Volume, fcp. 8vo. 6s. cloth.

A Sketch of the History of Chemistry has been prefixed to this Edition, which also contains the Results of the Author's most recent Researches in Dietetics, Physiology, and Agriculture.

\* \* A Prospectus, with the Contents of the Volume, may be had of the Publishers.

"Preceded by a familiar and intelligible description of how chemistry came to be what it is, the exposition of the leading truths of the science achieved in these Letters, makes not only a much more readable and interesting volume than has ever before been produced on this subject, but gives to it a scientific completeness not often attained when amusement is aimed at as well as instruction."—*Globe*.

"Every page of the volume thus teems with suggestions and inferences, for which the physician, the agriculturist, or the manufacturer, may find ready employment in their respective occupations. It is this bias towards a practical result which has conferred upon the author's scientific treatises their wide range of fame and usefulness."—*Atlas*.

**FAMILIAR LETTERS ON THE PHYSICS OF THE EARTH.** By H. BUFF, Professor of Physics in the University of Giessen. Edited by Dr. A. W. HOFMANN, Professor in the Royal College of Chemistry, London. Fcp. 8vo. 5s.

CONTENTS:—Introduction. Gravity and its Effects. Tides. Heat within the Earth. Warm Springs. Hot Springs and Jets of Steam. Jets of Gas and Mud Volcanoes. Volcanoes and Earthquakes. Temperature of the Outermost Crust of the Earth. Temperature of the Lowest Layer of the Atmosphere. Lines of equal Heat. Temperature of the Upper Layers of the Atmosphere. The Snow Limits. Glaciers. Temperature of the Waters, and their Influence on Climate. Currents of the Sea. Winds. Moisture of the Air and Atmospheric Precipitation. Electricity of the Air, Lightning and Thunder.

**THE BOOK OF ALMANACS,** with Index, by which the Almanac belonging to any Year preceding A. D. 2000 can be found ; with means of finding new and full moons from B. C. 2000 to A. D. 2000. By AUGUSTUS DE MORGAN, Professor of Mathematics in University College, London. Demy 8vo., oblong, 5s. cloth.

"This is quite a novelty in chronological literature. It is an *universal almanac*—universal, that is, as respects time, past, present, and future. The main object of it is, as the compiler states, to supply the place of an old almanac, which is never at hand when wanted ; of the older almanac, which never was at hand ; and of the universal almanac in every shape ! A more useful chronological handbook could scarcely be conceived. It will save an immensity of calculation, and is in many other respects invaluable as a chronological guide and instructor."—*Oxford Herald*.

**AN ELEMENTARY TREATISE ON MECHANICS,** for the use of the Junior University Students. By RICHARD POTTER, A. M., Professor of Natural Philosophy in University College, London. Second Edition, 8vo., with numerous Diagrams, 8s. 6d. cloth.

**AN ELEMENTARY TREATISE ON OPTICS, PART I.**  
By RICHARD POTTER, A.M., 8vo., Second Edition, corrected, with numerous Diagrams, 9s. 6d. cloth.

\*\* PART II., containing the Higher Propositions. By RICHARD POTTER, A.M., 8vo., with numerous Diagrams, 12s. 6d.

**THE ELEMENTS OF STATICS, DYNAMICS, and HYDROSTATICS,** with an Appendix on the Laws of Light, the Formation of Images by Lenses, and the Nature of Sound. By SAMUEL NEWTH, M.A., Fellow of Univ. Coll. London. Royal 12mo., boards, 6s.

**TWELVE PLANISPHERES,** forming a Guide to the Stars for every Night in the Year, with an Introduction, 8vo., 6s. 6d. cloth.

**FORMAL LOGIC,** or, the Calculus of Inference, Necessary and Probable. By AUGUSTUS DE MORGAN, Professor of Mathematics in University College, London. 8vo., 12s.

*By the same Author.*

**ELEMENTS OF ARITHMETIC.** Fifth Edition, with Eleven new Appendixes. Royal 12mo., 5s. cloth.

**ELEMENTS OF ALGEBRA.** Preliminary to the Differential Calculus. Second Edition. Royal 12mo., 9s. cloth.

**TRIGONOMETRY AND DOUBLE ALGEBRA.** Royal 12mo., 7s. 6d. cloth.

**ARITHMETICAL BOOKS AND AUTHORS,** from the Invention of Printing to the present time; being brief Notices of a large Number of Works drawn up from actual inspection. Royal 12mo., 6s. cloth.

**BARLOW'S TABLES OF SQUARES, CUBES, SQUARE ROOTS, CUBE ROOTS, and RECIPROALS,** up to 10,000. Stereotype Edition, examined and corrected. Under the Superintendence of the Society for the Diffusion of Useful Knowledge. Royal 12mo., 8s. cloth.

**REINER'S LESSONS ON FORM;** or, an INTRODUCTION TO GEOMETRY, as given in a Pestalozzian School, Cheam, Surrey. 12mo., with numerous Diagrams, 3s. 6d. cloth.

**A FIRST BOOK ON PLANE TRIGONOMETRY.** For the use of Schools. By G. W. HEMMING, M.A., Fellow of St. John's College, Cambridge. 12mo., with Diagrams, 2s. 6d.

**RITCHIE'S PRINCIPLES OF THE DIFFERENTIAL AND INTEGRAL CALCULUS,** familiarly Illustrated, and applied to a variety of useful purposes. Second Edition. 12mo., with Diagrams, 4s. 6d. cloth.

**RITCHIE'S PRINCIPLES OF GEOMETRY,** familiarly Illustrated, and applied to a variety of useful purposes. Designed for the Instruction of Young Persons. Second Edition, revised and enlarged, 12mo., with 150 Woodcuts, 3s. 6d. cloth.

**TABLES OF LOGARITHMS COMMON AND TRIGONOMETRICAL TO FIVE PLACES.** Under the Superintendence of the Society for the Diffusion of Useful Knowledge. Fcap. 8vo., 3s.

**LESSONS ON NUMBER**, as given at a Pestalozzian School, at Cheam, Surrey. By CHARLES REINER. The Master's Manual. New Edition. 12mo., cloth, 5s. The Scholar's Praxis. 12mo., 2s. bound.

**TURNER'S ELEMENTS OF CHEMISTRY.** Edited by PROFESSORS LIEBIG and GREGORY. Eighth Edition. One vol. 8vo. 1*l.* 10s. cloth. Part I.—INORGANIC CHEMISTRY, 15s. cloth. Part II.—ORGANIC CHEMISTRY, 15s. cloth.

**OUTLINES OF INORGANIC CHEMISTRY.** For the Use of Students. By WILLIAM GREGORY, M.D., Professor of Chemistry in the University of Edinburgh. Second Edition, revised and enlarged. 5s. cloth.

**GREGORY'S HANDBOOK OF ORGANIC CHEMISTRY:** being a New and greatly enlarged Edition of the "Outlines of Organic Chemistry, for the Use of Students." One Volume, large 12mo., 9s. 6*d.* cloth.

**PARNELL'S ELEMENTS OF CHEMICAL ANALYSIS, QUALITATIVE AND QUANTITATIVE.** Second Edition, revised throughout, and enlarged by the addition of 200 pages, 8vo., Cheap Issue, 9s. cloth.

**LIEBIG'S ANIMAL CHEMISTRY, OR, CHEMISTRY IN ITS APPLICATIONS TO PHYSIOLOGY AND PATHOLOGY.** Third Edition, almost wholly re-written. 8vo., Part I. (the first half of the work), 6s. 6*d.* cloth.

**LIEBIG'S CHEMISTRY IN ITS APPLICATION TO AGRICULTURE AND PHYSIOLOGY.** Fourth Edition, revised. 8vo., 10s. 6*d.* cloth.

**LIEBIG'S RESEARCHES INTO THE MOTION OF THE JUICES IN THE ANIMAL BODY.** 8vo., 5s.

**PARNELL'S DYEING AND CALICO PRINTING.** (Reprinted from Parnell's "Applied Chemistry in Manufactures, Arts, and Domestic Economy, 1844.") With Illustrations, 8vo., 7s. cloth.

**MUSPRATT'S PLATTNER ON THE BLOWPIPE,** in the Qualitative and Quantitative Examination of Minerals, Ores, Furnace-Products, &c. Second Edition, with numerous additions. Illustrated by Engravings. 8vo., 10s. 6*d.*

**OUTLINES OF THE COURSE OF QUALITATIVE ANALYSIS** followed in the Giessen Laboratory. By HENRY WILL, Ph.D., Professor Extraordinary of Chemistry in the University of Giessen. With a Preface by BARON LIEBIG. 8vo., 6s., or with the Tables mounted on linen, 7s.

LONDON: TAYLOR, WALTON, AND MABERLY,  
UPPER GOWER STREET, AND IVY LANE, PATERNOSTER ROW.

