



8037.92







# Nature

A WEEKLY

ILLUSTRATED JOURNAL OF SCIENCE

LONDON :  
R. CLAY, SONS, AND TAYLOR, PRINTERS  
BREAD STREET HILL, E.C.

# INDEX

- ABBADIE** (Antoine d'), the Earthquake of April 22, 1884, 101 ; Animal Intelligence, 125  
**Abbott** (Dr. C. C.), the Ancestor of the Dipper (Cinclus), 30  
**Abercromby** (Hon. R.), on the Origin and Course of the Squall that Capsized H.M.S. *Eurydice*, 22  
**Abrus** Poison, the non-Bacillar Nature of, Warden and Waddell, 263  
**Absorption of Water by Plants**, Francis Darwin, F.R.S., 7  
**Achcenes**, Work on, by Brau de Saint-Pol Lias, 643  
**Acta Mathematica** (Scandinavian Journal) and its Reputation in France, 153  
**Actinolite**, Scottish Localities for, Paper Read before Mineralogical Society, 181  
**Acupuncture by Chinese Doctors**, Use of, 324  
**Adams** (Prof. J. C.), Delegate to International Prime Meridian Conference, 129  
**Adelaide University**, 276  
**Afghan Frontier Commission**, Zoology and the, 324  
**Africa** : Proposed Circumnavigation of, 275 ; Return of Mr. Joseph Thomson from East, 298 ; Brief Account of Maurizio Buonfanti's Expedition across North, 131 ; African Exploration, 172 ; African Volcanoes, Dr. H. J. Johnston-Lavis, 62 ; Tropical African Mountain Flora, Sir J. D. Hooker, F.R.S., 635  
**After-Glow**, Major Robert D. Gibney, 634  
**Agram**, Earthquake at, 300  
**Agricultural Institute of Beauvais**, 367  
**Agriculture in the United States**, 77  
**Aitken** (John, J.P.), Geologist, Death of, 371  
**Alabama**, Geological Survey of, Ed. Smith, 77  
**Alabaster** (Henry), Obituary Notice of, 546 ; Scientific Services of, in Siam, 546  
**Albania**, Ethnography and Statistics of, 644  
**Albatross**, Curious Behaviour of a Booby during the Cruise of the, 130  
**Albert Medal of the Society of Arts** Awarded to Capt. James Buchanan Eads, 152  
**Albertite Beds of Strathpeffer**, Ross-shire, W. Morrison on, 181  
**Alchemy**, Mercury in Chinese, 299  
**Alcock** (Nathaniel), Why Tropical Man is Black, 401  
**Alert**, H.M.S., Sailing of the, 63 ; Report on the Zoological Collections made in the Indo-Pacific Ocean during the Voyage of the, 485  
**Alexandra House**, Laying the Foundation-Stone of, 222  
**Algae**, upon the Occurrence of Bacteria and, on the Surface of Paper Money, Jules Schaarschmidt, 360 ; on Old Coins, 478 ; Algal Flora of the Arctic Seas, Veit Brecher Wittrock, 638  
**Algebraic Geometry**, Conic Sections and, an Elementary Treatise on, G. Hale Puckle, 631  
**Algol**, Minima of, 253  
**Allen** (Grant), Flowers and their Pedigrees, 167  
**Alps**, the Building of the, Prof. T. G. Bonney, F.R.S., 44, 65  
**Alternation of Generations**, 67 ; Is Salpa an Example of, W. K. Brookes, 367  
**America** : Fossil Mollusca of North, by C. A. White, Dr. J. G. Jeffreys, F.R.S., 99 ; American Law Decisions on Details of Education, Digest of, 108 ; American Journal of Science, 118, 232, 378, 459 ; American Association for the Advancement of Science, 152, 566, 596 ; American Jurassic Dinosaurs, 201 ; Proposed American Exhibition, 275 ; Native American Literature and Ethnology, Prof. A. H. Keane, 341 ; American Initiative in Methods of Deep-Sea Dredging, R. Rathbun, 399 ; American Vines near Nîmes, 429 ; American Ornithologists' Union, 616  
**Ammonia**, Action of, upon some Lepidopterous Pigments, Geo. Coverdale, 571  
**Amour**, Exploration of, 615  
**Analysis**, Chemical, as applied to the Examination of Pharmaceutical Chemicals, Hoffmann and Power, 51  
**Analysis**, Chemical, for Schools, A. H. Scott White, 51  
**Analysis**, Qualitative, for Beginners, Stoddard's, 51  
**Anatomy**, Pathological, Ziegler's Text-Book of, 263  
**Anatomy**, Work on, by Dr. Dudgeon, from Tung Wen College at Peking, 458  
**Andalusite Schists of Aberdeenshire**, Origin of, Paper by John Horne, F.R.S.E., read before Mineralogical Society, 181  
**"Andes, Across the Pampas and among the,"** Robert Crawford, 36  
**Angara**, Rapids of the, 132  
**Animals**, Intelligence in, Duncan Stewart, Dr. John Rae, F.R.S., 6 ; E. A. Lonergan, 77 ; Col. J. Herschel, 125 ; Antoine d'Abbadie, 126 ; T. W. Kirk, Dr. H. McCormac, 240 ; T. H. Potts, 265 ; Dr. G. J. Romanes, F.R.S., 267 ; R. J. Harvey Gibson, Thomas Harrison, 538 ; Dr. Hyde Clarke, 561  
**Annalen der Physik und Chemie**, 160, 556, 579  
**Annam**, Fish in Hué River, Tirant, 21  
**Annuaire du Bureau des Longitudes**, 222  
**Antananarivo Magazine**, the, 275



- Antarctic and Arctic Seas, Voyages of Discovery in, R. McCormick, 239
- Antelon rosaceus*, the Pentacrinoid Stage of, Prof. W. A. Herdman, 634
- Anthropological Banquet to Gabriel de Mortillet, 40
- Anthropological Institute, 47, 162, 187, 235
- Anthropological Picture, an, 41
- Anthropology of Brazil, Early, 395
- Aquarius, Variable Star in, 346
- Ararat, Ascents of, 396
- Archæological Collections in the Indian Museum, Catalogue and Handbook of, John Anderson, 511
- Archibald (E. Douglas), Science and Military Examinations, 239; Solar (Dust?) Halo, 559
- Archives Italiennes de Biologie, 330
- Archives des Sciences Physiques et Naturelles (de Genève), 508
- Arcimis' Observations of Sunset Phenomena in Spain, 324
- Argyll (Duke of), Diffusion of Species, 462
- Arithmetical Chemistry, C. J. Woodward, 4
- Arlberg Tunnel, 615
- Arnesen (Capt. M. E.) of Tromsø, Particulars of his Voyages in Spitzbergen Seas, 132
- Arctic and Antarctic Seas, Voyages of Discovery in, R. McCormick, 239
- Arctic Seas, Algal Flora of the, Veit Brecher Wittrock, 638
- Ascent of Water in Plants, 561
- Aseismic Tables for Mitigating Earthquake Shocks, Chas. A. Stevenson, 193
- Asia (Central), Regel's Explorations in, 275
- Asia Minor, Earthquake in, 83
- Asiatic Turkey, Natural History Collections of, 615
- Association of German Naturalists and Physicians, 625
- Astronomy: Astronomical Column, 21, 41, 64, 83, 131, 154, 181, 200, 253, 300, 325, 346, 374, 397, 431, 458, 479, 496, 519, 547, 594, 615, 643; Recent Improvements in Astronomical Instruments, 181; a New Astronomical Journal, 173; Astronomical Photography, 496; Pending Problems of Astronomy, Prof. C. A. Young, 501; Handy Book of Celestial Motion, W. T. Lynn, 606
- Athens, Report of the School of Classical Studies at, 108
- Atkinson (A. S.), Pons' Comet, 55, 463; Pink Glow, 463
- Atlantic Ice and Mild Winters, Dr. John Rae, F.R.S., 76
- Atlantic Sea-Surface, Temperature of, 545
- Atmospheric Appearances at Berlin, 199
- Atmospheric Dust, R. Brough Smyth, 170; Alexander McAdie, 194
- Atmospheric Glow at Berlin, 546
- Atti della R. Accademia dei Lincei, 161, 379, 403
- Aumoitte (M.), Journey in Tonquin, 276
- Aurora Borealis, the Artificial, 252
- Aurora in Northern Europe, Dr. S. Tromholt, 592
- Auroral Researches in Iceland, Dr. Sophus Tromholt, 80
- Australasia, Early Discoveries in, E. A. Petherick, 109
- Australian Museum, 642
- Australian Orchids, 437
- Austrian Geological Institute, 202
- Ave-Lallemant (Dr. Robert), Obituary Notice of, 615
- Axis of Rotation, Earth's, Prof. C. Piazzi Smyth, 29
- Axis, Shifting of the Earth's, W. M. Flinders Petrie, 512, 561; W. H. M. Christie, F.R.S., 536; Prof. C. Piazzi Smyth, 582
- Ayrton (Prof. W. E., F.R.S.), New Form of Spring for Electric and other Measuring Instruments, 205
- Bachmetieff (M.), Magnetic Heat, 223
- Bacillus, Comma-Shaped, Alleged to be the Cause of Cholera, Timothy Richards Lewis, 513
- Backhouse (T. W.), the Supposed Volcanic Dust Phenomena, 54, 359, 633; Sky-Glows, 511
- Bacteria and Minute Algae on the Surface of Paper Money, upon the Occurrence of, Jules Schaarschmidt, 360
- Bacteria, Fungi and, A. de Bary, 433
- Bacteria on Old Coins, 478
- Baden-Powell (Lieut.), Balloon Ascent, 20
- Baginski (Dr. A.), Xanthines, 236
- Baker (Henry B.), Cholera Germ, 407
- Baker (J. G., F.R.S.), "Manual of the Mosses of North America," Leo Lesquereux and Thos. James, 461; Synopsis of the British Mosses, C. P. Hobkirk, 582
- Baker (T. W.), Sextants, 464
- Baku Naphtha and Specific Weights, 374
- Balding (A.), Voracity of the Drosera, 241
- Balearic Isles, Natural History Collections of, 615
- Ball Lightning, M. Planté on its Cause and Explanation, 569
- Ball (Prof. R. S.), Comets, 454
- Ball (Prof. V., F.R.S.), the Distribution of Scientific Works Published by the British Government, 634
- Balloons: Ascent by Lieut. Baden-Powell, 20; Ascent of Three from Finsbury Armoury, 494; Directing of, 373, 457, 494, 641
- Baltic, Migrations of *Salmo salar* (L.) in the, Prof. And. Joh. Malmgren, 521
- Baltimore, Peabody Institute of, 299
- Barnard's Comet, A. A. Common, 511
- Barometer of January 26, 1884, the Low, 58
- Barral (J. A.), Obituary Notice of, 517
- Bary (A. de), Fungi and Bacteria, 433
- Bashworth (Rev. Frs.), on the Motion of Projectiles, 5
- Bates (E. F.), Carnivorous Wasps, 408
- Batteries, Storage, 585
- Battery with Two Carbon Electrodes, 518
- Batuta's (Ibn) Travels to Ceylon and the Maldivé Islands, Translation into English of, 132
- Bauerman (Hilary), "Text-Book of Descriptive Mineralogy," 461
- Beauvais, Agricultural Institute of, 367
- Beddard (F. E.), a Gigantic Earthworm, 570
- Beetz, Standard Cell, 568
- Belgian Erratics, 154
- Belgium, Geological Survey of, 201
- Bell (Dr. F. Jeffrey), a Rare British Holothurian, 146; the Cotton-Spinner, 193, 335
- Bell (J. Lowthian, F.R.S.), Address to Mechanical Engineering Institute at Cardiff, 343
- Bell (Dr. Robert), Geology and Mineralogy of Northern Canada, 228
- Bellio (Prof.), Account of MS. by Castelli, 569
- Bells, Water, 408
- Ben Nevis: Observatory, 179, 613, 640; Plants from, 429; Meteorology of, Alexander Buchan, 336
- Bentham (George, F.R.S.), Death of, 476; Obituary Notice of, 539; Memorial of, at Royal Herbarium, 591
- Bergsman (Dr. M.), Difference between Sea and Continental Climate with Regard to Vegetation, 392
- Berlin: Geographical Society, 570; Thüringo-Saxon, 592; Meteorological Society, 652; Physical Society, 24, 188, 308, 356; Physiological Society, 48, 96, 140, 212, 236, 260, 308, 380, 531
- Bernard (Mrs. K. M.), the Earthquake, 145
- Bertrand and the Académie Française, 613
- Beryllium Chloride, Preparation of Pure, Nilson and Petterson, 84
- Bevan (G. Phillips), London Water-Supply, 165; Kansas, 295
- Bibliography, New Guinea, E. C. Rye, 275
- Bidwell (Shelford), on a Relation between the Thomson Effect and other Physical Properties of Metals, 94
- Binaries, Southern, 594
- Binary-Star  $\beta$  Delphini, 301
- Biological Association, Marine, 123, 350
- Biological Coast Survey, Proposed, Prof. E. R. Lankester, F.R.S., 76
- Biology at St. Andrew's, 107
- Biology v. Botany, Rev. Geo. Henslow, 537
- Birds: Meyer's Skeletons of, 78; Instinct in, 102; W. Brown, 56; Yarrell's History of British, 287; British Birds at the Natural History Museum, 491; Birds'-Nest Soup, 271; Bird's Nests, Henry Seebohm, 276; on the Preservation of Birds (Wild) in India, R. H. Elliott, 276
- Bishop (S. E.), Red Glow, 194; September Stream of Krakatoa Smoke at Strong's Island, 537
- Bismuth, Electrical Resistance of, 569
- Black, Why Tropical Man is, N. Alcock, 401
- Blanford (H. F., F.R.S.), Connection of the Himalayan Snow-fall with Dry Winds and Drought in India, 46; Theory of Winter Rains of Northern India, 304
- Blavier (E. E.), "Etude des Courants Telluriques," 106

- Blood Corpuscles, Photography of, 547  
 Blood, Experiment on Nature of, Dr. Cohnstein, 48  
 Blumentritt (Prof.), on Geography and Ethnology of Philippine Islands, 643  
 Body, Electrical Resistance of the Human, Dr. W. H. Stone, 269  
 Hoeddicker (Otto), the Recent Eclipse of the Moon, 589  
 Boguslawski (Dr. von G.), Death of, 180  
 Bois (Dr. Du), on Earthquakes, 614  
 Bolide at Elizabethpol, 478  
 Boma, Meteorological Observatory at, 223  
 Bonney (Prof. T. G., F.R.S.), the Building of the Alps, 44, 65; Rhyolitic Rock from Lake Tanganyika, 193  
 Bontemps (M.), Death of, 107  
 Booby, Story of a, Alighting on the *Albatross*, 130  
 Botany: some Botanical Queries, 194; *Botanische Practicum*, Dr. Strasburger, 214; Butterflies as Botanists, 269; Younger School of Botanists, W. T. Thiselton Dyer, F.R.S., 559; *Biology v. Botany*, Rev. George Henslow, 537; Handbook of Botany, Dr. A. Schenk, 581; Tropical African Mountain Flora, Sir J. D. Hooker, F.R.S., 635  
 Bottomley (J. T.), Curious Phenomenon, 634  
 Boulder-Glaciation, Hugh Miller, 23  
 Bourdon, Death of, 568  
 Bournonite, Crystallography of, Paper read before the Mineralogical Society, 181  
 Boyle-Marriott Law, 458  
 Bozward (J. Ll.), *Pevonospora infestans*, 216; the Remarkable Sunsets, 32  
 Brachiopoda in Kendal Museum, 154  
 Brachiopodenfauna, Beiträge zur Kenntniss der Liasischen, von Südtirol und Venetien, Hyppolyt Haas, 192  
 Brain, Physiology of the, Prof. Christiani, 260  
 "Brasilische Säugethiere," Natterer's, 74  
 Brazil, Early Anthropology of, 395  
 BRITISH ASSOCIATION: Meeting at Montreal, 63, 217, 275, 410; Reception, Addresses of Welcome, Excursions, &c., 410, 439, 468; Inaugural Address by the President, the Right Hon. Lord Rayleigh, D.C.L., F.R.S., 410; Conferring Degree of LL.D. of McGill University on Prominent Members of Association, 439, 468; Movement to Establish a Public Library in Montreal as Commemoration of Visit of Association, 468; Gold Medal in Applied Science provided by Association for Benefit of McGill University, 439, 468; Proposed Formation of Science Scholarships in McGill University, 439; Grants, 468; Next Meeting of Association at Aberdeen, 469; Proposed International Scientific Congress, 469  
 Reports of Committees:—Continuing Inquiries relating to Teaching of Science in Elementary Schools, 496; Exploring Kilimanjaro and the adjoining Mountains of Eastern Equatorial Africa, 497; Reducing and Tabulating Tidal Observations in English Channel made with Dover Tide-Gauge, and connecting them with Observations made on French Coast, 498; on Best Methods of Recording Direct Intensity of Solar Radiation, 498; Investigating Natural History of Timor Laut, 498; on Migrations of Birds observed at Lighthouses and Light-vessels, 499; Investigating Circulation of Underground Waters in Permeable Formations of England and Wales, and Quantity and Character of Water supplied to various Towns and Districts from those Formations, 500; on Rate of Erosion of Sea-Coasts of England and Wales, 522  
 Section A (*Mathematical and Physical Science*).—Opening Address by the President, Sir William Thomson, 417; J. T. Bottomley, on Loss of Heat by Radiation and Convection as affected by Dimensions of Cooling Body, 523; W. J. Millar, on Phenomena connected with Iron and other Metals in Solid and Molten States, 524; Prof. Sir W. Thomson, on a Gyrostatic Working-Model of the Magnetic Compass, 524  
 Section B (*Chemical Science*).—Opening Address by Prof. Sir H. E. Roscoe, F.R.S., 421  
 Section C (*Geology*).—Opening Address by the President, W. T. Blanford, F.R.S., 440; Rev. E. Hill, on Ice-Age Theories, 526; C. Le Neve Foster, on What is a Mineral Vein or Lode?, 526; L. W. Bailey, on Acadian Basin in American Geology, 526; W. F. Stanley, on Improbability that Former Glacial Periods in Northern Hemisphere were due to Eccentricity of Earth's Orbit, &c., 526; F. D. Adams, on Norwegian "Apatitbringer" in Canada, and Microscopic Characters of some Laurentian Amphibolites, 526; G. F. Matthew, on Geological Age of Acadia, Fauna, 527; Principal Dawson, F.R.S., on More Ancient Land Floras of Old and New Worlds, 527; E. Wethered, F.G.S., on Structure of English and American Carboniferous Coals, 527; Ralph Richardson, on Dissimilarity and Resemblance between Acadian and Scottish Glacial Beds, 528; V. Ball, F.R.S., on Occurrence of Precious Stones and Metals in India, 528; J. S. Gardner, F.G.S., on Relative Ages of American and English Cretaceous and Eocene Series, 528; Prof. E. W. Clappole, on Remains of Fish from Upper Silurian Rocks of Pennsylvania, 529; Hugh Miller, F.G.S., on Fluxion Structure in Till, 530; Dr. J. D. Dana, on Southward Ending of a Great Synclinal in Taconic Range, 530; G. F. Matthew, on Primitive Conocoryphean, 530; W. Whitaker, F.G.S., on Value of Detailed Geological Maps in Relation to Water-Supply, &c., 530; Prof. E. W. Clappole, on Pennsylvania before and after Elevation of Appalachian Mountains, 531  
 Section D (*Biology*).—Opening Address by the President, Prof. H. N. Moseley, F.R.S., 425  
 Department of Zoology and Botany.—Prof. Asa Gray, on Characteristic Features of North American Vegetation, 573; Prof. Moseley, on Trapping of Young Fish by *Utricularia vulgaris*, 574; Albert S. Bickmore, on the Jessop Collection in New York Natural History Museum, 574; W. J. Sollas, on the Origin of Freshwater Fauna, 574; Dr. Gwyn Jeffreys, on the Concordance of the Mollusca inhabiting both Sides of the North Atlantic, 574; Prof. J. Struthers, on the Rudimentary Hind Limb of the Humpbacked Whale, *Megaptera longimana*, 574; Prof. D. J. Cunningham, on the Value of Nerve-Supply in Determination of Muscular Anomalies, 574; Prof. A. M. Marshall, on Mutual Relation of Recent Groups of Echinoderms, 575; A. H. Caldwell, on Foetal Membranes of Marsupials, 575; G. F. Dobson, F.R.S., on some Peculiarities in Geographical Distribution and Habits of Mammals inhabiting Continents and Oceanic Isles, 575; Howard Saunders on Geographical Distribution of Laridæ, 575; W. B. Hemsley, on Investigations of Insular Floras, 575; G. P. Hughes, on Direct Descendants of *Bos primigenius* in Great Britain, 575; Dr. W. Fraser, on Natural Co-ordination in Organic Evolution, 575  
 Department of Anatomy and Physiology:—Prof. H. N. Moseley, F.R.S., on Eyes and other Sense-Organs in Shells of Chitonidæ, 575; Rev. Dr. Dallinger, F.R.S., on Germs of Septic Organisms, 576; A. W. Bennett, on a Vegetable Organism which separates Sulphur, 576; Prof. H. N. Martin and W. H. Howell, on Coagulation of Blood, 576; Francis Gotch and J. P. Laws, on Blood of *Limulus polyphemus*, 576; Prof. H. P. Bowditch, on Vaso-Motor Nerves, 576; Prof. T. W. Mills, Demonstrating Coordinating Centres of Kronecker, 576; Profs. Kronecker and Mills on Cardiac Nerves of Turtle, 576; V. Horsley and Prof. Schäfer, on Functions of Marginal Convolution, 576; Prof. R. Ramsay Wright, on Sensory Nerve-Sacs in Skin of *Amiurus* and Function of Air-Bladder in *Amiurus*, 577; Announcement that Mr. Caldwell, Balfour Student, had discovered that Monotremes were Oviparous, 577  
 Section E (*Geography*).—Opening Address by Gen. Sir J. H. Lefroy, F.R.S., 469; Lieut. Greely, on his Recent Arctic Expedition, 438  
 Section G (*Mechanical Science*).—Opening Address by the President, Sir F. G. Bramwell, F.R.S., 472  
 Section H (*Anthropology*).—Opening Address by the President, E. B. Tylor, F.R.S., 448; Horatio Hale on the Origin of Wampum, 577; Major J. W. Powell on the Marriage Laws of North American Tribes, 577; C. A. Hirschfelder on Prehistoric Remains in Canada, 577; Major J. W. Powell on the Classification of North American Languages, 578; Mrs. E. A. Smith on the Customs and Language of the Iroquois, 578; F. H. Cushing on Art among the Zunis, 578; Dr. Daniel Wilson on the Huron-Iroquois, 579; Prof. G. Lawson on Food-Plants used by Indians, 579; Lieut. P. H. Ray on the Habits of the Inu, 579; R. Law on Flint Implements, 579  
 British Association Catalogue of Stars, 496

- British Birds at the Natural History Museum, 491  
 British Fungi, Flora of, Rev. J. Stevenson, 181  
 British Government, the Distribution of Scientific Works Published by the, Prof. V. Ball, F.R.S., 634  
 British Isles, Temperature of Sea Round, 545  
 "British Mining," Robert Hunt, 358  
 British Mites, "The British Oribatidæ," A. D. Michael, Sir J. Lubbock, F.R.S., 141  
 British Mosses, Synopsis of the, C. P. Hobkirk, J. G. Baker, F.R.S., 582  
 Broca (Paul), Proposed Monument to, 82  
 Brook (Geo.), *Trachinus vipera*, 71  
 Brookes (W. K.), Is Salpa an Example of Alternation of Generations?, 367  
 Brorsen's Comet of Short Period, 300, 397, 459  
 Brown (E.), the Sky-Glows, 607  
 Brown (J. Croumbie), Forestry, 309; Forests and Forestry of Northern Russia and Lands Beyond, 535  
 Brown (W.), Instinct in Birds, 46  
 Browne (Miss T. M.), the Sky-Glows, 537  
 Browne (W. R.), Pyrometers, 366; Death of, 478  
 Bruel (M.), Death of, 21  
 Brussels Museum and its Work, 201  
 Buchan (Alexander), Meteorology of Ben Nevis, 336  
 Bulletin de l'Académie Royale de Belgique, 94, 209, 459, 508, 650  
 Bulletin de l'Académie des Sciences de St. Pétersbourg, 305  
 Bulletin de la Société d'Anthropologie de Paris, 160, 233, 650  
 Bulletin de la Société des Naturalistes de Moscou, 1883, 161, 627  
 Bulletin of the United States National Museum, 287  
 Bunge (Dr.), Revisiting the Place where the Adams Mammoth was found, 130, 430  
 Buonfanti's (Maurizio) Expedition across North Africa, Brief Account of, 131  
 Burder (Geo. F.), the Recent Eclipse of the Moon, 589  
 Burmah: Education in British, 545; Progress of English in, 644  
 Butterflies as Botanists, Dr. F. Müller, 240, 269
- Calabar, Rogozinski's Travels between Cameroon and, 109  
 Calculus, Integral, Elementary Treatise on, B. Williamson, F.R.S., 143  
 Calcutta Botanic Garden, 196  
 California, Stormy Winter in, 41  
 Callovian Rocks, Position of the, 154  
 Calvert (James Snowdon), Death of, 547  
 Cambridge, Palæolithic Implements from, M. C. Hughes, 632  
 Cambridge Philosophical Society, 162, 187  
 Cameroon and Calabar, Rogozinski's Travels between, 109  
 Canada, Northern, Geology and Mineralogy of, Dr. R. Bell, 228  
 Canada Pacific Railway, Geology of the Country Traversed by the, Principal Dawson, F.R.S., 95  
 Canadian Coals and Lignites, 154  
 Canadian Meteorological Service, 641  
 Canadian North-West, Notes on the, Gerrard A. Kinahan, 340  
 Cane (Frank E.), Rainbow on Spray, 490  
 Cannibal Snake, a, John Fotheringham, 269; Dr. C. F. Crehore, 408  
 Cape Heliumeter, the, 459  
 Capillary Constants of Liquids at their Boiling-Points, 618  
 Carnivorous Plant, a, Preying on Vertebrata, Prof. H. N. Moseley, F.R.S., 81  
 Carnivorous Plant, a, Commander A. Carpenter, 289  
 Carnivorous Wasp, 385; Rev. Geo. Henslow, 407; Rev. W. Clement Ley, 407; H. N. Dixon, 408; William White, 408; Thomas Edward, 408; E. F. Bates, 408  
 Carpenter (Commander A.), a Carnivorous Plant, 289  
 Carpenter (Dr. Herbert), Anatomy of Crinoids, 82  
 Carpenter (L. G.), the Remarkable Sunsets, 32  
 Carpenter (William Lant), Report on Comparison between Apparent Inequalities of Short Period in Sunspot Areas and in Diurnal Temperature Ranges at Toronto and at Kew, 118; Primary Education at the Health Exhibition, 218; Technical School Education at the Health Exhibition, 244
- Casey (John, F.R.S.), the First Six Books of the Elements of Euclid, 606  
 Castelli (Fra Teramo), Curious MS. of, 569  
 Caucasian Geographical Society, 396  
 Cauterisation in China, 324  
 Cayley (Prof., F.R.S.), awarded the First De Morgan Gold Medal, 179; the De Morgan Memorial Medal, 640  
 Cecil (Henry), Fireball, 289  
 Celestial Motion, a Handy Book of Astronomy, W. T. Lynn, 606  
 Centaurus, Ptolemy's 30th of, 346  
 Central Asia and Tertiary Botany, 430  
 Central Institution for Technical Education, Contributions to, 129, 198; Programme, 476  
 Ceylon: Ibn Batuta's Travels to, 132; Insect Pests in, 615; W. L. Distant, 634; Public Instruction in, 641  
 Chadwick (H. C.), *Psadalirius minutus*, 385  
 Chalk and the "Origin and Distribution of Deep-Sea Deposits," J. Starkie Gardner, 192, 264; Dr. J. Gwyn Jeffreys, F.R.S., 215  
 Challenger Reports, 533  
 Chambers's Vestiges of Creation, Dr. G. J. Romanes, F.R.S., 73  
 Chemistry: a Manual of, H. Watts, 357; Arithmetical Chemistry, C. J. Woodward, 4; Experimental, J. E. Reynolds, 4; Facts around us, C. L. Morgan, 51; Chemical Analysis as Applied to the Examination of Pharmaceutical Chemicals, Hoffmann and Power, 51; Chemical Analysis for Schools, A. H. Scott White, 51; the Discovery of the Periodic Law, by John A. R. Newlands, 51; Recent Chemistry, 51; Prof. Ramsay's Experimental Proofs of Chemical Theory for Beginners, 51; Chemical Society, 71, 119, 187; Roscoe and Schorlemmer's Chemistry, Dr. H. Watts, 75; Chemical Notes, 84, 616; Numerical Exercises in Chemistry, T. Hands, 239; Chimie Elementaire, Prof. Licherdopol, 239; Chemical Research in England, Dr. Perkin, 246; Raoul Jagnaux's "Traité Pratique d'Analyses Chimiques et d'Essais Industriels," 311; Relations between Composition and Structure of Chemical Compounds, 616  
 Chester Society of Natural Science, 547  
 Chierchia (G.) and Dr. Albert Günther, F.R.S., Voyage of the *Vittor Pisani*, 365  
 China: Early Culture in, 276; Mercury in Chinese Alchemy, 299; Cauterisation and Acupuncture in China, 324; Mining in, 430; Chinese Diet, Dress, and Dwellings, 458; Chinese and Japanese Plants in Normandy, 431; Stone Hatchets in, Rev. Dr. Joseph Edkins, 515; the Connection between Chinese Music, Weights, and Measures, 565; Chinese Geographical Orthography, 592; Chinese Notions of Immortality, 642  
 Chlorophyll, Dr. Hansen, C. A. MacMunn, 224  
 Cholera: Award to Dr. Koch, 63; Cholera at Toulon, 213; the Cholera Germ, 237, 263; Henry B. Baker, 407; Commission to Inquire into Cholera in India, 323; "Commishaped Bacillus" alleged to be the Cause of Cholera, Timothy Richards Lewis, 513; Cholera Poison, 557; Report of Five French Physicians on, 545; in India and China, 546, 566; the Epidemic of 1884, 629  
 Christiani (Prof.), Physiology of the Brain, 260  
 Christie (W. H. M., F.R.S.), Shifting of the Earth's Axis, 536  
 Cinclus (Dipper) Ancestor of, Dr. C. C. Abbott, 30  
 Circular Rainbow seen from Hill top, E. L. Layard, 361; W. L. Goodwin, 465; W. P. Marshall, 584; W. Symons, 607  
 City Companies Commission, 222  
 City and Guilds of London Institute, 377  
 Clark (Edwin), Rotating Thermometers, 32  
 Clark (J. Edmund), the Earthquake of April 22, 1884, 19; Sky-Glows, 488, 607  
 Clark's (Latimer) Mercurous Sulphate Cell, 568  
 Clarke (Dr. Hyde), Animal Intelligence, 561  
 Classical Studies at Athens, Report of the School of, 108  
 Clay, Pipe-, A. Hale, 489  
 Clymenias, on Asiatic Slope of Ural, 495  
 Coals, Canadian, and Lignites, 154  
 Cobalt Chloride, Hydration of, Potilitzin on, 84  
 Coburg, Germany, and Russia, Forests in, 515  
 Cochin China, Excursions et Reconnaissances, 299

- Cockchafer, European, 546  
 Cocking (Annie E.), Fireball, 269, 289  
 Coefficients of Capillarity of Liquid Carbon Compounds, 616  
 Coffee-Leaf Disease, the, 252, 546  
 Cohnstein (Dr.), Experiments on Nature of Blood, 48  
 Coleopterology of North America, 495  
 Cole's Pits, Rev. A. Irving, 560; Joseph Stevens, 607  
 Colini (Dr. G. A.), on Indians of Upper Amazon Regions, 344  
 Colliery Explosions, on the Influence of Coal-Dust in, Paper Read before the Royal Society, 262  
 Collimator, New, for Reflecting Telescopes, G. J. Stoney, F.R.S., 22  
 Collins (J. H.), Mineralogy, 143  
 Colombo, Proposed University in, 641  
 Colonial and Foreign Reports, 370  
 Colorado, the Silver Districts of, Henry Gunn, 71  
 Colorado and European Russia, Geological Parallel between, 614  
 Colour of Flowers, 519  
 Colours, Complementary, Dr. König, 308  
 Comets: Prof. R. S. Ball, 454; New, 83, 326, 346, 397; of 1729, 519; of 1858 III., the, 253; of 1882, the Great, 42, 154; of 1884 *b* (Barnard, July 16), 431, 458, 479, 496, 547; A. A. Common, 511; Comet 1884 *c*, 548; Periodical Comets in 1885, 346; Brorsen's Comet of Short Period, 42, 300, 459; Approaching Appearance of Encke's Comet, 594; Approaching Return of Olbers' of 1815, 64, 519; Pons' Comet, A. S. Atkinson, 55, 463; the Southern, Ross, January 7, 21; Wolf's Comet, 615; 643  
 'Comma-Shaped Bacillus,' Alleged to be the Cause of Cholera, Timothy Richard Lewis, 513  
 Commercial Geographical Society of Paris, 644; of Oporto, 644  
 Common (A. Ainslie), Rings of Saturn, 144; Læwy's New Telescope System, 434; Barnard's Comet, 611  
 Conference, International, on Education, 363  
 Congo, Exploration on the, 570  
 Conic Sections, G. Hale Puckle, 631  
 Continental Climate, Difference between Sea and, with regard to Vegetation, Dr. M. Bergsman, 392  
 Continents, Permanency of, Rev. Geo. Henslow, 407  
 Copper Sulphate, on the Density and Thermal Expansion of Aqueous Solutions of, Prof. J. G. MacGregor, 227  
 Corals, Deep-Sea, Prof. Martin Duncan, F.R.S., 464  
 Corea, Memoirs of the Interpreter, Otano Kigoro, on, Translated from the Japanese into Russian, 132  
 Cory (F. W.), How to Foretell the Weather with the Pocket Spectroscope, 606  
 Cotterill (James H., F.R.S.), "Applied Mechanics," Dr. J. F. Main, 382  
 Cotton Exhibition in America, 180  
 "Cotton-Spinner," Dr. F. Jeffrey Bell, 193, 335  
*Coudé*, Equatorial, of the Paris Observatory, Howard Grubb, F.R.S., 123  
 "Courants Telluriques, Étude des," E. E. Blavier, 106  
 Coverdale (Geo.), Action of Ammonia upon some Lepidopterous Pigments, 571  
 Crayfishes, Habits of Burrowing, in the United States, Ralph S. Tarr, 127  
 'Creation, Vestiges of,' Robert Chambers's, Dr. G. J. Romanes, F.R.S., 73  
 Crehore (Dr. C. F.), Cannibal Snake, 408  
 Crepuscular Lights, Theories of the Late Remarkable, A. G. Mocenigo, 82  
 Cresswell Caves in Derbyshire, 153  
 Cretaceous Flora of North America, Sir J. W. Dawson, 631  
 Crinoids, Anatomy of, Dr. Herbert Carpenter, 82  
 Crompton (R. F. B.), Artificial Lighting, 281  
 Crops, Field and Garden, Diseases of, Geo. Murray, 605  
 Crosskey (Henry W., LL.D.), Peripatetic Method of Instruction in Science and its Development, 622  
 Crystalline Rocks, the Origin of, T. Sterry Hunt, F.R.S., 227  
 Crystalline Schists, Origin of the, Dr. Johannes Lehmann, Arch. Geikie, F.R.S., 121  
 Cube, to Find the, of any Number by Construction, R. Tucker, 539, 561, 584  
 Curare, the Gaseous Inhalation and Exhalation in the Case of Animals affected with, Prof. Zuntz, 96  
 Currents, Earth, 106  
 Currents, Terrestrial, Dr. Wild, 223  
 Dairoku (Kikuchi), at Meridian Congress, 567  
 Dallinger (Rev. W., F.R.S.), Researches on the Origin and Life-Histories of the Least and Lowest Living Things, 619, 645  
 Dalton (John), Reminiscence of, 431  
 Daniel (Alfred), Text-Book of the Principles of Physics, 49  
 Darkness at Midday, Extraordinary, Rev. S. J. Perry, F.R.S., 6  
 Darwin (Charles), Five Bursaries at St. Petersburg University in his Name, 344  
 Darwin (Francis, F.R.S.), Absorption of Water by Plants, 7  
 Darwin (W. E.), Worm-Eating Larva, 146  
 Dawson (Principal Sir J. W., F.R.S.), Geology of the Country Traversed by the Canada Pacific Railway, 95; Prehistoric Man in Egypt and Syria, 95; Knighted, 494; Cretaceous Flora of North America, 631  
 Day (Francis), Salmon-Breeding, 488  
 Decharme, Experiments of, 568  
 Deep-Sea Deposits, on the Nomenclature, Origin, and Distribution of, John Murray and Rev. A. Renard, 84, 114, 132; J. Starkie Gardner, 192, 264; Dr. J. G. Jeffreys, F.R.S., 215  
 Deep-Sea Dredging, American Initiative in Methods of, R. Rathbun, 399  
 Deme and the Horde, the, Howitt and Fison, 235  
 Denning (W. F.), the Rotation Period of Mars, 55; Jupiter 125  
 Diatomaceous Deposits in Scotland, Prof. W. J. Macadam, 181  
 Diderot Centenary, 346  
 Diffusion of Species, Duke of Argyll, 462; Dr. G. C. Wallich, 512; R. Scot Skirving, 512  
*Dijnaphna* Expedition, Proposed New, 64  
 Dilatation of Liquids, 396  
 Diller (J. S.), Atmospheric Sand-Dust from Unalaska, Report on, 91  
 Dinosaurs, American Jurassic, 201  
 Dipper (Cinclus), the Ancestor of the, Dr. C. C. Abbott, 30  
 Discomycetes, a Manual of the British, 130  
 Distant (W. L.), Insect Pests in Ceylon, 634  
 Dittmar (Prof., F.R.S.), on the Composition of Ocean Water, 292  
 Dixon (H. N.), Carnivorous Wasps, 408  
 Dobbie (J. J.) and T. and A. Gray, on the Relation between the Electrical Qualities and Chemical Composition of Glass, 70  
 Dog-Poison, the Dilution of, 97  
 Dogs, Plague of, in Australasian Colonies, 345  
 Dolbear (Prof.), the Electrical Resistance of the Human Body, 56  
 Double-Star 99 Hercules, 375  
 Double-Stars, New Southern, 616  
 Double-Storeyed Houses in the Himalayas, B. D. Oldham, 30  
 Dragon-Flies at Moscow, Clouds of, 223  
 Drosera, Voracity of the, A. Balding, 241  
 Dublin Royal Society, 22, 72, 162, 331  
 Dublin, Sanitary Institute at, 557  
 Dublin University Experimental Science Association, 187  
 Dumas (J. B.), the Late *Éloges* on, 15  
 Dumas (Mathieu), Proposed Statue of, Dr. W. H. Perkin, 263  
 Duncan (Prof. Martin, F.R.S.), Deep-Sea Corals, 464  
 Dust: Atmospheric, R. Brough Smyth, 170; Alexander McAdie, 194; Solar, Prof. E. Douglas Archibald, 559; T. W. Backhouse, 633  
 Dust-Free Spaces, E. W. Serrell, jun., 53; Prof. O. Lodge, 54  
 Duter (M.), Experiments on Magnetic Shells, 568  
 Dyer (W. T. Thiselton, F.R.S.), Younger School of Botanists, 559  
 Dynamic Electricity, J. Hopkinson, J. N. Shoolbred, and R. E. Day, 144  
 "Dynamo-Electric Machinery," Prof. Silvanus P. Thompson, 144, 630  
 Earth Currents, 106  
 Earth, the Movements of the, by J. Norman Lockyer, F.R.S., 110, 254, 480

- Earth Tremors, 614
- Earth's Axis of Rotation, Prof. C. Piazz-Smyth, 29
- Earth's Axis, Shifting of the, W. M. Flinders Petrie, 512, 561; W. H. M. Christie, F.R.S., 536; Prof. C. Piazz-Smyth, 582
- Earthquake: the, of April 22, 1884, W. Topley, 17, 60; Surgeon-Major Eatwell, 18; Dr. J. E. Taylor, 18, 31; A. H. Waters, 19; Rev. O. Fisher, 19, 125; G. M. Whipple, 19; J. Edmund Clark, 19; C. E. De Rance, 31, 57; Edward Newton, 32; Rev. F. W. Ragg, 32; C. L. Prince, 57; M. I. Plarr, 77; H. C. Sorby, F.R.S., 101; Antoine d'Abbadie, 101; A. Shaw Page, 102; J. Henry Kinahan, 125; W. F. Stanley, 125; R. Meldola, 145; Col. H. H. Godwin-Austen, F.R.S., 145; Mrs. K. M. Bernard, 145; R. McLachlan, F.R.S., 170, 344, 372; Earthquake at Timor, 300; at Agram, 300; in the Alban Hills, Rome, 372; in Asia Minor, 83; in Lower Austria, 478; in Bosnia, 344; in Ischia, 324, 614; in Italy, 64; Northern Japan, 614; in Japan, F. Warrington Eastlake, 435; at Kishm, 130; at Massowah, 324, 372; in New York, 372; in Philadelphia, 372; at Réunion, 458; in Ontario, 518; at Windsor, 518; off Keykianes, 614; in Tokio, 614; Dr. H. J. Johnston-Lavis on, 608; Ascismic Tables for Mitigating Earthquake Shocks, Chas. A. Stevenson, 193; W. Topley, 216; Measuring Earthquakes, Prof. J. A. Ewing, 149, 174
- Earthworms: Notes on, Prof. T. McKenny Hughes, F.R.S., 57; E. A. Swan, 77; Fatal Effects of Sea on, 83; a Gigantic, F. E. Beddard, 570
- Eastern Counties, Hydrodictyon in the, Rev. J. C. Saunders, 488
- Eastlake (F. Warrington), Earthquake in Japan, 435
- Eatwell (Surgeon-Major), the Earthquake of April 22, 1884, 18
- Eclipses: Total Solar of 1816, November 19, 616; Solar, of March 16, 1885, 643; Total Solar, of 1889, January 1, 131; Lunar, on October 4, 519, 548; Otto Boeddicker on, 589; E. J. Lowe, F.R.S., 590; Geo. F. Burder, 590; H. Dennis Taylor, 632
- Edinburgh: Mathematical Society, 71, 187; Mineralogical Society, 330; Royal Society, 120, 162, 235, 403; Royal Physical Society, 23, 71; Geology at Edinburgh University, 107
- Edkins (Dr. Joseph), Early Culture in China, 276; Stone Hatchets in China, 515
- Education: What is a Liberal? Prof. S. Newcomb, 9; Inspector of Geographical Education for the Royal Geographical Society, 20; Digest of American Law Decisions on Details of Education, 108; the Peabody Institute and Education in America, 299; Education in the United States, 396; Recommendations of the Royal Commission on Technical Education, 113; International Conference on, 251, 363; Conference on, in Connection with Education Division of International Health Exhibition, 152, 198, 218, 244, 343; Education in Germany and England, by Oscar Browning, 517; Science in Schools, 517; Educational Statistics of Japan, 276, 490; in British Burmah, 545; Science and Art Education, 349
- Edward (Thomas), Carnivorous Wasps, 408
- Elasticity, Moduli of, Herbert Tomlinson, 234
- Electric Lift on French Northern Railway Company, 300
- Electric Lighting: Principles and Practice of, Alan Campbell Swinton, 144; Practical Treatise on Electric Lighting, J. E. H. Gordon, 333; Electric Light in Roman Catholic Church in Ayrshire, 394, 430; Electric Light for Lighthouses, J. Munro, 406; Oil and Electricity as Illuminants for, 518
- Electric Resistance, Modifications of Wheatstone's Bridge applied to Measurement of, Dr. Frölich, 24
- Electric Resistance of Bismuth, 569
- Electrical Conference at Philadelphia, 566
- Electrical Congress, Paris, 1884, 26
- Electrical Exhibition at Rouen, 181, 252; at Turin, 130; at Philadelphia, 152, 543; Commission in Philadelphia, 431, 475, 494; Proposed Exhibition at Boston, 518
- Electrical Induction in Metallic Conductors, F. N. Gisborne, 227
- Electrical Rainbow, R. S. Newall, F.R.S., 464
- Electrical Resistance of the Human Body, Dr. W. H. Stone, Prof. Dolbear, 56; Dr. W. H. Stone, 269
- Electrical Rules and Tables, Munro and Jamie-on's Pocket-Book of, A. Gray, 262, 290
- Electricity: On the Relation between the Electrical Qualities and Chemical Composition of Glass, T. and A. Gray and J. J. Dobbie, 70; the Relation between the B.A. Unit and the Legal Ohm of the Paris Congress, R. T. Glazebrook, 311; Electricity and Health, W. H. Stone, 253
- Electro-Dynamometer with extremely Light Suspended Coil, Dr. W. H. Stone, 635
- Electrolysing Glass, 568
- Electromotive Forces in the Voltaic Cell, on the Seat of, 594
- Elgar (Prof.), Training in Naval Architecture, 483
- Elliott (R. H.), on the Preservation of Wild Birds in India, 276
- Encke's Comet, Approaching Appearance of, 594
- "Encyclopædia Britannica," 405
- Encyclopædia of Natural Science, Trewend's, 21
- Engineering, Modern Steam Practice and, John G. Winton and W. J. Millar, 509
- England, Chemical Research in, Dr. Perkin, 246
- "English Flower Garden," W. Robinson, 534
- Equatorial Count of Paris Observatory, Reply to Grubb on, M. Loewy, 4, 53; Howard Grubb, F.R.S., 100, 123
- Ericsson (Capt. J.), Temperature of the Solar Surface, 465
- Eruption, the Krakatoa, R. D. M. Verbeek, 10; Prof. C. Piazz-Smyth, 511
- Essex Earthquake, 344, 372
- Essex Field Club, 343, 374, 518, 615
- Ethics, Physiology of, 180
- Ethnographical Collections, 547
- Ethnology: Native American Literature and, A. H. Keane, 341; and Geography, 569; of Philippine Races, 643; of Mindanao, 643
- "Euclid," J. S. Mackay's, 311
- "Euclid, the First Six Books of the Elements of," John Casey, F.R.S., 606
- Europe, Forests of Northern, 397
- Eurydice, H.M.S., on the Origin and Course of the Squall that Capsized, Hon. R. Abercromby, 22
- Evans (Capt. Sir Fred. J. O.), Delegate to International Prime Meridian Conference, 129
- Evans (Edwin II.), a Cannibal Snake, 216
- Ewart (Prof. Cossar), Mission in Connection with Fishery Board, 567
- Ewing (Prof. J. A.), Measuring Earthquakes, 149, 174
- Exhibitions: General Italian, 130; of India and the Colonies, 343; of Inventions, International, 373
- Family Faculties, Prize Records of, F. Galton, 82
- Fauvel (M. A.), on Liquidambar, the Wood used in Chinese Tea Chests, 299
- Fellow-Feeling in House-Flies and Swallows, 490
- Ferraris, Prof., Director of International Department of Electrical Exhibition in Italy, 130
- Field and Garden Crops, Diseases of, Geo. Murray, 605
- Figure of Uranus, 519
- Finnmark, Geology of, 201
- Fire, Risk of, 346
- Fireball: Annie E. Cocking, 269, 289; in Norway, 300; W. J. Millar on, 312; W. M. Flinders Petrie, 360; W. G. Smith, 408; W. White, 464
- Firth College, Sheffield, 153
- First Meridian Congress at Washington, 517
- Fish (C. F.), Handbook of Natural History, 547
- Fish in Hué River, Catalogue of, Tirant, 21
- Fish, the Weaver, Geo. Brook, 71
- Fisher (Rev. O.), the Earthquake of April 22, 1884, 19, 125
- Fishery Board, Prof. Ewart's Expedition to the United States, 567
- Fishery Board for Scotland, 129, 387; Deputation to the Home Secretary for Further Funds, 198
- Fison (Rev. Lorimer), the Deme and the Horde, 235
- Fitzinger (Dr. Leopold), Death of, 567
- Fixed Stars, David Gill, F.R.S., 135, 156
- Flat-Fish, Artificial Culture of, Prof. McIntosh's Inquiries into the, 82
- Flora, Algal, of the Arctic Seas, Veit Brecher Wittrock, 638
- Flora of British Fungi, Rev. John Stevenson, 181
- Flora, Cretaceous, of North America, Sir J. W. Dawson, 631
- Flora of the Philippines, R. A. Rolfe, 71
- Flora (Swedish), Enrichment by Railways of, 83
- Flow of Streams, George Higgin, 560

- Flower Garden, English, W. Robinson, 534  
 Flowers and their Pedigrees, Grant Allen, 167  
 Fly Killers, Wasps as, Geo. Lawson, 539  
 Fonvielle (W. De), on Directing Balloons, 641  
 Food, the Science of, 51  
 Foot (Capt.), Exploration of Nyassa Region, 546  
 Forestry: John R. Jackson, 194; John Croumbie Brown, 309;  
 Forestry Exhibition, 222, 243, 337; Forests of Northern  
 Europe, 397; Forests in Coburg, Germany, and Russia, 515;  
 Forests and Forestry of Northern Russia and Lands beyond,  
 J. Croumbie Brown, 535  
 Forked Lightning, Rev. Dr. C. Michie Smith, 463  
 Formaldehyde, Sugar-like Substance obtained by Action of  
 Alkalies on, Tollens, 84  
 Forster (Westgarth), "Strata of the North of England," 3  
 Fossil Mollusca of North America, C. A. White, Dr. J. G.  
 Jeffreys, F.R.S., 99  
 Fossil Reptiles, a History of British, Announced Publication by  
 Sir Richard Owen, K.C.B., 517  
 Fotheringham (John), a Cannibal Snake, 269  
 Foussereau (M.), Specific Resistance of Distilled Water, 568  
 Franklin Institute, 545, 579  
 French Association for Advancement of Science, 343, 483, 517  
 Freshwater Faunæ, on the Origin of, Prof. W. J. Sollas, 163  
 Fries (Prof. Ellis), on *Tricholoma colossus*, 547  
 Frogs, Intelligence in, 385, 465  
 Frölich (Dr.), Modifications of Wheatstone's Bridge Applied to  
 Measurement of Electric Resistance of Galvanic Elements, 24  
 "Fuel and Water," Schwackhöfer's, Prof. Fleeming Jenkin,  
 F.R.S., 311  
 Fungi and Bacteria, A. De Bary, 433
- Galton (F., F.R.S.), Prize Record of Family Faculties, 82; on  
 the "Measurement of Human Faculty," 129; "Identscope,"  
 637  
 Garbe (M.), on Lipmann's Capillary Electrometer, 568  
 Gardner (J. Starkie), Chalk and the Origin and Distribution of  
 Deep-Sea Deposits, 192, 264  
 Gas: Application of, to Heating and Cooking, 641  
 Gas-Burners, Old and New, Owen Merriman, 270, 335  
 Gas-Escapes, Means of Searching for, 615  
 Gasteropoda in Kendal Museum, 154  
 Gay (M.), the Rains and the Recent Volcanic Eruptions, 229  
 Geerts (Dr. A. J. C.), Death and Obituary Notice of, 20  
 Gegenbauer (Dr. Leopold), Elected Corresponding Member of  
 Vienna Academy of Sciences, 129  
 Geikie (Arch., F.R.S.), Origin of the Crystalline Schists, Dr.  
 Johannes Lehmann, 121  
 Generations, Alternation of, 67  
 Generations in Salpa, Alternation of, R. N. Goodman, 463  
 Geodetic Association, International, 371  
 Geodetical Operations, Norwegian, 105  
 Geography: Inspector of Geographical Education Appointed  
 by the Royal Geographical Society, 20; the Orient Line  
 Guide, 102; Geographical Notes, 109, 131, 478, 569, 643;  
 the Russian Geographical Society, 109; Geographical Society  
 in Edinburgh, 570; Teaching of Geography in Schools, 130;  
 in Russian and German Universities, 457; Geographical  
 Publications by Edward Stanford, 593  
 Geology: "Strata of the North of England," Westgarth  
 Forster, 3; the Silver Districts of Colorado, Henry Gunn,  
 71; Geology of the Malayan Peninsula, Rev. J. E. Tenison-  
 Woods, 76; Geological Survey of Alabama, E. A. Smith,  
 77; Geological Survey of Belgium, 201; Geological Survey  
 of New Zealand, 202; Geology in Russia, 94; Geology of  
 the Country Traversed by the Canada Pacific Railway, Princi-  
 pal Dawson, F.R.S., 95; Geological Society, 95, 139, 211,  
 235, 306; German Geological Society, 592; Geological  
 Notes, 154, 201; Geology of Finmark, 201; Geology at the  
 British Association, 217; the Origin of Crystalline Rocks, T.  
 Sterry Hunt, F.R.S., 227; Geological Position of the Weka-  
 Pass Stone, Capt. F. W. Hutton, 306; Thoroddsen's Geo-  
 logical Explorations, 317; International Geological Congress,  
 Prof. John McKenny Hughes, F.R.S., 359; the New Geo-  
 logical Map of Russia, 608; Geology and Mineralogy of  
 Northern Canada, Dr. Robert Bell, 228; Geology and Mine-  
 ralogy of Madagascar, Dr. G. W. Parker, 307
- Geometers, Two Greek, 315  
 Geometry, Solid, Elementary Treatise on, Chas. Smith, 143  
 Geometry, Some Propositions in, John Harris, 334  
 Georgia and Mingrelia, described in M.S. of Castelli (1597-1659),  
 569  
 Germ, Cholera, Henry B. Baker, 407  
 German Naturalists and Physicians, Association of, 625  
 Germany, Coburg, and Russia, Forests in, 515  
 Gibney (Major Robert D.), Light-Phenomenon, 194; After-  
 Glow, 634  
 Gibson R. J. Harvey), Animal Intelligence, 538  
 Gill (David, F.R.S.), Fixed Stars, 135, 156  
 Gisborne (F. N.), Electrical Induction in Metallic Conductors,  
 227  
 Glacial Age, Northern Norway under the, Karl Pettersen, 202  
 Glacial Boundary in Ohio, 155  
 Glaciation, Boulder, Hugh Miller, 23  
 Glaciers in the Main Strait of Magellan, Notes on a few of the,  
 Capt. J. L. Wharton, 177  
 Glaciers of Terek, in Caucasus, 395  
 Glaciers, Measurement of, in Sweden, 494  
 Gladstone (Dr. J. H., F.R.S.), School Museums, 384  
 Glasenap (Dr.), Russian Private Observatories, 252  
 Glasgow: the Mitchell Library at, 82; Philosophical Society of,  
 327  
 Glass, on the Relation between the Electrical Qualities and  
 Chemical Composition of, Thos. and Andrew Gray and J. J.  
 Dobbie, 70  
 Glazebrook (R. T.), the Relation between the B.A. Unit and  
 the Legal Ohm of the Paris Congress, 311; Prof. Tait on  
 Light, 261  
 Gledhill (J.), Sky-Glows, 489  
 Glow, Red, S. E. Bishop, 194; Prof. W. N. Hartley, 384;  
 A. S. Atkinson, 463; Robert Leslie, 463, 583; J. J.  
 Murphy, 583  
 Godwin-Austen (Col. H. II., F.R.S.), Earthquake, 145;  
 Ocean Swells, 487  
 Gonnermann (Dr. Wilhelm), Death of, 615  
 Goodman (R. N.), Alternation of Generations in Salpa, 463  
 Goodwin (W. L.), Circular Rainbow seen from a Hill-top, 465  
 Gordon (J. E. H.), Practical Treatise on Electric Lighting, 333  
 Gordon (Lieut. W. R.), Scientific Expedition to Hudson's Bay,  
 641  
 Gorilla, the Young, of the Jardin des Plantes, 128  
 Graham (R. H.), Graphic and Analytic Statics in Theory and  
 Comparison, 383  
 Graphic and Analytic Statics in Theory and Comparison,  
 R. H. Graham, 383  
 Graves (James), Rainbow after Sunset, 635  
 Gray (A.), Munro and Jamieson's Pocket-Book of Electrical  
 Rules and Tables, 262, 290  
 Gray (T. and A.), and J. J. Dobbie, on the Relation between the  
 Electrical Qualities and Chemical Composition of Glass, 70  
 "Great B," M. Thollon's Views of in the Solar Spectrum, Prof.  
 C. Piazzzi-Smyth, 535  
 Great Basin, Extinct Lakes of the, 197  
 Greeff (Prof.), the Island of St. Thomas, 109  
 Greek Geometers, Two, 315  
 Greely Relief Expedition, 64, 290, 395  
 Green Sun, Observations on a, and Associated Phenomena,  
 Prof. C. Michie Smith, 347  
 Greenland: Map by Prof. Nordenskjöld, 64; Scientific Explora-  
 tion of, 153; Lieut. Holm and the Greenlanders, 109  
 Griffen (H. II.), Tricycles of the Year 1884, 192  
 Grinnell Land, 438  
 "Grotto, Blue," on a Dalmatian Island, 200  
 Grub, Ravages of Coffee Plantations, Report by Mr. McLachlan  
 on, 546  
 Grubb (Howard, F.R.S.), Equatorial *Coudé* of the Paris Obser-  
 vatory, 100, 123  
 Crye (M. Bouquet de la), Inventor of a Multiplying Seismo-  
 graph, 569  
 Guldberg (Prof. G. A.), North Cape Whale, 148  
 Gulf Stream, Temperature of, 545  
 Gulland (G. Lovell), Lepidoptera, 560  
 Günther (Dr. Albert, F.R.S.), and G. Chierchia, Voyage of the  
*Vettor Pisani*, 365  
 Guthrie (Prof.), Action of Water on Triethylamine, 119  
 Gutta-producing Trees, 346

- Haas (Hyppolyt), "Beiträge zur Kenntniss der Liasischen Brachiopodenfauna von Südtirol und Venetien," J. Gwyn Jeffreys, 192
- Haast (Prof. von), Snow and Ice Flora, 55
- Hail, 513
- Hailstones, Resilience from the Earth of, 519
- Hainan, Henry's Journey Through, 41
- Hale (A.), Pipe-Clay, 489
- Hallett (Holt), Siamese Expedition, 324
- Halo: Solar, W. W. Taylor, 241; (Dust?), Prof. E. Douglas Archibald, 559; Iridescent Lunar Halos, T. H. Potts, 464
- Hampshire, Geological Survey of, 130, 494
- Hands (T.), Numerical Exercises in Chemistry, 239
- Hansen (Dr.) on Chlorophyll, C. A. MacMunn, 224
- Harcourt (Sir William), on Science, 591
- Harris (John), some Propositions in Geometry, 334
- Harrison (Thos.), Singular Instance of Instinct, 436; Animal Intelligence, 538
- Hartley (Prof. W. N.), Red Glows, 384
- Hartz, Upper Germany, the Metallic Veins of, Paper read before the Mineralogical Society, 181
- Hatchets, Stone, in China, Rev. Dr. Joseph Edkins, 515
- Hatton (Frank) Annual Prize, 641
- Haycraft (John B.), a Model Lens for Use in Class Demonstrations, 543
- Hazen (Prof. H. A.), the Dry and Wet Bulb Thermometers "Froude," 6
- Health, Electricity and, W. H. Stone, 253
- Health Exhibition, the, 39, 274, 394, 439, 567, 641
- Health Exhibition, International, Conference on Education, 152
- Health Exhibition, Primary Education at the, 218, 244
- Health Journal, the, 41
- Health, National Work and, 183
- Healthy Schools, 388
- Heat, Measuring, Prof. J. Joly, 361
- Heat, a New Principle of Measuring, Otto Pettersson, 320
- "Heat," Prof. P. G. Tait, Prof. Balfour Stewart, F.R.S., 191
- Heat, Specific, the Law of, L. E. Phillips, 288
- Heath (D. D.), Repulsion, 490
- Heliometer, the Cape, 459
- Heliostat, the Local, G. J. Stoney, F.R.S., 72
- Heluan, Sulphur Baths of, near Cairo, 518
- Hemileia vastatrix* in Natal, 252
- Henry (MM.), Photography for Double-Stars, 21
- Henry's Journey through Hainan, 41
- Henslow (Rev. Geo.), Simple Methods of Measuring the Transpiration of Plants, 146; Permanency of Continents, 407; Carnivorous Wasps, 407; Biology *v.* Botany, 537
- Herculis 99, Double-Star, 375
- Herdman (Prof. W. A.), the Pentacrinoid Stage of *Antedon rosaceus*, 634
- Hermite (Charles), Elected Foreign Honorary Member of Vienna Academy of Sciences, 129
- Heron (Mark), Cultivation of Salmon Rivers, 146
- Herrick (Sophie B.), Wonders of Plant-Life, 168
- Herring-Eggs in Course of Development, 129
- Herschel (Col. J.), Animal Intelligence, 125; the Yard, the Metre, and the Old French Foot, 312
- Herschel (Prof. A. S.), the Sky-Glows, 536
- Hick (Thomas), Protoplasmic Continuity in Plants, 216
- Higgin (George), the Flow of Streams, 560
- Hill-top, Circular Rainbow seen from a, W. L. Goodwin, 465
- Hill-tops, Pile-Dwellings on, S. E. Peal, 168
- Himalayas, Double-Storied Houses and Concave Roofs in the, B. D. Oldham, 30
- Histological Notes for the Use of Medical Students, W. Horscraft Waters, 168
- Hoang-ho, Sources of the, 570
- Hobkirk (C. P.), Synopsis of the British Mosses, J. G. Baker, 582
- Hochstetter (Dr. Ferd. von), Reports from *Novara* Expedition, 547
- Hoffmann (Dr.) and Dr. Egon Ihne, "Beiträge zur Phänologie," 588
- Hoffmann and Power, Chemical Analysis as applied to the Examination of Pharmaceutical Chemicals, 51
- Holm (Lieut.) and the Greenlanders, 109
- Holothurian, Rare British, Dr. F. Jeffrey Bell, 146
- Hooker (Sir J. D., F.R.S.), Letter from, on Opening of Kew Gardens and Museums on Sundays, 180; Tropical African Mountain Flora, 635
- Hopkins (B. J.), Sky-Glow, 268
- Horde, the Deme and the, Howitt and Fison, 235
- Horse, Przevalsky's Wild, 391; W. W. Watts, 436
- Horticultural Exhibition, St. Petersburg, 64, 179
- Hoskyns-Abrahall (Rev. John), a Remarkably Brilliant Meteor, 102; Meteor, 385
- "Hotel des Neuchâtelais," Discovery of Relics of, 477
- House-Flies and Swallows, Fellow-Feeling in, 490
- Howitt (A. W.), the Deme and the Horde, 235
- Huber (M. Charles), Murder of, in Arabia, 547
- Hué River, Catalogue of Fish in, Tirant, 21
- Hughes (M. C.), Palaeolithic Implements from Cambridge, 632
- Hughes (Prof. T. McK., F.R.S.), Notes on Earthworms, 57; International Geological Congress, 359
- Hull (Prof. E., F.R.S.), Remarkable Raised Sea-Bed near Lattakia, Syria, 384
- Hunt (Robert, F.R.S.), the *Mining Journal* and, 298; British Mining, 358
- Hunt (T. Sterry, F.R.S.), the Origin of Crystalline Rocks, 227
- Hutton (Capt. F. W.), on the Geological Position of the Weka Pass, 306
- Huxley (Prof., F.R.S.), Science in Schools, 63; on Parasites in Mackerel, 199; his Continental Tour, 591
- Hydrate of Sulphuric Acid, Specific Gravity of, 374
- Hydration of Cobalt Chloride, Potilitzin on, 84
- Hydrodicyon in the Eastern Counties, Rev. J. C. Saunders, 488
- Hydrophobia, Pasteur's Experiments on, 252, 371
- Hydroxylamine and the Assimilation of Nitrogen by Plants, 548
- Hygiene, International Congress of, at the Hague, 394, 429, 457
- Hypersthene-Andesite and Triclinic Pyroxene in Augitic Rocks, 155
- Ice, Atlantic, and Mild Winters, Dr. John Rae, F.R.S., 76
- Iceland, Auroral Researches in, Dr. Sophus Tromholt, 80; Explorations in, Th. Thoroddsen, 563, 584
- "Identscope," Francis Galton, F.R.S., 637
- Ihne (Dr. Egon) and Dr. Hoffmann, "Beiträge zur Phänologie," 588
- Ike-Aral, in Transbaikalia, 430
- Illuminants, Lighthouse, Trinity House Experiments on, 362
- Immortality, Chinese Notions of, 642
- India: Connection of the Himalaya Snowfall with Dry Wind and Drought in, H. F. Blanford, F.R.S., 46; Representation of, at International Prime Meridian Conference, 129; on the Preservation of Indian Wild Birds, R. H. Elliott, 276; Theory of the Winter Rains of Northern, H. F. Blanford, F.R.S., 304; Cholera: Inquiry Commission, 323; Rivett-Carnac's Indian Stone Implements, 324, 593; Indians of the Upper Amazon Regions, 344; Catalogue and Handbook of the Archæological Collections in the Indian Museum, John Anderson, 511; Natural History of the Mammalia of India and Ceylon, R. A. Sterndale, 98
- India-rubber, a New Application of, 544
- Industrial and Cotton Exhibition in America, 180
- Insect Allies, our, Theo. Wood, 582
- Insect Pests in the United States, 241; in Ceylon, 615; W. I. Distant, 634
- Insects, Injurious, E. A. Ormerod, 142
- Insects in New Zealand, 478
- Instinct, Singular Instance of, Thos. Harrison, 436; in Birds, 102; W. Brown, 56
- Institution of Civil Engineers, 71, 187
- Institution of Mechanical Engineers, 41, 343
- Instruction, Technical, Report on, 357, 381
- Instruments, New Form of Spring for Electric and other Measuring, Profs. W. E. Ayrtton, F.R.S., and John Perry, 205
- Integral Calculus, Elementary Treatise on, B. Williamson, F.R.S., 143
- Intelligence in Animals, 170; Duncan Stewart, Dr. John Rae, F.R.S., 6; E. A. Lonergan, 77; R. J. Harwey Gibson, 538; Thomas Harrison, 538; Dr. Hyde Clarke 561; in Frogs, 465
- International Conference on Education, 363

- International Weights and Measures, 612  
 Inventions, International Exhibition of, 373  
 Iridescent Lunar Halos, T. H. Potts, 464  
 Iron and Steel Institute, 42; Meeting at Chester, 476, 517  
 Irving (Rev. A.), Cole's Pit, 560  
 Ischia, Earthquake at, 324, 614  
 Italian Geographical Congress, the, 323  
 Italy, Earthquakes in, 64
- Jackson (John R.), Forestry, 194  
 Jacob (Ernst), "The Ores of Leadville," 437  
 Jacobsen (Capt. Adrian), Collecting Ethnographical Objects in Asia, 547  
 Jacobsthal (Prof.), on the Evolution of Ornament, 248, 272  
 Jagnaux (Raoul), "Traité Pratique d'Analyses Chimiques et d'Essais Industriels," 311  
 James (Thos.) and Leo Lesquereux, Manual of the Mosses of North America, J. G. Baker, F.R.S., 461  
 Jamieson and Munro's Pocket-Book of Electrical Rules and Tables, A. Gray, 262, 290  
 Jamin (M.), Elected Perpetual Secretary in the Section of Physical Sciences in Paris Academy, 179  
 Japan: Educational Statistics of, 276, 490, Department in Health Exhibition, 567, 592, 641; Meteorological System of Japan, 299, 478, 642; Medical Progress in, 345; Introduction of Vaccination into, &c., 345; Earthquake in, F. Warrington Eastlake, 435; Japanese Divination, 495; Japanese Nomenclature of Plants, 495; Pharmaceutical Factory, 519; Léon de Rosny on the Japanese, 570  
 Jardin des Plantes, the Young Gorilla of the, 128  
 Jeffreys (Dr. J. Gwyn, F.R.S.): White's Fossil Mollusca of North America, 99; Beiträge zur Kenntniss der Liasischen Brachiopodenfauna von Südtirol und Venetien, Haas Hypolyt, 192; Chalk and the Origin of Deep-Sea Deposits, 215  
 Jelly-fish, Phosphorescence of the, R. Meldola, 289  
 Jenkin (Prof. Fleeming), Schwachhöfer's "Fuel and Water," 311  
 Johns Hopkins University, 640  
 Johnston-Lavis (Dr. H. J.), Volcanoes on the Shore of Lake Nyassa, 62; Earthquakes, 608  
 Joly (Prof. J.): Note on Microscopical Examination of the Volcanic Ash from Krakatoa, 23; Measuring Heat, 361  
 Jouffroy Statue, 394; Jouffroy Claimed to be the Inventor of Steam Navigation, 394  
 Joule's (Dr.) Scientific Papers, 27  
 Journal of Anatomy and Physiology, 330  
 Journal of Botany, 209  
 Journal of the Chemical and Physical Society, 378  
 Journal of the Franklin Institute, 160, 508, 579, 627  
 Journal of Physiology, 330  
 Journal de Physique, 209  
 Journal de Physique théorique et appliquée, 556, 580  
 Journal of the Russian Chemical and Physical Society, 94, 118, 209, 555  
 Journal of the Straits Branch of the Royal Asiatic Society, 20  
 Jupiter, W. F. Denning, 125  
 Jupiter's First Satellite, Dark Transit of, W. F. Denning, 77  
 Jurassic Dinosaurs, American, 201
- Kadiak Island, Advices from, 275  
 Kamchatka, Peninsula of, its Geography and History, 569  
 Kannonikow's Experiments in Measuring the Refraction-Equivalents of Metals, 84  
 Kansas, G. Phillips Bevan, 295  
 Kara Sea, 345; Trade between Europe and Siberia through the, 132  
 Kasai, Exploration of, 546  
 Keane (A. H.), Native American Literature and Ethnology, 341  
 Kendal Museum, 154  
 Kephir, 216  
 Kepler's Nova of 1604, 431  
 Kerosene Emulsion, New Remedy against Phylloxera, 429  
 Kerry Nicholls (J.), "King Country; or, Explorations in New Zealand," 535  
 Kew Gardens, 316; Opening on Sundays, 180
- Kew, Royal Herbarium, 591  
 Kief, University of, 567  
 Kigoro Otano, Interpreter of the Korean Language into Chinese, 132  
 Killimanjaro, Mount, Letter of H. H. Johnstone from, 457  
 Kinahan (Gerrard A.), Notes on the Canadian North-West, 340  
 Kinahan (J. Henry), Earthquake, 125  
 "King Country; or, Explorations in New Zealand," J. Kerry Nicholls, 535  
 Kirk (T. W.), Animal Intelligence, 240  
 Kishm, Earthquake at, 130  
 Koch (Dr.), Award to, 63  
 Kohlrausch's Meter-Bridge, Dr. W. H. Stone, 145  
 Kola Peninsula, Proposed Explorations of, 324  
 König (Dr.), Complementary Colours, 308  
 Krakatoa Eruption, the, 279; R. D. M. Verbeek, 10, 335; Prof. C. Piazzzi-Smyth, 511; Atmospheric Effects produced by Volcanic Dust from, W. F. Stanley, 22; Notes on Microscopical Examination of the Volcanic Ash from, J. Joly, 23; Krakatoa and the Sun-Glows, 155; Dr. S. M. Rendall on, 287; Barometrical Indications in Rome of Aerial Disturbances Caused by, 324; Report of French Mission sent thither, 372; Krakatoa Smoke at Strong's Island, September Stream of, S. E. Bishop, 537  
 Krashennnikoff, Exploring Expeditions in the Last Century of, 153  
 Kyanite and Staurolite Localities in the North, Paper Read before Mineralogical Society, 181
- La Belgique Horticole, 233  
 La Nuova Scienza, 252  
 Laboratory at Paris, Municipal, 199  
 Lake Tanganyika, Rhyolitic Rock from, Prof. T. G. Bonney, F.R.S., 193  
 Lakes, Extinct, of the Great Basin, 197  
 Lankester (Prof. E. R., F.R.S.), the Marine Biological Association and a Coast Survey, 76, 123  
 Lapps, 52; Skeletons of, 518  
 Larden (W.), Sky-Glows, 489  
 Larva, Worm-Eating, W. E. Darwin, 146  
 Lattakia, Syria, Remarkable Raised Sea-Bed near, Prof. E. Hull, F.R.S., Rev. Dr. G. E. Post, 384  
 Lawes (Sir J. B.), Experimental Farm at Rothamstead, 642  
 Lawrence Smith Medal, Award to Scientific Merit in U.S., 373  
 Lawson (George), Wasps as Fly-Killers, 539  
 Layard (E. L.), Circular Rainbow seen from Hill-top, 361; Meteors, 538  
 Leadville, Ores of, Ernest Jacob, 437  
 Leaping and Running, Greek and English Records, 324  
 Least Squares, Text-Book on the Method of, Mansfield Merriman, 334  
 LeConte (Prof. Joseph), Right-sidedness, 76  
 Lehmann (Dr. Johannes), Origin of the Crystalline Schists, Arch. Geikie, F.R.S., 121  
 Lena, Survey of Two Branches of, 130  
 Lena Delta, Ravages of Small-Pox at, 567  
 Lens, a Model, for Use in Class Demonstrations, John B. Haycraft, 543  
 Lenses, Charles Pendlebury, 310  
 Lepidoptera, G. Lovell Gulland, 560  
 Lepidopterous Pigments, Action of Ammonia upon some, Geo. Coverdale, 571  
 Lepsius (Prof.), Death of, 274  
 Leslie (Robert), Sky-Glows, 463, 512, 583  
 Lesquereux (Leo) and Thos. James, Manual of the Mosses of North America, J. G. Baker, F.R.S., 461  
 Leuckart (Prof. L.), elected Foreign Corresponding Member of Vienna Academy of Sciences, 129  
 Lewis (Timothy Richards), "Comma-Shaped Bacillus" alleged to be the Cause of Cholera, 513  
 Ley (Rev. W. Clement), Carnivorous Wasps, 407  
 Leyden Museum, Notes from the, 389  
 Lias (Brau de Saint-Pol), 615, 643  
 Library Catalogues, W. Odell, jun., 636  
 Library, the Mitchell, at Glasgow, 82  
 Licherdopol (Prof.), Chimie Elementara, 239  
 Lick Observatory, 613



- Life-Histories and Origin of the Least and Lowest Living Things, Researches on, Rev. W. Dallinger, F.R.S., 619, 645
- Light at Great Depths of Sea, A. E. Verrill, 280
- Light, by Prof. Tait, R. T. Glazebrook, 261
- Light Phenomenon, Major R. D. Gibney, 194
- Light, Wave-Theory of, 545
- Lighthouse Illuminants, Trinity House Experiments on, 362
- Lighthouses, Electric Light for, J. Munro, 406
- Lighting, Artificial, R. F. B. Crompton, 281
- Lightning, Forked, Rev. Dr. C. Michie Smith, 463
- Lightning, Worthington G. Smith, 241
- Lignites, Canadian Coals and, 154
- Linnean Society, 70, 186
- Linnean Society of New South Wales, 95, 259, 307
- Linschoten, Corruption of Schichi-to, 643
- Lipmann's Capillary Electrometer, 568
- Liquidambar, the Wood used in Chinese Tea-Chests, Fauvel, 299
- Liquids, Capillary Constants of, at their Boiling-Points, 618
- Living Things, Researches on the Origin and Life-Histories of the Least and Lowest, Rev. W. Dallinger, F.R.S., 619, 645
- Lockyer (J. Norman, F.R.S.), Movements of the Earth, 110, 254, 480
- Locomotives, Consumption of Fuel in, M. Georges Marié, 41
- Lodge (Prof. O. J.), Dust-Free Spaces, 54; Experiment in Thought-Transference, 145
- Lœwy's New Telescope-System, A. Ainslie Common, 434; Reply to Grubb on Equatorial *Coudé* of Paris Observatory, 4, 53
- London Institute, City and Guilds of, 377
- London Water-Supply, G. Phillips Bevan, 165
- Loneragan (E. A.), Animal Intelligence, 77
- Longridge (J. A.), Wire in the Construction of Ordnance, 285
- Loochoo Islands, their Geography, Müller-Beeck, 643
- Lowe (E. J., F.R.S.), the Recent Eclipse of the Moon, 589
- Lower Congo, Meteorology of the, 589
- Lubbock (Sir J., F.R.S.), British Mites, A. D. Michael, 141
- Luminous Phenomena at Morges, in Valley of Saas-Fée, at Sand-Alp, and at Madrid, 394
- Lunar Eclipses: on October 4, 519, 548; Recent, H. Dennis Taylor, 632
- Lunar Halos, Iridescent, T. H. Potts, 464
- Lupton's Numerical Tables, 222
- Luzon, History of, 643
- Lynn (W. T.), "Celestial Motion," Handy Book of Astronomy, 606
- McAdie (Alexander), Atmospheric Dust, 194
- MacCormac (Dr. H.), Animal Intelligence, 240
- McCormick (R.), Voyages of Discovery in Arctic and Antarctic Seas, 239
- MacGregor (Prof. J. G.), on the Density and Thermal Expansion of Aqueous Solutions of Copper Sulphate, 227
- McIntosh's (Prof.), Inquiries into the Artificial Culture of Flat-Fish, 82
- McLachlan (R., F.R.S.), Earthquake, 170; Trichoptera of the European Fauna, 434
- MacMunn (C. A.), Dr. Hansen on Chlorophyll, 224
- Machinery, Dynamo-Electric, Prof. Silvanus P. Thompson, 630
- Mackay (J. S.), "Euclid," 311; Simson's Line, 635
- Mackerel, Prof. Huxley on Parasites in, 199
- Madagascar, Geology and Mineralogy of, Dr. G. W. Parker, 307
- Magellan, Notes on a Few of the Glaciers in the Main Strait of, Capt. J. L. Wharton, 177
- Magnetic Heat, Bachmeticff, 223
- Magnetic Observatory at Rome, Proposed, 199
- Magnetic Rotatory Polarisation of Chemical Compounds, Perkin's Researches on, 616
- Magnetic Shells, Experiments on, M. Duter, 568
- Main (Dr. J. F.), "Applied Mechanics," James H. Cotterill, F.R.S., 382
- Malacca, Natural History Collections of, 615
- Malayan Geology, Rev. J. E. Tenison-Woods, 76
- Malayan Ornithology, 346
- Malayan Peninsula, the Mountain System of the, Rev. J. E. Tenison-Woods, 264
- Maldives, Ibn Batuta's Travels to the, 132
- Malmgren (Prof. And. Joh.), Migrations of *Salmo sa'ar*, L., in the Baltic, 521
- Malta and Sicily, Remarkable Sunsets in, 20
- Mammalia of India and Ceylon, the, R. A. Sterndale, 98
- Mammals, Brazilian, Natterer's, 74
- Manby (Charles, F.R.S.), Obituary Notice, 343
- Manchester Literary and Philosophical Society, 72
- Manufactures, Science and, 1
- Marié (M. Georges), Consumption of Fuel in Locomotives, 41
- Marine Biological Association of United Kingdom, 40, 82, 275, 323, 350; Prof. E. Ray Lankester, F.R.S., 76, 123
- Marine Station, Scottish, 566
- Marine Zoological Survey, a Plea for a National, 25
- Mars, the Rotation Period of, W. F. Denning, 55
- Marshall (W. P.), Circular Rainbow, 584
- Martin (H. Newell) and W. A. Moale, Handbook of Vertebrate Dissection, 143
- Massowah, Earthquake at, 324
- Mathematical Society, 71, 186, 355, 640
- Maw (Geo.), the Flow of Streams, 486
- Measuring Earthquakes, Prof. J. A. Ewing, 149, 174
- Measuring Heat, Prof. J. Joly, 361
- Mechanical Engineers, Meeting of, 614
- "Mechanics, Applied," James H. Cotterill, F.R.S., Dr. J. F. Main, 382
- Mechanics, Teaching of, 567
- Medical Congress, International, at Copenhagen, 372, 394
- Medicine in Japan, 345; in British Burmah, 545
- Meldola (R.), the Earthquake, 145; Phosphorescence of the Jelly-fish, 289
- Memoirs, Scientific, Diffusion of, Prof. John Milne, 267
- Mendeléeff (Prof.), Increase of Densities of Solutions of Salts in Proportion to Increase of their Molecular Weight, 84; Researches into Specific Weights, 374
- Mercury in Chinese Alchemy, 299
- Merjelen Lake, Proposed Drainage of, 430
- Merriman (Mansfield), Text-Book on the Method of Least Squares, 336
- Merriman (Owen), "Gas-Burners," 270; Gas-Burners, Old and New, 335
- Merv and Russo-Persian Frontier, 430
- Messerschmidt, Exploring Expeditions of, 153
- Metals, Refraction-Equivalents of, Kannonikow's Experiments in Measuring the, 84
- Metals, on a Relation between the Co-efficient of the Thomson Effect and certain other Physical Properties of, Shelford Bidwell, 94
- Meteorology: the Low Barometer of January 26, 1884, 58; Meteorological Observatories in the China Seas, 108; Meteorological Observatory at Boma, 223; Meteorological Observatory at Falmouth, Laying Foundation-Stone of, 429; Meteorology of Ben Nevis, Alexander Buchan, 336; Meteorology in Victoria, 126; Meteorological System of Japan, 299; Scottish Meteorological Society, 326; the Meteorological Conference, 351; Meteorological Office, 545, 567; of Japan, 478; in Hong Kong, &c., 567; in Hudson's Bay, 641; in Japan, 642; of the Lower Congo, 589; Committee of Meteorology, Magnetism, &c., at St. Petersburg, 430; Polar Station of, 430
- Meteors: Rev. J. Hoskyns-Abrahall, 102, 385; at Stockholm, 300; E. L. Layard, 538; November, 615; in Norway, 200; Meteor-, Moon-, and Sun-shine, Prof. C. Piazz-Smyth, 462
- Meter-Bridge, Kohlrausch's, Dr. W. II. Stone, 145
- Metrical System, Extent to which it is used and to which it is optional, 153
- Metrics: the Yard, the Metre, and the Old French Foot, Lieut.-Col. Herschel, 312
- Meyer's Bird-Skeletons, 78
- Michael (A. D.), "The British Oribatidæ," Sir J. Lubbock, F.R.S., 141
- Michela, in Italy, Author of New Development of Telegraphy, 546
- Microbes, Dr. Klein and, 566
- Microscopical Examination of Volcanic Ash from Krakatoa, Notes on, J. Joly, 23
- Microseismology, 614
- Midday, Extraordinary Darkness at, Rev. S. J. Perry, F.R.S., 6
- Migration of Salmon, 361

- Migrations of *Salmo salar*, L., in the Baltic, Prof. And. Joh. Malmgren, 521
- Military Examinations, Science and, E. D. Archibald, 239
- Millar (W. J.), Fireballs, 312
- Millar (W. J.), John G. Winton, "Modern Steam Practice and Engineering," 509
- Milleporidæ, the, John L. Quelch, 539
- Miller (Hugh), Boulder Glaciation, 23
- Milne (Prof. John), Diffusion of Scientific Memoirs, 267 ; Earth Tremors, 614
- Mindanao, Geography and Ethnology of, 643
- Mineralogical Society, 181, 650
- Mineralogy, J. H. Collins, 143
- Mineralogy and Geology of Northern Canada, Dr. Robert Bell, 228
- Mineralogy and Geology of Madagascar, Dr. G. W. Parker, 307
- Mineralogy, Text-Book of Descriptive, Hilary Bauerman, 461
- Mingrelia and Georgia, Described in Italian Manuscript of Castelli (1597-1659), 569
- Minimum of Mira Ceti, the next, 374
- Mining, British, Robert Hunt, 358
- Mining in China, 430 ; in Tonquin and Annam, 477
- Mining Journal, and Mr. Robert Hunt, F.R.S., 298
- Minusinsk, Journeys in the North-East Part of, 132
- Mira Ceti, the Next Minimum of, 374
- Missing Nebulæ, 201
- Mitchell Library at Glasgow, the, 82
- Moale (W. A.) and H. Newell Martin, Handbook of Vertebrate Dissection, 143
- Mocenigo (A. G.), Theories of the Late Remarkable Crepuscular Lights, 82
- Moduli of Elasticity, Herbert Tomlinson, 234
- Moigno (Abbé), Death of, 275 ; Obituary Notice of, 291
- Mollusca, Fossil, of North America, by C. A. White and Dr. J. G. Jeffreys, F.R.S., 99
- Monster, a Sea, Alfred Morris, 513
- Montigny (Ch.), on State of Atmosphere as Affecting Stellar Scintillations, 222, 344
- Moon-, Meteor-, and Sun-shine, Prof. C. Piazzi-Smyth, 462
- Moon, the Recent Eclipse of the, Otto Boeddicker, 589 ; E. J. Lowe, 590 ; Geo. F. Burder, 590
- Morgan (C. L.), Facts around us, 51
- Morphological Speculations, Recent, 67, 225, 328
- Morphologisches Jahrbuch, 355
- Morris (Alfred), a Sea Monster, 513
- Morris (Chas.), the Red Sunsets, 312
- Mortillet (Gabriel de), Banquet to, 40
- Moscow, Cloud of Dragon-Flies at, 223
- Mooley (Prof. H. N., F.R.S.), a Carnivorous Plant Preying on Vertebrata, 81
- Mosquitoes in England, 372
- Mosses, British, Synopsis of the, C. P. Hobkirk, J. G. Baker, 582
- Mosses of North America, Manual of, Leo Lesquereux and Thos. James, J. G. Baker, F.R.S., 461
- Mott (F. T.), Museums, 360
- Mountain System of the Malayan Peninsula, the, Rev. J. E. Tenison-Woods, 264
- Movements of the Earth, J. Norman Lockyer, F.R.S., 110, 254, 480
- Mozambique and Lake Nyassa, Exploration of Country between, 546
- Müller, Exploring Expeditions in last Century of, 153
- Müller (Dr. F.), Butterflies as Botanists, 240 ; Christian Conrad Sprengel, 240
- Munk (Prof.), on the Extirpation of the Cerebrum in Rabbits, 308
- Munro (J.), Electric Light for Lighthouses, 406
- Munro and Jamieson's Pocket-Book of Electrical Rules and Tables, A. Gray, 262, 290
- Murphy (J. J.), Sky-Glows, 51
- Murray (Geo.), "Diseases of Field and Garden Crops," 605
- Murray (John), Deep-Sea Deposits, 84, 114 ; and Rev. A. Renard, on the Nomenclature, Origin, and Distribution of Deep-Sea Deposits, 132
- Museum of the Nineteenth Century, Proposed, 567
- Museums : Opening of, on Sundays, 180 ; Sir Joseph Hooker on the Opening of Kew Gardens on Sundays, 180 ; F. T. Mott, 360 ; School Museums, Dr. J. H. Gladstone, F.R.S., 384
- Natal, Coffee-Leaf Disease in, 252
- Natanson (Prof.), Obituary Notice of, 517
- National Association of Science and Art Teachers, First Annual Conference of, 180
- National Work and Health, 183
- Natterer's Brazilian Mammals, 74
- Natural History Collections, 615
- Natural History, New Library and Museum of, at Newcastle, 430, 475
- Natural History Museum, British Birds at the, 491
- Natural History Societies, Midland Union of, 153
- Natural Science, Establishment of a Chair of, in the Free Church Theological College of Glasgow, 130
- Natural Science in Tasmania, 562
- Natural Science, Teaching of, in Universities, 153 ; in Schools, 517
- Naturalists, Manchester Field, 153
- Naturalists and Physicians, German Association of, 517, 547
- Naturalists' Societies, East of Scotland Union of, 130, 153
- Naval Architecture, Training in, Prof. Elgar, 483
- Naval Constructors, the Royal Corps of, W. H. White, 33
- Nebulæ, Missing, 201
- Neesen (Prof. F.), on Sebert's Registration of Velocity of Shot, 344
- Negritos of the Philippines, Ethnology of, 643
- New Guinea Bibliography, Rye's, 275
- New South Wales, Rainfall of, 196
- New Southern Double Stars, 616
- New Zealand : Geological Survey of, 202 ; Insects in, 478 ; "King Country, or Explorations in," J. Kerry Nichols, 535
- Newall (R. S., F.R.S.), Electrical Rainbow, 464
- Newcomb (Prof. S.), What is a Liberal Education? 9 ; Appointed Professor of Mathematics in the Johns Hopkins University, 640
- Newlands (J. A. R.), the Discovery of the Periodic Law, 51
- Newton (Edward), the Earthquake of April 22, 1884, 32
- Nicols (Arthur), Salmon-Breeding, 512
- Niger : Exploration of, 570 ; Riebeck's Expedition, 592
- Nilson and Petterson, Preparation of Pure Beryllium Chloride, 84
- Nitrification, Notes on, 644
- Nitrogen, Hydroxylamine and the Assimilation of, by Plants, 548
- Nomenclature, Origin, and Distribution of Deep-Sea Deposits, John Murray and Rev. A. Renard, 132
- Nomenclature, Zoological, 256, 277
- Nordenskjöld (Prof.), Map of East Greenland, 64 ; "Popular Scientific Appendix to the Voyage of the *Vega*," Note on the Fifth Fascicule of, 131
- North America : the Mosses of, Leo Lesquereux and Thos. James, J. G. Baker, F.R.S., 461 ; Cretaceous Flora of, Sir J. W. Dawson, 631
- North Cape Whale, Prof. G. A. Guldberg, 148
- Northern Europe, Forests of, 397
- Northern Russia and Lands beyond, Forests and Forestry of, J. Croumbie Brown, 535
- Northernmost Point of Europe, 518, 642
- Norway : Northern, under the Glacial Age, Karl Pettersen, 202 ; Fireball in, 200, 300
- Norwegian Geodetical Operations, 105
- Novara Expedition, 1857-59, 547
- November Meteors, 615
- Numerical Tables and Constants in Elementary Science, Sidney Lupton, 222
- Nyassa, Lake, and Mozambique, Exploration of Country between, 546
- Observatories : Paris, 154 ; Reply to Grubb on Equatorial *Comet* of, M. Loewy, 4, 53 ; the Equatorial *Comet* of the, Howard Grubb, 100, 123 ; Meteorological, in the China Seas, 108 ; Visitation of the Royal Observatory, 147 ; Oxford University, 200 ; Private Observatories in Russia, 181 ; Fr. Glasenap on, 252 ; Yale College, U.S., 432 ; in Hong Kong, 567 ; at

- Stockholm, 592; at Ben Nevis, 613, 640; at Pulkowa, 615; at Dorpat, 615
- Ocean Swells, Col. H. H. Godwin-Austen, 487
- Ocean Water, on the Composition of, Prof. Dittmar, F.R.S., 292
- Oceanography, Handbook of, 180
- Odell (W.), Library Catalogues, 636
- Oestrifæ, Observations on, by Miss E. A. Ormerod, 641
- Ohio, Glacial Boundary in, 155
- Olbers' Comet of 1815, 64, 519
- Oldham (B. D.), Double-Storied Houses and Concave Roofs in the Himalayas, 30
- "Opah Fish," Fine Specimen of, 129
- Oporto, Commercial Geographical Society of, 644
- Orchids, Australian, 437
- Ordinance, Wire in the Construction of, Mr. J. A. Longridge on, 285
- O'Reilly (Prof. P.) "Red Glow" after Sunset, 170
- "Ores of Leadville," Ernest Jacob, 437
- Organisms under High Pressures, 494
- Oribatidæ, the British, A. P. Michael, Sir J. Lubbock, F.R.S., 141
- Orient Line Guide, the, 102
- Origin and Life-Histories of the Least and Lowest Living Things, Researches on, Rev. W. Dallinger, F.R.S., 619, 645
- Ormerod (E. A.), Injurious Insects, 142
- Ornament, on the Evolution of, Prof. Jacobsthal, 248, 272
- Ornithological Notes, 294
- Ornithologists' Union, American, 616
- Osten Sacken (Baron), Cannibal Snakes, 312
- Ova, Hatching of Cod and Soles, in Norway, 181
- Owen (Sir Richard, F.R.S.), Work on "A History of British Fossil Reptiles," 517
- Oxford, Statute allowing Women to enter for Honour Examinations, 19
- Oxford University Observatory, 200
- Oysters, Attempts to Form Beds of, in Baltic, 458
- Page (A. Shaw), Earthquake of April 22, 1884, 102
- Paleolithic Implements from Cambridge, M. C. Hughes, 632
- Pallas, Exploring Expeditions of, 153
- "Pampas and among the Andes, Across the," Robt. Crawford, 36
- Paper Money, upon the Occurrence of Bacteria and Minute Alge on the Surface of, Jules Schaarschmidt, 360
- Paris: Academy of Sciences, 23, 47, 67, 120, 163, 188, 211, 235, 259, 284, 307, 332, 355, 370, 404, 432, 460, 484, 508, 531, 556, 580, 604, 628, 651; Annual Meeting of, 40; Paris Electrical Congress, 1884, 26; the Observatory of Paris, 154; Reply to Grubb on Equatorial *Coudé* of, M. Lœwy, 4, 53; the Equatorial *Coudé* of the, Howard Grubb, F.R.S., 100, 123
- Parker (Dr. G. W.), Geology and Mineralogy of Madagascar, 307
- Parsley Crop, Failure of the, 539
- Pasco (Commander Crawford, R.N.), on Tidal Observations, 641
- Pasteur (M.), Experiments on Rabies, 81; on the Attenuation of the Virus of Rabies, 97; Awarded a Gold Medal for his Work on Rabies, 179
- Pathological Anatomy, Ziegler's Text-Book of, 263
- Paulsen (Dr. Adam), Appointed Director of Danish Meteorological Institute, 179
- Peal (S. E.), Pile-Dwellings on Hill-tops, 168
- Pearson (Karl), Animal Intelligence, 289
- Pen Pits, Somerset, 545
- Pendlebury (Chas.), Lenses, 310
- Pentacrinoid Stage of *Antedon rosaceus*, Prof. W. A. Herdman, 634
- Periodic Law: the Discovery of the, J. A. R. Newlands, 51; Application of to Mineralogy, Prof. J. Carnelley, 181
- Peripatetic Method of Instruction in Science and its Development, Henry W. Crosskey, LL.D., 622
- Peikin (Dr. W. H.), Chemical Research in England, 246; Proposed Statue of M. Dumas, 263
- Permanency of Continents, Rev. Geo. Henslow, 407
- Peronospora infestans*, J. L. Bozward, 216
- Ferrotin (M.), the Aspect of Uranus, 21
- Perry (Prof. John), New Form of Spring for Electric and other Measuring Instruments, 205
- Perry (Rev. S. J., F.R.S.), Extraordinary Darkness at Midday, 6; Black Rain, 32
- Persia, Natural History Collections of, 615
- Petermann's Mittheilungen, 644
- Petherick (E. A.), Early Discoveries in Australasia, 109
- Petrie (Capt. Frank), Sky-Glows, 268
- Petrie (W. M. Flinders), Fireballs, 360; Shifting of the Earth's Axis, 512, 561
- Petersen (Karl), Northern Norway under the Glacial Age, 202
- Pettersson (Otto), a New Principle of Measuring Heat, 320
- Phänologie, Beiträge zur, Dr. Egon Ihne and Dr. Hoffmann, 558
- Phenology, Contributions to, Dr. Egon Ihne and Dr. Hoffmann, 558
- Phenomena, the Volcanic (Dust?), T. W. Backhouse, 633
- Phenomenon, Curious, J. T. Bottomley, 634
- Philadelphia, Electrical Exhibition at, 543
- Philippine Islands, Systems of Writing by various Races in, 643
- Philippines, Flora of the, R. A. Rolfe, 71
- Phillips (S. E.), the Laws of Volume and Specific Heat, 288
- Philosophical Society of Glasgow, 327
- Phosphorescence of the Jelly-fish, R. Meldola, 289
- Photographic Society, 546
- Photographing Blood-Corpuscles, 495
- Photography, Astronomical, 496
- Photography for Double Stars, Henry, 21
- Phylloxera, 429, 519; in Pomological Institute of Pörskau, Silesia, 567; in Rhenish Provinces, 593; International Congress on Prevention of, 614
- Physical Notes, 568
- Physical Society, 47, 119, 139, 210, 283
- Physics, Daniell's, 49
- Physiology of the Brain, Prof. Christiani, 260
- Physiology of Ethics, by Prof. Stricker, 180
- Physiology, Work on, from Tung Wen College at Peking, 458
- Picture, an Anthropological, 41
- Pile-Dwellings on Hill-tops, S. E. Peal, 168
- Pinto (Major Serpa), 546
- Pipe-Clay, A. Hale, 489
- Pitch-Curves of Cogged Wheels, A. H. Curtis, LL.D., 162
- Pits, Cole's, Rev. A. Irving, 560; Joseph Stevens, 607
- Pitt-Rivers (General), his Excavations in Pen Pits, Somerset, 545
- Plane Conics, Examples on the Analytic Geometry of, R. A. Roberts, 143
- Plant, Carnivorous, Preying on Vertebrata, Prof. H. N. Mosely, F.R.S., 81; Commander Alfred Carpenter, 289
- Plant-Life, Edward Step, 99; Wonders of, Sophie Bledsoe Herrick, 168
- Planté, on Ball Lightning, 569
- Plants: Absorption of Water by, Francis Darwin, F.R.S., 7; Simple Method of Measuring the Transpiration of, Rev. Geo. Henslow, 146; Protoplasmic Continuity in, Thomas Hick, 216; Hydroxylamine and the Assimilation of Nitrogen by, 548; Ascent of Water in, 561
- Plarr (M. I.), the Earthquake of April 22, 1884, 77
- Podalirius minutus*, H. C. Chadwick, 385
- Prison Congress at Rome, International, 108
- Polar Conference, the, 93
- Polar Expeditions: New Scheme of, 153; *viâ* Franz Josef Land, 457, 495; Russian, 199, 430
- Polar Meteorological Station, 430
- Polzunoff, Maker of the First Steam-Engine in Russia, in 1763, 344
- Pons' Comet, A. S. Atkinson, 55, 463
- Post (Dr. G. E.), Remarkable Raised Sea-Bed near Lattakia, Syria, 384
- Potantin, sent by Russian Geographical Society, 570
- Potétomètre, the, H. Marshall Ward, 79
- Potilizin on Hydration of Cobalt Chloride, 84
- Poits (T. H.), Animal Intelligence, 265; Iridescent Lunar Halos, 464
- Prehistoric Man in Egypt and Syria, V. C. Dawson, C.M.G., 95
- Prehensile and other Zeolites in Samson's Ribs and Salisbury Crag, Andrew Taylor, 181
- Primeval Man and Working-Men Students, 194

- Prime Meridian, Universal, Conference on, 566, 567, 602, 613  
 Prince (C. L.), the Recent Earthquake, 57  
 Pritchard (Henry Baden), Death of, 83  
 Proceedings of the Linnean Society of New South Wales, 355  
 Projectiles, on the Motion of, Rev. Francis Bashforth, 5  
 Protoplasm, Continuity of the, through the Walls of Vegetable Cells, 182; Thomas Hick, 216  
 Przevalsky (Col.), News from, January 20 and March 22, 570;  
 Przevalsky's Wild Horse, 391; W. W. Watts, 436  
 Psychology, Outlines of, James Sully, G. J. Romanes, F.R.S., 238  
 Ptolemy's 30th of Centaurus, 346  
 Public Service, Science and the, 32  
 Puckle (G. Hale), an Elementary Treatise on Conic Sections and Algebraic Geometry, 631  
 "Pyramids of Instruction" in Germany, 200  
 Pyrometers, W. R. Browne, 366  
 Pyroxene, Triclinic, in Augitic Rocks and Hypersthene-Andesite, 155, 201
- Qualitative Analysis for Beginners, Stoddard's, 51  
 Quarantine, 546  
 Quelch (John L.), the Milleporidæ, 539  
 Quern Stones, 545
- Rabbits, on the Extirpation of the Cerebrum in, Prof. Munk, 308  
 Rabies, M. Pasteur on the Attenuation of the Virus of, 81, 97  
 Rae (Dr. John, F.R.S.), Intelligence in Animals, 6; Atlantic Ice and Mild Winters, 76  
 Ragg (Rev. F. W.), the Earthquake of April 22, 1884, 32  
 Railway Carriages, Seats in, 320  
 Railways, Enrichment of Swedish Flora by, 83  
 Rain, Black, Rev. S. J. Perry, F.R.S., 32; Dr. Treutler, 216  
 Rainbow: Circular, E. L. Layard, 361; W. L. Goodwin, 465; W. P. Marshall, 584; W. Symons, 607; Electrical, R. S. Newall, F.R.S., 464; Rainbow on Spray, 464; Frank E. Cane, 490; Rainbow after Sunset, James Graves, 635  
 Rainfall of New South Wales, 196  
 Rains and the Recent Volcanic Eruptions, the, M. Gay, 229  
 Rains, Winter, of Northern India, Theory of the, H. F. Blanford, F.R.S., 304  
 Ramsay's (Prof.) Experimental Proofs of Chemical Theory for Beginners, 51  
 Rance (C. E. de), the Earthquake of April 22, 1884, 31, 57; Water Supply Conference, 375  
 Rathbun (R.), American Initiative in Methods of Deep-Sea Dredging, 399  
 Rawlinson (Sir Robert), Address to Sanitary Institute, 546  
 Rayleigh (Lord), on the Use of the Silver Voltmeter, 283  
 "Red Glow" after Sunset, Prof. J. P. O'Reilly, 170; S. E. Bishop, 194; Prof. W. N. Hartley, 384  
 Red Light round the Sun—the Sun Blue or Green at Setting, 633  
 "Rede" Lecture, 129  
 Refraction-Equivalents of Metals, Kannonikow's Experiments in Measuring the, 84  
 Regel's Explorations in Central Asia, 275  
 Renard (Rev. A.), Deep-Sea Deposits, 84, 114; and John Murray, on the Nomenclature, Origin, and Distribution of Deep-Sea Deposits, 132  
 Rendall (Dr. S. M.), Krakatoa, 287  
 Rendiconti del R. Istituto Lombardo, 118, 161, 209, 306, 379, 403, 627  
 Repulsion, D. D. Heath, 490  
 Revue d'Anthropologie, 232, 403  
 Revue d'Ethnographie, 276  
 Reykjanes, Volcanic Island off, 614  
 Reynolds (J. E.), Experimental Chemistry, 4  
 Reynolds (Prof. Osborne, F.R.S.), the Two Manners of Motion of Water, 88  
 Rhode Island, its Geology, 495  
 Rhyolitic Rock from Lake Tanganyika, Prof. T. G. Bonney, F.R.S., 193  
 Riebeck'sche Niger Expedition, 592  
 Righi (A.), on Influence of Heat and Magnetism on Electrical Resistance of Bismuth, 569  
 Right-Sidedness, 102; Prof. Joseph LeConte, 76
- Riley (Prof. C. V.), Entomologist and Curator of Insects in U.S. National Museum, Visit to Europe, 429  
 Rings of Saturn, A. Ainslie Common, 144  
 Ringwood (Alex.), Red Sunsets, 301  
 Rivers, Salmon, Cultivation of, Mark Heron, 146  
 Rivista Scientifico-Industriale, 118, 161, 508, 627  
 Roberts (R. A.), Examples on the Analytic Geometry of Plane Conics, 143  
 Robinson (W.), English Flower Garden, 534  
 Rocks, Callovian, Position of the, 154  
 Rogozinski's Travels between Cameroon and Calabar, 109  
 Rolfe (R. A.), Flora of the Philippines, 71  
 Romanes (Dr. G. J., F.R.S.), Chambers's "Vestiges of Creation," 73; Sully's "Outlines of Psychology," 238; Animal Intelligence, 267  
 Rome: International Prison Congress at, 108; Barometrical Indications in, of Aerial Disturbances caused by Krakatoa Explosion, 324  
 Roofs (Concave), in the Himalayas, B. D. Oldham, 30  
 Roscoe and Schorlemmer's Chemistry, Dr. H. Watts, 75  
 Rosny (Léon de), on the Japanese, 570  
 Rotation, Earth's Axis of, Prof. C. Piazz-Smyth, 29  
 Rothamsted, Experimental Farm at, 642  
 Rouen, Electrical Exhibition, 252  
 Royal Corps of Naval Constructors, W. H. White, 33  
 Royal Meteorological Society, 22, 120, 211  
 Royal Microscopical Society, 47, 119, 284  
 Royal Society, 46, 70, 94, 109, 137, 161, 210, 234; *Conversione*, 63  
 Royal Society of Canada, 227  
 Royal Society of New South Wales, 259  
 Running and Leaping, Greek and English Records, 324  
 Russia: Geology in, 94; Forests in, 515; the New Geological Map of, 608; Collection of Russian Folk-Lore, 130; Russian Geographical Society, the, 109, 130; Russian Private Observatories, Dr. Glasenap, 252  
 Rye (E. C.), and New Guinea Bibliography, 275  
 Ryselberghé's (Van) Telephone, 547
- Sabine, Gen., on Connection between Temperature of Atlantic Waters and Weather of Europe, 545  
 Sabine (Robert, C.E.), Death of, 641  
 Sagastyr Meteorological Station, 130, 430, 567  
 Saigon to Tonquin and Bangkok, Travels from, 644  
 St. Andrews, Biology at, 107  
 St. Clair, on Photographing Blood-Corpuscles, 547  
 St. Nicholas Agassiz Association in the U.S. for Teaching of Science, 396  
 St. Petersburg: Horticultural Exhibition, 64; Academy of Sciences, 153, 430; Five Charles Darwin Bursaries at University of, 344  
 St. Thomas, the Island of, Prof. Greeff, 109  
 Salmon: Migrations of *Salmo saar* in the Baltic, Prof. And. Joh. Malmgren, 521; Removal of Obstructions to Ascent of Salmon up Scotch Rivers, 129; Cultivation of Salmon Rivers, Mark Heron, 146; Migration of, 361; Salmon-Breeding, Francis Day, 488; Arthur Nicols, 512  
 Salpa, is it an Example of Alternation of Generations? W. K. Brooks, 367; R. N. Goodman, 463  
 "Salting-Mounds" or "Red Hills" of Colchester, 344, 374  
 Salts, Densities of Solutions of, Increase of, in Proportion to Increase of Molecular Weights, Prof. Mendeléeff, 84  
 Samarkand, Ruins of an Ancient City near, 593  
 Sand-Dust, Atmospheric, from Unalaska, Report on, J. S. Diller, 91  
 Sandhurst Examinations, Science and, 409  
 Sanitary Institute of Great Britain, 457, 546; at Dublin, 557  
 Sasaki (C.), *Udschimyia sericaria*, Rond., a Fly Parasitic on the Silkworm, 435  
 Saturn, 105; Rings of, A. Ainslie Common, 144  
 Saunders (Rev. J. C.), Hydrodictyon in the Eastern Counties, 488  
 Scales, 385  
 Schaarschmidt (Jules), upon the Occurrence of Bacteria and Minute Algæ on the Surface of Paper Money, 360  
 Schellen (Dr. Heinrich), Obituary Notice of, 517  
 Schiödté (Prof. J. C.), Danish Entomologist, Death of, 153  
 Schmidt's Variable-Star in Virgo, 325, 397

- School Museums, Dr. J. H. Gladstone, F.R.S., 384; Rev. G. Henslow, 407; W. Hewitt, 407
- Schools, Healthy, 388
- Schools, Science in, Prof. Huxley, 63
- Schorlemmer and Roscoe's Chemistry, Dr. H. Watts, 75
- Schrauf (Dr. Albrecht), Elected Corresponding Member of Vienna Academy of Sciences, 129
- Schriften der Physikalisch-Oekonomischen Gesellschaft, 379
- Schwackhöfer's "Fuel and Water," Prof. Fleeming Jenkin, F.R.S., 311
- Schweinfurth (Dr. Georg), Return to Africa, 343, 547
- Science and Manufactures, 1
- Science and the Public Service, 32
- Science in Schools, Prof. Huxley on, 63
- Science Lectures in Royal Victoria Coffee Hall, London, 180
- Science and the Woolwich and Sandhurst Examinations, 189, 409
- Science and Military Examinations, E. D. Archibald, 239
- Science in Russia, 327
- Science and Art Education, 349
- Science: Government Endowment of, in Norway, 200; in Germany, 394; in the United States and England, 371, 394; Interdiction of, in Russia, 430
- Science Teaching in America, 396; in Schools, 517
- Science and its Development, Peripatetic Method of Instruction in, Henry W. Crosskey, LL.D., 622
- Science, Natural, in Tasmania, 562
- Scientific Association, International, 566
- Scientific Associations, International Convention of, 371
- Scientific Study, Specialisation in, 314
- Scientific Works, the Distribution of, Published by the British Government, Prof. V. Ball, F.R.S., 634
- Scotland, Fishery Board for, 387
- Scottish Meteorological Society, 179, 326
- Scott-White (A. H.), Chemical Analysis for Schools, 51
- Scythic Disease among Aleutes and Kamchadales, 132
- Sea, Light at Great Depths in, A. E. Verrill, 280
- Sea, the Saltness and Temperature of the, H. R. Mill, 313
- Sea and Continental Climate with regard to Vegetation, Difference between, Dr. M. Bergsman, 392
- Sea-Bed, Remarkable Raised, near Lattakia, Syria, Prof. E. Hull, F.R.S., Rev. Dr. G. E. Post, 384
- Sea Monster, Alfred Morris, 513
- Sebert's Method of Registering the Velocity of Shot within the Tube of a Gun, 344
- Seats in Railway Carriages, 320
- Seeborn, Henry, on Birds' Nests, 276
- Seismograph, a Multiplying, 569
- Seismological Society, 614, 642
- Seismology in Japan, 642
- September Stream of Krakatoa Smoke at Strong's Island, S. E. Bishop, 537
- Serrel Serigraph, 429
- Serrell (E. W., jun.), Dust-Free Spaces, 53
- Settari (Dr.), Death of, 517
- Sextants, T. W. Baker, 464
- Shamanism in Perak, 346
- Shifting of the Earth's Axis, W. M. Flinders Petrie, 561; Prof. C. Piazzi-Smyth, 582
- Shorthand, History of, 397
- Siam, 546; Progress of English in, 644; Holt Hallett's Expedition, 324
- Siberia, Steamers to, 344
- Siberia, Arctic, Hydrography of, 345
- Sicily, Malta and, Remarkable Sunsets in, 20
- Siemens (Sir Wm.): Proposed Engineers' Memorial to, 221; Methods of Work, 477
- Silica, Forms of, John Ruskin, D.C.L., 181
- Silkworm, *Udshinya sericaria*, Rond., a Fly Parasitic on the, C. Sasaki, 435
- Simms (G. E., jun.), *Utricularia vulgaris*, 295
- Simplon, Piercing Alps at, 615
- Simson's Line, 635
- Singh (Chanda), an Intellectual Prodigy in India, 592
- Sitzungsberichte der Naturforschenden Gesellschaft, 233
- Skirving (R. Scot), Diffusion of Species, 512
- Sky-Glows: B. J. Hopkins, Capt. Petrie, 268; J. Edmund Clark, 488, 607; J. Gledhill, 489; Clement L. Wragge, 489; W. Larden, 489; T. W. Backhouse, 511; Robt. Leslie, 512, 583; Prof. A. S. Herschel, 536; Miss T. M. Browne, 537; J. J. Murphy, 583; E. Brown, 607
- Skye, Finds in a Peat Moss in, 181
- Small-pox, 567
- Smeaton Lighthouse, 567
- Smith (Prof. C. Michie), Observations on a Green Sun and Associated Phenomena, 347; Forked Lightning, 463
- Smith (Chas.), Elementary Treatise on Solid Geometry, 143
- Smith (E. A.), Geological Survey of Alabama, 77
- Smith (Rev. F. J.), Work-Measuring Machines, 220
- Smith (J. P. G.), the Flow of Streams, 486
- Smith (Dr. R. Angus, F.R.S.), Death of, 63; Obituary Notice, Prof. T. E. Thorpe, F.R.S., 104
- Smith (Worthington G.), Lightning, 241
- Smith (W. G.), Fireballs, 408
- Smolensk, Uvaroff's Explorations in, 223
- Smyth (Prof. C. Piazzi), Earth's Axis of Rotation, 29; Shifting of the Earth's Axis, 582; Meteor-, Moon-, and Sun-shine, 462; Krakatoa Eruption, 511; M. Thollon's Views of "Great B" in the Solar Spectrum, 535
- Smyth (R. Brough), Atmospheric Dust, 170
- Snake, a Cannibal, Edwin H. Evans, 216; Baron Osten-Sacken, 312; John Fotheringham, 269; Dr. C. F. Crehore, 408; Suicide of, Rev. W. R. Manley, 268; Snakes and Tortoises in Chinese Mythology, 180
- Snow and Ice Flora, Prof. von Haast, 55
- Snowfall, Himalaya, Connection with Dry Winds and Drought in India of the, H. F. Blanford, F.R.S., 46
- Social Science Association, 180; Questions for Discussion at, 222; Meeting at Birmingham, 517; Inaugural Address by President O. Browning, 517; Paper by Dr. W. H. Crosskey, on Teaching of Science in Schools, 517
- Società di Geografia ed Etnografia, 323
- "Societies, Scientific and Learned, of Great Britain and Ireland, Year-Book of the," 108
- Society of Arts, *Conversazione* by the Council at Health Exhibition, 199; Award of Silver Medals, 199
- Solar (Dust?) Halo, Prof. E. Douglas Archibald, 559
- Solar Eclipse, Total, of 1816, November 19, 616; of March 16, 1885, 643
- Solar Halo, W. W. Taylor, 241
- Solar Spectrum, Constitution and Origin of the Group B of the, M. L. Thollon, 520; M. Thollon's Views of "Great B" in the, Prof. C. Piazzi-Smyth, 535
- Solar Surface, Temperature of the, Capt. J. Ericsson, 465
- Songkoi or Red River, Survey of, 394
- Sorby (H. C., F.R.S.), the Earthquake of April 22, 1884, 101
- Soup, Birds'-Nest, 271
- South America, German Expedition in, 570
- Southern Binaries, 594
- Sowerby (Rev. A.), the Remarkable Sunsets, 77
- Spain, Arcimis' Observations of Sunset Phenomena in, 324
- Specialisation in Scientific Study, 314
- Species, Diffusion of, Duke of Argyll, 462; Dr. G. C. Wallich, 512; R. Scot Skirving, 512
- Specific Resistance of Distilled Waters, M. Fousserau's Observations on, 568
- Spectroscope, Pocket, How to Foretell the Weather with, F. W. Cory, 606
- Spectrum Analysis: Constitution and Origin of the Group B of the Solar Spectrum, M. L. Thollon, 520; Prof. Piazzi-Smyth, 535
- Spinach-Fly Attacking Beet-Root Plants, 494
- Spirifer disjunctus* (Devonian Brachiopod), its Chinese Equivalent and its Distribution over the Earth, 153
- Spitzbergen, some Particulars of Capt. M. E. Arnesen's Voyages around, 132
- Sprats, Specimen of Mature, 129
- Spray, Rainbow on, 464; Frank E. Cane, 490
- Sprengel (Christian Conrad), Dr. F. Müller, 240
- Spring, New Form of, for Electric and other Measuring Instruments, Profs. W. E. Ayrton, F.R.S., and John Perry, 205
- Stanley (H. M.), Return of, 324
- Stanley (W. F.), Atmospheric Effect Produced by Volcanic Dust from Krakatoa Eruption, 22; Earthquake, 125
- Stars: on the Atmospheric Influence on the Colours in the Scintillation of, Montigny, 222; British Association Catalogue of, 496; Double, Photography for, M. Henry, 21; 99 Herculis, 375; New Southern, 616; Fixed, David Gill,

- F.R.S., 135, 156; Variable, 131, 200, 479, 594, 643; in Aquarius, 346; in Virgo, Schmidt's, 325, 397
- Statics, Graphic and Analytic, in Theory and Comparison, R. H. Graham, 383
- Steam-Engine, First Russian, in 1763, 344
- Steam Practice, Modern, and Engineering, John G. Winton and W. J. Millar, 509
- Stellar Scintillations and Atmosphere, 344
- Stenberg (Prof.), Death of, 299
- Step (Edward), Plant-Life, 99
- Sterndale (R. A.), Natural History of the Mammalia of India and Ceylon, 98
- Stevens (Joseph), Cole's Pits, 607
- Stevenson (Chas. A.), Aseismic Tables for Mitigating Earthquake Shocks, 193
- Stewart (Prof. Balfour, F.R.S.), Report on Comparison between Apparent Inequalities of Short Period in Sunspot Areas and in Diurnal Temperature Ranges at Toronto and at Kew, 118; "Heat," Prof. P. G. Tait, 191
- Stewart (Duncan), Intelligence in Animals, 6
- Stockholm: Meteor at, 300; Society of Natural Sciences, 628
- Stoddard (J. P.), Qualitative Analysis for Beginners, 51
- Stone (Dr. W. H.), the Electrical Resistance of the Human Body, 56, 269; Kohlrausch's Meter-Bridge, 145; Health and Electricity, 253; Electro-Dynamometer with Extremely Light Suspended Coil, 635
- Stone Hatchets in China, Rev. Dr. J. Edkins, 515
- Stone Implements (Indian), Rivett-Carnac's, 324; in West Indian, 593
- Stoney (G. J., F.R.S.), New Collimator for Reflecting Telescopes, 22; the Local Heliostat, 72
- Storage Batteries, 585
- Strachey (Lieut.-Gen. R.), Delegate to International Prime Meridian Conference, 129
- Strasburg, New University Building, 615
- Strasburger (Dr.), "Das Botanische Practicum," 215
- "Strata of the North of England," Westgarth Forster, 3
- Streams, the Flow of, Geo. Maw, 486; J. P. G. Smith, 486; George Higgin, 560
- Stricker (Prof.), on the Physiology of Ethics, 180
- Strong's Island, September Stream of Krakaton Smoke at, S. E. Bishop, 537
- Suicide of Snakes, Prof. W. R. Manley, 268
- Sully's (James) "Outlines of Psychology," G. J. Romanes, F.R.S., 238
- Sumatra, Natural History Collections of, 615
- Sun: Observations on a Green, and Associated Phenomena, Prof. C. Michie Smith, 347; Red Light Round the—the Sun Blue or Green at Setting, 633; Sun-Glows, Robert Leslie, 463; Sunsets, the Remarkable, L. G. Carpenter, 32; J. L. Bozward, 32; Rev. A. Sowerby, 77; A. G. Mocenigo, 82; in Malta and Sicily, 20; Prof. J. P. O'Reilly, 170; Alex. Ringwood, 301; Chas. Morris, 312; Rainbow after Sunset, James Graves, 635; Sunset Phenomena in Spain, Arcimis' Observations of, 324; Meteor-, Moon-, and Sun-shine, Prof. Piazz-Smyth, 462; Sunspots and Diurnal Temperature Ranges, Stewart and Carpenter, 109; the Theory of, Rev. T. W. Webb, 59
- Sunday Society and Health Exhibition, 180
- Swallows and House-Flies, Fellow-Feeling in, 490
- Swan (E. A.), "Notes on Earthworms," 77
- Sweden, a Remarkable Phenomenon in, 153
- Swedish Flora, Enrichment by Railways of, 83
- Swells, Ocean, Col. H. H. Godwin-Austen, 487
- Swinton (Alan Campbell), Principles and Practice of Electric Lighting, 144
- Sydney: Royal Society of New South Wales, 332, 459, 580; Linnean Society of New South Wales, 404, 603, 651
- Symons (W.), Circular Rainbow, 607
- Tailed Child, a Recent Case, 200
- Tait (Prof. P. G.): "Heat," Prof. Balfour Stewart, F.R.S., 191; "Light," R. T. Glazebrook, 261
- Tarr (Ralph S.), Habits of Burrowing Crayfishes in the United States, 127
- Tasmania, Natural Science in, 562
- Taxidermy, Practical, 338
- Taylor (H. Dennis), Recent Lunar Eclipse, 632
- Taylor (Dr. J. E.), the Earthquake of April 22, 1884, 18, 31
- Taylor (W. W.), Solar Halo, 241
- Tea-Trees in Transcaucasia, 397
- Technical Education in America, 394
- Technical Instruction, Recommendations of the Royal Commission on, 113, 357, 381
- Technical Forms of European Science, their Translation into Japanese, 477, 495
- Technical Teaching, Catalogue of Apparatus for, 567
- Telegraph Engineers and Electricians, Society of, *Conversazioni* and Conference, 179
- Telegraphic and Telephonic Transmissions along the same Wire, 519
- Telegraphy: Cheap, 394; New Development of, by Michela in Italy, 546
- Telephone, Application of, to Measurement of Temperatures at a Distance, 345
- Telephone and Telegraph, 547
- Telephonic and Telegraphic Transmissions along the same Wire, 519
- Telescope System, Lœwy's New, A. Ainslie Common, 434
- Telescopes, Reflecting, New Collimator for, G. J. Stoney, F.R.S., 22
- "Telluriques, Etude des Courants," E. E. Blavier, 106
- Temperature of the Solar Surface, Capt. J. Ericsson, 465
- Temperatures in America and Europe, Difference of, 457
- Tenison-Woods (Rev. J. E.): Malayan Geology, 76; the Mountain System of the Malayan Peninsula, 264
- Terrestrial Currents, on, Dr. Wild, 223
- Tertiary Botany in Central Asia, 430
- Thenard, Baron, Obituary Notice of, 430
- Thermometers: "Froude," the Dry and Wet Bulb, Prof. H. A. Hazen, 6; Rotating, Edwin Clarke, 32
- Thollon (L.), Constitution and Origin of the Group B of the Solar Spectrum, 520; Prof. C. Piazz-Smyth, 535
- Thompson (Joseph), Return of, 298
- Thompson (Prof. Silvanus P.), Dynamo-Electric Machinery, 144, 630
- Thompson (Mrs.), Contribution to International Scientific Association, 566
- Thomson Effect and other Physical Properties of Metals, on a Relation between the, Shelford Bidwell, 94
- Thomson (Prof. James), Whirlwinds and Waterspouts, 648
- Thomson (Sir William, F.R.S.), Elected Foreign Honorary Member of Vienna Academy of Sciences, 129; on "Wave-Theory of Light," 545; Lectures in Johns Hopkins University, 640
- Thoroddsen's Geological Explorations, 317
- Thoroddsen (Th.), Explorations in Iceland, 563, 584
- Thorpe (Prof. T. E., F.R.S.), Robert Angus Smith, 104
- Thought-Transference, Experiment in, Prof. Oliver J. Lodge, 145
- Tide, &c., in the Baltic, Measurement of, 200
- Tides, the Regular, Record of, 641
- Timor, Earthquake at, 20
- Tollens, Sugar-like Substance obtained by Action of Alkalies on Formaldehyde, 84
- Tomlinson (Herbert), Module of Elasticity, 234
- Tonquin, M. Aumoitte's Journeys in, 276
- Tonquin and Cambodia, Tribes on Frontiers of, 644
- Topley (W.), the Earthquake of April 22, 1884, 17, 60; Aseismic Tables for Mitigating Earthquake-Shocks, 216
- Tortoises and Snakes in Chinese Mythology, 180; their Mutual Affection, 180
- Total Solar Eclipse of 1816, November 19, 616; of 1889, January 1, 131
- Toulon, Cholera at, 213
- Tourmaline, Crystals of, a Peculiar Development of, Paper read before Mineralogical Society, 181
- Trachinus vipera*, Geo. Brook, 71
- Training in Naval Architecture, Prof. Elgar, 483
- Transpiration of Plants, Simple Method of Measuring the, Rev. Geo. Henslow, 146
- Trautschold (Prof.), Geological Parallel between Colorado and European Russia, 614
- Travel, Modern, the Orient Line Guide, 102
- Treutler (Dr.), Black Rain, 216
- Trewendt's Encyclopædia of Natural Science, 21
- Tricholoma colossium*, Specimen of, on Ask Island, 547

- Trichoptera of the European Fauna, Robert McLachlan, F.R.S., 434
- Triclinic Pyroxene, 201
- Tricycles of the Year 1884, H. H. Griffin, 192
- Triethylamine, Action of Water on, Prof. Guthrie, 119
- Trimen (Dr.), on Insects in Ceylon, especially *Helopeltis antonii*, 615
- Trinity House Experiments on Lighthouse Illuminants, 362
- Trinomial Nomenclature in Zoology, 198
- Tromholt (Dr. Sophus), Auroral Researches in Iceland, 80; Auroræ in Northern Europe, 592
- Tropical African Mountain Flora, Sir J. D. Hooker, F.R.S., 635
- Tropical Man, Why he is Black, Nathaniel Alcock, 401
- Tucker (R.), to Find the Cube of any Number by Construction, 539, 561, 584
- Turbot, Peculiar Specimen, 129
- Turin Exhibition, Scientific Features of, 181
- Tuttle's Comet, a New, 83
- Typhoon, History of a, 388
- Udschinya sericaria*, Rond., a Fly Parasitic on the Silkworm, C. Sasaki, 435
- Unalaska, Atmospheric Sand-Dust from, Report on, J. S. Miller, 91
- United States: National Academy of Sciences, 40; Agriculture in the, 77; Habits of Burrowing Crayfishes in the, Ralph S. Tarr, 127; Insect Pests in the, 241
- "Universal Column," Proposed, 567
- Universities (Scotland) Bill, New, 153
- University Intelligence, 22, 46, 94, 117, 137, 159, 186, 209, 232, 259, 531, 602, 649
- Uranus: the Aspect of, Perrotin, 21; Figure of, 519
- Utricularia vulgaris*, G. E. Simms, jun., 295
- Uvaroff's (Count) Explorations in Smolensk, 223
- Uzboi (the), 223
- "Vaccination, Facts Concerning," 300
- Variable Stars: 131, 200, 479, 594, 643; in Aquarius, 346; in Virgo, Schmidt's, 325, 397
- Vegetable Cells, Continuity of the Protoplasm through the Walls of, 182
- Vegetation, Difference between Sea and Continental Climate with Regard to, Dr. M. Bergsman, 392
- Venus, White Spots on, 41
- Verbeek (R. D. M.), the Krakatoa Eruption, 10, 335
- Verhandlungen des Naturhistorischen Vereins der Preussischen Rheinlande und Westfalens, 305, 627
- Vermin in our Colonies, 345
- Verrill (A. E.), Evidence of Existence of Light at Great Depths in the Sea, 280
- Vertebrate Dissection, Handbook of, H. Newell Martin and W. A. Moale, 143
- Vertebrates, the Origin of, 225
- "Vestiges of Creation," Robert Chambers's, Dr. G. J. Romanes, F.R.S., 73
- Vettor Pisani*, Voyage of the, G. Chierchia and Dr. Albert Günther, F.R.S., 365
- Victoria Institute, 95
- Victoria, Meteorology in, 126
- Vienna: Imperial Academy of Sciences, 24, 72, 129, 164, 212, 332, 460, 532; New University Building, 615
- Virgo, Schmidt's Variable Star in, 325
- Vladivostok, Exploring Society at, 615
- Volcanic Ash from Krakatoa: Notes on Microscopical Examination of, J. Joly, 23; Atmospheric Effects Produced by Eruption, W. F. Stanley, 22; the Supposed, F. W. Backhouse, 54, 359, 633; the Rains and, M. Gay, 229
- Volcanoes on the Shores of Lake Nyassa, Africa, Dr. H. J. Johnston-Lavis, 62
- Voltaic Cell, on the Seat of Electromotive Forces in the, 594
- Voltmeter, the Silver, on the Use of, Lord Rayleigh, 283
- Volume, the Law of, S. E. Phillips, 288
- Waddell and Warden's Non-Bacillar Nature of Abrus Poison, 263
- Wakburg, Electrolysing Glass, 568
- Wallich (Dr. G. C.), Diffusion of Species, 512
- Ward (Prof. H. Marshall), the Potéomètre, 79
- Warden and Waddell's Non-Bacillar Nature of Abrus Poison, 263
- Wasp, Carnivorous, 385; Rev. Geo. Henslow, 407; Rev. W. Clement Ley, 407; H. N. Dixon, 408; William White, 408; Thomas Edward, 408; E. F. Bates, 408
- Wasps as Fly-Killers, Geo. Lawson, 539
- Water: Absorption by Plants of, Francis Darwin, F.R.S., 7; the Two Manners of Motion of, Prof. Osborne Reynolds, F.R.S., 88; on the Composition of Ocean, Prof. Dittmar, F.R.S., 292; Schwackhöfer's Fuel and, Prof. Fleeming Jenkin, F.R.S., 311; Hells, 408; Ascent of, in Plants, 561; London Water-Supply, G. Phillips Bevan, 165; Conference on Water-Supply, 298; C. F. de Rance, 375
- Waters (A. H.), the Earthquake of April 22, 1884, 18
- Waters (W. Horscraft), Histological Notes for the Use of Medical Students, 168
- Waterspouts, Whirlwinds and, Prof. James Thomson, 648
- Watts (Dr. H., F.R.S.), a Manual of Chemistry, 3; Watts's Inorganic Chemistry, 57; on "Roscoe and Schorlemmer's Chemistry," 75; Obituary Notice of, 217
- Watts (W. W.), Przewalsky's Horse, 436
- Wave-Refraction, Prof. Poynting, 119
- Weather, How to Foretell, with the Pocket Spectroscope, F. W. Cory, 606
- Wehb (Rev. T. W.), the Theory of Sunspots, 59
- Weights and Measures and Chinese Music, the Connection between, 565
- Weights and Measures, International, 612
- Weka-Pass Stone, on the Geological Position of the, Capt. F. W. Hutton, 306
- Whale, North Cape, Prof. G. A. Guldberg, 148; Dr. Guldberg on, 252
- Wharton (Capt. J. L.), Notes on a few of the Glaciers in the Main Strait of Magellan, 177
- Whipple (G. M.), the Earthquake of April 22, 1884, 19
- Whirlwinds and Waterspouts, Prof. James Thomson, 648
- White (W. H.), the Royal Corps of Naval Constructors, 33
- White (William), Carnivorous Wasps, 408; Fireballs, 464
- White's Fossil Mollusca of North America, Dr. J. G. Jeffreys, F.R.S., 99
- Wight, Isle of, Geological Survey, 130, 494
- Wilczek (Count Hans), Elected Honorary Member of Vienna Academy of Sciences, 129
- Wild (Dr.), on Terrestrial Currents, 223
- Wild Horse, Przewalsky's, 391
- Williamson (B., F.R.S.), Elementary Treatise on Integral Calculus, 143
- Wilson (Sir Erasmus), Death of, 371
- Winter, Stormy, in California, 41
- Winter, Mild, Atlantic Ice and, Dr. John Rae, F.R.S., 76
- Winton (John G.) and Dr. J. Millar, "Modern Steam Practice and Engineering, 509
- Wire in the Construction of Ordnance, Mr. J. A. Longridge, 285
- Wissmann (Lieut.), Exploration of the Kasai, 546
- Wittrock (Veit Brecher), Algal Flora of the Arctic Seas, 638
- Wolf's Comet, 615, 643
- Women, Statute allowing, to Enter for Oxford Honour Examinations, 19
- Women Students, College Hall of Residence for, 457
- Women's College, Working, 568
- Wood (Theodore), Our Insect Allies, 582
- Woodward (C. J.), Arithmetical Chemistry, 4
- Woodward (Dr. J. J.), Death of, 494
- Woolwich and Sandhurst Examinations, Science and the, 189
- Work, National, and Health, 183
- Work-Measuring Machines, Rev. F. J. Smith, 220
- World's Industrial and Cotton Centennial Exposition, 180
- Worm-Eating Larva, W. E. Darwin, 146
- Wragge (Clement L.), Sky-Glows, 489
- Writing, Systems of, in Philippine Islands, 643
- Wurtz (Karl Adolphe), Death of, 63, 103; and his Chemical Work, 170
- Xanthines, Dr. A. Baginski, 236
- Yakutsk and Verkoyansk, Geography of, 430
- Yale College Observatory, U.S., 432

- Yarrell's "History of British Birds," 287  
 Yellow Fever, Glaring Example of Ignorance of Physiology, 298  
 Yenisei, Antiquities in the Basin of, 132  
 Yorkshire College, Appointment of Mr. Archibald Barr to be  
 Professor of Civil and Mechanical Engineering in, 130  
 Young (Prof. C. A.), Pending Problems of Astronomy, 501
- Zeitschrift für Wissenschaftliche Zoologie, 355  
 Ziegler's Text-Book of Pathological Anatomy, 263  
 Zoisite, New Locality for, Mr. Hamilton Bell, 181  
 Zoological Collections, Report on the, made in the Indo-Pacific  
 Ocean during the Voyage of H.M.S. *Alert*, 1881-82, 485
- Zoological Gardens, Additions to, 21, 41, 64, 83, 109, 130, 154,  
 181, 200, 223, 252, 377, 300, 325, 346, 374, 397, 431, 458,  
 478, 495, 519, 547, 568, 594, 615, 642  
 Zoological Marine Survey, a Plea for a National, 25  
 Zoological Nomenclature, 256, 277  
 Zoologicus, Scudder's Nomenclator, 287  
 Zoological Society, 95, 139, 162, 235  
 Zoology and the Afghan Frontier Commission, 324  
 Zoology at Edinburgh University, 107  
 Zootomy, Course of Instruction in, T. Jeffrey Parker, 144  
 Zuntz (Prof.), the Gaseous Inhalation and Exhalation in the  
 Case of Animals affected with Curare, 96





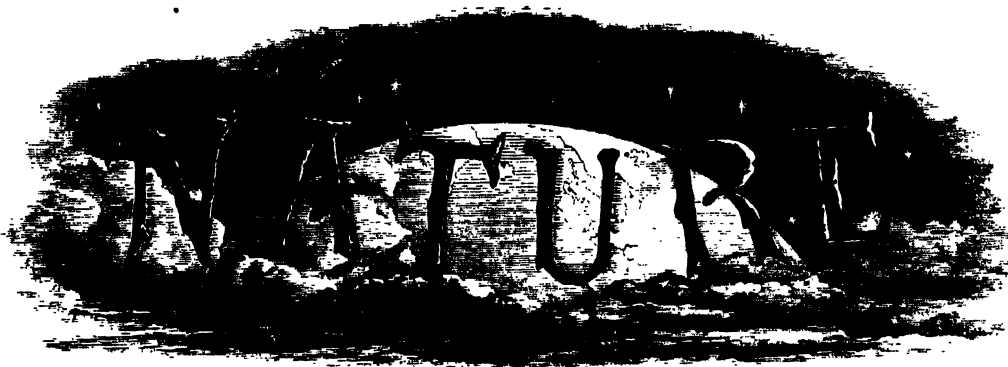

## A WEEKLY ILLUSTRATED JOURNAL OF SCIENCE

*"To the so'id ground  
Of Nature trusts the mind which builds for aye."*—WORDSWORTH

THURSDAY, MAY 1, 1884

### SCIENCE AND MANUFACTURES

THE occurrence in one week of meetings held by the Iron and Steel Institute, and by the Institution of Mechanical Engineers, seems to offer a fitting occasion for further remarks on the connection between science and art, between practical construction and theoretical investigation. A few months ago, in an article on the same subject, it was pointed out how these two branches of knowledge were found to work in harmony for the ends of each—science instructing art, art supporting and ministering to science; and this truth was illustrated by a variety of examples. Others which have occurred since that time may be touched upon before we conclude. At this moment we are anxious to insist once more on the need which exists to draw this union between art and science closer than it has ever been drawn before, and to remove all obstacles which may stand in the way of its fullest realisation.

The necessity for this union lies in the fact that England has an industrial supremacy to maintain, and that year by year its maintenance becomes more difficult in the face of keen and jealous competition. Whatever may be said in Parliament, all practical men are aware that the great tide of prosperity, promised last year by the President of the Board of Trade, has not yet begun to flow; that on the contrary there was never perhaps a time when the special industries of England were more depressed, or their outlook more gloomy. The fact that the steel-rail makers of England have banded themselves with those of France and Belgium into an association for the maintenance of remunerative prices speaks volumes, not only as to the severity of competition, but as to the sources from which that competition comes. On the other side we see the iron-masters of America extending their output year by year, and her manufacturers entering into competition with us in neutral markets, while jealously excluding us from their own.

What is to be the remedy for this state of things? How

is the demand for manufactured articles, and for the raw materials out of which those articles are made, to be once more equalised with the supply? Unless some vast market, such as China or Central Africa, can be opened up to European commerce, the only chance seems to lie in a new departure; in some great cheapening of production, or cheapening of transport, comparable to that which was effected by the development of railways. Now what is the physical fact lying at the basis of railway locomotion? It is simply this, that iron laid in the form of a track offers a resistance to rolling which, as compared with an ordinary road, is insignificant, whilst at the same time it offers a resistance to sliding large enough to utilise to the full the vast tractive power of the modern locomotive. The first point had long been known; the second was seized by the practical genius of George Stephenson, and enabled him at once to solve the problem of high speed locomotion. In so doing he owed nothing to science; but science might have discovered the fact, and would have done so with small trouble, if the idea had been put into her head—if, in fact, there had been in England that union of theory with practice which it is our present aim to advocate.

What is wanted now is that science shall point out some other fact of nature, new or old, which practice may seize upon, turn to her own ends, and make the basis of some new industrial development. It is easy to indicate various directions which such a development might take. Thus there is great need of some system of light railways which can be laid down on ordinary roads, and so cheaply that the traffic available on such roads may be sufficient to pay a fair return on the capital. It is impossible to calculate the advantages which would spring from the wide extension of such "third-class railways," as they are called in Germany. Again, the storage of power, such as that of the tidal wave, with cheap and ready means for giving it out when and where it is needed, offers a wide field for invention, and may lead to the most fruitful results. The transmission of power to long distances, whether by electricity, compressed air, or otherwise, is a somewhat similar problem, which at present occupies the attention of many engineers and men of science. Lastly, the more homely subject of house-building offers at this

moment special inducements to constructive genius. If houses could be built, by the use of iron or otherwise, at, say, half their present cost, the problem of sheltering our poor would be solved; unsafe and ruinous tenements would disappear, and a demand would set in for building materials and labour such as the world has never known.

Here, however, the question arises, Supposing that science and art should combine successfully for any such purpose, is it in England that the development will take shape?

At the time of the last industrial epoch, that of the introduction of railways, it would have been safe to prophesy that this would be the case. It is by no means so certain now. As regards cheap transport, for instance, the most promising recent invention in this field, viz. the caustic soda condenser previously described by us, was brought out in Germany. Other improvements in the same field, such as the portable railways of De Cauville, the rack railway of Rigenbach, the cable tramway of Hallidie, the fireless engine of Franco, the iron sleepers which are rapidly becoming universal in Germany, have all taken their rise either on the Continent or in America. The storage of power, in its only practical form, that of the secondary battery, owes its origin to Planté and Faure. The transmission of power is being worked out by Siemens in Berlin, and by Deprez and Tresca in Paris. Lastly, as to building, no one can travel abroad without seeing that as regards scientific architecture, England stands far nearer the bottom than the top in the scale of civilised nations.

What is the reason of this? Why is England thus lagging behind in the race? The answer is not far to seek. In America, in France, above all in Germany, the union between science and art is far more close and cordial than with us. Every practical constructor or manufacturer is anxious to know all he can of science, every scientific professor desires to mix practice with his theory. Thus on the one hand we find ordinary engineers drawing on all the resources of mathematics for the solution of such problems as the proper section of rails or the resistance of trains; on the other hand we see Clausius, perhaps the greatest of German physicists, devoting two long papers to investigate the working theory of the dynamo machine. But a concrete instance will make our meaning clearer. Within the last few days we have inspected a safety lamp, of which some thousands have already been sold for the German mines. It has many points of excellence, but we need only dwell upon one. It is well known to be most important that a miner's lamp should be locked in such a way that he cannot, if he will, open it; and it has been found very difficult to provide any simple kind of lock which it is beyond the resources of a clever workman to tamper with. In this lamp the difficulty is got over by making the upper part screw into the lower, while inside the lamp there is a catch or pawl, which, as in a common ratchet, prevents the screw from being turned the opposite way. Hence, that the lamp may be unscrewed, the pawl must be drawn out of place. In the overseer's office this can be accomplished by means of a powerful horse-shoe magnet. The pawl has a tail, which is attracted by the magnet when the latter is placed in contact with the side of the lamp. The tail moving towards the magnet, the pawl moves in the opposite

direction, and so allows the upper part of the lamp to be unscrewed, while the lower is held as if in a vice by the same magnetic power.

Now here we have a simple and beautiful contrivance for effecting an important practical object. It is merely the application of a well-known scientific principle to solve a special problem in construction; but it never could have been invented except by one to whom the resources of science and the needs of art were equally familiar—who was at once a physicist and an engineer. Now it cannot be questioned that in England we can boast many of the highest authorities in science, many men of the highest skill in practical construction; but the union of the two is comparatively rare, and yet it is this very union—the application of the scientific spirit to the things of common life, as so well illustrated in the excellent paper by Prof. Newcomb, published elsewhere—which is the vital necessity of the age.

The fault is not all on one side. Science sometimes looks down on Practice as a rough, prosperous mechanic, interested in nothing but his work and his wages, while Practice sneers at Science as a fine gentleman, too much absorbed in crotchets to be worth any attention or respect, and who, if he had not some one to look after him, would shortly be in the workhouse.

As an instance we may take the magnetic balance lately described by Prof. Hughes. This beautiful instrument promises at least to supply a want long felt by the makers and users of iron—the want of some method of “mechanical analysis”—some means of determining the physical and chemical properties of a given material—without testing it to destruction, as is now unavoidable. But whilst thus appealing on the one hand to manufacturers, the invention appealed on the other hand to electricians, as offering a ready index of the magnetic qualities of a metal. By the latter it has been welcomed, and is being used, as, for instance, by Mr. Preece, for the testing of telegraph-wire; but, so far as we know, not a single manufacturer or engineer has thought it worth while to encounter the small amount of trouble and expense which would be needed to test thoroughly the capabilities of the instrument in determining the mechanical properties of finished iron or steel.

We by no means wish to imply that no progress is being made in the direction here pointed out. The work undertaken by the City and Guilds Institute, the foundation of scientific colleges, such as those at Birmingham, Sheffield, Leeds, Nottingham, and elsewhere, the appointment of a Committee on Technical Education, the delivery of scientific lectures at the Institution of Civil Engineers—these are all signs that the gap existing between art and science is at last recognised, and that endeavours are being made to draw them together. Moreover, the old “rule-of-thumb” engineer is rapidly passing away, and a new generation is springing up, who, if they do not possess much science themselves, are at least alive to its value. The testing machine, for instance, is becoming a recognised institution in large workshops, where not many years ago it would have been scouted as absurd. In the skilful hands of a practical engineer, Mr. Wicksteed of Leeds, it has been made to record its own variations of stress by a self-drawn diagram, and this record seems likely to throw fresh and unexpected light on the physical

problems of extension and rupture. The same gentleman has both discovered and applied a new and most remarkable phenomenon in friction; the fact, namely, that if we give a rotary motion to a body which is in contact with another, not only is the friction diminished in the direction of motion, but the friction in the perpendicular direction is also diminished, apparently in at least an equal degree. Hence, for instance, by rotating the leather packing of an hydraulic ram, it becomes quite free to move in its cylinder in obedience to a difference in pressure on one side or the other. Here we have, once more, science helping art, and art in return throwing light upon the path of science.

These facts, and others like them, are encouraging signs, but we must repeat that something more than signs is needed. The work must be not only begun but finished, the bonds of union must be drawn close, and that quickly, or England will find that it is too late, and that she is once more ready to do the work of the world just when the world has left her no work to do.

#### FORSTER'S "STRATA OF THE NORTH OF ENGLAND"

*A Treatise on a Section of the Strata from Newcastle to Cross Fell.* By Westgarth Forster. Third Edition, revised and corrected to the present time by the Rev. W. Nall, M.A., with Memoir. 8vo. (Newcastle-upon-Tyne, 1883.)

THE position of Forster's "Strata" among the classics of geological literature in England is so well defined that a reissue would be welcome to many readers, as although the progress both of coal and metal mining during the long interval that has elapsed since the appearance of the last edition in 1821 has done much to supplement, and in some instances modify, the author's evidence, it must ever remain as a splendid monument of geological investigation as carried on in the earlier years of the century. Unfortunately, in the present issue the editor has carried out his duties in a very thorough-going fashion; to use his own words, "Some alterations have been made in this edition of the 'Strata.' Parts I. and II. have been revised and rearranged; Part III. has been partially recast; some of the old sections have been extended, and other sections have been given; obsolete matter has been expunged, and new matter in the form of notes has been added."

If the editing had been confined to the last-mentioned additions, or rather if all the alterations had been supplied as footnotes or in the form of appendixes, such a course would have been perfectly justifiable, and the value of the text would have been enhanced; but from the course adopted of shifting the original text backwards and forwards to bring it into harmony with more modern views, and rearranging the sections even to the extent of renumbering the beds of limestone in the lead-measures, and the intercalation of new subdivisions in the limestone series not contained in the original, the work has become so strangely metamorphosed that any one taking it for what it professes to be, namely, Westgarth Forster's "Strata," will be liable to be strangely misled, unless he carefully compares it with the original text. This is much to be regretted, as the editor's work has evidently been a labour of love, and it is strange that he should have so ill-used his favourite volume.

The editor has, however, done one good service deserving grateful mention by supplying a memoir of the author, which is, however, eccentrically interpolated between the original table of contents and the text. From this we gather many interesting particulars of the life of one who may be regarded as the prototype of the Sopwiths, Bewicks, and other mining engineers in the north of England, who have become famous not only in their original districts, but in all parts of Europe and America. It is somewhat surprising to learn how in the year 1807 the material for the first edition of the "Strata" was collected by Forster, who for that purpose resigned the agency of the Allendale lead mines. The volume was issued in 1809 in the same year with William Smith's first geological map of England, and at once became exceedingly popular; and thenceforward the author was recognised as one of the leading men in his profession, and was fully engaged in many surveys until his retirement in 1833. During this active period of twenty-three years he worked in nearly all the mineral districts of England and Wales, with the exception of Cornwall and Devon, and also visited Spain and North America. The American trip was made in 1831, in pre-steamboat days, in the fine packet-ship *Napoleon*, making a fairly good voyage of thirty-two days across the Atlantic. The districts visited were Pottsville and Mauch Chunk, in the anthracite district of Pennsylvania, which had then been discovered only eight years, and the Phoenix Copper Mines in Connecticut.

The later years of his life were clouded by misfortunes due to losses in working some lead mines in Wales, and before the spring of 1829 he had spent nearly all that he possessed in abortive trials, at a period of extreme depression in the lead trade. In 1833-34 failing health led him to retire from active work, and on November 9, 1835, he died at Garrigill, in Cumberland, in his sixty-third year. In the author's words, Forster rendered valuable service to the sciences of mining and geology, and for that service, if for no other reason, his name will continue to be remembered for a long time to come. H. B.

#### OUR BOOK SHELF

*A Manual of Chemistry.* By Henry Watts, B.A. (London: Churchill, 1883.)

THIS work is stated by the author to be intended for a student commencing the study of chemistry, and, as he states in his preface, this volume commences with a short sketch of the more important elementary bodies, the principal laws of chemical combination, and the representation of the constitution and reaction of bodies by symbolic notation. In addition to this there is a large section on chemical physics, including the mechanical properties of gases and the chief phenomena of heat, light, magnetism, &c. For an elementary work, as intended by the author, it is somewhat dense, and would be certainly apt to frighten a beginner in chemistry. The sections on physics alone, comprising Part I., occupy very nearly 150 pages, and within this narrow space we find that in the domain of light we have refraction, reflection, circular polarisation, &c., treated at considerable length. In magnetism and electricity we have a very complete and exceedingly condensed mass of information, certainly much too complete and condensed for an elementary text-book. In the purely chemical section, forming Part II., the work is extended so as to include a considerable chapter on crystals and the more recent extensions of the atomic theory, and also to the so-called rare metals,

which we find treated at considerable length. As to the arrangement of the chemical part, the method adopted in "Miller's Chemistry" of arranging the elements under the terms metals of the alkaline earths, &c., has been adopted, which is a very excellent method of arrangement for teaching purposes, as it allows of elements with similar properties being compared. There is evidently throughout the whole of the book a tendency to condense far too much into a small space. It would be an exceedingly difficult book indeed to be put before an *absolute* beginner. The explanatory part is reduced apparently as much as possible, although a great many facts are crammed in, certainly in good order; but still a beginner requires very much more explanation of facts than is to be found in this book. On that account, and being more an epitome of facts than explanations, especially in the chemical portion, it is scarcely possible to criticise it. The arrangement is very excellent and the details are well up to date. We notice that ozone has been put in in the form of an addendum: surely its position is closely in connection with oxygen. It is very liable in this position to be overlooked, or at any rate neglected, by a student. As there is such a considerable amount of attention given to the rare metals, especially vanadium, many of its compounds being detailed, it is somewhat surprising that davyum, though perhaps not yet absolutely settled, is not mentioned along with them. On looking carefully through the book, a number of points occur in which more explanation, or even an explanation of formulæ, would be very advantageous; but on the whole Mr. Watts is to be complimented on having produced a very complete, though certainly not quite elementary, manual on the science.

*Arithmetical Chemistry.* By C. J. Woodward, Birmingham and Midland Institute. (London: Simpkin, Marshall, and Co., 1884.)

THIS is almost a book of questions selected from the Cambridge and Oxford Local, University of London, Science and Art Department, and other examination papers. It is divided into headings on laboratory calculations, where, after an example of a volumetric or gravimetric analysis, a number of exercises and questions follows, and gas analysis with corrections of gases for pressure, &c., and determinations of vapour densities, specific and atomic volume, specific heat, calorific power, calorific intensity, kinetic theory of gases, and diffusion. The explanations are in most cases short and to the point, but the immense number of examples and exercises given tend to make it a "getting-up" book for examinations rather than a book to work with in the laboratory.

*Experimental Chemistry.* By J. Emerson Reynolds. Part III. (London: Longmans, Green, and Co., 1884.)

PROF. REYNOLDS, in the first and second parts of this little work, has departed somewhat from the usual method adopted in chemical books for junior students. The first and second parts deal entirely with the non-metals and their compounds, acids, &c.; while the third part is devoted to metals. It is divided into numbered experiments for the student to perform in rotation, and should be exceedingly valuable to medical and other students who have only a short time at disposal for practical chemistry. There is no attempt at systematic analysis, but the experiments are sufficiently logically arranged to enable a student who gives his attention to them to be able to perform any simple qualitative analysis. At the same time each experiment is very fully explained, and the reactions expressed in most cases with equations. Part III. is supplemented by a series of analytical tables at the end, which, however, are not very clear. They are certainly somewhat too complex for the class of student for which the book is intended. On the whole, however, it is a very excellent work.

## LETTERS TO THE EDITOR

[The Editor does not hold himself responsible for opinions expressed by his correspondents. Neither can he undertake to return, or to correspond with the writers of, rejected manuscripts. No notice is taken of anonymous communications.]

[The Editor urgently requests correspondents to keep their letters as short as possible. The pressure on his space is so great that it is impossible otherwise to insure the appearance even of communications containing interesting and novel facts.]

### Reply to Mr. Grubb's Criticisms on the Equatorial Coudé of the Paris Observatory

I HAVE just received the last number of the *Scientific Transactions of the Royal Society of Dublin*, containing a description of an instrument analogous to the equatorial constructed on a principle which I published in 1871 in the *Comptes Rendus*. Since it seems to me indispensable after I have studied Mr. Grubb's memoir to reply to it publicly, I beg you to insert this note in NATURE. In order to give greater importance to the modifications imagined by himself, the author, Mr. Grubb, submits the instrument imagined by me to a very severe criticism, and attributes very severe defects to it. There is no doubt that there is a considerable difference between the instruments in question. One of them, in fact, as experiments carried on during two years have proved, lends itself to the execution of all possible astronomical researches under the best possible conditions for securing precision, while the other, according to the description given in the publication above cited, renders impossible a very great part of the researches to which an equatorial is specially destined. Further on I shall insist on this difference, but I wish first of all to reply to Mr. Grubb's objections and to show that they are in all points contrary to the fact.

To give weight to his argument Mr. Grubb examines a case of the construction of an instrument of 27 inches aperture, and he anticipates in the construction the following difficulties, which he considers insurmountable:—(1) The optical difficulty of constructing a large plane mirror. (2) The practical difficulty of procuring a disk of the necessary dimensions. Mr. Grubb affirms that there is no glass-works capable of making a disk of glass so large. (3) The difficulty of moving a mirror of which the weight, according to Mr. Grubb's calculations, will be very nearly half a ton. (4) The dearth of the instrument, which would cost more than an ordinary equatorial, plus dome and observatory.

I will discuss these points one by one. (1) The construction of plane mirrors is a settled question nowadays. Many astronomers have been able to convince themselves that in the equatorial coudé of 11 inches aperture the introduction of a plane mirror of 16 inches in no way marred the definition. The brothers Henry, who constructed this mirror, have just made another of 40 inches diameter, which leaves absolutely nothing to be desired in this respect. This difficulty, moreover, is so little felt or feared by our opticians that the price of a similar mirror for an instrument coudé is only about a quarter of the price of an object-glass, in spite of the great difference of their respective surfaces. Thus, for an object-glass of 27 inches, the price of which is 70,000 francs, that of a plane mirror of 38 inches is 18,000 francs. For an object-glass of 40 inches, price 200,000 francs, the corresponding mirror of 58 inches only costs 40,000 francs. I admit, nevertheless, that in this respect Mr. Grubb may have had apprehensions. In the past, in fact, serious difficulties have been met with in the production of plane mirrors, but my own personal experience has enabled me to realise the real cause of this want of success. Up to the present time, to satisfy preconceived ideas it was believed that to establish rapidly an equilibrium of temperature it was necessary that the thickness of the mirror should be small. Then, under the influence of a tightening, however slight, or only a flexion, the mirrors were deformed unequally, and consequently produced an obvious alteration in the beauty of the images. The brothers Henry, studying the same question by different processes, have arrived at the same conclusions. In giving to the disk a sufficient thickness, the production of a plane surface is not more difficult than any optical surface whatever. The means of verification are so delicate that in a mirror of 40 inches diameter an error of 1/50,000 of a millimetre can easily be determined and eliminated. So if there be a sphericity in the mirror, the radius of curvature will have at least 1600 leagues, that is to say, about

the radius of curvature of a bath of mercury, and in taking still greater pains it will be possible to go further and to reach an exactitude such that the radius of curvature might be twice as great. Under these conditions it is not possible, as one can readily see, that there can be any appreciable imperfection. The problem is therefore solved, as I said above.

(2) The impossibility of finding glass-works capable of furnishing large disks for mirrors, pointed out by Mr. Grubb, does not exist. We have in reserve at the Observatory a disk for a plane mirror of 1'22 m. diameter, weighing 650 kilos. The mirror just finished by the brothers Henry has a diameter of 40 inches, with a thickness of '17 m.; this weighs 380 kilos. The glass-works of St. Gobain are prepared to furnish blocks weighing a ton, the diameter 58 inches, to anybody who will order them.

(3) The third point in Mr. Grubb's criticism has arisen from some error in calculation. Mr. Grubb makes me say that it is necessary to give the mirror a thickness equal to 1/5 of the diameter, and then making some calculations with this false datum, he finds that the mirror necessary for an equatorial coude of 27 inches would weigh 83 tonnes, and it is this result that misleads him. Here are the facts. I have never said that the thickness should be '18 of the diameter. I have given '18 as a *maximum*. Allow me to quote textually what I have said (*Journal de Physique*, August 1883): "Des recherches effectuées avec des miroirs de 0'08 m. m'ont démontré que pour prévenir dans un miroir toute déformation causée par la flexion ou un léger serrage, il faut que l'épaisseur du verre soit 0'18 du diamètre. Peut être avec des miroirs plus grands sera-t-il possible de réduire notablement cette épaisseur; en tout cas, la fraction 0'18 doit être considérée comme un maximum."

In my equatorial coude for example, the mirror has a thickness equivalent to 1/6 of the diameter. In taking 1/7 for a mirror of 38 inches destined for an object-glass of 27 inches, one has still nothing to fear, for its weight would scarcely reach 250 kilos., that is to say, the half of the weight indicated by Mr. Grubb. For an instrument which weighs already between 8 and 9 tonnes, this addition of 250 kilos., or of 280 kilos. if we adopt the proportion of 1/6, is so small as not to be worth mentioning. From a mechanical point of view the displacement of the cylinder carrying mirrors of 250 kilos., or even a tonne, considering both the movement and the stability of the installation, does not offer the least difficulty. It is a mechanical problem so elementary that not only the first-class artists of all countries but even ordinary constructors would be able to solve it without any great effort of intelligence. I am only astonished that a man of Mr. Grubb's reputation should have stopped to consider such a detail.

(4) We now come to the question of expense. I am curious to know whence Mr. Grubb could have got his information, because it differs so absolutely from the facts. In spite of the addition of two supplementary mirrors, the price of the new instrument is less, or at all events not greater, than an ordinary one. The simplicity of the construction is such that the saving in the mechanical part covers the expense of the optical one. As I have already pointed out in the *Comptes Rendus* in 1871 and 1873, and in the *Journal de Physique* already quoted, the considerable expense of rotating domes, &c., is entirely avoided. I am greatly astonished, therefore, that Mr. Grubb makes on this point, so thoroughly studied, an objection so little founded. If he had, moreover, looked at the drawing which I published in the *Journal de Physique* of last year, he would have seen that it is almost identical with that which he has communicated to the Dublin Society, so far as the general arrangements for sheltering the observer and instrument are concerned. M. Gautier has been good enough to furnish me with the prices.

Dimensions Inches	Ordinary Equatorial Francs	Equatorial Coude Francs
12	48,000	44,000
18	81,000	79,000
27	183,000	183,000

These prices are for instruments of the most complete kind.

The objects which I wished to attain were (1) to realise an instrument more stable than the ordinary ones, and to render possible the measurement of large angular distances; (2) to establish an arrangement which permits the astronomer to explore the whole sky and to regulate himself, with the most perfect convenience, all the movements of his apparatus; (3) to avoid the necessity of those monumental domes, of which both the building and the movement are always so costly; (4) to realise an instrument which, in spite of the introduc-

tion of two supplementary mirrors, would be optically more perfect. Indeed, being able to give the telescope a much greater focal distance than in the common large instruments, the achromatism may be rendered more perfect. I believe that I have succeeded in satisfying these various conditions, and that I can appeal to the judgment of several of the most eminent astronomers who have studied the instrument. Mr. Grubb makes a last reproach rather curiously. He is astonished that I have not as once applied the new system to the construction of a large instrument, for he adds, "No one finds any difficulty in working an equatorial of 11 inches." I do not know whether this opinion of Mr. Grubb is based on his personal experience, but I do know that all astronomers do not share his optimism on this point. To cite only one instance. In all the observatories where the discovery of comets or small planets is in question, telescopes of 6 or 7 inches aperture at the outside are employed. Continued work of this kind with a larger instrument is accompanied with fatigue. Now in my instrument, whatever be the nature of the research, a precious economy of time and energy is secured. If we have not in Paris a larger telescope on my plan, I must say that my regret is greater than that of Mr. Grubb, and that the lack of it does not depend on me.

In a subsequent letter I propose to discuss Mr. Grubb's counter proposal.

M. LAWY

Paris Observatory, April 10

### On the Motion of Projectiles

EXPERIMENTS made in 1866 showed that the resistance of the air to the motion of projectiles varied only slightly for such forms of heads as were likely to be used in practice, and that it was of no importance whether the apex of the shot was pointed or rounded off.

From what I have said (*NATURE*, vol. xxix. p. 527) it is evident that before we can calculate the trajectory of shot we must know something of the quality of the gun from which the shot is supposed to be fired. For if trajectories of shot fired from the experimental guns were calculated by the use of the tabular values of  $K_v$ , it is plain that the calculated ranges would err in excess for the 3-, 7-, and 9-inch guns, and in defect for the 5-inch gun. As Mr. Ristori, using tabular coefficients, finds his calculated less than his experimental range, it may be that his gun gave a degree of steadiness above the average, as the 5-inch gun did. It is also necessary to be correctly informed of the exact *initial direction* taken by the shot, because, owing to the recoil of the gun, there is a "jump," which gives a greater elevation to the direction taken by the shot than the elevation of the axis of the gun. It is also a difficult matter to obtain the correct *initial velocity* of a small-arm bullet. For I am assured on the highest authority that the cotton threads of which my screens are composed, would be likely to cause unsteadiness in the motion of a small bullet, and if so, the measured velocity would be lower than the velocity of the undisturbed bullet. And if wire screens were used, the evil would be increased. From the excellent work done by Robins with a *small* ballistic pendulum, I am disposed to think that that instrument might be advantageously used in experiments with *small-arm* bullets.

As my tabular values of  $K_v$  were determined from the average results given by 3- to 9-inch shot, I did not venture to put them forward as being applicable to the calculation of the motion of small bullets. But recently Major McClintock, R.A., Assistant Superintendent Royal Small-Arms Factory, has used them for that purpose. He says:—"The accuracy of rifle-bullet trajectories calculated by means of Prof. Bashforth's tables, has been tested by firing a large number of rounds through paper screens placed at different points along the range. The rifle used in the experiment was the Martini-Henry, and the screens were erected at intervals along a 500-yards and a 1000-yards range. The result of the experiment was most satisfactory, the mean heights of the bullet-holes in the screens agreeing closely with the heights found by calculation."

As is well known, guns vary greatly in the degree of steadiness they impart to elongated shot, and this often changes with the initial velocity of the shot. It is important, therefore, to have a ready way of changing the tabular coefficients  $K_v$  in the ratio of 1 :  $\kappa$ , when the coefficients will become  $\kappa K_v$ , where  $\kappa$  is a constant for that round. In the calculation of the general tables, and in using the tables of values of integrals denoted by X, Y, and T, we have to deal with the product  $\frac{a^2}{v} \times (\kappa K_v) =$

$\left(\frac{d^2}{w} \kappa\right) \times K_v$ . Hence, if we calculate the value of  $\left(\frac{d^2}{w} \kappa\right)$  at first, we may proceed without further change to use the general tables, or to calculate trajectories, using the tabular values of  $K_v$ , just as when no change is required in the value of the tabulated coefficients. For the 3-, 5-, 7-, and 9-inch guns, the value of  $\kappa$ , in the cases we have considered, would be 1.08, 0.92, 1.05, and 1.08 respectively. There was one case where the studs did not act, when  $K_{980}$  was found to be 335.1 instead of 75.0, which gives  $\kappa = 4.47$ . The smaller the value of  $\kappa$  the steadier will be the motion of the shot. Mr. Ristori might calculate another range, using  $\kappa = 0.92$  given by the 5-inch gun, if he be satisfied that he has got the correct initial velocity and initial direction of the shot. If the calculated and measured ranges did not now quite agree, the remaining correction of  $\kappa$  might be found perhaps with sufficient accuracy by proportional parts. This seems to be the best way of expressing the degree of steadiness of shot when they are so light as to have their motion disturbed by cutting the threads of screens. But for heavy shot the most direct way is to fire through equidistant screens as already explained.

When I made experiments with low velocities in 1879, I was furnished with some range tables of the 6.3-inch Howitzer, where, it was said, my coefficients did not give correct results. As the difficulty in obtaining good results increases as the velocity decreases, I took the trouble to make a thorough comparison between the calculated and experimental results in the above case. I also made use of some German range tables in the same way, where the value of  $d^2 \div w$  was only a trifle larger. The results of these comparisons may be found at pp. 45-49 of my Final Report, 1880, which appear to me quite satisfactory.

So long as there are guns good, bad, and indifferent, it is clear that no single set of coefficients can give ranges suited to all cases. But ranges, &c., calculated by the help of my coefficients, may serve as a standard of comparison applicable to every case, and so give a measure of the steadiness of the shot.

April 23

FRANCIS BASHFORTH

### The Dry and Wet Bulb Thermometers "Froude"

A SO-CALLED thermometer "froude" has been used in France for many years, and its use, on special occasions, has gradually extended to other countries. It consists of an ordinary thermometer fastened to a string two to four feet in length. If such a thermometer be swung through a circle whose radius is the length of the string, it is evident that it will attain the temperature of a large mass of air unless the results are vitiated by friction with the air, oxidation, centrifugal action, or other causes. Careful comparisons, at high and low velocities, with a thermometer properly exposed, have given entirely reliable results.

Some time ago the writer attempted to use this instrument as a wet bulb with such results that it was decided to fasten two thermometers together, one with its bulb one and a half inches below the other. The latter may be easily wet by immersion without wetting the dry. This arrangement has worked admirably, and has been in constant use the past winter in determining temperature and humidity conditions both in city and country, in courts and rooms. Every one who has undertaken humidity observations with a wet bulb thermometer, especially in cold calm weather, has found it very difficult to obtain good results even after an hour's waiting after wetting. With this instrument it is an easy matter in every instance to obtain an absolutely correct result in two or three minutes. This is shown by the fact that repeated wetting and swinging will give the same result as often as tried. If ice is on the bulb, it is best, after swinging for several observations, or until the clear glare of ice has gone, to wet in water above freezing so as to remove the old ice and form a new coat. Distilled water should also be used if possible.

With this instrument it has been found that, in order to get even approximate results of humidity above grass ground, in clear calm weather, with temperature below freezing, the observation must be made upon a knoll, never in a valley or upon a plain with rising ground on any side. It has also been found that under the above conditions in the morning a height of twenty to thirty feet is essential, even upon a knoll, in order to obviate the effect of the gradual accumulation through the night of damp air above sod.

April 14

H. A. HAZEN

### Extraordinary Darkness at Midday

THE extraordinary darkness that occurred here suddenly on the morning of the 26th is deserving of record, as being the most intense that is remembered by any of the inhabitants.

The early morning was bright, and no change was noticed until close upon 11 a.m., when the sky became rapidly darker in the west-south-west. The wind was blowing from the north-east at 11 a.m. with a velocity of five miles an hour, and it scarcely changed at 11.40, when it increased to seven miles an hour, and veered at once to south-west, and then moved more slowly round through west and north, back again to east at 1 p.m., when its velocity was only three miles an hour.

At 11.30 the darkness was so great that it was found impossible to read even bold print (small pica) close by the window, and at this time a dense black cloud with a slightly yellowish tinge hung over the south-west sky; the blackness being most intense at 10° above the horizon. At 11.35 it became somewhat lighter, and at 11.40 the rain began to fall, and in forty minutes 0.114 inch of rain-water was collected in our rain-gauges, the whole being almost as black as ink, and full of fine carbon in suspension. Hail that fell a mile off to the south-west by south, and both hail and snow that fell on the hills two miles to the west, were also black. At Preston, fourteen miles to the south-west, the darkness was very marked, but five and a half miles to the north-east nothing very particular was noted.

Stonyhurst Observatory, April 28

S. J. PERRY

### Intelligence in Animals

I THINK it was about the year 1844 that the Duke of Argyll desired my late father, his factor, to preserve game in the district of Kintyre, Argyllshire. If any steps in this direction had been taken by other proprietors, they were very irregular. My memory goes back to about 1846 and 1848, and at that time the grouse of Kintyre "sat like stones"—they might be shot to dogs from the first to the last day of the season; in fact it was often difficult to get the birds up. With this preservation, grouse increased enormously—and therefore the food supply of the people—to such an extent that the late Sir John Cunningham and my father shot, on one 12th of August, seventy-two brace of grouse. Sir John was a very old man, and insisted on loading his own gun, an old muzzle-loader. My father never shot hard. Now I do not believe any two men with two guns and loaders could do this in the same district with all the improvements in arms and dogs; whilst I have heard my father say that seven brace was a good bag when he was young, before game-preserving.

Grouse yet sit pretty well in Kintyre, and I believe this is the case because it was one of the last districts to preserve and shoot; but the birds are every year becoming wilder, and now in the month of September it is useless to take dogs on the hill, and for two years we, like others, have had to drive them.

I account for this by an alteration in instinct, and I am as sure as any one can be, from observation and the opinion of competent persons, that it is *progressive instinct in successive generations*. Formerly the great enemies of the grouse were ravens, that took their eggs and young birds; foxes, polecats or martin cats, and wild cats, that took them at night on the ground; and hawks, that took them on the wing during the day. When man stepped in and altered the balance of Nature, the

Bird that up and flew away,  
He lived to breed another day.

No hawk was there to knock him down. He found from experience that flying away before man and his dog came near gave him safety; and his children that inherited the wit or instinct or power of turning heather into nerve-force or intelligent thought—or whatever the straw-splitters like to call it—lived; whilst his brother, that inherited the qualities which kept him hiding in the heather, was shot when forced up.

I had this summer ample corroboration of this theory. About eight years ago I was shooting in the island of Rum; the grouse were not preserved and were extremely tame, so tame in September and October that I had to run after them to make them take the wing, and it was new to dogs. Last year I again shot in the island, and I observed the same tameness in one part of the island, but in another district I observed the grouse were larger, darker, and much wilder. I was puzzled with this until I found out that the late tenant had three years before turned down some English grouse, and in the district where they were so turned down the grouse were very wild.

Knockrioch, April 28

DUNCAN STEWART

IN NATURE (vol. xxix. p. 596) there is a letter signed James Graves, in which he says, "as to the magpie or any other bird being able to fix dates exactly to the day, it is unproved and incredible." I do not know what may be the case in regard to birds-nestbuilding, but I can give two instances of the regularity with which birds arrive at certain localities *en route* northward, whatever may be the state of the weather. During a ten years' residence on the shores of Hudson's Bay, the first Canada goose of the spring migration was seen and generally shot on April 23. At Toronto on Lake Ontario, large flocks of a pretty little plover called the "black-heart," from a black patch on its breast, pass along the islands, flying northward, on St. George's Day (April 23), and are seldom or never seen even a day before or a day after that date. The poor little birds have a sad time of it for six or eight hours, as a number of sportsmen go out for the occasion and knock them down by the half-dozen or more at every shot. In this case, as in the other, wind and weather appear to cause no difference

JOHN RAE

4, Addison Gardens, April 25

THE ABSORPTION OF WATER BY PLANTS

AN ingenious instrument has lately been described by Dr. J. W. Moll (*Archives Neerlandaises*, i. xviii.) under the name of the Potometer. It is a modification of Sachs' apparatus for determining the amount of water which a cut branch absorbs in a given time. I have been for some years in the habit of using a form of Sachs' instrument, differing in principle from Moll's apparatus, but resembling it in being especially adapted for making observations at short intervals of time. As the subject of transmission of water through wood is now attracting attention among physiologists, it seems worth while to describe my instrument.

A short piece of thick indiarubber tube is slipped over the cut end of a branch and firmly attached to it by wire ties; the other end of the rubber tube being securely fitted to a glass tube which is filled with water. The other end of the glass tube is closed by an indiarubber cork through which passes a coarse thermometer tube. The apparatus is now fixed so that the free end of the thermometer tube dips into water. As the leaves evaporate the water in the glass tube is sucked up by the cut end of the branch, the loss being constantly made up by a current flowing in through the thermometer tube. If then we can estimate the rate of this current we shall know the rate of absorption of water. This is very simply done by allowing, for a few seconds, the thermometer tube to suck in air instead of water; when a column of air a few millimetres in length has been drawn in, the end of the tube is again immersed in water, and the bubble travels rapidly along the thermometer tube, when its speed is measured by means of a chronograph.

This method appears no doubt to be a rough one, and is open to objections; but I believe that it does not give rise to serious errors, and it certainly demonstrates extremely well small changes in the rate of absorption by a cut end of the branch. By means of my instrument observations can be made at very short intervals; for instance, four readings were taken in 1' 50"; it is therefore well adapted for observing rapid changes in the rate of absorption.

I reserve a full discussion of the merits and demerits of the instrument for a later publication.

*Experiments, April 1884.*—When a branch is first fitted to the instrument the rate of absorption is extremely rapid, owing to causes which need not here be considered, but after a time the rate of absorption (which diminishes with great rapidity) becomes constant. A branch of Portugal laurel (*Cerasus lusitanica*) was cut at 9.30 a.m., and was not fitted to the apparatus until 10.15 a.m.

The following table shows clearly the rapid decrease in the rate of absorption:—<sup>1</sup>

Times	h.	m.	Rate of Absorption
10	18	...	71
	20	...	53
	25	...	40
11	14	...	26
	35	...	25
	52	...	25

Sachs has called attention to the diminution in the absorption which occurs when cut branches are placed in water, and has shown that the absorbing power can be renovated by cutting a fresh surface at the base of the branch. This effect is well shown with my instrument.\*

The above-mentioned branch of Portugal laurel which had been placed in water at 9.30 a.m. gave a relative rate of absorption of twenty-four at 12.28; at 12.30, between 6 and 7 cm. were cut off, and the branch was again fitted to the machine, the operation lasting one and a half minutes.

Time p.m.	h.	m.	Rate of Absorption
12	28	...	24
	30	...	fresh surface cut
	31½	...	branch replaced
	33	...	35
	35	...	30
	39	...	28
	45	...	26
	54	...	26

When the rate of absorption has become constant, any variation in dampness or dryness of the air causes variations in the transpiration of the leaves, and therefore in the rate of absorption. These changes are well shown by my instrument. The following experiment, made with a branch of Portugal laurel shows the amount and rapidity of the increase in absorption caused by exposing the leaves to the sun shining through window-glass:—

Time a.m.	h.	m.	Rate of Absorption
10	44	...	14
	49	...	14
	55	...	14
11	0	...	15
	5	...	15
	6½	...	14
		blind drawn up	
	7½?	...	14
	9	...	20
	12½	...	27

Thus in six minutes the rate of absorption had nearly doubled. A similarly rapid effect is seen when the sunlight is cut off, when the rate of absorption falls.

Time	h.	m.	Rate of Absorption
12	5	...	33
	10	...	32
	10½	...	blind down
	12½	...	27
	19½	...	20
	25	...	19
	29	...	18

That is, the rate of absorption diminished in the proportion of 100:56 in twenty-four minutes, when the sunlight was cut off. In the same way the effect of opening a window and thus increasing the evaporation for the leaves, is a once visible in increased rate of movement in the bubble.

Time a.m.	h.	m.	s.	Rate of Absorption
10	33	0	...	32
11	0	0	...	31
	9	0	...	window and door opened
	10	40	...	34
	11	30	...	37
	12	0	...	37
	18	0	...	33
	19	0	...	window and door shut
	21	30	...	31
	22	30	...	29
	40	...	...	31

<sup>1</sup> In this and the following tables I have not given the actual quantities of water absorbed, merely the relative rates of absorption.

\* It need not here be discussed whether the particular phenomena here described is the same as that described by Sachs.



**Effect of Disturbance.**—The fact observed by Baranetzky, that a small disturbance, such as a slight shake, increases the transpiration of the leaves, is also easily seen, and my observations show that in some cases the effect may be very transitory. It need not occur in the use of my instrument, since the plant remains quite untouched, the only necessary movement being the removal and replacement of a vessel of water to allow the entrance of a bubble.

**Effect of Sudden Diminution of the Evaporating Surface.**—I have been astonished to find with what rapidity the rate of absorption diminishes when the evaporating surface is diminished by cutting off a twig from the branch under experiment.

A branch of Portugal laurel was absorbing (April 10) with great regularity.

Time p.m. h. m. s.	Rate of Absorption
5 5 0	23
47 0	23
48 40	a small branch cut
49 15	21
50 30	20
52 0	21
58 0	20
6 4 0	20
11 0	20
12 0	another branch cut off
20	18
13 0	17
14 40	16
26 0	16
35 0	16

When the first branch was removed nearly the whole of the permanent diminution was visible in 35"; in this case the distance from the base of the branch to the place where the small branch was severed was 28 cm.

In the second experiment half the permanent effect was produced in 20"; and here the distance of the cut-off twig from the cut end of the main branch was 45 cm.

But far more remarkable results were obtained when a long stem of ivy was used for the experiment.

A stem of ivy was removed from the tree on which it grew on April 13, and was placed with its cut end in water until the following day, when it was fitted to the apparatus.<sup>1</sup>

April 14.—The rate of absorption remained fairly constant from 10.30 to 11.45 a.m., when the first branch was removed.

Time a.m. h. m. s.	Rate of Absorption
10 33 0	32
11 42 0	31
45 0	branch cut off
15	29
46 20	23
53 0	26

The branch which had been cut off left the main stem at a distance of 13 feet 3 inches from the basal end, so that change in the rate of absorption was transmitted at the rate of 0.88 feet per second.

In a second trial the following results were obtained:—

Time h. m. s.	Rate of Absorption
3 1 0	23
6 0	23
11 30	23
13 0	stem cut
15	18
14 0	17
15 30	15
18 0	15

The point at which the stem was severed was 16 feet 5 inches from the basal end, so that here a change in

<sup>1</sup> The stem was fixed so that its distal end was some few feet above the base immersed in water.

absorption travelled at the rate of 1.1 foot per second. The same result followed on two other occasions, but here the rates of transmission were slower—

15 feet 5 inches in 30",  
9 feet 10 inches in 30".

In the latter of these two cases the part removed was not a branch of the stem, but a branch belonging to a neighbouring stem which had grown into lateral union with it, so that here the transmission of the change must have taken place laterally from the branch to the stem, and then longitudinally along the latter.

**Effect of partly severing the Branch.**—My instrument is well adapted for testing the transmitting capacity of a branch which has been partly cut through. I have been much surprised at the fact that cuts to the depth of half or more than half the diameter of the branch produce practically no diminution in the rate of absorption. Indeed a slight increase is often visible owing to the disturbance which must occur when the branch is cut with the saw.

A branch of yew .55 inch in diameter was sawn (A) to the depth of .25 inch, (B) so deep that the bridge of wood through which the water had to pass was not more than .1 inch in thickness in radial direction.

Time p.m. h. m.	Rate of Absorption
3 26	99
32	99
34	cut A made
35	98
40	103
47	101
4 3	99
37	99
38 4	cut B made
40	100
43	97
46	100
50	100

It was only when the bridge remaining after cut B was narrowed, by sawing on both sides at right angles to the former direction, that the rate of absorption fell. The same thing was shown in another branch of yew, the woody part of which was 10 mm. in diameter, and which was sawn to a depth of 8 mm., leaving a bridge 2 mm. thick in radial direction. Even this deep section did not diminish the rate of absorption. With the Portugal laurel the same thing was observed; and here the possibility of recovery from a temporary diminution in absorption was shown in two cases.

The branch with its bark on measured 11 mm. in diameter, and it was traversed by an excentric cylinder of old brown wood 1.8 mm. in diameter.

The following figures give the result of section:—

Time a.m. h. m.	Rate of Absorption
11 0	18
9	18
14	cut A
16	16
20	18
30	17
12 0	17
6	18
8-9	cut B
10	18
11	19
17	17
30	18
35	cut C
36 1/2	9
38	9
42	10
48	12
55	14
p.m.	
1 15	16

It will be seen that the two first cuts produced no effect comparable to that caused by C. Cut A was 3 mm. deep, cut B was also 3 mm. deep on the opposite side, so that, after B had been made a bridge, 5 mm. in radial direction remained; nevertheless the rate of absorption was undiminished. Cut C was made by increasing B to the depth of 5 mm. from the bark, so that the bridge of more or less central wood finally left was 3 mm. in radial thickness, and even then the diminution was only temporary. The cuts were made about 7 cm. from the basal end, and the same distance from the first branch. Another branch of Portugal laurel showed the same thing. The wood of the branch at the point of section was about a centimetre in diameter, and contained a large proportion of old brown wood. The external envelope of white wood was cut away with the exception<sup>1</sup> of a bridge measuring roughly 3 × 3·5 mm. in cross section.

The result is shown in the following table:—

Time p.m. h. m.	Rate of Absorption
1 34	15
2 13	15
16	cut
19½	10
21½	11
26	13
32	14
39	13
47	14
53	15

Here again we have a diminution followed by gradual rise.

When the little bridge of younger wood was severed, the fall in rate of absorption was rapid.

Time p.m. h. m.	Rate of Absorption
5 27	16
28½	bridge severed
32	0·12
47	0·08

Thus the absorption fell to one-twentieth of the original amount; that it did not quite cease may be accounted for by the fact that the younger circumferential wood was not completely cut through.

My apparatus would be also suitable for such experiments as those of Dufour (*Arbeiten d. Bot. Inst. in Würzburg*, 1884, Band iii.), in which he showed that sharply bending a stem, such as a hop-bind, does not prevent the passage of the water of transpiration, whereas water could not be mechanically forced through the bent stem. Dufour also repeated Hales' experiments in which the transpiring branch was cut half through on two opposite sides, the points of section being an inch or two apart. When this had been done, so that the continuity of all *cavities* of vessels and cells was broken, he found that the transpiration-stream could still pass, because the continuity of the cell-walls remained unbroken. I give a single experiment of this kind to show that my instrument is well adapted for such work (April 15):—

Time h. m.	Rate of Absorption
11 32	25
34	25
36	25
37½	first cut
39	22
49	24
55	second cut
12 2	0·84
22	0·69

Both cuts penetrated to the centre of the branch. The first was one and a half inch from the base, the second

<sup>1</sup> The young wood was not well severed, and a small amount remained in continuity.

half an inch below the first cut, and on the opposite side of the branch.

Dufour's experiments would seem to show that the great depression in absorption which occurred on making the second cut may have been only a temporary phenomenon; this and other kindred questions I hope soon to be able to work out.

FRANCIS DARWIN

Cambridge, April 17

WHAT IS A LIBERAL EDUCATION?<sup>1</sup>

I DO not intend, in the present paper, to enter upon the disputed question between the advocates of classical culture on the one hand, and those of scientific training on the other; because it seems to me that the line on which the two parties divide is not that which really divides the thought of the day. If we look closely into the case, we shall see that the objects of a higher education may be divided into three classes, instead of the two familiar ones of liberal and professional. In fact, what we commonly call a liberal education should, I think, have two separate objects. With the idea of a professional education we are all familiar: it is that which enables the possessor to pursue with advantage some wealth-producing specialty. Although, in accordance with well-known economic principles, it is designed to make the individual useful to his fellow-men, the ultimate object in view is the gaining of a livelihood by the individual himself. On the other hand, the object had in view in what is commonly known as culture is not the mere gaining of a livelihood, but the acquisition of those ideas, and the training of those powers, which conduce to the happiness of the individual. From this point of view culture may be considered an end unto itself.

The third object which we have to consider is only beginning to receive recognition in the eyes of the public. It is the general usefulness of the individual, not merely to himself and to those with whom he stands in business relations, but to society at large. Modern thought and investigation lead to the conclusion, that man himself, the institutions under which he lives, and the conditions which surround him, are subject to slow, progressive changes; and that it depends very largely on the policy of each generation of mankind whether these changes shall be in the way of improvement or retrogression. During the next fifty years all of us will have passed from the stage of active life, and the course of events will be very largely directed by men who are still unborn. The happiness of those men is, from the widest philanthropic point of view, just as important as the happiness of those who now inhabit the earth; and, in the light of modern science, we now see that that happiness depends very largely upon our own actions. We thus have opened out to us an interest and a field of solicitude in which we need the best thought of the time. The question is, What form of education and training will best fit the now rising generation for the duty of improving the condition of the generation to follow it?

Let it be understood that we are now speaking, not of the education of the masses, but of that higher education which is necessarily confined to a small minority. So far as I am aware, that fraction of the male population which receives a college education is not far from 1 per cent. To that comparatively small body we must look for the power which is to direct the society of the future, and by their acts to promote the well- or ill-being of the coming generation. Our duty to that generation is to so use and train this select body as to be of most benefit to the men of the future. What is the training required? I reply by saying that I know nothing better for this end than a wide and liberal training in the scientific spirit and the scientific method. The technicalities of science are not the first object; and, so far as they are introduced, it is only

<sup>1</sup> From *Science*.

as media through which we may imbue the mind with certain general and abstract ideas. If called upon to define the scientific spirit, I should say that it was the love of truth for its own sake. This definition carries with it the idea of a love of exactitude—the more exact we are the nearer we are to the truth. It carries with it a certain independence of authority; because, although an adherence to authoritative propositions taught us by our ancestors, and which we regard as true, may, in a certain sense, be regarded as a love of truth, yet it ought rather to be called a love of these propositions, irrespective of their truth. The lover of truth is ready to reject every previous opinion the moment he sees reason to doubt its exactness. This particular direction of the love of truth will lead its possessor to pursue truth in every direction, and especially to investigate those problems of society where the greatest additions to knowledge may be hoped for.

Scientific method we may define as simply generalised common sense. I believe it was described by Clifford as organised common sense. It differs from the method adopted by the man of business, to decide upon the best method of conducting his affairs, only in being founded on a more refined analysis of the conditions of the problem. Its necessity arises from the fact that, when men apply their powers of reason and judgment to problems above those of every-day life, they are prone to lose that sobriety of judgment and that grasp upon the conditions of the case which they show in the conduct of their own private affairs. Business offers us an example of the most effectual elimination of the unfit and of "the survival of the fittest." The man who acts upon false theories loses his money, drops out of society, and is no longer a factor in the result. But there is no such method of elimination when the interests of society at large are considered. The ignorant theoriser and speculator can continue writing long after his theories have been proved groundless, and, in any case, the question whether he is right or wrong is only one of opinion.

I ask leave to introduce an illustration of the possibilities of scientific method in the direction alluded to. Looking at the present state of knowledge, of the laws of wealth and prosperity of communities, we see a great resemblance to the scientific ideas entertained by mankind at large many centuries ago. There is the same lack of precise ideas, the same countless differences of opinion, the same mass of meaningless speculation, and the same ignorance of how to analyse the problem before us in the two cases. Two or three centuries ago the modern method of investigating nature was illustrated by Galileo, generalised by Bacon, and perfected by Newton and his contemporaries. A few fundamental ideas gained, a vast load of useless rubbish thrown away, and a little knowledge how to go to work acquired, have put a new face upon society. Look at such questions as those of the tariff and currency. It is impossible not to feel the need of some revolution of the same kind which shall lead to certain knowledge of the subject. The enormous difference of opinion which prevails shows that certain knowledge is not reached by the majority, if it is by any. We find no fundamental principles on which there is a general agreement. From what point must we view the problem in order to see our way to its solution?

I reply, from the scientific standpoint. All such political questions as those of the tariff and the currency are, in their nature, scientific questions. They are not matters of sentiment or feeling which can be decided by popular vote, but questions of fact, as effected by the mutual action and interaction of a complicated series of causes. The only way to get at the truth is to analyse these causes into their component elements, and see in what manner each acts by itself, and how that action is modified by the presence of the others: in other words, we must do what Galileo and Newton did to arrive at the truths of Nature. With this object in view, whatever our views of culture,

we may let science, scientific method, and the scientific spirit be the fundamental object in every scheme of a liberal education.

S. NEWCOMB

### THE KRAKATOA ERUPTION<sup>1</sup>

THE inquiry, instituted in consequence of a Government resolution of October 4, 1883, into the nature, the extent, and the consequences of the volcanic eruptions of Krakatoa, has led to various remarkable results of which a short account is given here. A detailed report is in course of preparation, but will not appear for some months, as the making of numerous illustrative maps and plates will take much time. The inquiry did not extend solely to the islands of the Straits of Sunda, but also to the coast countries of the Lampong districts, Bantam and Batavia, which were partly or entirely destroyed. In the Straits of Sunda the islands of Merak, Toppershoedje, Dwars in den Weg (Thwart the Way), Seboekoc, Sebesi, Lagoendi, Krakatoa, Taboean, Prince's Island, the Monnikrotsen (the Monk's Rocks), and Meeuwen Island (Mew's Island), were visited; further, the coast-strip from Ketimbang to Kalianda, and inland as far as Kesoegihan, besides the foot of the Radja Bassa; the coast of Hoeroen to Telok Betong, and the environs of the capital; the southern part of Semangka Bay (the northern part was inaccessible through pumice-stone), the kampoengs Tampang and Blimbing, near the Vlakken Hoek, Java's First Point (Java Head), and the coasts of Tjiringin and Anjer to Merak. The voyage, which lasted seventeen days, was made by the *hopperbarge* (small steamer) *Kediri*, commander 't Hoen, given for the inquiry by the temporary chief of the Batavian Harbour Works. About the causes of eruptions there is usually not much to be said, yet in this case something has been ascertained. Krakatoa, namely, lies with a few other volcanoes on a rent or fissure in the crust of the earth which runs across the Straits of Sunda, and of which I indicated the probable existence for the first time three years ago. Along such a fissure little shiftings of the earth's crust are possible, by which a pressure is exercised upon the molten substances below the crust. It is also possible that along such a rent—however tightly closed by the neighbouring stone-layers—the water may more easily than elsewhere flow to the regions under the earth. If this water comes in contact with the molten substances, steam at high temperature and high pressure is formed, and this steam may be considered as the chief motor of most, if not all, volcanic eruptions.

Many circumstances, therefore, combine to make eruptions take place in preference near fissures, provided water (either rain or sea-water) can penetrate in sufficient quantity. We must conclude from the 200 years' quietude of the volcanoes in the Straits of Sunda that the water affluence during that time was but small, and only became larger within the last years. Now it happens that during the last years a great many earthquakes took place along this fissure, of which the lighthouse on "Java's First Point" in particular suffered greatly. The most violent earthquake took place September 1, 1880; the upper part of the tower was rent, and had to be broken off afterwards. These earthquakes were probably the result of subterranean subsidences, and I think I may assume that through those subsidences modifications took place along the fissure through which the sea-water could ooze in greater quantity than before. Within the three last years, the pressure of the steam formed became sufficiently strong to force the lava, out of the much deeper-lying lava strata, upwards through the crater of Krakatoa, and the eruption took place when, at last, the violence of the steam was enabled to force its way through the lava to the crater and the surface. The steam carried with it a

<sup>1</sup> Translation of a Short Report on the Eruption of Krakatoa on August 26, 27, and 28, 1883.

quantity of lava, which was mostly shot as fine dust out of the crater. The porous nature of the ejected substances—pumice-stone was almost the only substance formed—is doubtless to be ascribed to the steam, which was blown with great force through the lava. I must keep the more detailed description of the way in which the eruption proper was prepared and took place for a future time, as drawings are requisite for a right understanding of the matter. I must still observe here, however, that through the Krakatoa eruption our notions about the shape and extent of subterranean regions will probably be much modified. If it may be assumed that there exists a connection between our eruptions, the heightened activity of the volcanoes in the Indian Archipelago since that time, and the earthquakes in Australia which took place simultaneously with and succeeded the eruptions of the last days—in any case a remarkable coincidence—then much larger dimensions will have to be allowed to those regions than the present geologists are accustomed to assign to them.

Krakatoa is the only point which has been active. There are reports that Sebei and the Radja Bassa have also shown activity, but this is inaccurate.

Of the old Krakatoa there is no detailed survey; the English and Dutch sea-charts, both on a small scale, besides a couple of sketches taken by Buijskes in 1849, and by me in 1880, alone give some idea of the surface-formation of the island. From the two sketches may be seen that the island had three tops—the northern, called Perboewatan (in some reports Roewatan), was the lowest of the three, and showed streams of lava on various sides; this is the point which first began to be active in May 1883, and which probably also ejected pumice-stone in 1860. The centre top bore the name of Danan, and was active also in August 1883. The southern peak, the mountain Rakata properly speaking (which was corrupted into Krakatoa), was by far the highest point of the whole island, and, according to the sea-chart, 822 metres high. This point is also an old crater, but was *not* active in 1883.

On May 20, 1883, the Perboewatan began suddenly to show signs of activity; that nothing was known before then of an approaching eruption must be ascribed to the fact that Krakatoa was uninhabited, and only visited occasionally by Lampong fishermen, who went no further than the coast. Otherwise it would seem inexplicable that no previous signs of it should have been noticed. The eruptions lasted with various degrees of violence, and with intervals, till August 26; while latterly also the crater of Mount Danan became active. Though in themselves not unimportant, these eruptions were insignificant compared to what followed. On August 11 trees were still growing on the peak, so that the destruction of vegetable life was then still limited to the immediate neighbourhood of the craters. On the 26th the explosions much increased in violence, and they reached their maximum on the 27th, at 10 a.m. They then diminished in strength, but lasted still the whole night of Monday to Tuesday, till they suddenly ceased on the 28th, at about 6 a.m.

About the eruptions from May till August 26 little of importance has, on the whole, become known; all I have been able to collect will be mentioned in the detailed report.

The eruptions of August 26 and 27 were accompanied by violent detonations and air vibrations. During those days almost incessantly a rumbling sound was heard which resembled the noise of thunder at a distance, the explosions properly speaking were accompanied by short detonations which can best be compared to heavy cannon shots, but the most violent detonations were still shorter and more rattling, and cannot be compared to any other sound.

The sounds of the explosions in May were heard in

a north-west direction at Moeara Doea in Palembang, and at Bintoehan, in the division of Kauer in Benkoelen, respectively 230 and 270 kilometres from Krakatoa; the transmission of the sound on August 27 surpasses, however, all which is known of the kind. The explosions were heard in Ceylon, in Burmah, at Manilla, at Doreh in the Geelvink Bay (New Guinea), and at Perth on the west coast of Australia, besides all the places which lie closer to Krakatoa than the above-mentioned. If a circle is drawn from Krakatoa with a radius of  $30^\circ$ , 1,800 geographical miles, or 3,333 kilometres, the circle will go exactly over the furthest points where the sound was heard. The furthest distance between the points east and west where the sound was heard is therefore  $60^\circ$  (the diameter of the circle) or one-sixth of the whole circumference of the earth. The surface of this circle, or rather of the spherical segment, comprises more than one-fifteenth of the surface of the earth. In historic times no eruption is known of which the sound was transmitted over such an enormous area. At the eruption of Tombora in Sumbawa, in 1815, the radius of the circle within which the sound was heard, was but half the size, namely  $15^\circ$ , the surface being therefore 3·93 times smaller.

If a circle with the same radius, namely  $30^\circ$ , is drawn round the earth, taking Amsterdam as the centre, the circle would have the following course. The northern point lies  $82^\circ$  north latitude, thus north of Spitzbergen; from there the circle runs to the middle of Novya Zemlya, thence along the Ural Mountains to Orenburg, Tiflis, Damascus, Jerusalem, Suez; crosses the Tropic of Cancer at about  $15^\circ$  east longitude from Greenwich, reaches the most southern point at  $22^\circ$  north latitude in the Desert of Sahara, crosses the Tropic of Cancer once more at  $5^\circ$  west longitude from Greenwich, runs close along Ferro, includes the Canary Islands and Azores, besides the greater part of Greenland, and runs back to the starting point north of Spitzbergen. In various places it was observed that the strongest detonations were heard at different hours, and also that in places in the neighbourhood of Krakatoa little or nothing was heard of the sound, whereas it was heard very distinctly in places further removed. Thus for example the loudest report was heard at Buitenzorg at a quarter to seven, at Batavia at half-past eight, at Telok Betong at ten o'clock on the morning of the 27th. This was caused principally by the direction of the wind; it appears clearly from the reports that the sounds were loudest on the side of Krakatoa whither the wind blew, and the fine ash particles were blown. But this does not yet explain the fact that the sound was sometimes better heard in places that were further off than in those that were nearer when those places lay in the same direction from Krakatoa, such as, for example, Anjer, Serang, and Batavia. This phenomenon is to be ascribed solely to the great quantity of ash particles which were present in the lower atmosphere. If one assumes for example the presence of a thick cloud of ashes between Krakatoa and Anjer, this would act on the sound waves like a thick soft cushion; along and above such an ash cloud the sound may be propelled very easily to further removed places, for instance Batavia, whereas at Anjer, close behind the ash cloud, no sounds or only faint ones would be heard. Other explanations, such as by the interference of sound, seem to me less probable though not entirely impossible.

Besides these sound vibrations, very long air waves were formed during the explosions, which did not manifest themselves by any sound, but had nevertheless an important effect. The most rapid of these vibrations communicated themselves to the buildings and walls of rooms, so that objects which hung on the walls or from the ceiling were set in motion. Thus at Batavia and at Buitenzorg, a distance of 150 kilometres from Krakatoa, the doors and windows began to rattle, clocks stood still, ornaments on cabinets fell down, and hanging lamps were

thrown out of their fastenings, and fell shattered to the ground with their chimneys and globes.

But not only at this distance was the air vibration perceptible. At Batoe-Radja in Palembang (250 kilometres from Krakatoa) rents appeared in the *pradjoerit's* barracks at three o'clock in the night; even at Palembang, 350 kilometres from Krakatoa, several Government buildings had to be immediately vacated as a crash was feared; and even in the Alkmaar country in Pasoeroean, 830 kilometres from Krakatoa, the walls were rent in the house of the administrator and the machinist. All this was caused by air vibrations, *not* by earthquakes, for it is a remarkable fact that these have nowhere been observed with certainty in this eruption.

Finally in the most violent explosions, air waves of an astonishing length were formed. As the Meteorological Institute at Batavia no longer possesses a self-registering barometer, those waves would have passed unobserved at Batavia, had they not fortunately been recorded by the indicator of the gas-works. This apparatus is self-registering, and continually marks on a paper, wound round a turning cylinder, the pressure of the gas. As the large gasometer was set in motion on August 26 and 27 by the pressure of the air waves, these oscillations were marked by the indicator, and the line of pressure shows that day, not the normal curves, but a number of sharp points. As hour lines are marked on the paper, the time at which these oscillations occurred can be accurately fixed, and if the time be deducted which the wave requires to travel from Krakatoa to Batavia, the moment is also known when the wave was formed, and the explosion took place (omitting a correction for the time which elapses between the moment of pressure on the gasometer and the moment this is recorded by the indicator, a lapse of time which is unfortunately not exactly known). The barometer experiments in Europe and America show that those large air waves possess almost as great a velocity as sound, from which it follows that they require seven minutes to travel the distance between Krakatoa and Batavia.

I have concluded from this that the most violent explosions took place at the following hours:—August 27, 5h. 35m., 6h. 50m., 10h. 5m., and 10h. 55m., Batavia time. By far the most violent of these four was the explosion of 10h. 5m. Then also an air wave was propelled from Krakatoa which spread in a circular form round this point as pole along the surface of the earth, and travelled no less than three and a quarter times round the whole circumference of the earth. The velocity was, as already observed, about the same as that of sound, although these were waves of a gigantic length (the length of the lowest sound waves being about 20 metres, that of the Krakatoa air wave more than a million metres).

The eruptions, which took place at first above the sea, probably became submarine about ten o'clock on August 27. Before that time only more or less damp ashes were ejected, after that also a large quantity of mud or mire, being volcanic sand mixed with sea-water. The giving way of the northern part of the mountain must have preceded these submarine eruptions, as appeared from the time at which the large tide wave, which probably originated through this subsidence, overflowed the *Vlakken Hoek*. This catastrophe caused a great change in the group of islands of Krakatoa. To the north-west of Krakatoa lies *Verlaten Island*, to the north-east *Long Island*, and west of the latter lies the *Poolsche Hoedje*. This small island has disappeared, the two others still exist, and are even larger than before, through the ejected substances which have settled on and around the island; but the greatest change has been undergone by Krakatoa itself. The whole northern part with the craters *Perboewatan* and *Danan*, and half of the peak have sunk in the depths. There only remains the southern part of the peak, which has been cut in two from the very top, and forms on the north side a magnificent precipitous cliff

more than 800 metres high. Through the downfall therefore a volcano rupture has been formed which is probably unique in the world. A coloured drawing of this remarkable rock will be added to the large report.

The size of Krakatoa was formerly 33½ square kilometres; of that 23 square kilometres have subsided, and 10½ square kilometres remain extant. But on the south and south-west side the island has been increased by a large ring of volcanic products, so that the size of New Krakatoa is now, according to our survey, 15½ square kilometres. The size of *Long Island* was formerly 2'9 and is now 3'2 square kilometres. *Verlaten Island* has become much larger; it was formerly 3'7 and is now 11'8 square kilometres in size. Of the *Poolsche Hoedje* nothing remains.

In the place where the fallen part of Krakatoa once stood there is now everywhere deep sea, generally 200, in some places even more than 300 metres deep. It is remarkable that in the midst of this deep sea a rock has remained which rises about 5 metres above its surface. Close to this rock, which is certainly not larger than 10 metres square, the sea is more than 200 metres deep. It is like a gigantic club, which Krakatoa lifts defiantly out of the sea.

The volcanic products of the preceding year consist almost exclusively, as we have already said, of pumice-stone; only here and there among the pale gray material a solitary piece of darker coloured steatite or a vitreous piece of obsidian appears. Although the stone masses in the crater were doubtless liquid, a stream of lava could nowhere pour down, because everything was shot out of the crater in larger and smaller pieces, and generally in powder.

The chemical composition of the ejected substances is not yet sufficiently known, but from the analyses that have hitherto been made it would appear that all the substances do not contain the same quantity of silica; probably that the large pieces floating on the top of the molten mass were somewhat more acid than the lava that lay deeper in the crater and was ejected as powder. The ashes collected by myself at *Buitenzorg* contained, according to the analysis made at Batavia, 60 per cent; a piece of pumice-stone, collected on the *Island Calmeyer*, 68 per cent.; a small piece of obsidian from Krakatoa over 68 per cent.; and fine yellow ashes from the east coast of Krakatoa even 70 per cent. of silica. There was found moreover alumina 14 to 16 per cent., protoxide of iron 6 per cent., chalk 4 per cent., soda 4 to 6 per cent., and a little magnesia.

In the microscopic examination of the ashes collected at *Buitenzorg* there was found—(1) *glass* in innumerable irregular fractured particles, generally completely permeated with vacuoles round or oval; in some particles the glass threads are bent. Those glass particles, microscopic pieces of pumice-stone, are always present in large abundance. (2) *felspar*, very fresh and clear, sometimes with distinct polysynthetic twin lines, generally, however, in single crystals; all seems to be plagioclase, as the analysis shows no potash. As inclusions in the felspar are found glass, apatite, augite, and magnetite. (3) *pyroxene*, partly green and then extinguishing obliquely, therefore monoclinic augite, partly coloured brown, and then, as it appears, extinguishing in parallel lines; it is not yet quite certain whether these last brown augites, which are present in much larger quantities than the green ones, belong to a rhombic pyroxene (bronzite or hypersthene), or are brown monoclinic augites which lie in the preparations on the orthopinacoid. This would be fortuitous; but if the orthopinacoid is much more developed in those crystals than the klinopinacoid, it is not surprising. I also believe I observed in one brown crystal oblique extinction, while sometimes transitions from brown to green tints occur. Inclusions are glass, apatite, magnetite. (4) *magnetite* in grains and oc-

tahedra, as the oldest component part. The quantity of magnetite decreases in the ashes in proportion as they fell further from Krakatoa.

If the molten mass had slowly cooled, an ordinary augite-andesite or andesite-steatite (with rhombic pyroxene), would have originated.

The thickness of the ejected substances diminishes on the whole as the distance from Krakatoa increases; the coarser material fell principally within a circle, with a radius of 15 kilometres drawn round Krakatoa, although pieces of the size of a fist were still thrown at a distance of 40 kilometres. Within the circle of 15 kilometres' radius the thickness of the layers of volcanic substances is 20 to 40 metres. At the back of the Island of Krakatoa, the thickness of the ash mountains at the base is in some places even 60 to 80 metres, but diminishes in thickness upwards, so that, in the deep clefts, which have already been hollowed out by the water, the old surface of the mountain and the fallen trees appear.

The thick layers of ashes were cooled at the top at the time of my visit, but were still very hot below, so that in the deep ravines hot water and steam appeared everywhere; also at Verlaten Island, Long Island, the Islands Steers and Calmeyer, and even at Sebesi, steam was seen to escape here and there. At Krakatoa there are, besides, stems of trees which have been carbonised by the hot ashes and continue to smoulder close to the fracture, where the air can penetrate, so that at night a little fire-glow and smoke may be observed. These small fires specially gave rise to the report that Krakatoa was still active.

The ascent of the mountain from behind, on the pumice-stone elevations, is difficult, but possible; the innumerable crevices, into which one must constantly descend, make the climbing up in the great heat and the total want of shade very fatiguing. The ascent may be made from the north-west, close along the rupture till about 20 metres from the top, which, according to our measurements, lies 831 metres above the sea; the surroundings of the top are rent and constantly crumbling away.

Between Krakatoa and Sebesi there is a large quantity of ashes and pumice-stone which has filled up that entire part of the sea, and projects in two places above the surface. To these two points the names of Steers Island and Calmeyer Island have been given. They do not rise more than a few metres above the sea, have much to suffer from the beating of the waves as they only consist of loose material, and will soon be washed away. The sixteen small craters between Sebesi and Krakatoa, reduced in later reports to six or four, have never existed. The smoking volcanic accumulations have been mistaken for active craters which, at first, from a distance was not unlikely to happen.

The finer ashes were blown eastward (east-south-east), to near Bandoeng (250 kilometres from Krakatoa), in a north-north-west direction to Singapore and Bancalis, respectively 835 and 915 kilometres from Krakatoa, in a south-west direction as far as Kokos Island (Keeling Island), 1,200 kilometres from Krakatoa; how far the ashes were projected west, north, and south is unknown; the surface comprises at least 750,000 square kilometres, that is, almost as large an area as Sweden and Norway, larger than the Austro-Hungarian Empire, also larger than the German Empire with Denmark (including Iceland), the Netherlands, and Belgium together, and twenty-one times the size of the Netherlands.

Evidently the prevailing wind-currents, *i.e.* south-east and north-east, have carried the particles along, which causes the outline of the surface covered with ashes to be irregularly curved.

Finer particles still have fallen even beyond this line into the sea, as appears from reports of ships; and the finest of all, mixed with a quantity of vapour, remained a long time floating in the upper air-currents, and, pro-

pelled by the wind, have made a journey round the world. The vapour was condensed to water, and froze in the cold currents; the refraction through the innumerable ice crystals caused the beautiful dark red glow which was observed the last months in so many places in Asia, Africa, Europe, and America; while the ash particles partly obscured the sunlight, or gave the sun blue and green tints at its rise and setting.

If one considers that the volume of the solid ejected substances already amounts to several cubic kilometres, and that the volume of ejected gas substances was perhaps hundreds of times as large, the hypothesis of a cosmic ice cloud to explain the air phenomena seems to me quite superfluous.

That the ash particles, as a matter of fact, were carried very far in the upper air-currents, has already appeared from snow which fell in Spain, and rain in the Netherlands, in which the same components were found as in the ashes of Krakatoa; and that the particles must moreover have been projected *very* high at the last eruption may be concluded from the report that, on the 20th May, during one of the first eruptions, the steam cloud—according to the measurements taken on board of the German man-of-war, *Elisabeth*, which left Anjer that morning at nine o'clock—must have reached a height of at least 11,000 metres. During the much more violent explosions of August 26 and 27, the height, if the above report may be relied on, may very well have reached 15 to 20 kilometres.

I found that on calculating as accurately as possible the quantity of ejected solid substances, they reached 18 cubic kilometres. In doubtful cases the lowest figure was always selected, so that 18 kilometres may be too low, but not too high, a computation. The possible margin amounts in my estimation to not more than 2 or 3 cubic kilometres.

However large a quantity this may be, it does not nearly reach that which the Tombora produced in 1815, and which Junghuhn estimates at 317 cubic kilometres; this computation, however, rests on but few data, so that in my opinion a quantity of 150 to 200 cubic kilometres will come nearer the truth. But even in that case the number is eight to eleven times larger than ours, which is not astonishing, as at that time at Madura, a distance of more than 500 kilometres from the Tombora, the sun was totally obscured for three days, whereas the darkness here only lasted a few hours.

Of these 18 cubic kilometres, which represent a weight of more than  $36 \times 10^{12}$  kilogrammes, no less than 12 cubic kilometres, or two-thirds of the whole ejected quantity lies within the circle with a radius of 15 kilometres drawn round Krakatoa. As the sea between Krakatoa and Sebesi was not deeper than 36 metres, and the thickness of the volcanic ejections amounts to almost the same, the navigation there has become quite impossible. A little further the thickness diminishes considerably. From 15 to 22½ kilometres from Krakatoa, the average thickness amounts to no more than 1 to 1½ kilometres; within this ring lies Sebesi, which now only presents a heap of ashes, with a few projecting stumps of trees; nothing here remains of the four populated kampongs which formerly stood on the plain opposite the small island Mengoenang (Huisman's Island), all has been washed away, and is covered with a layer of ashes 1 metre thick. From 22½ to 40 kilometres, the average thickness of the ashes amounts to 0.3 metre, then to 50 kilometres 0.2 metre. At a still greater distance from Krakatoa the thickness speedily diminishes to 2, 1, and half a centimetre, but the finer the ashes become the more the direction of the wind is perceptible. An "ash map" will be added to the detailed report.

One more very remarkable phenomenon during the eruption was the formation of powerful sea waves, which flowed over the low-lying coast districts of the Straits of

Besides, a remarkable fact must be taken into account, namely, that the largest wave, the only one which spread great distances along the north coast of Java and to the south-west, and which surpassed all other waves by far in height, was almost seen nowhere; at Tjiringin alone this wave was seen to approach before the darkness began, and this was about ten o'clock on the morning of the 27th. Anjer was already destroyed at 6 a.m., and then abandoned. At Telok Betong, and in the lighthouses on the Vlakken Hoek, and at Java's First Point, the wave was not seen because it was pitch dark. Even in the lighthouse, 40 metres above the sea on Java's First Point, nothing was seen of the wave, and the destruction of the coast country was only discovered the next morning when it became light.

As the great darkness at Bantam set in soon after the great detonation of 10h. 5m.—the same explosion which gave rise to the great air wave—and as the wave had only time, before the darkness set in, to reach the neighbouring Tjiringin, which lies 47 kilometres from Krakatoa, this tide wave cannot have arisen much before 9h. 50m. or 9h. 55m. At the Vlakken Hoek, 103 kilometres from Krakatoa, it appeared at about 10h. 30m., which agrees with our time computation, if it be taken into account that the velocity of the waves towards the Vlakken Hoek must have been greater on account of the greater depth of the sea than towards Tjiringin.

It is very probable that shortly before ten o'clock a subsidence of the hollow crater walls of one or both of the active craters took place, that through this the water gained access in large quantities, and that then half of the peak, which had been *previously undermined and fractured by the eruptions*, also disappeared in the depths. The cause of the great wave motion must no doubt be sought for in the subsidence of the peak. Of the northern part of the island, after the many eruptions, not much more than a hollow shell can have remained, the subsidence of which could not have caused waves of great importance; nor could the rush of the water produce great waves, but rather a suction towards Krakatoa, and this may be the cause of the water on the coast *first* retreating in various places before the great flood advanced.

The peak itself, however, was still massive, and I have calculated that the part which fell of this mountain alone, without Danan and Perboewatan, possessed a volume of at least 1 cubic kilometre. If this cubic kilometre be suddenly plunged into the sea, the same quantity of water must be displaced, which must give rise to a circular wave round Krakatoa.

There have been, however, other smaller waves; one as early as Sunday evening, August 26, at 5h. or 5h. 30m., two more in the night, and on Monday morning at 6h. a wave which destroyed Anjer. It is difficult to account for the small waves by assuming that parts of the mountain gave way, because, if so, probably the sea would have gained access also, and mud eruptions would have occurred much sooner, unless it be supposed that mud was ejected, but nowhere far enough to reach inhabited places, which is not quite impossible.

according to our measurements as follows:—15 metres up the lighthouse at the Vlakken Hoek; at Beneawang (Semangka), uncertain; at Telok Betong, before the house of the Resident, 22 metres; at the Apenberg (Goenoeng Koenjit), 24 metres; at Kalianda, up a sloping plain, 24 metres; on the south side of Thwart the Way,  $\pm$  35 metres (not measured); on the south side of Toppershoedje, 30, on the north side, 24 metres; at Merak itself the height cannot be ascertained with certainty, the old house of the engineer stood only 14 metres above the sea; about 2 kilometres south of Merak, 35 metres; north of Anjer, on the coast opposite Brabandshoedje, 36 metres. The height, therefore, varies everywhere, and depends on the situation of the places, their distance from Krakatoa, their being more or less sheltered, and the steepness of the coast. At Sebesi there is no trace left of the tide wave, as everything is thickly covered with ashes, which fell after the wave. At Seboekoe the height amounts from 25 to 30 metres, but no measurement was taken.

The big wave which was propelled from Krakatoa at about 9h. 50m. spread over great distances, among others as far as Ceylon, Aden, Mauritius, Port Elizabeth in South Africa, and even to the coast of France. The velocity of the waves varies greatly, of course, since it increases with the depth of the sea; I shall not be able to give a detailed summary till the tables of all the self-registering tide apparatus shall have been collected. For the Indian Archipelago, and a few points beyond, I found the following numbers:—

Places	Velocity per hour in miles	Average depth of the sea in metres
Island Noordwachter ... ..	37	37
Tandjong-Priok (Batavia) ... ..	36	35
Undeepwater Island ... ..	33	29
Dendang (Billiton) ... ..	31	26
Tandjong-Pandan (Billiton) ... ..	32	27½
Tjilamaja (Krawang) ... ..	31	26
Oedjoeng Pangka (near Soerabaja) ... ..	29½	23
Pasar Manna (Benkoelen) ... ..	113	344½
Padang . . . . .	109	320½
Mauritius (Port Louis) ... ..	(364)?	(3575)?
Port Elizabeth ... ..	306	2526

In our Archipelago the velocity is small, owing to the shallowness of the sea, but in the deep sea, on the route to Mauritius and the Cape, it increases considerably, *i.e.* amounts to more than 300 knots an hour, a velocity which is alone to be compared to that of the lunar tide wave and the earthquake waves of Simoda, in Japan, of December 23, 1854, and of Tacna, in Peru, of August 13, 1868.

From the velocity of the wave the average depth of the sea between the places along its path can be determined; I have put together in the foregoing table those various degrees of velocity, but they can only be trusted when the height of the wave is small with respect to the depth of the sea, which in our Archipelago is not strictly the case. However the numbers agree pretty well with the sea-chart. In the time computation of Mauritius ~~there~~ appears to be a mistake, as the average depth cannot be so different from that of Port Elizabeth.

After these terrible events Krakatoa slowly calmed

down, not however without having still violently roared in the evening and night of August 27 to 28. The detonations were scarcely less strong at Buitenzorg from ten to one o'clock than in the morning. But after the 28th nothing more was heard of the mountain. The tidal registrations at Tandjong Priok exhibit still a few small oscillations till August 30 at twelve o'clock in the day, but after that the condition of the water also became normal. Notwithstanding this I found that there must have been a serious eruption a considerable time after August 28, and shortly before I visited the island.

On October 11 I left Batavia with my staff, and after having visited various points in the Straits of Sunda, arrived at Calmeyer on the 15th. We stopped a few hours in order to survey the island, which is a perfectly bare bank of pumice-stone, divided into seven parts by encroachments of the sea; the temperature was 42° Celsius, a heat which almost stupefied us. Here already my attention was drawn to the fact that the white or pale gray pumice-sand was covered by a 0·2 metre thick layer of darker coloured very fine ash, which exhibited numerous fissures on the surface, produced in the process of drying, and therefore had probably fallen there as wet mud. I did not, however, then attach any special importance to this phenomenon.

On the 16th I arrived at Krakatoa and remained there till the 18th. When in surveying the mountain on the 17th we had climbed to the top, and began the steep descent on the south side, I observed with astonishment that on the ordinary gray pumice-stone material two black streaks were visible, which began 600 metres above the sea, therefore about 200 metres lower than the top, and could be traced in a tolerably straight line over a length of 1300 metres till 100 metres above the sea. These black streaks proved to be two mud streams, which had flowed down the slope of the mountain and had covered the white pumice-stone to the thickness on an average of 0·2 to 0·3 metre and a breadth of 1 to 5 metres. The most remarkable fact was, however, that these mud streams were not only traced down the back of the mountain but had also flowed into the deep ravines of pumice-stone material, as can be distinctly seen. Therefore those mud streams did not arrive there till the crevices in the pumice-sand already existed, and as several weeks must have been required for the water to hollow out these ravines the mud eruption cannot immediately have followed the eruptions of August. The very fine dark gray mud was still damp at the time of my visit, and could be kneaded with the hand, which also proves that the streams were of recent origin.

In this eruption very curious objects were ejected, *i.e.* very smooth, round balls resembling marbles, to the size of 1½ to 6 centimetres in diameter. They are full of acids, they contain 55 per cent. carbonate of lime, 26 per cent. silica, 11 per cent. alumina, and 5 per cent. water. These calcareous lumps of marl must be derived from layers of marl which exist at the bottom of the Straits of Sunda in the neighbourhood of Krakatoa, and the slime or dust of which has been shot out of the crater in a rapid revolving motion. The balls, which are rare, are never found inside but only on the top of the pumice-stone dust, generally half sunk in the sand; they evidently belong to the last ejections. Whether the mud streams also contain lime I have not been able to ascertain, as a piece brought as a sample has unfortunately been lost.

The last mud eruption, which must have been very important, since on Calmeyer, 12 kilometres from Krakatoa, the upper black layer is 0·2 metre thick, and the mud must have been thrown over the top, which is 830 metres high, to the back of the mountain, whence it poured down, probably took place only six days before my arrival, namely on October 10, at about 9h. 30m. in the evening, because on that evening at about ten o'clock a considerable tide wave arrived at Tjikawoeng in Welkomstbaai

(Welcome Bay), the only tide wave which was observed since August 28. A rumbling sound in the direction of Krakatoa was then heard in that place, as well as a little more northward at Soemoer. The wave overflowed the shore to a distance of 75 metres beyond the tide-mark at Tjikawoeng, but has not been observed at other points of the coast, as the devastated coast country was not yet inhabited and was quite abandoned at night. We find in this another proof that the falling down of large quantities of ejected substances round Krakatoa suffices to form important waves in the Straits of Sunda.

The eruption on October 10 seems to have been the last. But this eruption was scarcely noticed, and it is therefore possible that subsequent feeble volcanic actions may have remained quite unobserved. When I visited Krakatoa there was nowhere any sign of activity. On October 18 we left Krakatoa, and we arrived on the evening of the 19th at Vlakkens Hoek, where nothing was noticeable. It is not likely, therefore, that the rumbling sounds which were heard that evening at Tangerang and Mauk coming from the west should have proceeded from Krakatoa. It would, however, be very interesting to visit Krakatoa once more in order to be able to trace whether any more changes have taken place since October 18.

Though there is no fear of any serious eruption of Krakatoa after the terrific activity of the volcano and the subsidence of the greater part of the island, still much that is interesting may be learnt yet from less important subsequent volcanic actions, as we see in the instance of the lumps of marl.

With the detailed report a large map of Krakatoa will appear, as well as maps of Calmeyer, the devastated parts of Merak, Java's First Point, Sebesi, Seboekoe, Telok Betong, and Kalianda; moreover tables indicating the pressure at the gas-works at Batavia, and of the self-registering tidal apparatus at Tandjong Priok and at Soerabaja; a small "ash map" and other supplements, and finally a few coloured drawings of Krakatoa and the devastated districts, where in a few moments tens of thousands of people lost their lives on the memorable 27th of August, 1883.

R. D. M. VERBEEK

Buitenzorg, February 19, 1884

#### THE LATE MONSIEUR DUMAS

AT the funeral of this eminent chemist addresses were given by the representatives of various official bodies. From these we subjoin the following extracts, affording as they do an idea of the estimation in which M. Dumas was held by his contemporaries, and of the position to which he is entitled in the science of the present century.

M. le Comte d'Haussonville, Director of the French Academy, said:—

"Who was more worthy than Jean Baptiste Dumas of the high distinctions conferred on him by the Academy of Sciences! By us he was welcomed at a time when his name already ranked amongst the most illustrious of our times, when he had already been hailed as a master by associates destined soon to become masters in their turn. To their authoritative voice, rather than to me, must belong the duty of recording the signal services rendered to science by our regretted colleague, whose mortal remains lie at our feet. They will tell you with a fulness far beyond my power how, under the first inspiration of his soul, he understood how to vary his experiments and verify his assumptions. And with what supreme delight, says one of our *confrères*, who had the honour to receive him into the Academy, he pierced with eagle-eye into the depths of the divine laboratory, beyond which there is naught but the infinite, the unfathomable, the unapproachable! Speaking of his own work, he himself thus expresses himself:—'Above the sphere of phenomena which we study, and where such a vast field of discovery still



lies open before us, there is still a higher sphere inaccessible to our methods. We begin to understand the life of bodies; that of the soul belongs to another order. My years, near enough to those of the venerable seer by whose death we are overwhelmed with grief, enabled me to assist at one of M. Dumas' earliest triumphs. It was before the year 1848, when in his official capacity he ascended the tribune of the House of Deputies in order to expound the whole mechanism of minting in connection with a law then under discussion. Notwithstanding the dryness of the subject, I still remember how we remained for two hours captivated by the charm of his natural eloquence. In taking leave of so great a memory, permit me to repeat the glowing words recently uttered by M. Dumas himself on the occasion of the death of his distinguished colleague, M. Regnault: 'The Academy, faithful interpreter of posterity and sole heir of your renown, hastens to render a public homage of affection to your person, of thanks for the great and noble work of your life, of respect for your brilliant services, awaiting the time when science and your country shall pay their debt to a name worthy of every honour.'

M. J. Bertrand, Perpetual Secretary of the Academy of Sciences, said:—

"M. Dumas has been our universal teacher. His lectures at the Athenæum, at the College of France, at the Central School, at the School of Medicine, the Faculty of Sciences, and Polytechnic, had so many attractions, he understood so well how to inspire his audience, he indicated the path of progress so clearly, and made each discourse so finished and perfect in itself, that all alike withdrew resolved not to miss the following lecture.

"In the history of reformed chemistry no name will assuredly eclipse that of M. Dumas. Eager to disseminate his ideas, skilful in placing his proofs in a clear light, his wise and lofty intellect surveyed from a high standpoint the main routes of science, acting ever as a faithful guide to all who, younger than himself, considered that they honoured themselves in proclaiming him their master."

M. Rolland, as President of the Academy of Sciences, naturally entered into some detail on the scientific work of M. Dumas. Among other things he said:—

"The scientific work of J. B. Dumas is immense, and his labours have long shed a lustre on his name. In his thirty-second year he had already joined the Academy of Sciences, of which he subsequently became one of the most eminent and respected members. I cannot attempt here to mention all the numerous discoveries due to his genius, by which he has so potently contributed to the establishment of modern chemistry, herein showing himself the worthy successor of Lavoisier.

"I will therefore restrict my remarks to the second period of his career, during which, as Perpetual Secretary of the Academy of Sciences, he enabled us better to appreciate his subtle and lofty intellect, his profound knowledge of men and things. Hence his authority was unanimously recognised by his colleagues, whose councils and labours were so often controlled by him with admirable tact and prudence under peculiarly delicate circumstances. If to these rare gifts be added a fluent speech, a kindly and sympathetic feeling from which he never departed, it will be understood how highly prized was the combination of these exceptional qualities, how valued by the Academy, where Dumas so often played the part of guide and director.

"These eminent virtues had long been esteemed and utilised by other societies also, such as those of the Central School, of the Friends of Science, and others, over whose labours he had presided for many years. He was also intrusted with the presidency of several international Commissions, where were discussed many important questions in connection with a uniform system of weights, measures, and currency, as well as with the

determination of electric units. There might perhaps be reason rather to regret the manifold occupations and public duties which absorbed so much of his time, diverting him from the prosecution of purely scientific researches, where so much might still be hoped from such a powerful genius. For, in spite of a long life devoted to incessant work, our *compère* had to the last preserved his strong intellect and mental activity.

"But however great and varied were the labours constantly claiming his attention, he never neglected his more personal duties. His was the life of a true patriarch, ever encircled by his children and children's children, who cherished his fair name and ever rejoiced in the constant solicitude of a tender and devoted father.

"Dumas had married the daughter of Alexander Brongniart in the year 1825. All who, like myself, had the privilege to be welcomed in that happy circle, can testify to the intimate and devoted character of their union down to these last days. I may here be permitted to express to the bereaved widow our warmest sympathy in the loss which to-day deprives her of the affectionate support of such a well-beloved husband.

"But the time has come to bid a last farewell to the mortal spoils of our illustrious colleague, whose memory shall ever remain engraved on our hearts, whose name is eternally enrolled amongst those of the great thinkers by whom the nineteenth century has been most honoured."

Following M. Rolland came M. Wurtz, who spoke on behalf of the Faculties of Science and Medicine.

"To those already deposed on the remains of M. Dumas, the University," M. Wurtz said, "adds other wreaths in supreme homage to the teacher by whom we have all profited, to the *savant* who has shed a lustre on our times, to the worthy citizen who has left a void in the hearts of all. Ours is a public mourning, and above the voices which we hear around us I seem to hear the great voice of France, which in Dumas suffers an irreparable loss. For a period of sixty years he served her with distinction under the most varied circumstances.

"To a piercing genius, an intuition leading to great discoveries and broad views of the universe, Dumas added the choicest gifts of eloquence, of a clear and graceful style, gifts which make the orator and the writer. He was the ideal of a French *savant*, and history will award him a place not far removed from that of his admired master, Lavoisier.

"Born at Alais in 1800, he began life as a chemist's assistant in Geneva. But he was scarcely twenty years of age when, jointly with Prévost, he published some researches on various physiological subjects, and notably some experiments on the blood, which have held their ground to the present time. After his arrival in Paris in 1821 he devoted himself exclusively to chemistry, and soon felt himself competent to undertake such grave work as the independent development of organic chemistry, and the reform of mineral chemistry. And if during the last fifty years chemistry has broken new ground, and become, so to say, transformed under our eyes, this has been accomplished in virtue of a programme he was the first to trace, and the foundations of which were laid by his own discoveries. The ideas at that time current had been drawn from the relatively simple study of mineral compounds. All combinations, it was assumed, are formed of two direct elements, themselves either simple bodies or compounds in the first degree. This so-called 'dualism' in chemistry, traceable to Lavoisier, had been adopted and developed by Berzelius, but was overthrown by Dumas. Studying in 1834 the action of chlorine on organic compounds, he detected in this simple body 'the remarkable power of replacing hydrogen atom by atom.' Such was the first announcement of a law which, supported by thousands of analogous cases, now forms the point of departure for the theory of substitutions and its consequences, associated with the name of Dumas. This

conception was developed in a series of memoirs dealing with chemical types, and was later on generalised and simplified by Charles Gerhardt.

"Dumas' studies embraced every branch of the science—discovery and description of mineral and organic compounds, analysis of numerous substances and improvement of the methods of analysis themselves, determination of atomic weights. With the penetration of inventive genius he introduced into all his researches that firm grasp of the subject, that accuracy in details, that critical spirit which are the essential conditions and necessary instruments of all scientific investigation.

"And how shall I speak of his theoretical views expressed on a great variety of special subjects, and embodied either in his great 'Traité de Chimie Appliquée aux Arts,' or in his admirable 'Leçons de Philosophie Chimique'? Merely to mention one point, to Dumas we are indebted for a first attempt at a classification of simple non-metallic bodies, an attempt which has still its value.

"Let me also remind you that, after enriching physiological chemistry at the outset of his career, he soon after endowed physics with a new method for determining the densities of vapour, in continuation of the work begun by his master, Gay-Lussac.

"But a complete idea of his influence and authority cannot be had without reference to his career as a teacher. On his arrival in Paris he opens a course of lectures at the Athenæum. Later on he founds, jointly with Lavallée, Ollivier, and Pécllet, the Central School of Arts and Manufactures, where he conducts the chemical class for a quarter of a century. In 1832 he replaces Thenard at the Polytechnic, and the same year is appointed Assistant Professor to the Faculty of Sciences. In 1841 he becomes at once Titulary and Dean of the same Faculty, having three years previously obtained the Chair of Organic Chemistry in the Faculty of Medicine. It was here perhaps that his talents as a teacher achieved their greatest triumphs. He was at that time at the most brilliant period of his creative genius, and he set forth the great ideas then animating him with sympathetic warmth and persuasion, with inimitable clearness and wealth of illustration.

"Such, in a few words, has been the preponderating part played by M. Dumas in science and instruction. And although during his last years he withdrew from public life, it was only to devote himself to work of another order. He was equal to every undertaking imposed on him, the soul of the many committees over which he presided, the ornament of the Academic celebrations which he honoured by his presence and addresses. And after such a long and glorious life what remained except a peaceful end in the midst of his family circle, and in the full enjoyment of all his faculties? But such a commanding figure cannot pass into forgetfulness. Your memory, Dumas, shall be perpetuated, your name transmitted from age to age. You shall live in your works, in the example you have given, in the immortal productions and rare qualities of your mind: *Forma mentis aeterna.*"

### THE EARTHQUAKE

EARTHQUAKES are so rarely observed in England, that an exceptional interest attaches to that of April 22, an interest far in excess of that due to its intrinsic importance. Fortunately the earthquake is exceptional in another sense. It is seldom that a shock results in so small a loss of human life in proportion to the damage done to houses.

The daily London press, for a few days after the occurrence, gave much information as to the range of the earthquake, and the nature and amount of the damage done; further details are given in the local papers of the Eastern Counties, but we are still sadly in want of definite statements upon many matters of great importance. In

this article we shall notice only a few points of interest, reserving for a later issue, it is hoped by the aid of fuller knowledge, a more complete account of the phenomena, to be illustrated by a map showing the area of disturbance.

The shock was most severely felt near the north shore of the estuary of the Blackwater, and for about six miles inland to the north, in the direction of Colchester. The geology of this district is simple. Nearly all the country is occupied by London Clay; over the marshy land of the Colne, and the flats separating Mersea Island from the mainland, there is a covering of recent alluvial deposits; over parts of the higher land of Mersea Island there are patches, from a quarter of a square mile to one square mile in area, of Glacial gravel, the remnants of a great sheet of similar material which once overspread the London Clay and joined the large area of similar gravel near Colchester. This town is mostly built on gravel, which rises to a greater height, and occurs in considerable thickness, to the south-west of the town—over Lexden and Stanway Heaths; further to the west and south-west this gravel passes under Boulder Clay. Underlying the whole of the Tertiary beds of the east of England there is a continuous bed of Chalk, from 600 to 1000 or more feet in thickness. Below the Chalk there is a bed of Gault Clay of varying thickness. But here our certain knowledge of the geological structure of the country ends. Rocks of Silurian, Devonian, or Carboniferous age have been proved at various points under the east of England—at Harwich, Ware, Turnford, Tottenham Court Road; rocks of probably Triassic age have been found at Crossness and Richmond. Still further west and north-west the older rocks have been proved at Burford and Northampton. Over Central England the Jurassic and Triassic rocks cover a wide area, but from beneath these the older rocks appear in numerous places.

One of the most interesting questions connected with the recent earthquake is to ascertain whether there be any relation between the known range of these older rocks and the range of the earthquake over areas far distant from its central spot. At first it seemed certain that such was the case. The shock was plainly felt at Bristol, Wolverhampton, Birmingham, and Leicester—all places on or near to the outcrop of the older rocks. Numerous intermediate localities have since been mentioned, many not being connected, so far as we yet know, with the near existence of older rocks; but the far distant places still make it probable that some such connection exists.

It seems therefore likely that the wider and more general range of the earthquake is connected with the range of the Palæozoic rocks, whereas the local phenomena depend very largely upon the nature and thickness of the Secondary and Tertiary rocks. It is therefore important that those who study in detail the effects of the earthquake on the spot should do so with the aid of the Geological Survey Map of the district, which was surveyed by Mr. W. H. Dalton. The map and explanatory memoir are both published; in them the nature of the drift deposits are fully explained.

Almost all earthquakes have a very striking effect on springs and wells, sometimes causing a permanent change, at other times having merely a temporary influence. It is somewhat remarkable that so little has been recorded upon this point. A strong spring at West Mersea, which issues at the base of the Glacial gravel, where this bed rests upon London Clay, is said to have ceased to flow for a short time, and to have been discoloured when the water returned. Any residents in the district who have the opportunity of inquiring into similar cases, which doubtless occurred, will do good service by noting the facts.

Dr. J. E. Taylor's letter, which appears elsewhere, contains much valuable information, such as might well be collected from neighbouring areas; his observations as to the twisting of chimneys, &c., and as to the direction in which that twist occurred, is a case in point.

Information is also wanted as to the angle at which the shock emerged from the ground at various points around the central area, in order that the depth from the surface at which the shock originated may be known. There should be no difficulty in collecting data for this in a district where so many buildings are cracked and shattered. The direction of the cracks, and the angles which these cracks make with a horizontal line, should be carefully noted.

Another point upon which much uncertainty at present exists is the direction in which the wave travelled from its point of origin. The swinging of chandeliers, the swinging of pictures on certain walls and not on others, pendulums which stopped or not according to the direction of the swing, are all important helps towards deciding this question. Of course it is always dangerous to seek for knowledge of this kind some time after the event, but in many cases it may be possible to speak with absolute certainty of the facts.

Some observers speak decidedly of two distinct shocks; this probably was the case frequently, though seldom noticed. The rumbling sound so frequently accompanying earthquake shocks was in many cases noticed in Suffolk and Essex. It is rarely mentioned elsewhere, but is said to have been heard at Chelsea, Reading, and Bristol.

As regards the actual area affected by the shock, there is perhaps much yet to learn. It is recorded along the south side of the Thames from Herne Bay to London, and again at Reading. It was felt at Maidstone and Croydon, and again along the south-east coast from Hastings to Portsmouth and Ryde. But at present we know of no observations in the central parts of Kent, Surrey, or Sussex.

W. TOPLEY

WE have received the following further communications in reference to the earthquake:—

As all facts connected with the earthquake shock on Tuesday may prove of more or less value, I beg to communicate the following. The house which I occupy is situated in the centre block of buildings constituting Inverness Terrace, on the western side. Under this block of houses runs the Underground Railway, but a distance of one hundred paces from my house. During the day-time the passage of trains is wholly unperceived, but during the night, when heavy luggage-trains run, a very perceptible vibration is experienced, and in the stillness a distinct rumbling is heard. On the morning of Tuesday I was engaged reading, when my attention was called to what I supposed to be the passage of a train; but the peculiarity of the motion speedily undeceived me. The sensation was that of being borne rather on water than on solid earth, and as I had already had experience of an earthquake shock in India, I suspected that this disturbance I was feeling was of the same nature. I immediately looked at my watch and noted the time as being thirty-two minutes past nine o'clock. As no one of the other three inmates of the house had perceived anything unusual, I thought no more about the matter until I saw the announcement in the evening papers of what had happened. I then went to the watchmaker's and found that my watch was just fifteen minutes too fast. I am therefore able, with fair approximation to accuracy, to fix seventeen minutes past nine o'clock as the time at which the vibration ceased at this point.

W. C. B. EATWELL

69, Inverness Terrace, Kensington Gardens, W., April 24

ON Wednesday morning last, the day after the earthquake, I determined to start upon its track. In Ipswich here, little or no visible harm has been done; but no sooner had I arrived at Colchester and commenced to walk through the town, from the chief station to the Hythe, than abundant evidence of the ruin wrought by it was visible. Chimneys were totally thrown down, and the brickwork had crashed through the frail roofs. Others were standing, but they looked as if they had been struck by lightning. Their upper parts were splintered and laterally expanded. I could not help noticing that nearly all the houses whose chimneys were wrecked were the oldest—hardly any of the modern, cheaply-built cottages being affected, contrary to my expectation.

At Wivenhoe I found the appearance of the town best expressed by the remark already made: "It looked as if it had been bombarded." That was the first idea which rose in my mind.

Hardly a house was untouched, inside or out. The newest houses seemed to be externally least affected, but they made up for this inside. They looked as if they had been given a few half turns, and then shaken up. The plaster had been detached from all the walls, the roofs were rent and loosened all along the cornices, and the framework of the windows was everywhere splintered or free. The battlements of the grand old church had been thrown down, and about fifteen tons of rubbish lay among the crushed headstones and the delicate and abundant grave flowers. Here again there was evidence of a semi-rotatory motion on the part of the earthquake. The beautiful Independent Chapel is so utterly wrecked within and without that it will all have to come down. The streets were full of bricks, mortar, and tiles, although with characteristic English tidiness and diligence the terror-stricken inhabitants were already clearing away the debris. I noticed several houses with rents at the bases of their walls, and in such of the chimneys as remained standing they were frequent. One thing struck me, the rents sprang at an angle of about 30° at the bases of the buildings, whilst in the chimneys this was increased to from 40° to 45°.

The old ferryman related his experience after the manner of an old salt. He was just bringing his boat to the shore when the shock occurred—"it seemed just like *three seas*," he said—a capital and vivid expression to convey an idea of the wave-motion.

Crossing the river I made my way through Fingrinhoe village, and on to Langenhoe. I did not see a single house on the road, large or small, for a distance of about four miles, that had escaped untouched. The fine old Jacobean hall at Fingrinhoe has lost the upper part of the western side of the front elevation. Here I found some of the chimneys that had been left standing *twisted* on their pediments. I carefully noted this on the way, and on examining those of the massive chimneys of the rectory at Langenhoe, the torsion was very plainly visible. The twist had come from the south, for the faces of the chimneys which had previously looked in that direction were now turned almost south-easterly. I did not set out a minute too soon to note these circumstances, for all the builders of the countryside were already abroad, and in a few days all the evidences of earthquake action of the greatest value to seismologists will have been completely obliterated. Thus I found a very intelligent builder from Colchester on the lawn of the Langenhoe Rectory, giving orders for having the twisted chimneys removed, and I have no doubt they were all taken down within twenty-four hours. He had been driving all over the disturbed countryside, and told me that wherever the big chimneys had been left they were twisted from the south-south-west to the north-north-east, especially in the contiguous villages of Peldon and Abberton. This, I think, settles the original direction of the earthquake wave, and also establishes its rotatory character.

Langenhoe Church is an utter ruin, and all that yet stands will have to come down. It is a sad sight to see this picturesque, ivy-clad old church—standing so prettily overlooking the creeks where the ancient Danish Vikings landed in the dawn of our modern history but a comparatively few years before the church was built—now so utterly ruined. The porch on the north side is of brick, and a modern structure. Two large rents run up, one on each side of the doorway, at an angle of about 32°. They run from opposite directions, and meet just above the keystone of the arch. Here another large rent parallel with the ground traverses the masonry. It seemed to me that the first earthquake shock which rent the brickwork sprang from the western corner, and was reflected so as to form the opposite rent, after striking and lifting up and forming the parallel crack above-mentioned.

The battlements of Langenhoe Church, like those of Wivenhoe, have been shaken down. But while those of Wivenhoe were thrown upon the ground chiefly on the *west* side, those of Langenhoe Church were thrown on the *nave*—that is, in an opposite or *easterly* direction. They crashed through the roof and carried a gallery with them, the concussion meantime bursting out the upper part of the chancel end. Am I right in thinking that this pitching forward of the loosened rubbish in opposite directions, as exemplified in these two churches, taken in connection with the overwhelming proof of rotatory motion, indicates that the movement of the earthquake had swerved right round be-

tween Wivenhoe and Langenhoe? In that case does it not also suggest the *local* character of the earthquake?

Langenhoe and the adjacent villages, with the Isle of Mersea close by and in full view, appear to form the focus of the disturbance. So far as I have been able to learn, the shocks stopped by the shock were those facing the north.

I see the newspapers refer to various cracks and fissures in the ground at Langenhoe, Abberton, Mersea, and elsewhere, as having been caused by the earthquake. I saw numbers of them, but in every instance they were the ordinary cracks which always appear in the London Clay during a drought, or after a spell of dry weather like that of the last three weeks. In none of the instances I saw had the fissures anything to do with the earthquake.

The local character of the area of chief disturbance is not only indicated by the different directions in which the rubbish was thrown from the battlements of Wivenhoe and Langenhoe Churches relatively, but also by the fact that whilst the western side of Mersea Island suffered severely, the eastern side was only slightly affected in comparison.

Museum, Ipswich, April 26

J. E. TAYLOR

THE earthquake was felt here very plainly, and I am able to give some evidence as to the amount of oscillation experienced at the moment when the wave passed under Cambridge. I happened to be looking at my marine aquaria at rather more than twenty minutes past nine on Tuesday morning (I regret I did not notice the *exact* time, but that was about it), and the water in them distinctly moved. The oscillation was not violent, as if produced by a concussion in the air, such as an explosion would cause, but rather as if the table on which the aquaria stand had been tilted up to the extent of an inch, and in the direction of a line running east and west. I was looking more particularly at a very shallow aquarium in which I keep shrimps, mussels, and sand-loving annelids, and one portion of which has less than a quarter of an inch depth of water. This was tilted up so much that the sand at the shallow end was quite uncovered by the water, and my first thought was that evaporation had taken place during the preceding night to such an extent as to endanger the lives of the nereids and other creatures; I therefore went hastily for some fresh water, but upon returning with it in a minute I found the water at its normal level, and I had no necessity to pour any fresh in. I remember, too, that I was sensible of a slight giddiness at the time, and the house and everything in it seemed to be moving. The sensation indeed was much like being on ship-board. I had no suspicion of the real cause, but thought it was a slight faintness, as I had not then breakfasted.

Mill Road, Cambridge, April 23

ALBERT H. WATERS

THE following memoranda may be of interest:—On January 8, 1869, I was with Prof. Dawkins, engaged in examining the late Mr. Whincopp's collection at Woodbridge, Suffolk. On my way home I was delayed three hours at Bury St. Edmund's in consequence of a luggage-train having broken down to the eastward. While there I was told that an earthquake had been felt that day at Thurston, Elmwell, and Haughley, places between Ipswich and Bury. It was reported that a workman, sitting eating his luncheon on the bank, saw the rails move. Mentioning this when I returned home, I was told that the policeman in this village had felt a shock. I therefore interviewed him and made the following note:—"January 15, 1869: P. C. Redhouse, when near the 'Hare and Hounds'" (which is a few hundred yards south of my house) "on Sunday morning the 3rd, about 2 a.m., heard a sound like heavy distant guns, which seemed to shake him and to make him reel. He was walking fast, and stopped. There was no shake after the sound. He thought there were six or seven reports in a couple of seconds. The movement was from north to south. There were three sounds before he stopped, and three afterwards. He did not regain his steadiness for two or three chains' distance. The sounds were very heavy, and he went home in alarm." I was awakened the same night by a tremor of the bed. This occurred a week before the shock in Suffolk. The late earthquake was preceded at Langenhoe by a slighter one on February 18.

A yacht captain at Wivenhoe happened, on the 22nd inst., to witness the effects from the top of a ladder. Hearing a rumbling sound, he looked about him and saw the church and all the houses rocking about, some one way and some another, "like a lot of pleasure-boats at the seaside with a gentle swell on." This seems to show that the length of the wave could not have

been great, but that it must have been in opposite places within a few hundred yards. Knowing the district well, it strikes me as remarkable that the strength of the shock should have been so much localised, while the distance over which it was slightly felt was so extended.

O. FISHER

Harlton, Cambridge, April 28

ALTHOUGH this Observatory does not possess a seismograph, yet the passage of yesterday's earthquake wave was recorded by the magnetographs, although I am not aware the shock was felt by any one in this neighbourhood. It was registered at 9.17-18 a.m. G.M.T., and from the fact that the disturbance of the horizontal force magnetometer was the greatest, we infer that the terrestrial movement was rather north and south than east and west.

G. M. WHIPPLE

Kew Observatory, Richmond, Surrey, April 23

PROBABLY one of the extreme limits of the action of the earthquake of April 22 was at Street, Somerset, ten miles beyond the Mendip main anticline. There it was *certainly* felt by an invalid lady, who mentioned it at midday dinner, only a few hours after, no news having been received, of course, from other parts. Has there been any certain record of it north of the concealed Palæozoic ridge across the North Midland counties?

York, April 28

J. EDMUND CLARK

## NOTES

AT the meeting of the Executive Committee of the City and Guilds of London Institute held on Tuesday, the following appointments were made at the Central Institution, Exhibition Road:—To the Professorship of Chemistry, Henry Armstrong, Ph.D., F.R.S., of the Technical College, Finsbury; to the Professorship of Engineering, W. C. Unwin, D.Sc., of the Royal Engineering College, Cooper's Hill; to the Professorship of Mechanics and Mathematics, Olaus Henrici, Ph.D., F.R.S., of University College, London; to the Professorship of Physics, Oliver Lodge, D.Sc., of University College, Liverpool.

IN a crowded house on Tuesday last the Convocation of the University of Oxford passed the much-debated statute allowing women to enter for "certain of the honour examinations of the University." The statute has been opposed on very different grounds. The old Conservative Oxford School (fast becoming extinct among the resident teachers) of course objected to any change in favour of the higher education of women; with them went a portion of the High Church party, who look with disfavour on any proposal tending to bring women into intellectual competition with men. Others, again, opposed the statute on the ground that it was unfair to men, who have to keep certain terms and pass certain examinations within a specified time if they wish to enter for an honour school, whereas the statute allows women to enter for honours without the same preliminary examinations, and without restrictions as to time and residence. Others again feared an influx of young ladies into Oxford, as likely to destroy the manliness of the undergraduates and spoil the natural modesty of the lady students. To these arguments the success which the present halls for ladies in Oxford have met with is the best answer. Their presence has not revolutionised the University; they have not been a stumbling-block to discipline nor a rock of offence to the Church. The women's examinations, conducted by the delegates, were exactly on the same subjects, and the papers were set by the same men, as in the men's honour examinations before this statute passed. Now the same papers will serve for both, trouble will be saved, and the women who obtain honours will win a certificate universally recognised throughout the country. Oxford is to be congratulated on Tuesday's vote.

THE Rede Lecture at Cambridge University will be delivered on May 28 by Mr. Francis Galton, the subject of the lecture being "The Measurement of Human Faculty."

WE are informed that tickets have been applied for as follows for the Montreal meeting of the British Association:—Members elected prior to October 1882, 379; Members elected since October 1882, 181; Associates (relations of Members), 120; total, 680.

THE International Geological Congress will hold its meeting in Berlin this year, towards the end of September.

THE International Polar Conference concluded its labours last Thursday.

IN reference to the recent sunsets a correspondent writes that Graham's Island was in eruption, throwing out vast quantities of steam, ashes, and cinders from July 19 to August 16, 1831, and in connection therewith sends us the following extract from a letter written from Malta, January 28, 1832 (see *Phil. Trans.* 1832):—"In the month of August a singular appearance was witnessed in the heavens, many evenings successively, both here and in Sicily. Soon after sunset the western sky became of a dark, lurid red, which extended almost to the zenith, and continued gradually diminishing in extent and intensity even beyond the limit of twilight. This phenomenon, too, was attributed to the volcano, and was supposed by many people, whom it greatly alarmed, to be portentous of some impending calamity." Our correspondent also sends us the following old translation of Virgil's "Georgics," Book i. line 542:—

"He, too, bewailing her unhappy doom  
When fell her glorious Caesar, pitied Rome,  
With dusky redness veiled his cheerful light,  
And impious mortals feared eternal night;  
Then, too, the trembling earth and seas that raged,  
And dogs and boding birds dire ill presaged;  
What globes of flame hath thundering Etna thrown,  
What heaps of sulphur mixed with molten stone,  
From her burst entrails did she oft expire,  
And deluge the Cyclopean fields with fire."

THE Kew Committee of the Royal Society have affiliated to the Department for the examination and verification of scientific instruments a branch which will rate watches for either makers or the public on very moderate terms.

THE Council of the Royal Geographical Society have decided to appoint for one year an inspector, to inquire thoroughly into and report on the state of geographical education at home and on the Continent. In addition to studying the best methods of geographical teaching—chiefly probably in Germany and Switzerland—he will be required to collect and report on the best text-books, maps, models, and appliances. His honorarium will be 250*l.*, to include travelling expenses, but not the purchase of books, &c., which will be defrayed by the Society on the selection being approved by the Council.

SCIENCE in Japan has recently suffered a severe loss by the death of Dr. A. J. C. Geerts, which took place at Yokohama towards the end of last year at the early age of forty. He had been for fifteen years in the employment of the Japanese Government, and a few weeks before his death his services had been recognised by the Emperor, who conferred on him the Order of the Rising Sun. Dr. Geerts was originally Professor of Chemistry in the School of Military Medicine at Utrecht, and in 1868 was offered by the Japanese Government the post of Professor of Natural Science at the Medical School then recently established at Nagasaki. After occupying this position for five years he was nominated adviser to the Department of Hygiene and Public Health in Tokio, and was also charged with the establishment of a chemical laboratory at Kiôtô. In 1877 he established a similar institution in Yokohama, where his duties consisted chiefly in the testing of foreign drugs imported for sale amongst the Japanese, and this position he held at the time of

his death. Like every other European in the Japanese Government service whose duty compels him to stand between his own countrymen and the natives, and to hold an even balance between the claims of both, his work was frequently of a harassing and unpleasant description; nevertheless he found time to write numerous works on Japan. His papers on Japanese mineral products, communicated during a number of years to the two learned societies in Japan, are of much value. He also published a Japanese Pharmacopœia, an account of the numerous mineral springs in Japan, and finally he commenced, and actually published, two volumes of an encyclopædic work entitled "Produits de la Nature Japonaise et Chinoise," in which he intended to describe the names, history, and application "to arts, industry, economy, medicine, &c., of substances derived from the three kingdoms of nature, and which are employed by the Japanese and Chinese." The formidable nature of this title is in no degree diminished when we come to examine the torso of the work itself. Ordinary men, who bear in mind that human life and human powers are limited, can only stand amazed at the conception of this work; for the author not only ransacked all that had ever been written on China and Japan in Europe, but also examined the whole of Chinese and Japanese literature before he sat down to write even the most insignificant article. In the section "Iron" alone one finds about 200 references to works in all literatures and of all ages. Each section contains the Japanese and Chinese legends respecting the origin and discovery of the production which formed its subject, the places where it has been or is now found, the primitive modes of obtaining it, the various qualities ascribed to it, its employment in arts and industry, &c. From this method of writing, it was inevitable that the work should bear the appearance of a hotch-potch, an *omnium gatherum* of fact and myth; but we could at least feel sure that in each section all that had ever been known of the subject was given. The work was really beyond the power of any single individual, and, if it were to be brought to an end at all, should have been executed on some extensive plan of cooperation similar to that employed in Dr. Murray's English Dictionary. As an example of the minute care bestowed on each point, it may be mentioned that in dealing with "Jade" the author gives two Latin synonyms, two Chinese, thirteen Japanese, a Spanish, a Manchu, a Turkish, a Persian, an Arab, and a Maori synonym!

LIEUT. B. BADEN-POWELL, Scots Guards, made an ascent in his own balloon from Aldershot on Monday last week. The weather at the time of starting (4.30) was threatening and the wind fresh from the north-east. On rising to a height of 4000 feet, a lovely cloudscape was seen, the sky overhead being clear and blue, and a sea of clouds stretching around with very distinct horizon. Below, the earth could be seen through the haze, on which the shadow of the balloon was thrown, a bright halo surrounding the car. The descent was made at a quarter to six, about twenty miles off.

MR. H. O. FORBES writes:—In a note received from the ex-Governor of Timor (now in Lisbon) I learn that a violent earthquake was experienced in Dilly on November 11, which destroyed the hospital and also damaged the church and other edifices, but without loss of life.

THE last number of the *Journal of the Straits Branch of the Royal Asiatic Society* (Singapore, 1883) has the continuation of Capt. Kelham's notes on the ornithology of the Straits Settlements and the western States of the Malay Peninsula; also a collection of Malay proverbs, by Mr. Maxwell. Mr. Cameron contributes a paper on the Patani, the most considerable river of the peninsula, which flows northwards into the Gulf of Siam. An article of extraordinary interest is that on *latah*, a nervous disorder among Malays, or rather the native name applied to

those who labour under the disorder. "It includes all persons of a peculiarly nervous organisation, ranging from those who, from their mental constitution, seem absolutely subservient to another's will, down to those who appear merely of a markedly excitable temperament." Numerous examples of the effect of this mysterious mental affection are added by the writer, Mr. H. A. O'Brien.

WE gladly notice the issue of three new numbers of the *Encyclopedia of Natural Sciences*, from the publishing house of Eduard Trewendt, in Breslau. The tenth number is now out of the *Alphabetical Manual of Zoology, Anthropology, and Ethnology* (part i. l. 36), which with this new instalment has completed its "F," and entered on its "G." The number referred to contains very valuable articles contributed by Gustav Jäger, Reichenow, von Mojsisowics, Roeckl, von Hellwald, Sussdorf, and others. Nos. 19 and 20 of the second part of the collective work have also appeared, both belonging to the *Dictionary of Chemistry*, edited by Ladenberg. Among other valuable articles in No. 19, by Ladenberg, Biedermann, Weddige, and Jacobsen, "Azoverbindungen," by Heumann, and "Benzoesäure" by Weddige, are treated with special completeness. In No. 20 are articles by Engler, Drechsel, Biedermann, and others. These two numbers bring the *Dictionary of Chemistry* to the end of "B." We again wish all success to this comprehensive collective work on the natural sciences.

MM. HENRY are experimenting with a system of photography for double-stars, in order to determine their distance and position angle. They have already obtained good results on about twenty stars in various constellations.

M. LEVEAU has been appointed Astronome Titulaire at the Paris Observatory, in place of the late M. Yvon Villarceau.

In a small pamphlet published at Saigon ("Memoire sur les Poissons de la Rivière de Hué," C. Guillard et Martinon), M. Tirant, the Administrator of Native Affairs, has given a catalogue of the fish to be found in the river of Hué, the capital of Annam, and in the adjacent lagoons. These latter are exceedingly numerous, running parallel to the sea for miles, and are filled during the rainy season by the overflow from the rivers. They are employed as reservoirs for the fish supply of the capital. In them, and in the river itself, Dr. Tirant states he procured seventy new species of fish.

INFORMATION has recently been received in Paris of the death of M. Bruel, one of the most enterprising of French explorers in Cochin China. He was murdered by pirates on January 18 in Cambodia, on the frontier of the Laos country.

THE additions to the Zoological Society's Gardens during the past week include a Rhesus Monkey (*Macacus rhesus* ♂) from Continental India, presented by Mr. A. MacDonnett Green; a Common Fox (*Canis vulpes*), British, presented by Miss Bertha Haig; a Herring Gull (*Larus argentatus*), European, presented by Mr. R. Morton Middleton, jun.; a Green Lizard (*Lacerta viridis*), European, presented by Mr. J. H. Leech; three Russell's Vipers (*Vipera russelli*) from Ceylon, two Indian Rat Snakes (*Ptyas mucosa*), an Indian Python (*Python molurus*), an Indian River Snake (*Tropidonotus quincunciatus*), two Indian Cobras (*Naja tripudians*) from India, presented by Mr. Gerald Waller; a Gray Ichneumon (*Herpestes griseus*) from India, a Short-headed Phalanger (*Belidius breviceps*) from Australia, three Lesser Birds of Paradise (*Paradisaea minor*), two Red-sided Eclectus (*Eclectus pectoralis*) from New Guinea, a Chattering Lory (*Lorius garrulus*), a Three-coloured Lory (*Lorius tricolor*) from Moluccas, deposited; a Dusky Parrot (*Pionus violaceus*) from Guiana, received in exchange; a Smooth-headed Capuchin (*Cebus monachus*) from South-East Brazil, a Severe Macaw (*Ara severa*) from Brazil, two Schlegel's Doves (*Chalcophelia pudla*), a

Buffon's Touracou (*Corythaix buffoni*) from West Africa, a Diademed Amazon (*Chrysotis diademata*), a Yellow-shouldered Amazon (*Chrysotis ochroptera*) from South America, a Banded Aracari (*Pteroglossus torquatus*) from Central America, received on approval; a Mediterranean Seal (*Monachus albiventer*) from the Mediterranean, two Chinchillas (*Chinchilla lanigera*) from Chili, an Anaconda (*Eunectes murinus*) from South America, purchased.

### OUR ASTRONOMICAL COLUMN

THE SOUTHERN COMET (ROSS, JANUARY 7).—Adopting Mr. Tebbutt's elements copied into this column last week, we have the following positions of the comet observed at Melbourne and Windsor, N.S.W., for 6h. Greenwich mean time:—

1883	R.A. h. m. s.	N.P.D.	Log. distance from Earth	Sun
Dec. 16	17 4 30	93 56.9	0.0561	9.6151
18	17 12 4	94 3.2	0.0232	9.5758
20	17 21 35	94 34.4	9.9864	9.5393
22	17 33 53	95 44.7	9.9463	9.5102
24	17 49 54	97 50.8	9.9046	9.4934
26	18 10 31	101 6.2	9.8651	9.4930
28	18 36 2	105 29.2	9.8332	9.5090
30	19 5 47	110 35.5	9.8144	9.5376

This ephemeris, founded upon an orbit which is certainly not open to material correction, enables us to decide that the supposed comet which was seen in Tasmania on the mornings of December 25 and 27, rising a few minutes before the sun, could not have been the comet detected by Mr. Ross on January 7, which on those mornings would not rise (at New Norfolk, for instance) till upwards of forty minutes after the sun; on December 25 the sun rose there at 4h. 21m., the comet at 5h. 2m.

It is not easy to reconcile the estimate of brightness at Melbourne on January 11 with that of Mr. Tebbutt on January 19. Mr. Ellery writes to the *Observatory* that on the former evening the comet disappeared in a faintly illuminated field, simultaneously with a tenth-magnitude star, while Mr. Tebbutt considered it on January 19 to be just beyond unassisted vision; yet the ratio of the theoretical intensity of light on the former date would be to that on the latter as 2.9 to 1.

The comet appears to have been well above the horizon in European latitudes before daylight, previous to the perihelion passage. Between December 17 and 21 it rose at Greenwich about 5h. 40m. a.m., but the presence of the moon would have rendered its discovery difficult. It was nearest to the earth on the morning of January 1, the distance being then 0.646 (the earth's mean distance from the sun = 1).

THE ASPECT OF URANUS.—At the sitting of the Academy of Sciences of Paris on April 21, M. Perrotin presented a note on the aspect of Uranus, from observations made with the 15-inch equatorial at the Observatory of Nice. On March 18 he had remarked, in company with Mr. Lockyer, a bright spot near the lower limb of the planet, as seen in the inverting telescope. Further observations showed that it was near the equator of Uranus. It was a very difficult object, and much uncertainty existed as to its exact position; it was better seen as it approached the limb. It was observed on April 1 about 11h., at the northern extremity of the equatorial diameter, and on the next night about 10h. 30m., at the southern extremity; it occupied the same position on April 7 at 10h. 30m., and April 12 at 11h. These observations, M. Perrotin adds, made at the limits of visibility, required very favourable conditions, and being aware of the possibility of illusion in such a case, he invites the attention of observers possessed of powerful optical means, in order to control his own impressions. The appearance and the indeterminateness in the duration of the phenomenon on April 1, when the images were best, rather point to a luminous belt than to a single spot, which introduces uncertainty in the times of the observations; with due regard to this, M. Perrotin finds a fair agreement with the assumption of a rotation not differing much from ten hours. On April 12 Mr. Trépied was present, and confirmed the impressions received by the Nice astronomer; he also remarked in the bright part a condensation which had previously escaped notice.

By "diamètre équatorial" we presume M. Perrotin refers to the diameter in the plane of the orbits of the satellites.

### UNIVERSITY AND EDUCATIONAL INTELLIGENCE

CAMBRIDGE.—The following courses of lectures are being delivered this term:—

**Mathematics**—Prof. Stokes, Optics; Prof. Darwin, Theory of Potential and Attractions; Trinity College, Mr. Glaisher, Theory of Errors, Mr. Ball, Higher Solid Geometry, Mr. J. J. Thomson, Dynamics of a Rigid Body, Mr. Rowe, Higher Integral Calculus and Abel's Theorem, Mr. Forsyth, Thermodynamics; St. John's College, Dr. Besant, Analysis, for Schedules II. and III., Mr. Pendlebury, Laplace's and Bessel's Functions, Mr. Webb, Elementary Rigid Dynamics; Pembroke College, Mr. Burnside, Hydrodynamics; Emmanuel College, Mr. Webb, Elasticity.

**Physics**—Trinity College, Mr. Trotter, Electricity and Magnetism, Mr. Glazebrook, Elementary Physics; Cavendish Laboratory, Mr. Shaw, Elementary Physics; St. John's College, Mr. Hart, Elementary Electricity, Practical Physics, Cavendish Laboratory; Advanced Demonstrations in Light and Sound; and Elementary Demonstrations in Optics and Electricity.

**Chemistry**—Prof. Liveing, Course of Examinations and Personal Instruction of those who have attended his general course in the last two terms; Mr. Main, General Course, including Carbon Compounds; Mr. Pattison Muir, Non-Metals, and Elementary Organic; Mr. Sell, Elementary Chemistry; Mr. Scott, Gas Analysis; Mr. Lewis, Catechetical Course.

**Practical Chemistry**—Demonstrations for 1st M.B. by Mr. Sell and Fenton; Demonstrations in Qualitative Analysis (Sidney College), Mr. Neville; Practical Courses at St. John's and Caius College Laboratories.

**Mineralogy**—Prof. Lewis; and two Courses of Elementary Demonstrations.

**Mechanism**—Prof. Stuart, Differential and Integral Calculus for Engineering Students; Mr. Lyon, Machine Construction and Heat; Mr. Ames, Surveying and Levelling.

**Physiology**—Elementary, Prof. Foster; Structure and Function of the Central Nervous System, Mr. Langley; Advanced Physiology of Respirations, Dr. Gaskell; Preparation for 2nd M.B., Mr. Hill.

**Human Anatomy**—Prof. Macalister, Anatomical Basis of Anthropology, Advanced; Demonstrations and Dissections.

**Elementary Biology**, Mr. Sedgwick; **Morphology of the Vertebrata**, Mr. Sedgwick; **Mollusca and Tunicata**, Mr. Weldon; **Mammalia**, Mr. Gadaw.

**Botany**—Prof. Babington, Structural and Systematic; **Morphology**, chiefly Cryptogamic, advanced, Dr. Vines; **Demonstration Lectures on Physiology**, Mr. F. Darwin; **Demonstrations in Systematic Botany**, Mr. Potter.

**Geology**—Stratigraphy, Local, Prof. Hughes; **General Course**, Carboniferous to Recent, Dr. R. D. Roberts; **Palæontology**, Elementary, Mr. T. Roberts; **Microscopic Petrology**, Mr. A. Harker; **Climatology**, Mr. E. Hill; **Metamorphism**, Mr. Marr; **Field Lectures**, Prof. Hughes.

### SOCIETIES AND ACADEMIES

#### LONDON

**Royal Meteorological Society**, April 16.—Mr. J. K. Laughton, M.A., F.R.A.S., vice-president, in the chair.—J. Y. Davidson and T. Wright were elected Fellows of the Society.—The following papers were read:—On the origin and course of the squall which capsized H.M.S. *Eurydice*, March 24, 1878, by the Hon. Ralph Abercomby, F.R.Met.Soc. It will be remembered that the *Eurydice*, which was a full-rigged corvette, when passing Ventnor in the Isle of Wight, running free before a westerly wind, with all sails set, was struck by a sudden squall from the north-west; and before sail could be shortened she went on her beam ends, and the lee ports being open, she filled and foundered. The author has investigated the character of the weather preceding and following the day in question, and finds that the squall was one belonging to the class which is associated with the trough of V-shaped depressions. The squall, which originated in the north of England, swept across the Isle of Wight at a rate of about thirty-eight miles an hour. The V-depression was of an uncommon class, in which the rain occurs after the passage of the trough, and not in front of it, as is usually the case. The weather generally for March 24 was unusually complex, and of exceptional intensity, and for this reason some of the details of the changes cannot be explained.—Water-

spouts and their formation, by Capt. J. W. C. Martyr.—The weather forecasts for October, November, and December, 1883, by C. E. Peek, M.A., F.R.Met.Soc. This is a comparison of the weather indicated in the forecasts of the Meteorological Office with that actually experienced at Rousdon in Dorset.—On certain effects which may have been produced in the atmosphere by floating particles of volcanic matter from the eruptions of Krakatoa and Mount St. Augustin, by W. F. Stanley, F.G.S. In this paper were given details of a microscopical examination which had been made of some dust that fell, to the thickness of about two inches, upon the deck of the bark *Arabella*, in lat. 5° 37' S., long. 88° 58' E., at about 1000 miles from Krakatoa, and supposed to be from the eruption of that volcano. The dust under examination was contained upon a single microscopic slide. For the convenience of discussion of the subject the visible forms were separated into eight different kinds of particles:—(a) Small masses and single crystals of mineral matter visible by polarised light only. These were principally of augite and of certain felspars. (b) Very thin chips and scales of the above. (c) Very small masses of dense ordinary pumice. (d) Fractured chips of the above with one thin edge. (e) Light apparently *overblown* pumice in relatively large thin plates. (f) Fractured parts of e, but of larger bubbles traversed by seams upon which septa normal to the surface formerly existed. (g) Fractured parts of e, but of larger plates, with a thicker seam on one edge or on one corner only. (h) Thin glassy plates of e, formerly of relatively much larger size. These are of equal thickness throughout, and generally with one hollow surface. The particles a and b form only about half to one per cent. of the mass, the whole of the remainder being of the different forms of pumice described. The particles g and h, as being much the lightest in proportion to their extent of surface, were most dwelt upon. These particles, which the author termed *bubble-plates*, are of irregular, angular forms. They measure under the microscope, in different directions, from about .5 to .05 mm. The thickness of the plates is fairly uniform, varying between .001 and .002 mm. When there is a seam on one edge, the plate is smaller, and thickens towards the seam. By taking the interior part of a large mass of pumice and breaking it up into fine dust, some similar forms may be discovered. These plates being of quite transparent, volcanic glass (obsidian), they are invisible under the microscope, by direct light; but being placed in a medium of higher refractive power, as Canada balsam, they become clearly defined under oblique illumination, above a spot lens, with careful adjustment. Mr. Stanley suggested that these thin plates were from overblown bubbles of volcanic glass such as forms the mass of pumice; that most probably they were projected from about the centre of the volcanic chimney, where they could maintain a melting temperature until they reached the higher atmosphere; under which conditions the internal steam in each separate bubble would expand in volume through release of external pressure until the bubbles burst in the very thin fragments shown. These thin forms of bubble-plates, having great surface in comparison with their very small masses, were such as were eminently adapted to float in atmospheric currents to great distances. As such particles would descend with their convex sides downwards, they would also be especially adapted to reflect the sun's rays, when the sun sank to the horizon, whereas when the sun was at greater altitude his rays would pass through them nearly unobstructed. It was therefore proposed that the after-glow so often observed since the eruptions of Krakatoa and Mount St. Augustin was possibly due to reflection from these thin plates.

#### DUBLIN

**Royal Society**, March 17.—Section of Physical and Experimental Science.—Howard Grubb, M.E., F.R.S., in the chair.—On the success of an instrument for completing the optical adjustment of reflecting telescopes, by G. Johnstone Stoney, M.A., D.Sc., F.R.S., vice-president of the Society. The author had been astronomical assistant to the late Earl of Rosse, and while in charge of his observatory became impressed with the importance of increasing both the degree of accuracy and the facility with which reflecting telescopes can be adjusted. At the Cheltenham meeting of the British Association in 1857 he described an instrument designed to attain these ends, but had no opportunity of testing its performance till two years ago, when a twelve-inch mirror came into his possession of exquisite defining power, figured by the late Mr. Charles E. Burton, B.A., F.R.A.S. This mirror is mounted as a Newtonian telescope.

The collimator proposed in 1857 was made for it last autumn by Mr. Howard Grubb, M.E., F.R.S., and its performance has been fully tested with the most satisfactory results during the present observing season. The new collimator is a short telescope of eleven inches focus and two inches aperture, which, when used, is to be inserted into the eyepiece-holder of the large telescope. A spark between platinum points is produced in the focus of this instrument by a small Rhumkorff's coil such as those sold with toy apparatus, and the light of the spark emerging from the collimator is reflected by the small mirror of the Newtonian, and so reaches its large mirror. By pushing the eyepiece and platinum points of the collimator a little inside its focus, the beam of light, as it passes down the large telescope, is rendered slightly divergent, and falls normally on the large mirror. If everything is in perfect adjustment, the beam of light will then, after reflection by the large mirror, retrace its steps, and, reentering the collimator, will form an image coincident with the spark. Any want of adjustment is at once betrayed by the image in the field of view of the collimator not being coincident with the spark. On commencing the night's observing, the mirrors of the large telescope are first adjusted in the usual way. The collimator is then put into the eyepiece-holder, and if the telescope has been tolerably well adjusted, the image of the spark will be found not farther from the spark than a quarter or a third of the field of view of the eyepiece of the collimator. The adjustment is then completed in the following way:—The eyepiece-holder, instead of being rigidly attached to the tube of the telescope, is mounted on a triangular plate fastened to the side of the telescope by screws acting against springs at the corners. By these screws the line of collimation of the eyepiece-holder can be slightly altered, and by moving them the image of the spark is made to coincide with the spark. The instrument is then in a condition of optical adjustment vastly more perfect than has hitherto been attainable with reflecting telescopes. This whole process occupies less than half a minute, and is so easy of application that the author is in the habit of repeating it every time the telescope is moved to a fresh object. He is rewarded by having the last degree of refinement applied to the adjustment of his telescope in using it upon every object, an advantage the importance of which will be appreciated by every astronomer who uses a sufficiently fine mirror and is working on a sufficiently good night.—Mr. J. Joly, B.E., read a paper entitled "Notes on a Microscopical Examination of the Volcanic Ash from Krakatoa." The ash examined was part of some which fell on board the Norwegian barque *Borjild* while she lay at anchor off the great Kombuis Island on August 27, 1883. Her position was some 75 miles to the north-east of Krakatoa, a strong south-westerly gale prevailing at the time. She was hence most favourably placed for receiving good samples of the dust. A specimen of the floating pumice, picked up by the *Borjild* in the Straits of Sunda, was compared with the ash. Microscopically they were found to present the same features. Two species of pyroxene occur—a monoclinic and a rhombic variety. The first was augite; the second presents many of the optical characteristics of hypersthene. Both contain much magnetite. A triclinic feldspar is very abundant, showing many different crystalline shapes. The identity of many of these with the triclinic feldspar is shown by their occurrence, twinned with and superimposed upon crystals presenting undeniable plagioclastic characteristics. They show small angles of extinction. The presence of sanadine appeared doubtful. Iron pyrites was found in the ash, both embedded in vitreous fragments and free, as aggregations of cubes, showing the striations at right angles for adjacent faces. Magnetite is abundant. The frequency of lines of growth on the feldspars seemed indicative of a comparatively tranquil formation. Most of the crystals showed a fine coating—much pitted and reticulated—of vitreous matter. A sudden mechanical separation from a viscous magma would explain this appearance, which somewhat resembled that produced by rapidly separating two flat surfaces compressing a viscous substance. Organic remains were found abundantly in both ash and pumice. A foraminiferal shell, very perfect, was found in the ash, and another in the pumice. Fragments, apparently of some algae, were found plentifully in the former.—Dr. R. S. Ball, F.R.S., exhibited Mr. Common's photograph of the great nebula in Orion.—Prof. G. F. Fitzgerald, F.R.S., exhibited Ayrtton and Perry's new spring ammeter.

Section of Natural Science, W. Frazer, F.R.C.S.I., in the chair.—On spherical or globular phosphorites of Russian Podolia,

by Prof. J. P. O'Reilly, C.E.—Catalogue of Vertebrate fossils from the Siwaliks of India, by R. Lydekker, B.A., F.G.S., F.Z.S. Communicated by V. Ball, M.A., F.R.S.—On the action of waves on sea-beaches and sea-bottoms, by A. R. Hunt, M.A., F.G.S. Communicated by Prof. A. C. Haddon, M.A., F.Z.S. After detailing the conflicting views put forward by various authors, Mr. Hunt discusses Mr. Scott Russell's theory of oscillatory waves being converted into waves of translation, with observations and experiments to disprove it. The author then treats of the action of waves, currents, and wind currents on beaches, shingles, and sandbanks as observed in the neighbourhood of Torquay, and describes experiments conducted in a specially constructed tank.

## EDINBURGH

Royal Physical Society, April 23.—Dr. Traquair, F.R.S., in the chair.—Mr. Hugh Miller, A.R.S.M., read a paper on boulder-glaciation and striated pavements. Starting from local observations made near Edinburgh by Charles Maclaren and Hugh Miller upon the glaciation *in situ* of boulders and boulder pavements in the till, the author has been led to the conclusion that boulder-glaciation *in situ*, registering the ice-movement during the formation of the till, is extremely common. The glaciation of the county of Northumberland, to which he referred in passing, may be roughly divided into upland-glaciation, valley-glaciation, and glaciation of the seaboard. All these are registered equally well in the striation of the larger boulders (whether singly or in groups) as in that of the rock below. He confirmed the older observations that the glaciating agent was the same in both the rocks and the boulders, adducing the fact as strong evidence of the glacier origin of the deposit. That floating ice should striate in fixed directions so many blocks lying in soft mud at the sea-bottom he regards as impossible. As registering changes in ice-movement, the intercrossing of erratics, and a distinction between successive boulder-clays, this widespread glaciation of boulders *in situ* may prove of general importance and a distinguishing mark of the true till.

## PARIS

Academy of Sciences, April 21.—M. Rolland in the chair.—Letter of condolence to the family of the late M. Dumas from the *savants* of Geneva.—On a theorem of Kant relating to the celestial mechanism, by M. Faye.—On the scale of temperatures and on molecular weights, by M. Berthelot. The author endeavours to show that a profound study of specific heats tends to establish the fact that heat, which resolves compound molecules into their elements, has also the effect of resolving the highly complex groups of particles which constitute the bodies hitherto regarded as elementary.—On the optical identity of the crystals of herderite of Ehrenfriedersdorf with that of the State of Maine, by M. Des Cloizeaux.—Account of a young gorilla recently brought from the Gaboon and now in the menagerie of the Natural History Museum, Paris, by M. Alph. Milne-Edwards. This specimen is described as of a much more ferocious character than the chimpanzee or orang-utan, and greatly inferior in intelligence even to the gibbon.—Note accompanying the presentation of the marine charts and hydrographic documents offered to the Academy by the Depot of Charts and Plans on behalf of the Department of Marine, by M. de Jonquières.—On the separation of phosphoric acid in arable lands, by M. de Gasparin.—On the speed attained by Lapps with their snowshoes; extract from a letter addressed by M. Nordenskjöld to M. Daubrée. From the result of races instituted for the purpose of determining this point, an average speed of over six miles per hour was verified at Quickjock in Lapland.—Further observations on the present appearance of the planet Uranus as observed at the Observatory of Nice during the month of April, by M. Perrotin.—Changes observed in the rings of Saturn, by M. E. L. Trouvelot. From continued observations made since the year 1875 at the Meudon Observatory the author is able definitely to confirm the conclusion already arrived at, that the rings, so far from being fixed, are extremely variable.—On surfaces of the third order, by M. C. Le Paige.—On uniformly inclined surfaces and proportional systems, by M. L. Lecornu.—On the principle of the prism of greatest thrust, laid down by Coulomb in the theory of the limited equilibrium of sandy masses, by M. J. Boussinesq.—On the diffusion of light through unpolished glass or metal surfaces, by M. Gouy.—On the propagation of sound through gases, by M. Neyreneuf.—On the boiling-point of oxygen, air, nitrogen, and the oxide of car-



bon under atmospheric pressure, by M. S. Wroblewski.—On a metallic radical, by M. P. Schutzenberger.—Determination of the densities of the vapours of the chloride of glucinum, by MM. L. F. Nilson and Otto Pettersson.—On the neutral molybdate of didymium, and on the equivalence of didymium, by M. Alph. Cossa.—On the curves of solubility of salts, by M. A. Étard.—On the bark of *Xanthoxylum caribaum*, Lk., as a febrifuge, by MM. Heckel and Fr. Schlagdenhauffen.—On the application of the digester for the destruction of microbes in liquids, by M. L. Heydenreich.—On some siliceous spicules of living sponges obtained from the dredgings executed during the last expedition of the *Talisman*, by M. J. Thoulet.—On the generic relations of *Orbulina universa* with *Globigerina*, two illustrations, by M. C. Schlumberger. From the comparative study of these organisms the author infers that the dimorphism of the Foraminifera is an initial character resulting from two original forms.—On the action of heat on the phenomena of vegetation: (1) on the development and direction of the roots; (2) on the heliotropism of certain plants, by M. A. Barthélemy.—On marine and fresh-water deposits considered from the economical standpoint, according as they are or are not sulphuretted; alluvia of the Durance, by M. Dieulaufait.—New report on the diamantiferous deposit at Grão Mogol, province of Minas Geraes, Brazil, by M. Gorceix.—On the bones of the head of the Simœodosaurians, and on the various species of this extinct reptile found in the Cernay formations in the Rheims district, by M. V. Lemoine.—Note on the crepuscular phenomena observed at the Imperial Observatory of Rio de Janeiro during the winter months of 1883-84, by M. L. Cruls.—Note on the scientific mission to Cape Horn 1882-83 in connection with the question of the periodicity of barometric oscillations, by M. Ch. V. Zenger.

## BERLIN

**Physical Society**, March 21.—Dr. Frölich spoke of some modifications of Wheatstone's bridge which had been applied to the measurement of the electric resistance of galvanic elements and batteries. Wheatstone's bridge consisted, as was known, of a wire quadrilateral and two wire diagonals. Of the two diagonals one contained a battery of constant electromotive force, the other the galvanometer. In these circumstances the resistances of the four lateral wires showed the proportion  $W_1 : W_2 = W_3 : W_4$ . For the purpose of measuring the resistance in a galvanic battery, the arrangement was so far empirically changed that the battery to be measured was inserted in one of the lateral wires. A second empirical method consisted in inserting the galvanometer into one diagonal wire and interrupting the second; the battery to be measured was placed in a lateral wire. Dr. Frölich showed that both arrangements were only modifications of Wheatstone's bridge. The way in which these modifications originated might be conceived by supposing that the bridge was formed of cords, and that the angles of the square were successively shifted; the proportion which applied to Wheatstone's bridge would still hold in the new case. Dr. Frölich laid down a general law applicable to all individual cases. If in a Wheatstone bridge an element be inserted into each wire, while one diagonal wire contained the galvanometer, and the other was interrupted, if, moreover, on opening this wire, the electromotive force in the other diagonal remained unchanged, then the proportion above stated between the resistances of the lateral wires would still hold. Whether this general law included such a case as could be applied practically and with certainty to the measurement of the resistance of elements must be determined by experience.—Dr. Frölich then gave a report on the continuation of his measurements of solar temperature. At a former sitting he communicated the measurements he had made during the previous year. These measurements yielded an almost equal result on June 29 and July 1, an increase of solar heat of 6 per cent. over this last estimate on August 14, and a value pretty nearly equal to that of July 1 in the middle of October. Since then doubts had been expressed as to whether the calculated increase of solar heat in August corresponded with the fact, seeing that the amount of the difference was not so much greater than might be accounted for by assuming an error, not easily avoided, in an observation. In opposition to this consideration, Dr. Frölich contended that, even if it were claimed that the difference would have to be three times greater than any error in observation which might probably occur, the increase in August had such a high degree of probability in its favour that one might bet 22½ to 1 for its accuracy. All doubt, however, on the matter was completely removed by

two measurements Dr. Frölich made on February 19 and March 17. Both measurements yielded pretty nearly equal values of solar heat, and one was 15 per cent. higher than the estimate of the middle of October last year. In this case the probable error was surpassed eight times. Dr. Frölich was of opinion that the increase of solar heat in August was connected with an assumed formation of sunspots, and seeing that the spots were bound up with the magnetism of the earth he made inquiries with a view to ascertaining the state of the terrestrial magnetism at that time. From the average of the reports collected by him he found that in correspondence with the increased solar heat in the middle of August there was a diminution of the earth's magnetism.—At the close Dr. Frölich produced a large lump of magnesium as the product of an electrolytic industry. The piece was wrought in a factory according to a patented method based essentially on the melting of chloride of magnesium, and decomposing it in the melted state by an electric current.

## VIENNA

**Imperial Academy of Sciences**, March 20.—L. Martin, on the polydimensional argument.—R. von Drasche, on some new and less-known ex-European Ascidia.—T. Latschenberger, on testing and determining ammonia in animal fluids.—W. Possek, synthesis of dyad alcohols by action of alcoholic potash on aldehydes.—On the action of phosphorus trichloride on aldehyde, by the same.—F. Wiesner, on geotropic curvature of roots.—F. W. Dafert, synthesis of glycuronic acid from manite (sealed packet).—K. Olszewski, determination of density and of coefficient of expansion of liquid oxygen.—Determination of the temperature of solidification of some gases and liquids, by the same.

April 3.—A. Adamkiewicz, preliminary communication on new stainings of the spinal cord, part ii.; results obtained by staining the diseased spinal cord with saffronine.—M. Loewit, contributions to theory of blood-coagulation, part i.; on the coagulating power of the blood-disks.—A. Lustig, contributions to development of gustatory buds.—T. V. Tanowski, on direct substitution-products of azobenzene and on an asymmetrical trinitroazobenzene.—E. Witlaził, on polymorphism of *Chactophorus populi*, L.—M. Strainsky, on tides and their reaction on the configuration of the earth's surface.—R. Benedikt and K. Hazura, on morin.—R. Benedikt and P. Julius, on diresorcin and diresorcinphthaline.—K. Hazura and P. Julius, on resorcin-ether.—P. Julius, on a new reaction of benzidine.

## CONTENTS

	PAGE
Science and Manufactures . . . . .	1
Forster's "Strata of the North of England" . . . . .	3
Our Book Shelf:—	
Watts's "Manual of Chemistry" . . . . .	3
Woodward's "Arithmetical Chemistry" . . . . .	4
Reynolds's "Experimental Chemistry" . . . . .	4
Letters to the Editor:—	
Reply to Mr. Grubb's Criticisms on the Equatorial Coudé of the Paris Observatory.—M. Loewy . . . . .	4
On the Motion of Projectiles.—Rev. Francis Bashforth . . . . .	5
The Dry and Wet Bulb Thermometers "Froude."—Prof. H. A. Hazen . . . . .	6
Extraordinary Darkness at Midday.—Rev. S. J. Perry, F.R.S. . . . .	6
Intelligence in Animals.—Duncan Stewart; Dr. John Rae, F.R.S. . . . .	6
The Absorption of Water by Plants. By Francis Darwin, F.R.S. . . . .	7
What is a Liberal Education? By Prof. S. Newcomb . . . . .	9
The Krakatoa Eruption. By R. D. M. Verbeek . . . . .	10
The Late Monsieur Dumas . . . . .	15
The Earthquake. By W. Topley; Surgeon-Major W. C. B. Eatwell; Dr. J. E. Taylor; Albert H. Waters; Rev. O. Fisher; G. M. Whipple; J. Edmund Clark . . . . .	17
Notes . . . . .	19
Our Astronomical Column:—	
The Southern Comet (Ross, January 7) . . . . .	21
The Aspect of Uranus . . . . .	21
University and Educational Intelligence . . . . .	22
Societies and Academies . . . . .	22

THURSDAY, MAY 8, 1884

*A PLEA FOR A NATIONAL MARINE  
ZOOLOGICAL SURVEY*

**W**HILST the influential meeting recently held at the Royal Society, for the purpose of founding a Society for the Biological Investigation of the British Coast, is still in the minds of naturalists, the present occasion is a fitting opportunity for the expression of opinions respecting the scope and aims of such an undertaking, as well as to suggest in what way zoological investigation in general may be more systematically directed than has hitherto been the case in this country.

The primary object of the newly-formed Society, as indicated in the resolutions passed at the preliminary meeting, is the establishment of a zoological station. This of itself is an important step in the right direction; and though much will depend on the thorough organisation and efficient management of the station, the hearty thanks of naturalists are already due to Prof. Ray Lankester for the energy and perseverance with which he has brought this desideratum within possible attainment. The establishment of a zoological station, however, or even of a number of stations at different parts of our seaboard, is not the only thing wanted. Neither should the maintenance of a single biological laboratory be the only aim of such a Society as the one proposed. Indeed it may be seriously questioned whether a Society is the best, or even a necessary, piece of machinery for the maintenance of a zoological station at all, excepting solely as a subscribing body, and even in this capacity its efficiency may prove inadequate. It is therefore to be hoped that the new Society will realise that there are broader and more extensive claims which zoology has a right to make in a country so peculiarly placed as Britain.

Few will deny that, notwithstanding the impetus given to the study of zoology during the last quarter of a century by the theory of evolution and the revelations of embryology, this branch of science appears in many respects to have been more backward than several of the kindred sister sciences in revising methods of investigation in accordance with the spirit of the age. Biology and morphology have of course made advances whose importance cannot be over-estimated; but it would seem that Zoology—in the wider sense—might well take a leaf out of the book of her much younger sister, Geology. Years ago, quite in the infancy of that science, national geology was placed upon a systematic basis by the establishment of the Geological Survey. The reason of that step is perhaps not far to seek. It stood mainly upon utilitarian grounds. The geologist was able to show that a knowledge of his science directly concerned the mineral wealth of the country, and that he offered as it were the key to the then secret storehouses of coal, ores, and water, which were unmistakable synonymous terms for national wealth, advancement, and prosperity. It is quite unnecessary in the present place to do more than refer incidentally to the admirable manner in which the Geological Survey has fulfilled, and is still fulfilling, the purpose of its being. While constantly keeping in view the industrial applications of geology, it has at the same time never lost

sight of the strictly scientific problems which the geological structure of the country presents in such abundance. Its success in both these departments may well point the argument that the zoologist has an equal share, and an equal power to assist, in the nation's welfare, besides possessing his own ample domain in science.

The insular position of this country naturally causes the sea fisheries and all that pertains thereto to be an important factor from a national and pecuniary point of view. The food, the habitat, the cultivation, the development, the enemies, and the diseases of fish all lie within the province of the zoologist; and it is to him alone that we can come for information on these questions, whereon the prosperity of our national fisheries depends, just as it is to the geologist that we go for direction as to the acquirement of the coal and ores that lie treasured beneath our feet, or as to the sources and quality of the water required for the supply of towns. On these grounds national marine zoology may claim an equally systematic method of investigation and an equal recognition as an important handmaiden to national wealth. Patriotism, as well as the desire for the advancement of human knowledge, would therefore urge with all possible earnestness the establishment of a national Marine Zoological and Physical Survey, whereby the fauna and the conditions of every portion of our coast should be carefully investigated. Apart from the unquestionable advantages that would thus be afforded to our fisheries, it is not too much to promise that by this means a greater amount of light would be thrown upon the life-histories of marine organisms, upon the variations of species, and the conditions upon which these depend, together with the solution of a greater number of important zoological problems than we could otherwise ever hope to attain. From a geological point of view, also, it is most desirable to have a better knowledge of the deposits now forming around our coasts. Other countries have already recognised these claims, and the fruition of their foresight is too well known to naturalists to need recapitulation here.

Such a scheme as the present naturally demands national encouragement and Government support. Many will of course say that the British Government is too much hampered and proverbially backward in assisting scientific projects to undertake what is here briefly indicated. May not, however, the want of success in obtaining assistance from Government be found to lie too frequently in the imperfect and partial manner in which application is made? Ministers and members of Government are too frequently "asked" in a private, unofficial manner whether support might probably be obtained for such-and-such an object; and should this happen to be one with which they are little conversant, it is only natural that the answer should frequently be unsatisfactory.

The establishment of a systematic and permanent Zoological Survey has, from its direct relation with a great national source of wealth, apart from its equally important scientific bearings, a logical claim which cannot be gainsaid; and it is scarcely to be supposed that a properly organised application would fail to be favourably received by the Government. In the event, however, of the prayer of such an application being rejected, the onus of neglecting an important British industry would obviously then rest on the shoulders of the Government; and scientific

men would at least have done their duty in urging its claims and pointing out whereby it might be protected and augmented. It unfortunately happens that up to the present time scientific men have brought no definite scheme or proposition of this kind directly before Government; and the onus of neglect may consequently in a certain sense be said to rest now at their door.

The honour of removing this responsibility lies directly within the scope of the newly-formed Society for Biological Investigation; for naturally no other body of men could more readily put themselves into communication with the various kindred societies throughout the kingdom, and thus obtain a unison of views upon this important subject. The next step would be to elect an influential representative deputation from the Society to wait upon the Prime Minister for the purpose of urging the appointment of a Parliamentary Commission to inquire exhaustively into the various subjects pertaining to a Zoological Survey.

#### THE ELECTRICAL CONGRESS OF PARIS, 1884

THE first Congress of 1881 has borne good fruit. It has not only brought about an *approchement* between electricians of all countries, but it has led to the adoption of an international system of measurement which will be in universal use. It is satisfactory to find that there are questions which can be amicably settled internationally. The Congress was divided into three Commissions which dealt with (1) electrical units, (2) atmospheric electricity and earth-currents, (3) standard of light. The first Commission virtually dealt with the length of a column of mercury of one square millimetre section which represented the ohm—it having been decided at the Congress of 1881 that this should be the unit of resistance. Many physicists had been working on this in different countries and on different methods. M. Mascart grouped the results in the following useful table:—

Methods	Experimenters	Column of Mercury in Centimetres
1. B.A.	{ British Association	104·83
	{ Rayleigh-Schuster	106·00
	{ Rayleigh (1882)	106·27
	{ H. Weber ...	106·16
2. Weber (I.) ...	{ Kohlrausch	105·81
	{ Wiedemann ... ..	106·19
	{ Mascart ... ..	106·33
3. Kirchhoff ...	{ F. Weber ... ..	105·02
	{ Rowland ... ..	105·79
	{ Glazebrook ... ..	106·29
	{ Mascart ... ..	106·33
4. ... ..	{ Röiti ... ..	105·9
5. ... ..	{ Fr. Weber ... ..	105·33
	{ Lorenz (first) ... ..	107·1
6. Lorenz ... ..	{ Rayleigh ... ..	106·24
	{ Lenz ... ..	106·13
	{ Lorenz (second) ... ..	106·19
	{ Dorn ... ..	105·46
7. Weber (II.) ...	{ Fr. Weber ... ..	105·26
	{ Wild ... ..	105·68
	{ Bailla ... ..	105·37
8. Heat ... ..	{ Joule ... ..	106·22

From this it appears that the figures obtained by the different methods were—

B.A. ... ..	106·21
Weber's I. ... ..	106·14
Kirchhoff's ... ..	105·93
Lorenz ... ..	106·19
Weber's II. ... ..	105·47
Joule ... ..	106·22

The mean of which was 106·02, but 106 was taken as a round figure sufficiently near the truth for all practical and useful purposes. Hence the Congress decided that "the legal ohm should be the resistance of a column of mercury of one square millimetre section and of 106 cm. of length at the temperature of freezing," and a resolution was passed desiring the French Government to transmit this resolution to the different Governments, with a view of making its adoption international. It was decided that primary standards should be constructed in mercury, but that secondary coils should be made of solid alloys, which should be frequently compared among themselves and with the primary standard.

It was resolved that the ampère should be exactly  $10^{-1}$  C.G.S. electromagnetic unit of current, and that the volt should be the electromotive force which maintained an ampere in a conductor whose resistance was the new ohm.

We can now congratulate ourselves upon having a scientific system of electrical units independent of any particular instruments or of any particular process. It is not absolutely exact. That is, the new ohm is not  $10^9$  C.G.S. units, but it is the nearest approach to it that can be practically attained. It will probably be known as the *Congress ohm*, to distinguish it from the true ohm ( $10^9$  C.G.S.) or the B.A. ohm of 1864.

One subject of regret is that Prof. Rowland's measurements in Baltimore are not completed, and will probably not be ready before the end of the year. The United States Congress voted a large sum of money to enable this to be done. He is using a Planté secondary battery and employing three methods, viz. Kirchhoff's, Joule's, and Lorenz's. His well-known experimental skill has given much interest to this investigation of Rowland's.

The second Commission dealt with atmospheric electricity and earth-currents, and recommended that it was desirable to send each year to the Bureau International des Administrations Télégraphiques in Berne the reports that were collected in the different countries, so that they might be distributed to the different Governments.

The third Commission dealt with the standard of light, and it was decided, not without considerable opposition, that the unit for each simple light should be the quantity of light of the same kind emitted in a normal direction by a square centimetre of surface of fused platinum at the temperature of solidification, and that the practical unit of white light should be the total quantity of light emitted normally by the same source. This is a very unsatisfactory standard. It was accepted because there was virtually none other before. But it was obtained by only one observer (M. Violle); it is not portable; it is not even reproducible except at great expense, and it is so eminently impracticable that it is scarcely likely to be generally adopted. It is to be regretted that the British Association Committee on a Standard of White Light has not yet finished its work, but we may hope that at Montreal Capt. Abney will be able to give some results which will give us a better and more practical standard.

There was a universal consensus of opinion that the Congress had faithfully and earnestly done its work, and that the success of its labours and the rapidity of its action was due to the energy and ability of M. Cochery, the Minister of Posts and Telegraphs. Our English representatives were Sir William Thomson, Capt. Abney,

Prof. Carey Foster, Prof. Hughes, Prof. Fleeming-Jenkin, Mr. Graves, and Mr. Preece. The full text of the resolutions is as follows:—

"I. *Electric Units*, strictly so called. First Resolution: The legal ohm is the resistance of a column of mercury of a square millimetre cross-section and 106 centimetres in length at the temperature of melting ice. Second Resolution: The Conference expresses the wish that the French Government should transmit this resolution to the different States, and recommend an international adoption of it. Third Resolution: The Conference recommends the construction of primary standards in mercury conformable to the resolution previously adopted, and the concurrent employment of scales of secondary resistances in solid alloys which shall be frequently compared amongst one another and with the primary standard. Fourth Resolution: The ampere is the current the absolute value of which is ten to the power minus one in electro-magnetic units. Fifth Resolution: The volt is the electromotive force which maintains a current of one ampere in a conductor the resistance of which is one legal ohm.

"II. *Earth-Currents and Lightning-Rods*. First Resolution: It is to be desired that the results of observations collected by the various administrations be sent each year to the International Bureau of Telegraph Administration at Berne, which will make a digest of them and communicate it to the various Governments. Second Resolution: The Conference expresses the wish that observations of earth-currents be pursued in all countries.

"III. *Standard of Light*. Resolution: The unit of each kind of simple light is the quantity of light of the same kind emitted in a normal direction by a square centimetre of surface of molten platinum at the temperature of solidification. The practical unit of white light is the quantity of light emitted normally by the same source."

#### DR. JOULE'S SCIENTIFIC PAPERS

*The Scientific Papers of James Prescott Joule, D.C.L., LL.D., F.R.S., &c.* (London: Published by the Physical Society, 1884.)

OUR benefactors are oftentimes unrecognised! The writer of the present notice of our latest acquisition in scientific literature, takes credit to himself for having been the first to propose to Sir William Thomson the reprinting of his original papers. Seized with a great desire to possess those invaluable electrostatic papers, which, in 1867, could only be read in the original by those who were fortunate enough to have access to the *Cambridge and Dublin Mathematical Journal*, he urged that there must be many others by whom a reprint would be gladly welcomed. Thus was originated the reprint of the "Electrostatics and Magnetism."

The initiative being taken, we have now a second series from Sir William Thomson—part published, part in progress—intended to include all his mathematical and physical papers. Prof. Stokes also, under the influence of pressure and good example, has produced the first half of a reprint of his classical papers. Abroad we have collections of the papers of Prof. von Helmholtz and Prof. Kirchhoff. Last at the present moment, but far from the

least in importance or in general interest, we have the first volume of republished papers by Mr. Joule.

But what a debt of gratitude we owe to the Physical Society for its publishing enterprise—first for the publication of Prof. Everett's "Illustrations of the C.G.S. System," a book which has been helpful to every student of physical science; then for its graceful tribute to the memory of Wheatstone; and now for this fresh and most happy undertaking.

Before looking at the papers themselves, let us unburden ourselves of one or two remarks. The form of the book is admirable. The printing and the diagrams are all that can be desired. The accuracy of the author of the papers, who has personally undertaken the editing, appears in that there is scarcely a misprint to be found in the 650 pages. One serious want, and one only, we have felt, and it is this. Throughout the book there are many back references to previous papers. These references are given in footnotes exactly as they were given in the original papers, thus, *Phil. Mag.*, ser. 3, vol. xiii. p. 268. But what the reader of the book wants, nay absolutely requires, is the reference to the page of the reprint itself where the passage alluded to is to be found. May we be allowed to suggest this as an improvement for the second volume now promised?

To come to the papers themselves, almost one hundred in number. There is a considerable number of unconnected papers on a great variety of subjects, several on meteorological phenomena, six or eight on new instruments or modifications of instruments, a mercurial pump, an improved barometer, a new dip circle, a current meter, &c., in addition to his tangent galvanometer, and one or two others to which we will immediately refer more particularly; then we have a paper on utilisation of sewage; a note on the prevalence of hydrophobia; improvements in the common kite, &c.: all of considerable value. For the most part, however, the papers are on two or three classes of subjects very closely connected, and these are of superlative interest, containing, as they do, the germs, or rather affording the foundation, of the modern theory of energy.

Mr. Joule's papers are remarkable in form as well as in substance. Of mathematics there is scarcely a line: but what clearness, and depth, and penetration into the hidden things of Nature! Thus their interest is general to an unusual degree. To those who shun the labour of arriving at results by "chasing the  $\rho$ " through mazes of equations they are the perfection of clear exposition of fundamental principles. The mathematician, on the other hand, finds in them a model of concise expression, and results of experimental investigation stated in a form ready and convenient for being represented in mathematical symbols.

It is impossible within the limits to which these lines are necessarily confined to notice exhaustively the investigations themselves, or even the results arrived at. We must content ourselves with a brief reference to some of the most important.

The first subject which seems to have attracted the attention of Mr. Joule was that of magnetism and the electro-magnetic engine. His earliest papers are taken up with the description of novel forms of the electro-magnetic engine, and of experiments in this connection. In a very early paper he investigates the laws relating to

what is now commonly spoken of as the *back electromotive* force of a motor. In connection with these researches Mr. Joule obtained valuable results with regard to the construction and the efficiency of various forms of magnets, both permanent magnets and electro-magnets, and he was led also to improvements in the galvanometer which, in the form of the tangent galvanometer, he afterwards perfected.

These experiments led naturally to investigations on the connection between heat, electricity, and mechanical energy, and to a comparison between electricity obtained from chemical action and that obtained from magneto-electric machines, and also to an examination into the heat given out during electrolysis.

A paper of March 1841, on the heat evolved by metallic conductors of electricity and in the cells of a battery during electrolysis, is of special interest. It is here that the law is first announced that the heat developed by a current of electricity, whether through a metallic conductor or in an electrolytic cell, is proportional to the resistance and to the square of the current. It is proved that the whole heat generated by a voltaic battery is proportional to the chemical action which goes on in each cell of the battery multiplied by the whole "intensity" or electromotive force; and the localities at which the several portions of the heat developed in a compound circuit, are clearly distinguished, and the quantities of heat developed in each part are determined.

In this paper improvements in the galvanometer are referred to. A "degree of electricity," or unit-current, is defined as "the quantity of current electricity which is able to electrolyse a chemical equivalent expressed in grains in one hour of time." Hence the results in this paper, and in many others which follow and in which the same *degree* is used, are now easily reducible to absolute measure. His degree was somewhat less than two amperes, or one-fifth of the absolute C.G.S. unit. In this paper also he defines his *first unit of resistance*—a wire of copper ten feet long and 0.024 of an inch in diameter (about No. 23 B.W.G.); and it is curious and somewhat amusing to find that the copper wire which Joule used for this unit must have been preternaturally *bad*! If the wire had been of "conductivity" copper, such as is now universally insisted on, the resistance would have been 0.167 ohm. An easy calculation from Joule's results shows that the resistance must have been at least one-half more! It was not until the manufacture of the 1858 Atlantic cable was in progress that it was found that variations, not previously dreamed of as possible, were commonly to be met with in the conductivity of copper wire.

A most interesting paper on the electric origin of the heat of combustion, also in 1841, naturally follows that just referred to. It is in this paper that Joule determines the *electromotive force necessary to decompose water*. He finds it to be 2.8 of Smee's elements, and then proceeds to similar determinations for various chemical compounds used as electrolytes.

Space fails altogether for mentioning the multitude of interesting results, then perfectly unknown, which Joule brings out in these early papers. Many of them have played important parts in guiding and in assisting other investigators. We find tests recorded as to permanency

of resistance coils. We have investigations of the resistance of electrodes of various materials in various electrolytic cells. Joule's early (1841 to 1844) determinations enabled Sir William Thomson in 1851 to calculate in absolute measure the electromotive force of a Daniell's cell. He found it to be 2,507,100 British absolute units or 1.0739 volt! It is doubtful whether we are assured of a better result at the present day.

We must notice next the series of papers containing Joule's researches on the dynamical equivalent of heat, unquestionably the most important of all his investigations. The complete and successful prosecution of this investigation belongs to Joule, and to Joule alone. The methods are his; the carrying out of the experiments is his. The result will ever be known under the honoured name of "Joule's equivalent."

It is interesting to notice the first germ of the idea, and to be enabled to follow, from its commencement to its conclusion, the series of experiments which gradually brought out the result with which we are now so well satisfied.

In a paper dated January 24, 1843, we find the first mention of the idea as follows:—

"The magnetic electrical machine enables us to convert mechanical powers into heat by means of the electric currents which are induced by it. And I have little doubt that, by interposing an electro-magnetic engine in the circuit of a battery, a diminution of the heat evolved per equivalent of chemical change would be the consequence, and this in proportion to the mechanical power obtained."

A note dated February 18, 1843, is as follows:—

"I am preparing for experiments to test the accuracy of this proposition."

The results of the experiments alluded to in the note just quoted were given to the British Association at its meeting at Cork, in a paper read on August 21, 1843, "On the Calorific Effects of Magnetic Electricity, and on the Mechanical Value of Heat." The experiments were made by rotating "an electro-magnet immersed in a vessel containing water between the poles of a powerful magnet, to measure the electricity thence arising by an accurate galvanometer, and to ascertain the caloric effect of the coil of the electro-magnet by the change of temperature in the water surrounding it."

Permanent steel magnets were first employed for producing the magnetic field, and afterwards a huge stationary electro-magnet was used for this purpose. The writer of the present notice well remembers the interest with which this great rough magnet and its accompaniments were viewed, by some of the foreigners who visited the Loan Collection of Scientific Apparatus at South Kensington in 1877.

Joule's conclusion, given to the British Association at this time was that the mechanical equivalent of a water pound-degree Fahrenheit of heat was 838 foot-pounds of work. In a postscript to this paper, of date August 1843, he says:—

"I have lately proved experimentally that heat is evolved by the passage of water through narrow tubes. My apparatus consisted of a piston perforated by a number of small holes working in a cylindrical glass jar containing about 7 lbs. of water. I thus obtained one degree of heat per pound of water from a mechanical force capable of raising about 770 lbs. to the height of

one foot, a result which will be allowed to be very strongly confirmatory of our previous deductions."

In 1844 we have a paper communicated to the Royal Society on "Changes of Temperature produced by the Rarefaction and Condensation of Air." This paper was not accepted by the Royal Society for its *Transactions*, and the *Philosophical Magazine* had the honour of publishing it! In 1845, in a paper read before the British Association, he describes experiments made by stirring water with a "sort of paddle-wheel" in a "can of peculiar construction;" and in 1846 this was followed by an important paper on "Heat disengaged in Chemical Combinations."

It was, however, in 1849 that his celebrated paper "On the Mechanical Equivalent of Heat" was communicated by Faraday to the Royal Society. This was the first of Joule's papers which was communicated to and *not* rejected by the Royal Society, and it was rewarded by a Royal Medal! In this paper he describes experiments (1) on friction of water; (2) (3) friction of mercury, two series of experiments; (4) (5) friction of cast-iron, two series. From all these he concludes:—

"(1) That the quantity of heat produced by the friction of bodies, whether solid or liquid, is always proportional to the quantity of force expended; and

"(2) That the quantity of heat capable of increasing the temperature of a pound of water [weighed in vacuo and taken at between 55° and 60°] by 1° F. requires for its evolution the expenditure of a mechanical force represented by the fall of 772 lbs. through the space of one foot."

In 1867 a report was communicated to the British Association through the Committee on Standards of Electrical Resistance, containing the results of fresh experiments on the dynamical equivalent of heat. Finally, at the desire of this Committee, and aided by funds placed at his disposal by the British Association, Mr. Joule undertook a complete redetermination. This was commenced in 1870, and his report was given in 1878. Here is his conclusion, stated in the last two sentences of the present volume:—

"The equivalent at the sea-level and the latitude of Greenwich will therefore be 773.492 foot-pounds, defining the unit of heat to be that which a pound of water, weighed by brass weights when the barometer stands at 30 inches receives in passing from 60° to 61° F. With water weighed *in vacuo* the equivalent is finally reduced to 772.55."

It is impossible for us to do more here than mention some of the other papers contained in this volume. Perhaps among those which are of highest importance we should refer first to a short paper "On the Theoretical Velocity of Sound," in which outstanding difficulties are cleared up, and deductions as to the true relation between the specific heat of air, volume constant, and the specific heat, pressure constant, are brought forward. We have also important experiments on "Some Amalgams," in which their mode of production and characteristics are dealt with. A paper "On Surface Condensation of Steam" was largely conducive to the great improvement which the substitution of this method, for condensation by injection, has realised in the condensing engine of the present day.

In connection with his very earliest work Joule gave special attention to the construction of thermometers. He was the first to produce accurate thermometers in

England, as Regnault did, just about the same time, in France. Joule's thermometers were made for him by Mr. Dancer of Manchester. In 1867 we have a paper "On the Alteration of the Freezing-Point," giving the results of the observations of five and twenty years on this curious phenomenon. In the present volume the paper is supplemented by observations carried down to December 1882.

We mention, lastly, his papers describing experiments to test the brittleness supposed to be imparted to iron castings by frost—experiments which, so far as they go, negative altogether the popular idea on the subject; and with this mention we must take our leave of the volume, expressing once more our deep appreciation of its value, and earnestly hoping for the speedy appearance of its promised companion.

### LETTERS TO THE EDITOR

[The Editor does not hold himself responsible for opinions expressed by his correspondents. Neither can he undertake to return, or to correspond with the writers of, rejected manuscripts. No notice is taken of anonymous communications.]

[The Editor urgently requests correspondents to keep their letters as short as possible. The pressure on his space is so great that it is impossible otherwise to insure the appearance even of communications containing interesting and novel facts.]

#### Long or Short Fractions for Great Natural and National Standards—Earth's Axis of Rotation

IN the two last numbers of the *American School of Mines Quarterly Journal* the learned President Barnard of Columbia College, New York, has involuntarily opened a question of far wider interest than the particular one with which he set out. For on his page 120 there stands the following remarkable statement:—

"The length of the polar axis of the earth is a quantity which may with strict truth be pronounced to be, up to this time, absolutely unknown."

Now if that really be so, the peoples of every civilised country on the face of the earth, who have been taxed during the last hundred years to the extent of millions and millions for the support of magnificent arc-of-the-meridian measuring establishments, have some right in common sense to rise with revolutionary wrath, and demand how those enormous sums of their money, given to determine the size and shape of the earth, have been expended. And when shall we know the far greater distance of the sun!

But the statement can only be true on some private interpretation which is needless to inquire into; for when we take the various lengths of the earth's axis of rotation as determined in modern times, and collected by President Barnard himself from very diverse sources indeed, we find them all to be coincident to four places of figures at least. And considering that for some other most important natural standards the world is apparently content with a certainty of two places of figures only, the officers of the several trigonometrical establishments of all the countries of Christendom deserve high praise, rather than blame, for the results they have succeeded in bringing out.

The mean of their last five measurements, as given by President Barnard for the polar axis of the earth, is

500,492,732.8 British inches,

the ten-millionth part of which is evidently

50.04927328 British inches;

though he has chosen to bring it out as a very different quantity indeed, viz. 49.273 British inches.

But the rather important point now to be discussed is, whether in practical use as a standard of measure, either on paper or for mechanical work, we should attempt to realise that long fraction; or be content with the

50.05 British inches,

at which, as quoted by the President, I had years ago ventured to assume the said ten-millionth of the earth's axis of rotation.

In place of merely, and perhaps vainly, theorising on the sub-

Pope Gregory's reformation of the calendar, by introducing the former (or something like it) in place of the latter quantity, caused sufficient disturbance to all the ordinary affairs of men in every nation when it was first adopted; and has some arguments which may be alleged in its favour still.

But if I read aright a recent tract by so consummate a physical astronomer as Prof. Simon Newcomb, he holds that the Gregorian alteration has done so much more harm than good, being quite a needless refinement, and is so totally unsuitable to calculations in physical astronomy, compared with the Julian year, that civilised nations should, and presently will, return to that year and reckoning, or "Old Style,"—leaving a few curious computers, whom it may concern, to prepare tables of corrections where they are absolutely required for their own abstruse and recondite purposes.

C. PIAZZI-SMYTH

15, Royal Terrace, Edinburgh, April 26

### The Ancestor of the Dipper (*Cinclus*)

IN NATURE for April 3 (vol. xxix. p. 524) the Duke of Argyll desires Mr. Romances to prove "that the dipper once had an ancestor which began to dive in water, &c." The Duke well knows that such ancestry cannot be exhibited, but seems unaware that there are other *land* birds that are *divers* besides the dipper (*Cinclus*). I have often seen the winter wren dart or dive through a sheet of water, and remain in the damp and dripping space behind the little cascade. The water-thrushes (*Seiurus*, sp.) all wade in water, and often, seeing minute mollusca on the bottom of the stream, plunge both head and neck beneath the surface; so that, often for several seconds, a large part of the body is submerged. Now, these birds, like the winter wren, still have the plumage "pervious to water, and so *are* liable to be drenched and sodden"; but they have also the faculty of giving these drenched feathers such a good shaking, that flight is practicable a moment after leaving the water. Swallows, too, are often seen flying in and through spray and thin sheets of falling waters, yet with no detriment to their flight power. Certainly the water-thrushes or wagtails (*Seiurus ludovicianus*, *auricapillus*, and *navaboracensis*) have taken many preliminary steps towards becoming as aquatic as the dipper (*Cinclus*), and the winter wren, and even Maryland yellow-throat, are not far behind. The Duke can scarcely derive any comfort from the dippers; Mr. Romances can.

CHAS. C. ABBOTT

Trenton, New Jersey, U. S. A., April 18

### Double-storied Houses and Concave Roofs

In your issue of January 31 I notice a review of Mr. Im Thurn's book on the Indians of Guiana, in which attention is called to the manner in which a pile dwelling may be converted into a two-storied house, and Prof. Moseley's suggestion that the Swiss chalet did so originate is quoted, the general impression intended being apparently that this, in the majority of cases, is the origin of a double-storied dwelling. Now in that portion of the Himalayas lying south of the snowy range, to which my personal experience is confined, double-storied houses are almost universal, the lower story being used as a cattle-shed, the upper as a dwelling; at the level of the floor a platform is carried out from the building on one side at least, usually on three, or, if the house stands clear of the hillside, on all four sides. The only means of access to this platform and the upper story is by a ladder or flight of steps—it is difficult to say which it should be called—but it consists of the trunk of a tree split in half on the flat surface of which a series of notches are cut to give foothold; this is placed in a sloping position leading to the outside edge of the platform, or if, as is often the case, the platform is inclosed by boarding, through a hole in the floor. It will be seen that this is a principle of construction such as might easily have descended from a pile dwelling, and yet I cannot believe that this is the case; my reasons are: (1) there are no lakes in the Himalayas in which the habit of building on piles could have been acquired; (2) the houses are built of dry stone, strengthened at intervals by timber frames, these frames being without exception horizontal, and built into the wall in courses, such a thing as a vertical post being unknown, while had the style of

and even five stories high, while those of the natives who are rich enough to afford it build three-storied houses, the ground-floor being used for the cattle, the intermediate one as a storeroom, and the upper one as the dwelling. On the other hand, the Kolis or Koltas, an aboriginal race who are as a rule the servants, or practically slaves, of the so-called Brahmin and Rajput land-owners, generally inhabit a single-storied cabin, but where these Kolis themselves own land and cattle, they, too, have double-storied houses. The true origin of this style of building lies, I fancy, in the fact that stone or wooden slabs are practically the only available roofing material, and the preparing and collecting these, not to mention the timbers required, forms a very serious part of the labour involved in building a house, and it is consequently an advantage to make one roof cover both the cattle and their owner rather than to undertake the labour and expense involved in two separate roofs.

In this connection there is a point to which I would wish to call attention. When first entering the Himalayas I was struck by the fact that, whereas the roofs of the villagers' houses were made with a single straight slope from ridge to eaves, those of the temples were as a rule steeper near the ridge, so as to present a concave outline, and as the ends were usually ornamented with deep weather boards fringed with pendent wooden ornaments, while the corners often had what can best be described as a wooden tassel, the appearance of the whole was decidedly Chinese; as I worked higher up into the hills, towards the region of the deodar, the origin of this construction revealed itself. Where deodar is abundant the roofs of the common houses, as well as of the temples, are made of split planks the whole width of the tree, and from 6 to 8 feet long, the ridge being made water-tight by a coping cut out of a single deodar-tree shaped into a ridge above, while in the lower side a V-shaped group is cut. If the row of planks next the ridge were set at a low angle, it might be difficult to fit this coping; but when the angle of the slope is high, the fitting is easier, and besides the beam by its weight grips the planks of the opposite slopes and holds them together effectually without the need of nails, a consideration of probably far greater weight at the time when this method of construction originated than at the present time. Thus the origin of the high slope near the ridge is explained, but to carry this high slope down to the eaves would necessitate the use of an inordinate amount of material, and so the second row of planks is arranged with a gentle slope; in those rare cases where the roof is large enough to require three separate rows of planks, the middle one is arranged generally with a slope intermediate between those of the two marginal ones, and the roof assumes a concave form. As deodar gets scarce the first roofs in which it disappears are those of the villagers' houses, and it is invariably the lower or gentle slope that is the first to be roofed with stone; then this spreads on to the steeper part of the roof, but here the slope has to be lessened or the slates nailed on. Where roofing slabs can be obtained, large and well-shaped, the latter alternative is adopted, and merely the deodar coping remains of the original wooden roof; as a last stage this too disappears, and the ridge is made water-tight by carrying the slates of one slope over the edges of those of the other. This style of roof, however, only persists where roofing slabs are obtained in such abundance and of such size that they can be cut to the desired shape; where slates are only procurable of small sizes and irregular shapes, the concave roof is soon found to be inapplicable, the higher slope near the ridge disappears, and the roof assumes the form of a single gentle slope, but in the temples the archaic form survives. I have called attention to this concave outline of roof because a similar concavity of outline in Chinese roofs is commonly said to be a survival from the time when the Chinese dwelt in tents; this can hardly be the true explanation, for, as Fergusson has pointed out, the Tartar tents, and those of all nomads with which I am acquainted, have a convex and not concave outline. I do not know whether there are in China any trees from which roofing slabs of good quality are or could be made, nor have I at present means of access to any books by reference to which I could settle this question, but if it be the case it is more probable that the concave outline originated as I have indicated above than in the manner suggested by Fergusson in his book on Eastern architecture.

This letter has already run to great length, but in conclusion I should like to add a few words anent the wooden ornaments already referred to. They are usually turned in a lathe, and in shape are not unlike the ninepins of our childhood, but the knob at the top is originally larger in proportion, and continued upwards into a tenon; the knob is then carved away so as to leave two interlocking loops, and the tenon is fitted into the weather board. At the corners of the roof there are often pendent disks of wood fringed with these ninepins, so as to form a sort of wooden tassels. These would answer well for a rude copy of bells which similarly fringe the roofs of the Chinese pagodas, and it is possible that there is a direct connection between the two, but in any case their association with a concave roof is at least a remarkable coincidence.

B. D. OLDHAM

Camp Matil in the Himalayas, April 9

**The Recent Earthquake**

SINCE the earthquake of Lisbon in 1755 troubled the waters of the fish-pond, called Peerless Pool, in the London City Road, it has been a well-known fact that earth-waves had a direct influence in producing an alteration in the level of waters inland, as well as in producing tidal waves sweeping the coasts. The earthquake of Tuesday, April 22, has produced a marked, and, so far, permanent, change in the level of underground waters in the district most affected by the shock, but how far this influence extended there is not yet evidence to show, for, judging by past experience, it may probably prove that springs have increased in volume and the underground water-levels have been raised over the whole area affected by the recent shock, which includes the district lying between Broadstairs and Bristol, 165 miles from east to west, and from Spilsby to Ryde, 170 miles from north to south, and possibly beyond it. It will be of especial interest to know whether the Wealden area, which, as Mr. Topley has pointed out, was free from the more direct influence of the shock, experienced any rise in its underground waters.

At Colchester the water supply is derived from a deep artesian well in the chalk, the supply from which has slightly lessened during the past few weeks, necessitating the lengthening of the suction pipes; and the necessity of still further lengthening them was under discussion, when the Water Committee were agreeably surprised to find that the earth-wave of the 22nd had caused an increased flow of water, and a rise in the water-level of 7 feet, which has so far been maintained.

Earthquakes were described by Mallet "as the transit of a wave of elastic compression." This motion at Langenhoe produced fissures in the gravel walks of the vicar's garden, and at West Mersea opened a fissure a rod in length, which for a short time took off the springs which supply the village with very pure water, and when, after an interval, the pools in which the water accumulates were again full, it was found to be red and thick, and in some of them to be strongly mixed with chalk.

At Bocking the height of the water in Messrs. Courtauld and Co.'s well has been taken weekly for some years; the surface of the well is 137.07 feet above the mean sea-level, and the heights given represent the number of inches the water rises above the surface; the results are very remarkable, the highest previous reading being on Easter Monday, 1883, when it was 19 inches.

The following is the weekly record of the level of water in Messrs. S. Courtauld and Co.'s well, Bocking, Braintree, Essex. The observations are made at 6 a.m. on Monday mornings; no water is drawn from the well on Sunday.

1884	Inches	Corresponding period 1883	Inches
March 31 ... ..	14½	April 2 ... ..	13
April 7 ... ..	15	" 16 ... ..	12
" 14 ... ..	12½	" 23 ... ..	13½
" 21 ... ..	12	" 30 ... ..	14½
" 28 ... ..	31		16
" 29 ... ..	32½		
" 30 ... ..	34		
May 1 ... ..	34		
" 2 ... ..	36		
" 3 ... ..	38½		
" 5 ... ..	42	May 6 ... ..	15

Dat

The readings being weekly, and the earth-wave occurring the day after the record was taken, unfortunately a week elapsed before the remarkable rise was ascertained; after that the readings were taken daily, showing a continued steady rise in level.

These facts tend to show that the recent earth-wave has caused the fissures to open, and to permit a freer circulation of water, and that consequently the "cone of exhaustion" has been filled up with water; and that the only example of this effect so far received should be from chalky districts is not surprising when it is remembered, as Prof. Ansted pointed out, that, though the chalk absorbs water freely, it parts with it slowly, the water derived from chalk-wells being due more to water travelling in the joints and fissures than to the water stored in the chalk itself. It would appear probable that when the increased volume of water now running off, through the enlarging of the sectional area of the fissures, is again lowered by pumping, the old artesian gradients will be resumed, and that the present increase will be only temporary.

As Secretary of the Underground Water Committee of the British Association, I shall be glad to receive any further information on these phenomena. C. E. DE RANCE

Museum, Jermyn Street, S.W.

FROM recent observations I have concluded that the seismic vertical was at or near Dr. Green's house, close to the Strood or Causeway which connects the mainland of Essex with Mersea Island. The house was built in 1860, and is therefore new. I may here observe that (as I hinted before in former letters) the modern, cheaply-built cottages were not so much affected as the more ancient ones. The chimneys, walls, &c., of the latter were invariably destroyed, damaged, or cracked—the former seldom so. I was much surprised at this. The first thought naturally was that these "jerry-built" houses would be shaken down like a pack of cards. Is it that their very looseness of structure is in their favour, as compared with the stronger-built cottages of two and three hundred years ago? I have somewhere seen that in earthquake-visited centres the houses most secured from destruction are the loosely-built, low edifices. One can speak plainly on this matter, as no premium is required to encourage the development of "jerry-building."

Dr. Green's house is literally split and cracked in all directions, and the splits and cracks are the most vertical of any to be seen. The entire building was twisted on its foundations. At the south-west corner this is visible to the amount of about one inch and a half. Dr. Green informed me he was lifted up, as if from behind, and shot violently forward.

A friend of mine remarks (and I noticed the same fact in my note-book, but omitted including it in my last communication) that the railway cutting at Wivenhoe appears to have broken the continuity of the undulations, for the houses contiguous to it are comparatively uninjured.

A noteworthy fact in connection with the recent earthquake, to which I can personally testify, and which appears to be the general experience of all the most trustworthy observers I have come across, is that the sounds or noises preceded the oscillations for an appreciable period of time. Mallet's experiments showed that the shock of an explosion travelled through wet sand at the rate of 951 feet per second. In Ipswich we are situated chiefly on drift sands and London Clay, and allowing that the earthquake shocks travelled through these strata at a more rapid rate, it is not likely to have been much more rapid. As sound travels at the rate of 1118 feet per second, it is very probable that the noise accompanying the earth-movements preceded the oscillations.

Mr. Wilkins, the well-known yacht-builder at Wivenhoe, tells me he was standing at the time the earthquake occurred in the yard, and his first impression was that a new yacht he was looking at was heeling over, and he called out so to his workmen in the shop close by. Then followed the crash of the tall chimney and the rending of the walls. The workshop has an upper floor, with windows on each side, and, as he stood in the yard, Mr. Wilkins says the oscillatory waves were such that he was enabled to look right through these windows, so as to see the falling chimneys of the buildings on the other side. He calculates that there must have been a rise and fall of the ground of 2 feet 9 inches to have enabled him to do this.

On Saturday, May 3, the members of the Ipswich Scientific Society made an excursion to Langenhoe and Peldon, and Mr. Henry Miller, C.E., the honorary secretary, kindly took the following exact measurements of the rents seen in a building adjoining Peldon Mill. There are two of them, succeeding each other at a short distance, and they pass through the brickwork at an angle of just 30°. At the gable end of this building there is



another rent in an opposite direction at an angle of exactly  $32^\circ$ . The brick shaft of the mill stands by itself, and is about 40 feet high. The upper part, ten feet from the top, is broken right through, evidently by the swaying motion, and is twisted round on the lower part one inch and a half towards the south-east. The size of the chimney at this part is 3 feet 9 inches square.

In view of Mr. Topley's suggestion that the earthquake may have some connection with the underlying ridge of Palæozoic rocks, it would be interesting to know if any shocks were felt in the Boulonnais and the Ardennes.

J. E. TAYLOR

Ipswich Museum

At the Cross Farm, East Mersea, on April 25, I was shown in the garden two places where water, it was said, spouted up shortly after the shock on the 22nd. They were about ten yards apart on a freshly dug piece of ground on a slight slope, and the woman who lived in the house close by informed me that after the shock she had observed water spouting out from them, and that it continued to do so until after her dinner, which was at one o'clock, when it ceased. There was enough water she said to cause a small stream to run down from each place towards her house, where they formed a puddle; her husband tasted the water and told her it was brackish. There was still evidence of the truth of this statement: the earth at each spot was damp, as was also a small channel which the water had made running down the slope. It appeared as if a small underground water-pipe had burst and the water had been forced above the surface. Cross Farm, I believe, is about a quarter of a mile from the sea, and perhaps twenty feet above its level.

EDWARD NEWTON

Lowestoft, May 5

THIS village lies partly on the lowest beds of the Chalk, and partly on the Gault; it is between N. lat.  $51^\circ 49'$  and  $51^\circ 50'$ , and W. long.  $0^\circ 40'$  and  $0^\circ 41'$ . The shock was felt at the church, and at two cottages where are invalids in bed. The church is on rising ground at the edge of the chalk platform which lies below the Chilterns, some two miles away from them. I was on the scaffolding erected for repairs to the church. At a little past nine—it could hardly have been later, I think, than 9.15, if so late—I felt the church give what seemed like a fierce shudder. This seemed to begin on the east, rather to north, and travelled westwards nearly. By shudder I mean that a sort of vibration began, which almost instantly increased in intensity, reached a climax, and then rapidly decreased and died away. It seemed to me to begin slightly north of east, because I remember feeling (for what reason I can hardly say) that the cause was hidden from me behind the east end of the church. I was on the south side, some eighteen feet from the south-east corner. A moment after a whirlwind followed, which began, as I find, near the top of the slope north-east of the church, and followed the churchyard wall which bends round the churchyard to south-west. In a cottage on the junction of the Chalk and Gault (or very near the junction), according to the result of inquiries I have made of an invalid there, the pictures on a wall lying north-west and south-east waved from and to the wall, but seemed also to move along it somewhat, *i.e.* north-west and south-east. Flower-pots on a table rocked in a direction almost east and west, and a window facing the south-east shook; her bed also, lying north-west and south-east, waved, and seemed as if giving way. This took place, she says, a little after nine. In a cottage on the Gault where another invalid was lying, a window facing south-west rattled, a picture shook on the wall on which it is fixed, and the bed, lying south-east and north-west, also waved. This was, she thought, at nine, but the time must have been later. She noticed that the wind was still. No noise was heard except the clatter caused by the rattling of the buildings; but at a mill on the Icknield Way, near Tring, lying at nearly lat.  $51^\circ 48'$ , and long.  $0^\circ 40'$ , a rumbling was heard.

FREDERICK W. RAGG

Masworth Vicarage, Tring, May 6

### Black Rain

THE following paragraph from the *Field* of May 3 will probably interest those of your readers who have seen my note in the last number of NATURE (p. 6):—

“Black Rain.—Yesterday afternoon (April 28) a violent thunderstorm raged over the district between Church Stretton and Much Wenlock. Torrents of rain fell, seemingly a mixture

of ink and water in equal proportions. One old man here says he never saw anything like it but once. I certainly never saw such a coloured rain, and I intend to have a bottle of it analysed. Even this afternoon the little brooks are quite black, and the ruts in the roads look as if ink and water had been poured into them.—Rev. R. I. BUDDICOMBE, Ticklerton, Church Stretton.”

An analysis of the rain which fell at Stonyhurst showed that the impurity was almost entirely carbon.

S. J. PERRY

Stonyhurst Observatory, Whalley, May 4

### The Remarkable Sunsets

BECAUSE of the volcanic hypothesis that has been proposed to account for the red sunsets of the past fall and winter, other instances where similar phenomena have been seen after like eruptions are of interest.

Graham's Island, which arose off Sicily in 1831, attracted attention from July 19 to August 16, but was most active on August 7, according to the account given by John Davy in the *Philosophical Transactions* for 1832. The same writer says (p. 252):—“In the month of August a singular appearance was witnessed in the heavens, many evenings successively, both here and in Sicily. Soon after sunset the western sky became of a dark, lurid red, which extended almost to the zenith, and continued gradually diminishing in extent and intensity even beyond the limit of twilight.”

A few days after this eruption, August 11 and 12, on the clearing away of a hurricane, the sun appeared blue at the Bermuda Islands (*Amer. Journ. Sci.* xl. p. 323); on August 13, 14, 15, at Mobile, in the southern part of the United States, the rays of the sun were pale blue or violet, varying to sea green (*Amer. Journ. Sci.* xxi. p. 198).

In the month of October the sunsets were prominent enough in the vicinity of Washington to attract popular inquiry. At Alexandria, Virginia, October 12, the heavens continued to reflect a very red light for a long time after the sun had set. October 13, at midday, the sun had a silvery appearance, and its rays gave a ghastly appearance to the countenances of persons. Between 3 and 4 p.m. it appeared greenish blue (*Niles' Register*, October 1831).

L. G. CARPENTER

State Agricultural College, Lansing, Michigan, U.S.A.,

April 47

IT may interest readers of NATURE to learn that on the occasion of a rain-storm at 5 p.m. on the 26th ult. at Crowle, an agricultural village a few miles eastward of this city, the rain-water was so greatly discoloured and loaded with an ash-like matter as to present, until after subsidence, a deep black hue, when caught in vessels placed for the purpose. Again, on Saturday last, the 3rd inst., on the occurrence in this city of rain-storms during a half gale from the north-west, there remained after the storms, on the panes of windows exposed to the north-west, a considerable film of dust which had fallen with the rain. While writing it may be mentioned that the phenomenon described as red sunrises and sunsets has prevailed here, before and after sunset, ever since November 9 last; of late, in gradually decreasing tone and variety of colour, and extent of sky area. The coloration at this date is of a russet hue, and there is a steely glare.

J. LL. BOZWARD

Worcester, May 5

### Rotating Thermometers

IN reference to the Froude thermometer, to which attention is drawn in your last number (p. 6) by Mr. Hazen, I feel confident that if its merits were better known it would be universally employed, not only as insuring among all observers absolute uniformity in the record of the temperature of the air, but as affording the only satisfactory means of determining the degree of saturation by means of the wet and dry bulb. Nothing is more perplexing to the meteorologist than the selection of his screen and of an appropriate site. The system of whirling a thermometer rapidly through the air effectually dwarfs all external influences from the rapidity with which renewed particles constantly impinge on the bulb, and it is well known that in the case of the wet bulb the indication is greatly affected by the presence or absence of wind. I found this to be practically the only means of determining the temperature and humidity in a steamer at sea. The only objection was the inconvenience and risk of whirling small thermometers on a string,

and the difficulty of reading without affecting their record ; but this I completely got over as explained in my "Visit to South America," 1878, by using a simple whirling table, on which the thermometers were fixed, the reading being effected by bringing them in succession under a plate of glass covering part of the circumference of the table. Nothing can exceed the simplicity of such an arrangement, which is almost independent of position, and with *small* thermometers affords a uniformity and accuracy impossible of attainment with a fixed thermometer, as it becomes a repeating instrument by a few extra turns of the table, thus insuring freedom from error of observation. I have used this system for many years with most satisfactory results.

EDWIN CLARK

#### Science and the Public Service

WHILST sincerely regretting the new scheme of openly cutting down the science marks in the army examinations, I think it is not so much the low maximum of marks supposed to be attainable which is discouraging the science subjects, as the low marks actually given at all Government examinations (excepting the Indian Woods and Forests) to any one who is so unwise as to take up natural science. To take, as an example, the Indian Civil Service marks of last year. While in French and German, each of which is a 500 subject, more than 30 per cent. of the candidates obtained over 200 marks ; in chemistry, which is also a 500 subject, only two out of thirty-two, or 6 per cent., scored over 200. The marks in the other subjects included in the fatal column of natural science are equally low. Now I do not think that any one will maintain that science is not properly taught at Clifton, Dulwich, &c., yet in French and German a boy has every chance of obtaining 100 marks more than in chemistry (the highest marks last year were—chemistry 229, French 325, German 347). Two possibilities present themselves : either the clever boys will not take up science subjects at all owing to the low marks persistently given, or the examiners expect more chemical knowledge from a boy of eighteen (who must take mathematics or classics, English, &c., in addition to chemistry) than he can possibly acquire. I trust that examiners may be induced to seriously consider the last possibility.

F. C. S.

#### THE ROYAL CORPS OF NAVAL CONSTRUCTORS

BY an Order in Council of August last this corps was established ; an Admiralty Circular of November last published the details of the new arrangements ; and the result of the first examination for the grade of "Students in Naval Construction" has recently been announced. An important change has thus been made in the entry, training, and promotion of the professional officers upon whom devolve the responsibilities connected with the design and construction of ships for the Royal Navy ; yet little public interest has been evinced. There can be no dispute, of course, as to the great importance attaching to the maintenance in the highest state of efficiency of the constructive department of the navy. Shipbuilding is making such rapid strides that all who have to take part in its developments, whether for war or for commerce, require a highly scientific as well as a thoroughly practical education, if they desire to keep in the forefront of progress. And for modern war-ships with their high speeds, heavy burdens of armour and armament, and liability to damage in action, specially difficult problems continually present themselves, the solution of which is only possible by means of scientific procedure. Recognising these facts, it may be well to make a brief statement respecting the new Constructive Corps, and to indicate the manner in which its creation may be beneficial not merely to the public service but to the mercantile marine.

It is only proper to remark at the outset that the Lords Commissioners of the Admiralty have hitherto been the chief patrons of the scientific education of shipbuilders in England ; and to their generosity has been due the existence of the only establishments in which the higher train-

ing of naval architects was provided for. Early in the present century (1811) the first School of Naval Architecture was established in Portsmouth Dockyard, and continued at work for more than twenty years. It was established in consequence of the absolute necessity for opposing to the well-trained French naval architects men of equal education and ability, who could not be found at that time in our naval service. Ship-designing was clearly in a very inferior position here, when no shame was felt in building servile imitations of vessels captured from the French. In 1832 this school was abolished, and for sixteen years there was no training establishment of the kind open for English students. But during that interval men educated at Portsmouth occupied important positions both in the Royal Naval service and in private establishments, helping to maintain our national reputation. In 1848 a second school was opened at Portsmouth, on a much more modest scale, and destined to have a shorter life, for it lasted only five years. That brief period sufficed, however, to produce a number of men still holding some of the highest positions in the profession. Another interval of ten years elapsed, and then the Royal School of Naval Architecture was opened at South Kensington, the Admiralty giving it large support, although it aimed at educating other than Admiralty students. Since 1864 there has been no interruption in the good work, although in 1873 the establishment at Kensington was broken up, and the Admiralty section of it transferred to the Royal Naval College at Greenwich. There, as at Kensington, all comers are welcomed if they possess sufficient preliminary training, and private English students, as well as foreigners, have opportunities for instruction afforded them as good as those which the Admiralty provide for their own students. By the munificence of Mrs. John Elder the University of Glasgow has had a Professorship of Naval Architecture recently established, and the classes will, it is understood, commence work this year. But up to the present time the Royal Naval College affords unrivalled opportunities for instruction, and may challenge comparison with any similar institution in Europe.

By means of the very excellent training schools in the Royal dockyards, and the large field of selection from among the apprentices, the Admiralty have been able to secure a continuous supply of well-prepared students for the higher training at Kensington or Greenwich ; and thus have obtained the educated naval architects required for the public service. Nor is this all that has been done. A very considerable number of the trained men have passed from Admiralty employment into private establishments, where they have done and are doing good work.

It may be asked, in view of these results, why change a system which has worked so well? The answer is twofold. First, there were grave objections to the continuance of the restrictions imposed by the regulations for first entry into the service. Second, there was not proper recognition of the special training which a student had received when he passed out into actual work, nor any guarantee of a subsequent career. These points require brief explanation.

Although the Admiralty so fully recognised the value of scientific training for its naval architects, and made provision for it, yet for half a century they maintained regulations which necessitated the first entry into the service being made either as an apprentice or as a working man. A few exceptions may be quoted : but the general rule was as stated. The result of this arrangement was that, with few exceptions, candidates for entry came from the working classes ; and there was no attraction into the service of the sons of persons in good social positions, such as very commonly become pupils of civil or mechanical engineers. This was obviously a matter which required alteration. The competition for entry was absolutely free, no doubt ; but it was surrounded by conditions which

made the real field of selection narrow, and did away with many possibilities of attracting well-educated youths into the service.

Competition was of the essence of the whole system—unlimited and fierce. There was an open competition for entry as apprentice, with probably ten times as many candidates as there were appointments; then from amongst each year's successful candidates—perhaps thirty or forty in number—three only could reach the Naval College after five or six years' work and frequent examinations. Supposing the College course successfully passed, and the student launched on his professional career as a fully certificated naval architect, he then only began a fresh series of competitive examinations on the result of which depended his future promotion. This was a second objection to the old scheme: it was much the same as if a wrangler were called upon to begin work as teacher in an elementary school, and to compete for that position in elementary subjects with men who knew little or nothing beyond those subjects.

Both these objections have been disposed of by the constitution of the Constructive Corps. For the future, while the apprentices in the dockyards will still retain the possibility of advancement to the highest posts, a new class is to be created, termed "Students of Naval Construction." Not more than three are to be entered annually by open competitive examination; they will receive special training at Portsmouth for six years in both professional and educational subjects, living meanwhile in quarters there, and receiving the same treatment as is given to the students in course of training as engineer officers of the Royal Navy. No possible objection need be felt by any gentleman in placing his son under these conditions, and the training is certain to be thorough. Once entered at the Training School, a student has a definite career before him, provided he is well behaved and diligent. He has simply to pass certain standards to insure entrance into the Naval College; and similar conditions hold good during his stay there, as well as at his graduation therefrom. Very properly, powerful inducements are offered to the students in order that they may exert themselves and pass out in the highest class; but those who pass the standard fixed are to receive appointments at once as Assistant Constructors in the Royal Navy. With position thus assured to begin with, and with duties to perform suited to the special training received, the graduates of the Naval College can look forward to an honourable and useful career in the Constructive Corps. Promotion throughout the subsequent stages is to be by selection, and not by competition, selection being governed by the reputations which men make in their professional work.

There are many degrees of rank in the new corps, reaching up from the junior assistant constructors, to constructors, chief constructors, and the highest office—that of Director of Naval Construction, now so worthily filled by Mr. Barnaby. But from the highest to the lowest all the members of the corps have recognised positions in due relation to one another. This is a great gain.

Still another notable feature in the new arrangements is the possibility which now exists for a naval architect who has obtained his training outside the Admiralty service to enter it after he has proved his capabilities for the appointment of assistant constructor by passing a test examination at the Royal Naval College. There are certain limits of age laid down, and it is possible that the number of candidates who will present themselves for some time to come will not be great. At the same time the Admiralty have shown a wise discretion in thus extending the field from which their shipbuilding officers may be recruited. The private trade has drawn largely hitherto from the Admiralty staff: perhaps some return will be made in future.

In the Constructive Corps are included all the principal

officers at the Admiralty and in the Royal dockyards, and all the specially educated men from the Naval College who have been successful in their course of study. Provision is also made for admission to the corps of subordinate shipwright officers from the dockyards who may be qualified for the appointment. This is a matter of less public interest than those above mentioned, but it has a very important bearing on the discipline and smooth working of the dockyards.

These are the main features of the new arrangements. They promise well for the future. While retaining for the apprentice class their possibilities of advancement to the highest positions, the Admiralty have greatly enlarged the field of selection for their constructive staff, and made it possible for any gentleman to place his son in the Training School at Portsmouth with the assurance that the surroundings will be as suitable as the system of training is excellent. Further, the Admiralty have recognised the wisdom of training men who from the first shall take rank as officers, and not be compulsorily forced through the grade of workman in order to become officers. This is what is done in all the principal foreign navies and in private establishments: it need not involve any loss of practical knowledge of details, and it is a gain from an administrative point of view.

For my present purpose it will suffice to terminate here this sketch of a "new departure" which promises well for the Royal Navy, and to which most people will wish entire success. There are matters of detail which seem open to criticism, and it would be interesting, did space permit, to show in what respects the new regulations resemble or differ from the corresponding regulations in force in the French or other foreign navies. As this could not be done within the limits of this paper, I have been content to draw attention to the openings which the Admiralty have presented to youths who have a taste for naval architecture, but who would not submit to the drudgery of an ordinary apprenticeship; and have endeavoured to point out how the public service may be benefitted by the changes introduced.

The shipbuilding profession has hitherto been a very "close" one, both in the public service and outside it. But it may be reasonably anticipated that, at least in the Royal Navy and possibly in private establishments also, a change of system would prove advantageous. If the conditions for admission and training are made to resemble more closely those holding good in various branches of engineering, there seems no good reason why a larger number of well-educated and intelligent young men should not adopt naval architecture as a profession. The new Constructive Corps has been created on the recommendation of a departmental Committee, of which Sir Thomas Brassey was chairman. The Report of this Committee, as well as the minutes of the evidence taken by them, have been published as a Parliamentary Paper (No. 277 of 1883), and will well repay perusal. It may there be seen that the appointment of the Committee resulted chiefly from action taken by Admiral Sir Houston Stewart, when Controller of the Navy: and it is a matter of great gratification to myself that I had the honour of assisting that distinguished officer in the preparation of the scheme, which was substantially recommended by the Committee for adoption, and has been adopted by the Admiralty. A few years' experience will decide whether or not the benefits anticipated from the changes above described will be realised. Much must depend, no doubt, upon the manner in which the scheme is developed, and the process must be gradual and carefully watched if it is to be successful. But whatever the result may be, nothing but good can come from the changes which enlarge the field of selection for the shipbuilding officers of the Royal Navy, and which unite in one corps all ranks and classes of the constructive staff.

W. H. WHITE

THE FLORA OF PATAGONIA<sup>1</sup>

THIS work, the joint production of the late Prof. Lorentz and of Mr. G. Niederlein, is a substantial addition to our knowledge of the vegetation of one of the least explored portions of the earth. It forms one portion of the scientific results of the expedition into Patagonia conducted in 1879 by General Roca, who has since been elected President of the Argentine Confederation. The Indians who, under the vigorous and stern administration of General Rosas, had been terrified into inaction, if not into submission, gradually took courage when they had to deal with less energetic opponents. At repeated intervals the wandering tribes, especially those of Araucanian stock, made destructive incursions through North Patagonia and the south of the province of Buenos Ayres, massacring the white settlers and driving off the cattle. It had long been the declared policy of the Argentine Government to confine the Indians to the region south of the Rio Negro, by establishing military posts at suitable points in the valley of that river; and to carry out this project was the object of General Roca's expedition. The chief station occupied was Cholochele, a large island inclosed by two arms of the Rio Negro. From thence the upper valley of that river was followed to its junction with a large tributary, the Nauquem. Prof. Lorentz had already returned to Buenos Ayres, while Mr. Niederlein travelled northward to Mendoza. Although the expedition was carried out at an unfavourable season—the autumn and early winter of the southern hemisphere—the authors succeeded in collecting 337 species, of which thirteen are ferns and the remainder flowering plants, in a district which includes only the north-western portion of Patagonia. It is not, however, easy to say how many of the numerous species not hitherto recorded as natives of Patagonia are henceforward to be added to its scanty flora. Many of the species recorded were found in the region lying north of the Rio Colorado, which is generally regarded as the northern boundary of Patagonia, and are not said to spread to the south of that river. Again, as many as sixty-five species of flowering plants were collected in such an imperfect condition that the authors have not been able to assign to them specific names, and many of these will doubtless be found identical with those already known as natives of the country. Further, it must be added that, of twenty plants described as new species, several appear to rest upon slight distinctive characters, which, in the eyes of many experienced botanists, will entitle them to be counted rather as varieties than as altogether new species.

Making due allowance for these deductions, it appears that we may reckon about 150 species as additions to the meagre catalogue of the plants hitherto known as indigenous to Patagonia, scarcely 300 in number for a territory more than 1000 miles in length and from 200 to 400 in breadth. Apart from the interest felt by the systematic botanist in the special forms of vegetation displayed in each region of the earth, many questions of a more general character are suggested by the study of local floras, and that of Patagonia is especially suggestive. Ever since naturalists ceased to regard the existence of each organism as due to a special and separate act of creation, and have learned that the existing population of each region is derived by descent with modification from earlier races, the influence of geological and physical changes has assumed a paramount importance in regard to all changes relating to the geographical distribution of plants and animals. If we seek to understand how the flora of a given region of the earth has come to be what it is, our first business is to inquire into the past history of that region, and to ascertain from what sources the indigenous species may have been derived. With

<sup>1</sup> "Informe Oficial de la Comision Cientifica agregada al Estado Mayor General de la Expedicion al Rio Negro (Patagonia) bajo las ordenes del General D. Julio A. Roca." Entrega II. Botanica. (Buenos Aires, 1882.)

reference to the special features of the Patagonian flora, the subject was discussed during the past winter at a meeting of the Linnean Society. It was then pointed out that nearly the whole of Patagonia and a considerable part of the adjoining Argentine territory had been raised from beneath the sea-level during the latest geological period, and that the only quarters from which the vegetable population could be derived were either the range of the Andes or the subtropical region now included in the northern Argentine provinces. It was argued that the exceptional poverty of the Patagonian flora is not mainly due to climatal conditions, but to the fact that in the time which has elapsed since its upheaval only a relatively small proportion of the plants of the adjoining regions had been modified to suit the conditions of life in the newly-formed territory.

It is interesting to see what light is thrown on the subject by the present work, which, although bearing the date 1881, appears to have but very recently reached this country. Our previous knowledge of the flora was nearly confined to the region near the coast, whereas most of the plants here enumerated come from the territory near the eastern base of the Cordillera. Whether owing to the season, or to the fact that they do not extend to the interior, many of the indigenous species known to occur near the coast—at least a hundred might be enumerated—are absent from the enumeration of MM. Lorentz and Niederlein. But a comparison of all the materials accessible displays a remarkable degree of uniformity in the general features of the vegetation. When raised from the sea the newly-formed territory of Patagonia was dependent for a vegetable population on the immigrant species which it might receive either from the range of the Cordillera to the west, or from the subtropical region to the north. As a matter of fact the predominant features of the vegetation are derived from the lower zone of the Andes, the majority of the species being either the same or slightly modified forms of plants of that zone. Our knowledge of the eastern slopes of the Andes in Patagonia is so imperfect that we cannot say whether a few apparently very distinct plants, two of which are here described as types of new genera under the names *Niederleinia* and *Grisebachella*, are derived from the higher zone of that range; but it is remarkable that as a general rule very few of the characteristic plants of the higher Andes should have been able to adapt themselves to the conditions of life on the plateaux of Patagonia.

The plants of the subtropical region have exhibited greater power of adaptation to new conditions. Of the larger trees none have been able to spread so far southward; and, except where planted and specially protected, it is not likely that they ever can do so. But of the small bushes and perennial herbs which make up the bulk of the flora a considerable number must be reckoned as more or less modified descendants of subtropical types. It is rather singular to note that this power of adaptation seems to be characteristic of certain groups or natural orders. The most marked instance is that of the *Leguminosæ*. In the Old World the tribes of this family characteristic of the tropics show no tendency to extend into the warm temperate zone, the only exceptions that suggest themselves to the writer being a few acacias in North Africa; whereas we find in this volume out of twenty-one species of indigenous *Leguminosæ* ten belonging to characteristic genera of the tropics, including two species of *Casalpinia* and one (new) species of *Mimosa*.

The condition of an extensive territory inhabited by a relatively small number of indigenous species, many of them probably but imperfectly adapted to their environment, was evidently very favourable for colonisation by new immigrants; and the chances in favour of the new comers were further increased on the introduction of agriculture and of domestic cattle from the Old World. The plough clears the ground from many bushes and

perennial herbs, and cattle make war on the species suitable for their food, and at the same time carry with them the seeds of many species adapted to such means of transport. To these causes we must attribute the wide diffusion of many plants, chiefly from southern Europe, introduced by man, either accidentally or intentionally, into the Argentine region and North Patagonia. A few of these appear to have spread beyond the bounds of European colonisation, but the majority seem to keep pace with the extension of the white race and of domestic cattle.

This volume, dated 1881 when it went to press, but not published till 1882, is very well printed and illustrated by twelve well-executed lithograph plates, in a manner creditable to the typographic resources of Buenos Ayres, and reflects honour on the administration of the republic and on General Roca, who, as commander of the expedition, deserves the credit of associating with his staff several competent scientific men. We probably owe it mainly to his influence that the results have been given to the world in a manner so complete and satisfactory.

J. B.

#### ACROSS THE PAMPAS AND AMONG THE ANDES<sup>1</sup>

THE interest attaching to the confederation of South American provinces known as the Argentine Republic more than justifies Prof. R. Crawford in the publication of an account of his journeys across the Pampas and the Andes. Some fourteen years ago the Government of the Province of Buenos Ayres, foreseeing the vast importance of a line of railway which would connect the two oceans, entered into an agreement with the firm of Waring Brothers of London to send out a staff of engineers to explore and survey a route for a proposed Transandine railroad. Prof. R. Crawford was given the command, and, with his colleagues, left Liverpool in March 1871 for Monte Video, which was reached after a voyage of a month's duration. On landing, it was soon ascertained that matters were in desperate plight at Buenos Ayres. The frightful epidemic of yellow fever was still raging, the local Government had proclaimed public holidays and itself migrated to a distance from the doomed city, business of all sorts was suspended, and silence reigned in the streets. Under these circumstances, but for the pluck and energy of Prof. Crawford, the scheme for the survey across the Pampas would have come to an untimely end (that from the Chili side had commenced towards the end of April 1871); but he determined it should proceed, and never let the local authorities have any rest until all preliminaries were settled. In the meanwhile the enforced sojourn at Monte Video was not over pleasant. The city was in a state of siege, and it was not for some time after the arrival of the party that a temporary peace was patched up. Weary of the forced delay, Prof. Crawford and some members of his party visited Concordia and made a survey for the Salto Grande Canal. They passed, in their voyage up the Plate, Buenos Ayres, looking in the distance bright and pleasant, though death was stalking through it. In steaming up the Uruguay they saw Liebig's famed extract-of-beef factory at Fray Bentos, and McCall's vast establishment at Paysandu. In an account of a short excursion made from Concordia, we find the following interesting anecdote about the black vulture (*Cathartes atratus*) of La Plata; perhaps the coolness of the vulture's behaviour is fully equalled by the coolness of the driver in appropriating the stray horse:—

"The roads were very sandy, and the wheels sank deeply into them, making the carriage heavy to draw, so that the driver gladly appropriated a stray horse we met

upon the way that seemed inclined to join himself to ours, and having extemporised a rude set of harness with some spare pieces carried in reserve, attached him to our team, and drove off in triumph with this new acquisition.

"I was sitting on the box-seat with my gun in hand, when a black vulture came flying past, at which I fired, bringing it to the ground with a broken wing. The strange horse testified his dissatisfaction with the proceeding by the most violent plunging and kicking, that required all the driver's skill and address to overcome.

"When at last he was brought to a state of rest, due, no doubt, in a great measure to exhaustion, the wounded bird occupied our attention by the strange coolness of its proceedings. Regardless alike of our presence and an injured wing, to say nothing of the noise and confusion the horse had created, instead of attempting to escape, it walked quietly up to us, as if about to demand an explanation of the treatment it had received; then mounting deliberately on the wheel of the carriage, hopped in through the open window as composedly as if it were a regular passenger about to occupy an inside seat for which it had been booked in the ordinary manner.

"So offensive was the odour emitted by the unwelcome intruder that we could with difficulty bring ourselves to approach and dislodge it; and when we had done this, the vulture took refuge under the legs of the strange horse, frightening him to such a degree that he began again his strenuous endeavours to get loose, not stopping till he succeeded in smashing the harness to pieces, and escaping from his flapping foe.

"I am afraid that I was not popular that afternoon with my comrades and the driver, for my unlucky shot had entailed upon them much inconvenience and delay, so that it was late when we reached the estancia house."

Just as the survey of the canal was finished, traffic between Monte Video and Buenos Ayres was resumed, and, returning to the former place, the whole expedition left for Buenos Ayres on June 16, 1871. The city was still overwhelmed with gloom. Between 20,000 and 30,000 of its inhabitants had been buried within the few previous months out of a population of only 200,000 souls. Numerous houses had the plague spot still marked upon them, but in a very short time things looked more cheerful, and there were no outward tokens of the plague the city had passed through. Now began the negotiations for the necessary escort to accompany the expedition across the Pampas. While the expenses of the expedition were in great measure to be defrayed by the local Government of Buenos Ayres, it will be remembered that this Government has no national authority, nor could it undertake any outside its own territory, it was therefore necessary for the provincial Government to come to an understanding, which they did, with the national Government and with its neighbouring provinces, and with the Republic of Chili, for the passage of the expedition through these lands and for the supply of a military escort. "Along the whole route," the general commanding on the frontier reports to the President of the Republic (May 20, 1871), "there will be danger: the Indians were in a state of alarm that the objects of the Survey were to take more and more of their territories from them, and were determined to destroy the members of the expedition when possible," and the general calculated that an adequate force to properly protect the party from all danger should not number less than 1500 men perfectly equipped. Under these circumstances, and after some months' delay, the originally proposed route was abandoned, and a more northern one, in territory likely to be more free from the predatory attacks of the Indians, was adopted, and with a small escort the expedition left Buenos Ayres on August 17, 1871, and took up their quarters at Chivilcoy, 100 miles to the west of it; here final preparations were made for the formidable journey across the Pampas. The Chili expedition in the meantime had, before reaching the summit of the mountains,

<sup>1</sup> "Across the Pampas and the Andes." By Robert Crawford, M.A. With a Map and Illustrations. (London: Longmans, Green, and Co., 1882.)

been obliged, owing to heavy falls of snow, to abandon the work, which was not resumed until September. In this month too the preliminary party of the Pampas expedition started, and were followed by the rest of the party towards the end of October. We leave the reader to peruse in the volume itself an account of all the troubles and difficulties that had to be, and were, overcome ere a party of sixty-six persons, not counting the escort, could be started on such a journey across the boundless Pampas.

By the end of November the Indian frontier was reached, the work of the Survey having proceeded well. Water was often scarce, and only procured by sinking wells, which furnished but very moderate supplies. Some very sudden changes of temperature were encountered. Thus, on November 13, "the thermometer, which had hitherto been registering great heats, suddenly fell to 26° F., converting the water in our tents into ice." Deer (*Cervus campestris*) and partridge (*Nothura maculosa*

and *Rhynchotus rufescens*) were abundant. The deer at the season they were met with went about in small herds of from three to seven. As they advanced water became more scarce, and moreover was often muddy. Once when the stock at the disposal of the engineers' mess was reduced to a small kettle-full, and that heavily charged with sediment, it was resolved as a means both of economising the fluid and making the most of the mud, that it should be made into coffee. Anxiously the little group sat around the camp fire watching the kettle, the water in which was never to boil, for by some unfortunate accident, the particulars of which were never explained, as the subject was one too painful to be talked over, the kettle was over-set, and its contents poured out on the resenting flames, amidst a groan of horror from the parched throats around it. In this Indian territory Rheas (*Struthio rheca*) were numerous, and the young birds were very easily tamed, those captured by the men becoming pets in a few days, and wandering about the camp like young turkeys. The



Tupungato, from the River Lujan.

generally careful and prudent engineer-in-chief was here on one occasion so heedless of his own safety that he was nearly coming to grief. One night he passed out of bounds unnoticed, but on attempting to regain the encampment he found his situation most serious, for he was at once challenged by the sentry, who happened to be a Frenchman fresh from the experiences of the Franco-German war, and not being satisfied with Prof. Crawford's explanation, he proceeded to present his rifle. Not anxious to serve as a target, the professor, to prevent the sentry from getting him projected on the sky line, fell flat on the ground, and while in that somewhat undignified position, some of the men coming out on hearing the alarm, recognised his voice, and released him, resolving to be more prudent the next time that he wandered beyond range. Several troops of wild horses were met with; they had all flowing manes, and tails that swept the ground. On November 29, an attack in force of the Indians being most imminent, and the military escort being ordered to retire on Fort Media Luna, the surveying

operations were most reluctantly discontinued. The last peg was driven well into the ground and covered with a large mound of earth. When thinking of resuming operations, Prof. Crawford demanded an escort of 200 men, but after a promise of fifty, was only eventually furnished with twenty. To continue the survey work with such an escort was quite out of all reason, and the question arose, what was to be done? After all that had been endured and all that had been accomplished, was the expedition to be abandoned? Such a termination would have been a most painful one to all engaged; Crawford therefore determined to risk everything, and endeavour to accomplish the mission by crossing the Pampas in a compact body, keeping along the line of frontier until the Andes were approached, and then bearing southwards, to ascend their eastern slopes until they should join their colleagues from the Chilian side at the place of rendezvous. This determination they proceeded to carry out on December 6, when Media Luna was left. On the 18th the swampy district known as the "Amarga" was reached

Here the Rio Quinto loses itself in an extensive sandy plain to reappear not far off as the Salado, which river falls into the Plata, about sixty miles south of Buenos Ayres. A couple of days later, near Fort "Nichochaza" potatoes were met with and the potato in blossom. The tubers of the latter were very small, and, when boiled, tasteless. Lakes were now often met with, the water generally sweet, and the lakes encircled by sand-hills. At Fort Sarmiento the Rio Quinto was crossed; it had here cut for itself a channel 300 feet wide through a gravelly soil to a depth of some ten feet below its banks. About December 23 trees became numerous, and the monotony of the ocean-like plain was broken by the appearance of a mountain (El Morro). Here Colonel Roca was in command of a garrison, and at once struck Prof. Crawford as a man most highly gifted by the possession of many qualities not often associated in the same individual. He has since risen in his profession to be a general, and now as President of the Argentine Republic directs its affairs with wisdom and firmness.

The country now became more interesting, and the Rio Quinto presented well-wooded banks. Christmas Day was spent in camp, the thermometer indicating 104° F. in the shade. At Villa Mercedes the Rio Quinto runs in a valley it has formed for itself some 1270 yards wide. Here oxen were changed for mules, and the weariness of the delay at this station was aggravated by the great heat of the weather during the day, and the intensity, by contrast, of the cold at night, the thermometer ranging from 107° F. in the shade during the day to 34° F. at night. The mules gave great trouble, refusing to carry the baggage carts, and almost bringing the expedition to a close; but again the energy of its head succeeded in getting matters to rights, but not before a journey to San Luis, and procuring there the requisite number of pack mules. San Luis was left on February 3, and Mendoza was reached about the 11th. The first sight of the glorious range of the Andes inspired the expedition with a fresh energy.

"The scene which met our tired eyes was one of such magnificence and grandeur as soon dispelled all weariness, and filled us with wonder and amazement. There stood the Andes boldly outlined against the sky, with the mighty 'Tupungato' towering like a giant above the other peaks, its snow-clad summit bathed in gold by the sun's first rays (itself not yet apparent over the horizon), while rosy clouds alternating with crimson and violet of deepest hue, brought out the lights and shades upon the rugged mountain tops, and all below was merged in one vast sea of sombre grey, night's mantle, which the sleeping earth had not yet put aside. Each moment did the picture alter, and every change brought with it some fresh beauty not before perceived, till the sun, rising from the pampas as from the ocean, covered the mountains with a dazzling light, in which the delicate tints and shades of colour disappeared, and last of all the darkness at their base resolved itself into a thin blue cloud like smoke, which hung about them for a while, and then too, was in turn forced to yield and vanish as the rest had done. It was impossible to look on such a scene unmoved, or to find words wherewith to reproduce it to another's eye. Gladly would we have lingered gazing at the view before us, but business, demanding our attention, recalled us to more practical affairs. It was necessary that we should be off without delay; a long and weary journey lying before us. That day we travelled six-and-thirty miles, three-fourths of the distance being over a barren sandy soil, destitute alike of grass and water. The day was very hot, and during it all our dogs, which for many months had followed the fortunes of the expedition, disappeared; where they had gone to no one knew, but it was thought that possibly they had sought shelter from the scorching heat under some thick shrubs we passed upon the route, and never afterwards had been able to overtake or find us; or when the cold of night came on,

they may have retraced their steps back on the route we took that morning and joined their lot with the first settler they fell in with. Whatever was their fate, we deeply regretted to have lost our faithful followers and friends."

Soon they were up among the Andes into deep ravines among lofty hills, now descending into valleys, and soon afterwards ascending giddy heights. An extinct volcano, now a beautiful mountain called the "Cerrito Diamante," was passed; some thirty miles from it a rill of a yellowish-white fluid, like petroleum, issuing from the mountain-side at a considerable height, was discovered. The source from which it flowed was at the junction where a hard metamorphic rock interspersed with small augite crystals overlay a stratum of volcanic tuff. It was in form like a crater of a volcano, and full of a black bituminous matter, hot and sticky, which could be stirred to a depth of about 18 inches. Floundering in it was a polecat, which had been enticed to its fate by a bird caught in this natural birdlime. The overflow was 2 or 3 feet wide, and as it spread out it became of an asphalt-like form. Two other little birds were found entangled in the stream, and on being released both feathers and skin came off. Possibly they had mistaken the stream for water. A further search revealed many bird and small mammalian skeletons embedded in the mass, possibly a puzzle for some palæontologist in days to come. After leaving the River Atuel sandstone and limestone strata were met with, and on February 29 their colleagues from the Pacific coast who had crossed the Andes by the Planchon Pass were met. The combined party rested a few days in the highland valley of Las Leñas Amarillas, where guanacos abounded. The watershed of this district was reached at a level of 9200 feet above the sea, the scenery being of surpassing beauty, and the Andes are described as having no lovelier spot than this secluded "Valle Hermoso." Here a good deal of land-surveying was accomplished, and also in the region of the Rio Grande. In the middle of March the passage of the Andes was begun *via* the Planchon Pass. The attempt to cross by the head of the Rio Grande was frustrated by the dangerous illness of a colleague when a height of about 11,000 feet had been attained, and fearing the consequences if they bore him to the summit (1000 feet higher), they retraced their steps and went over by the Planchon Pass, 8225 feet above sea-level. On the descent silver and copper mines were passed. After five months of hardships, a day at the lovely baths of Cauquenes was thoroughly enjoyed, and on March 25 the party arrived at Santiago de Chili, described as a city which for its position cannot be surpassed in grandeur and the magnificence of its surroundings. After a fortnight's sojourn here, Valparaiso was reached by rail, from whence, proceeding through the Magellan Straits, Monte Video was reached, and thence home.

All through the narrative the reader's interest is sustained, and the author might often indeed have ventured on further details without the least risk of being tedious. The trials and hardships undergone are very slightly dwelt upon, but they must have been many and great. On the result of his labours, and on this pleasant narration of some of the chief incidents of his travels, we heartily congratulate Mr Crawford, whom we are also glad to find once more located within the walls of his ancient University, laying the varied experiences of his life before the engineering classes of Trinity College, Dublin.

In a most valuable and important series of appendixes we have an excellent account of the peaks and passes of the Andes, which seem in every way worthy of the Alpine clubs of Europe; a most important essay on the Argentine Republic, its position and extent, its Indian frontier and invasions, its colonies and railways—a Republic with a great future before it, and one in which our British interests are largely involved.

### THE INTERNATIONAL HEALTH AND EDUCATION EXHIBITION.

There is at first sight some lack of unity of purpose in an exhibition which undertakes to illustrate such diverse subjects as health and public education. This impression will be in the present case confirmed partly by the postponement of the opening of the Educational Section to the month of June, and partly by the fact that the display of educational appliances will be held in the neighbouring building, the new Technical School of the City and Guilds of London Institute, and not in the galleries of the Exhibition building itself. A mere miscellaneous collection of objects more or less illustrative of school work, e.g. furniture, fittings, apparatus, and diagrams, would, however, prove of little general interest and value, unless it were on a very comprehensive scale. The Executive Committee, therefore, have wisely decided to limit the scope of the educational part of the Exhibition of the present year, and to direct the attention of exhibitors mainly to the elucidation of a few special problems which possess exceptional importance or public interest at the present time. Foremost among these are the subjects of technical and scientific instruction, trade and apprenticeship schools, the teaching of art, and the Kindergarten with other devices for infant training. The accidental association of this part of the Exhibition with one devoted to the subject of health has also naturally suggested another class of illustrative display likely to prove particularly interesting to school managers and the public at this moment. While the Executive Committee has shown no disposition to encourage the absurdly exaggerated and not very sincere outcry which has been raised about the "over-pressure" of children in schools, they have shown much judgment in giving special prominence to those "exhibits" which are designed to illustrate the conditions of healthy life in schools. Accordingly, models of the best school buildings, appliances for warming, lighting, and ventilating, improved desks and fittings, contrivances for securing right posture for the limbs and for preventing injury to eyesight, precautions against disease in schools, will be largely shown. The whole subject of physical training will also, it is expected, be illustrated with unusual fullness and variety. Models and examples of the latest and best forms of gymnastic apparatus in use in England and in foreign countries will be shown; and arrangements are being made, with the sanction of the heads of the Admiralty and of the War Office, for the practical exposition of the methods of military drill in use in the great military and naval schools at Chelsea and Greenwich, on certain afternoons on which the boys can be spared for this purpose from their ordinary school duties.

The increased attention now being directed to the whole subject of infant training; the extended interest taken by the best teachers in the study of the methods of Fröbel; and the recognition by the Education Department for the first time, in Mr. Mundella's Code, of the need of training, object lessons, recreation, and varied employment in infant schools, as well as instruction in reading, writing, and arithmetic, have justified the appropriation of a considerable space to the Kindergarten, and to the exhibition of pictures, games, manual exercises, and apparatus specially adapted for the training of very young children, whether in schools or nurseries. There is reason to believe that this department of the display will be especially full and interesting, and will comprise some of the latest and most ingenious of the devices for infant discipline which are in use in Germany and Switzerland, as well as in our own country.

Closely connected also with the general design of the Exhibition to show how school-life may be made healthier, brighter, happier, and more interesting, there will be a considerable display of pictures and school de-

corations. The "Art for Schools Association" and other exhibitors will seek to show how the school-room may be incidentally useful in improving the taste and stimulating the imagination of the scholars; and it may be hoped that many teachers will gather from the Exhibition some fruitful suggestions as to the manner in which art may give added reality and force to lessons on history, on descriptive geography, on the facts of science, and on the life of the ancient world.

The London, Birmingham, and other School Boards have arranged for collective displays of their best fittings, desks, and other apparatus. Illustrations and models of school kitchens, cookery schools, and the latest appliances for the practical teaching of domestic economy will be tolerably numerous; and special pains have been taken by those members of the Education Committee who have recently served on the Technical Instruction Commission to procure some of the most characteristic illustrations of the methods of technical and industrial teaching in use in the trade and apprentice schools of the Continent.

There will be a library and reading room attached to the educational department of the Exhibition; and a large collection of the newest text-books, treatises, diagrams, and works of reference having relation to the subject of the Exhibition will be so arranged that they may easily be consulted by visitors.

One very interesting feature of the whole programme will be found in the plan—not yet fully matured—for an International Congress or series of Conferences to be held in connection with the Exhibition during the first week in August. A large attendance of delegates from foreign countries is expected, and some of the most important educational problems of the day will be discussed. The sub-Committee, which has spent much time in arranging the details, is representative in its character, and consists of Lord Reay, the Hon. L. Stanley, two of the Senior Inspectors of Schools, Mr. Sharpe and Mr. J. G. Fitch, Archdeacon Emery, the Rev. Dr. Graham of the Hammersmith Training College, Mr. Storr, Mr. Magnus, Mr. St. John Ackers, and Dr. Rigg. So far as the arrangements have yet been published, they promise to provide a series of valuable public discussions, by persons of authority in their special departments, on the organisation of primary, secondary, and university education; on the conditions of health and physical development in schools; on the professional training of teachers, the testing of their qualifications, and the public recognition of those qualifications; on several special departments of instruction, e.g. infant training, art teaching, science and technical teaching; and on museums, libraries, and other subsidiary agencies by which the influence of the school may be extended to the home life, to leisure, and to the means of self-improvement.

### NOTES

THE Council of the Royal Society have selected the following fifteen candidates to be recommended for election at the annual meeting on June 12 next:—Prof. George Johnston Allman, LL.D., Prof. Isaac Bayley Balfour, D.Sc., Joseph Baxendell, F.R.A.S., James Bell, F.I.C., Prof. Walter Noel Hartley, F.R.S.E., Prof. Alexander Stewart Herschel, M.A., Wilfrid H. Hudleston, M.A., Prof. Horace Lamb, M.A., Prof. John G. McKendrick, M.D., Arthur Ransome, M.D., Prof. Charles Smart Roy, M.D., Prof. Arthur William Rücker, M.A., Joseph John Thomson, B.A., Lieut.-Col. Charles Warren, C.M.G., and Prof. Morrison Watson, M.D.

THE following three *savants* were elected Foreign Members of the Linnean Society at the last meeting, May 1:—Dr. Ernst Haeckel, Professor of Zoology and Director of the Zoological Institut, Museum, University of Jena, among other things well known for his studies of Sponges, Radiolarians, Medusæ, &c.;



Dr. Alexander Kowalevsky, Professor and Director of the Zoological Cabinet, &c., in the University of Odessa, notable for his anatomical and embryological researches on the Tunicates, Holothurians, Coelenterata, &c.; and Dr. S. Schwendener, Professor of Botany, University of Berlin, whose labours in cryptogamic botany, more especially Lichens and Algæ, receive due appreciation by his kindred workers on these and allied topics.

A CIRCULAR signed by Prof. Ray Lankester, Secretary *pro tem.*, and Mr. Frank Crisp, Treasurer *pro tem.*, has been issued from Burlington House, London, with reference to the proposed "Marine Biological Association of the United Kingdom." The object of the Society, as explained by the speeches made at the meeting of March 31, is to erect and maintain at suitable points on the coast one or more laboratories similar to the Zoological Station of Naples and the American Laboratories of Newport and Chesapeake, to which naturalists may resort for the purpose of investigating the history of marine life, both animal and vegetable, and the various conditions affecting the welfare of British food-fishes and mollusks. It is proposed, in the first place, to establish a laboratory on the south coast of England. To build this laboratory and equip it in an efficient manner with boats, dredging apparatus, and tanks, a sum of not less than 10,000*l.* is desirable, whilst an income of not less than 1500*l.* a year will be required to maintain it and to pay the wages of attendants and fishermen and the salary of a resident superintendent. The Provisional Committee, as authorised by the meeting on March 31, has made the following rules with regard to membership of the Society:—"The Members of the Society shall consist of three classes—(a) Donors of 500*l.* and upwards to the Society, who shall be Governors and permanent Members of the Council. (b) Donors of 100*l.* to the Society, who shall be Founders and Members of the Society for life. (c) Annual Subscribers of 1*l.* 1*s.* The subscription may be compounded for at any time by a payment of 15*l.* 15*s.*" The members of the Society will shortly meet to elect a Council and Officers, and to adopt a constitution and rules. It is proposed that the members shall meet at least once a year for the purpose of electing a Council and transacting other business, and they will receive reports of the work done by the Society, and especially of the investigations carried out in the laboratory maintained by its agency. In addition to the fixed contributions above mentioned in connection with membership, the Committee invite special donations towards defraying the expenses of erecting the first laboratory. Those desiring to become members should communicate as soon as possible with the Treasurer, at 6, Old Jewry, E. C.

THE Annual Meeting of the Academy of Sciences of Paris was held on Monday, M. Blanchard, president for 1883, being in the chair. M. Blanchard opened the sitting by an address, reciting all the losses that the Academy had sustained during the past year. He dwelt principally on the exceptional eminence of M. Dumas. He summarised also the several scientific expeditions which had been fitted out by the French Government during the year after having taken the advice of the French Academy. M. Bouley read the list of the awards granted by the several academical commissions, and which is too long to be reproduced in our columns, the number of these foundations being yearly enlarged; thus far no less than three prizes were distributed for the first time—the Penaud Prize for progress in Aëronautics to MM. Tissandier, Taton, and Leroy de Brognac, and two prizes by Le Petit d'Ormay, one for physical sciences, and the other for mathematics. The interest of the Bréant Prize (4000*l.*) for curing the cholera was bestowed on M. Pasteur's pupils, who have studied the subject in Egypt on the spot. One of the astronomical prizes was given to M. Stephan of Marseilles, and the other to several members of the transit missions not belonging to the

Academy Gold medals were distributed to the marine officers who took part in the expedition of the *Travailleur* under Milne-Edwards for exploring the Atlantic, and to those who wintered with the *Romanche* in Terra del Fuego, in connection with other Polar expeditions. M. Bertrand read the *loge* which had been written by M. Dumas on the brothers Deville, both of them members of the Academy of Sciences, who died, Charles, the geologist, in 1876, and Henry in 1881, both at the same age. After having read this address on behalf of his illustrious colleague, M. Bertrand read for himself an *loge* on Puiseux, a Member of the Mathematical Section.

THE following, according to *Science*, is a complete list of the papers read at the meeting of the United States National Academy of Sciences, April 15 to 18:—G. K. Gilbert, the sufficiency of terrestrial rotation to deflect river-courses; T. Sterry Hunt, the origin of crystalline rocks; Simon Newcomb, on the photographs of the transit of Venus taken at the Lick Observatory; A. E. Verrill, zoological results of the deep-sea dredging expedition of the U.S. Fish Commission steamer *Albatross*; Ira Remsen, the quantitative estimation of carbon in ordinary phosphorus; reduction of halogen derivatives of carbon compounds; Elias Loomis, reduction of barometric observations to sea-level; C. S. Peirce, the study of comparative biography; C. S. Peirce and J. Jastrow (by invitation), whether there is a minimum perceptible difference of sensation; S. P. Langley, the character of the heat radiated from the soil; J. E. Hilgard, on the depth of the western part of the Atlantic Ocean and Gulf of Mexico, with an exhibition of a relief model; on the relative levels of the western part of the Atlantic Ocean and Gulf of Mexico with respect to the Gulf Stream; account of some recent pendulum experiments in different parts of the world, made in connection with the U.S. Coast and Geodetic Survey; E. D. Cope, on the structure and affinities of *Didymodus*, a still living genus of sharks of the Carboniferous period; on the North American species of mastodon; Theo. Gill and John A. Ryder (by invitation), the characteristics of the lyomerous fishes; on the classification of the apodal fishes; Theo. Gill, on the ichthyological peculiarities of the bassalian realm; George F. Barker, on the Fritts selenium cell; on a lantern voltmeter; George J. Brush, on the occurrence of mercury in native silver from Lake Superior; H. A. Rowland, progress in making a new photograph of the spectrum; B. Silliman, on the existence of tin ore in the older rocks of the Blue Ridge; H. M. Paul (by invitation), the Krakatoa atmospheric waves, and the question of a connection between barometric pressure and atmospheric electricity; John S. Billings, memorandum on composite photographs in craniology; A. W. Wright, some experiments upon the spectra of oxygen; Elliott Coues, on the application of trinomial nomenclature to zoology; E. M. Gallaudet (by invitation), some recent results of the oral and aural teaching of the deaf, under the combined system; F. W. Clarke (by invitation), jade implements from Alaska; Henry L. Abbot, recent progress in electrical fuses; J. S. Diller (by invitation), the volcanic sand which fell at Unalashka, October 20, 1883, and some considerations concerning its composition. The following biographical notices of deceased members were also read:—Of Gen. G. K. Warren, by H. L. Abbot; of Prof. Stephen Alexander, by C. A. Young; of Dr. J. Lawrence Smith, by B. Silliman; and of Dr. John L. LeConte, by S. H. Scudder.

ON Saturday last a banquet was given by a number of anthropologists to M. Gabriel de Mortillet, Conservator of the St. Germain Museum of National Antiquities, and his portrait, was presented to him. M. de Mortillet stated that his usual summer excursion would take place this month or in the beginning of June, and that Brittany would be chosen as a field for exploration. Any person wishing to join the Professor

in his scientific tour may write to M. de Mortillet at the Château de Saint Germain. The banquet hall was decorated with a life-size picture of an early Gaul. The picture was executed according to the last discoveries of M. de Mortillet. The man is represented as having no hair on his body; his arms are very long and muscles very powerful, but the toes of his feet are not opposable, although they could be used for climbing the trees of the primitive forest. His jaw is strongly prognathous, but not at all equal to that of an anthropoid ape. His breadth is strongly compressed laterally and his abdomen prominent. The skin is not negroid, but of our present colour. The expression of the face is in intelligence on a level with that of an Australian.

ANTHROPOLOGY plays a great part in the Paris *salon* this year. One of the largest pictures, attracting the attention of crowds, represents a primeval tribe preparing in their cave to feed upon an *Ursus spelæus* which has been killed by the warriors with their stone implements.

THE spring meeting of the Institution of Mechanical Engineers was held at the Institution of Civil Engineers on May 1 and 2. The most interesting paper read was on the Consumption of Fuel in Locomotives, by M. Georges Marié, Engineer to the Paris and Lyons Railways. This paper is of considerable importance as bearing on the actual economy of the locomotive considered as a heat engine. The chief conclusion is that the locomotive is a better engine, as regards economy of fuel, than is usually believed, and cannot be very much improved unless the pressure in the boiler can be increased at one end or a condenser applied at the other. The author looks forward confidently to both these improvements, but when achieved they will, he considers, necessitate an improvement in the valve gear, and probably the use of compound engines on the scheme now brought forward by Mr. Webb. With these and with some other improvements, such as a better clothing of the boiler and the heating of the feed-water by the exhaust-steam, M. Marié looks forward to the locomotive attaining a position, as regards economy of fuel, much beyond even that which it possesses at present. The other papers read were entirely of a practical character, with the exception of one by Mr. Robert Gordon, of Burmah, describing the apparatus used at Mr. Froude's works at Torquay, for testing current meters. The arrangement of the tank, dynamometer, governor, &c., is clearly described, but would hardly be intelligible without the aid of drawings.

WE are glad to direct the attention of our readers to the *Health Journal*, published by Heywood of Manchester, and which, with the May number, has concluded its first volume. The *Journal* is a monthly review "of sanitary science and of voluntary effort for the public good." It seems to us to be admirably calculated to serve the purpose for which it has been established, and we hope it will receive all the encouragement it deserves.

THE recent threat of certain French journals that their troops would occupy the island of Hainan until China had paid an indemnity has directed attention to that little-known appendage of the Chinese Empire. In a late number of that valuable periodical, the *China Review*, we find an account of a journey through Hainan by Mr. Henry. As in other outlying possessions of China, the native tribes have succeeded in a measure in holding their own against the ubiquitous Chinese. The northern part of the island is described as a large plain, while the central and southern portions are mountainous. Here the aboriginal tribes, the *Les*, take refuge. They are cordial and hospitable to strangers, and are probably of Malay origin. There are fifteen or sixteen different tribes, known under distinct names, varying more or less in dress, language, and customs, but all evidently belonging to one homogeneous race, bound together by common

ties, and, as a rule, living on friendly terms with each other. The flora and fauna appear singularly rich, and but little investigated. In a visit of a few weeks the late Mr. Swinhoe noted 172 species of birds, nineteen of which were new to science, and were first described by him. The leeches are an especial plague to the traveller. They are described as of a grayish-brown and earthen hue, and vary from half an inch to an inch and a half in length, and swarm from the ground on all sides. Along the path, on the ends of grass blades and branches of shrubs, they may be seen holding by one end, while they reach out their whole length feeling on every side for their prey. The instant they touch foot or hand, or any part of the body, they take fast hold, and can only be detached by the application of fire, or when they are sated with blood. The natives carry bamboo sticks, with which by a quick motion they can sometimes detach them. Although the people appear in a state of rural prosperity, as there is very little foreign trade, while the climate is bad, it is difficult to see what France would gain by the occupation of the island.

REPORTS from Mount Hamilton, California, *Science* states, say that this has been the most stormy winter known since observations were begun at the Lick Observatory. The bad weather did not begin till so late in January that a drought in California was feared; but there have been 40 inches of rain and melted snow up to April 4, and at that date the mountain was covered with 2 feet of snow. The anemometer cups were blown away, with the wind-gauge indicating 65 miles per hour. The lowest temperature has been + 12°; and at this temperature outside water did not freeze within the uncompleted buildings.

THE additions to the Zoological Society's Gardens during the past week include a Rhesus Monkey (*Macacus rhesus* ♀) from India, presented by Miss Harbord; a Pig-tailed Monkey (*Macacus nemestrinus*) from Java, presented by Miss Ethel Fenwick; a Macaque Monkey (*Macacus cynomolgus* ♂) from India, presented by Mr. F. Harrison; a Garnett's Galago (*Galago garnetti* ♂) from Eastern Africa, presented by Lieut. James Knowles, R.N.; a Dow's Tapir (*Tapirus dowii* ♂) from Venezuela, presented by Mr. Reginald Pringle; a Spotted Ichneumon (*Herpestes nepalensis*) from Nepal, presented by Mr. John Walker; two Clapperton's Francolins (*Francolinus clapperton*) from West Africa, presented by Major H. Wade Dalton; two Chukar Partridges (*Caccabis chukar*) from North-West India, presented by Lieut.-Col. C. Swinhoe; a Herring Gull (*Larus argentatus*), European, presented by Miss Laura Dunning; two Barn Owls (*Strix flammea*), British, presented by Mr. R. Church; two Hoary Snakes (*Coronella cana*) from South Africa, presented by Mr. E. Watson; two Wattled Cranes (*Grus carunculata*) from South Africa, two Spur-winged Geese (*Plectropterus gambensis*), four Vinaceous Turtle Doves (*Turtur vinaceus*), three Harlequin Quails (*Coturnix histrionica* ♂ & ♀) from West Africa, deposited; a Grey-cheeked Mangabey (*Cercocebus albigena* ♂) from West Africa, two White Cranes (*Grus leucogeranus*) from India, a Cabot's Horned Tragopan (*Ceiornis caboti* ♂) from China, a Banded Gymnogene (*Polyboroides typicus*) from Africa, two Yucatan Blue Jays (*Cyanocitta yucatanica*) from Yucatan, two Axolotls (*Siredon mexicanus*) from Mexico, purchased; a Moustache Monkey (*Cercopithecus cephus*) from West Africa, received in exchange; a Maholi Galago (*Galago maholi*), seven Coypus (*Myopotamus coypus*), born in the Gardens.

#### OUR ASTRONOMICAL COLUMN

WHITE SPOTS UPON VENUS.—Four years since M. Trouvelot drew attention to two remarkable white spots which he had observed on opposite limbs of Venus, near the extremity of the cusps, from November 13, 1877, to February 7, 1878. The

southern spot was the brighter of the two, and "appeared then to be composed of a multitude of bright peaks, forming on its northern border a row of brilliant, star-like dots of light." The white spots disappeared after the inferior conjunction, which occurred on February 21.

At the sitting of the Academy of Sciences of Paris on March 24, M. Trouvelot mentioned that on two hundred and forty-two occasions since February 1878 he had observed one or other of the luminous spots, and occasionally both, and had made upwards of one hundred and twenty drawings. Since April 5 in the present year he had not lost sight of the northern spot, which alone was visible at that date. He did not find the spots affected by the diurnal rotation of the planet, and hence infers that the axis passes either through or very close to their centre. In this view it will be interesting to compare the position of the axis of the spots determined by his observations with the results obtained by De Vico and others. An attempt in this direction, founded upon some of the more satisfactory drawings, did not promise a near agreement. M. Trouvelot adds that the spots appear almost permanent, and thinks they are the summits of high mountains projecting beyond the cloudy envelope, generally opaque, which covers the planet.

The observations in 1877-78 were made at Cambridge, U.S., those of the present year at the Observatory of Meudon. De Vico's investigation on the position of the axis of Venus appeared in the *Memoirs* of the Observatory of the Collegio Romano for 1840-1841: it can hardly be said that his results, founded upon data necessarily vague, have inspired much confidence amongst astronomers. He made the inclination of the equator of Venus to the ecliptic  $53^{\circ} 11'$ , and the longitude of the ascending node  $57^{\circ} 19'$  for 1841; the rotation of Venus in sidereal time, 23h. 21m. 21<sup>o</sup>.93s.: these are the figures quoted in Secchi's "Life of De Vico."

**THE GREAT COMET OF 1882.**—Prof. Howe notifies that he has undertaken a definite determination of the orbit of this comet, which will doubtless be a work of some labour. Thus far calculation appears to indicate that the comet was moving in an ellipse, with a period not differing much from eight centuries: Kreutz gave 843, Fabritius 823, Frisby 794, and Morrison 712 years; the orbit of Fabritius depends upon the widest extent of observation. Between the earliest and latest accurate positions the comet described an orbital arc of  $340^{\circ}$ : a similar arc was traversed by the comet of 1680 between its discovery by Kirch on the morning of November 14 and the last observation by Sir Isaac Newton on March 19 following.

Those who may have unpublished observations of position of the great comet of 1882 will do well to communicate them to Prof. Howe forthwith.

**BROSEN'S COMET OF SHORT PERIOD.**—We have not yet met with any intimation that an ephemeris of this comet for the approaching reappearance is being prepared: that for the last return in 1879 was furnished by Prof. L. R. Schulze of Dobeln; the time of perihelion passage was about eleven hours later than his calculation gave it. Disregarding perturbation, the comet would be again due at perihelion in the middle of September next, in which case it would be observable in the two hours before sunrise, in August and September, under somewhat similar conditions to those in 1873. Supposing the perihelion passage to occur September 14<sup>h</sup> 5, the comet's position at that time would be in about R.A.  $154^{\circ} 5'$  and N.P.D.  $76^{\circ} 2'$ , the distance from the earth 1.41.

Since the discovery of this comet within one day of perihelion passage in 1846 it has been observed at four returns, viz. in 1857, 1868, 1873, and 1879.

### THE IRON AND STEEL INSTITUTE

THE annual meeting of the Iron and Steel Institute took place at the Institution of Civil Engineers on April 30 and May 1 and 2. The proceedings commenced with the reading of the Council's Report and the Accountant's statement, and with the presentation of the Bessemer Medal jointly to Mr. E. B. Martin of Dowlais and Mr. E. Windsor Richards of Middlesbrough, in recognition of the part taken by them in introducing the basic process for the manufacture of steel. In returning thanks, Mr. E. Windsor Richards mentioned that his firm, that of Messrs. Bolckow, Vaughan, and Co., were now making no less than 3000 tons per week by this process from Cleveland pig-iron, such

as would have been thought, until recently, wholly unsuitable for steel-making. Sir H. Bessemer, who was present, congratulated the recipients and the steel trade generally upon the brilliant success of Messrs. Thomas and Gilchrist's invention.

The first paper read was by Mr. I. L. Bell, F.R.S., and dealt with the use of Raw Coal in the Blast Furnace. It pointed out that this question, as being more complicated than that of coke, had never been treated before the Institute, although raw coal was largely used in the United States in the form of anthracite, and in Scotland in the form of the splint coal of the Lanarkshire coal-field. It is with the latter that the paper was chiefly concerned. Taking the Brockwell seam as a good specimen of Durham coking coal, analyses were given of it first in its raw state, and secondly when converted into coke, together with the number of heat units developed from one weight-unit of each. It appears that this number is 7437 in the case of the coal, and 7395 in the case of the coke, so that the heat developed in the two kinds of fuel is practically the same. This theoretical result was checked by experiments on a large scale made upon the North-Eastern Railway, using the same engines and the same weight of trains. The trials were continued for one week with each kind of fuel, full loads being taken to the place of shipment and the waggons returned empty to the collieries. The result in one trial in pounds consumed per train mile was 40.5 of coal and 41.6 of coke. In another experiment the difference was larger, but still it was not serious, and the theoretical deduction just given is thus fully confirmed. This equality of value between coal and coke is not, however, found to exist in the blast furnace, for the simple reason that the volatile constituents of the coal are scarcely oxidised at all, and therefore give but very little useful effect. They might, however, be utilised in another way, namely, as a means of reducing the oxide of iron to the metallic state. The gas from the coal would thus do part of the work now done by CO, and might enable a larger quantity of CO<sub>2</sub> to be evolved in the escaping gases. At present, however, this effect does not seem to be realised in practice. Analyses were given of the Lanarkshire splint coal, which show that, as a source of heat, it is inferior by about 30 per cent. to the South Durham coal. Analyses were also given of the escaping gases where this coal is used for smelting, and from this the quantity of heat evolved and appropriated was calculated, and compared with furnaces using coke. It thus appears that the raw coal occasions a much less perfect oxidation of the carbon, and in consequence a much smaller evolution of heat. On the other hand, the hydrogen contained in the coal affords a large supply of heat, but this and far more is absorbed in the expulsion of the volatile constituents, which is sufficiently proved by the very low temperature of the escaping gases, 190° C. as compared with 332° C. in the case of coke.

As regards the proportion of CO<sub>2</sub> and CO in the escaping gases, it appears that with coal it is much below the limit which Mr. Bell has fixed as the maximum compatible with reduction, viz. 1 of CO<sub>2</sub> to 2 of CO. Hence it follows that a considerable quantity of CO<sub>2</sub> must have dissolved carbon and so returned to CO. Calculating this quantity, it appears that the total carbon which reaches the hearth and gives up its heat for the fusion of iron, &c., is not very different in the two cases. Why then is there so large a disappearance of CO<sub>2</sub> in the Scotch furnace as compared with the English? Mr. Bell attributes it to the fact that the latter is 80 feet high, whilst the former, though 74 feet high, was only filled to 85 per cent. of its real capacity. The effect of the lower furnace is to diminish the time during which the ore is exposed to the reducing agency of CO, whilst still too cool for the fuel to decompose CO<sub>2</sub>. In addition it is suggested that the presence of hydrogen in the coal might cause the formation of steam, which would subsequently react on the fuel and tend to lower the percentage of CO<sub>2</sub>. On the whole it appears that when using raw coal in the blast furnace there is a waste of carbon to the extent of 3.72 units; but before recommending that the coal should be coked in order to avoid this loss, the commercial aspect of the question must be considered, and it appears that the cost of coking even where possible would in many cases exceed the saving attained. A further point, however, which needs consideration is the possibility of condensing the tar and ammonia given off by the coal and so saving the valuable products. Here we have a difficulty in the Scotch furnaces: the enormous quantity of gas which would have to be dealt with; nevertheless the results attained by Messrs. Baird in the Gartsherrie furnaces (given below) seem to show that the yield of ammonia is about the same as in the Simon-Carvès process for coking, as used

by Messrs. Pease, in which case the sulphate of ammonia and tar were worth about 3s. per ton of coal used. As theoretically five times this amount of sulphate of ammonia might be obtained from the coal, it seems probable that a large quantity of nitrogenous compounds may eventually be secured in this manner.

In the discussion on the paper, the fact of coal and coke being practically equal in heating power was confirmed by several speakers; and some interesting facts as to the anthracite blast furnaces of the United States were elicited. The advantages of calcining the limestone (which seem in most cases to be *nil*) and of mixing coke with coal in the charge were also discussed; and the important question of raw coal as an iron-smelting material may thus be said to be fairly opened.

The next two papers were taken together. The first was by Mr. R. Smith Casson on the system worked out by himself and M. Bicheroux for gas puddling and heating furnaces. This system, which has been worked with most satisfactory results in Belgium, is simpler and cheaper than that introduced by Sir William Siemens, and as regards efficiency and economy has much to recommend it. The other paper, by Mr. W. S. Sutherland, was on the most recent results in the application and utilisation of Gaseous and Liquid Fuels. It appears that Messrs. Baird and Co. are now recovering the tar and ammonia from the gases of no less than sixteen of their blast furnaces, consuming about 100 tons of coal daily. They manufacture the ammonia into sulphate and distil the tar, the actual yield per ton of coal varying from 18 lbs. to 25 lbs. of sulphate of ammonia, and from 180 lbs. to 200 lbs. of tar. The gas is found to be perfectly clean and free from moisture, and is thus better adapted than before to such purposes as raising steam, heating the blast, &c. In addition to this the paper described a new method of working the producers employed for generating gas in the Siemens or other systems of gaseous fuel, and for abstracting from the gas so obtained the tar and ammonia it comprises. It appears that a generator gas of high quality can now be got with certainty, at the same time yielding 20 lbs. of sulphate of ammonia with ten to twenty gallons of good tar per ton of coal. A net saving of from 2s. 6d. to 4s. per ton may thus be effected, and with the same result as in the case of the blast furnace, viz. that the gases are improved instead of being damaged by the removal of their valuable products. The using of such substances as tar and ammonia merely for fuel can only be considered barbarous, and it now seems probable that in a very few years it may be a thing of the past.

On Thursday the first paper read was by Mr. Walter R. Browne on Iron and Steel Permanent Way. It described the system of iron sleepers, successfully introduced by Mr. Webb of the London and North-Western Railway, and pointed out the many advantages that would result, especially to the iron trade of this country, if the use of metallic sleepers became a recognised fact. In Germany it is so already, thousands of miles being now laid with metallic sleepers; and it is to be hoped that a vigorous effort will be made to develop their use both in England and in our colonies.

The second paper, by Capt. C. Orde-Browne, R.A., dealt with the behaviour of Armour of different kinds under fire. Four kinds of armour were specified: first, wrought iron; secondly, compound armour or wrought iron with a steel face; thirdly, solid steel; fourthly, chilled cast iron. The different modes in which these yield to the impact of a shot were clearly described. Wrought iron is punched with a clean hole, the rest of the target hardly suffering any damage. As complete penetration is necessary, hardness and rigidity of metal are the essentials for a projectile, and not tenacity. Hence the extended use of Palliser's chilled shot. In compound armour the hard steel face severely tries the tenacity of the metal, so that the shot frequently breaks to pieces; at the same time the plate yields by cracking in radiating lines from the point of impact, and sometimes in concentric lines. Solid steel does not yield at the point of impact, but as the shot enters, it wedges and sets up the metal round it, the plate swelling and yielding by radiating cracks. Such cracks are much more likely to extend through the metal than is the case with compound plates. Chilled iron is broken up bodily by the direct blows of heavy shots, cracks radiating from the point of impact, which is never pierced even to a single inch of depth. Details were then given of the experiments carried out in 1882 at Essen, at Spezia, and at Ochta near St. Petersburg; in 1883, at Shoeburyness, and at Buckau on chilled cast iron; and finally experiments by Capt. Palliser and Sir Joseph Whitworth. Stress was laid on the necessity for dividing armour into two

distinct classes, soft and hard: the former signified armour which was perforated, and the latter armour which must be broken up. The difference was illustrated by a simple dropping apparatus, in which a model of a shot with a heavy weight behind it was allowed to fall either upon millboard, to represent soft iron, or upon brick, to represent hard iron. The likeness of the results to those found in practice with hard and soft armour respectively is very remarkable. It is therefore altogether a mistake, when attacking hard armour, to use the data obtained for perforation as a measure of the shot to be employed. The energy in the shot per ton of the weight of the shield is another measure which may be useful, but is not theoretically correct. To work out the problem mathematically is very difficult, and it is suggested that much might be learnt by firing steel bullets against plates of steel and chilled iron, keeping all conditions uniform except those whose relation is the object of investigation. Certainly some such experiments are needed, as are also actual trials against the hard armour, solid steel, or chilled iron, which is much used abroad; otherwise, should we be involved in a war, we might find that our calculations, based only on soft armour, would land us in disastrous failure.

The first paper on Friday was on Recent Improvements in Iron and Steel Shipbuilding, by Mr. William John of Barrow-in-Furness. This paper gave some remarkable statistics of steel-built vessels during the last few years. It appears that between 1879 and 1883 the proportion of steel vessels built and registered in the United Kingdom increased from 4.38 per cent. in 1879 to 15.7 per cent. in 1883; wooden vessels being left out of account in each case. It is evident that steel as a material for shipbuilding has passed entirely out of the experimental stage, and must be judged by the results of its working in the shipyards, and the performance of the ships already afloat. The experience of those shipbuilders who have paid most attention to steel is that it has now become a much more uniform and satisfactory material than iron, so that workmen actually complain if they are put to work upon iron, from the trouble and annoyance it involves. The only point of practical importance left is the deterioration which occasionally occurs when thick plates of steel are punched. On this further information is necessary, as also on the real cause of the failures that took place some years ago, especially those in the boilers of the *Livadia*. In some cases, metal of which the chemical analysis showed nothing abnormal, and which would bend double when the edges were carefully prepared, broke off like glass when the edges were rough, or when holes were punched in it. The paper then went on to consider the difference in cost between vessels built of iron and steel, which at the present rate appears to be practically insignificant. On the other hand, strength is decidedly in favour of steel ships, even with the present reduction of scantlings sanctioned by Lloyd's. The case was mentioned of the *Duke of Westminster*, a vessel 400 feet long, which bumped for a week at the back of the Isle of Wight on stony ground without making a drop of water. This was owing to the elasticity of the steel, and could not possibly occur with an iron ship. With regard to corrosion, Mr. Johns considered that this was a matter to be overcome by increased knowledge and care in maintenance, while there was no evidence to show that the difference in corrosion between steel and iron is sufficient to stop the progress of steel shipbuilding. Finally he observed that great attention had been paid of late to the longitudinal strains on very large ships, much greater use being made of iron decks, longitudinal stringers in the bottom, &c., so that he could no longer show, as he had in 1874, that vessels grew steadily weaker as they increased in size. In the discussion, Mr. Martell, Inspector of Lloyd's, confirmed the view that steel is infinitely superior to ordinary iron, and that there is no reason to suppose that it deteriorates faster. He mentioned a ship built in 1878 for the iron ore trade, which as yet showed no sign of deterioration. On the other hand, Mr. Jeremiah Head mentioned that, despite the progress of steel, more iron had been used in shipbuilding during the last year than ever before, and that steel plates were still much more expensive than steel rails from the necessity of hammering them after rolling. He maintained that common iron did not corrode so much as best iron or steel: the *Great Britain*, built in 1845, is still in existence, and so is a collier built in 1831. Mr. Riley confirmed the necessity of hammering, owing to the increased number of failures if this was neglected. Sir Henry Bessemer and others also took part in the discussion. This concluded the business of the meeting, the remaining papers being adjourned.

THE BUILDING OF THE ALPS<sup>1</sup>

WHEN were the Alps upraised, and what is the age of their building stones? On the former of these questions there is less diversity of opinion than on the latter; yet, notwithstanding all that has been written on both, I am not without hope that I may find a few things sufficiently novel to be of interest to a general audience.

The subject, indeed, is so vast that I must crave your indulgence for leaving some gaps in my reasoning unfilled, and presenting you with little more than an outline. To save time I shall assume a knowledge of the simpler geological terms, asking you only to remember that I always use the word "schist," as I maintain it ought to be used, to denote a more or less fissile rock the constituents of which have undergone so much mineral change that, as a rule, their original nature is almost wholly a matter of conjecture. I must also ask you to remember that, though I have seldom mentioned the names of other workers, I am really doing little more than giving an epitome of the labours of a host of geologists, conspicuous among whom are Heim, Baltzer, Von Hauer, Gastaldi, Lory, Favre, Renevier, and many more, both Continental and English; I select, however, those facts with which I have myself become familiar during many visits to different districts of the Alps, from the Viso on the south to the Dachstein on the east.

It is needless, I assume, to explain that mountain chains are the result of lateral thrust rather than of vertical upheaval, and their contours are mainly due to the sculpturing action of heat and frost, rain and rivers, acting upon rocks bent into various positions, and of various degrees of destructibility. There are, however, three principles which are less familiar, but which I must ask you to bear in mind throughout this lecture: (1) that when a true schist is asserted to be the metamorphosed representative of a post-Archæan rock, the *onus probandi* lies with him who makes the assertion; (2) that rocks composed of the detritus of older rocks may often readily be mistaken for them; (3) that great caution is needed in applying the principles of lowland stratigraphy to a mountain region. The first of these is, I know, disputed, but there can be little doubt as to its accuracy; the second is indisputable, so is the third; but I will briefly illustrate what I mean by the statement. [Attention was then directed to diagrams of folds and reversals of strata in the Alps.]

The first section to which I invite your attention is in the neighbourhood of the Lake of Lucerne. There are few travellers to whom the cliffs of the Rigi are not familiar. Those great walls of rock, along and beneath which the Rigibahn now takes its audacious way, are mainly composed of enormous masses of conglomerate, an indurated gravel of Miocene age, called the nagelfluë. These pebble beds may be traced in greater or less development along the north-western margin of the Swiss Alps; they attain in the Rigi and the fatal crags of the adjoining Rossberg a thickness of not less than 2000 feet. The structure and nature of this nagelfluë show that it has been deposited by rivers, possibly at their entry into lakes, but more probably, as suggested by my friend Mr. Blanford, on beginning a lowland course at the very gates of the mountains. In this great mass there are indeed pebbles of doubtful derivation; but we need not hesitate to refer the bulk of them to the mountains which lie towards the east, and we may regard the great pebble beds of the Rigi and the Rossberg as built of the ruins of Miocene Alps by the streams of a Miocene Reuss. Now when we scrutinise the pebbles of this nagelfluë we are at once struck by a remarkable fact. The Reuss, at the present day, only passes through Mesozoic rocks when it approaches the neighbourhood of the Lake of Lucerne. It is within the mark to say that quite three-fourths of its drainage area consists of crystalline rocks. Hence schists and gneisses abound among its pebbles, and the same rocks are no less frequent among the erratics which have been deposited by the vanished glaciers of the Great Ice Age on the flanks of the Rigi to a height of 2000 feet above the Lake of Lucerne. Yet, on examining the nagelfluë, we find that, while pebbles of grit, and limestone, and chert—specimens of the Alpine Mesozoic rocks—abound, pebbles of schist and gneiss are extremely rare. I had searched for hours before I found a single one. The matrix also of the nagelfluë—the mortar which makes this natural concrete—when examined beneath the microscope, tells the same story. We do not see in it the frequent quartz grains, the occa-

sional pieces of felspar, the mica flakes, which are records of the detrition of gneissic rocks, but it consists of fragments similar to those which form the larger pebbles. It is therefore a legitimate inference that, in this part of the Alps at least, the protective covering of Mesozoic rock in the Miocene age had not generally been stripped away from the crystalline schists of the Upper Reuss, and that since then the mountains may have been diminished and the valleys deepened by at least a mile vertically. I have spoken only of the valley of the Reuss, but a little consideration will show that my remarks may be extended to a much larger area of the Oberland Alps.

I pass now to two other sections: of these the first is in the neighbourhood of Pontresina. Most of the peaks in this region consist of igneous rocks, of gneisses, and of schists, but some of later date are not wanting—as, for example, may be seen in the flanks of the well-known Heulthal. These last are limestones of Triassic age. Here they overlie unconformably a coarse gneiss—in other places they rest on schists presumably of later date; in fact, the series of Mesozoic rocks of which the above limestone is the lowest member—though now to a great extent removed by denudation—has clearly once passed transgressively over the whole series of gneisses and schists of the Engadine.

The second section, or rather group of sections, is some distance away to the south-east, in the region of the Italian Tyrol. Those magnificent crags of the Dolomite mountains, the serrate teeth of the Koenigsarten and the Langkofel, the towers of the Cristallo and the Drei Zinnen, the precipitous masses of the Blattkogel and the Marmolata, are built up of rocks of Triassic age, not of a very different date from the soft red marls which occupy so large an area in the Midlands of England. Follow me for one moment by the mountain road from Predazzo to Primiero. At the former place—classic ground for geologists—we are surrounded by great masses of igneous rocks, the roots, it may be, of long-vanished cones, although we refuse to recognise a crater in the valley about Predazzo. As we ascend towards the beautiful Alps of Paneveggio, we pass for a considerable distance over a great mass of red felsstone. This belongs to a group of igneous rocks which extend to the westward even beyond the Etsch. It is overlain by the beds of the Trias, commencing with the red Grotner sandstone and passing up soon into the vast masses of dolomite which form the wild crags of the Cimón della Pala and its attendant summits. But as we descend on the other side of the pass towards Primiero, we see the Triassic rocks, without the intervention of the felsstone, resting upon mica schists, similar to those which occur in many other parts of the Alps. Sections of the above kind, were it needful, might be multiplied indefinitely to prove that between the base of the Trias and the Alpine schists and gneisses there is an enormous break, but we may content ourselves with one other, interesting not only for the completeness of the demonstration, but also for the mode in which it illustrates Alpine structure. [Attention was then directed to the section of the Mont Blanc range as given by Prof. Favre.]

The Aiguilles Rouges are composed of coarse gneisses and crystalline schists, but on the highest summit there remains a fragmental outlier of stratified and unaltered rock. The upper part of this is certainly Jurassic. Below this comes a representative of the Trias—much attenuated, as it is generally in this western region, with possibly a remnant of a deposit of Carboniferous age. Be that as it may, there is undoubtedly here a great break between the crystalline series and the succeeding Mesozoic or Palæozoic rock.

There remains yet one other section to which I wish to direct your attention; it is near Vernayaz, in the vicinity of the famous gorge of the Trient. Where the Rhone bends, at Martigny, from a south-west to a north-west course, the crystalline *massif* of the Mont Blanc region of which we have just spoken crosses the river, and is lost to sight as it plunges beneath the Mesozoic rocks of the western summits of the Oberland. The gorge of the Trient is cut through hard and moderately coarse gneiss; the same rock occurs at the Salenche waterfall. Between the two is a mass of rock of a totally different character—in part a dark slate, like some in Britain of Lower Silurian age; in part a conglomerate or breccia in a micaceous matrix, proved by its plant remains to be a member of the Carboniferous series. Omitting some minor details, not without interest, it may suffice to say that we have in this place the end of an almost vertical loop, formed by the folding of beds of Carboniferous age between the crystalline rocks, which are the foundation-stones of the district. The conglomerate is at the base of the Carboniferous

<sup>1</sup> Lecture by Prof. T. G. Bonney, D.Sc., F.R.S., Prae.G.S., at the Royal Institution, April 4.

series, and its matrix so closely resembles a mica schist that it has been claimed as indicating metamorphism, and as linking together the Carboniferous slates and the crystalline schists. But, in the first place, the fragments in the conglomerate are not only gneisses and schists, but also ordinary slaty rocks, no more altered than those of Llanberis. How, we may well ask, could the latter escape unchanged when all the surrounding matrix was converted into mica schist? Further, when we apply the test of the microscope—that Ithuriel spear by which the deceptions of rocks are so often revealed—we find that this seeming mica schist is only the consolidated debris of micaceous rocks. Its composition, and that of the conglomerate, justifies us in asserting that when the Carboniferous rocks of the Valorsine were deposited there were land surfaces of gneiss and schist in the western region of the Alps, and that these rocks were substantially identical with those through which the Trient has seen its ravine.

It would be easy to multiply instances similar to one or the other of those quoted above for this or that district of the Alpine region, from the south of Monte Viso to the north of the Adriatic, to speak only of those districts of which I have a personal knowledge; but I should speedily weary you, and will ask you to regard these as typical cases, single samples of a great collection. They justify, as I think you will agree, the following inferences:—(1) That there has been one epoch, at least, of mountain-making posterior to the deposition of the Miocene nagelfluë, which has given to many parts of the Alpine chain an uplift sometimes not less than a mile in vertical elevation; (2) that prior to this there was an earlier epoch of mountain-making, which affected all the rocks of older date, including at any rate a portion of middle Eocene age—for we find marine strata of this date crowning the summit of the Diablerets, now more than 10,000 feet above the sea, and bent back, as at the Rigi Scheideck, over the beds of the nagelfluë; (3) that there was a pre-Triassic land surface of great extent, largely composed of crystalline rocks, and that with this geological age commenced a long continuous period of depression, lasting into Tertiary times; (4) that a land surface of considerable extent existed at a yet earlier period, and that this in the Carboniferous age was watered by streams and clothed with vegetation—whether there were mountains then it is impossible to say, but the evidence certainly points to the conclusion that the ground was hilly; (5) that anterior to the last-named period there is a great gap in our records; the older rocks, whose stratigraphical position can be ascertained, being much metamorphosed, so that we appear justified in concluding that all the more important mineral changes which they had undergone occurred in pre-Carboniferous times—that is, that the later Palæozoic land surfaces consisted of gneiss and schists in all important respects identical with those which now exist.

I have thus led you step by step—by processes, I trust, of cautious induction—to the result that the Alps, as an irregular land surface, are a very ancient feature in the contour of the earth, and that the gneisses and crystalline schists, whereof they so largely consist, are rocks of very great antiquity. Let us now attempt to advance a step further by attacking the problem from another side. Hitherto we have been working downwards from the newer to the older, from the rocks of known towards those of unknown date. Beginning now in the unknown, beginning with the most remote that we can find, let us proceed onwards toward the more recent and more recognised.

This is a task of no slight difficulty. The ordinary rules of stratigraphical inference frequently fail us; nay, if blindly followed, would lead us to the most erroneous conclusions. In the apparent succession of strata in a mountain range the last may be first and the first last in the literal sense of the words. Beds may be repeated again and again by great folds, now in the direct, now in the inverse, order of their superposition. They may have been faulted and then folded, or folded and then faulted, and the difficulty is augmented by the vast scale on which these earth movements have taken place, by the frequent impossibility of scaling the crags or pinnacles where critical sections are disclosed, and by the masking of large areas of surface by snow and glacier, or by debris and vegetation. Yet more, the consciousness of these difficulties produces in the mind—I speak for myself—a sort of hesitation and scepticism, which are most unfavourable for inductive reasoning. Knowing not what features are of importance, one is perplexed by the variety of facts that seem to call for notice; knowing how easily

one may be deceived, one hesitates to draw conclusions. I am often painfully conscious of how much I have lost in a previous journey from not having remarked some fact to which a fortunate accident has just compelled my attention. In this part, therefore, I must be pardoned if I speak with considerable hesitation and do not attempt more than state those inferences which seem to me warranted by facts.

I shall again ask permission to conduct you to a series of typical sections, which, however, I shall describe with less minuteness.

Let us place ourselves in imagination on the great ice-field at the upper part of the Gross Aletsch Glacier—the Place de la Concorde of Nature, as it has been happily termed. We are almost hemmed in by some of the loftiest peaks of the Bernese Oberland: the Aletschhorn, the Jungfrau, the Mönch, and several others. We find the rocks which rise immediately round the glacier—as, for example, near the well-known Concordia hut—to be coarse gneisses, with difficulty distinguishable from granites. As the eye travels up to any one of the mountain ridges, the rock evidently becomes less massive and more distinctly foliated. We note the same sequence as we retrace our steps towards the Rhone valley—speaking in general terms, the ridges and the flanks of the Eggischhorn consist of more finely granulated gneisses and of strong micaceous schists, which alternate more frequently one with another. Further to the west, in the region around the Oberaletsch Glacier and on the slopes of the Bell Alp, we find the same succession—coarse granitoid gneisses in the relatively lower part of the heart of the chain, finer grained and more variable gneisses and schists on the upper ridges and the southern flanks.

Let us change our position to a spot considerably to the east, to the great section of the crystalline series made by the valley of the Reuss below Andermatt.

From the spot where the rocks close in suddenly upon the torrent near the Devil's Bridge, to a considerable distance below Wasen, extends an almost unbroken mass of coarse granitoid gneiss. This, however, becomes more distinctly bedded and schistose before it entirely disappears beneath the Secondary deposits that border the Bay of Uri. Similarly, if from Wasen, where the gneiss is barely distinguishable from granite, we ascend the wild glen which leads up to the Susten Pass, and descend on the other side by the grand scenery of the Stein Alp to the beautiful Gadmenthal, thus passing obliquely outwards along the apparent strike of the rocks to the point where, as in the neighbourhood of the Imhof, they disappear beneath Mesozoic deposits, we again find that we are among rocks which are rather more variable in their mineral character, oscillating between moderately coarse gneisses, sometimes porphyritic, and strong mica schists. Near Muhlestalden, in the Gadmenthal, even a bed of white crystalline dolomitic limestone is interstratified with the gneissic rocks.

Leaving for a brief space the vicinity of the St. Gothard road, and returning to the upper valley of the Rhone, let us place ourselves on such an outlook as we can obtain from Prof. Tyndall's chalet on the Bell Alp, and fix our eyes on the magnificent panorama of the Pennine chain, with whose geology we will suppose ourselves to have become familiar in frequent traverses from the northern to the southern side of the watershed of Central Europe. Facing us, and forming the lower slopes and crags of the great mountain chain of the Pennines, we see an enormous mass of distinctly bedded rock, of a brownish tint, of which at this distance we should hesitate to say whether we ought to regard it as a member of the metamorphic or of the ordinary sedimentary series. In an east-north-east direction we see it gradually rising to form the peak of the Ofenhorn and the upper part of the mountains about the Gries Pass. In the opposite direction it forms the lower slopes of the Simplon Pass and the portals of the valley of the Visp. Hence, could we follow it, the area occupied by this rock broadens out into the spurs which inclose the Einfischthal and the Eringerthal, and crosses the watershed towards the south to the east of the St. Bernard Pass. In more than one locality in the region of the Binnenthal a band, of no great vertical thickness, of a white crystalline dolomite is conspicuously present. A very similar group of rocks occurs in the Val Piora, in some bands of which black garnets are very abundant. The same mineral also occurs in a similar rock near the summit of the Gries Pass. Andalusite or staurolite also occurs occasionally; the group, in short, is well characterised, and for reference I will call it the Lustrous Schists.

I pass now to the neighbourhood of the St. Gothard. The coarse gneiss, which is pierced by the northern entrance of the great tunnel, ends abruptly at the Urnerloch. The basin of the Urnerenthal is excavated from satiny slates, with dark limestones, very possibly of Jurassic age, and from some underlying rather variable schists. The first rock visible on the eastern side as we approach Andermatt is a schistose crystalline limestone, associated with mica schists; and a series of rather variable schists, evidently very different from the coarse gneisses of the gorge below, appears to cross the valley, and form the slopes leading to the Oberalp Pass. These may be traced for some distance up the Furka road above Realp, when they are abruptly succeeded by the slaty group mentioned above. I am convinced that they are much more ancient than the latter, being probably members of the Lustrous Schist group, if not older. It is obvious that the newer rocks are only a fragment of a loop of a huge fold, over which on either hand the fragments of the enveloping older metamorphic rocks tower up in mountain peaks. On the ascent of the St. Gothard Pass from Hospenthal a series of somewhat variable micaceous schists continues till the top of the first step in the ascent is reached, about 800 feet above the valley, when gneiss sets in, generally rather coarse and sometimes very porphyritic, occasionally interbanded with dark, rather friable mica schists. The upper plateau of the pass consists of a porphyritic rock, often called granite, but with a gneissose aspect and rather more friable in character than the rock of the Wasen district. On the first steep descent on the south side this rock appears to pass into a normal coarse gneiss, occasionally banded with mica schist, resembling that in a similar position on the northern flank, which is succeeded for a short space by a remarkably well-banded gneiss. To this succeeds—it must be remembered that the series is inverted in order—the great group of hornblende and garnetiferous mica schists, which continue along the Val Tremola and the lower slopes of the mountain to the neighbourhood of Airole, where some calcareous rock occurs, being probably an infold of much later date.

Through the kindness of Mr. Fletcher and Mr. Davis, of the British Museum, I have been allowed to examine the series of specimens from the St. Gothard Tunnel in that collection. They correspond in general with the succession above indicated, except that I have failed to identify the granitoid rock of the summit plateau. Leaving, however, for a moment the question of correlation, we see that the St. Gothard section presents us with an instance of folding on a gigantic scale, and of the fan structure, doubtless with many minor flexures and faults.

In the neighbourhood of the Val Piora we get an important succession. The ascent to the hotel from the Val Bedretto passes in the main over a series of micaceous schists and rather friable gneisses, which are a prolongation of an axis exposed in the mountains south of Airole and fairly correspond with much of the rock (excepting the granitoid) forming the upper part of the St. Gothard Pass. To this succeeds a series which, though more calcareous, clearly represents the garnetiferous actinolitic series of the southern slopes, and to this a group closely resembling the Lustrous Schists.

(To be continued.)

### UNIVERSITY AND EDUCATIONAL INTELLIGENCE

CAMBRIDGE.—The Electors to the Professorship of Pathology will meet for the purpose of electing a Professor on May 24. The stipend of the Professor is 800*l.* a year, exclusive of fees, but he must not engage in the private practice of Medicine or Surgery.

Prof. Macalister lectures to-day on the Race Types of the Human Skull; on Saturday, on the Race Variations of the Skin, Hair, and Soft Parts; and on Tuesday, the 13th, on the Anatomical Characters of the Prehistoric and Early Historic Races of Britain: on each day at 1 p.m.

In the Long Vacation Prof. Macalister will take a Class in Osteology, and the Demonstrator will have a class for Practical Histology.

The new buildings for Prof. Stuart's Museum of Mechanism will be ready to receive their contents this term, and it is recommended that the buildings to provide for the Department of Botany be at once proceeded with, to be ready for use at the beginning of October.

### SOCIETIES AND ACADEMIES

LONDON

**Royal Society, May 1.**—"On the Connection of the Himalaya Snowfall with Dry Winds and Seasons of Drought in India." By Henry F. Blanford, F.R.S.

In this paper the author points out that for some years past it has been suspected that the snowfall of the Himalaya has a direct influence on the dry land winds of North-Western India. The connection of the two was first noticed in 1876 and 1877, the first-named a year of drought and famine in Southern India, the second the same in the North-Western Provinces, Rajputana, and Central India. Messrs. Hill and Archibald, about the same time, called attention to the circumstance that excessive winter rainfall in Northern India is usually followed by defective rains in the summer or monsoon season. This inference is strengthened if the rainfall of May be included in that of the winter and spring instead of in that of the summer, as is shown by a table for the eighteen years from 1864 to 1881 inclusive. Fourteen of these years give results agreeing with Messrs. Hill and Archibald's views, and only four differ from their conclusions: two out of these four, viz. 1876 and 1880, being found on further investigation distinctly to confirm the theory, whilst data are wanting with regard to the other two years.

After some details concerning the meteorology of the area in the years 1881-82, the writer gives a description of the unusual snowfall on the outer ranges of the Himalaya in the spring of 1883, and of the extensive drought in Northern, North-Western, and part of Central India that followed. In this instance a warning forecast of dry weather and retarded rainfall was published in the *Gazette of India* on June 2, and this forecast is shown to have been justified by the event, the rainfall in July and August over large portions of India having been much below the average.

In an account of the meteorology of the land winds it is shown that from November to February they tend to circulate anticyclonically round the axis of maximum pressure, extending from the Punjab and Sind across Rajputana and Central India towards Orissa. In March a barometric minimum is established over the Hyderabad plateau, and this extends to the north and north-east, the wind currents becoming cyclonic around the depression. To the eastward of this area some rain falls in the spring, but Western India from Belgaum to the Punjab is practically rainless from November till May, and is the dry wind area. It is then shown that the supply of air for the dry wind is derived from an upper stratum by convective interchange. After rain and snow on the Himalayas the dry winds are supplemented by an outflow of cold air from the hills accompanied by a wave of high pressure advancing eastward from the valley of the Indus.

The following summary and conclusions are given:—

(1.) The experience of recent years affords many instances of an unusually heavy and especially a late fall of snow on the North-Western Himalaya being followed by a prolonged period of drought on the plains of North-Western and Western India.

(2.) On tabulating the average rainfall of the winter and spring months at the stations of the North-Western Himalaya, year by year, for the last eighteen years, and comparing it with the average rainfall of the North-Western Provinces in the ensuing summer monsoon, it is found that with four exceptions an excessive winter precipitation on the hills is followed by a deficient summer rainfall on the plains, and *vice versa*. Of the four apparent exceptions, two are found to afford a striking support to the first proposition.

(3.) The west winds which, in Western and Northern India, are characteristic of seasons of drought as abnormal winds, are identical in character with the normal winds of the dry season, and appear to be fed by descending currents from the North-Western Himalaya, and possibly the western mountains generally.

(4.) It is a common and well-known phenomenon of the winter months that a fall of rain and snow on the North-Western Himalaya is immediately followed by a wave of high pressure advancing eastwards from the western mountains, accompanied with dry cool north-west winds.

(5.) The conclusion is that an unusual expanse of snow on the North-Western Himalaya, whether due to the unmelted residue of an unusually copious winter snowfall, or to an unusually late fall in the spring months, acts, at high levels, in the summer months, in somewhat the same way as the ordinary falls of snow and rain on the Lower Himalaya do at low levels in the winter

season, and favour the production of dry north-west winds on the plains of Western India.

(6.) That this dependence of dry winds on the Himalayan snowfall affords a criterion for forecasting the probabilities of drought in North-Western and Western India.

In setting forth the above conclusions, it is, however, necessary not to ignore the fact that there are other conditions besides those here considered which exercise a very great influence on the prevalence of dry winds and drought. During the last famine period in India (the years 1876 and 1877; in the former year in Southern India, in the latter in the North-Western Provinces and Rajputana), the pressure of the atmosphere was persistently and abnormally high, and this was due, as I showed in the reports on the meteorology of those years, to the condition, probably the high density, of the higher atmospheric strata. Moreover, this excessive pressure was shown to affect so extensive a region that it would be unreasonable to attribute it to the condition of any tract so limited as a portion of the Himalayan chain; and if dependent on the thermal conditions of the surface, which may indeed have been the case, this land must rather have been the major portion of the Asiatic continent than merely a relatively small portion of its mountain axis. This question must remain for future inquiry. It is referred to here to guard against too wide an application being assigned to the action of the Himalayan snows.

**Physical Society, April 26.**—Dr. Guthrie, president, in the chair.—New Members: Mr. Chattock, Mr. Inwards.—Prof. Perry and Ayrton read a paper on the indicator diagram of a gas-engine, which was intended to teach practical engineers a new method of studying gas-engine diagrams. The most recent results obtained by the use of Dowson gas were stated, and it was suggested that before long gas-engines will be employed for the propulsion of ships. A large wooden model of an Otto gas-engine enabled the operations going on during a cycle of the engine to be understood. Tables were given of the constituents of coal-gas and Dowson gas, the air required for combustion, the heat of combustion, and the specific heats, to enable the characteristic equation of the fluid used in the gas-engine to be determined. An easy method of obtaining one empirical formula to represent all the diagrams which can be obtained from an engine with different quantities of gas was described and its results compared with observation. The effects of vibration of the indicator spring in the various parts of the diagram were discussed, as well as the effect of the last explosion, which are provided for in the empirical formula. Three practical methods of determining the rate,  $q$ , of gain of heat by the fluid during the forward stroke were given, and a diagram was shown in which this rate could everywhere be compared with the rate of doing work. If  $W$  is the indicated work in one cycle, it was shown that  $5.64 W$  is the total energy of combustion of one charge, and this is expended as follows:— $1.45 W$  is the work done in the forward stroke,  $2.22 W$  is given to the cylinder by radiation in the forward stroke,  $1.5 W$  is carried off through the exhaust-pipe,  $0.47 W$  is given to the cylinder as heat after exhaust-valve opens. The rate at which the loss,  $2.22 W$ , by radiation occurs at every point of the forward stroke was shown on a diagram obtained from a knowledge of the temperature at every point in the stroke, and when the ordinates of this diagram were added to the  $q$  diagram previously described, a diagram was obtained showing at every point of the stroke the rate at which combustion was going on. This diagram was specially important as showing the effect of dissociation in the gas-engine.—Dr. W. H. Stone exhibited a simple form of siphon mercurial barometer with metrical scale. Two millimetre scales are adjusted to slide easily side by side; the lower edge of one is brought on a level with the mercury in the shorter limb, and the other slid up and down until its lower edge coincides with the upper mercury surface. The adjustment is easily effected by an observer without stooping by the use of two right-angled glass prisms fitting on the upper and lower ends of a vertical glass tube.—The next meeting of the Society, on May 10, will be held in the Mason College, Birmingham.

**Anthropological Institute, April 22.**—Prof. Flower, F.R.S., president, in the chair.—The President, in welcoming the Members to their new quarters, gave an outline of the history of the Society and of the eminent men who have presided over it during the forty years of its existence. The Ethnological Society, founded in 1843, and the Anthropological Society twenty years later, were united in 1871 under the title, "The Anthropological Institute of Great Britain and Ireland."—The Marquis of

Lorne sent to express his regret at his inability to attend; he exhibited a large collection of North American objects, including a scalp taken last summer.—Sir Richard Owen communicated a paper on a portrait of an aboriginal Tasmanian. The paper was further illustrated by two busts and several portraits belonging to the Institute.—Prof. Keane then read a paper on the ethnology of the Egyptian Soudan, which was described as a region of extreme complexity, a converging point of all the great races of the African Continent, except the Hottentot and Bushman. Although official documents such as Col. Stewart's "Report on the Soudan" for 1883, recognised only "two main divisions, Arab and Negro," it was shown that here was represented the Hamites, Semites, Nubians, Negroes, and Bantus. Of the Hamites, the chief branches were the Tibbu in Darfur, and the Ethiopians stretching east of the Nile without interruption from Egypt to the Equator, and including the Galla and Somali south of Abyssinia, various tribes between Abyssinia and the coast, and the Bejas, who occupied the greater part of the Nubian Desert between Abyssinia and Egypt. The Bejas, whose very existence was ignored by our officials, and who were universally confounded by newspaper correspondents with the Arabs, were the true aboriginal element in the country between Berber and Suakim, where they recently came into collision with the British forces.

**Royal Microscopical Society, April 9.**—The Rev. W. H. Dallinger, F.R.S., president, in the chair.—On the motion of the President a vote of condolence with the R. Accademia dei Lincei on the death of their president, Quintino Sella (an *ex-officio* Fellow of the Society) was passed.—Dr. Carpenter, C.B., explained in detail his reasons for considering that binocular vision in the microscope took place on the same principles as in the case of ordinary vision, and combated Prof. Abbe's view to the contrary. A number of photographs, diagrams, and models were exhibited in illustration. Mr. Crisp gave his reasons for considering that Prof. Abbe was right. In ordinary vision we had a perspective shortening of parts of the object, but under the microscope this did not occur. In ordinary vision a lined object would show the lines closer together when viewed obliquely, whilst under the microscope the lines appeared the same distance apart whether they were viewed by the central or oblique pencils.—Mr. Bolton exhibited the interesting Rhizopod, *Clathrusula elegans*, from Epping Forest, which had been found to exhibit a fourth mode of reproduction by the formation of flagellate monads.—Mr. Guimaraens described a true *Xanthidium* from Halifax coal strata.—Mr. Badcock read a note on certain filaments which he had observed protruding from *Spirivella bifrons*.—Mr. Nelson explained the method which he had found most suitable for examining certain bacteria.—The President announced that the next meeting would be made special, to consider the question of the admission of ladies as members of the Society.

#### PARIS

**Academy of Sciences, April 28.**—M. Rolland in the chair.—Observations extracted from M. Verbeek's report on the Krakatoa eruption of August 26, 27, and 28, 1883, by M. Daubrée.—Note on the problem to determine the degree of all algebraic surfaces which may be osculatory with another surface, by M. de Jonquières.—On an extension of the law of Harriot relating to algebraic equations, by Prof. Sylvester.—Memoir on the conservation of stellar energies, and on the variation of terrestrial temperatures, with a table showing the probable succession of the approximate dates of maximum and minimum intensity of solar radiation, by M. Duponchel.—On the absolute standard of light, by M. J. Violle. In this paper the author develops the idea already formulated by him at the International Congress of Electricians in 1881, the essential object of which was to verify the principle of the method, which consists in taking as a standard of light a metal at its point of fusion. He now finds that platinum best fulfils the conditions required of an absolute standard of light. It rests on a perfectly defined and constant physical phenomenon, and constitutes a practical term of comparison with ordinary standards.—Results of a series of experiments undertaken to determine the dimensions of the column of mercury at zero which represents the unity of practical resistance, or the value of the ohm, by MM. E. Mascart, F. de Neville, and R. Benoit.—Note on the application of the laws of induction to the helio-electric theory of the perturbations of terrestrial magnetism, by M. Quet. From his own observations, as well as those of Carrington, Armstrong, and others, the author infers a definite relation between



the sunspots and terrestrial magnetic disturbances.—On the apparent resistance of the voltaic arc usually employed in light-houses, by M. F. Lucas.—Some results of repeated experiments conducted at the School of Telegraphy on telluric electric currents, by M. E. E. Blavier.—Description of a method for directly determining the cause of the deficit in dynamo-electric machines, by M. G. Cabanellas.—On the freezing point of the salts of biatomic metals, by M. F. M. Raoult. This paper is accompanied by tables of results for a large number of biatomic metals.—On the formation of amides in separating sal ammoniacs from organic acids, by M. N. Menschutkin.—On a glucoside yielded by the Boldo (*Boldoa fragrans*), by M. P. Chapoteaut.—Researches on water-tight substances; influence of baking and carbonic acid on the induration of siliceous cements, by M. Ed. Landrin.—On the presence of manganese in wines and a large number of other vegetable and animal products, by M. E. J. Maumené. An appreciable proportion of manganese was found in thirty-four wines tested by the author, who infers that it exists in all wines, as well as in wheat, rye, and many other substances.—Note on the assimilating properties of the phosphoric acid contained in rocks and in arable lands, by M. G. Lechartier.—Experimental method of determining the physiological combustibility of various substances, with tabulated results, by M. Schützenberger.—Researches on the respiration of plants in the dark, by MM. G. Bonnier and L. Mangin.—Further remarks on the zeolites associated with the dolerites of the Chaux-de-Bergonne district, Puy-de-Dôme, by M. F. Gonnard.—Special distribution and localisation of the motor roots in the lumbo-sacral plexus, by MM. Forgue and Lannegrace.—Geological section of the shaft sunk to a depth of 502.50 metres at Montrond, Loire, presented by M. Laur. At this depth a sheet of mineral water was reached, accompanied by much carbonic acid, which was ejected to a height of 35 metres above the surface.

## BERLIN

**Physiological Society, March 28.**—Dr. Cohnstein communicated observations he had made on rabbits and dogs regarding the nature of the blood of fœtuses and new-born animals. He first counted the number of blood-corpuscles in a cubic millimetre of blood, and found that throughout the whole course of the fœtal intra-uterine state they increased progressively with the age of the embryo, but yet never attained to the number present in the mother's blood. After birth, however, the relative numbers of the two were reversed. The number of blood-corpuscles in the blood of the young one exceeded that in the blood of the mother. The blood of the new-born animal was accordingly thicker than that both of the fœtus and of the mother. Dr. Cohnstein measured the total blood mass in the unborn and new-born young according to a method he communicated in greater detail; and though the results he obtained were very variable, he never found the same relative differences therein as applied to the quantity of blood-corpuscles. The proportion of hæmoglobin of the embryo blood was precisely calculated, and on the whole showed the same variations as the number of blood-cells; yet the increase of hæmoglobin after birth was not so great as that of the number of blood-corpuscles.—In connection with the foregoing statements of Dr. Cohnstein, Prof. Zuntz brought forward his experiments on the subject of the mechanics of the blood-circulation in unborn animals, after describing at full length the apparatus and methods he had employed in this investigation. The results of his observations, carried out mostly on the umbilical vessels, were as follows:—The blood-pressure in the navel artery amounted on an average to about 40 mm. mercury; in the navel vein it showed considerable variations, limited, however, to between 16 and 30 mm. mercury; values very considerably surpassing the normal pressure in the *vena cava inferior* in the case of the full-grown, but which were very simply explained by the fact that the blood in the placenta suffered only very slight resistance. The rate of movement of the blood was considerably less in the fœtus than in the mother. Especially interesting were the results of the analyses of the blood gases, performed in accordance with methods indicated in the address. It was first shown that the blood of the unborn, when kept for some time in a closed vessel, had its proportion of oxygen very quickly reduced, that is to say, the consumption of oxygen on the part of the fœtal blood was very copious and considerably greater than after birth or in the case of the full-grown. This fact was shown by the very appearance of the blood, the bright red blood taken from the navel artery turning dark very rapidly. The proportion of carbonic acid in the blood in the navel artery was about

4½ per cent. higher than in the navel vein, while in the case of the full-grown the difference between arterial and venous blood amounted on an average, as was well known, to 9 per cent. The proportion of oxygen in the fœtal blood was very changing. In the navel artery it averaged about 4 per cent. less than in the navel vein; but even in this latter case the blood was by no means saturated with oxygen. From the gaseous contents of the blood and its circulation an interesting glance was thus obtained into the respiratory process of the unborn.—Dr. Kossel announced that he had succeeded in demonstrating the presence of peptonous bodies in tissue. If the granule-holding blood-cells of birds were treated with water, there remained a loose, flaky mass which shrunk together on the application of hydrochloric acid; the main constituent of the flaky mass was nuclein, and by the acid another substance was freed, which on analysis proved to be a peptonous substance. The circumstance that this peptonous body, which was soluble in water, was not extracted on the first treatment with water, showed that in the blood-corpuscles it was chemically combined with nuclein. A remarkable property was displayed by this peptonous body when treated with ammonia; it became precipitated as coagulable albumen. Such a transformation of a peptone into coagulable albumen was hitherto known only as an effect of high temperature. That it could be effected in such a simple manner Dr. Kossel regarded as a confirmation of his view that peptone was distinguished from albumen by a higher proportion of water.—Herr Aronsohn spoke of his experiments with a view to electric irritation of the olfactory nerves. The nose having been filled with a very weak warm solution of common salt, one electrode, a platinum wire inside a glass tube, was brought close to the olfactory nerve, and the other was directed to the hand or the neck. A constant current of the strength of .0001 ampere now excited in each case, according to its direction, either on opening or on closing, a quite decided sensation of smell which could be compared with no known scent, not even with that of phosphor or ozone. Now and again, too, a sense of taste was excited at the same time. The direction of the current had no influence on the quality of the olfactory sensation. The appearance of the irritation on closing or opening the constant current corresponded completely with Pfüger's law of spasms (*Zuckungsgesetz*).

## CONTENTS

	PAGE
A Plea for a National Marine Zoological Survey . . . . .	25
The Electrical Congress of Paris, 1884 . . . . .	26
Dr. Joule's Scientific Papers . . . . .	27
Letters to the Editor:—	
Long or Short Fractions for Great Natural and National Standards—Earth's Axis of Rotation.—Prof. C. Piazz-Smyth . . . . .	29
The Ancestor of the Dipper ( <i>Cinclus</i> ).—Dr. Chas. C. Abbott . . . . .	30
Double-storied Houses and Concave Roofs.—B. D. Oldham . . . . .	30
The Recent Earthquake.—C. E. De Rance; Dr. J. E. Taylor; Edward Newton; Rev. Frederick W. Ragg . . . . .	31
Black Rain.—Rev. S. J. Perry, F.R.S. . . . .	32
The Remarkable Sunsets.—L. G. Carpenter; J. L. Bozward . . . . .	32
Rotating Thermometers.—Edwin Clark . . . . .	32
Science and the Public Service.—F. C. S. . . . .	33
The Royal Corps of Naval Constructors. By W. H. White . . . . .	33
The Flora of Patagonia . . . . .	35
Across the Pampas and Among the Andes ( <i>Illustrated</i> ) . . . . .	36
The International Health and Education Exhibition . . . . .	39
Notes . . . . .	39
Our Astronomical Column:—	
White Spots upon Venus . . . . .	41
The Great Comet of 1882 . . . . .	42
Brorsen's Comet of Short Period . . . . .	42
The Iron and Steel Institute . . . . .	42
The Building of the Alps. By Prof. T. G. Bonney, F.R.S., Pres. G.S. . . . .	44
University and Educational Intelligence . . . . .	46
Societies and Academies . . . . .	46

THURSDAY, MAY 15, 1884

## DANIELL'S "PHYSICS"

*Text-Book of the Principles of Physics.* By Alfred Daniell, M.A., Lecturer on Physics in the School of Medicine, Edinburgh. (London: Macmillan and Co., 1884.)

AN important and welcome addition to the existing text-books of elementary physics has appeared. Since the days when Arnott's and Golding-Bird's manuals were in vogue, the number of text-books of physics which have appeared in this country is very small as compared with the vast number of excellent manuals or students which have been produced in Germany and France. Many of these are unique. Verdet's "Cours de Physique" stands alone; nothing like it has ever been produced in England. The text-book of Jamin and Bouty, now much enlarged, is also unique, and of semi-mathematical text-books is by far the best, though limited by the curious restriction that seems to cramp all French science,—ignorance of all scientific work that is done outside France. Jamin's smaller *petit traité*, though admirable, is too concise. Daguin's text-book is overloaded: those of Fernet, and of Boutan and D'Almeida unequal in balance, and too obviously cut to suit the narrow requirements of the *baccalauréat*. The same remark applies less strongly to Ganot's excellent "Physique." Those of Moutier and Violle are yet incomplete. In Germany, Müller-Pouillet's "Lehrbuch," recently overhauled and enlarged by Prof. Pfaundler of Innsprück, is a grand and substantial work for students. If it lacks the elegance of Jamin and Bouty, it makes up in solidity and catholicity of information. Its wealth of pictorial illustration is unapproached. Wüllner's "Lehrbuch" is heavy, and his "Compendium" is not what students want. Mousson's "Lehrbuch," now greatly enlarged, is valuable as a work of reference, but might with benefit be pruned. In addition to these we might name hosts of others by Viktor von Lang, Jochmann, von Waltenhofen, Eisenlohr, Koppe, Emmsman, R. Waeber, Hessler-Pisko, Paul Reis, Krebs, Crüger, Sumpff, and others. Against this array what can be shown in Great Britain? The English translation of Ganot by Dr. Atkinson has long held sway; its indefatigable editor has long ago filled up the gaps of the original French work; but it has grown almost encyclopædic, and has never quite freed itself from Ganot's academically conservative way of treating physical problems. The lesser elementary Ganot is also excellent in its way,—as a purely introductory book. Besides the translated Ganot we have also the translated Deschanel; a work which, thanks to Prof. Everett, is vastly superior to the original French work, and has proved of great value as a text-book, by reason of the excellent cuts and the valuable mathematical editorial notes. Dr. Everett's lesser "Physics" is also good as a purely introductory work. In addition to these we may mention, though adapted for popular instruction rather than for students' reading, the two volumes of Guillemin on the "Forces of Nature," edited by Mr. J. Norman Lockyer, which have done good work in their way. So far, not a

VOL. XXX.—NO. 759

single really English text-book! But, stop; there is one genuinely British and of very original merit, Prof. Balfour Stewart's "Elementary Lessons in Physics." This comparatively small volume may be cited as the first conscientious attempt to rewrite "Physics" from the modern standpoint, namely, on the basis of the doctrine of energy. In this respect it is infinitely ahead of the more ambitious adaptations from French authors, and will probably long keep its place as a text-book for elementary work. We do not forget Galbraith and Haughton's manuals, excellent—and sketchy—as they are; nor the re-edited Lardner volumes, which, in spite of the abilities of Messrs. Carey Foster and Lœwy, are very decidedly of the *réchauffé* order, and should be allowed an honourable burial. There are also C. Bird's handy "Notes," and a volume by Dr. Aveling, of which, the less said the better. This strange poverty in modern text-books would be indeed remarkable were it not that it is more than compensated by the great abundance of splendid text-books on isolated branches of physics which have issued from the press of Great Britain during the past decade. Individual treatises on mechanics, optics, electricity, sound, and heat have to a considerable extent supplanted more general treatises on physics, with great advantage, in the long run, to the solidity of the reader's information. Nevertheless the text-book of physics has its place and its readers. Men who are reading for mathematics, for medicine, or for the army still require in many cases a something more than superficial acquaintance with physics. It is they who buy the Ganots, the Deschanel, and the Balfour Stewarts, and find them more or less adapted to their needs.

Mr. Daniell's new "Text-book of Physics" is addressed to such students as these, and more particularly to those who read physics as a part of their preparation for a medical degree. But there is abundant matter in it for the engineer and the chemist to consider. The work opens with two chapters on the fundamental notions of mass, time, and space, and on the derived kinematical and kinetical quantities. The third chapter deals with measurements, and the fourth with work and energy. All this is only introductory, and occupies but 50 pages. The remaining 570 pages are therefore based upon the doctrine of energy. The chapter on Kinematics which follows is lengthy but admirable. Harmonic motion, and problems connected with the propagation of waves, are expounded with great care. The teaching here, as throughout, bears the impress of the two great living Scotch physicists whom Mr. Daniell names as his masters. The chapter on Kinetics is none the less welcome because the author frankly gives up the misleading term, "centrifugal force." It strikes us that more might have been said with advantage concerning angular motion and the problems relating to couples. A very useful chapter on Attraction and Potential is then introduced: a most sensible step, since too often the notion of a potential function is postponed until the student comes upon it quite unprepared in electrostatics. It may be noticed that a similar course is adopted in the text-book of Jamin and Bouty. Gravitation and the pendulum conclude the kinetic section of the work, which next deals with the properties of matter. In this chapter, which must be extremely interesting to those

D

who approach the subject freshly, modern ideas come to the front. The question of viscosity of solids and liquids comes prominently forward. The views of Crookes on the "radiant" condition of highly attenuated gases are discussed, and so is also the connection between the liquid and gaseous states. With respect to the alleged continuity between these states, the author does not seem to have quite made up his mind; for though he quotes with approval the proof given by Ramsay, that the so-called critical point is not necessarily a phenomenon of continuity at all, but simply a certain condition of things in which the liquid and its vapour mix, because they have arrived at equal density and cannot keep separate, he seems also to lean to the other view, apparently relying on an unconfirmed observation by Hannay on the solubility of a solid in a gas. The vortex theory of atoms and the existence of the ether are mentioned in this chapter. There is a capital section on elasticity, and another on liquids, in which the molecular phenomena of liquid cohesion and surface-tension are given due weight, as are also sundry matters concerning the kinetics of liquids, often omitted from such text-books. A short chapter on Gases is introduced, and then follows one on Heat. Just fifty-one pages are given to this entire subject; but in those fifty-one pages an enormous amount of useful matter is comprised. There is not a superfluous line or even word. This extraordinary success—for the thing is most successfully done—is largely due to the author's fundamental method of starting from the energy doctrine. The chapter on Heat opens with the first law of thermodynamics, and states it thus: "Heat, being a form of energy, can be measured in ergs." The rest of the subject is developed in a masterly way; though probably the student who has read nothing previously in this branch will find it tough. The paragraph on "the six thermal capacities" is very suggestive, and needs clear thinking to follow it. The author adheres, not quite wisely, we think, to the practice of taking as the definition of the calorie or heat-unit, the kilogramme-water-degree unit instead of the gramme-water-degree unit. This is the only case in which the author does not accept the C.G.S. system. Is there any adequate reason why he should not follow the more modern custom and adopt the *calorie mineure* instead of the *calorie majeure*? The chapter on Sound is also well written; and, for the first time, so far as we are aware, we have the notation of the tonic sol-fa system introduced along with staff notation into the discussions of pitch and temperament.

The chapter which succeeds is enough to take away one's breath. Were this a text-book of the stereotyped academic style, one would know exactly what to expect. After Sound, Light: a chat on the velocity of light; the old familiar gray-headed problems of reflection and refraction; a glance at the rainbow and at telescopes and microscopes; and, to wind up, a couple of pages on the spectrum—with the inevitable chromolithographed chart—and two more on polarisation. But this is not the method of our author. He heads his chapter, "Ether-Waves," and after a little preliminary clearing away he launches into radiation and introduces notions on wavelength, heating effects, colour, and on *exchange* of radiations. Prevost's law and Stokes' law lead direct to the analysis of radiations in the spectrum, and to the evi-

dence afforded in the spectrum of the phenomena of transmission, reflection, and absorption. The propagation of waves through the ether next comes up, involving the questions of plane and circular polarisation, and then, after all this,—shades of the immortal Potter and of the revered Todhunter!—come reflection and refraction of light, mirrors, prisms, and lenses! This is indeed a *bouleversement* of the time-honoured custom of giving all attention to geometrical optics, leaving physical optics to take its chance at the fag end. Yet we are persuaded that the method is essentially right. It is to be regretted, however, that the author does not, with all his improvements, adopt Gauss's treatment of lens problems. Perhaps this is solely for want of space; the sin, if it be one, is one of omission only. Separate sections on interference, double refraction, optical instruments, and rotatory polarisation are given. The instruments are briefly but satisfactorily discussed; the ophthalmoscope and stereoscope receiving due attention. The last and longest chapter in the book is devoted to Electricity and Magnetism. This chapter, though abounding in good points, is to our mind the least successful of the whole; it will not satisfy electricians, though it may, and will, give to medical students a very good and thorough insight into the phenomena and laws of electricity. A very useful bibliography of works on physics for further reading closes the book.

One further point strikes us in reviewing the book as a whole—the excellence of the examples chosen to illustrate the problems and remarks. Particularly to medical students will this feature recommend itself. Levers and moments of forces are illustrated at p. 151 by a long list of articulations in the human skeleton. The references on p. 154 to the action of the biceps and deltoid muscles, on p. 138 to Rosapeky's researches, on p. 143 to anæmic disorders, on pp. 252-55 to the relations of the physical processes of osmose and diffusion to the tissues of the body in relation to juices, foods, alkaloids, and to serpent-poisons, will be recognised as giving a distinctive character to the work.

Such criticisms as it remains for us to pass are directed solely to a few points in which the author will do well to modify the work when it shall attain—as it doubtless will—to a second issue. In the section on the rainbow the secondary and tertiary, &c., bows due to multiple internal reflection are apparently confused with the supernumerary bows due to interference. On p. 35 the "watt" is wrongly defined as a unit of work, and equal to  $10^7$  ergs, whereas it is not a unit of "work" at all, but a unit of "activity," and is equal to  $10^7$  ergs *per second*. The matter recurs on p. 575, but is not there much mended. The author uses the letters "E.M.D.P.," meaning thereby "electromotive difference of potential," for that which is more commonly denominated "electromotive force," and abbreviated into "E.M.F." We cannot think the change well advised. What would the author do if he came to discuss the formulæ of a dynamo, in which the induced electromotive force is a very different quantity from the difference of potential between the terminals? Would he write both "E.M.D.P."? Again, on p. 625, the author uses "utility" for the quantity commonly called the "efficiency" of an electric motor. This is in itself not *ps* a bad exchange of terms. But the author goes

to misapply the very same word and to use it in the sense of "activity," saying in effect that (by Jacobi's law) the "utility" is a maximum when the reaction of the motor reduces the supply-current to one-half. The diagram intended to represent Hall's experiment on p. 628 is quite wrong. The statement on p. 503 that the velocity of light is greater in metals than in air is incorrect: the refractive index is greater, therefore the velocity less. The author has most wisely abandoned the use of that most misleading of terms, vapour-tension, and substitutes therefor simply pressure. This is well; but the reform must go further, and should have gone further at the hands of so worthy a pupil of the Scottish school of physical precision. A reference to the index shows apparently that the author uses the word "pressure" correctly and consistently in the sense of force per unit area. If this were so, it would be excellent. Unfortunately the text of the treatise is not always consistent. On p. 152 the author talks of applying a "pressure" to a lever, where he does not mean so many dynes per square centimetre, but where he means simply a "force,"—a push. Of course this confusion of language is pardonable: it runs riot throughout every Cambridge text-book of mechanics from Todhunter to Garnett. We had hoped better things here. Again on p. 154 comes the following question:—"A nutcracker 6 inches long has a nut in it an inch from the hinge: the hand exerts a pressure of 4 lbs.: what is the stress on the hinge?" Answer: "The stress on the hinge is the weight of 24 lbs." In the first place the word "stress" is wholly misapplied; for a stress is not a force, but a force divided by the area on which it is applied: and in the second the word "pressure" is equally misapplied, because what is meant is that the hand applies a "force" equal to the weight of four pounds. In like manner the author's general precision of language would lead to the expectation that he would not misapply that unhappy word "tension." Referring to the index it appears that he uses the word tension in four different senses. He speaks of "surface-tension" of a liquid: which is excusable if the words are connected by an indissoluble hyphen. He speaks of voltaic cells being coupled in "tension," where he means united in series. He speaks (p. 522) of atmospheric pressure in an electrified soap-bubble being resisted by "an electric self-repulsion or *tension* over the surface" (as if self-repulsion were a pulling instead of a pushing force!); and lastly, he speaks of the "tension" of a string (p. 142) when he means the pull, not the stress of so many dynes per square centimetre. He is no worse, however, than the majority of writers on the subject. The average Cambridge text-book teems with similar instances, where problem after problem is set to "find the tension in a rope," without the necessary data as to area of cross-section in the rope being given. There is one book on physics, now happily almost extinct, in which the word tension is used in eight different significations!

Lastly, we must congratulate Mr. Daniell on having embodied the latest results of contemporary research in his work. The ordinary text-book is not seldom ten or fifteen years behind in its data, in some cases more. Here, however, we find, absorbed into the fibre of the book, the most recent matter, such as the researches of Lord Rayleigh on the unit of resistance, of Quincke and

of Worthington on capillary phenomena, of Guébard on electro-chemical figures, of Crookes on radiation and "radiant matter," of O. E. Meyer on viscosity, of A. M. Mayer on the analysis of sounds, of Rosenthal on animal heat, of Vierordt and of Chauveau on blood-pressure, of Wintrich on the use of resonators in auscultation, and of Abney and of Langley on dark radiation. A text-book so furnished forth is doubly welcome. S. P. T.

#### RECENT CHEMISTRY

*Experimental Proofs of Chemical Theory for Beginners.*

By Prof. Ramsay. (London: Macmillan, 1884.)

*The Discovery of the Periodic Law, and on Relations among the Atomic Weights.* By John A. R. Newlands. (London: Spon, 1884.)

*Chemical Analysis as applied to the Examination of Pharmaceutical Chemicals.* By Messrs. Hoffmann and Power. Third Edition. (London: Churchill, 1884.)

*Chemical Analysis, for Schools and Science Classes.* By A. H. Scott-White. (London: Laurie, 1884.)

*Facts Around Us.* By C. Lloyd Morgan. (London: Stanford, 1884.)

*Science of Food.* A Text-book specially adapted for those who are preparing for the Government Examinations in Domestic Economy. By L. M. C. (London: George Bell and Sons, 1884.)

*An Outline of Qualitative Analysis for Beginners.* By J. T. Stoddard. (Massachusetts, 1883.)

THERE is not the least doubt that in English laboratories theory does not occupy a prominent position. Prof. Ramsay is to be complimented on this very small book, which is certainly a valuable attempt to put chemical theory on a practical basis. It consists of a series of exercises on the measurement of temperature, pressure, and weight in connection with gases, &c., and contains very valuable directions and instructions in the manner of reading thermometers and barometers, and representing changes by curves, and also in the graduation of thermometers and other instruments in common use in the chemical laboratory, a work which should not be relegated entirely to a physical laboratory. The work is divided into twelve chapters, in all of which we have very excellent practical exercises on what is commonly known as chemical theories, that is, the sensity of gases, the law of Gay Lussac and Avogadro, on quantivalence, specific heat, and the equivalents of metals, and a short chapter summarising Newlands' work on the periodic law of the elements. We can strongly commend this little book to all students in chemical laboratories.

Mr. Newland's little book, as the author says in his preface, contains an exact reprint of all the papers on relations among the atomic weights and on the periodic law written by himself and printed in the *Chemical News* during the last twenty years. In its present form it is a desirable addition to our literature, and should bring Mr. Newlands' very valuable work into its proper position.

Messrs. Hoffmann and Power's very elegant work is evidently not adapted to an ordinary chemical laboratory. As the authors state, it has been prepared for the pharmacist and dispensing practitioner of medicine, for the purpose of enabling him to test chemicals and drugs used in pharmacy. The arrangement of the work is

therefore such as to suit the practical pharmacist rather than the analytical chemist. The substances are described under their several Latin synonyms, in addition to the French, German, English, and Spanish names. We find that each preparation is described as to physical and chemical properties, and then follows a very elaborate examination for the presence of impurities, in addition to methods of quantitative determination of the principal constituents. It should be a very useful addition to the pharmaceutical laboratory.

Mr. Scott-White's volume is one of the usual little books of chemical analysis tables. There seems to be nothing very remarkable about it, excepting the variety of types in which the formulæ are printed. The book, which is intended as a text-book for the various examinations of the University of London, Oxford and Cambridge Senior Locals, and the Kensington examinations, seems well adapted for its purpose. It contains a table of solubilities of common inorganic salts, which is a thing students rarely make use of; and an appendix of requirements in examinations, detailing apparatus, chemicals, &c., necessary for most of the elementary examinations in chemistry.

With all our science classes and the very general spread of scientific education throughout the country, it is still a sad fact that the great mass of the public and even of the middle-class educated public are wofully ignorant on common things. Even now it is somewhat out of place to talk in a drawing-room about oxygen: as to the mention of phosphorus or selenium, or metals like platinum or iridium, it is still more out of place. A great deal of this ignorance—ignorance possibly occasioned by dread—is doubtless caused by the very scientific science books that are in common use. We are almost entirely without books on general science that are sufficiently simple, and at the same time accurate, to convey a general but correct notion of ordinary substances, or to interest the ordinary reader in all these things around us. Why should not the properties of oxygen or phosphorus be quite as interesting reading as some of the three-volume novels? Mr. Lloyd Morgan in his very small book has evidently intended to supply to some extent this want by describing—not in simplest language, it might have been simpler—a few very common chemical and physical facts. It does not appear exactly from the preface for what class of readers it is intended, but it can scarcely fail to be useful if not interesting to any lay readers. It commences with the chemistry of a candle flame, and in that way passes on to the similar actions taking place in animals and plants, where of course carbonic acid comes into play, and we are led through carbonic acid to wood, coal, and diamonds, to the atmosphere, where the physical part comes in, the pressure of the atmosphere, the thermometer, and the idea of elements, compounds, and mixtures. Passing on to water, we have the proof of the composition of water, physical properties of water, which leads directly on to the phenomena of heat. Although only consisting of about 150 small pages, we are led up at the end to some chemical reactions, and an appendix on molecules. The whole book is arranged for experimental purposes, although the methods of performing some of the experiments are not given. It has been probably assumed that the experimenter should have conveniences supplied. The appendix on arithmetical questions

seems scarcely required in such a work, but, excepting this, it is certainly a step in the right direction to bring a knowledge of common things into a simple and understandable shape.

"L. M. C.'s" text-book is a sort of chemical, physiological, and biological book, and is divided under the following heads:—Food, its composition and nutritive value; its functions; and its preparation and treatment. It is evidently got up for the purpose of preparing for the examinations, as it says in the introduction that a grant of 4s. will be given for a pass, and that payment upon the results of examinations of school children are made to managers. In spite of this a considerable amount of useful information may be obtained from it, although that information is not conveyed in the best possible style. The descriptions of substances like bread, for instance, are not by any means exhaustive. Under animal food or flesh, it is stated that "animal food is composed of the same materials as vegetable; it is formed of the same elements and presents the same approximate principles, and contains water and mineral matters of the same kind as plants." This is not very instructive. The section on food and its selection will be useful, but the main object of the book is evidently to prepare for the examinations on this subject.

If the spread of chemical teaching may be measured by the number of small books on qualitative analysis, it certainly has a great number of disciples. There is nothing very extraordinary in Mr. Stoddard's book, unless it be the importance that is given to the atomicity marks attached to the signs of the elements. We find that iron is described as Fe<sup>II</sup> and also Fe<sup>III</sup>, whilst chromium is only put down as Cr<sup>III</sup>. Nickel and cobalt are both marked as dyad and tetrad. Only the so-called ordinary elements and acids are treated of.

#### LETTERS TO THE EDITOR

[The Editor does not hold himself responsible for opinions expressed by his correspondents. Neither can he undertake to return, or to correspond with the writers of, rejected manuscripts. No notice is taken of anonymous communications.]

[The Editor urgently requests correspondents to keep their letters as short as possible. The pressure on his space is so great that it is impossible otherwise to insure the appearance even of communications containing interesting and novel facts.]

#### Reply to Mr. Grubb's Criticisms on the Equatorial Coudé of the Paris Observatory

IN continuation of my first letter I now wish, in my turn, to criticise Mr. Grubb's instrument, and to show that in all respects it bristles with inconveniences. I discuss it as it is presented and explained by Mr. Grubb, and I wish to examine it successively—

- (1) From the optical point of view.
- (2) From the point of view of the mechanism employed.
- (3) From the point of view of its application to astronomy.

(1) The optical point of view. The system adopted by Mr. Grubb is much inferior to that generally used in ordinary equatorials. The dialytic telescope only gives images free from colour for the point which lies in the axis of the object-glass. For all other points images present themselves under the form of spectra which are longer as they are further from the axis. This arrangement necessitates that the three lenses must be very exactly centred, which can be done with the ordinary achromatic object-glass where the two lenses are in contact in the same cell. It is with very great difficulty that this can be done in a dialytic telescope. While admitting, however, that it can have an optical axis common for all the lenses of which it is composed, this centering becomes very difficult when the images are broken by a plane mirror, the

angle of which varies, and it becomes almost impossible in a broken equatorial, in which the eyepiece is independent of the moving part of the instrument, as proposed by Mr. Grubb. In a word, taking no account of the new and very grave causes of variability introduced by Mr. Grubb, this optical system is so unstable that its employment has been rejected unanimously by all astronomers and opticians. The least derangement of the position in the central mirror spoils everything.

The mobility of the plane mirror presents equally, from the optical point of view, a slight inconvenience. The quantity of light varies with the different angles of inclination, which renders the exact researches of the photometric very difficult. Without making one feel all its gravity, Mr. Grubb has, in truth, indicated the defect of this optical system. But in order to turn the difficulty he suggests that, since the field of view becomes smaller as the instruments become larger, we may content ourselves with observing at a central point. But this is an affirmation pure and simple. It is necessary in many measures of precision to have a large field of view. The contrary will present several serious objections. We have, in fact, to observe stars in relation with other stars, to measure, for instance, the difference of declination between a planet and a star of comparison. But we cannot make both these observations at the centre. The same thing will always be happening, in the case of comets, nebula, and clusters. It seems to me, on the contrary, that a telescope is more perfect the larger the field of view. Feeling thus, I have had made by Prazmowski, for my new equatorial *coude*, achromatic eyepieces giving a very large field. For the observation of comets I have such an eyepiece, which magnifies fifty times and has a field of view such that I can observe a degree. For a telescope of twenty-seven inches we might have such an eyepiece with a field of twenty-four minutes.

From all which precedes, I think everybody will agree that the system proposed by Mr. Grubb is far inferior to that now employed in ordinary equatorials.

(2) The mechanical point of view. The instrument consists actually of an ordinary equatorial, in which the part which carries the eyepiece is replaced by a counterpoise. It presents therefore, from the point of view of stability, all the defects of the ordinary instrument. Additional causes of instability inherent to the design are—

The micrometer and eyepiece are completely independent of the principal mass, which necessarily gives rise to different defects of decentering between the separated parts. Moreover, in this instrument there are three distinct movements. In addition to declination and right ascension, there is a third, which consists of a differential movement round the axis of the mirror. This last one constitutes alone, from the point of view of stability, a complication which does not exist in the ordinary instruments. All the movements of transmission are broken at a right angle, and are four times as long as those of an equatorial *coude* of the same size. There will therefore be such loss in transmission, one would never have the instrument perfectly adjusted and oriented. We see, from the mechanical point of view, there is such an incoherence between the different parts of the apparatus, that it is inferior to those now employed. And it really cannot be compared with mine, which is almost as stable as a transit instrument, and in which the movements of transmission are excessively simple.

(3) If we examine Mr. Grubb's instrument from an astronomical point of view, we see it is based on a principle which no astronomer can admit, namely, that it is superfluous to observe the greater part of the northern heavens. In many investigations among the most elevated in the astronomy of precision—let us take stellar parallax as an example—one is obliged to combine observations made at different epochs of the year, and it is only by the combination of measures thus obtained that the desired result is arrived at. These stars must be observed, therefore, in the northern part of the heavens as well as in the others, for the vicissitudes of climate do not permit the astronomer to observe exactly how and when he wants. The same necessity presents itself in the study of the double stars; to ascertain and to discard the systematical errors in the angles of position the astronomer is obliged to observe these stars in all the celestial regions. If one wishes to limit one's self to the exploration of one side of the heavens, one would lose precious opportunities and gratuitously introduce serious difficulties. There are also many cases in which this choice is not possible. Thus, if we wish to discover new comets every part of the heavens must be explored, and if one wishes to observe them they must be observed where they are.

Finally, permit me to ask Mr. Grubb how he is going to study that part of the heavens which lies between  $20^\circ$  from the zenith and the Pole. This region of space, I take it, would be entirely closed to the observer with Mr. Grubb's arrangement. Any research, therefore, which touched the stars covering this large area could not be undertaken.

The independence of the micrometer of the rest of the instrument renders impossible any measures of precision. The orientation of the micrometer, in fact, is the fundamental base of every measure, and to do this preliminary work properly three or four successive operations have to be performed, and take the mean of the readings and adjust the apparatus by means of the circle of position. But this fundamental operation cannot be performed on Mr. Grubb's instrument. In fact, in practice, if one wished to take an angular measurement with this instrument, one would have to proceed somewhat in this wise: First of all it would be necessary to content one's self with one approximation as to the orientation; then to repeat this after every individual measure; and lastly to take into account the disorientation of the micrometer, to submit the readings of the circle of position obtained to fastidious computations with a view to compensate them. This gives an idea of all the inextricable complications in which one would find one's self involved in this case. In fact, to secure a simple observation of a comet it would be necessary to increase the readings and the calculation by four times, and after all one would only get a result inferior to that furnished by an ordinary equatorial. I don't believe there is a single astronomer in the wide world who would undertake observations of precision under such conditions.

It is quite true, as Mr. Grubb indicates, that the *oculaire* might be connected with the rest of the instrument, but then, new inconveniences of another order would arise. These, however, I will not discuss now, for, as I said at the beginning, Mr. Grubb's actual proposal is now alone in question. However this may be, I consider the conception of this equatorial is so defective, taken as a whole, that I do not think its adoption would be seriously recommended. Nor do I think that the project will go beyond its present stage, unless essential modifications are introduced, and in this case the instrument would become like my own.

Paris Observatory

M. LÉWY

### Dust-Free Spaces

I VENTURE to call attention to some points in connection with the observations on "dustless spaces," &c., as detailed in the report of Dr. Lodge's lecture published in *NATURE*, vol. xxix. p. 610.

Certain observations and studies of my own lead me to think that, if attention be given to the points to which I wish to call the notice of physicists, results of the highest importance may be reached by means of the method of experimenting developed by Dr. Lodge and Mr. Clark, and described in the report referred to.

Dr. Lodge's statement (p. 611) that "cloud spherules are falling, but falling very slowly," is true when these spherules are not at a higher temperature than the atmosphere in their neighbourhood. When, however, very small particles floating in the air become heated, they warm the air immediately surrounding them, and then these particles are either buoyed up by a small envelope of heated and dilated air clinging to their surfaces, or they are borne aloft by the local currents which they create by contact with the surrounding atmosphere.

Observations continued for nearly fourteen years have convinced me that in ordinary clouds these two methods of lifting are combined—that to a certain extent each of the spherules or very many of the spherules of clouds are buoyed by adherent heated and dilated air, and that the whole of the cloud, in many cases at least, becomes warmer than its neighbourhood in general, which adds to its buoyancy as a mass of intermingled air, water, and vapour.

These remarks apply also to small particles of matter other than water. The action is the same except in degree. The very high specific heat of water enables it to heat surrounding air more readily and quickly than other substances do, and as a consequence masses of water as in clouds are lifted more quickly and to a greater height than masses of other bodies having the same proportion of surface to weight.

If it be remembered that radiant heat passes uninterruptedly through air, *i.e.* that air is diathermous, it will be seen that radiations from a distance striking upon particles of athermanous bodies suspended in the air will cause these latter to heat the

air about them, and produce upward currents or a buoying of the athermanous particles by dilation of the air in contact with them.

This affords a complete explanation of cloud-fotation and the fotation of fine dust-particles. For some years I have been in the habit of watching clouds, and by the use of the above theory have very often been able to account for forms, dimensions, and movements which I could not otherwise explain. Some four ago I explained the above ideas to the Chief Meteorological Officer of the United States Signal Service, and received from him suggestions which have since afforded me the means of much pleasure in observing the locations and forms and movements of clouds, and although these irregular masses are subject to many complicating circumstances, I have never yet observed anything tending to weaken this theory of fotation, but have made many hundreds of observations tending to confirm it.

I trust that it will be taken for granted that I do not wish to attack the hypothesis of Dr. Lodge and Mr. Clark, that heated bodies "bombard" and drive away approaching particles. My object is simply to show that, as it seems to me, the theory of particles buoyed up by a locally heated fluid, when considered in connection with well-known principles of radiation, &c., is sufficient to account for the phenomenon of the "dust-free coat" described in the article alluded to.

Referring to the figures on p. 612, an ascending current is shown in the neighbourhood of the pipe or rod in Fig. 1. The theory which I have sketched would indicate that this current had been set up in great measure by the indirect action of the heated tube or rod upon the surrounding air.

I should contend that the dust-free coat may be explained as follows:—

A given particle which may be assumed to be directly below the rod is heated by radiation from the rod. It in turn heats and expands the air in contact with it; the particle with a coat of adherent air becomes lighter than the surrounding atmosphere, and the mote, with its jacket of expanded air, ascends towards the rod. As it reaches the point marked "slow moving" in the figure, it begins to find itself in air which has been heated directly by contact with the rod, and distributed near it by the small "circular" currents which always surround a blunt obstacle in a stream of fluid. At the outer limit of the "dust-free coat" the particle or mote is arrested because it has come to a point where the air is so warm that the mote can no longer heat its jacket enough hotter than its surroundings to cause buoyancy. It is arrested because it has reached a point where the surrounding medium is as light as its own air-float, much as cork is arrested at a surface of water.

The mote with its warm air jacket could ascend through cool and therefore heavy air, but the air warmed by contact with the pipe is too light to float it.

The dark "tail" above the rod, or tube, is the upstreaming dust-free air, warmed by the tube, and too light to carry motes, or in which motes have not been carried by any current.

The report of the lecture contains within itself some very striking confirmations of this theory. For example, Dr. Lodge tells us that at a high temperature the dust-free coat is thicker than at low ones. This is according to the theory of fotation as above set forth, because an approaching mote would sooner meet the increased body of air warmed by contact with the tube to a point sufficient to destroy the buoyancy of the mote and its jacket. Again, hydrogen is a light gas having a very high specific heat; hence according to this theory the mote would need more heat and more difference of temperature to float than in air, and consequently should not be able to float up to as near the rod. Now, Dr. Lodge states that "in hydrogen it [the dust-free coat] is thicker than in air." With a surrounding medium of carbonic acid, less heat and less fotation are required for the mote, as the gas is heavier and of lower specific heat, and, quite in accord with the theory, the dust-free coat "is thinner" than in air or hydrogen. Again, Dr. Lodge states that the dust-free coat is set up by a "difference of a degree or two," and it would apparently require a much more complicated theory than the simple one here advanced to account for this on the bombardment hypothesis, as the action has been shown to be—

- (1) Affected by the medium as to thickness of coat.
- (2) Obtainable at different temperatures in the rod.
- (3) Apparently dependent, not on the actual temperature of the rod, but on the differences in temperature between the rod and its surrounding dust-containing fluid.

The behaviour of cool rods or plates, as stated, is also in accord with this theory. A mote coming within the influence of the plate or rod is cooled by radiation and loses buoyancy in its air jacket. If above the plate, it therefore falls upon it; if below, it drops away. Dr. Lodge does not explain how a cool plate "bombards" the motes and drives them away from its lower side. If clearly explained, the method of experiment developed and now under study by Dr. Lodge and Mr. Clark, and that of Mr. Aitken on the condensation of water about nuclei, will probably be found productive of results of the very highest importance.

Questions of climate, rainfall, healthfulness of districts, fogs, mists, humidity, &c., can probably be better studied than in any other way by some form of apparatus based upon results obtained by these experiments, if the theory of fotation above set forth is connected with them, as I trust it may be.

EDW. W. SERRELL, Jun.

Chabeuil, Drôme, France, April 27

Mr. Serrell is no doubt perfectly correct in his view that the average specific gravity of a warmed and vapour-filled cloud may be often less than that of air. The ascent of the so-called "steam" from a kettle proves this, and he will find the view clearly stated in Maxwell's "Heat," p. 280. I did not enter into details in the Dublin lecture, but I was fully convinced of the truth of this statement.

His supposition that the dusty air near a hot body gets warmed not by gaseous conduction from the hot body but by interception of its radiation by the suspended particles, is not an unnatural one, but it is practically untrue. It is disproved by the fact that the concentrated radiation from the electric light is much less effective in warming dusty (or any other) air, than is the neighbourhood of a warm solid only a few degrees above the atmospheric temperature.

Mr. Serrell's criticism, that we do not clearly explain the down-streaming dark plane from a cool body observed by Lord Rayleigh, is quite legitimate. So far as I entered into the matter at all, I intended to indicate provisionally a distinction between a cool body and a very cold one—the boundary coming somewhere, say, between ten and thirty degrees below the air, or possibly depending upon actual temperature as well as on difference. I am not prepared to assert that the bombardment of particles towards a cool body begins the instant it is colder than the atmosphere. I think it possible that there may be a neutral point below which it begins.

But Mr. Clark is working out this among many other points, and I am not sure that his view at present agrees with my hypothesis. He will doubtless make a complete statement when he publishes an account of the quantitative research he is now engaged in. Till then I prefer to leave the account of cold bodies a little vague.

O. J. LODGE

### The Supposed Volcanic Dust Phenomena

THE reddish circle round the sun, which I suppose must be considered as a kind of very large corona, alluded to by E. Divers of Tokio (NATURE, vol. xxix. p. 283), G. F. Burder (p. 525), and other observers, was invariably visible here, when circumstances favoured, from November 1883 up to April 3. In the middle of that day, and of the 4th, though circumstances seemed favourable for seeing it, no tinge of red was perceptible; but it was visible late in the afternoon of the 4th. Since then it has become more visible again, and from April 21 has been very plain, though not so conspicuous as it was originally. It is red in the middle of the day, and brown towards sunset, the bright space between it and the sun being blue or greenish.

The semicircle opposite the sun is now far fainter than it was originally, indeed I do not think I should notice it now without looking for it. It is now plainest when the sun is a little above the horizon, which was not formerly the case, and I have not seen it after sunset lately. This may perhaps be owing to a change in the height of the volcanic dust, or whatever it is.

The amount of sediment in the rain strikes me as being very large. I have at different times in the last few months collected it upon glass and examined it with the microscope: there appear in it a considerable variety of crystals and other transparent objects. Some of the crystals are like those drawn by Mr. Beyerinck (vol. xxix. p. 309). I have usually found a number of regular transparent pieces, but I cannot say that they have

much resemblance to the vitreous ashes of Krakatoa, drawn on p. 587, as they are very thin.

I have examined this sediment with the naked eye to see whether I could perceive anything like the large corona. I darkened the room and admitted the sunlight through a narrow slit on to the glass. The sediment sparkles with various colours, chiefly pink and green, I suppose owing to interference; and it is difficult to judge which colour preponderates. I find a decided excess of green at a small angular distance from the sun, and often pink preponderates at a greater but varying distance. These colours being similar to those seen in the large corona are slightly confirmatory of the theory that the sediment from the rain is the substance which has caused it and the strange sunsets and sunrises; but other substances are also capable of giving a green light near the sun. Moisture on glass gives quite different colours, so far as I have observed.

The cirrus-like wisps on which the sunset phenomena appears were definite and very small at the end of November; but on the whole grew larger and more indefinite, till at length they have been quite imperceptible for several weeks past.

On April 24 there was the first moderately bright aurora have seen since October 5. Can this remarkable absence of auroras and the scarcely less remarkable frequency of lightning have been caused by the volcanic dust? If so, it may also account for S. Tromholt's finding auroras so scarce and poor in Iceland during the winter, as mentioned on p. 537 (vol. xxix.) though he does not say whether they were scarcer than usual there.

THOS. WM. BACKHOUSE.

Sunderland, May 10

#### Pons' Comet

PONS' comet was visible here with the naked eye throughout the month of February, including the nights of greatest moonlight. I so saw it on some twenty or more nights during that month, and append some notes as to its comparative brightness, so far as I could judge.

February 3.—“Comet visible till 10.45. Could see ‘old moon’ with naked eye easily, and in telescope Grimaldi and Aristarchus, but only with a very small part of sunlit portion in field.”

February 6.—“At 8.45 could see comet with naked eye, though sky not quite free of sunset-glow and somewhat hazy, and moon nine days old. It was altogether faint, but most of the tail visible at other times could be seen—certainly more than I should have expected.”

February 9.—“At 9.30 found the comet with naked eye and could see it without difficulty, but there was only the suggestion of a tail. Comparing it with  $\alpha$  Sculptoris by looking midway between the two, they produced the same effect on the eye; but of course the least magnifying power showed the difference.”

February 10.—“8.20 to 8.50. Found comet with naked eye, but it was very faint, and to the unaided eye looked certainly fainter than  $\alpha$  Sculptoris. Yet it seemed to me that more of the tail (or the tail more certainly) was visible than last night.”

February 11.—“Found comet with naked eye about 8.10, and watched it up to 9.40. As the sky lost the traces of sunset I could pick it up without difficulty, in spite of the full moon shining in a cloudless sky. It was not quite so easily seen as  $\alpha$  Sculptoris, but I may say that  $\lambda^1$  and  $\lambda^2$  Sculptoris, though each marked as of the same magnitude as  $\alpha$ , I could not get a glimpse of, though I tried hard.”

February 12.—“At 8.15 found comet with naked eye without difficulty, and so at intervals up to 9. Found it again with difficulty at 10.15; it was then getting low and into the haze: in the telescope it seemed then to have lost (at a guess) half its light.”

On the subsequent clear nights in February there was no difficulty.

March has been much cloudier, and owing to this and moonlight I only saw it with naked eye certainly on four nights—the 1st, 4th, 16th, and 17th. My note for the 4th is: “Found and saw comet with naked eye several times, though not easily, between 8.15 and 8.40 p.m. Could see the outline of the ‘old moon’ without difficulty.”

The 5th is marked as doubtful both as to comet and “old moon.”

March 14.—“A fine pink glow in evening, and splendid afterglow about 7.15—never saw it better. Found comet easily with opera-glass, but could not see it with naked eye, the moon rising before the glow had vanished.” So also on the 15th.

March 16.—“Saw comet repeatedly with naked eye (looking a little above it) between 7.45 and 8.30. Sky very good.”

March 17, 7.40 to 8.10.—“Found comet with naked eye, and saw it many times, looking a little above it; could not be quite sure of seeing it direct.”

(Owing to clouds I have only seen it on two nights since, the 24th and 28th; and that only with opera-glass and telescope.

Nelson, N.Z., March 29

A. S. ATKINSON.

#### Snow and Ice Flora

IN the account of Prof. Veit Brecher Wittrock's interesting work on the Arctic snow and ice flora (NATURE, vol. xxviii. p. 304) your reviewer enumerates the countries and mountain ranges where red snow has been observed, but does not mention the Southern Alps of New Zealand, where as far back as 1861 this plant was observed by me. The fact that green and red ice have been found in these high northern latitudes, and that the unusual coloration has been traced to microscopic organic life is of special interest to me, as I repeatedly observed green as well as red ice amongst the glaciers of New Zealand, first at the head of the Rangitata River, as far back as February, 1861. At the time I published an account of this occurrence, which was reprinted by others (amongst others see Hochstetter's “*Neu Seeland*,” 1863, p. 342). Since then during my alpine explorations I have repeatedly observed the same phenomenon, so that evidently at the Antipodes there occurs a counterpart of the Arctic snow and ice flora. It is to be hoped that some able botanist will some day do the same work for us that Baron Nordenskjöld and his able coadjutors have done for Greenland and Spitzbergen.

JULIUS VON HAAST

Christchurch, N.Z., December 31, 1883

#### The Rotation Period of Mars

NOTWITHSTANDING his comparatively small diameter and slow axial motion, the planet Mars affords special facilities for the exact determination of the rotation period. Indeed no other planet appears to be so favourably circumstanced in this respect, for the chief markings on Mars have been perceptible with the same definiteness of outline and characteristics of form through many succeeding generations, whereas the features such as we discern on the other planets are either temporary atmospheric phenomena or rendered so indistinct by unfavourable conditions as to defy lengthened observation. Moreover it may be taken for granted that the features of Mars are permanent objects on the actual surface of the planet, whereas the markings displayed by our telescopes on some of the other planetary members of our system are mere effects of atmospheric changes which, though visible for several years and showing well-defined periods of rotation, cannot be accepted as affording the true periods. The behaviour of the red spot on Jupiter may closely intimate the actual motion of the sphere of that planet, but markings of such variable unstable character can hardly exhibit an exact conformity of motion with the surface upon which they are seen to be projected. With respect to Mars the case is entirely different. No substantial changes in the most conspicuous features have been detected since they were first confronted with telescopic power, and we do not anticipate that in future ages there will be any material difference in their general configurations. The same markings which were indistinctly revealed to the eyes of Fontana and Huyghens in 1636 and 1659, will continue to be displayed to the astronomers of succeeding generations, though with greaterfulness and perspicuity owing to improved means. True there may possibly be variations in progress as regards some of the minor features, for it has been suggested that the visibility of certain spots have varied in a manner which cannot be satisfactorily accounted for on ordinary grounds. These may possibly be due to atmospheric effects on the planet itself, but in many cases the alleged variations have doubtless been more imaginary than real. The changes in our own climate are so rapid and striking, and occasion such abnormal appearances in celestial objects that we are frequently led to infer actual changes where none have taken place; in fact, observers cannot be too careful to consider the origin of such differences and to look nearer home for some of the discordances which may have become apparent in their results.

The rotation period of Mars has been already given with so much precision that it may seem superfluous to rediscuss the point, but it is very advisable to see whether recent observations



confirm the values derived from former results. The "Hourglass" or "Kaiser Sea," which is admittedly the most prominent mark on the planet, is a very suitable one for comparisons to find the intervals of rotation. Early in 1869 I saw it with a 4½-inch refractor as it passed the central part of the disk. On February 2, 1869, it was central at 10h., on February 4 at 11h., and on February 5 at 11h. 30m.

I observed the same object in February of the present year with a 10-inch reflector (power 252), and noted it crossing the planet's central region at the following times:—

1884	h.	m.
February 14	...	5 55
15	...	6 35
19	...	9 5
22	...	11 4

I have combined my observation of February 4, 1869, with that of February 14, 1884 (as I regard this pair as the best obtained), to ascertain the rotation period. The interval includes 5487d. 18h. 55m. = 474,144,900 seconds. Correcting this for the difference in longitude between Mars and the earth at the two epochs and for defect of illumination (there is no necessity to apply any correction for equation of light, as the apparent diameter of the planet on the dates selected for comparison was about 16", and hence the distances were nearly the same), I find the time of rotation resulting from the discussion of these observations to be

h. m. s.  
24 37 22'34 (5349 rotations),

which is in satisfactory agreement with the periods computed by Kaiser, Schmidt, and Proctor from a much longer series of observations. In order to exhibit the small differences between the period now computed and those resulting from some of the best modern determinations, I give the following summary:—

	h.	m.	s.	
J. H. Mädler ...	24	37	23'8	<i>Ast. Nach.</i> 349.
1864, F. Kaiser ...	24	37	22'62	<i>Ast. Nach.</i> 1468.
1866, R. Wolf ...	24	37	22'9	<i>Ast. Nach.</i> 1623.
1869, R. A. Proctor ...	24	37	22'735	<i>Mon. Not.</i> vol. xxix. p. 232.
1873, F. Kaiser ...	24	37	22'591	<i>Annalen der Leidener Sternwarte</i> , vol. iii. p. 80.
1873, J. F. J. Schmidt	24	37	22'57	<i>Ast. Nach.</i> 1965.
1884, W. F. Denning	24	37	22'34	

It is obvious that Mädler's period of 24h. 37m. 23'8s. is about one second too great. If we take a mean of the other six values (all within 0'6s. of each other) we get

h. m. s.  
24 37 22'626

which may be fairly regarded as a very near approximation to the true sidereal rotation period of Mars.

The computations of Kaiser, Schmidt, and Proctor are severally based on very long periods, the comparisons being modern observations with those of either Huyghens or Hooke during the last half of the seventeenth century. It is unfortunate, however, that there is some question as to the correct identification of the spots depicted in some of the ancient drawings. The representations by Hooke on March 2, 1666 (old style), at 12h. 20m. and 12h. 30m., also those by Huyghens in 1659, 1672, and 1683 give a large irregular spot, extending in a north and south direction, which can only be identified as the "Hourglass" or "Kaiser Sea." It would appear, however, that this interpretation is incorrect in certain cases, for the several drawings do not only show disagreements with each other but also when compared with modern observations originate discordances of period, small it is true, but still too large to be attributed to simple errors of observation. No doubt the period which approaches nearest to the truth will become apparent from future observations, though it can hardly admit of definite settlement for many years, inasmuch as the differences between the several times of rotation as above deduced are very insignificant, and must so closely accord with the real period of the planet that the errors such as exist must be allowed to accumulate over a lengthened interval before they will become distinctly manifested. A comparison extending over fifteen years is insufficient for the purpose, for a computed time of rotation, erroneous to the extent of one-tenth of a second, will still, at the termination of such a period, answer to the positions of the markings to within 9 minutes of time. It is to be remarked that Mr. Marth, whose opinion is entitled to great weight, has, for some time, adopted the period of 24h. 37m.

22'626s. for the rotation of Mars. This corresponds to a daily rate of 350°8922, and forms the basis of his computations in his "Ephemerides for Physical Observations of Mars," annually published in the *Monthly Notices*. W. F. DENNING

"The Electrical Resistance of the Human Body"

WILL you kindly publish the inclosed from Prof. Dolbear? It furnishes a complete explanation of the discrepancy between his measurements of the resistance of the human body and those which I have recently made. At the same time, as I have pointed out to him, the fact that this resistance may sink below 500 ohms with "soaked skin," even if that be "abnormal," is of the highest physiological importance, and goes far to explain the hitherto mysterious deaths from accidental passage of a current through the body. Most of these, as Prof. Forbes remarked to me, have taken place with alternate, not continuous, current machines. W. H. STONE

Wandsworth, May 11

College Hill, Mass., April 23, 1884

DEAR SIR,—I have to acknowledge the receipt of your pamphlet "On the Resistance of the Human Body," for which I am obliged. I am glad to know that physiology has some one in its ranks who is interested in that line of work, and who knows what to do in order to settle such vexed questions.

I have also seen in the last *Electrical Review* that has reached me an article on the same matter, in which you refer to me and what has been published concerning some of my work, that needs a little elucidation. In the early days of telephony the experiment was often tried of making the human body part of the circuit in order to see how speech could be transmitted through the body, in the language of those days. Bell wanted to know what the resistance of the body was when in such circumstances, and I measured it from hand to hand when thumbs and fingers grasped the terminals of a wire and found it to vary between 6000 and 15,000 ohms, and wrote to him to that effect, and from that grew out the statement to which you have referred. Now under such conditions that work is right, as I have frequently since proved.

It seems to me that when we speak of the resistance of the body or of any body, and do not define what is meant by body, it is fair to assume that the body is the ordinary body under ordinary conditions. If the resistance (the *actual*) of the wire is found to be a thousand ohms by one party and another one files off the rust from the contacts and then finds the resistance less, both parties may be right. Now the skin of individuals is more or less horny in texture, and so has high resistance which soaking may reduce, and the question then properly arises, is the hard skin properly a part of the body? The resistance of a farmer's hand is often twice as great as that of a child's or of a man of sedentary habits, but solely, as I think, because of the thickness and density of his skin. Does not the question resolve itself into this—What is the resistance of a dry hand and the resistance of a soaked hand? What is the resistance of a good conductor and the resistance of a poor conductor? If the poor one is made better in any way, its resistance is correspondingly increased.

If the condition of the body is abnormal, its resistance may also be abnormal. I should call a soaked skin abnormal.

Still it is of the utmost importance that we should know what the resistance is under all conditions, as being the only way to advance in knowledge of the physiological effects of known currents, and I would again express my gratification at your persistent work in this field, and if I can in any way be of service to you I shall be pleased to be employed.

Yours very truly,

A. E. DOLBEAR

To Dr. W. H. Stone

Instinct in Birds

MR. GRAVES, who writes on this subject (*NATURE*, vol. xxix. p. 596), is, I fear, not so accurate an observer as the magpie, for he misquotes the day fixed by the birds for building, and then indicates that the young "mags" are restricted to four in each nest, while the fact is there are often six or seven in a nest. The magpie is too fond of a fresh egg for breakfast to escape the attention of the gamekeeper. I have often seen the greater part of their nest shot down, repaired, and reoccupied by the birds year after year. I know of no bird that begins the work of incubation here early in February, nor any that devotes two months to the work. The rook (*Corvus frugilegus*) is the first to

begin, and I have often been told that it does so early on the first Sunday of March, G.M.T.

What I said about the magpie beginning on the first Sunday (old style) was founded partly on report, but mainly on personal observation extending over some years at one breeding-place, where I have often seen them at work for the first time on this particular morning, and on one occasion in another locality on the same day.

This instinct is not confined to any particular tribe or order, but is common, I think, to all wild fowl, and the two instances given by Dr. Rae (vol. xxx. p. 7) of the regularity with which certain birds pass north to their breeding-grounds is precisely the point at issue, as I believe they begin work as soon as they arrive.

Scientific accuracy has not yet been directed to the subject, but there can be no doubt that from some cause, possibly a sharper and better defined division of summer and winter in former ages, all the feathered tribe have inherited an instinct in nest-building and in the time of their arrival at and departure from their breeding-grounds which guides them to a day in many cases without reference to the state of the weather.

WM. BROWN

112, West Regent Street, Glasgow, May 5

Watts's "Inorganic Chemistry"

THE review of my "Inorganic Chemistry" in NATURE of May 1 (p. 3) appears to have been written without much knowledge of the previous history of the work. The reviewer, indeed, writes as if he were criticising an entirely new book, whereas a glance at the preface might have shown him that the volume in question is the first part of the thirteenth edition of Fownes's well-known "Manual of Chemistry," the first edition of which was published in 1844.

I. WATTS

151, King Henry's Road, N.W.

The Recent Earthquake

I NOTICE that Mr. Topley, at the conclusion of his communication to you respecting the recent earthquake in Essex, remarks, "but at present we know of no observations in the central parts of Kent, Surrey, or Sussex." I wish therefore to mention, that although I did not myself notice anything in connection therewith, yet an invalid neighbour of mine, lying in bed, distinctly heard a rumbling noise about 9h. 20m., and a moment afterwards perceived some pot plants in front of his window sway to and fro. This is the only incident with which I have been made acquainted.

C. L. PRINCE

The Observatory, Crowborough, Sussex, May 3

THE rise in the Essex waters detailed in my letter of last week still continues. Mr. Radforde Sharpe has kindly sent me the following additional heights that the water rises from Messrs. Courtauld and Co.'s well, at Bocking, Braintree, in inches above the surface of the ground:—

May 6	...	...	40½ inches	May 9	...	...	39½ inches
" 7	...	...	38½ "	" 10	...	...	39½ "
" 8	...	...	40 "	" 12	...	...	44 "

At Colchester Corporation Waterworks Mr. C. Clegg, C.E., reports the rise recorded is still maintained.

Museum, Jermyn Street, S.W. C. E. DE RANCE

W. H. FRANCE.—Any good entomological text-book will give you the information you ask for.

NOTES ON EARTHWORMS

EVER since our great naturalist called attention to the common earthworm, we watch them with entirely different eyes as they creep timidly out on to the lawn or hurry across the gravel walk; as they collect the dead leaves or bits of string and cloth we may have dropped the evening before, or heap up their household refuse outside the entrance to their home.

He long ago pointed out its importance as a geological agent. The surface of the ground would be very different were it not that the earthworm is for ever at work bringing in the decaying vegetation and converting it into mould.

And, more than this, the superficial deposits are often modified to a considerable depth by the earthworms, which, carrying the earth mouthful by mouthful, and the gravel stone by stone, invert the order of stratification.

But we must not push this explanation of the origin of the universal surface mould too far. I received one caution from Darwin himself, many years ago when I was talking to him about the manner in which the chalk with which the land was dressed in Kent worked down. He told me to be careful to bear in mind the action of the great Kentish plough as it year by year turned swathe after swathe down the slopes. The result of this plough-down is clearly distinguishable from worm-mould. In his work on earthworms also he refers to another mould-forming agent of more universal operation and hardly less important cumulative effect. My attention was first directed to it by a lecture I heard delivered by Stoppani in Milan many years ago, in which he was explaining the action of the wind in modifying the surface of the earth, and especially in carrying dust, organic and inorganic. Richthofen and Drew have thus explained the origin of the loam that covers half Asia; and Mr. Clement Reid has recently extended the same kind of observation to Great Britain (*Geol. Mag.*, April 1884). Without this addition we can hardly explain how earthworms could find the material for the manufacture of the mould which often fills the interstices of the ruins of a buried city.

We find, commonly, isolated tumps of moss-covered soil, and every gradation from that up to the large patches of mould which hang like little gardens on each sheltered ledge, where the greater part of the material must evidently have been carried from elsewhere and not have been brought up from below; where it is obvious, from the character of the rocks, that the principal part of the mould cannot have been derived so much from them as from the wind-carried fragments of organic and inorganic material and the decomposition of the vegetation that soon began to grow upon it.

But we find also that the earthworms soon appear in such places, and set to work to mix up and modify all this various stuff that has by various agencies been brought together.

As squirrels, burying acorns and nuts in the autumn, have planted many an oak forest and hazel grove, so it is probable that the earthworms plant many of the ash and sycamore trees that we see perched in out-of-the-way corners, where it is difficult to explain how the blown seed can have got covered by mould enough to allow it to germinate. If an overhanging tree drops the seed, or the wind carries it anywhere near the worm's feeding-ground, it is dragged in and planted in leaf mould, and kept moist till spring time. At this time of the year we see clusters of sycamore seedlings growing up together out of the little worm-hills into which they had been dragged heavy end first.

It is therefore interesting to inquire into the various reasons that should make earthworms travel and occupy new ground. Round the margin of an overcrowded colony we should expect them to spread. They cannot live under water, so they have to move away before a flood. It has been stated that "they may live when completely submerged in water for nearly four months" (Romanes reviewing Darwin, NATURE, vol. xxiv. p. 553). But they were killed off by a flood of a couple of days' duration in the Backs of the Colleges at Cambridge in August 1879. Some of them seem to have got on to the paths, which are raised above the surrounding meadows, and there died. Where the greatest number were found dead the ground had been submerged for a longer time. The following carefully recorded observations by the Rev. Henry Russell, of St. John's College, are worth noting:—

"On Sunday, August 3, 1879, our paddock (the inclosed space in which the men play at lawn tennis, in front of the

new court) was covered with water to the depth, at 1 p.m., when it was greatest, of four to five feet. The level of the paddock is much lower than that of the ground surrounding it. . . . Therefore, on Wednesday, August 6, I cut a trench from the north-west angle of the paddock across the raised path. . . . The water had drained off by Saturday evening, August 9. The rush of water from the west across the Fellows' garden had carried with it into the paddock a great quantity of worms, which, when the water had subsided, were observed, some very large, lying dead under the water. As the water drained off, these lay on the paddock and on the slopes of grass surrounding it, and the smell of them infected the air till Friday, August 15."

Mr. Russell's observations go to show that the worms found dead were not all worms that had lived in the paddock, but those which had got washed out with the earth from the Fellows' gardens, and so they perhaps perished sooner being in the water. It is probable that worms buried deep in the earth under submerged meadows may, if they remain underground, hold out through much longer floods. However I gather that a large number perished in the adjoining parts of the Backs, and were seen on the paths and slopes as soon as the flood began to subside. Many of them were of exceptionally large size. I have heard of land injured by floods where the injury was supposed to be principally due to the destruction of all the earthworms. It is probable that the growth of peat-mosses may be in great part referred to the fact that the conditions were unfavourable to earthworms, for had they been there they would have worked up the vegetable matter into mould.

But there must be something besides floods that makes earthworms migrate.

If we drive a stick into the earth and move it about so as to shake the ground, the earthworms will come out to the surface and scuttle away in all directions. This was a common way of getting worms for fishing, and we used to be told, as Darwin notices, that the worms came out because they thought a mole was digging after them.

There must be however some other reason why worms will often come out to the surface in the daytime, and hurry away across a gravel path or on to a road, and why they then seem so much less sensitive to tremor of the ground about them than do the worms that come out to feed on the lawn.

From the analogy of other more highly organised animals I could not help thinking that there must be some creature that hunted the common earthworm, some worm ferret that drove them out. Many who have passed their lives in the country know well when they see a large field-mouse cantering down a road and showing little fear of man that a fiercer enemy than man is following the poor little animal with untiring certainty. If you draw aside and watch, you will soon see a weasel following by scent. Even a hare or rabbit will at length lie down paralysed with terror, and give itself up to the stoat that has followed it with deadly pertinacity. The sudden appearance of one or two strange birds in a neighbourhood has often been a source of wonderment, and it has sometimes been suggested in explanation that they had been chased by birds of prey and got up into strong currents of air. Those who have seen a peregrine drive a flight of rooks up into the sky can easily see how this might happen. In the cases to which I am referring the earthworm comes out like a hunted thing. I have also noticed that many of the worms that I found dead or torpid were maimed; generally they had their tail cut off, and this when there had been no digging in my garden for a long time, and although there are few birds that would touch them. I have frequently observed that the earthworms were apparently unwilling to go to ground again though I have tried to make them in order to watch the rate and manner in which they buried themselves. A

few days ago, however, I saw, I believe, the explanation of most of the cases I had been observing. A large earthworm about nine inches long, bright, clean, and healthy-looking, was moving somewhat irregularly on the earth of a flower-bed. On stooping to examine it, I found a small yellow animal with a brown head holding on within about half an inch of the tail end of the worm. I sent it to Prof. Westwood, who writes: "Your worm-eating larva is evidently one of the Carabidæ, probably *Steropus madidus*" (see *Gardener's Chronicle*, 1854, p. 613). It was not disturbed by my taking up the worm, but went on biting its way round the worm, holding on like a bulldog, and bettering its hold every now and then. It had nearly got round the worm, leaving a lacerated ring. The wounded part seemed somewhat swollen, but on this point I am not clear, as the unequal power of extension of the wounded part may have produced the effect of swelling. Mr. Edwin Laurence has recorded (*NATURE*, vol. xxvi. p. 549) a similar circumstance observed by him in France, where, however, the larva seems to have attacked the worm differently, and with a view to killing it rather than cutting off a portion, and from his description, moreover, it would not appear to be the larva of the same species. He suggests that the numerous birds in England may have destroyed such an enemy of the earthworm. A sparrow would probably take the larva, and not touch the earthworm. One would have thought that the earthworm would have a better chance of rubbing off his deadly enemy in the earth than above ground, as a salmon is said to clean himself in a gravelly river, but we want further observations on this curious question, as well as on several others raised by the inquiry, How arc worms transported to out-of-the-way places? and How long can they live in soils of various degrees of permeability when the surface is flooded?

T. MCKENNY HUGHES

#### THE LOW BAROMETER OF JANUARY 26, 1884

IN the end of January we gave a brief notice (see *NATURE*, vol. xxix. p. 316) of the unprecedentedly low barometric readings which were observed on the evening of January 26 in the middle districts of Scotland over which the centre of that great storm passed. The lowest reading, reduced to 32° and sea-level, then given was 27.332 inches, and was observed by Mr. George Croucher at Ochertyre, near Crieff. This still remains the lowest reading observed during the storm, and as it is absolutely the lowest known to have been observed in Europe, if not indeed the lowest on any land surface of the globe since the invention of the barometer, it is desirable to give an accurate record of it in *NATURE*.

On that occasion, Mr. Croucher's observations included the barometer, its attached thermometer, and a thermometer hung outside the window, it being too stormy to venture out. The observations near the time of greatest depression, corrected for instrumental errors and reduced to 32° and sea-level, were, in inches, 27.631 at 7 p.m., 27.527 at 7.45 p.m., 27.420 at 8.30 p.m., 27.390 at 9 p.m., 27.332 at 9.45 p.m., and 27.365 at 10.15 p.m. The correctness of these readings is amply attested by the hourly barometric readings made at a considerable number of the Scottish meteorological stations that evening.

At the meeting of the Royal Meteorological Society on February 20, a paper was read on the storm of January 26, in which it is remarked that "the lowest readings of the barometer (reduced to 32° and sea-level) yet reported were 27.32 inches at Kilcreggan, and 27.332 inches at Ochertyre." The observations at Kilcreggan were made with an aneroid, whose errors were unknown. From the hourly observations made at the different stations in Scotland, the isobars for each hour have been drawn, and, from a comparison of the Kilcreggan observations with these

isobars, the following approximate errors of the aneroid have been determined for the lowest recorded readings:—

p.m.	Aneroid, inches	Approximate error	inch
7	27'300	...	-0'230
8	27'200	...	-0'240
8.30	27'155	...	—
9	27'200	...	...
10	27'300	...	...

Mean error ... .. -0'230

If the correction + 0'230 inch for instrumental error and height be applied to 27'155 inches, the lowest observed sea-level reading at Kilcreggan was only 27'385 inches—a reading, it may be remarked, agreeing closely with the lowest readings noted at several stations on the mainland and islands of Argyllshire earlier in the evening. The Ochertyre reading, 27'332, was thus, so far as known, absolutely the lowest recorded during the great storm of January 26, 1884.

THE THEORY OF SUNSPOTS<sup>1</sup>

THE literature of heliography, by no means inconsiderable in extent, has received an addition by the publication of the work before us which, if it makes no attempt to enlarge our knowledge of solar phenomena from personal observation, is deserving of notice as a specimen of one of the modes in which those phenomena are attempted to be explained.

The subject is confessedly full of difficulty as well as interest. Nothing can be more natural than the wish to obtain some knowledge of the constitution of that splendid orb that is the dispenser of life and enjoyment to unnumbered millions of organised beings, and that exhibits on its surface such a strange development of forces commensurate in intensity with its amazing magnitude. But these tempting inquiries are beset with difficulties scarcely to be appreciated in the absence of actual experience. When we bear in mind the amount of light and heat that has to be encountered, with all its consequences in optical, mechanical, and atmospheric impediments, we may rather wonder that man should have been permitted to accomplish so much, than that he should have failed in effecting more. The servicable working of the telescope soon comes to an end; and what it is able to exhibit it is not able to render intelligible. In strong contrast with the exploration of the selenographer, who feels no doubt as to the general character of his object, whatever perplexities may arise out of the study of its details, the observer of the solar disk knows absolutely nothing as to what he is looking upon. He finds a blazing surface of by no means uniform texture, unlike anything else in the whole compass of his experience. He encounters strange-looking specks that disfigure, if we might venture to use such a word without presumption, the purity and perfection of that brilliant orb. In those dark patches, and their attendant fringe-like borders, what is it that meets the eye? Cavity? or cloud? or eruption? or cyclone? or scoria? Have astronomers succeeded in explaining them? Shall we listen to Wilson, or Herschel, or Kirchhoff, or Nasmyth, or Secchi, or Faye, or Zöllner, or Langley? More or less, they all disagree. Or shall we be venturesome enough to attempt an independent solution of the mystery? Little encouragement could be found in such a course. After such protracted discussion we could hardly bring to our telescope an unbiased eye or an impartial judgment. What we are looking for, we should be likely to find. We shall be surrounded with phenomena that lend themselves with perplexing facility to very dissimilar and even opposite interpretations; and, where one observer is confident as to a clear vacancy

<sup>1</sup> "Die Theorie den Sonnenflecken." Nach den neuesten wissenschaftlichen Forschungen dargestellt von J. E. Braszus. (Berlin, 1884.)

leading down to unimaginable depths, another fills the same dark area with heavy clouds or floating dross. There may be, and for our own part we believe there are, as in the formerly contested theories of light, details of less equivocal character adequate to guide if not absolutely to establish our judgment; but the ambiguity of the general aspect is sufficiently shown by the support which such conflicting theories have claimed from it, each in its turn.

Perhaps we are disappointed in our telescope. It will be to no purpose to enlarge our aperture or deepen our eyepieces: we are still confronted by an insoluble mystery. We adopt a fresh mode of investigation, the means of which have been but recently placed in our hands; and we bid the spectroscope exert its analysing power and report to us what is there. And now, under the guidance of Lockyer and Janssen and Huggins, we shall be carried a long way in advance, further than the boldest imagination would have dared to anticipate but a few years back; and we find set before us, as in some strange vision, the unmistakable presence of familiar elements, ninety-three millions of miles away. Yet even this triumph of human ingenuity finds there a boundary that it cannot overpass. The evidence, to a great extent conclusive, is sometimes equivocal, sometimes perplexing: affected probably by influences the force and direction of which we can little estimate. The well-known features often wear a strange aspect, and are associated with incomprehensible surroundings. We have succeeded in interrogating the sun: he has answered us, and his answer will surely be reliable:—

"Solem quis dicere falsum

Audent?"

That is, if we can but comprehend it; but unfortunately the message is not free from obscurity; some of it is in an unknown speech, and "Helium" and "No. 1474" and others of their companions are not only beyond our interpretation, but are likely so to remain. Very wide is the field thus opened for speculation, and very different may be the deductions from the same, or apparently the same, premises, with little possibility of demonstrating that any one combines all the elements of truth. Not one of the current theories has wanted defenders of intelligence and skill; if no one of them clears up all difficulties, no one fails in showing that there is much to be said in its favour; and therefore, as long as no patent absurdity interposes an insuperable bar, we may well exercise toleration to those who do not see through our eyes, or who question to some extent our conclusions. The best result is perhaps not very far in advance of probability, and every claimant has some right to be heard.

Remarks somewhat of this nature may be suggested by the treatise before us, which may be looked upon as an attempt to stem the prevailing current of opinion as to the cause of solar phenomena by showing that they may receive a complete explanation from Zöllner's theory of floating scoriae, as expanded and developed by the author. The principal results which he has deduced from an extended collation, as it would appear, of the previous observations of others, may be expressed in the following way:—

The sun is to be looked upon as an intensely heated and very gradually cooling ball of monatomic gas, the visible surface of which, or photosphere, is, as Kirchhoff also maintained, composed of iron, with a small admixture of other metals, in a state of glowing fusion, and permeated in every direction by an abundance of incandescent hydrogen, this gas being poured forth abundantly from the exterior of the monatomic nucleus, where the central temperature is sufficiently reduced through decreasing density to admit of the first steps of elemental association. The presence and diffusion of this hydrogen maintains the fused condition of the iron shell, and prevents it from cooling enough to exhibit in every part the

condition which obtains exceptionally in the spots. The "granulated" texture of the photosphere is the result of the eruptive pressure of the internal hydrogen, upheaving and penetrating the glowing mass of iron. The faculæ owe their greater elevation and intensity to an increased activity of the same process; and the chromosphere and the protuberances, whether of the more eruptive or more cloudy character, are traceable to the same origin, the greater brilliancy of the former class being due to the admixture of metallic vapours with the all-pervading hydrogen. The iron shell is not everywhere in a state of equal fluidity, a considerable portion being in a more "pappy" or viscous condition, such as may be seen in our own iron furnaces, which, however, does not render its presence manifest without such a reduction of temperature as to produce opacity. This cooling does not obtain either in the equatorial or polar regions, but is effected in what are known as the "spotted zones," by the overflow of hydrogen from the loftier equatorial strata of the atmosphere. Here, the gas, having been carried up in consequence of the solar rotation into a higher and cooler region, and extending itself laterally as an "equatorial current," descends on the less fluid portions of the photosphere, whence radiation is not so free; they are thus reduced to the more scoriaceous and opaque condition in which they assume the well-known appearance of "spots," while the whirls of cooler vapour on the outside of the main column in its downpour, encountering and tearing away the adjacent metallic edges of the chromosphere, force them to assume the form of those radiated fringes which we know as "penumbrae." The *maxima* and *minima* of the spots, as well as their respective drifting towards the poles or the equator, find their explanation in a "pulsation" or alternate compression and expansion of the globe, chiefly in the direction of its axis, from corresponding alternations in the balance of internal condensation and temperature, each of which is supposed to be in its turn in the ascendant; and though the change of dimension is slight, it is sufficient to give preponderance either to the equatorial or polar current, and, combined with the rotation, to determine the periodicity of the frequency and range of the spots. On the whole, the energy of solar radiation is never compensated; but the waste is so gradual that we have no reason to anticipate any sensible effect for ages to come, and yet so sure that the progressive cooling must terminate in ultimate extinction. In our author's words, "When in some future period of the world the whole of the hydrogen has escaped from the solar nucleus, the sun will cease to shine with its wonted intensity, and will become more and more feeble till at length it hangs in the firmament, a mighty globe of glowing red, as seen from other worlds a ruddy star, which, through rapid cooling, becomes visibly obscured, and, from the formation of everywhere surrounding scoriæ, immersed in deep night,"—a termination of which it may be said that, whatever its intrinsic probability, no reader need look forward to it with the slightest personal apprehension. And were that resplendent body, as Kepler in the exuberance of his imagination believed, the abode of glorious spirits, they might perhaps be supposed to smile at all such anticipations as utterly foreign to the unsearchable designs of the All-wise Creator.

And yet we may not forget that there have been, from time to time, mysterious warnings among the innumerable suns that have their abode in the far depths of space, and we are reminded by no process of argument, but by the evidence of our senses, how untrue it is that "all things continue as they were from the beginning of the creation." The certainty of strange and wonderful catastrophes of outburst or extinction has come to our knowledge, though perhaps only after centuries; or it may have been ages, of the transmission of the recording light: and similar events, to be recognised only by long-distant generations, may be in progress at the present hour. We know very

little of the history of the universe, and it becomes us well to speak of such possibilities with caution and reverence. Meanwhile we owe a debt to all who will aid us in the attempt to gratify a very natural curiosity, and to our author among the rest. Some portion of his hypothesis does not come before us for the first time. La Hire in very early days entertained the notion of opaque bodies floating in a fluid mass and occasionally appearing on its surface; and the conclusions of Gautier were very similar as to a partial solidification of metal in fusion; but we must bear in mind that it is only for the diffusion of hydrogen through a liquid envelope of iron that our author claims originality. His ideas are expanded and enforced by so much elaborate reasoning as at any rate to deserve perusal, if they do not succeed in producing conviction. As to this point we may freely confess that the author is more sanguine than ourselves. Some of his arguments are well worthy of attention; but the general character of the treatise is that of an ingenious piece of special pleading, one-sided, but fair and honest in its self-persuasion. A few omissions and mistakes might be pointed out, but they do not impair his argument. The weakness of this, as our readers will have already perceived, lies in the magnitude of some of its assumptions. It might indeed be said that the same objection lies against each of the more commonly received theories; and to this it can only be replied that, though similar in character, it differs in amount; and that the value of any attempt at explanation must be estimated in the inverse ratio of its unproved demands upon our assent.

T. W. WEBB

#### THE EARTHQUAKE

IN a previous notice (p. 17) brief mention was made of the more obvious conclusions which follow from a consideration of the observed effects of the earthquake of April 22. Mention was also made of some points upon which further knowledge would be of value, notably as to the result of the earthquake upon wells and springs. Mr. De Rance's letters give important information upon this matter.

The measurements of the water in wells at Colchester and Bocking prove that the level of the water has risen seven feet in the former case and from twenty to thirty inches in the latter case. These facts, and also the curious instance of water spouting from the ground at East Mersea, are quite in accord with what frequently occurs during earthquakes. Mr. Mallet says:—"Fissures containing water often spout it up at the moment of shock. Wells, after the shock, alter their water-level, and sometimes the nature of their contents; springs become altered in the volume of water they deliver. . . . It is important to observe whether any changes of level of water in wells take place *prior* to earthquakes. Statements to this effect have frequently been made, but as yet stand much in need of confirmation."

Dr. Taylor's observations that the new and often slightly-built houses have generally suffered less than the old and more solid structures is scarcely what one would have expected. In districts much subject to earthquakes the houses are generally built in such a manner that they yield readily to the vibration, and so mostly escape serious damage. Mr. Mallet indeed believes that if this custom were enforced very little damage would be done. As regards larger and more important structures, the question is not so easily settled; and Messrs. D. and T. Stevenson, in constructing the lighthouses of Japan, employed a peculiar and ingenious contrivance for guarding against the effects of earthquake shocks: this was to interpose a break in the rigid part of the building, and so to prevent the propagation of the shock. Mr. D. Stevenson, in describing this, says:—"The plan I propose for this purpose, which may for brevity be termed an *aseismic joint*, is

the introduction of spherical balls of bell-metal working in cups of the same material placed between two platforms, the lower cups being fixed to beams forming the foundation, and the upper cups being fixed to the lower beams of the superstructure, thus admitting, within a limited range, free

motion of the upper over the lower part of the building." The cost of this was about 90% for each lighthouse.

This plan had some disadvantages: high winds, for instance, gave as much free motion to the upper part as a slight earthquake would do; and there was also consider-

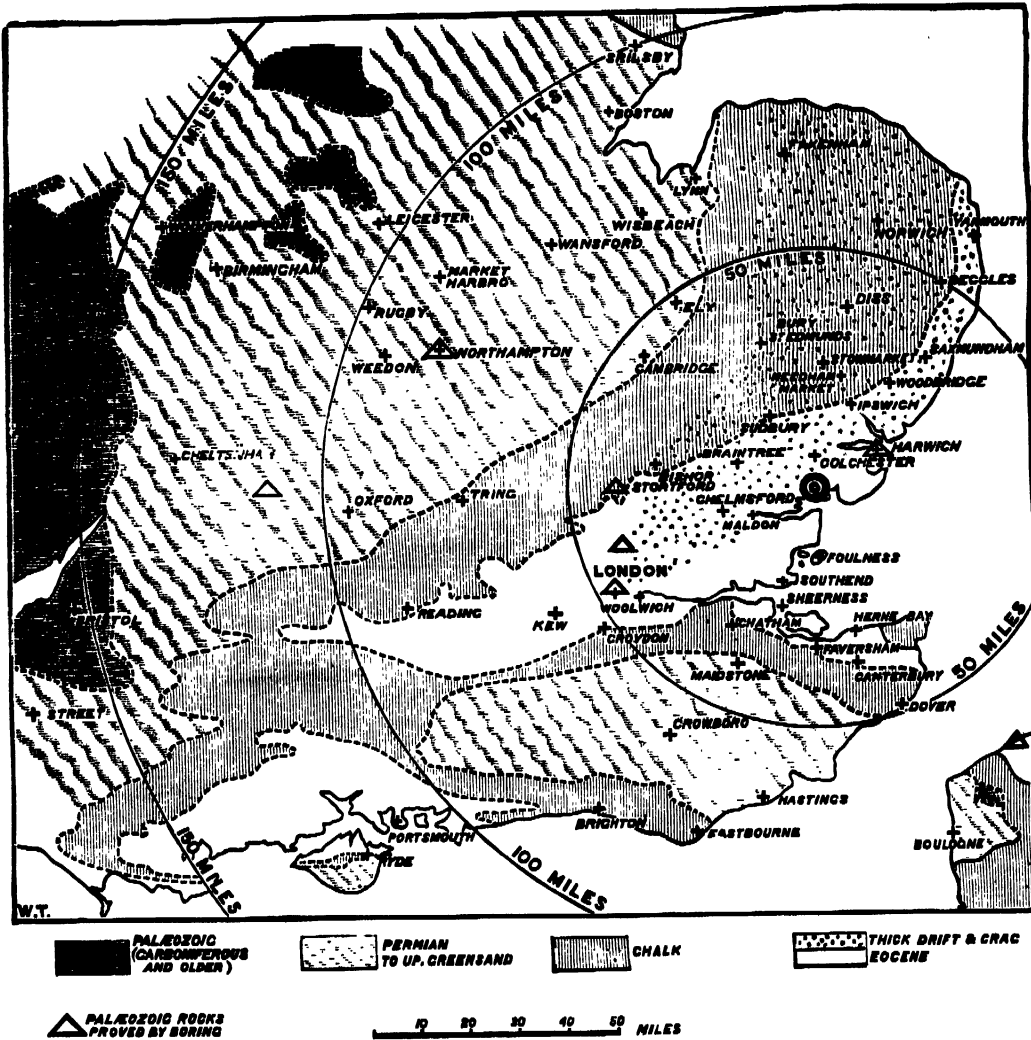

Map of the Earthquake of April 22, 1884. N.B.—The places marked are those at which the shock was felt. In the East of England only the more important of such places are marked.

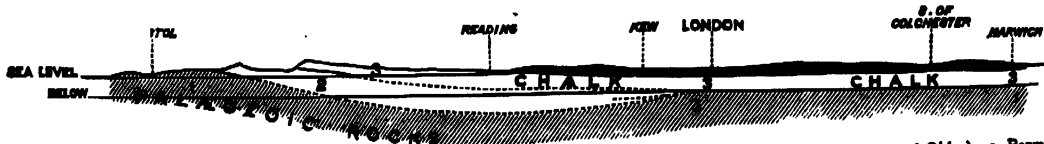

Section from Bristol to Harwich, showing the probable range of the Palaeozoic Rocks. 1, Palaeozoic Rocks (Carboniferous and Older); 2, Permian to Upper Greensand; 3, Chalk.

able movement of the lights during cleaning. The lighthouse-keepers, therefore, screwed up the metal plates, so that when an earthquake came sufficiently powerful to test the value of the plan, the structure was rigid and the glasses were broken. This plan was afterwards abandoned, and Mr. R. H. Brunton adopted the plan of con-

structing the lighthouses with "great weight and solidity, thereby adding to their inertia and checking the oscillation." Mr. W. Lloyd, from his experience in South America, believes that the more solid the structures the better they resist earthquake shocks. Mr. Woods, on the other hand, found that in Peru lightly-built structures of

iron were unharmed by earthquake shocks which did enormous damage to other buildings. This apparent contradiction may perhaps be explained by supposing that a lightly-built structure would give to every movement, and a very massively-built structure would resist such movement; either would bear a considerable earthquake shock unharmed, but buildings of intermediate resisting power would be destroyed.

Upon the twisting motion often noticed in earthquakes, and especially referred to by Dr. Taylor as observed at Langenhoc, Peldon, Fingrinhoe, and Abberton, much difference of opinion has existed. From the time of Aristotle it has been commonly attributed to a vorticose movement of the earth's surface at the part affected. The effects produced seem at first quite to accord with this explanation, as when in Japan a chimney ten feet high, and two feet by three, is broken in two, the upper half being twisted diagonally round without other fracture or displacement; or when, at Mendoza, a church tower has its lower story uninjured, its middle story turned through an angle of nearly 90°, and its highest story thrown completely over. But Mr. Mallet, who recorded similar cases in the Neapolitan earthquake of 1857, denied that this is in any case the correct explanation, and he believed that the twisting is best explained by resolved motions, due to the transit rectilinearly of the shock.

As regards the range of the recent earthquake very little more is known than was recorded during the first few days after the shock. The most important new fact is that mentioned by Dr. Prince of the shock being observed at Crowborough in Sussex; this proves that the Wealden area was affected, although the shock must have been very slight. Probably if the Palæozoic rocks were as near the surface there as was once hoped the shock would have been more distinctly felt.

There can now be little doubt that the origin of the shock was vertically under West Mersea or thereabouts, and that the wave must have travelled in all directions away from that area, but not necessarily with equal force and rapidity in all directions. The observations as to the direction of motion generally agree with this view; but in the neighbourhood of London there are some curious differences. The observations in London itself generally give an east and west direction, whereas some on the north side of London appear to point to a more north and south direction.

No observations are recorded of the connection of the earthquake wave with minor details of geological structure, such as the outcropping of certain hard or soft beds, or with lines of fault. The only instance of the latter kind known to me is at St. John's, near Greenwich, where the shock was felt very close to a fault, well exposed in the railway cutting just west of St. John's Station. But another and perhaps better explanation is that the shock was there felt by an invalid lying quietly in bed, and very sensitive to movement.

In the map here given, an attempt has been made to mark the positions of all places at which the shock was felt, so far as can be learnt from published accounts; but in Essex, Suffolk, and North Kent only a few of such places could be marked. By marking the outcrops of the older rocks (Carboniferous and earlier), the possible connection of these with the travel of the earthquake wave may be seen. This is made clearer by the section. The position of the Palæozoic rocks is known at Harwich and London; there is some uncertainty as to their position under Reading and Colchester, but for the purpose intended, and regard being had to the depth at which the shock must have originated (certainly far within the Palæozoic rocks), the line drawn is sufficiently near the truth. We can see how the shock can have been propagated through the hard Palæozoic rocks and been felt where these are bare or thinly covered with newer rocks, whereas through the thick and softer Secondary and Tertiary rocks the wave might travel a

shorter distance. Possibly also this section may suggest an explanation of the double shock which was sometimes recorded: the first would be that travelling quickly through the hard Palæozoic rocks, the second that propagated more slowly through the softer overlying newer rocks.

W. TOPLEY

#### VOLCANOES ON THE SHORES OF LAKE NYASSA, AFRICA

DR. LAWS, on his return to Europe from the mission station at the north end of Lake Nyassa, passed by Naples, where I had the pleasure of meeting him. Amongst other information that I gleaned was that pumice-stone is very abundant in the locality above-mentioned and on the shores of the lake, where pebbles of coal are also met with. He also informed me that many of the rocks had a striking resemblance to the volcanic tufas around Naples. Dr. Laws happened to have a specimen of pumice, which he kindly placed at my disposal.

The specimen forms about two-thirds of a flattened ellipsoidal pebble of about  $1\frac{1}{2} \times 1\frac{1}{4} \times \frac{3}{4}$  inches in diameter. It is of a dirty buff colour, darker in spots, the result of oil stains in packing. The grain is fine; there are very few large cavities, which are multilocular, with smooth-walled spheroidal-shaped alveoli. The specific gravity of the mass is light. The characters indicate great homogeneity of material, only a moderate amount of dissolved water in the original magma, and an eruption of true paroxysmal type. A few minute crystals of sanadin are discernible with the naked eye, and rarely also a small black spot, which we shall see to be pyroxene.

It is easily sectionised, and when examined under a low power, shows a remarkable uniformity of size in the pores. Those near and opening upon the surface contain a few diatoms indicating the action of water as the cause of the pebble-like form.

The magma is a perfect glass of light straw-colour. Scattered through it are a few small irregular crystals of sanadin, fairly clear, but of irregular boundaries in many cases, as if they had wavered between crystallisation and fusion. A few are twinned on the Carlsbad type, and a few also present fine wavy striation parallel to their longer axis. At one spot were two or three sanadin crystals inclosing dark brownish-green pleochroic microliths, too irregular to measure the angle of extinction, but which looked very much like amphibole. There were to be seen a few well-formed crystals of pyroxene of light pea-green colour, quite free from pleochroism, and with characteristic crystalline boundaries and cleavage, with absence of inclosures. In the immediate neighbourhood of the large pyroxene crystals were a few microliths of the same mineral; the average angle of extinction was 49°, and ranging within narrow limits. No other "formed" materials were discernible except a mass of dirty brown, dusty matter involved in a group of sanadin crystals, which might be magnetite. The whole character of the specimen is strikingly like some of the basic pumices of Monte Somma, and almost indistinguishable from some specimens of Phase VI. Period 1 (*Quart. Journ. Geol. Soc.*, January 1884).

I regret that for want of a balance I have not been able to analyse the specimen, though I am inclined to place it amongst volcanic rocks containing less than 55 per cent. of silica.

The specimen itself is in no way remarkable, but it is interesting as indicating the existence of continental volcanoes some hundreds of miles from the seashore, although in the immediate neighbourhood of a great lake, as also an additional grain of acquaintance with the geology of the mysterious interior of the "dark continent."

My informant has promised to forward me a collec-

tion of rocks on his return to Lake Nyassa, which will give us a more detailed knowledge of that interesting volcanic and also coal-bearing region.

Naples, April 26

H. J. JOHNSTON-LAVIS

### NOTES

TWO eminent chemists died on Monday, both born in the same year—1817—M. Karl Adolph Wurtz and Dr. R. Angus Smith, F.R.S. M. Wurtz, who was a pall-bearer at the funeral of Dumas, is stated to have died from the bursting of a blood-vessel; he was a candidate for the vacant post of Perpetual Secretary to the Academy of Sciences. Dr. Angus Smith had been in failing health for some time. A detailed account of the careers of both chemists we must postpone till next week.

THE Council of the Royal Geographical Society have selected the following travellers for honours:—Mr. A. R. Colquhoun, for his travels in China, and Dr. Julius von Haast, for his systematic exploration of the southern island of New Zealand, the Royal Medals; Mr. W. W. M'Nair, the Murchison Grant; Mr. Emil Boss, the Bach Grant; Mr. W. O. M'Ewan, the Cuthbert Peek Grant; and Dr. Haast, Dr. Max Buchner, and M. Ferdinand de Lesseps as honorary corresponding members.

GERMANY has been prompt in acknowledging the services of its Cholera Commission; by acclamation a bill was passed by Parliament on Tuesday awarding a sum of 135,000 marks to Dr. Koch and his companions.

THE Council of the British Association have resolved not to entertain any more applications for membership prior to the Montreal meeting, when members and associates will be elected as at any other meeting. The number of tickets applied for is 722.

DURING the discussion in the Dominion House of Commons upon the vote of 25,000 dollars to defray the expenses of the meeting in Montreal in August next of the British Association, some further arrangements for the reception of members were made known. The excursion to the Rocky Mountains will, it is announced, take place on September 4, the members being taken by the New Canadian Pacific Lake route, where specially-constructed steamers make direct connection with the railway on each side. The excursion will probably occupy two weeks, and arrangements have been made that members of the party may not be put to greater expense than one dollar and a half per diem during the trip. Of the 25,000 dollars granted by the Dominion Parliament, 5000 will be used to defray the expenses of the meeting itself, and a fund is being raised to guarantee the Association against loss in connection with the publication of their proceedings. In addition to the Rocky Mountains excursion, excursions will be arranged to Ottawa, Quebec, and probably to Belœil Mountain, a locality of great geological interest. Active preparations are being made at Montreal, Toronto, and other places which will be visited, to give the members a duc reception. It has also been arranged by the Associated Atlantic Cable Company that social cable messages to and from the delegates and their friends shall be sent free of charge. This is regarded as a considerable contribution towards the success of the meeting in Montreal.

THE French Association for the Advancement of Science meets at Blois this year from September 4 to 11.

PROF. HUXLEY was examined on Tuesday before the Select Committee of the House of Commons on the Education, Science, and Art Departments. He stated that in his opinion greater attention should be paid in our public schools to physical science. The Endowed Schools Commission was appointed to a great extent on account of the general state of apathy which existed in connection with the endowed schools. There is a distinct provision that a certain proportion of marks should be given to

science and modern languages. The system, however, is not well carried out in the public schools; not more than two hours a week are given to science. There is no doubt, Prof. Huxley stated, that the Oxford and Cambridge School Examination Board Regulations tend to handicap science extremely. The examiners found their examinations on what is taught in the schools, and the schools found their instruction on the requirements of the examiners. He regarded the present system of education as wrong from top to bottom. The subjects on which most stress is laid are really luxuries, while those which are regarded as luxuries are really the most essential. The present system of education in the country shuts out young men from many employments for which they should be eligible, and tends to the employment of foreigners. Prof. Huxley thought that an influential Minister, with a seat in the Cabinet, might do a great deal to improve education. It would be his business to judge in what direction the educational system was tending, and to enforce on the educational bodies a modification of their system in the desired direction. He would give the Minister power to insist upon more time being given to science and modern languages.

THE Royal Society *conversazione* on the 7th inst. was well attended, and the exhibits, mainly connected with physical science, interesting. Mr. J. Wimshurst exhibited the continuous electrophorus. This instrument consists of two glass disks, revolving in opposite directions upon the same axis. To the outer faces of the disks radial metallic sectors are attached, which in their turn are touched by brushes of fine wire. It is self-exciting under almost any condition of atmosphere, parts freely with its electricity, and the current will not change its direction while the instrument is at work. In Room II. was shown a map of the earthquake in Essex (April 22, 1884), with photographs of damaged buildings. In Room III. Messrs. Elliott Brothers showed some electrical and magnetic apparatus, including a simplex repeater board, Wheatstone's transmitter, Wheatstone's perforator (new form), portable electric lamps, worked by Skrivanow batteries, the Kew Committee magnetometer, and a selection of electrical and other instruments. In the principal library was a compound magnet, with bifilar suspension, showing the change in total moment produced by dividing a magnet into short lengths, exhibited by Mr. R. H. M. Bosanquet. The magnet consists of eighteen pieces of hard steel which, fitted end to end, form a cylindrical bar. These can be placed in the suspension tray either as a bar, or dispersed as separate pieces. When placed together as a bar the moment is between seven and eight times as great as when the pieces are separated. The equilibrium position of the suspended tray is east and west. When a magnet is placed in the tray a deflection takes place towards north and south. The tangent of this deflection measures the moment, according to the ordinary principles of bifilar suspension. Mr. Hilger exhibited various spectroscopes and a  $\frac{1}{4}$ -inch achromatic object glass in a mount of new construction. A new photometer and Dworak's sound radiometer, were sent by Mr. Preece; and Hughes' magnetic balance, and Prof. Minchin's absolute sine electrometer, by Mr. Groves. An interesting apparatus for the generation and distribution of ozonised air, to be placed in the Hôtel-Kursaal de la Maloja, Upper Engadine, was exhibited by Dr. A. Tucker Wise. To render the air as pure as possible in this building, ozone is added to the internal atmosphere in connection with the general plan of ventilation. By means of valves this ozonised air can be turned into any room at the rate of from 60 to 100 cubic metres per hour for each occupant. The Rev. S. J. Perry exhibited a selection from the series of drawings of the solar surface made at the Stonyhurst Observatory from 1880 to 1884.

At the next meeting of the Society of Telegraph Engineers and Electricians, to be held on Thursday, May 22, at the Institu-



tion of Civil Engineers, Mr. W. H. Preece, F.R.S., will give a review of the work done by the Electrical Congresses of Paris, and will describe the new units determined upon.

THE Lord Lieutenant of Ireland has appointed the following Commissioners to inquire into the management of the Queen's Colleges and Royal University in Ireland:—R. P. Carton, Q.C., Mr. George Johnstone Stoney, F.R.S., Rev. Dr. Gerald Molloy, Rector of the Catholic University, Mr. Wm. Jack of Glasgow University, and Surgeon-General Marsten. Mr. N. D. Murphy, barrister, is appointed secretary.

THE Engineering Department of the Yorkshire College at Leeds is about to be considerably enlarged, to admit of more students at the classes, and towards this object Sir Andrew Fairbairn, M.P., and Sir John Hawkshaw have each contributed 1000*l*.

THE steamer *Alert*, one of the vessels to be engaged in the Greely Relief Expedition, sailed from New York on May 10.

THE eminent Swedish astronomer, Prof. H. Gylden, at present chief of the Stockholm Observatory, has been called to the Professorship of Practical Astronomy at Göttingen.

HERR AUGUSTIN GAMEL of Copenhagen has offered to despatch the *Dijmphna*, under Lieut. Hovgaard, to Franz-Josef Land in the summer of 1885, provided the Danish Government will contribute part of the expenses. No contribution will be accepted from foreign nations.

PROF. NORDENSKJÖLD has executed a detailed map of that part of the east coast of Greenland which he visited last summer, situated beyond Cape Dan, known from Lieut. Graah's journey. The peninsula on which the cape is situated he has named "King Christian's Island," and the harbour in which he landed "King Oscar's Harbour." Several other points have been named after celebrated Swedes and Danes.

THE Finnish Senate has petitioned the Czar that all members of the forthcoming hydrographical expedition in the Baltic, which will cost about 100,000 marks, shall be Finnish subjects, as so little progress with such labours seems to be made under Russian naval officers.

THE St. Petersburg Horticultural Exhibition and Botanical Congress, which was deferred last year owing to the coronation of the Czar, was opened on May 5. Mr. H. J. Elwes, F.L.S., of Preston House, Cirencester, was requested by the Science and Art Department to attend as the delegate on behalf of this country, and has been accredited.

MR. J. E. MARR, M.A., Fellow of St. John's College, Cambridge, has been appointed by the Council to lecture in geology.

A VIOLENT shock of earthquake, having an undulatory character, was felt at Spoleto at 8 o'clock on Friday night. The bells were set ringing and the clocks stopped. On Saturday, at 9.50, a slight shock in the direction of from north-west to south-east was felt at Cosenza, and at Paola a somewhat stronger shock was felt.

THE additions to the Zoological Society's Gardens during the past week include a Barbary Ape (*Macacus inuus* ♀) from North Africa, presented by the Countess of Craven; a Moufflon (*Ovis musimon* ♂) from Sardinia, presented by Col. Knox and the Officers of the 1st Battalion Scots Guards; a Common Raccoon (*Procyon lotor*, white variety) from North America, presented by Mr. F. J. Thompson; a Ground Hornbill (*Buceros abyssinicus*) from West Africa, presented by Capt. Rupert La T. Lonsdale; a Gold Pheasant (*Thaumalea picta* ♀) from China, presented by Mr. Frank Reed; two Peregrine Falcons (*Falco peregrinus*), European, presented by Lieut.-Col. Drummond Moray; two Alligators (*Alligator mississippiensis*) from the Mississippi, pre-

sented by Mrs. Andrade; a Green Tree Frog (*Hyla arborea*), European, presented by Mr. G. W. Obicini, F.Z.S.; twenty-one River Lampreys (*Petromyzon fluviatilis*) from British rivers, presented by Mr. T. E. Gunn; two Japanese Greenfinches (*Ligurinus sinicus* ♂ ♀) from Japan, two Common Crowned Pigeons (*Goura coronata*) from New Guinea, purchased; a Canadian Porcupine (*Erethizon dorsatus*), five Long-fronted Gerbilles (*Gerbillus longifrons*), two Variegated Sheldrakes (*Tadorna variegata*), bred in the Gardens.

### OUR ASTRONOMICAL COLUMN

THE APPROACHING RETURN OF OLBERS' COMET.—Now that the comet of Pons is drawing away from us, attention may be directed to another comet belonging to the same group as regards length of revolution, viz. that discovered by Olbers at Bremen on March 6, 1815, and last observed by Gauss at Göttingen on August 25. While it was still under observation an elliptic orbit was assigned by several astronomers, including Bessel and Gauss, who found the period between seventy and eighty years. Bessel subsequently discussed all the observations available to him, in a memoir published in the *Transactions of the Berlin Academy*, and, after determining the most probable orbit in 1815, he calculated the planetary perturbations to the time of ensuing return to perihelion, which he fixed to 1887, February 9, the effect of the perturbations being to accelerate the return by about 825 days.

An elaborate investigation of the elements of Olbers' comet and the effects of planetary attraction during the current revolution has been lately made by Herr F. K. Ginzel, of Vienna: it gained the prize of the Haarlem Society of Sciences, and was published by the Society in 1881. The author has availed himself of the improved values of the planetary masses and the other advantages which the astronomy of the last seventy years has placed in our hands, and has produced an interesting and skillfully-worked discussion of the motion of the comet since it passed out of view in 1815. He commences with a solar ephemeris, and coordinates X, Y, Z, founded upon Leverrier's Tables, and extending from March 4 to August 27, followed by an ephemeris from Bessel's ellipse of the comet's geocentric right ascension and declination and log. distance for the same period. In the next section the observations are as far as possible newly reduced, great care and trouble having been bestowed on the determination of the places of the comparison stars from the most reliable catalogues. It may be mentioned that there are observations at fourteen observatories, including Greenwich, where the comet was followed from May 22 to July 7; the series newly reduced are those of Berlin, Göttingen, Königsberg, Paris, Prague, and Seeberg. The necessary data for reduction of mean to apparent places of the comparison stars follow. The effect of parallax is applied to the comet's observed positions, and we have then the entire collection of deduced geocentric places, with the Berlin mean times of the observations.

In Bessel's investigation 187 observations were utilised; Ginzel has the greatly increased number of 346. The perturbations of Mercury, Venus, the Earth, Mars, Jupiter, Saturn, Uranus, and Neptune are next calculated for the period over which the observations extend; twelve normal positions are formed, and cleared of the effect of planetary attraction; then, in the usual manner, Bessel's elements are corrected by equations of condition, and the following definitive orbit for 1815 is obtained:—

Perihelion passage, 1815 April 26<sup>o</sup>30'146 Berlin M.T.

Longitude of perihelion ... ..	149 2 28	} M. Eq.
"    ascending node ... ..	83 28 46.7	
Inclination ... ..	44 29 50.8	
Eccentricity ... ..	0.93114958	
Log. perihelion distance ... ..	0.0837998	

Hence there results a revolution of nearly 74 years. The limits of uncertainty in this period are then examined, and found to be 75.68 and 72.33 years, and thus Ginzel concludes that the time of revolution given by the complete discussion of the observations of 1815 is in doubt to the extent of 1.6 year, or about a year and seven months.

In the next section of the memoir are presented the details of the laborious work involved in the calculation of the effect of planetary attraction during the actual revolution. The separate effect of each of the planets Jupiter, Saturn, Uranus, and Neptune

is assigned, and as regards the period, will be found from Ginzel's numbers to be—

				days
For Jupiter	...	...	...	- 799'16
Saturn	...	...	...	- 27'27
Uranus	...	...	...	- 7'53
Neptune	...	...	...	- 2'76

These figures show a total acceleration of 836'72 days, and hence the most probable epoch of the next perihelion passage is found to be 1886 December 16<sup>g</sup> G.M.T.

After remarks upon the physical observations made in 1815, and Bessel's observation of a nearly central occultation of a star by the comet on April 26, we have extensive sweeping ephemerides to facilitate the rediscovery at the approaching return; the places are given for every tenth degree of the sun's longitude, and of the true anomaly from - 120° to + 120°. In view of the uncertainty in the length of the comet's period, it may be well to commence the search in 1885.

In a supplement Ginzel examines the effect of the attraction of the smaller planets Mercury, Venus, the Earth, and Mars from March 1815 to February 1817; also the possible effect of a resisting medium: these are found to be too small to be worthy of consideration practically.

The elements assigned by Ginzel's investigation for the comet's next appearance are:—

Perihelion passage, 1886 December 16<sup>g</sup>338 Berlin M.T.

Longitude of perihelion	...	...	...	149 48 40'3	} M. Eq. 1887 <sup>o</sup>
"    ascending node	...	...	...	84 31 24'2	
Inclination	...	...	...	44 33 34'3	
Angle of eccentricity	...	...	...	68 31 3'0	
Mean daily sidereal motion	...	...	...	49''387785	
Log. semi-axis major	...	...	...	1'2375914	

To which corresponds a period of revolution of 71'843 years.

THE BUILDING OF THE ALPS<sup>1</sup>

II.

I PASS now to the section of the Simplon. On the southern side, deep in the glen of the Doveria, in the vicinity of the gorge of Gondo, we find a mass of granitoid gneiss, which recalls to mind that already described from the wildest portion of the upper valley of the Reuss. We may, I think, with confidence affirm that, whatever be the true nature of this rock, we are again touching the foundation-stones of the rock masses of the Alps. As we approach Alghy, the granitoid gneiss becomes more distinctly bedded and variable, a thin band of micaceous crystalline limestone is passed, and presently the more rapid ascent of the pass begins. Hence to beyond the summit we traverse, so far as can be seen, a great series of bedded gneisses, often coarse and even porphyritic, and of schists. The same are displayed in the crags of Monte Leone on the east and of the Rossbodehorn on the west. As shown in Prof. Renevier's valuable section, bands of crystalline dolomitic limestone, and of hornblende and garnetiferous schists occur in various places on either side of the Simplon road. Then, after descending about half way to Brieg, we strike the group of the Lustrous Schists, with the usual calcareous zone in the lower part. Prof. Renevier does not attempt to unravel the complexities of the strata which compose this portion of the central ridge of the Alps, and I feel that my slighter knowledge makes caution yet more imperative; but I think we are justified in asserting that we have evidence of an upward succession from the coarse granitoid fundamental gneisses, through more variable and bedded gneisses, to a group which recalls the garnetiferous schists, so finely developed on the southern flanks of the St. Gothard—a group also traceable in the upper portion of the Binenthal, though apparently far less perfectly developed. I think also that in the gigantic anticlinal of the Simplon we have evidence of sharp flexures on a great scale; and that these garnetiferous schists are only here and there preserved as the lower ends of infolded loops, so that the bulk of the *massif*, and, so far as I can tell, the actual summit ridges of the Rossbodehörner and Monte Leone, are composed of the bedded gneisses and strong schists, and perhaps of the more friable gneisses which have been already described in the mountains further to the east.

The mountains further west—the aspiring peaks which rise

<sup>1</sup> Lecture by Prof. T. G. Bonney, D.Sc., F.R.S., Prae.G.S., at the Royal Institution, April 4. Continued from p. 46.

around the two branches of the Visp, including among them some of the highest summits of the Alps, such as Monte Rosa, the Mischabelhörner, the Matterhorn, and the Weisshorn—offer indeed magnificent sections, but are full of difficulty. The fundamental gneiss, if I mistake not, is occasionally exposed—as, for example, in the rocks of Auf der Platte, at the base of Monte Rosa; and in parts of the Mischabelhörner blocks of coarse granitoid rock, often very porphyritic, which I refer to the same series, are brought down by the glaciers. There are also mica schists in plenty, such as the summit rocks of Monte Rosa and the backbone—if the phrase be permitted—of the Mischabel- and Saaser hörner, which I refer to the second zone already described—that of the bedded gneisses and strong mica schists. I have also seen specimens which closely resemble the garnetiferous schists of the St. Gothard district, but we meet in this district with a group of rocks which, if not altogether unknown before, appear now to be developed to an exceptional extent, and to become an important factor in the Alpine crystalline series.

Those who are familiar with the environs of Saas and Zermatt will remember how frequently schists or schistose rocks of a greenish colour occur. Sometimes they are interbedded with strong mica schists, or schisty quartzites, sometimes they form homogeneous masses of considerable extent. It is possible that some of the latter are intrusive masses of serpentine, to which subsequent pressure has given a schistose aspect; certainly there are occasional masses of coarse gabbro, which I think undoubtedly an intrusive igneous rock; but still, making all allowance for such cases, there is in this region a considerable mass of greenish hornblende, talcose, and serpentinous rocks which appears to be non-igneous in origin. We find these all around Zermatt. They form the ridges of the Gorner Grat and of the Hornli. They break out through the snows of the Breithorn and Little Mont Cervin, and constitute no inconsiderable portion of the mighty obelisk of the Matterhorn. The whole of that peak, according to the investigations of Sgr. Giordano—and with this my own recollections correspond—consists of an apparently regularly bedded series of serpentinous and micaceous schists, and of greenish gneisses, with the exception of a gabbro, developed on the western side, which I have no doubt is an intrusive rock. Can we trust these indications? Are we justified in assigning to this zone, with those characteristics, a vertical thickness of more than a mile? To these questions I can give at present no answer, further than to state that I am convinced that, notwithstanding the apparent regularity of the bedding in this and the neighbouring peaks, there are really great folds which patient scrutiny may at length unravel, and that this zone of greenish rocks—for which Alpine geologists have proposed the name of *Pietra Verde* group, appears to underlie the garnetiferous series of silvery mica schists, and either to overlie or replace the upper portions of the banded gneiss series which succeeds to the fundamental series.

I do not propose to weary you further with the details of Alpine sections, except that I must add a few words upon the extent of this remarkable series to which I have now introduced you. On the northern side of the watershed in the Swiss Alps, so far as I am aware, it is not generally strongly developed, except in certain localities in the southernmost of the three ranges which make up the whole chain, but in parts of the Tyrol it is well displayed. It borders—the mica schists sometimes dominating—the fundamental gneiss in the Oetzthal *massif*; it forms the peak of the Gross Glockner; it meets us on the Brenner Pass and elsewhere overlain by and folded up with rocks which, if my memory do not mislead me, are the equivalents of the Lustrous Schists of more western districts.

Again, it is finely developed, seemingly in succession to bedded coarser gneiss, in some of the peaks of the Bernina range, and it occupies a considerable tract about the heads of the valleys to the south. It may be traced, indeed, over a great zone, and with but slight interruption all along the southern slopes of the Alps, even to the south of the head waters of the Po, forming many of the grandest peaks in the Graian, Tarentaise, Maurienne, and Cottian Alps; and we find traces of it overlying the coarse granitoid series in the *massif* of the Alps of Dauphiné.

Sections, indeed, in the neighbourhood of Biella, according to Gastaldi and Sterry Hunt, exhibit the *Pietra Verde* group overlying the upper or more bedded portion of the great gneissic or basal series, and succeeded by the group of friable gneisses, described above as closely associated with the garnetiferous schists, in a manner that suggests an unconformity. Under ordinary circumstances we should not hesitate to admit

that there is considerable evidence in favour of this break, and some for one between the Pietra Verde group and the stronger gneisses and schists below; but in mountain regions we fear to trust our eyes. The evidence, however, in certain districts in favour of a break at the base of the Lustrous Schists is yet stronger. If I am right in regarding the Lustrous Schists as forming one group with the older part of the Bundnerschiefer of the Grisons region, and of the Thonschiefer of Von Hauer in the Eastern Alps, a study of the geological map will show that it is difficult to explain the relation of these beds to the underlying gneisses and schists without such an hypothesis. What I have myself seen in regard to the Lustrous Schists is strongly in favour of a great break in some localities. On the south side of the St. Gothard we have in the Val Piora the Lustrous Schists apparently in true succession with the representatives of the garnetiferous group of the Val Tremola, yet on the northern side, in the Ursenthal, the latter series is wanting, and the gneisses which underlie it appear to be immediately succeeded by the Lustrous Schists. This, however, might be explained by a complication of faulting and folding. What I have seen in the Binnenthal is harder to explain. At the head of the Hohen Glacier, just below the peak of the Ofenhorn, we have a coarse but bedded gneiss, which I should correlate with the series immediately overlying the granitoid gneiss so often mentioned as the lowest rock of all. Glancing towards the north, across the snowfield, we see this rock in the base of the Strahlgrat distinctly overlain by the Lustrous series, with its characteristic band of limestone or dolomite. This series swoops down for some 2000 feet, and we cross it in the upper basin of the valley below, while yet further down the valley I detected the characteristic garnetiferous schist, of which, however, there is no great development. If this be the result of faulting and folding only, it is certainly very remarkable.

But I must linger no longer over details. The passing time warns me that I must attempt briefly to describe the general process of the building of this great mountain group of Europe. I have, I hope, proved that the metamorphic rocks of the Alps, if we may trust mineral similarity and mineral and lithological sequence, are vastly older than the Carboniferous period, and that in this ancient series a certain succession may be made out. If we may reason from the analogy of other regions, we may assign to the whole of their latest group (the Lustrous Schists) an antiquity greater than the earliest rocks in which indisputable traces of organic life have been found. One point, however, I should notice before proceeding further. It might perhaps be said—it has indeed been said—that the crystalline schists and gneisses of the Alps are the result of the great earth movements by which the mountains were upraised, when heat and pressure changed mud into schists and felspathic sandstone into gneiss. I have shown you that we can trace a mineral succession in the crystalline series of the Alpine chain, and that some at least of these are earlier than the Carboniferous period; but I can add to the proofs that these great rock masses had assumed in the main their present mineral structure when these movements occurred. We meet with some rock masses whose structure is doubtless due to the pressure which they have undergone. This is the case with all cleaved rocks, as was lucidly explained twenty-eight years since by Prof. Tyndall in this very room. We meet also with schists, where, from the arrangement of the mineral constituents, we have good reason for supposing that they were developed when the rock mass was exposed to a pressure definite in direction. Here the lines of different minerals, which we believe indicative of an original structure in the rock, are often wrinkled; the more flaky minerals commonly lie with their broader planes parallel, but, notwithstanding this, there is no very definite cleavage in the rock mass, nor tendency to separate easily along the different mineral layers. Specimens of such rocks may be obtained in the Alps, but there are others in which the layers have evidently been crumpled up after the period of mineral change: the bands of quartz and felspar have been, as it were, crushed together, the flakes of mica are sometimes crumbled and sometimes twisted round into new positions.

The subject is a technical one, so I must ask you to accept my statement, without the long details of microscopic work on which it is founded, that the older Alpine rocks frequently testify to having undergone an extraordinary amount of crushing. In the middle of coarse gneisses, for example, streaks and thin bands of a mica schist may be found, which are not due to an original difference of materials, but to the fact that here and there the original rock has yielded to enormous pressure, and has been

crushed *in situ* into lenticular bands of rock dust, from which some new mineral developments have taken place. You may notice also in some regions, where you would classify the rocks at first sight as mica schists, that a close examination of the broken surfaces at right angles to what appear to be planes of foliation reveals a structure resembling a coarsish gneiss. The microscope shows that the rock is really a gneiss, somewhat crushed, and that the micaceous layers are of extreme tenuity—mere films, which do not seem to have been original constituents. The gneissic mass has been crushed, cleaved, and on the cleavage planes films of a hydro-mica have been developed. We cannot fail to be struck, when once our eyes have been opened to it, by the frequency of a slabby structure in the more central parts of the Alpine ranges, the surfaces of these slabs being coated with minute scales or films of mica. These are really records of a rude cleavage which has been impressed upon the more central and less flexible portions of the Alps during the great earth movements which they have undergone since they were first metamorphosed.

Thus in the building of the Alps our thoughts are carried very far back in the earth's history, far beyond the earliest strata of the Palaeozoic age. Under what conditions were these great homogeneous granitoid masses of the fundamental gneisses formed? They differ on the one hand from granites, on the other from the ordinary gneisses; from the former their differences are but slight, and of uncertain value, yet into the latter they appear to graduate. There is nothing like to them in any subsequent rock group, and, so far as our knowledge at present goes, they appear to be the records of a period unique in the world's history. This may well be. When the dry land first appeared, when the surface of the earth's crust had not long ceased to glow, when the bulk of the ocean yet floated as a vapour in the heated atmosphere, when many gases now combined were free, we can well imagine that the earliest sediments would be deposited under conditions which have never been reproduced. In the later schists, with their more frequent mineral changes, their distinct stratification, and their beds of quartzite and of limestone, we may mark the gradual approach to a more normal condition of things. Some, such as the Lustrous Schists, may indeed be contemporaneous with our earliest Palaeozoic rocks; but I confess that to myself the evidence appears more favourable to the idea that all are more ancient than the period which we call Cambrian, and that the majority are so I feel little doubt.

Supposing, then, that I am right in considering all the Alpine schists, even the Lustrous group, to be pre-Cambrian, we have a vast interval of time which has left no record in those districts of the Alps of which I have been speaking. It is not till we come to the Carboniferous period that we can identify any pages in the life-history of the earth. We are justified with regard to these in the following conclusions:—

That in the place of the Alps there was at that time an upland district, composed of gneisses and schists, in substantially the same mineral condition as they are at present, together with slaty beds in a comparatively unaltered condition, which district was fringed by a lowland covered by a luxuriant vegetation. Prior to this time, also, the metamorphic rocks of the Alps had been so far folded and denuded that the coarser gneisses were in many places laid bare, and contributed the materials which we now find in such beds as the Val Orsine pudding-stone. Whether there was a pre-Triassic mountain chain occupying some parts of the present Alpine region we cannot venture to say, but I think we may unhesitatingly affirm that there were pre-Triassic highlands.

After the close of the Carboniferous period, and anterior to the middle part of the Trias, there were volcanic outbursts on a large scale in more than one region of the Alps—notably in the district near and to the east of Botzen. After this commenced a period of subsidence and of continuous deposition of sediment. This seems to have begun earlier and to have been at first more rapid in the eastern than in the western area. Since in the former the Triassic beds are generally much thicker and more calcareous than in the latter, one is tempted to imagine that the eastern area quickly became a coraliferous sea, with an occasional atoll or volcanic island. Henceforward to the later part of the Eocene the record is generally one of subsidence and of deposit of sediment. Pebble beds are rare: the strata are grits, shales (or slates), and limestones. Whence the inorganic constituents of these were derived I cannot at present venture to suggest, but though conglomerates are rare, there are occasional indications that land was not very distant. In the eastern Alps, however,

the position of some of the Cretaceous deposits and the marked mineral differences between these and the Jurassic seem to indicate disturbances during some part of the Neocomian, but I am not aware of any marked trace of these over the central and western areas. The mountain-making of the existing Alps dates from the later part of the Eocene. Beds of about the age of our Bracklesham series now cap such summits as the Diablerets, or help to form the mountain masses near the Tödi, rising in the Bifertenstock to a height of 11,300 feet above the sea. Still there are signs that the sea was then shallowing and the epoch of earth movements commencing. The Eocene deposits of Switzerland include terrestrial and fluviatile as well as marine remains. Beds of conglomerate occur, and even erratics of a granite from an unknown locality, of such a size as to suggest the aid of ice for their transport. For the present I prefer, for sake of simplicity, to speak of the upraising of the Alps as though it were the result of a few acts of compression, though I am by no means sure that this is the case. Thus speaking we find that in Miocene times a great mountain chain existed which covered nearly the same ground as the present Alpine region of Mesozoic and crystalline rocks. To the north, and probably to the south, lay shallow seas, between which and the gates of the hills was a level tract traversed by rivers, perhaps in part occupied by lakes. Over this zone, as it slowly subsided—in correspondence, probably, with the uplifting of the mountain land—were deposited the pebble beds of the nagelfluë and the sandstones of the molasse.

Then came another contraction of the earth's crust; the solid mountain core was no doubt compressed, uplifted, and thrust over newer beds, but the region of the softer border land, at any rate on the north, was apparently more affected, and the sub-alpine district of Switzerland was the result. I may here call your attention to the fact that, whether as a consequence of this or of subsequent movements, the Miocene beds occur on the northern flank of the Alps at a much greater height above the sea than on the southern, and have been much more upraised in the central than in the western and eastern Alps. Further, between the Lago Maggiore and the south of Saluzzo, Mesozoic rocks are almost absent from the southern flank of the Alps, and the Miocene beds are but slightly exposed and occupy a comparatively lowland country. I think it therefore probable that the second set of movements produced more effect on the German than on the Italian side of the Alps, producing on the latter a relative depression. In support of this we may remark that the rivers which flow from the Alps towards the north or the west, start, as a rule, very far back, so that the watershed of the Alps is the crest of the third range reckoning from the north, and the great flat basin of the Po is the receptacle for a series of comparatively short mountain rivers. These also take a fairly straight course to the gates of the hills, while the others change not seldom from the lines of outcrop to the lines of dip of the strata—a fact I think not without significance. To this rule the valley of the Adige in the eastern region is an exception. May not this be due to the remarkable series of minor flexures indicated by the strike of the rocks (Mesozoic and earlier) immediately to the west of it, which probably influences the course of the Adda, and can, I think, be traced at intervals along the chain as far as Dauphiné? Be this as it may, it is obvious that the generally uniform east-north-east to west-south-west strike of the rocks which compass the Alpine chain is materially modified as we proceed south of the Lake of Geneva, changing rapidly in the neighbourhood of Grenoble from a strike north-east to south-west, to one from north-west to south-east. This subject, however, is too complicated to be followed further on the present occasion. I will only add that the singular trough-like upland valleys forming the upper parts of some of the best-known road passes—as, for instance, the Maloya—which descend so gently to the north, and are cut off so abruptly on the south, seem to me most readily explained as the remnants of a comparatively disused drainage system of the Alps.

It remains only to say a few words on the post-Tertiary history of the Alps. We enter here upon a troubled sea of controversy, upon which more than the time during which I have spoken might easily be spent; so you will perhaps allow me to conclude with a simple expression of my own opinion, without entering into the arguments. That the glaciers of the Alps were once vastly greater than at the present time is beyond all dispute; they covered the fertile lowlands of Switzerland, they welled up against the flanks of the Jura above Neufchatel, they crept over the orange gardens of Sirmio, and projected into the plains of

Piedmont. By their means great piles of broken rock must have been transported into the lowlands; but did they greatly modify the peaks, deepen the valleys, or excavate the lake basins? My reply would be, "To no very material extent." I regard the glacier as the file rather than as the chisel of nature. The Alpine lakes appear to be more easily explained—as the Dead Sea can only be explained—as the result of subsidence along zones roughly parallel with the Alpine ranges, athwart the general directions of valleys which already existed and had been in the main completed in pre-Glacial times. To produce these lake basins we should require earth movements on no greater scale than have taken place in our own country since the furthestmost extension of the ice-fields. This opinion as to the origin of the lakes is, I believe, generally held to be a heresy, but it is a heresy which has been ingrained in me by some twenty years of study of the physiography of the Alps.

## RECENT MORPHOLOGICAL SPECULATIONS

### I.—On Alternation of Generations

IT is more than sixty years since Chamisso pointed out that in *Salpa* a solitary asexual individual produced a chain of sexual individuals by budding, the viviparous eggs in these becoming in turn the solitary form. This he made his type of *Alternation of Generations*.

Since his time the definition of this peculiar method of reproduction has been narrowed, and the alternation of a series of individuals developed from an unfertilised egg, *i.e.* parthenogenetically, and one or more generations of sexually produced young is now called *heterogamy*; the term *metagenesis* has been invented for cases of alternation of sexual and gemmiparous generations.

Few instances can be cited where the study of a single genus has brought out so many points of interest as in the case of the pelagic Ascidian, *Salpa*. Two points in the history of this animal still involved in controversy are the first phenomena of embryonic development, and the mutual relationship of the two forms, the solitary individual and the colony that swim united in a chain.

As regards the former matter, the fate of the egg and the origin of the nutritive structure known as the placenta present great difficulties.

While W. K. Brooks (*Bull. of Museum of Comp. Zool., Harvard University, iii.*) believed that the egg undergoes a regular segmentation resulting in the formation of a gastrula, the cavity of which is divided by a transverse constriction into two chambers, one becoming the "placenta," Todaro (*Atti della R. Accad. dei Lincei, Rome, 1875, 1880*), on the other hand, stated that the solitary *Salpa* is the result, not of the division of the true ovum, but of the follicular cells inclosing it, and that during development, which takes place in a special part of the oviduct, the so-called uterus, a fold of the uterine wall forms a decidua reflexa comparable to that of mammals.

Salensky (*Zool. Anzeiger, 1881; Mittheil. d. zool. Stat. zu Neapel, Bd. iv.*) accounts for some of these conflicting statements by showing that great variety exists in nearly allied species, but he also declares that previous observations were often inaccurate. He states that the fertilised ovum divides but slowly, and only till the number of its segments reaches sixteen; and that probably it then entirely disappears, the tissues of the embryo being formed from a varying number of follicular cells. In some cases, as *S. bicaudata*, the so-called "decidua" is not represented. To this most exceptional method of development he gives the name of "follicular budding."

Now the theory that *Salpa* is an instance of the alternation of sexual and gemmiparous generations (*i.e.* of *metagenesis*), which was put forward by Chamisso and supported by the researches of Krohn, has been attacked by Brooks, who believes that the solitary *Salpa* (which he calls the *nurse*) is hermaphrodite, and gives rise by budding to a chain of males into each of which an egg migrates from the nurse. This view of course supposes that the solitary and chain forms belong to the same generation, they being, in fact, respectively the sexually and asexually produced offspring of one and the same solitary hermaphrodite *Salpa*. Todaro, on the other hand, states that, in the solitary adult, certain of the follicular cells surrounding the ovum give rise to no organs, but remain as cell-masses; and that from these the stolon is eventually developed. Hence the chain-*Salpæ* are developed parthenogenetically, and the nurse is an older sexless form, serving to nourish the sexually complete chain.

In Brooks' theory the main point is the migration of ova from the solitary individual into the individuals of the chain. In the light of a study of closely allied genera we find serious objections to this view. The fact on which it is chiefly based is that in the stolon when quite immature, we can trace the following organs: *a*, the outer tunic or epidermis; *b*, the pharyngeal cavity continuous with the pericardium; and *c*, two "club-shaped masses" of cells which lie on either side of *b*, and which soon resolve themselves into two lines of ova, one of which passes into the sinus system of each zooid. The discovery of undoubted ova in the stolon when the organs of the zooids are hardly indicated suggests, says Brooks, a migration from the nurse, which is therefore female.

Now we have, in direct opposition to this, an observation of Salensky's, that in some cases a second ovary is developed in the chain-Salpæ; and an indirect negation is entailed in the facts of gemmation in Pyrosoma, which is generally allowed to be a less modified form. Here we find the bud, when merely a protuberance on the mother, consisting of an epidermis derived from that of the mother, an "archenteric" cavity continuous with the endostyle, and a mass of cells which are derived directly from the "generative blastema." In this mass a single ovum can be seen quite as early relatively as in Salpa, and a second near the base supplies the secondary bud. Among the Composite Ascidians the case is similar; in Amourosium the buds are cut off from the post-abdomen and consist of outer tunic, mesentery (that is, continuation of pharynx backwards), and two lateral masses in which germinal vesicles shortly appear; in Didemnum, also, although Kowalevsky traced the buds back to a condition much more nearly resembling the segmenting ovum, still even here the single ovum is one of the most conspicuous of the primitive organs. It is apparent that there is in the Tunicata a tendency to form buds at the expense of the three primitive layers, and that some advantage attends the early development of ova. Whether this is to avoid the danger of self fertilisation or not, it reaches its limit in Salpa, where the rudiment of the ovary only consists of one fully developed ovum.

A similar modification in the time of development of the ova has taken place in some of the Hydrozoa (Hydrella, Sertularia, &c.), where, as Weismann has pointed out (Abstract and Review by Prof. Moseley in NATURE, vol. xxix. p. 114), the immature ova may be detected in the cœnosarc before even a rudiment of the bud appears.

The view which Todaro upholds seems also to be negated by Salensky's observations. For if the solitary Salpa is developed by follicular budding, it is not remarkable that some of the cells should form an organ corresponding to the generative blastema of Pyrosoma, *i.e.* giving rise only to the generative cells.

If Salensky's facts stand the test of further observation, we have in Salpa not only a unique method of development but a unique alternation of generations, namely, of gemmation and parthenogenesis, only comparable to that of the Aecidiomycetes among plants.

In Pyrosoma, the individual developed directly from the egg is the "cyathozoid," and this remains rudimentary, giving rise to the first four ordinary individuals by budding. There is here an alternation of a single asexual form with numerous generations produced by budding, each of which becomes hermaphrodite.

According to Ganin, we have a precisely similar case in the Composite Ascidians, for he states that sexual organs only develop in the individuals produced by gemmation.

In Doliolum the ovum, as before, gives rise to an asexual individual, but the lateral and median buds which arise on its dorsal stolon do not become sexually mature. The former only serve to nourish and protect the latter (Grobben, *Arbeit. der Zool. Inst. zu Wien*, iv.), from which a ventral stolon (stalk of attachment) grows out, bearing sexual individuals.

Outside the group of the Tunicata, true alternation of generation occurs in some Coelenterates, some Annelids, some Cestodes, and possibly in the Trematodes.

The alternation of hydroid and medusoid forms in many Hydromedusæ (Gymnoblasic and Calyptoblastic Hydroids and Hydrocoralla), all Acraspeda except Pelagia, and possibly Fungia among the Actinozoa, has been dwelt on in a previous paper in this journal by Prof. Moseley, and little range of modification occurs except in the extent of development of the medusæ.

In Cestodes the complicated metamorphosis has been mistaken for metagenesis, but it is only in those cases where the cystic worm develops a number of "heads" by gemmation, *e.g.*

*Camurus cerebralis*, *Tania echinococcus*, that metagenesis really occurs.

There is more uncertainty about the condition of affairs in the Trematodes, the ordinary view being that "the majority of the individuals of a complicated metamorphosis, but in the coexistence of larval budding (giving rise to Cercariæ or a second generation of Rediæ) with true sexual reproduction there is in addition a true alternation of generations" (Balfour, "Comparative Embryology," vol. i. pp. 172, 173). Grobben (*loc. cit.*), however, has lately stated that the Cercariæ are developed not from a mass of cells produced by internal budding in the Redia but from an ovum developed parthenogenetically. This would place these phenomena under the category of heterogamy.

Among the Polychætes there exist in Syllis, Myrianida, and Autolytus undoubted cases of alternation of generations; but these are not of recent discovery, having been described by Quatrefages, Krohn, and A. Agassiz about 1850-1860 (Balfour, *ibid.*, i. pp. 283, 284).

A general comparison of the various ways in which reproduction is carried on within the limits of alternation of generations may be easily made by a series of diagrams in which A represents the asexual individual developed from the fertilised egg, B the sexual zooid, and A B those forms which carry on both methods of reproduction.

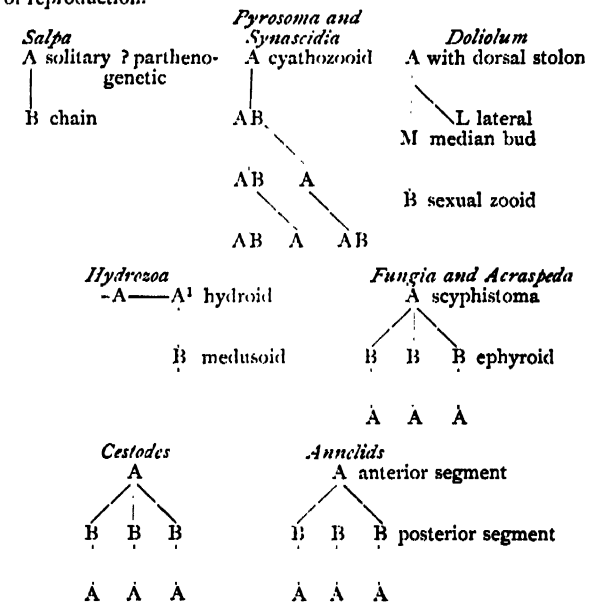

*Heterogamy*, which is not so common as metagenesis, has been the subject of very interesting memoirs by Adler and Lichtenstein. In a paper, "Ueber den Generationswechsel der Eichen Gallwespen" (*Jenaische Zeitschrift*, 1881), we have the result of Dr. Adler's work on "Gall-making Hymenopterous Insects," formerly described as belonging to eight different genera, namely *Neuroterus*, *Aphilothrix*, *Dryophanta*, *Biorhiza*, *Spathogaster*, *Andricus*, *Teras*, and *Trigonaspis*. He confirms the conclusions of Lichtenstein that certain species of the first four of these genera are stages in the life-history of certain species of the last four.

The gall wasps which in April leave the small round scale-like galls on the under surface of the leaves of the oak, have been described as *Neuroterus ventricularis*; but the parthenogenetic egg develops within a round soft "currant-gall" to a wasp named *Spathogaster baccharum*. The latter escapes in June, and differs from the *Neuroterus* in size, colour of the legs, and in the female in the number of joints in the antennæ. The eggs produced by the *Spathogaster* when fertilised develop within *Neuroterus* galls. A still greater difference exists between the two generations formerly called *Biorhiza renum* and *Trigonaspis crustalis*. *Trigonaspis* is 4 mm. long, winged, almost entirely black, with antennæ of 15 (♂) and 14 (♀) joints, while the *Biorhiza* is 1.5 mm. long, wingless, red-brown, and with 13 joints in the antennæ; the two forms live, moreover, in different kinds of galls. In all these cases the alternation is direct. But among

*Phylloxera quercus* (Balbiani) migrates from *Quercus ilex* to *Q. sessiliflora*.

*P. vastatrix*, from the leaf-galls to the root of the vine.

*Tetranaura rubra*, from galls on trunk of elm to roots of dog's grass.

*T. ulmi*, from elm-galls to roots of maize.

Other less perfect examples of heterogamy, such as *Cecidomyia* and *Ascaris nigrovirens*, are well known.

The current views concerning the probable origin of the phenomena of heterogamy and metagenesis may be roughly classed in two groups, one formulated by Leuckart and supported by Claus and Balfour, the other held by Salensky and Brooks.

Leuckart supposed that alternation of generations is a division of labour in regard to reproduction in which the two chief kinds of multiplication, sexual and asexual, are divided between different individuals and generations.

The other theory is that these phenomena are due to a modification of metamorphosis, Salensky also stating that "the connection between metagenesis and metamorphosis is much more easily seen in Tunicates than in other animals."

If in an animal undergoing a metamorphosis the larva acquired the power of producing other individuals by budding, we should have the larval form undergoing finally a change into the adult sexual form. At the same time it is obvious that this is not an indispensable condition; for the more individuals the larva produced the more incapacitated it would be for future sexual reproduction, so that in all probability there would soon be no development beyond the larval stage. W. K. Brooks, in a recent paper on the subject, alludes to a medusa, *Cunina*, the hydroid form of which is parasitic on the stomach of another medusa, *Turritopsis*. This hydroid produces medusæ by gemmation, but is itself finally modified into a medusa.

The contrast between this and the more usual case is thus:—

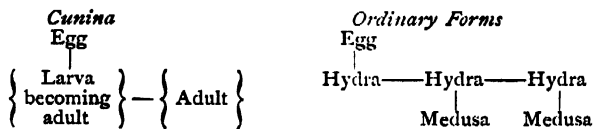

Similarly in the Cestodes it is usually allowed that the Echinococcus stage consists in the production of a number of individuals in the larval state, not of adults differentiated to meet diverse methods of reproduction.

In such a form as *Doliolum*, and indeed generally among the Tunicata, there seems to be more difficulty attending this view. Gemmation does not result in the production of individuals like the gemmating zooid, which by growth become unlike it. The cyathozoid, or the *Doliolum* with dorsal stolon, not only do not become sexual after a metamorphosis, but they give rise to the ascidiozooid, a form with ventral stolon in no way comparable to the adult of which it is the arrested larva. It seems here more probable that the existence of two methods of reproduction perhaps taking place at slightly different times has led to the selection of two sets of individuals, one better fitted for gemmation, the other for sexual reproduction. We must then suppose that any influence acting for the modification of one generation is transmitted not to the next but the next but one.

\* Huxley's distinction of true ova and pseud-ova applies to the whole.

### THE PARIS ACADEMY OF SCIENCES

THE yearly public meeting of this body was held on Monday May 5, under the presidency of M. Emile Blanchard. The proceedings consisted mainly of a detailed statement of the award made for prize essays or distinguished services rendered during the year 1883 to the various branches of the mathematical and natural sciences, useful arts, and industries.

In Mechanics the Extraordinary Prize of 6000 francs, established to encourage improvements of all sorts in the efficiency of the French Naval Service was divided, as in previous years, among several candidates. For his "Studies on Marine Engines," no in course of publication, M. Taurines received 3000 francs, M. Germain 2000, for his "Treatise on Hydrography," and Cap A. de Magnac 1000, for his "New Astronomic Navigation," published in 1877. The Montyon Prize, in the same department, was also divided, half going to M. Léon Francq, for his improvements in Lamm's steam traction engine, and half to Capt. L. Renouf, inventor of an instrument intended to simplify the observation of altitudes at sea, dispensing with the necessity of employing artificial horizons and enabling exact calculation to be made without stopping the vessel under sail or steam. M. Jacquemier, inventor of the kinemometer, dynamometer, and other useful appliances, gained the Plumey Prize; and M. Marc Deprez the Fourneyron, for his ingenious electric experiments on the Chemin-de-fer du Nord.

The Lalande Prize, founded by the illustrious astronomer to stimulate astronomical studies in France and abroad, was unanimously decreed to MM. Bouquet de la Grye, de Bernardières Courcelle-Seneuil, Fleuriais, Hatt, Perrotin, Bassot, Bigourdan and Callandreaux, chiefs of the various French expeditions sent to observe the transit of Venus on December 6, 1882. In this branch the Valz Prize was assigned to M. Stephan, Director of the Marseilles Observatory, and discoverer of about 700 nebulae, the positions of over 500 of which he has carefully determined.

For his extensive labours in the field of Experimental Physics M. Henri Becquerel was rewarded with the Lacaze Prize, the only one given away in this department.

In Chemistry the Jecker Prize was secured by M. Etard for his numerous researches and publications on organic chemistry. M. L. Cailliet obtained in this branch the Lacaze Prize for his important researches on the liquefaction of gases, and especially for his success in, for the first time, demonstrating the possibility of liquefying all the so-called permanent gases.

In Geology the Grand Prize granted by the Minister of Finance for the best geological description of any region in France or Algeria fell to M. Fontannes for his long and successful researches in the Tertiary Basin of South-East France, mainly embodied in his "Stratigraphic and Palaeontological Studies of the Tertiary Period in the Rhone Valley." An exceptional award of 2000 francs was also made in favour of M. Péron, author of an extremely important work entitled "Essay on a Geological Description of Algeria."

For his comprehensive monograph on Trichinosis, M. Joannès Chatin, Director of the Government Laboratory at Havre, obtained the Barbier Prize; and MM. G. Bonnier and L. Mangin the Desmazières Prize for their memoir on the "Respiration and Transpiration of Fungi," both in the department of Botany. In the same department M. Costantin was the successful competitor

for the Bordin Prize, awarded for the best solution of the following question proposed in 1879 by the Academy:—"Explain by direction observation and experiment the influence exercised by the environment on the structure of the root, stem, and leaves of vegetable organisms. Study the modifications undergone in water by land plants and those experienced by aquatic plants compelled to live in the air. Explain by direct experiments the special forms of some species of marine flora."

In Agriculture the Morogues Prize was gained by M. Duclaux for his great work on "Biological Chemistry," forming part of the "Chemical Encyclopædia" published under the direction of M. Fremy.

In Anatomy and Zoology the Grand Prize granted by the Minister of Finance for the best memoir on the "Histological Development of Insects during their Metamorphoses," as proposed by the Academy, was assigned to the young naturalist, Dr. H. Viallanes, for his "Researches on the Histology of Insects, and on the Histological Phenomena accompanying the post-embryonic Development of these Animals." In the same department the Bordin Prize was awarded to M. Grand'Eury, who, in two memoirs entitled "Carboniferous Flora of the Department of the Loire and Central France," and "On the Formation of Coal," deals satisfactorily with the "Botanical or Zoological Palæontology of France or Algeria," as proposed by the Academy to competitors for this prize.

Subjoined are some of the most important prizes proposed for 1884 and following years:

1884

**BORDIN:** General Study of Monge's Problem of Earth-works.

**FRANCEUR:** Works or discoveries useful to the progress of the pure and applied mathematical sciences.

**THE EXTRAORDINARY PRIZE OF 6000 FRANCS:** Studies tending to increase the efficiency of the French Naval forces.

**PONCELET:** Awarded to the author of the most useful work in advancing the pure or applied mathematical sciences.

**PLUMEY:** For improvements in steam-engines or any other invention contributing most to the progress of steam navigation.

**GRAND PRIZE OF THE MATHEMATICAL SCIENCES:** For any important advance in the theory of the application of electricity to the transmission of force.

**VAILLANT:** Fresh researches on fossils made in any region which for the last quarter of a century has been little explored from the palæontological standpoint.

**DESMAZIERES:** For the most useful work on the cryptogamous plants.

**GRAND PRIZE OF THE PHYSICAL SCIENCES:** On the mode of distribution of marine animals along the French seaboard.

1885

**DELMONT:** To engineers, for the best work connected with the Department of Public Works (Roads and Bridges).

**FOURNEYRON:** Theoretical and practical study on hydraulic accumulators and their applications.

**DAMOISEAU:** Review of the theory of Jupiter's satellites.

**GRAND PRIZE OF THE MATHEMATICAL SCIENCES:** Study of the elasticity of one or several crystallised bodies from the experimental and theoretical standpoints.

**BORDIN:** Researches on the origin of atmospheric electricity, and on the causes of the great development of electric phenomena in thunderstorms.

**L. LACAZE:** For the best treatise on physics, chemistry, and physiology.

**DELESSE:** For a work on geological sciences, or, failing this, on mineralogical sciences.

**MONTAGNE:** For important works on the anatomy, physiology, development, or description of the lower cryptogamous plants.

**GRAND PRIZE OF THE PHYSICAL SCIENCES:** Study of the intimate structure of the tactile organs in one of the chief natural groups of Invertebrates.

**BORDIN:** Comparative study of the freshwater fauna of Africa, Southern Asia, Australia, and the Pacific Islands.

**GAY:** Measure of the intensity of weight by the pendulum.

**CUVIER:** For the most important treatise either on the animal kingdom or on geology.

**PETIT D'ORMOY:** Pure or applied mathematical sciences and the natural sciences.

1886

**DE LA FONS MELICOCQ:** For the best treatise on the flora of North France.

1887

**CHAUSSIER:** For important works on legal and practical medicine.

1893

**MOROGUES:** For the most useful work in stimulating the progress of agriculture in France.

## SOCIETIES AND ACADEMIES

LONDON

**Royal Society,** April 24.—"On the Relation between the Electrical Qualities and the Chemical Composition of Glass and Allied Substances." Part I. By Thomas Gray, B.Sc., F.R.S.E., and Andrew Gray, M.A., F.R.S.E., Assistant to the Professor of Natural Philosophy in the University of Glasgow, and J. J. Dobbie, M.A., D.Sc. (Edin.), Assistant to the Professor of Chemistry in the University of Glasgow. Communicated by Prof. Sir William Thomson, F.R.S.

This paper describes some further experiments as to the relation between the chemical composition of glass and its quality of resistance to electrical conduction through its substance.

The experiments were made on specimens of flint glass of different densities, made by different makers, and varying considerably in chemical composition. The method of experimenting was that described in Mr. T. Gray's paper on the same subject (*Proc. R. S.*, No. 222, 1882). Each of the specimens, which were in the form of globular flasks of nearly three inches in diameter, was filled up to the bottom of the neck with mercury, and immersed to the same level in mercury contained in an outer vessel. A wire dipping in the mercury within the flask was connected, without touching the table or any of the supports, to one terminal of a sensitive galvanometer of high resistance, and the circuit completed, through a battery of about 120 Daniell's cells, from the other terminal to the mercury in the outer vessel. (The galvanometer was well insulated, and was the high resistance astatic instrument described in *Proc. R. S.*, February 14, 1884.) The outer vessel, containing the flask, was immersed in a sand-bath which was heated by a Bunsen burner to temperatures above 100° C., and readings of the galvanometer taken at different temperatures, with precautions to insure that there was no error due to leakage. By means of a suitable reversing key in the circuit, the direction of the electrification, which lasted in each case about three minutes, was reversed between each pair of readings. From the observed deflections, and the constants of the galvanometer and battery, which were frequently determined, the resistance of the flask at each temperature could be calculated.

The results of the electrical experiments and of complete analyses of the specimens of glass are detailed in the paper, and show that the specific resistance of glass of the kinds experimented on increases with the percentage of lead contained in the glass and also with the density; and that further, as had been previously found by different experimenters, the resistance diminishes as the percentage of alkali present in the glass increases. The best specimen experimented on contained over 40 per cent. of oxide of lead, and had a density of 3.141, and a specific resistance at 130° C. of  $8400 \times 10^{10}$  ohms between two opposite faces of a centimetre cube. From this result, as it has been found by these and former experiments that the resistance is halved, over a considerable range of temperature, by an increase of temperature of about  $8\frac{1}{2}$ ° C., the approximate resistance of the glass at other temperatures may be found.

The paper concludes with a short statement of further work which the authors have in hand with respect to the electrical qualities of glass and minerals.

**Linnean Society,** May 1.—Prof. P. Martin Duncan, F.R.S., vice-president, in the chair.—Messrs. Wm. Dennison-Roebuck and F. Newton-Williams were elected Ordinary Fellows, and Prof. E. Haeckel of Jena, A. Kowalevsky of Odessa, and S. Schwendener of Berlin, Foreign Members of the Society.—Mr. S. O. Ridley exhibited and made remarks on a series of drawings of sponges (and their spiculæ) and of Actinæ drawn from the living objects, as obtained in Ceylon and forwarded by Dr. W. C. Ondaatje, F.L.S.—Prof. Jeffreys Bell also drew attention to sketches of living Ceylonese Comatulids sent by Dr. Ondaatje as an earnest of progress in researches on the marine fauna of that coast.—Mr. T. Christy showed the leaf of a China grass rich in fibre useful for textile purposes.—Mr. R. Bowdler Sharpe read a paper on a collection of birds from

the Bahr-el-Ghazal province and the Nyam-Nyam country in Equatorial Africa. The collection had been made by Herr Bohndorff, who had spent several years in travelling over the region in question, and who brought a native Nyam-Nyam with him to the Society's meeting. Mr. Sharpe gave descriptions of and remarks on new species and on little-known birds, some twenty-seven in all, these being of considerable significance in relation to their faunal distribution. He pointed out that Herr Bohndorff had apparently crossed the boundary line of two faunas, for most of the Nyam-Nyam birds assimilated to those known from the Gaboon and Congo territory; whereas those obtained in the Bahr-el-Ghazal and Nilotic region were allied to the avifauna of North-East Africa and partly of the Senegambian area. Among new species cited are *Crateropus bohndorffi*, *Sigmatus griseimentalis*, *Mesopicus strictothorax*, *Centhinocurus intermedius*, *Pionias bohndorffi*, and others of equal interest.—Mr. R. A. Rolfe thereafter gave a communication on the flora of the Philippine Islands and its probable derivation. According to recent computation the phænogamic vegetation of the Philippines consists of 3564 species belonging to 1002 genera. Of 165 dicotyledonous orders 119 are represented, and of monocotyledons 25 out of 35; while the three gymnosperms, though nominally there, are poor in number. The proportion of vascular cryptogams to phanerogams is nearly one-eighth, chiefly ferns. Of these 52 species are not known elsewhere, a fact stamping individuality on the flora. The endemic phænogamic vegetation consists of 917 species, or a proportion of over one-fourth endemic, the dicotyledons showing one-third, the monocotyledons about one-tenth. The striking feature of the flora

the large number of endemic species and the very small number of endemic genera. The flora approximates to that of the Malayan region, but very many typical Malayan genera—those even occurring on the neighbouring island of Borneo—are wanting in the Philippines. Taking into account the dominant Australian and Austro-Malayan features, along with numerous other data and reasoning, Mr. Rolfe infers that Mr. Wallace's idea of extinction of genera by submergence will not alone explain the present peculiarities of the vegetation. Mr. Rolfe looks upon the Philippines as truly insular in the essentials of their natural history, this not so much through their being an early separation from the Asiatic continent which has had a dip under the sea, as from their being largely of volcanic and geologically of somewhat recent origin.—Mr. Geo. Brook read a preliminary account of the development of the weaver fish (*Trachinus vipera*). In this he mentioned that the eggs had been laid in his aquarium at Huddersfield, the fish themselves having been kept alive therein over two years. He drew attention to the fact of there being a vitelline membrane present in the eggs of this fish, as well as in those of the herring; in contradistinction therefore to what is stated to be the case in osseous fishes generally. He also particularly referred to the persistent nature of the segmentation cavity, which is pushed round the yolk-sac concurrent with the development of the embryo from the blastoderm; and that it does not entirely disappear until the yolk is absorbed. The circulatory system, according to Mr. Brook's researches, is very late in developing, no blood-vessels appearing until several days after hatching. In illustration of his paper he exhibited under the microscope preparations showing the segmentation stage, the embryonic shield, and commencement of keel, the early embryo, third day before closure of the blastopore, and fourth-day blastopore and Kupffer's vesicle, also at the eighth day, and the newly-hatched embryo.—Dr. J. Millar and Mr. J. Jenner Weir were elected auditors for the Fellows, and Mr. T. Christy and Mr. H. T. Stainton for the Council.

**Mathematical Society, May 8.**—Prof. Henrici, F.R.S., president, in the chair.—Mr. J. Brill was elected a member, and Prof. Luigi Cremona, of Rome, Foreign Member, was admitted into the Society.—Prof. Cremona communicated, in French, a paper entitled "Sopra una trasformazione birazionale, del sesto grado, dello spazio a tre dimensioni, la cui inversa è del quinto grado." Dr. Hirst, F.R.S., welcoming the author, spoke in commendatory terms of the value of the communication.—The following papers were also laid before the Society:—Motion of a network of particles with some analogies to conjugate functions, by E. J. Routh, F.R.S.—On a subsidiary elliptic function, by J. Griffiths.—On the homogeneous equation of a plane section of a geometrical surface, by J. J. Walker, F.R.S.—On the "symmedian-point" axis of a system of triangles, and on another line which is connected with a plane triangle, by R. Tucker.

**Chemical Society, May 1.**—Dr. W. H. Perkin, F.R.S., president, in the chair.—The following papers were read:—On benzoylactic acid and some of its derivatives (part i.), by W. H. Perkin, jun. For various reasons the author determined to examine carefully benzoylactic ether with special reference to reactions in which the ketone group takes part. Full details of the preparation of this body, which boils at 265° to 270°, and gives a violet coloration with ferric chloride, are contained in the paper. When boiled with dilute sulphuric acid, it splits up into acetophenone, alcohol, and carbonic anhydride. The barium, silver, copper, and lead salts were prepared. The paper contains an account of the preparation and properties of the following bodies: Benzoylactic acid, ethylbenzoylactic acid, diethylbenzoylactic acid, allylbenzoylactic acid, the corresponding ethers and their decomposition products, and an investigation of the action of bromine on allylacetophenone.—The composition of coal and canal gas in relation to their illuminating power, by P. F. Frankland. In this paper the author gives the results of a detailed examination of the gas supplied to some of the more important towns of the United Kingdom. The constituents which have been determined are the hydrocarbons absorbed by fuming sulphuric acid, carbonic anhydride, oxygen, nitrogen, hydrogen, carbonic oxide, and marsh gas. The results are compared with previous analyses in 1851 and 1876.—On selenium sulphoxide; on the reaction between hydrogen chloride and selenium sulphoxide; on selenium selenochloride, by E. Divers and Masachika Shimosé.—On a new form of pyrometer, by T. Carnely and T. Burton. This consists essentially of a coil of copper tube, which is placed in the furnace, oven, &c.; through this coil flows a constant current of water; the temperature of the oven is estimated by the difference between the temperature of the water as it flows into and issues from the coil.—On fluorene, by W. R. Hodgkinson. During the fractional distillation of fluorene the formation of an orange-red substance was noticed; this seemed likely to be an oxidation product, and in the present paper the author gives an account of his attempt to isolate this body, which is rendered extremely difficult, as the substance decomposes when distilled in a vacuum, and is equally soluble with the hydrocarbons which accompany it.

**Institution of Civil Engineers, April 22.**—Sir J. W. Bazalgette, president, in the chair.—The paper read was on the comparative merits of vertical and horizontal engines, and on rotative beam-engines for pumping, by Mr. Wm. E. Rich.

#### EDINBURGH

**Royal Physical Society, April 23.**—Dr. Ramsay H. Traquair, F.R.S., president, in the chair.—Mr. Hugh Miller, of H.M. Geological Survey, read a paper on boulder glaciation and striated pavements, an abstract of which was given in these columns on May 1 (p. 23).—The President gave an outline of a paper by Mr. J. T. Richards, on Scottish fossil cycadaceous leaves contained in the Hugh Miller collection.—Mr. J. R. Henderson exhibited various mollusks and zoophytes from the Firth of Forth.—Mr. Henry Gunn, A.R.S.M., contributed a paper on the silver districts of Colorado (Leadville and San Juan). In the first portion of the paper, which dealt with the Leadville deposits, the author pointed out that within a limited thickness of from 700 to 1000 feet, typical representatives of Laurentian, Cambrian, Silurian, and Carboniferous rocks were to be found, and also indicated the influence which intrusive rocks had in the economic geology of the district, inasmuch as all the deposits occurred at the contact of the quartz porphyry with the limestones. Specimens illustrative of the ores mined in the district were exhibited, also some possessing unusual associations of mineral, a specimen showing granules of free gold in hard carbonate of lead attracting much attention from the fact that it was the only specimen ever discovered in the district exhibiting this association. Mr. Gunn exhibited specimens of tellurium ores of remarkable beauty, and a sample of zinc blende mined in large quantity in Pitkin County, which, contrary to the opinion generally held by miners, contained large quantities of silver. The second portion of the paper dealt with the San Juan district, and after indicating the peculiar disadvantages under which this district laboured for the first few years of its existence, proceeded to describe the geology of the district, which, he states, to be Trachyte overlying rocks of Carboniferous and Devonian age. The mineral is found in true fissure veins of great width, chiefly composed of quartzose matter, but usually carrying one or more gray streaks from two to six feet wide, composed of



galena, fahlert, and sulphurets of silver and gold. Some of the mines produce beautiful filaments of native silver, and one of the specimens showed a very unusual association, viz. fine filaments of silver on gray copper.—The Secretary (Robert Gray, V.P.R.S.E.) exhibited a specimen of the Calandra lark (*Alda calandra*) from the neighbourhood of Madrid, showing a peculiar malformation of both mandibles, which seemed to render it impossible for the bird to pick up its food. The specimen had been sent to him by Dr. A. C. Stark, and is to be deposited in the Edinburgh Museum of Science and Art.—Mr. Gray also reported the occurrence of at least three instances of the stock dove (*Columba oenas*) in Roxburghshire, and made some remarks on the distribution of the species in the border counties. This bird has now been found to be a regular visitor to the counties of Berwick, Dumfries, and Roxburgh, in all of which it breeds.—Mr. Harvie-Brown, F.R.S.E., F.Z.S., exhibited, with remarks, a specimen of the black redstart (*Ruticilla titys*, Scop.), taken last month on the Pentland Skerries, Pentland Firth. The specimen was a male adult, and is said to be the fifth of the species recorded in Scotland.

**Mathematical Society**, May 9.—Dr. Thomas Muir, F.R.S.E., president, in the chair.—Prof. Crum Brown delivered an address, interesting alike to mathematicians and to chemists, on the hypothesis of Le Bel and Van't Hoff.—Dr. Muir gave a preliminary account of a treatise on Determinants, published in 1825, and unknown to all writers on the history of the subject.

## DUBLIN

**Royal Society**, April 21.—Section of Physical and Experimental Science.—Arthur Hill Curtis, I.L.D., in the chair.—Notes from the Physical Laboratory of the Royal College of Science, by Prof. W. F. Barrett.—On the local heliostat, by G. Johnstone Stoney, D.Sc., F.R.S. This instrument was designed by the author many years ago, and made for him most satisfactorily by Messrs. Spencer and Sons, opticians, of Dublin, who have since constructed several reproductions of it for physicists at home and abroad, at the suggestion of one of whom it is now described. The instrument is in some degree a modification of Gambey's heliostat, but it differs from that apparatus by being simpler in its details, sturdier, easier to use, and cheaper. These advantages are gained by sacrificing the generality of Gambey's instrument and providing only for stations within a limited range of latitude, usually about 10°, which, for example, enables one instrument to be used anywhere within the British Islands. Hence it has been called the local heliostat. The adjustment for latitude is of the simplest kind. After it is made, the instrument is to be levelled, and an arrangement based on the principle of the sun-dial enables it in about half a minute to be placed in the meridian. A polar axis is driven by a common clock at the rate of one revolution in twenty-four hours. To the upper end of this axis an arm is jointed, which, by a simple contrivance, can be pointed towards the sun, and which the clockwork, while in action, will then cause to follow that luminary. This arm trammels the mirror in the same way as in Gambey's instrument; and the reflected ray continues in the direction of a bar which can be placed in any azimuth and can be inclined up or down within reasonable limits. The direction of this bar, and with it of the reflected ray, can be readjusted, if necessary, in one or two seconds without disturbing the rest of the apparatus. The local heliostat has hitherto been made with mirrors about six inches by three for use in physical laboratories, but the design has been rendered so simple that it could be made at small cost with a mirror as large as a toilet glass, and driven by a cheap common clock. This would furnish an instrument which might be employed in physiological experiments on plants, in photography, and for any other purposes in which a large sunbeam in a fixed direction would be useful.—Dr. C. E. Fitzgerald exhibited Mr. P. Smith's model illustrating the conjugate movement of the eyes.

**Section of Natural Science**.—V. Ball, M.A., F.R.S., in the chair.—The following papers by D. Sharp, M.B., were communicated by Prof. W. R. McNab, M.D.:—(1) Descriptions of new genera and species of Hawaiian Coleoptera; (2) Catalogue of Hawaiian Coleoptera, with localities, distribution, and habits; (3) Topographical table of Hawaiian Coleoptera, with summaries, generalisations, and comments.—Prof. A. C. Haddon, B.A., F.Z.S., on the generative and urinary ducts in Chitons. The author discussed the various views as to the nature of the urinary ducts in Chitons. His own investigations supported Sedgwick's account as opposed to Haller's, and an oviduct was proved to

exist in *Ch. (Trachydermon) ruber*, Linn.—Notes on some of the Irish crystalline iron ores, by G. H. Kinahan, M.R.I.A.—Addi-

ing to phenomena ..... August 22 to 24, while the *Medea* was in the Sunda Straits. These embraced electrical effects, showers of sand and gravel, &c. At 2 p.m. on the 26th Capt. Thomson heard the first explosion; others succeeded every ten minutes. This geyser-like regularity was substantiated by all accounts received by the author. A column of dust arose to the westward immediately after the first explosion. Two observations enabled the height of this column to be computed. One gave seventeen, another twenty-one miles. The last included some doubtful factors, the observation being made three hours after first explosion. Further examination of the dust and pumice revealed hematite in thin blood-red flakes. The feldspars seemed divisible into two groups depending on optical and structural differences. Pyrites occurred not alone as an inclusion in the feldspars but also in the hypersthene. Optical tests rendered highly probable the presence of a triclinic pyroxene.

## MANCHESTER

**Literary and Philosophical Society**, March 4.—H. E. Roscoe, F.R.S., president, in the chair.—A paper was read on the production and purification of gaseous fuel for industrial purposes, with the results of several large applications of a system, by W. S. Sutherland.

March 18.—H. E. Roscoe, F.R.S., president, in the chair.—Notes on the meteorology and hydrology of the Suez Canal, by Dr. W. G. Black, F.R.Met.S.

## VIENNA

**Imperial Academy of Sciences**, April 24.—F. von Hochstetter, fifth communication to the seventh report of the Prehistoric Commission; on the tumuli at Froeg, near Rosegg (Carinthia).—K. Zulkorosky, on the aromatic acids as dye-forming matters.—W. Stephanic, on rotation of the moon.—T. Unterweger, on the aurora borealis.—T. Habermann and M. Hænic, on the action of cuprum hydroxide on some sugars.—F. Berger, on the preparation of phenyleyanide.—E. Spiegler, contribution to a knowledge of the euxanthone group.—Contribution to a knowledge of diphenylglucetoxin, by the same.—T. von Hepperger, on the position and figure of isochrones in comets' tails.

## CONTENTS

	PAGE
Daniell's "Physics" . . . . .	49
Recent Chemistry . . . . .	51
Letters to the Editor:—	
Reply to Mr. Grubb's Criticisms on the Equatorial Coudé of the Paris Observatory.—M. Lœwy . . . . .	52
Dust-Free Spaces.—Edw. W. Serrell, Jun.; Prof. O. J. Lodge . . . . .	53
The Supposed Volcanic Dust Phenomena.—Thos. Wm. Backhouse . . . . .	54
Pons' Comet.—A. S. Atkinson . . . . .	55
Snow and Ice Flora.—Prof. Julius von Haast . . . . .	55
The Rotation Period of Mars.—W. F. Denning . . . . .	55
"The Electrical Resistance of the Human Body."—Dr. W. H. Stone; Prof. A. E. Dolbear . . . . .	56
Instinct in Birds.—Wm. Brown . . . . .	56
Watt's "Inorganic Chemistry."—Dr. H. Watts . . . . .	57
The Recent Earthquake.—C. L. Prince; C. E. De Rance . . . . .	57
Notes on Earthworms. By Prof. T. McKenny Hughes, F.R.S. . . . .	57
The Low Barometer of January 26, 1884 . . . . .	58
The Theory of Sunspots. By Rev. T. W. Webb . . . . .	59
The Earthquake. By W. Topley ( <i>With Map</i> ) . . . . .	60
Volcanoes on the Shores of Lake Nyassa, Africa. By Dr. H. J. Johnston-Lavis . . . . .	62
Notes . . . . .	63
Our Astronomical Column:—	
The Approaching Return of Olbers' Comet . . . . .	64
The Building of the Alps, II. By Prof. T. G. Bonney, F.R.S., Pres. G.S. . . . .	65
Recent Morphological Speculations, I. . . . .	67
The Paris Academy of Sciences . . . . .	69
Societies and Academies . . . . .	70

THURSDAY, MAY 22, 1884

## VESTIGES OF CREATION

*Vestiges of Creation.* By Robert Chambers, LL.D. Twelfth Edition, with an Introduction relating to the Authorship of the Work, by Alexander Ireland. (London: W. and R. Chambers, 1884.)

ALTHOUGH the authorship of this interesting book has been for some time a somewhat open secret, the public avowal of it is to be welcomed for more reasons than one. The mystery which for so long a time has been allowed to hang over the subject was itself a mystery to explain. For any one reading the "Vestiges" could scarcely suppose that the free-minded, open-hearted, and fearless, truth-seeking spirit which looks out upon us in every page could be deterred by any motives of a petty or puerile kind from fixing the stamp of his name upon his work—at any rate in some of the later of the numerous editions through which the book passed. This mystery is now explained. In his brief introduction to this, the twelfth, edition, Mr. Ireland gives us the whole history of the matter. It seems that Mr. Chambers desired to conceal the authorship in the first instance for a variety of reasons, all of which were laudable. The chief among these was that "he was his brother's partner in a publishing business in which the rule had been laid down from the beginning of their co-partnership to avoid as far as possible, in their publications, mixing themselves up with debatable questions in politics and theology." After the author's death this brother continued to put his veto upon any declaration of the authorship, and so the secret was held close. About this time last year, however, Dr. William Chambers died, and left Mr. Ireland, as he says, "the sole surviving possessor of the secret." Previous to his death William Chambers expressed a wish that the secret should never be divulged; but as Robert Chambers had left the matter to the discretion of Mr. Ireland, this gentleman very properly undertook to keep the secret during the lifetime of the surviving relative, but refused to promise that he would do so in the event of his being left its sole repository. It is, therefore, to his sagacity and good feeling that the public are now indebted for the final clearing away of all the cobwebs which have been allowed to grow around this matter.

Of course the interest of the book itself is now purely historical. But if we were asked to indicate what is the feature which most strikes us on reading it from end to end, we should say, its power of clear and logical reasoning. The author is obviously a literary man, as distinguished from a man of science. But he is a literary man who is diligent in getting up his facts after the manner of a barrister preparing a case. He does not wait to examine his facts, provided that they make a decent show of probability, and produce a striking effect in his argument. As a consequence, even in this expurgated edition, we meet with a number of gravely erroneous statements. But the point to which we desire to draw attention is this. Although the writer every now and then admits erroneous statements of fact on insufficient evidence, and although as a consequence he every now

and then runs after some will-o'-the-wisp hypothesis, he never loses his logical balance; but, after his chase is over, he returns to his main argument as little out of breath as when he started. This, we think, is no small praise. If Chambers constructs his argument barrister-wise, he does so merely for the sake of presenting to judgment everything that has any appearance of being a fact; and on the whole he exercises a wise discretion in his estimate of the comparative value of the facts as proved or unproved.

The interest attaching to this remarkable work being now purely historical, it is impossible to avoid contrasting it with the still more remarkable work by which it was so soon to be eclipsed. When we do so, we have brought home to us more forcibly than ever by how enormous an interval the mind of Mr. Darwin was separated from all contemporary thought on the origin of species. It is not merely that he happened to have shed upon the whole subject the new light which arose with the great conception of survival of the fittest. Indeed, while reading some of Chambers' broadly-stated and yet closely-reasoned views upon "the fecundity of nature ordaining that her creatures shall ever be pressing upon the verge of the local means of subsistence"; the consequent tendency of individuals to overflow into other areas, "thus exposing themselves to new influences"; the opportunity that is thus afforded to any variety happening to arise on the newly colonised area, and happening also to be adapted to these new conditions, to perpetuate itself by heredity (pp. 226-27);—when we read such passages, we are led to wonder that, having gone all round the hypothesis of natural selection, Chambers should not have gone through it. But where we find the immense contrast between him and Darwin is in the different manner wherewith they have treated even the same lines of evidence concerning the *fact*, as distinguished from the *method*, of evolution. If we compare the chapters on geological and geographical distribution, on the mental constitution of animals, &c., with the corresponding chapters in the "Origin of Species" and "Descent of Man," we are led to marvel, perhaps more than we have ever marvelled, at the gigantic grip of Mr. Darwin's mind. It is not merely that he had incomparably larger stores of facts to draw upon, that he was a man of science as distinguished from a man of letters, and so forth. It is rather that he was head and shoulders above everybody else in sheer mass and force of thought. We have now become so accustomed to walk easily through the jungles where he, like an elephant, has opened the way, that it is difficult for the younger generation to realise the state of matters before the elephant appeared. But in the "Vestiges of Creation" we have the vestiges of these former things. We here see a man of very unusual strength as a writer, with no small diligence in accumulating evidence, and well equipped with the implements of logical method; we see him fighting manfully with all his might to cut his way in the direction where he is profoundly convinced that the truth must lie; and yet we see that he is overwhelmed with the immensity of his task. His work is now well worth surveying, if only to make us realise the nature of the difficulties with which at that same time his great successor was contending.

But, leaving now this unavoidable comparison aside.

we shall give a few quotations from the book, in order to show at once the tone of thinking which more or less pervades the whole, and the pleasing style in which it is conveyed.

"There are some considerations on the very threshold of the question which appear to throw the balance of likelihood strongly on the side of natural causes, however difficult it may be to say what these causes were. The production of the organic world is, we see, mixed up with the production of the physical. It is mixed in the sense of actual connection and dependence, and it is mixed in regard to time, for the one class of phenomena commenced whenever the other had arrived at a point which favoured or admitted of it; life, as it were, *pressed in* as soon as there were suitable conditions, and, once it had commenced, the two classes of phenomena went on, hand in hand, together. It is surely very unlikely, *a priori*, that in two classes of phenomena, to all appearance perfectly coordinate, and for certain intimately connected, there should have been *two totally distinct modes of the exercise of the divine power*," &c. (p. 148).

"There is certainly no express reason to suppose that, although life had been imparted by natural means after the first cooling of the surface to a suitable temperature, it would have continued thereafter to be capable of being imparted in like manner. . . . We are rather to expect that the vital phenomena presented to our eye should mainly, if not entirely, be limited to a regular and unvarying succession of races by the ordinary means of generation. This, however, is no more an argument against a time when phenomena of the first kind prevailed, than it would be proof against the fact of a mature man having once been a growing youth that he is now seen growing no longer" (p. 168).

Notwithstanding this, however, the writer immediately begins coquetting with a number of very seductive facts and considerations in favour of spontaneous— or, as he more correctly terms it, "non-parental generation." In particular he lays great stress upon the "Crossian experiment" of producing acari by the action of a voltaic battery on a solution of silicate of potash. And here we have a very good special illustration of the difference between Chambers and Darwin. The former, as a literary man, states the experiments, weighs the evidence which they yield, and, without actually accepting the fact as proved, is on the whole strongly disposed to believe it. The latter, as a man of science, would have spent a lifetime in verifying so all-important a fact, even if the evidence of it had appeared to him of but a tenth part of the weight that it appeared to Chambers. Here, however, it is but fair to Chambers, as a literary man, to say that he does not in this place, or anywhere else, attach more than its due value to the evidence of any alleged fact. He merely gives the evidence for what it may be worth, and then passes on. Therefore he is careful to make it clear that whether or not all the considerations which he adduces in favour of "non-parental generation" are valid, the question of its actual occurrence is really a side issue, and does not affect the course of his general argument in favour of the evolution of species by way of "parental generation." This clearness of logical view is further and particularly well displayed in his consideration of Lamarck's theory touching the causes of the evolution of species: although Chambers is exceedingly anxious to find these causes, so that it might "appear as if the clouds were beginning to give way, and the light of simple, unpretending truth were about to break upon the great

mystery," yet he critically puts his finger upon the weak points of the theory in question, and ends by dismissing it as inadequate to explain the facts (p. 233 *et seq.*).

One other quotation may be given as an example of the general common sense which the writer every now and then pours out, like a viscid secretion, wherewith to entangle and render helpless his opponents.

"It may be well to mark the credulity to which the adherents of immutability must here be reduced. They must believe that the Creator, having a particular regard to the fact of molluscan shells lying useless on the shore, formed, by special care or fiat, a family of crabs to occupy them. They must believe that the roughness of the caudal appendages, the development of suckers along the abdomen, the reduction of the two hind pairs of limbs, and the left pincer-claw, were all subjects for this special care, and were beyond the power of what an eminent geologist calls 'vulgar nature.' Surely the *Deus ex machinâ* was never more remarkably exemplified. See, on the other hand, how these facts are accounted for on the development theory. According to this new light, the hermit-crabs are simply a portion of some greater section of the crustacean class. Their peculiarities are modifications from the parent form, brought about in the course of generations, in consequence of an appetency which had led these creatures to seek a kind of shelter in turbinated shells" (p. 54).

It only remains to say that this, the no doubt final edition of the "Vestiges of Creation," is very prettily got up, and leaves nothing to be desired as to printing, &c. We feel, however, that it would have been well worth while to have had the reprint edited by some competent naturalist, who might have inserted footnotes to warn the general reader against the numerous pitfalls which are to be encountered on matters of fact. As it is, the general reader cannot possibly know what he is to accept as scientifically-established truth, and what he is to reject as superseded error. This we think is a pity in the interests of the book itself, because during its author's lifetime the successive editions were successively brought up to date in the matter of keeping pace with the progress of science. Lastly, in the appendix, written by the author himself in reply to criticisms, we must not fail to note the magnanimous temper, dignified style, and forcible reasoning, which contrast so favourably with the opposites of these things in the quotations which he has occasion to make from the more celebrated among his critics.

GEORGE J. ROMANES

#### NATTERER'S BRAZILIAN MAMMALS

*Brasilische Säugethiere.* Resultate von Johann Natterer's Reisen in den Jahren 1817 bis 1835. Dargestellt von August von Pelzeln. (Wien, 1883.)

THE collections of the celebrated Brazilian traveller and naturalist, Johann Natterer, owing to his untimely death shortly after his return to Europe, lay almost unnoticed for many years in the Imperial Cabinet at Vienna. At length Herr August von Pelzeln, after several years' unremitting study of the unrivalled collection of birds, published in 1871 his "Ornithologic Brasiliens"—well known to ornithologists as one of the most important authorities on the Brazilian avifauna. More recently the same laborious naturalist has devoted his attention to Natterer's mammals, and in the memoir now before us, of

which the second part has just been issued, has given us an excellent summary of Natterer's discoveries in this class of animals.

During his ten journeys in the Brazilian Empire (of which the first was commenced at Rio in November 1817, and the last terminated at Parà in September 1835) Natterer collected no less than 1179 examples of mammals, all most carefully prepared and accurately labelled, with notes of sex, colours of soft parts, date, and locality. These are referred by von Pelzeln to 205 species, 73 of which were new to science when first obtained by this unrivalled collector.

Natterer had planned a general work on the mammals of Brazil, in conjunction with Andreas Wagner. After the former's untimely death in 1843, Wagner published descriptions of the new genera and species in Wiegmann's *Archiv* and other periodicals, and introduced notices of them into his well-known supplement to Schreber's "Sangethiere." But we have now for the first time a complete systematic account of the whole of Natterer's collection with exact localities.

As might have been expected, the dense forest-region mostly traversed by Natterer was especially productive of Quadrumana—the American group of this order being exclusively arboreal in their habits. No less than 265 specimens of American monkeys were obtained, referable to 45 species, 4 of which were new to science. Of Chiroptera, Natterer procured examples of 48 species, of which at least 25 were first discovered by him. It should be also noted that the very singular structure of the stomach of the bloodsucking *Desmodi*, first made known by Prof. Huxley in 1865, was, as is testified by his note-books, previously discovered by Natterer in 1828!

The Carnivores are not so numerous in the Brazilian forests as the two preceding orders. Only 17 species were met with by Natterer, and only one of these (*Lutra solitaria*) was first made known to us by his specimens. The Rodents, on the other hand, are very abundant in species as in individuals in this part of South America. Not less than 50 species are represented in Natterer's series, whereof 24 were previously unknown to science.

The Ungulates are not abundant in South America, the true Ruminants being only represented by some peculiar forms of the deer family (Cervida). Of these Natterer obtained examples referable to 5 species. Besides the deer the only Ungulates met with were a tapir (*Tapirus americanus*) and the two well-known species of peccary.

Of the Sirenia, Natterer met with a manatee high up the stream of the Amazons, in the Rio Negro, Rio Branco, and Madeira, and maintains in his notes that the species which inhabits these far inland waters is quite different from the *Manatus americanus* of the South American coast. Natterer called it *Manatus inunguis*, from its nailless fingers, and sent home to the Imperial Cabinet of Vienna three complete specimens and several skulls. Of the Cetaceans, Natterer met with two species of dolphin in the Amazons and its tributaries. *Inia amazonica* was found in the Guaporé and Madeira, and two examples obtained, and a head of *Steno tucuxi* was brought home from Barra de Rio Negro. Interesting notes are given on the structure of both these little-known animals.

We now come to the Edentata, which, as is well known, are well represented in the Neotropical Region by the three families of sloths, armadillos, and anteaters. Of each of these peculiar forms Natterer obtained a fine series. Among the sloths the two-toed *Choloypus didactylus* was met with on the banks of the Rio Negro and its tributaries, while of the three-toed genus *Bradypus* examples were collected which are referred by Herr von Pelzeln to five species. Of armadillos, Natterer obtained examples of five species, including the giant *Cheloniscus gigas*; he likewise procured specimens of all the three known species of anteaters.

South America is also rich in the smaller opossums, which constitute the only family of extra-Australian Marsupials, and amongst them this assiduous collector reaped a rich harvest. Of 18 species of which he sent home specimens not less than 11 were previously unknown to science, and were mostly described by Andreas Wagner under Natterer's manuscript names. It may, indeed, be safely affirmed that no naturalist, unless our countryman, John Gould, in the case of his celebrated expedition to Australia, be a possible exception, has ever been equally successful with Johann Natterer in discoveries amongst the higher classes of animals, and it is probable that no future naturalist, however great be his industry, will ever surpass him in the number and variety of his discoveries or in the excellence of his specimens.

#### OUR BOOK SHELF

*A Treatise on Chemistry.* By H. E. Roscoe, F.R.S., and C. Schorlemmer, F.R.S., Professors of Chemistry in the Victoria University, Owens College, Manchester. Vol. III. Organic Chemistry, Part II. (London: Macmillan and Co., 1884.)

THE first part of this volume, treating of the hydrocarbons of the paraffin series, and the alcohols, ethers, bases, acids, &c., derived therefrom, has already been reviewed in this journal (vol. xxv. p. 50). The part now under consideration treats of a large number of compounds derived from the di-, tri-, tetra-, and hex-atomic alcohol-radicals, and from the monatomic alcohol-radicals of the series  $C_nH_{2n-1}$ ; also of the carbohydrates, sugar, starch, gum, cellulose, &c., and of the furfuryl, meconic acid, and uric acid derivatives. Many of these bodies, e.g. the carbohydrates, and oxalic, lactic, malic, tartaric, citric, and uric acids, are of great importance as constituents of vegetable and animal organisms, and for their applications in arts and manufactures. The extraction and purification of sugar, from the cane and from beet, are clearly and fully described in this volume, and illustrated by excellent woodcuts of the apparatus and machinery used; also the estimation of sugar in juices, &c., by the optical or polarimetric method. Descriptions and illustrations are also given of the manufacture of starch, of the uses of cellulose in its various forms, cotton, flax, hemp, &c., and of the manufacture of paper.

Altogether the part now under consideration forms a very valuable portion of Roscoe and Schorlemmer's "Treatise," and we hope that the publication of the remaining parts—which will treat of the benzene-derivatives or aromatic bodies, and of the proximate constituents of the animal organism—will not be long delayed. The portions already published afford a guarantee that the volume when finished will form one of the most complete treatises on Organic Chemistry yet published in the English language.

H. WATTS

## LETTERS TO THE EDITOR

[The Editor does not hold himself responsible for opinions expressed by his correspondents. Neither can he undertake to return, or to correspond with the writers of, rejected manuscripts. No notice is taken of anonymous communications.]

[The Editor urgently requests correspondents to keep their letters as short as possible. The pressure on his space is so great that it is impossible otherwise to insure the appearance even of communications containing interesting and novel facts.]

## Geology of the Malayan Peninsula

IN some geological excursions made recently in the State of Perak, I met with some curious facts which may be of interest to many of your readers. I made boat journeys down the Perak River from Enggor to the mouth, then back again up the valley of the Kiuta, and then returning to the mouth of the Kampar, went up that stream as far as boats can go. The main chains dividing these ranges are all granitic, rising to peaks generally over 3000 but sometimes over 7500 feet high. The ranges are flanked by Lower Limestone ridges, forming detached hills about 1500 feet in elevation. The summits of these hills, as well as on the flanks, are pierced with caves, which contain a ferruginous clay with stream tin. The latter is evidently derived from granite, but as the limestone hills are quite isolated, and some miles away from the source of the ore, the denudation of the country must have been very great. Some of the caves with tin sand are 1000 feet above the plain, and have to be approached by steps cut in the face of a precipice. These small mines are rich enough to attract a few Malays and Chinese, who are the only inhabitants. The country is otherwise a dense jungle. The limestone is crystalline, without a trace of organicism, though lines of stratification can still be traced. Tin is also found in the drift at the base of these hills, entangled as it is in the pinnacles and peaks of the underlying limestone.

There is evidence of extensive denudation in both the granite and limestone. There are no signs of any recent upheaval in any of this country, nor, as far as I have seen, anywhere in the Malayan Peninsula, from Keddah to Johore. The country is rich in tin, which has been only partially worked.

There is a palæozoic sandstone clay slate or gneissose formation lying between the limestone and granite. It is much decomposed, and gives rise to a red clay which goes generally by the name of laterite. It is not of great thickness, but is widely represented by outliers at the base of the main ranges, often capping small detached hills. At the junction of this rock with the granite is in my opinion the place where the great deposits of tin have taken place. Wherever such outliers have been denuded away the resulting drift has always been noticed by me as richest in stream tin. On such drifts are the richest mines of Perak, notably Larut, Kamunting, and Assam Kumban. I don't think this palæozoic formation has been previously noticed, but indeed the country is but little known geologically. The slates are very like the Ordovician rocks of Australia, in which so much gold has been found.

J. E. TENISON-WOODS  
Thaiping, Perak, April 17

## The Marine Biological Station and a Coast Survey

ALLOW me to say in reference to your article advocating a Biological survey of the British coasts, that you are quite right in supposing that such a survey falls within the scope of this Association. As a first step in the direction of such a survey the Association proposes to establish a dredging station and observatory on the south coast. Later it will, it is to be hoped, be able to establish or to cooperate in the establishment of additional dredging stations on various parts of the coasts of the United Kingdom, and thus gradually complete a *thorough* (not a superficial) survey such as is needed. The Association will no doubt seek the aid of the Government when the proper time for doing so arrives.

E. RAY LANKESTER  
Secretary (*ad interim*) of the Marine  
Biological Association

## Atlantic Ice and Mild Winters

THE influence of the Gulf Stream in ameliorating the climate of the United Kingdom and of the north-west corner of Europe up to 71° of north latitude is so well known and so generally acknowledged that no comments are required; but can we dis-

cover any force sufficiently powerful by which this great heating power may occasionally be so largely augmented as materially to influence our usual winter temperatures, by bringing to our shores not only a larger flow of warm water, but also impelling it to strike or come into closer contact with our coasts further to the south?

I have, in a desultory way, for a series of years noticed that as a rule mild winters in England were associated with much ice extending far south in the Atlantic. The past winter is a striking example of this. Floe-ice has been more than once met with by steamers in lat. 40° N. and in about the same degree of west longitude, as nearly as possible midway between New York and Ireland, and in the direct ship track between Jamaica and Liverpool. These conditions indicate an Arctic current of very much increased volume, extending something like 400 miles south and an equal or greater distance east of the position given to it on any of the current charts I have examined.

The natural effect of so large a flow of cold water from the north meeting the Gulf Stream at right angles would not only be to deflect the latter to the southward of its usual course, causing it to strike our shores further south, but also in much greater volume, because a larger supply is required to replace the increased quantity from the Arctic.

The only specially cold winds we have had in the past winter and spring have been from the east, with one or two brief exceptions, when there were gales from west and north-west, during which the air, after leaving the Arctic current, *may have* passed so rapidly over the Gulf Stream that it had not time to acquire any great increase of heat.

As was to be expected from the extra quantity of ice on the west side of the Atlantic the winter weather was unusually cold and changeable in Canada and the United States, varying with the direction of the winds.

The meeting of the Arctic current and Gulf Stream has no doubt been seen thousands of times. I had the good fortune to witness it only once, and it reminded me—but on a far grander scale—of two great rivers having waters of different colours, joining each other at right angles, or nearly so, as I have noticed with the McKenzie and some of its tributaries.

We were coming from Portland (February 1860), and our excellent captain had kept far south of the usual track, to avoid ice, so that for several days we were steaming *in* or at the edge of the Gulf Stream. The meeting of the two currents with their eddies—miles wide—was clearly defined, the water to the north being beautifully clear and blue, whilst to the south it had a brown colour with a thin film of haze over it. As we crossed the eddies or "swirls" of current, temperatures were carefully taken, that of the clear water being many degrees lower—I have forgotten the exact difference—than the brown or Gulf Stream.

Probably this whole question may have already been gone into and fully discussed by others; if so, the details have not come under my notice. My chief object is to attract the attention of those who are much better qualified to deal satisfactorily with this interesting subject than I can pretend to be.

4, Addison Gardens, May 10

JOHN RAE

## Right-sidedness

IN NATURE for March 20 (vol. xxix. p. 477) Mr. Wharton and Dr. Rae criticise my letter of the 13th on right-sidedness. In writing that letter I had no intention of starting a new subject, but only to remove one source of confusion from the subject of bias in walking. But since the subject is started, I will say a few words in reply.

Neither Mr. Wharton nor Dr. Rae seem to be perfectly normally constituted. Dr. Rae is left-handed, indeed left-sided, by inheritance (I suppose), and right-handed in some things by education. In his case, therefore, the phenomena are more complicated, but there is nothing at all inconsistent with my view or at all different from what I would expect.

Mr. Wharton is near-sighted; his two eyes are of different focal length, and his *left* eye is *much* the stronger. And yet "by unconscious preference" he uses the right eye for the microscope or telescope. Is it possible to have a stronger confirmation of my view?

But he says that if right-sidedness has its cause in the brain, then, since I am right-handed, I ought to be left-eyed, for paralysis of the right side is attended with blindness of the left eye, and *vice versa*. Is this true in all cases? If Mr. Wharton would prove it, physiology would owe him a deep debt. We all

know the complex and therefore delusive and often apparently contradictory character of the phenomena resulting from lesions of the brain, but I think the weight of experimental evidence (and surely this is more reliable than pathological) is the other way. Experiments on pigeons and dogs ("Dalton's Physiology," pp. 430 and 454) seem to show that lesions of the brain affect the opposite eye as well as the opposite side of the body. Anatomical structure also would lead us to expect this, for the fibres of the optic tracts cross over in the chiasma, in birds completely, and in mammals largely. But even if it were otherwise, I do not see that the question is materially affected. If right-sidedness is inherited, there must be, or must have been, some advantage in it; and there is no reason why inheritance should not have affected different sides of the brain for hand and for eye, if such were necessary to bring about the result.

Again, Mr. Wharton has the singular idea that because Europeans, who are a right-handed people, write from left to right, therefore Eastern nations who write from right to left must be left-handed! Obviously this does not follow. Many right-handed motions, such for example, as striking with a whip are from right to left, so that the contrary stroke, on account of its unfrequency, is called *backhanded*.

Lastly, Mr. Wharton alludes to the rules of boxing. The left hand is used mostly for striking, and the right for guarding. It would be well if some one acquainted with the subject would give us its history. My impression is that the present practice is comparatively recent, perhaps forty to fifty years old, and that formerly the right hand was used mostly for striking, and the left for guarding. I think, further, that even now the left is used more for feints and lighter blows, while the right is reserved for favourable opportunities to plant decisive blows.

Berkeley, Cal., April 23

JOSEPH L. E. CONTE

#### Dark Transit of Jupiter's First Satellite

ON May 18, at 8h., on observing Jupiter with my 10-inch reflector, p. 252, I saw three very dark spots—one near the planet's centre, and two others not far advanced upon the east limb. These I took to be the shadows of satellites, and on reference found that the shadows of Satellites I. and II. were really upon the planet; also Satellite I. itself. The latter was evidently the spot near the centre of the disk, and it appeared almost equally as black as the shadow. The satellite was situated close to the equatorial white spot, and in point of fact was projected upon the north-east borders of that object. The latter was estimated on the central meridian at 8h. 5m., so that its longitude, computed on the diurnal rate of  $878^{\circ}46'$  (= rotation of 9h. 50m.  $7'42s.$ ), was  $94^{\circ}3'$ .

When near mid-transit, Satellite I., as regards its visible aspect, could hardly have been distinguished from its shadow, and I believe the very dark appearance of the satellite on this occasion to have been somewhat exceptional; for though I have observed a considerable number of its transits, I never saw it nearly so dark before.

W. F. DENNING

Bristol, May 19

#### The Remarkable Sunsets

A COPY of NATURE (vol. xxix. p. 149) just received here contains an article on "Remarkable Sunsets" which were seen in all parts of the world during the latter days of November and the early days of December. It may interest your readers to know that precisely similar sunsets to those described in the paper referred to above occurred here for several days in December. The "rosy pink after-glow" immediately succeeded the sunset, and lasted from ten to fifteen minutes. The phenomenon considerably scared the Chinese, who feared it portended some evil to the Emperor. The winter has been remarkably mild and dry; the first fall of snow, a very heavy one, took place on March 1. This region is volcanic; we have occasional shocks of earthquake.

ARTHUR SOWERBY

T'ai Ynen Fu, Shansi, North China, March 5

#### "Notes on Earthworms"

REFERRING to Mr. Hughes' communication to NATURE of May 15, p. 57, I myself to-day saw a small worm pursued by a black insect, also evidently the larva of one of the Curabidæ. I was attracted by observing the worm emerge from the ground

and hurry quickly away. When about five inches from its burrow the larva came out of the same burrow, and briskly followed in a zigzag course, until it overtook its prey, which it then seized near the tail end and dragged under some loose earth. No doubt the worm had been pursued underground, and was endeavouring to make its escape.

E. A. SWAN

224, Camberwell New Road, May 17

#### The Recent Earthquake

IN p. 57 of the last number of NATURE notice is taken of the lack of observation on the late earthquake in Central Kent, Surrey, or Sussex. In Tonbridge we have known of three instances in which it was certainly felt. On the morning of April 22 a lady in bed in a room on the first floor felt a push from the foot of the bed so strong that she asked her little girl, who was in the room, why she was shaking it so, which of course the child denied—the bedstead being of iron and too heavy for her to have moved; the valance at the head of the bed swayed to and fro. The second instance we heard of was an Indian officer, who felt it, while standing leaning against his mantel-piece, directed about from north-north-east to south-south-west. The third instance was an invalid lady in bed on the first floor.

M. I. PLARR

22, Hadlow Road, Tonbridge, Kent, May 19

#### Animal Intelligence

ONE night a loud knock was heard at the back door, and as the door could not be reached by any one outside the house except by getting over the garden wall, some alarm was caused. On the knock being impatiently repeated, the door was opened, and the cat ("Mrs. Muffins") walked in with great dignity. Since then she has never failed to make known her presence in the same way, always waiting after the first knock. Some weeks elapsed before it was ascertained how the knocking was produced, but at length it was discovered that a slip of wood which runs down the side of the door was loose at the bottom; this slip she pulls out with her paw, and then allows it to rebound. She is a very affectionate mother. Some time ago her mistress, by accident, hurt her kitten. "Mrs. Muffins" walked up to her and gave her two or three sharp slaps on the dress. To-day the same thing has occurred; but on this occasion, as the servant was the offender, "Mrs. Muffins" followed her into the kitchen to chastise her. I may also add that she has shown great intelligence in making her wants known to her friends.

E. A. LONERGAN

#### AGRICULTURE IN THE UNITED STATES<sup>1</sup>

WE may learn many a good lesson by observing the admirable manner in which the various Boards of Agriculture discharge their duties in the United States. With a sound discretion the mutual influences of geology and agricultural practice are prudently considered in association with the investigations of the chemist and the records of the Census Office. In these respects the various States are greatly in advance of anything provided in the United Kingdom. We have our Geological Survey most carefully conducted, and the maps showing the solid geology of the country are excellent. In addition to these we have another series of geological maps showing the drifts covering up these rocks, but at this point we cease to follow the example set us in the United States. Aided as each individual State is by a series of experts, such as the State Botanist, the State Geologist, the State Entomologist, the State Chemist, and similar officials, we thereby find most valuable help rendered to the agriculture of the country. This assistance is rendered more effective by reason of the concerted action by which it is so generally characterised. Each scientist views any given subject from his own special standpoint, and the great advantage of concerted action is the more mellowed judgment which is thereby secured.

In the Report before us we have one of those happy blendings of science and practice which is so well calcu-

<sup>1</sup> "Geological Survey of Alabama, embracing an Account of the Agricultural Features of the State." By Eugene Allen Smith, Ph. D., State Geologist.

lated to benefit the district dealt with, and which, instead of insulting the practical man, gives him information which he gladly utilises. The Report commences with a general discussion upon the composition, mode of formation, and the properties of soils, and the changes produced by cultivation. In the second section, soil in its relation to vegetation is somewhat elaborately dealt with. In the third section, soil in its relations to animal life is very completely presented to the reader's attention. The question of the absorptive powers of soils is ably dealt with. "As to the cause, opinions vary, but closer study of the phenomena of absorption have led back to the pretty general acceptance of the explanation originally offered by Way, which, as expressed by Mayer ('*Agrikultur Chemie*'), is as follows:—"We find in the soil easily decomposable double silicates, the exact composition of which is unessential, which, along with alumina, always contain some other base, an alkali or an alkaline earth, or even several of these bases at the same time. These silicates have the property, under certain conditions, of exchanging their accessory ingredients (not the alumina). The artificial silicate of Way had the composition of a zeolite, and it remained only to experiment with naturally occurring zeolites, which was done by Eichhorn, Mulder, and others, with the result of showing . . . that they all possess the power of exchanging a portion of their original content of lime or soda for an equivalent of potash or ammonia; in other words, of absorbing the latter bases. . . . According to Mulder . . . while the fertility of soil does not depend exclusively upon these zeolites, yet its chemical activity is altogether determined thereby." These comments are the more noteworthy because there has been a tendency amongst some chemists to undervalue the importance of Way's discovery, but the testimony of practice is too strong for it to be altogether ignored.

An exceedingly important connection is shown between the production of cotton and the systems of management pursued in Alabama. Speaking of the Great Cotton Belt of Alabama, the Report points out that the soils upon this belt have been largely exhausted by improvident culture, cotton being planted year after year upon the same soils, without any attempt being made to maintain the fertility by the use of manures. In other parts of the State where cotton is produced a selection is generally made of the better soils, rotation of crops is more generally practised, and in some sections fertilisers are in more general use. This is largely occasioned by the relative proportions of the population and the capital they have at their command.

"The system of credits in the large cotton-producing regions prevails to such an extent that the whole cotton crop is usually mortgaged before it is gathered, and when we consider that the prices charged for provisions are at least 50 per cent. higher than regular market rates, . . . it will need very little calculation to show that the labourer will have the chances too greatly against him, even to be out of debt to his merchants, when he relies solely upon this crop to provide the money, and the exorbitant interest on the money advanced is not likely to be lessened so long as the merchants' risks continue to be as great as they are. Where the blacks are in excess of the whites there are the originally most fertile lands of the State. The natural advantages of the soils are, however, more than counterbalanced by the bad system prevailing in such sections, viz. large farms rented out in patches to labourers, who are too poor and too much in debt to merchants to have any interest in keeping up the fertility of the soil, or rather they lack the ability to keep it up, with the natural consequence of its rapid exhaustion and a product per acre on the best lands in the State lower than that which is realised from the very poorest. Where the two races are in nearly equal proportions . . . there is found the system of small farms, worked gene-

rally by the owners, a consequently better cultivation, a more general use of commercial fertilisers, a corresponding high product per acre, and a partial maintenance of the fertility of the soils."

The entire Report is literally crowded with interesting and most important details, such as skilled experts are likely to formulate for the guidance of higher officials and for the assistance of those engaged in the cultivation of the land. The well-organised system existing in the United States, whereby the causes of failure and success are rendered prominent, is doing great service to that country, for they clearly recognise the truth that the advancement of agriculture is a national duty, because just in proportion as additional wealth is thus created within the States, so do the people generally participate in the advantages thus secured.

### BIRD SKELETONS<sup>1</sup>

THE author of this important work, shortly after his return from his explorations in New Guinea and the Moluccas, was appointed Director of the Royal Zoological Museum at Dresden, and under his care the last-named museum is fast becoming one of the leading institutions in Germany. During his travels in the East Dr. Meyer appears to have amassed a considerable amount of material for his projected work on the skeletons of birds, and now that five parts of the "*Abbildungen*" have appeared, we think it well to draw the attention of English naturalists to it, as it will undoubtedly prove to be one of the most interesting osteological works yet attempted. The skeletons are all contained in the Dresden Museum, and Dr. Meyer proposes to carry on the work until his material becomes exhausted; but we trust that all ornithologists who can aid the author in his excellent enterprise will not fail to do so.

The works on the osteology of birds are not numerous, and this important portion of ornithological study has been too much neglected and systematically overlooked. The chief English work has been the "*Osteologia Avium*" of the late Mr. Eyton, and there are, of course, Prof. Owen's well-known memoirs on the *Dinornis* and its allies, on the Great Auk, and a few scattered representations of skeletons here and there. France can boast of Prof. Milne-Edwards's splendid volumes on fossil birds in comparison with recent forms, as well as the fine series of illustrations in the "*Histoire Naturelle de Madagascar*" of M. Grandidier. In Germany Prof. Selenka, of Erlangen, commenced, in Bronn's "*Classen und Ordnungen*," a systematic treatise on the osteology of birds, but unfortunately he discontinued this useful work after the issue of a few parts. Dr. Meyer's labours therefore deserve the acknowledgment of all scientific men as being an attempt to fill up a gap in our knowledge of birds. There are probably eleven thousand species of birds described up to the present time, but the osteological characters of only a very small proportion of them have been noticed, and a very inconsiderable number of the three thousand genera have been illustrated. As Dr. Meyer only figures those species which have not been before represented, each illustration represents a new fact for science, and we trust that he will be able to continue to add to the already rich materials at his command, and bring to a successful conclusion the important task which he has set himself.

Dr. Meyer does not avail himself of the usual mode of illustration by lithography, but has had all the skeletons photographed from nature, and then reproduced by

<sup>1</sup> "*Abbildungen von Vogel-Skeletten herausgegeben mit Unterstützung der generaldirection der königl. Sammlungen für Kunst und Wissenschaft in Dresden.*" Von Dr. A. B. Meyer. Parts 1 to 5, pp. 1 to 40, Platten 1 to 50. (Dresden: Published by the Author, 1879-1883.)

phototype. This process does not fade as a photograph is liable to do, but has the consistency of print with the appearance of a steel engraving. By an ingenious method adopted by the author only one side of the bird's skeleton is given in the plate, and thus the confusion which is often seen in osteological illustrations from the appearance of the opposite side of the skeleton in the picture is obviated. The plates, which have been executed in Dresden at Mr. Wilhelm Hoffmann's Art Institute, deserve great credit for their execution. The letterpress which accompanies the figures gives the distinguishing characters of the skeletons with their principal measurements.

It is proposed to issue at least two parts in the course of every year, each part to contain ten plates. Out of the number hitherto published we find illustrations of seventeen Parrots belonging to fourteen genera, amongst them being the rare *Dasyptilus pesqueti* from New Guinea, the smallest known Parrot, *Nasitera pygmaea*, as well as the largest one, *Microglossus aterrimus*, both of which are from New Guinea, *Nestor meridionalis* and *Stringops habroptilus* from New Zealand, besides illustrations of members of the following genera:—*Eclolus*, *Cacatua*, *Cyclopsitta*, *Loriculus*, *Trichoglossus*, *Charmosyna*, *Brotoperys*, *Tanygnathus*, and *Eos*. Of Birds of Paradise illustrations are given of *Cicinnurus regius*, *Paradisaea minor*, *Manucodia chalybeata* with its twisted windpipe, along with those of its allies. Other Birds of Paradise are promised by Dr. Meyer. Among the Pigeons are figured species of *Carpophaga*, *Otidiphaps*, *Cedirhinus* and *Ptilopus*, side by side with skeletons and skulls of some of the domestic races. Of Kingfishers figures of the skeletons of the genera *Cittura*, *Tanyptera*, and *Sauromarphus* are furnished, and among others we find illustrations of such interesting genera as the following:—*Pelenopides*, *Meropogon*, *Collocalia*, *Heteralocha*, *Rallina*, *Scissirostrum*, *Streptocitta*, *Oriolus*, *Dicrurus*, *Lepidogrammus*, &c.

We must draw the special attention of our readers to the skeleton of a species of *Notornis* from New Zealand, which Dr. Meyer has figured in Plates 34 to 37. This skeleton was procured along with the skin of the bird in South Island, N.Z., in the year 1879, and has found its way to the Dresden Museum. Complete figures of the osteology of this interesting genus are here given for the first time. Our national collection contains two skins of *Notornis*, but no skeleton, only some fossil remains from the North Island having been described and figured in the year 1848 by Prof. Owen. From a comparison of the latter with the skeleton now in the Dresden Museum, Dr. Meyer has been induced to consider that the North Island species is distinct from that inhabiting the South Island, and as the name of *Notornis mantelli* was given by Owen to the former bird, the specimen in the British Museum which came from the South Island must bear the name of *Notornis hochstetteri*, as Dr. Meyer proposes to attach to it the name of the well-known New Zealand explorer, Prof. von Hochstetter of Vienna.

A comparison is instituted by Dr. Meyer between the skeletons of different species of *Porphyrio* and *Ocydromus*. Together with the skeleton of the Jungle-fowl (*Gallus bankiva*), which Dr. Meyer himself brought from Sangi Island, north of Celebes, and different species of grouse (amongst them that of *Tetrao medius*), we find representations of the skeletons of several domesticated races of fowls. The importance of the characters presented by the differences of the crania and other portions of the skeletons of domestic fowls and pigeons was long ago proved by Mr. Darwin, and as there were only certain portions of the skeletons figured by him, the material which Dr. Meyer has collected with great care offers to the student a better opportunity of going deeply into this subject.

R. B. S.

THE "POTÉTOMÈTRE," AN INSTRUMENT FOR MEASURING THE TRANSPIRATION OF WATER BY PLANTS

IN view of the interest now attaching to recent advances in vegetable physiology, it seems not unlikely that a description of the instrument bearing the above name, lately published by Moll (*Archives Néerlandaises*, t. xviii.), will serve a useful purpose.<sup>1</sup> The apparatus was designed to do away with certain sources of error in Sachs's older form of the instrument, described in his "Experimental-Physiologic"—errors chiefly due to the continual alteration of pressure during the progress of the experiment.

As shown in the diagram, the "potétomètre" consists essentially of a glass tube, *ad*, open at both ends, and blown out into a bulb near the lower end; an aperture also

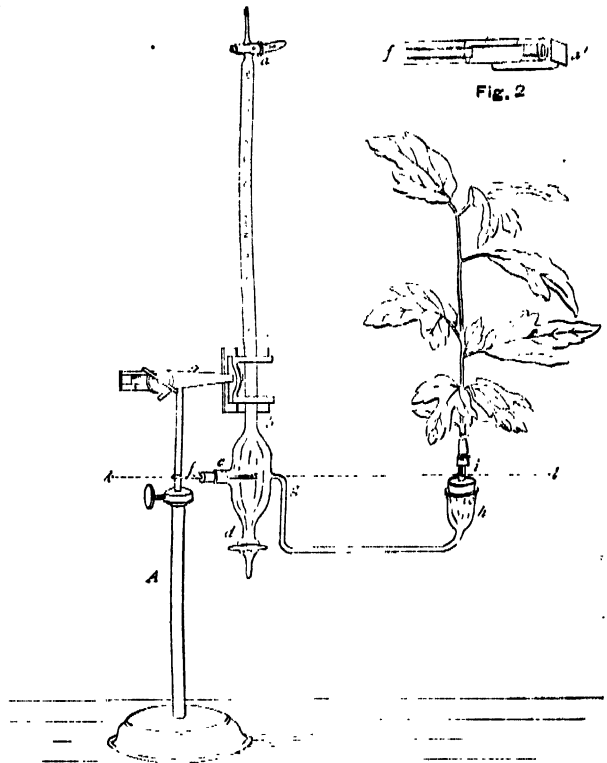

Fig. 1

exists on either side of the bulb at or about its equator. The two ends of the main tube are governed by the stopcocks *a* and *d*, and the greater length of the tube is graduated. A perforated caoutchouc stopper is fitted into one aperture of the bulb *e*, and a tube, *gh*, fits hermetically to the other. This latter tube is dilated into a cup at *h* to receive the caoutchouc stopper, into which the end of the shoot to be experimented upon is properly fixed.

The fixing of the shoot is effected by caoutchouc and wire or silk, as shown at *i*, and must be performed so that the clean-cut end of the shoot is exactly at the level of a tube passing through the perforated stopper, *e*, of the bulb; this is easily managed, and is provided for by the bending of the tube *gh*. The tube *f*, passing horizontally through the caoutchouc stopper *e*, is intended to admit bubbles of air, and so equalise the pressure and at the same time afford a means of measuring the rapidity of the absorption of water by the transpiring shoot. This tube

<sup>1</sup> Especially also with reference to Mr. F. Darwin's description of his own ingenious instrument (see NATURE, May 4, p. 7).



(see Fig. 2, *f*) is a short piece of capillary glass tubing, to which is fixed a thin sheath of copper, *b*, which slides on it, and supports a small plate of polished copper, *a*, in such a manner that the latter can be held vertically at a small distance from the inner opening of the tube, and so regulate the size of the bubble of air to be directed upwards into the graduated tube *a b*.

The apparatus is filled by placing the lower end of the main tube under water, closing the tubes *f* and *i* (with caoutchouc tubing and clips), and opening the stopcocks *a* and *d*. Water is then sucked in from *a*, and the whole apparatus carefully filled. The cocks are then turned, and the cut end of the shoot fixed into *i*, as stated: care must be taken that no air remains under the cut end at *i*, and the end of the shoot must be at the level *k l*. This done, the tube *f* may then be opened.

The leaves of the shoot transpire water, which is replaced through the stem at the cut end in *i* from the water in the apparatus. A bubble of air passes through the tube *f*, and at once ascends into the graduated tube *a c*. The descent of the water-level in this tube—which may conveniently be graduated to measure cubic millimetres—enables the experimenter at once to read off the amount of water employed in a given time.

It is not necessary to dwell on obvious modifications of these essentials, nor to speak of the slight difficulties of manipulation (especially with the tube *f*). Of course the apparatus might be mounted in several ways; and excellent results for demonstration in class could be obtained by arranging the whole on one of the pans of a sensitive balance.

H. MARSHALL WARD

Botanical Laboratory, Owens College

#### AURORAL RESEARCHES IN ICELAND

IN my last communication to NATURE on the aurora borealis in Iceland (vol. xxix. p. 537), I mentioned that the unusually adverse state of the weather had frustrated my plan of erecting one of the "utströmnings" apparatus invented by Prof. Lemström for the production of the artificial aurora borealis (see NATURE, vol. xxvii. p. 389) on Mount Esja, 2500 feet in height, and about two geographical miles north-east from Reykjavik.

The greatest part of February passed too without showing any improvement, and the prospects of getting the apparatus in working order on the mountain whilst the Arctic night still reigned became smaller and smaller. Although I regretted this, the study of the aurora which I had observed during the winter had, as indicated in my last communication, gradually convinced me that such an apparatus, even at a great height above the level of the earth, would, at all events in this part of Iceland, give but a negative result.

In spite of the favourable position of the island, the electrical forces, for which the aurora borealis is a visible indicator, appear to possess exceedingly little energy and intensity here, which has particularly been the case during the past few months. In consequence I came to the conclusion that should even all my arrangements be carried out to perfection there was little prospect of producing the "artificial" aurora borealis here.

On February 22, however, a change in the weather set in, and we had a few lovely days with a clear sky, no wind, and a pleasant temperature. Now, if ever, the time had come for realising my plan; and as the weather held for three entire days I fixed the departure for noon of the 25th.

I was fortunate enough to be able to make the journey in pleasant company, two of the burghers of the town and two Englishmen engaged at some sulphur mines in the vicinity volunteering to accompany me to the top of the mountain. We started at about 10 a.m. in a large sailing boat, with the poles, wires, and the rest of the apparatus.

In about three hours we landed at the foot of Esja, and took up our quarters in the farm Mogilsau, from whence I despatched the crew in every direction to call up all able-bodied men to assist in bringing the materials up to the top. Already the same afternoon I had ten of the poles carried up to a height of about 1500 feet.

The next morning broke clear and fine, promising a day as fine as the previous one. I had then sixteen men at my disposal. They began work at 6 a.m., carrying the heavy things up the mountain, and at 9 the last were taken out of the boat, and we all followed upwards.

We ascended from the southern side of the mountain about two miles in length. Only now and then we found snow, otherwise the ground consisted of sand and gravel mixed with boulders. The incline is not very great at first, but at times hills and ridges are encountered which tax the muscles and the lungs severely enough. However, the first 2000 feet of the road were not difficult or dangerous; in fact the only part which could be called so were the last 500 to 600 feet. Here the mountain rises abruptly (Esja is formed in terraces), and was covered with a thin layer of snow having a dangerous ice-coating. It was impossible to proceed here without first having hewn steps in the ice.

At 11.20 we mounted the crest of Esja. The mountain stretched snowy-white to all sides as level as a floor. It brought to my mind my ascent of the North Cape last summer. There was a slight breeze blowing which made the air feel chilly. The thermometer showed in the sun at 1 p.m. - 1°2', at 2 - 0°2', and at 3, in the shade, - 3°2' Cels.

Every hand now became busy with erecting the apparatus. The layer of snow on the surface of the mountain was not thick enough to support the poles, and as the ground was frozen hard, they were—thirty-one in number—raised in cairns of large boulders, of which there were great quantities on the edge of the plateau. The poles being raised, the copper wires, along which there were fixed more than a thousand fine points, were suspended over the insulators on their tops. The wires were 850 feet in length, and the poles were erected in such a manner that square spiral slings were formed, having a distance of 6 feet from each other. The total surface area of the "utströmnings" apparatus is therefore 4100 square feet.

The work of erecting the apparatus occupied about four hours, and from the four barometrical observations I had an opportunity of making during the time—in conjunction with those which were, at my request, simultaneously, and with a similar instrument, effected at Reykjavik—I have fixed the height at which the apparatus stands at 2616 feet.

At 3.30 the descent began. The first part of this was far more risky than the ascent, as the steps cut became worn down and new ones had to be made. Simultaneously a very strong copper wire, carefully insulated by layers of canvas and indiarubber—the insulation being 6 mm. in diameter—was brought down the mountain by the shortest road, as far as it reached.

The next morning welcomed us with wind and heavy clouds, with a rapidly-falling barometer. The remaining poles were now brought up the mountain, and the bare telegraph wire, 3200 feet in length, carried to the spot where the insulated conductor ended. Both wires were connected in the most careful and exact manner, and the bare wire laid down as an ordinary telegraph wire on poles with insulators as far as it went. I had expected from its great length that it would reach down to the foot of the mountain, but it did not; it only reached to a height of 714 feet. When the wires in increasing rain and wind were laid out, I connected the end with two zinc disks one of which was placed in a small waterfall with heavy stones on it, and the other buried in the earth. When, finally, I had by means of a telephone and a gal-

vanic element, conclusively ascertained that the conductor was in perfect working order right up to the top of the mountain, we began the descent and the return journey as rapidly as possible. We had no other choice, as the storm and rain which every moment increased precluded every possibility of doing more at that time. I had, however, some consolation in what already was done, my apparatus standing 1900 feet above the disks.

I left all the instruments to be used in connection with the experiments at Mogilsau in hopes that the weather would soon improve and allow me to return. The journey to Reykjavik was performed in a downpour of rain and a great storm.

As I had anticipated, the "utströmnings" apparatus has up to the present shown no signs of life whatever. I can see it plainly with a good telescope from my residence, and thus ascertain that it is in perfect order. In addition, I have just received a message from Mogilsau, informing me that the lower part is in perfect order too. Still during the few favourable nights we have as yet experienced not the slightest luminosity has appeared above the point in question.

If this be a negative result, it is a result, nevertheless, of considerable scientific interest.

The aurora borealis here has during the last few months been far more distinct in its appearance than during the first half of the winter. There is certainly, when the sky is sufficiently free from clouds, here and there a faint indication that the phenomenon does still exist, but such signs of life are very weak and limited.

I have at present no knowledge whether the aurora borealis has displayed less activity in other quarters of the globe during the winter than is generally the case, as letters take a long time from and to this island, but the Reykjavik people contend that the phenomenon displays usually far more energy and intensity than has been the case this winter. I am at present inquiring in various parts of the island whether the absence of the aurora borealis this winter has been noticed as generally remarkable, or its appearance is the usual one in Iceland.

In my last communication to NATURE I intended to have mentioned that I was curious to know what the effect would be of a sufficiently strong aurora covering the moon's disk. During the winter I have had several opportunities of observing aurora projecting over the disk of the moon when full, but nothing more unusual is seen than the light of the aurora borealis disappearing within a radius of  $5^{\circ}$  to  $10^{\circ}$  around the moon. But in the appearance of the latter there is no difference.

Reykjavik, March SOPHUS TROMHOLT

#### A CARNIVOROUS PLANT PREYING ON VERTEBRATA

AN interesting discovery has been made during the last week by Mr. G. E. Simms, son of a well-known tradesman of Oxford. It is that the bladder-traps of *Utricularia vulgaris* are capable of catching newly-hatched fish and killing them. Mr. Simms brought to me for examination a specimen of *Utricularia* in a glass vessel, in which were numerous young roach newly hatched from a mass of spawn lying at the bottom. Numbers of these young fish were seen dead, held fast in the jaws of the bladder-traps of the plant. I had never seen *Utricularia* before, and am indebted to my colleague Prof. Burdon Sanderson for the identification of the plant and a reference to Cohn's researches on it. Mr. Simms supplied me with a fresh specimen of *Utricularia* in a vessel with fresh young fish and spawn, and in about six hours more than a dozen of the fish were found entrapped. Most are caught by the head, and when this is the case the head is usually pushed as far into the bladder as possible till the snout touches its hinder wall. The two dark black eyes of the fish then show out conspicuously

through the wall of the bladder. Rarely a specimen is seen caught only by the tip of the snout. By no means a few of the fish are, however, captured by the tail, which is swallowed, so to speak, to a greater or less distance, and I have one specimen in which the fish is caught by the yolk sac. Three or four instances were observed in which a fish had its head swallowed by one bladder-trap, and its tail by another adjacent one, the body of the fish forming a connecting bar between the two bladders.

I have not been able to see a fish in the actual process of being trapped, nor to find one recently caught, and showing by motion of the fore part of its body signs of life. All those trapped were found already dead, but I have had no opportunity of prolonged observation, and it will be remembered that Mr. Darwin, in his account of the trapping of Crustacea, worms, &c., by *Utricularia*, states that he was not able to observe the actual occurrence of the trapping of an animal, although Mrs. Treat of New Jersey often did so. I think it probable that the fact described by Mr. Darwin, and which is easily verified, that the longer of the two pairs of projections composing the quadrifid processes by which the bladders of *Utricularia* are lined "project obliquely inwards and towards the posterior end of the bladder," has something to do with mechanism by which the small fish become so deeply swallowed so to speak. The oblique processes, set all towards the hinder end of the bladder, look as if they must act together with the spring valves of the mouth of the bladder in utilising each fresh struggle of the captive for the purpose of pushing it further and further inwards. On cutting open longitudinally some of the bladders containing the heads and foreparts of the bodies of fish, and examining their contents, I found the tissues of the fish in a more or less slimy deliquescent condition, no doubt from decomposition, for Mr. Darwin failed to detect any digestive process in *Utricularia*. The quadrifid processes were bathed in the slimy semi-fluid animal substance, and the processes themselves appeared to contain abundance of fine granular matter, possibly the result of absorption, but the large quantity of surrounding animal matter present rendered the observation uncertain. The usual swarms of Infusoria were present in the decomposing matter.

Specimens of the *Utricularia* with the little fish fast in the bladder-trap, and their heads or tails hanging out, can be well preserved in spirits, and show the conditions well, notwithstanding that the plant becomes colourless, and there is no longer the marked contrast between the glistening white dead fish and the green bladders, which in the fresh condition renders the combination of the trap and prey conspicuous.

Mr. Simms, by whose permission I write this, intends shortly to publish an account of his observations himself. I have advised him to endeavour to prepare spirit specimens of *Utricularia* plants with numerous trapped fish *in situ* for sale to those interested in the matter who may care to apply for them. His address is 37, Broad Street, Oxford.  
H. N. MOSELEY

#### NOTES

M. PASTEUR read to the Academy of Sciences on Monday an account of his experiments on rabies. He maintains that he has twenty dogs which he has rendered insusceptible to the disease, and which, with twenty ordinary dogs, he is prepared to have bitten by a number of dogs in a rabid state. A Commission has been appointed by the French Government to test M. Pasteur's conclusions, the immense importance of which, if established, must be evident to every one. Eminent physiologists maintain, however, that M. Pasteur is far from having proved his position, and that it would be rash to give any positive opinion upon the subject until the experiment which he suggests has been made. We await the full report of M. Pasteur's paper before saying more upon

it. The following are the members of the Government Commission:—Dr. Beclard, the Dean of the Paris Faculty; M. Paul Bert, Professor of General Physiology at the Faculty of Sciences; M. Bouley, Professor of Comparative Pathology at the Museum of Natural History; Dr. Villemin, Professor of Clinical Surgery at the Military Pharmacy; Dr. Vulpian, Professor of Comparative and Experimental Pathology at the Paris Faculty of Medicine; and M. Tisserand, Director of the Agricultural Department.

PROF. HUXLEY has undertaken to be President of the Marine Biological Association. It is stated that Plymouth will probably be selected as the site of the first laboratory and experimental station erected by the Association. The Duke of Argyll, the Duke of Sutherland, and Dr. Gwyn Jeffreys, F.R.S., have given their names as vice-presidents. Mr. Chamberlain has joined the Association, and subscribed twenty guineas towards building the sea-coast laboratory. Mr. Thomasson, M.P. for Bolton, has subscribed 100*l.*

We understand that the Scottish Fishery Board have obtained sufficient funds to enable Prof. McIntosh to carry on a number of important preliminary inquiries at St. Andrew's as to the possibility of increasing by artificial means the supply of flat-fish, and also as to the spawning habits and life-history of food fishes in general. This work is in the meantime being carried on in a temporary building which for some time served as a hospital. It is hoped, however, that when the importance of the work and the many advantages which St. Andrew's offers for a marine station are recognised, that both in the interest of science and by way of developing further the great fishing industry, a well-equipped laboratory and hatching station will be provided. Dr. McIntosh has already succeeded in hatching from artificially fertilised eggs the flounder, whiting, haddock, and cod, and in determining the nature of the eggs of the gurnard and other fish. Prof. Habrecht of Utrecht is expected to work at the St. Andrew's Marine Station during the autumn.

THE DAVIS Lectures upon zoological subjects will be given in the lecture-room in the Zoological Society's Gardens, Regent's Park, on Thursdays, at 5 p.m., commencing June 5, as follows:—June 5, Man, zoologically considered, by Prof. Flower, LL.D., F.R.S.; June 12, Hands and feet, by Prof. Mivart, F.R.S.; June 19, Instinct, by G. J. Romanes, LL.D., F.R.S.; June 26, Hedgehogs, moles, and shrews, by Prof. Parker, F.R.S.; July 3, Dogs, ancient and modern, by J. E. Harting, F.L.S.; July 10, Birds' nests, by Henry Seebohm, F.L.S.; July 17, Reptiles, by P. L. Sclater, F.R.S.

THE Municipal Council of Paris has, at the instigation of the Société d'Anthropologie, given its sanction to the projected erection of a monument to Paul Broca. The spot chosen is a triangular plot of ground on the Boulevard Saint-Germain, immediately opposite the entrance gate of the new wing of the *École de Médecine*. A Commission has been appointed to decide upon the terms and conditions to be observed by those who desire to enter into the competition shortly to be opened for the honour of executing the work.

THE eighth meeting of the French National Congress of Geography will open on August 8 at Toulouse, where the local Geographical Society is organising an international exhibition, to be held from June 1 to August 15.

IN reference to his "Prize Records of Family Faculties" Mr. F. Galton writes to the *Times*:—"Permit me, as the last day for sending in the records has just gone by, to send you a brief estimate of the value of the response to my offer, so far as a very hasty inspection warrants. This value has far exceeded my expectations. I have received very little trash, and upwards of 150 good records of different families. Many of these are admirably drawn up; concise, full of information, and offering numerous opportunities of verification. As each of these returns refers to fourteen direct

ancestors of the children of the family, and to many of the brothers and sisters of each of them, the mass of anthropological material may be inferred. It certainly refers to more than 5000 persons, and as the data are all entered in my bound tabular forms, the records form a long row of thin quarto volumes, severally labelled, and easily accessible. It is a unique anthropological collection. The writers are chiefly persons of the upper and middle classes of society; they are male and female in nearly equal proportions, and the two sexes write equally well, so far as I can thus far judge. The letters that accompanied the records are full and friendly, expressing a trust that I can assure them will not be misplaced of my treating the information as strictly confidential. In many cases they express the great interest that the inquiry into their own family history has been to them. Permit me to add that I do not think it possible to determine the prizes in much less than two months, and that besides publishing the awards I propose to send a copy of them to the private address of every substantial competitor."

No. 16 of the Bibliographical Contributions of the Library of Harvard University consists of a classified index to the maps in *Petermann's Geographische Mittheilungen*, 1855-81, by Mr. Richard Bliss. The index consists of 1340 entries, and has evidently been made with the greatest care. Mr. Bliss has done a work of great utility.

IN two papers entitled "*Læ Ceneri dei Volcani di Giava supposta Causa dei Bagliori Crepuscolari*," and "*L'Isola di Giava ed i Crepuscoli del Novembre e Dicembre 1883*," recently published at Vicenza, Alvise G. Mocenigo discusses the various theories put forward to explain the late remarkable crepuscular lights that have been observed in every part of the world. He thinks the phenomena should probably be attributed to extraterrestrial, interplanetary, or cosmic conditions naturally recurring only at long intervals, and which may possibly have never before arisen since the appearance of man on the earth.

THE Mitchell Library at Glasgow still labours under that most satisfactory of difficulties—want of room in which to carry on the amount of work it could otherwise do. Seldom has this want been more heavily felt than here, where not one-tenth of its founder's bequest of 70,000*l.* has yet been expended, while an additional legacy of 11,500*l.*, exceeding the entire expenditure in books hitherto, lies unused for sheer want of space to make available any such treasures as it would secure. The moderate increase of between 4 and 5 per cent. in its total issues of books is reasonably attributed to this limitation. Glasgow has not yet adopted the Free Libraries Act, but the Corporation has placed the complete publications of the Patent Office at another library founded by Walter Stirling, a merchant of that city, in 1791. As a reference library this also is free, and a recent reorganisation has reduced the subscription to its circulating department to 10*l.* 6*s.* a year, or half that where four members of a firm enter together. This arrangement has led to a large increase of readers at both branches of this library, but that has not interfered with the use made of the Mitchell Library, and it is satisfactory to find in the Report of the latter a notice in large type referring all persons who wish to take books home to the moderate terms of the sister establishment. Still the subscribers to the latter form but a small fraction of the numbers who would be sure to avail themselves of rate-supported libraries in a great town like Glasgow, and the Mitchell Report strongly and wisely urges the adoption of the Act.

VISITORS to Canada during the forthcoming meeting of the British Association will find many useful hints and considerable practical guidance in Mr. T. Greenwood's "*Tour in the United States and Canada*." Mr. Greenwood went out and back in six weeks, and evidently made good use of his time.

THE demonstration by Dr. Herbert Carpenter of some points in the minute anatomy of Crinoids at the last meeting of the

Royal Microscopical Society was of great interest, and gave promise that his forthcoming *Challenger* Report will be of high importance as a contribution to the morphology of these Echinoderms. His exhibition of microscopic preparations of the system of cords which he and his father assert to be of a nervous nature was supplemented by an interesting account by Dr. Carpenter, C.B., of the observations and experiments which had led to the conviction as to their nervous nature, which is gradually being accepted by other investigators.

M. MASCART, Professor at the College of France, will give a discourse at the Royal Institution on Friday evening, May 30, the subject being "Sur les Couleurs."

WE regret to learn of the death of Mr. Henry Baden Pritchard, whose name has been so long connected with the *Photographic News*, and with the photographic world in general.

A STRONG earthquake shock causing some damage was felt last week at Panderma and Erdek in the province of Broussa, Asia Minor. Two slight shocks, unattended by any damage, have occurred at Balikesri in the same province.

AT a meeting of the Governors of North Wales University, held last week at Bangor, Mr. Henry Rudolf Reichel, M.A., Fellow of All Souls College, Oxford, was elected Principal of the College.

THAT the railway should be the means of enriching the flora of a district seems strange. This has, however, been shown to be the case in Arbrá parish, in the province of Helsingland, Sweden. Thus, since the extension of the Great Northern main line into this province in 1878, no less than seven new species of plants have immigrated along the line. They are *Galium mollugo*, *Plantago lanceolata*, *Euphorbia helioscopia*, *Dactylis glomerata*, *Bunias orientalis*, *Avena fatua*, and an American importation, *Rudbeckia hirta* (L.). That these must owe their introduction to the railway is clearly demonstrated by the fact that in spite of the closest scrutiny these plants have never before been found in this district, and that they are even now confined to the railway embankment and its immediate vicinity. The four first-named have, in all probability, only come from the parishes south of Arbrá, but the *Bunias orientalis* and *Avena fatua* have no doubt travelled along the line all the way from the province of Gestrkland, to whose flora they belong. The last-named, *Rudbeckia hirta*, which hails from the eastern part of the United States, seems to follow in the track of the navy in the whole of Northern Sweden. In the summer of 1880 it was seen some ten miles south of Bollnäs station; in 1882 it appeared for the first time at Arbrá, about twenty miles further up the railway line; and last year it had travelled as far as Torps parish, in the province of Medelpad, i.e. a distance in four years of about one degree.

A CORRESPONDENT writes in reference to Prof. McKenny Hughes' article on earthworms, that the worst consequence of the sea going over the walls in the Somerset low grounds is that it kills the worms, thousands of which come to the surface and die in agony, and the farmers are very sensible of the evil done to the land for a long time afterwards.

MESSRS. CROSBY LOCKWOOD AND CO. inform us that they will shortly publish "A Treatise on Earthy and other Minerals and Mining," by D. C. Davies, F.G.S. The work, which is uniform with and forms a companion volume to the same author's "Treatise on Metalliferous Minerals and Mining," will be fully illustrated. The same publishers announce a work on an entirely new subject, viz. "Stone-working Machinery, and the Rapid and Economical Conversion of Stone, with Hints on the Arrangement and Management of Stone-Works," by M. Powis Bale, M.Inst.M.E., A.M.Inst.C.E. Messrs. Crosby

Lockwood and Co. also announce "The Blowpipe in Chemistry, Mineralogy, and Geology," by Lieut.-Col. Ross.

THE additions to the Zoological Society's Gardens during the past week include a Hodgson's Partridge (*Perdix hodgsoniae*), presented by Mr. W. Jamrach; a Bonnet Monkey (*Macacus radiatus*), presented by Mr. A. King; two Japanese Pheasants (*Phasianus versicolor*), two Egyptian Geese (*Chenalopex aegyptiaca*), a White American Crane (*Grus americana*), thirteen Green Lizards (*Lacerta viridis*), purchased; two Common Vipers, presented by Mr. W. H. B. Pain; a Common Partridge (*Perdix cinerea*), presented by Mr. R. Steele; a Banded Ichneumon (*Herpestes fasciatus*), presented by Master Adams; twelve Variegated Sheldrakes (*Tadorna variegata*), four Soft-billed Ducks (*Hymenolemus malacorhynchus*), a Bernicle Goose (*Demncla leucopsis*), an Argentine Tortoise (*Testudo argentina*), presented by Mr. Wm. Petty.

OUR ASTRONOMICAL COLUMN

A NEW COMET OF SHORT PERIOD.—M. Schulhof of Paris has lately ascertained that the observations of the third comet of 1858 (a very limited number) are closely represented by an elliptical orbit with a period of about six years and a half. The comet in question was discovered by Mr. H. P. Tuttle at the Observatory of Cambridge, Mass., on the evening of May 2; it was observed there until May 12, and likewise at Ann Arbor by the late Prof. Watson from May 9 until June 1. Eight observations in all are available for the calculation of the orbit, and upon these M. Schulhof bases four positions, from which he deduces the following elements:—

Perihelion passage, 1858 May 2.96719 G.M.T.

Longitude of perihelion ... ..	200 46 27.1
"    ascending node ... ..	175 4 8.5
Inclination ... ..	19 30 2.0
Angle of eccentricity ... ..	41 21 5.2
Mean daily sidereal motion ... ..	536".881

From these elements we find—

Eccentricity ... ..	0.660676	Perihelion distance	1.1950
Semi-axis major ... ..	3.5217	Revolution ... ..	6.609 years
"    minor ... ..	2.6436		

M. Schulhof finds the limits for the mean daily motion 612" and 470" corresponding to periods of 5.80 and 7.55 years.

With such elements the comet must approach very near to the orbit of Jupiter, as is the case with nearly all the comets of the short-period group; and with the most probable period (6.6 years) would come into close proximity to the planet in 1879 and 1880. It unfortunately happens that an endeavour to identify this comet with any one of the imperfectly observed comets of past times, or with missing nebulous objects, has so far been fruitless, and hence much uncertainty remains as to the true length of the revolution, but M. Schulhof has prepared sweeping-ephemerides, of which a part is printed in No. 2590 of the *Astronomische Nachrichten*: it contains the sweeping-line for every fourth degree of the sun's true longitude from 40° to 104°. At the time of discovery in 1858 the comet was a very faint object in the comet-seeker, and continued faint during the month that it was observed. To this circumstance and unfavourable weather is attributed its not having been seen at Washington; it was not observed in Europe. Parabolic elements were computed by Profs. Hall and Watson, but no suspicion of periodicity could have arisen from the results of their calculations beyond what comparatively small inclination and direct motion might have suggested; indeed we believe it is somewhere upon record that Prof. Hall considered the tendency was rather towards a hyperbolic orbit. M. Schulhof's merit in drawing the attention of astronomers to the real nature of the comet's path is so much the greater.

Could reliance be placed upon the period given by the few observations in our possession as the most probable one, a return to perihelion might be expected in October next, but as already remarked such period would have brought the comet into close proximity to the planet Jupiter in 1879-80, and the next perihelion passage might be considerably affected thereby. Further, it is to be remarked that with perihelion passage in the middle

of October there would be little or no chance of recovering the comet.

The comet's heliocentric equatorial-coordinates at perihelion are—

$$\alpha \dots -1^{\circ}11'48 \quad \gamma \dots -0^{\circ}43'05 \quad z \dots +0^{\circ}00'18.$$

If we combine these with the sun's coordinates, X, Y, Z, in the *Nautical Almanac*, we readily obtain an idea as to the chances of finding the comet, according to different assumed dates of arrival at perihelion. The most advantageous conditions are presented when this falls about the middle of April. If we assume April 11, the R.A. is found to be  $208^{\circ}$ , N.P.D.  $54^{\circ}$ , and the intensity of light 11.05, which is four times greater than on the date of the comet's discovery by Tuttle in 1858. As it was then extremely faint, its rediscovery may be a matter of difficulty. We have already one "Tuttle's comet," of short period, and it may perhaps occur to astronomers that the third of 1858 will be aptly named *Schulhof's comet*.

### CHEMICAL NOTES

POTILITZIN has recently (*Ber.*, xvii. 276) made some interesting observations on the hydration and dehydration of cobalt chloride. He shows that, besides the already known hydrate  $\text{CoCl}_2 \cdot 6\text{H}_2\text{O}$ , there exist two hydrates,  $\text{CoCl}_2 \cdot 2\text{H}_2\text{O}$  and  $\text{CoCl}_2 \cdot \text{H}_2\text{O}$ , the former being rose-red in colour, and the latter dark violet. When the dehydrated salt is heated to about  $100^{\circ}$ , it parts with water, which is again absorbed on cooling. When an aqueous solution of the ordinary hexhydrated salt is heated, or is mixed with a dehydrating agent, the colour changes from pink to blue or dark violet. Potilitzin shows that this change, which he proves to be due to partial decomposition of the hexhydrated salt, may be brought about without raising temperature by the capillary action of unsized paper or a porous plate of stucco.

TOLLENS has made experiments on the sugar-like substance obtained by the action of alkalis on an aqueous solution of formaldehyde. He oxidises methylic alcohol by air in presence of platinum foil at  $54^{\circ}$ - $55^{\circ}$ , and distils; he then treats the crude distillate with baryta water, and so obtains a yellowish precipitate, which, when freed from barium, yields an amorphous syrup that reduces Fehling's solution, and gives results on analysis approximating to the formula  $\text{C}_6\text{H}_{10}\text{O}_6$ . This syrup is optically inactive, and does not undergo fermentation; on treatment with sulphuric acid, it gives formic and lactic acids (*Landw. Versuchs-Statt.*, xxix. 355).

KANNONIKOW (*Ber.*, xvii. p. 157, abstracts) attempts to measure the refraction-equivalents of various metals by deducting the refraction-equivalents of salts of these metals with organic acids (determined with aqueous solutions of the salts) from the refraction-equivalents of the acids themselves. So far as his results go, they appear to indicate that the refraction-equivalents vary periodically with variations in the atomic weights of the metals.

MM. NILSON AND PETTERSON have prepared pure beryllium chloride by heating the metal in perfectly dry hydrochloric acid gas, and have determined the density of the vapour of this compound. Beryllium chloride can be volatilised without decomposition in an atmosphere of dry nitrogen or carbon dioxide, provided every trace of air is excluded. The density of the gaseous compound for the temperature-interval  $686^{\circ}$ - $812^{\circ}$  agrees with that calculated from the formula  $\text{BeCl}_2$  ( $\text{Be} = 9.1$ ). The question as to the value to be assigned to the atomic weight of beryllium, which has been so much discussed of late, appears to be now finally settled in favour of the number deduced by applying the periodic law to the study of the properties of this metal and its compounds (*Ber.* xvii. 987).

CONTINUING the researches of Krämers, Prof. Mendeléeff has shown at a recent meeting of the Russian Chemical Society (*Journal of the Society*, vol. xvi. fasc. 2) that the densities of solutions of salts increase together with the increase of their molecular weights. Thus if we take the series of salts  $\text{HCl}$ ,  $\text{LiCl}$ ,  $\text{NaCl}$ ,  $\text{KCl}$ , . . .  $\text{BaCl}_2$ ,  $\text{SnCl}_4$ ,  $\text{HgCl}_2$ , and  $\text{Fe}_2\text{Cl}_6$ , the molecular weights of which are respectively 36.5, 42.5, 58.5, 74.5, . . . 208, 259, 271, and 325, the densities of their solutions in 100 parts of water, at  $15^{\circ}$  to  $20^{\circ}$ , are: 1.010, 1.014, 1.023, 1.025, . . . 1.098, 1.106, 1.128 (calculated), and 1.134. The densities increase as the molecular weights increase; but if we take, instead of the molecular weights, the weights of their

equivalents, or those of the equivalents of metals, the regularity of increase disappears. Prof. Mendeléeff adds that the above is true, not only with regard to chlorides, but also with regard to the salts of bromine and iodine, and many others. Reserving to himself further to pursue his researches in this way, Prof. Mendeléeff points out the following relation:—If the molecular weight of the dissolved body be  $M$ , and the solution be represented by  $nM + 100\text{H}_2\text{O}$  (where  $n$  represents the number of molecules), the density,  $D$ , of the solution may be expressed for many bodies by the following equation:— $\left(\frac{n}{D-D_0}\right)^k = A + Bn$ ,

where  $D_0$  is the density of water, and  $k$  is equal to unity, or very near to it. This equation must be considered, however, only as preliminary, ulterior researches promising to give a more general formula.  $A$  and  $B$  are two constants, which vary with the temperat. e. Thus, for  $\text{HCl}$  at  $0^{\circ}$  (the density of water at  $4^{\circ}$  being taken = 1),  $A = 94.5$  and  $B = 1.725$ ; at  $20^{\circ}$ ,  $A = 102.2$ , and  $B = 1.80$ ; at  $40^{\circ}$   $A = 106.2$ , and  $B = 1.85$ ; at  $60^{\circ}$   $A = 105.2$ , and  $B = 2.05$ ; at  $80^{\circ}$   $A = 100.6$ , and  $B = 2.25$ ; and at  $100^{\circ}$   $A = 94.5$ , and  $B = 2.55$ , the coefficient  $k$  being in all cases equal to unity.

### ON THE NOMENCLATURE, ORIGIN, AND DISTRIBUTION OF DEEP-SEA DEPOSITS<sup>1</sup>

#### Introduction

THE sea is unquestionably the most powerful dynamic agent on the surface of the globe, and its effects are deeply imprinted on the external crust of our planet; but among the sedimentary deposits which are attributed to its action, and among the effects which it has wrought on the surface features of the earth, the attention of geologists has, till within quite recent times, been principally directed to the phenomena which take place in the immediate vicinity of the land. It is incontestable that the action of the sea along coasts and in shallow water has played the largest part in the formation and accumulation of those marine sediments which, so far as we can observe, form the principal strata of the solid crust of the globe; and it has been from an attentive study of the phenomena which take place along the shores of modern seas that we have been able to reconstruct in some degree the conditions under which the marine deposits of ancient times were laid down.

Attention has been paid only in a very limited degree to deposits of the same order, and, for the greater part, of the same origin, which differ from the sands and gravels of the shores and shallow waters only by a lesser size of the grains, and by the fact that they are laid down at a greater distance from the land and in deeper water. And still less attention has been paid to those true deep-sea deposits which are only known through systematic submarine investigations. One might well ask what deposits are now taking place, or have in past ages taken place, at the bottom of the great oceans at points far removed from land, and in regions where the erosive and transporting action of water has little or no influence. Without denying that the action of the tidal waves can, under certain special conditions, exert an erosive and transporting power at great depths in the ocean, especially on submerged peaks and barriers, it is none the less certain that these are exceptional cases, and that the action of waves is almost exclusively confined to the coasts of emerged land. There are in the Pacific immense stretches of thousands of miles where we do not encounter any land, and in the Atlantic we have similar conditions. What takes place in these vast regions where the waves exercise no mechanical action on any solid object? We are about to answer this question by reference to the facts which an examination of deep-sea sediments has furnished.

A study of the sediments recently collected in the deep sea shows that their nature and mode of formation, as well as their geographical and bathymetrical distribution, permit deductions to be made which have a great and increasing importance from a geological point of view. In making known the composition of these deposits and their distribution, the first outlines of a geological map of the bottom of the ocean will be sketched.

This is not the place to give a detailed history of the various contributions to our knowledge of the terrigenous deposits in deep water near land, or of those true deep-sea deposits far removed from land, which may be said to form the special subject of this communication. From the time of the first expeditions under-

<sup>1</sup> A Paper read before the Royal Society of Edinburgh by John Murray and A. Renard. Communicated by John Murray

taken with a view of ascertaining the depth of the ocean, small quantities of mud have been collected by the sounding lead and briefly described. We may recall in this connection the experiments of Ross and the observations of Hooker and Maury. These investigations, made with more or less imperfect appliances, immediately fixed the attention, without however giving sufficient information on which to establish any general conclusions as to the nature of the deposits or their distribution in the depths of the sea.

When systematic soundings were undertaken with a view of establishing telegraphic communication between Europe and America, the attention of many distinguished men was directed to the importance, in a biological and geological sense, of the specimens of mud brought up from great depths. The observations of Wallich, Huxley, Agassiz, Baily, Pourtales, Carpenter, Thomson, and many others, while not neglecting mineralogical and chemical composition, deal with this only in a subordinate manner. The small quantities of each specimen at their command, and the limited areas from which they were collected, did not permit the establishment of any general laws as to their composition or geographical and bathymetrical distribution. These early researches, however, directed attention to the geological importance of deep-sea deposits, and prepared the way for the expeditions organised with the special object of a scientific exploration of the great ocean basins.

The expedition of the *Challenger* takes the first rank in these investigations. During that expedition a large amount of material was collected and brought to England for fuller study under the charge of Mr. Murray, who has in several preliminary papers pointed out the composition and varieties of deposits which are now forming over the floor of the great oceans. In order to arrive at results as general as possible, it was resolved to investigate the subject from the biological, mineralogical, and chemical points of view, and M. Renard was associated with Mr. Murray in the work. In addition to the valuable collections and observations made by the *Challenger*, we have had for examination material collected by other British ships, such as the *Porcupine*, *Bulldog*, *Valorous*, *Nassau*, *Swallow*, *Dive*; and, through Prof. Mohn, by the Norwegian North Atlantic Expedition. Again, through the liberality of the United States Coast Survey and Mr. A. Agassiz, the material amassed in the splendid series of soundings taken by the American ships *Tuscarora*, *Blake*, and *Geltyburg*, were placed in our hands. The results at which we have arrived may therefore be said to have been derived from a study of all the important available material.

The work connected with the examination and description of these large collections is not yet completed, but it is sufficiently advanced to permit some general conclusions to be drawn which appear to be of considerable importance. In addition to descriptions and results, we shall briefly state the methods we have adopted in the study. All the details of our research will be given in the Report on the Deep-Sea Deposits in the *Challenger* series, which will be accompanied by charts indicating the distribution, plates showing the principal types of deposits as seen by the microscope, and numerous analyses giving the chemical composition and its relation to the mineralogical composition. The description of each sediment will be accompanied by an enumeration of the organisms dredged with the sample, so as to furnish all the biological and mineralogical information which we possess on deep-sea deposits, and finally, we shall endeavour to establish general conclusions which can only be indicated at present.

Before entering on the subject, we believe it right to point out the difficulties which necessarily accompany such a research as the one now under consideration, difficulties which arise often in part from the small quantity of the substance at our disposal, but also from the very nature of the deposit. Since we have endeavoured to determine, with great exactitude, the composition of the deposit at any given point, we have, whenever possible, taken the sample collected in the sounding-tube. That procured by the trawl or dredge, although usually much larger, is not considered so satisfactory on account of the washing and sorting to which the deposit has been subjected while being hauled through a great depth of water. We have, however, always examined carefully the contents of these instruments, although we do not think the material gives such a just idea of the deposit as the sample collected by the sounding-tube. The material collected by the last-named instrument has been taken as the basis of our investigations, although the small quantity often gives to it an inherent difficulty. It was the

small quantity of substance collected by the sounding-tube in early expeditions which prevented the first observers from arriving at any definite results; but when such small samples are supplemented by occasional large hauls from the dredge or trawl, they become much more valuable and indicative of the nature of the deposit as a whole. Not only the scantiness of the material, but the small size of the grains, which in most instances make up deep-sea deposits, render the determinations difficult. In spite of the improvements recently effected in the microscopical examination of minerals, it is impossible to apply all the optical resources of the instrument to the determination of the species of extremely fine, loose, and fractured particles. Again, the examination of these deposits is rendered difficult by the presence of a large quantity of amorphous mineral matter, and of shells, skeletons, and minute particles of organic origin. It is also to be observed that we have not to deal with pure and unaltered mineral fragments, but with particles upon which the chemical action of the sea has wrought great changes, and more or less destroyed their distinctive characters.

What still further complicates these researches is the endeavour to discover the origin of the heterogeneous materials which make up the deposits. These have been subjected to the influence of a great number of agents of some of which our knowledge is to a great extent still in its infancy. We must take into account a large number of agents and processes, such as ocean currents; the distribution of temperature in the water at the surface and at the bottom; the distribution of organisms as dependent on temperature and specific gravity of the water; the influence of aerial currents; the carrying power of rivers; the limit of transport by waves; the eruptions of aerial and submarine volcanoes; the effect of glaciers in transporting mineral particles, and, when melting, influencing the specific gravity of the water, which in turn affects the animal and plant life of the surface. It is necessary to study the chemical reactions which take place in great depths; in short, to call to our aid all the assistance which the physical and biological sciences can furnish. It will thus be understood that the task, like all first attempts in a new field, is one of exceptional difficulty, and demands continued effort to carry it to a successful issue.

In presenting a short *résumé* of our methods, of the nomenclature we have adopted, and of the investigation into the origin of the deposits in the deep sea and deeper parts of the littoral zones, we offer it as a sketch of our research, prepared to modify the arrangements in any way which an intelligent criticism may suggest.

Before proceeding to a description of methods and of the varieties of deposits, with their distribution in modern oceans, we will briefly enumerate the materials which our examination has shown take part in the formation of these deposits, state the origin of these materials, and the agents concerned in their deposition, distribution, and modification.

*Materials.*—The materials which unite to form the deposits which we have to describe may be divided into two groups, viewed in relation to their origin, viz., mineral and organic.

The mineral particles carried into the ocean have a different form and size, according to the agents which have been concerned in their transport. Generally speaking, their size diminishes with distance from the coast, but here we limit our remarks to the mineralogical character of the particles. We find isolated fragments of rocks and minerals coming from the crystalline and schisto-crystalline series, and from the clastic and sedimentary formations; according to the nature of the nearest coasts they belong to granite, diorite, diabase, porphyry, &c.; crystalline schists, ancient limestones, and the sedimentary rocks of all geological ages, with the minerals which come from their disintegration, such as quartz, monoclinic and triclinic feldspars, hornblende, augite, rhombic pyroxene, olivine, muscovite, biotite, titanite and magnetic iron, tourmaline, garnet, epidote, and other secondary minerals. The trituration and decomposition of these rocks and minerals give rise to materials more or less amorphous and without distinctive characters, but the origin of which is indicated by association with the rocks and minerals just mentioned.

Although the debris of continental land to which we have just referred plays the most important rôle in the immediate vicinity of shores, yet our researches show beyond doubt that when we pass out towards the central parts of the great ocean basins, the debris of continental rocks gradually disappears from the deposits, and its place is taken by materials derived from modern volcanic rocks, such as basalts, trachytes, augite-andesites, and vitreous

varieties of these lithological families, for instance, pumice, and loose, incoherent, volcanic particles of recent eruptions, with their characteristic minerals. All these mineral substances being usually extremely fine or areolar in structure, are easily attacked by the sea water at the place where they are deposited. This chemical action brings about an alteration of the minerals and vitreous fragments, which soon passes into complete decomposition, and in special circumstances gives rise to the formation of secondary products. In some places the bottom of the sea is covered with deposits due to this chemical action, principal among which is clayey matter, associated with which there are often concretions composed of manganese and iron. In other regions the reactions which result in the formation of argillaceous matter from volcanic products give rise also to the formation of zeolites.

Among other products arising from chemical action, probably combined with the activity of organic matter, may be mentioned the formation of glauconite and phosphatic nodules, with, in some rare and doubtful examples, the deposition of silica. The decomposition of the tissues, shells, and skeletons of organisms adds small quantities of iron, fluorine, and phosphoric acid to the inorganic constituents of the deep-sea deposits.

Finally, we must mention extra-terrestrial substances in the form of cosmic dust.

We now pass to the consideration of the rôle played by organisms in the formation of marine deposits. Organisms living at the surface of the ocean, along the coasts, and at the bottom of the sea are continually extracting the lime, magnesia, and silica held in solution in sea water. The shells and skeletons of these, after the death of the animals and plants, accumulate at the bottom and give rise to calcareous and siliceous deposits. The calcareous deposits are made up of the remains of coccospheres, rhabdospheres, pelagic and deep-sea Foraminifera, pelagic and deep-sea Mollusks, Corals, Alcyonarians, Polyzoa, Echinoderms, Annelids, Fish, and other organisms. The siliceous deposits are formed principally of frustules of Diatoms, skeletons of Radiolarians, and spicules of Sponges.

While the minute pelagic and deep-sea organisms above mentioned play by far the most important part in the formation of deep-sea deposits, the influence of Vertebrates is recognisable only in a very slight degree in some special regions by the presence of large numbers of sharks' teeth, and the ear-bones and a few other bones of whales. The otoliths of fish are usually present in the deposits, but, with the exception of two vertebrae and a scapula, no other bones of fish have been detected in the large amount of material we have examined.

*Agents.*—Having passed in review the various materials which go to the formation of deposits in the deep water immediately surrounding the land and in the truly oceanic areas, attention must now be directed to the agents which are concerned in the transport and distribution of these, and to the sphere of their action. The relations existing between the organic and inorganic elements of deposits to which we have just referred, and the laws which determine their distribution, will be pointed out at the same time.

The fluids which envelop the solid crust of the globe are incessantly at work disintegrating the materials of the land, which, becoming loose and transportable, are carried away, sometimes by the atmosphere, sometimes by water, to lower regions, and are eventually borne to the ocean in the form of solid particles or as matter in solution. The atmosphere when agitated, after having broken up the solid rock, transports the particles from the continents, and in some regions carries them far out to sea, where they form an appreciable portion of the deposit; as, for instance, off the west coast of North Africa and the south-west coast of Australia. Again, in times of volcanic eruptions, the dust and scoria which are shot into the air are carried immense distances by winds and atmospheric currents, and no small portion eventually falls into the sea.

Water is, however, the most powerful agent concerned in the formation and distribution of marine sediments. Running water corrodes the surface of the land, and carries the triturated fragments down into the ocean. The waters of the ocean, in the form of waves and tides, attack the coasts and distribute the debris at a lower level. Independently of the action of waves, there exist along most coasts currents, more or less constant, which have an effect in removing sand, gravel, and pebbles further from their origin. Generally, terrestrial matters appear to be distributed by these means to a distance of one or two hundred miles from the coast. Waves and currents probably have no erosive or trans-

porting power at depths greater than 200 or 300 fathoms, and even at such depths it is necessary that there should be some local and special conditions in order that the agitated water may produce any mechanical effect. However, it is not improbable that, by a peculiar configuration of the bottom and ridges among oceanic islands, the deposit on a ridge may be disturbed by the tidal wave even at 1000 fathoms; and this may be the cause of the hard ground sometimes met with in such positions. By observations off the coast of France it has been shown that fine mud is at times disturbed at a depth of 150 fathoms; but, while admitting that this is the case on exposed coasts, the majority of observations indicate that beyond 100 fathoms it is an oscillation of the water, rather than a movement capable of exerting any geological action, which concerns us in this connection.

Although the great oceanic currents have no direct influence upon the bottom, yet they have a very important indirect effect on deposits, because the organisms which live in the warm equatorial currents form a very large part of the sediment being deposited there, and this in consequence differs greatly from the deposits forming in regions where the surface water is colder. In the same way a high or low specific gravity of the surface water has an important bearing on the animal and vegetable life of the ocean, and this in its turn affects the character of the deposits.

The thermometric observations of the *Challenger* show that a slow movement of cold water must take place in all the greater depths of the ocean from the poles, but particularly from the southern pole, towards the equator. It could be shown from many lines of argument that this extremely slow massive movement of the water can have no direct influence on the distribution of marine sediments.

Glaciers, which eventually become icebergs that are carried far out to sea by currents, transport detrital matter from the land to the ocean, and thus modify in the Arctic and Antarctic regions the deposits taking place in the regions affected by them. The detritus from icebergs in the Atlantic can be traced as far south as latitude 36° off the American coast, and in the southern hemisphere as far north as latitude 40°.

The fact that sea water retains fine matter in suspension for a much shorter time than fresh water should be referred to here as having an important influence in limiting the distribution of fine argillaceous and other materials borne down to the sea by rivers, thus giving a distinctive character to deposits forming near land.

We have pointed out the influence of temperature and salinity upon the distribution of the surface organisms whose skeletons form a large part of some oceanic deposits, and may state also that the bathymetrical distribution of calcareous organisms is influenced by the chemical action of sea water. We will return to these influences presently when describing the distribution of the various kinds of deposits and their reciprocal relations, especially in those regions of the deep sea far removed from the mechanical action of rivers, waves, and superficial currents. The action of life as a geological agent has been indicated under the heading *Materials*.

*Methods.*—We give here an example showing the order followed in describing the deposits examined:—

Station 338; lat. 21° 15' S., long. 14° 2' W.; March 21, 1876; surface temperature 76°·5, bottom temperature 36°·5, depth 1990 fathoms.

GLOBIGERINA Ooze, white with slight rosy tinge when wet; granular, homogeneous, and very slightly coherent when dry; resembles chalk.

i. *Carbonate of Calcium*, 90·38 per cent., consists of pelagic Foraminifera (80 per cent.); coccoliths and rhabdoliths (9 per cent.); Miliolids, Discorbinas, and other Foraminifera, Ostracode valves, fragments of Echini spines, and one or two small fragments of Pteropods (1·38 per cent.).

ii. *Residue*, 9·62 per cent., reddish brown; consists of—

1. *Minerals* [1·62] m. di. 0·45 mm., fragments of feldspar, hornblende, magnetite, magnetic spherules, a few small grains of manganese, and pumice.

2. *Siliceous Organisms* [1·00], Radiolarians, spicules of Sponges, and imperfect casts of Foraminifera.

3. *Fine Washings* [7·00], Argillaceous matter with small mineral particles and fragments of pumice and siliceous organisms.

The description of the deposits has been made upon this plan, which was adopted after many trials and much consideration.

This is not the place to give the reasons which have guided us in adopting this mode of description, or to give in detail the methods that we have systematically employed for all the sediments which we are engaged in describing. These will be fully given in the introduction to our *Challenger* Report. We limit ourselves here to explaining the meanings and arrangement of terms and abbreviations, so that the method may be understood and made available for others.

The description commences by indicating the kind of deposit (red clay, blue mud, Globigerina ooze, &c.), with the macroscopic characters of the deposit, when wet or dry.

We have always endeavoured to give a complete chemical analysis of the deposit, but when it was impossible to do this we have always determined the amount of *Carbonate of Calcium*. This determination was generally made by estimating the carbonic acid. We usually took a gramme of a mean sample of the substance for this purpose, using weak and cold hydrochloric acid. However, as the deposits often contain carbonates of magnesia and iron as well, the results calculated by associating the carbonic acid with the lime are not perfectly exact, but these carbonates of magnesia and iron are almost always in very small proportion, and the process is, we think, sufficiently accurate, for, owing to the sorting of the elements which goes on during collection and carriage, no two samples from the same station give exactly the same percentage. The number which follows the words "*Carbonate of Calcium*" indicates the percentage of  $\text{CaCO}_3$ ; we then give the general designations of the principal calcareous organisms in the deposit.

The part insoluble in the hydrochloric acid, after the determination of the carbonic acid, is designated in our descriptions "*Residue*." The number placed after this word indicates its percentage in the deposit; then follow the colour and principal physical properties. This residue is washed and submitted to decantations, which separate the several constituents according to their density; these form three groups—(1) *Minerals*, (2) *Siliceous Organisms*, (3) *Fine Washings*.

1. *Minerals*.—The number within brackets indicates the percentage of particular minerals and fragments of rocks. This number is the result of an approximate evaluation, of which we will give the basis in our report. As it is important to determine the dimensions of the grains of minerals which constitute the deposit, we give, after the contraction *m. di.*, their mean diameter in millimetres. We give next the form of the grains, if they are rounded or angular, &c.; then the enumeration of the species of minerals and rocks. In this enumeration we have placed the minerals in the order of the importance of the *rocks* which they play in the deposit. The specific determinations have been made with the mineralogical microscope in parallel or convergent polarised light.

2. *Siliceous Organisms*.—The number between brackets indicates the percentage of siliceous organic remains; we obtain it in the same manner as that placed after the word *Minerals*. The siliceous organisms and their fragments are examined with the microscope and determined. We have also placed under this heading the glauconitic casts of the Foraminifera and other calcareous organisms.

3. *Fine Washings*.—We designate by this name the particles which, resting in suspension, pass with the first decantation. They are about 0.05 mm. or less in diameter. We have been unable to arrange this microscopic matter under the category of *Minerals*, for, owing to its minute and fragmentary nature, it is impossible to determine the species. We have always found that the *Fine Washings* increase in quantity as the deposit passes to a clay, and it is from this point of view that the subdivision has its *raison d'être*. We often designate the lightest particles by the name argillaceous matter, but usually there are associated with this very small particles of indeterminate minerals and fragments of siliceous organisms. The number within brackets which follows the words *Fine Washings* is obtained in the same manner as those placed after *Minerals* and *Siliceous Organisms*.

These few words will suffice to render the descriptions intelligible. Greater details will be given, as already stated, in the *Challenger* Report. It may be added that in the majority of cases we have solidified the sediments and formed them into thin slides for microscopic examination, and that at all times the examination by transmitted light has been carried on at the same time as the examination by reflected light. Each description is followed by notes upon the dredging or sounding, upon the animals collected, and a discussion of the analysis whenever a

complete analysis has been made, which is always the case with typical samples of the deposits.

*Kinds of Deposits*.—We now proceed to the description of the various types of deposits into which it is proposed to divide the marine formations that are now taking place in the deeper water of the various oceans and seas. We will speak first of those which are met with in the deeper water of inland seas, and around the coasts of continents and islands, and afterwards of those which are found in the abyssal regions of the great oceans. Those coast formations which are being laid down on the shores, or in very shallow water, and which have been somewhat carefully described previous to the recent deep-sea explorations, are here neglected.

A study of the collections made by the *Challenger* and other expeditions show—

(1) That in the deeper water around continents and islands which are neither of volcanic nor coral origin, the sediments are essentially composed of a mixture of sandy and amorphous matter, with a few remains of surface organisms, to which we give the name of *muds*, and which may be distinguished macroscopically by their colour. We distinguish them by the names, *blue*, *red*, and *green muds*.

(2) Around volcanic islands the deposits are chiefly composed of mineral fragments derived from the decomposition of volcanic rocks. These, according to the size of the grains, are called *volcanic muds or sands*.

(3) Near coral islands and along shores fringed by coral reefs, the deposits are calcareous, derived chiefly from the disintegration of the neighbouring reefs, but they receive large additions from shells and skeletons of pelagic organisms, as well as from animals living at the bottom. These are named, according to circumstances, *coral or coralline muds and sands*.

Let us now see what are the chief characteristics of each of these deposits.

*Blue mud* is the most extensive deposit now forming around the great continents and continental islands, and in all inclosed or partially inclosed seas. It is characterised by a slaty colour which passes in most cases into a thin layer of a reddish colour at the upper surface. These deposits are coloured blue by organic matter in a state of decomposition, and frequently give off an odour of sulphuretted hydrogen. When dried, a blue mud is grayish in colour, and rarely or never has the plasticity and compactness of a true clay. It is finely granular, and occasionally contains fragments of rocks 2 cm. in diameter; generally, however, the minerals, which are derived from the continents, and are found mixed up with the muddy matter in these deposits, have a diameter of 0.5 mm. and less. Quartz particles, often rounded, play the principal part, next come mica, feldspar, augite, hornblende, and all the mineral species which come from the disintegration of the neighbouring lands, or the lands traversed by rivers which enter the sea near the place where the specimens have been collected. These minerals make up the principal and characteristic portion of blue muds, sometimes forming 80 per cent of the whole deposit. Glauconite, though generally present, is never abundant in blue muds. The remains of calcareous organisms are at times quite absent, but occasionally they form over 50 per cent. The latter is the case when the specimen is taken at a considerable distance from the coast and at a moderate depth. These calcareous fragments consist of bottom-living and pelagic Foraminifera, Mollusks, Polyzoa, Serpulæ, Echinoderms, Alcyonarian-spicules, Corals, &c. The remains of Diatoms and Radiolarians are usually present. Generally speaking, as we approach the shore the pelagic organisms disappear; and on the contrary, as we proceed seawards, the size of the mineral grains diminishes, and the remains of shore and coast organisms give place to pelagic ones, till finally a blue mud passes into a true deep-sea deposit. In those regions of the ocean affected with floating ice, the colour of these deposits becomes gray rather than blue at great distances from land, and is further modified by the presence of a greater or less abundance of glaciated blocks and fragments of quartz.

*Green Muds and Sands*.—As regards their origin, composition, and distribution near the shores of continental land, these muds and sands resemble the blue muds. They are largely composed of argillaceous matter and mineral particles of the same size and nature as in the blue muds. Their chief characteristic is the presence of a considerable quantity of glauconitic grains, either isolated or united into concretions. In the latter case the grains are cemented together by a brown argillaceous matter, and include, besides quartz, feldspars, phosphate of lime, and other



minerals, more or less altered. The Foraminifera and fragments of Echinoderms and other organisms in these muds are frequently filled with glauconitic substance, and beautiful casts of these organisms remain after treatment with weak acid. At times there are few calcareous organisms in these deposits, and at other times the remains of Diatoms and Radiolarians are abundant. When these muds are dried they become earthy and of a gray-green colour. They frequently give out a sulphuretted hydrogen odour. The green colour appears sometimes to be due to the presence of organic matter, probably of vegetable origin, and to the reduction of peroxide of iron to protoxide under its influence. The *green sands* differ from the muds only in the comparative absence of the argillaceous and other amorphous matter, and by the more important part played by the grains of glauconite, which chiefly give the green colour to these sands.

*Red Muds.*—In some localities, as for instance off the Brazilian coast of America, the deposits differ from blue muds by the large quantity of ochreous matter brought down by the rivers and deposited along the coast. The ferruginous particles when mixed up with the argillaceous matter give the whole deposit a reddish colour. These deposits, rich in iron in the state of limonite, do not appear to contain any traces of glauconite, and have relatively few remains of siliceous organisms.

*Volcanic Muds and Sands.*—The muds and sands around volcanic islands are black or gray; when dried they are rarely coherent. The mineral particles are generally fragmentary, and consist of lapilli of the basic and acid series of modern volcanic rocks, which are scoriaceous or compact, vitreous or crystalline, and usually present traces of alteration. The minerals are sometimes isolated, sometimes surrounded by their matrix, and consist principally of plagioclases, sanadin, amphibole, pyroxene, biotite, olivine, and magnetic iron; the size of the particles diminishes with distance from the shore, but the mean diameter is generally 0.5 mm. Glauconite does not appear to be present in these deposits, and quartz is also very rare or absent. The fragments of shells and rocks are frequently covered with a coating of peroxide of manganese. Shells of calcareous organisms are often present in great abundance, and render the deposit of a lighter colour. The remains of Diatoms and Radiolarians are usually present.

*Coral Muds.*—These muds frequently contain as much as 95 per cent. of carbonate of lime, which consists of fragments of Corals, calcareous Algae, Foraminifera, Serpulæ, Mollusks, and remains of other lime-secreting organisms. There is a large amount of amorphous calcareous matter, which gives the deposit a sticky and chalky character. The particles may be of all sizes according to the distance from the reefs, the mean diameter being 1 to 2 mm., but occasionally there are large blocks of coral and large calcareous concretions; the particles are white and red. Remains of siliceous organisms seldom make up over 2 or 3 per cent. of a typical coral mud. The *residue* consists usually of a small amount of argillaceous matter, with a few fragments of feldspar and other volcanic minerals; but off barrier and fringing reefs facing continents we may have a great variety of rocks and minerals. Beyond a depth of 1000 fathoms off coral islands the debris of the reefs begins to diminish, and the remains of pelagic organisms to increase; the deposit becomes more argillaceous, of a reddish or rose colour, and gradually passes into a Globigerina ooze or red clay. *Coral Sands* contain much less amorphous matter than coral muds, but in other respects they are similar, the sands being usually found nearer the reefs and in shallower water than the muds, except inside lagoons. In some regions the remains of calcareous algae predominate, and in these cases the name *coralline mud or sand* is employed to point out the distinction.

Such is a rapid view of the deposits found in the deeper waters of the littoral zones, where the debris from the neighbouring land plays the most important part in the formation of muds and sands.

When, however, we pass beyond a distance of about 200 miles from land, we find that the deposits are characterised by the great abundance of fragmentary volcanic materials which have usually undergone great alteration, and by the enormous abundance of the shells and skeletons of minute pelagic organisms which have fallen to the bottom from the surface waters. These true deep-sea deposits may be divided into those in which the organic elements predominate, and those in which the mineral constituents play the chief part. We shall commence with the former.

(To be continued.)

## THE TWO MANNERS OF MOTION OF WATER<sup>1</sup>

IT has long been a matter of very general regret with those who are interested in natural philosophy that in spite of the most strenuous efforts of the ablest mathematicians the theory of fluid motion fits very ill with the actual behaviour of fluids, and this for unexplained reasons. The theory itself appears to be very tolerably complete, and affords the means of calculating the results to be expected in almost every case of fluid motion, but while in many cases the theoretical results agree with those actually obtained, in other cases they are altogether different.

If we take a small body, such as a raindrop, moving through the air, the theory gives us the true law of resistance; but if we take a large body, such as a ship moving through the water, the theoretical law of resistance is altogether out; and what is the most unsatisfactory part of the matter is that the theory affords no clue to the reason why it should apply to the one class more than to the other.

When seven years ago I had the honour of lecturing in this room on the then novel subject of vortex motion, I ventured to insist that the reason why such ill success had attended our theoretical efforts was because, owing to the uniform clearness or opacity of water and air, we can see nothing of the internal motion, and while exhibiting the phenomena of vortex rings in water, rendered strikingly apparent by partially colouring the water, but otherwise as strikingly invisible, I ventured to predict that the more general application of this method, which I may call the method of colour-bands, would reveal clues to those mysteries of fluid motion which had baffled philosophy.

To-night I venture to claim what is at all events a partial verification of that prediction. The fact that we can see as far into fluids as into solids naturally raises the question why the same success should not have been obtained in the case of the theory of fluids as in that of solids. The answer is plain enough. As a rule there is no internal motion in solid bodies, and hence our theory, based on the assumption of relative internal rest, applies to all cases. It is not, however, impossible that an at all events seemingly solid body should have internal motion, and a simple experiment will show that if a class of such bodies existed they would apparently have disobeyed the laws of motion.

These two wooden cubes are apparently just alike, each has a string tied to it. Now if a ball is suspended by a string you all know that it hangs vertically below the point of suspension, or swings like a pendulum; you see this one does so, the other you see behaves quite differently, turning up sideways. The effect is very striking so long as you do not know the cause. There is a heavy revolving wheel inside which makes it behave like a top.

Now what I wish you to see is that had such bodies been a work of Nature so that we could not see what was going on—if, for instance, apples were of this nature while pears were what they are, the laws of motion would not have been discovered, or if discovered for pears would not have applied to apples, and so would hardly have been thought satisfactory.

Such is the case with fluids. Here are two vessels of water which appear exactly similar, even more so than the solids, because you can see right through them, and there is nothing unreasonable in supposing that the same laws of motion would apply to both vessels. The application of the method of colour-bands, however, reveals a secret—the water of the one is at rest while that in the other is in a high state of agitation.

I am speaking of the two manners of motion of water—not because there are only two motions possible: looked at by their general appearance the motions of water are infinite in number; but what it is my object to make clear to-night is that all the various phenomena of moving water may be divided into two broadly distinct classes, not according to what with uniform fluids are their apparent motions, but according to what are the internal motions of the fluids which are invisible with clear fluids but which become visible with colour-bands.

The phenomena to be shown will, I hope, have some interest in themselves, but their intrinsic interest is as nothing compared to their philosophical interest. On this, however, I can but slightly touch. I have already pointed out that the problems of fluid motion may be divided into two classes, those in which the theoretical results agree with the experimental and those in which they are altogether different. Now what makes the recognition

<sup>1</sup> Lecture at the Royal Institution on Friday, March 28, by Prof. Osborne Reynolds, F.R.S.

of the two manners of internal motion of fluids so important is that all those problems to which the theory fits belong to the one class of internal motions. The point before us to-night is simple enough, and may be well expressed by analogy. Most of us have more or less familiarity with the motion of troops, and we can well understand that there exists a science of military tactics which treats of the best manoeuvres to meet particular circumstances. Suppose this science proceeds on the assumption that the discipline of the troops is perfect, and hence takes no account of such moral effects as may be produced by the presence of an enemy. Such a theory would stand in the same relation to the movements of troops as that of hydrodynamics does to the movements of water. For although only disciplined motion may be recognised in military tactics, troops have another manner of motion when anything disturbs their order. And this is precisely how it is with water: it will move in a perfectly direct, disciplined manner under some circumstances, while under others it becomes a mass of eddies and cross streams, which may be well likened to a whirling struggling mob, where each individual element is obstructing the others. Nor does the analogy end here. The circumstances which determine whether the motion of troops shall be a march or a scramble are closely analogous to those which determine whether the motion of water shall be direct or sinuous. In both cases there is a certain influence necessary for order: with troops, it is discipline; with water, it is viscosity or treacyness. The better the discipline of the troops, or the more treacly the fluid, the less likely is steady motion to be disturbed under any circumstances. On the other hand, speed and size are in both cases influences conducive to unsteadiness. The larger the army and the more rapid the evolutions the greater the chance of disorder; so with fluid, the larger the channel and the greater the velocity the more chance of eddies. With troops some evolutions are much more difficult to effect with steadiness than others, and some evolutions which would be perfectly safe on parade would be sheer madness in the presence of an enemy. It is much the same with water.

One of my chief objects in introducing this analogy is to illustrate the fact that even while executing manoeuvres in a steady manner there may be a fundamental difference in the condition of the fluid. This is easily realised in the case of troops, difficult and easy manoeuvres may be executed in equally steady manners if all goes well, but the conditions of the moving troops are essentially different, for while in the one case any slight disarrangement would be easily rectified, in the other it would inevitably lead to a scramble. The source of such a change in the manner of motion may be ascribed either to the delicacy of the manoeuvre or to the upsetting disarrangement, but as a matter of fact both these causes are necessary. In the case of extreme delicacy an indefinitely small disturbance, such as is always to be counted upon, will effect the change. Under these circumstances we may well describe the condition of the troops in the simple manoeuvre as stable, while that in the difficult manoeuvre is unstable, *i.e.* will break down on the smallest disarrangement. The small disarrangement is the immediate cause of the breakdown in the same sense as the sound of a voice is sometimes the cause of an avalanche, but since such disarrangement is certain to occur a condition of instability is the real cause of the change.

All this is exactly true for the motion of water. Supposing no disarrangement, the water would move in the manner indicated in the theory, just as if there were no disturbance an egg would stand on its end, but as there is always some slight disturbance it is only when the condition of steady motion is more or less stable that it can exist. In addition then to the theories either of military tactics or of hydrodynamics, it is necessary to know under what circumstances the manoeuvres of which they treat are stable or unstable. It is in definitely separating these that the method of colour-bands has done good service, which will remove the discredit in which the theory of hydrodynamics has been held.

In the first place it has shown that the property of viscosity or treacyness possessed more or less by all fluids is the general influence conducive to steadiness, while, on the other hand, space and velocity have the counter influence. Also that the effect of these influences is subject to a perfectly definite law, which is that a particular evolution becomes unstable for a definite value of the viscosity divided by the product of the velocity and space. This law explains a vast number of phenomena which have hitherto appeared paradoxical. One general conclusion is that with sufficiently slow motion all manners of motion are stable.

The effect of viscosity is well shown by introducing a band of coloured water across a beaker filled with clear water at rest. Then, when all is quite still, turn the beaker about its axis. The glass turns, but not the water, except that which is quite close to the glass. The coloured water which is close to the glass is drawn out into what looks like a long smear, but it is not a smear. It is simply a colour-band extending from the point in which the colour touched the glass in a spiral manner inwards; showing that the viscosity is slowly communicating the motion of the glass to the water within. To show this it is only necessary to turn the beaker back, and the smear closes up until the colour-band assumes its radial position. Throughout this evolution the motion has been quite steady—quite according to the theory.

When water flows steadily, it flows in streams. Water flowing along a pipe is such a stream. This is bounded by the solid surface of the pipe, but if the water is flowing steadily we can imagine the water to be divided by ideal tubes into a faggot of indefinitely small streams, any one of which may be coloured without altering its motion, just as one column of infantry may be distinguished from another by colour.

If there is internal motion, it is clear that we cannot consider the whole stream bounded by the pipe as a faggot of elementary streams, as the water is continually crossing the pipe from one side to another, any more than we can distinguish the streaks of colour in a human stream in the corridor of a theatre.

Solid walls are not necessary to form a stream. The jets from a fountain or the cascade in Niagara are streams bounded by free surfaces. A river is a stream half bounded by a solid surface. Streams may be parallel, as in a pipe; converging or diverging, as in conical pipes; or they may be straight and curved. All these circumstances have their influence on stability in the manner indicated in the accompanying diagram.

#### CIRCUMSTANCES CONDUCTIVE TO

<i>Direct or Steady Motion</i>	<i>Sinuous or Unsteady Motion</i>
(1) Viscosity or fluid friction which continually destroys disturbance. Thus treacle is steadier than water.	(5) Particular variation of velocity across the stream, as when a stream flows through still water.
(2) A free bounding surface.	(6) Solid bounding walls.
(3) Converging solid boundaries.	(7) Diverging solid bounding walls.
(4) Curvature of the streams with the velocity greatest on the outside.	(8) Curvature with the velocity greatest on the inside.

It has for a long time been noticed that a stream of fluid through fluid otherwise at rest is in an unstable condition. It is this instability which renders flames and jets sensitive to the slight disarrangement caused by sound.

I have here a glass vessel of clean water in front of the lantern, so that any colour-bands will be projected on to the screen. You see the ends of two vertical tubes facing each other: nothing is flowing through these tubes, and the water in the vessel is at rest. I now open two taps, so as to allow a steady stream of coloured water to enter at the lower pipe, water flowing out at the upper. The water enters quite steadily, forms a sort of vortex ring at the end, which proceeds across the vessel, and passes out at the lower pipe. The coloured stream then extends straight across the vessel, and fills both pipes: you see no motion; it looks like a red glass rod. The red water is, however, flowing slowly, so slowly that viscosity is paramount, and hence the stream is steady. As the speed is increased, a certain wriggling, sinuous motion appears in the column; a little faster and the column breaks up into beautiful and well-defined eddies, and spreads into the surrounding water, which, becoming opaque with colour, gradually draws a veil over the experiment. The final breaking up of the column was doubtless determined by some slight vibration in the apparatus, but such vibration, which is always going on, will not affect the stream until it is in a sufficiently unstable condition. The same is true of all streams bounded by standing water.

If the motion is sufficiently slow, according to the size of the stream and the viscosity, the stream is steady and stable. Then at a certain critical velocity, determined by the ratio of the viscosity of the water to the diameter of the stream, the stream becomes unstable. So that under any conditions which involve a stream through surrounding water, the motion becomes unstable at sufficiently great velocities.

Now one of the most noticeable facts in experimental hydrodynamics is the difference in the way in which water flows along contracting and expanding channels. Such channels are now projected on the screen, surrounded and filled with clean, still water. The mouth of the tube at which the water enters is wide; the tube then contracts for some way, then expands again gradually until it is as wide as at the mouth. At present nothing is to be seen of what is going on. On colouring one of the elementary streams, however, outside the mouth, a colour-band is formed. This colour-band is drawn in with the surrounding water, and shows what is going on. It enters quite steadily, preserving its clear streak-like character until it has reached the neck, where convergence ceases; then on entering the expanding channel it is altogether broken up into eddies. Thus the motion is direct and steady in the contracting tube, sinuous in the expanding.

The theory of hydrodynamics affords no clue to the cause of this difference, and even as seen by the method of colour-bands the reason for the sinuous motion is not obvious. If the current be started suddenly at the first instant, the motion is the same in both parts of the channel. Its changing in the expanding pipe seemed to imply that there the motion is unstable. If this were so, it ought to appear from the theory. I am ashamed to think of the time spent in trying to make this out from the theory without any result. I then had recourse to the method of colour again, and found that there is an intermediate stage.

When the tap is first opened, the immediately ensuing motion is nearly the same in both parts; but, while that in the contracting tube maintains its character, that in the expanding changes its character: a vortex ring is formed which, moving forwards, leaves the motion behind that of a parallel stream through the surrounding water. When the motion is sufficiently slow, the stream is stable, as already explained; there is then direct motion in both the contracting and expanding portions of the tube, but these are not similar, the first being a faggot of similar elementary contracting streams, the latter being that of one parallel stream through surrounding fluid. The first is a stable form, the second an unstable, and on increasing the velocity the first remains, while the second breaks down, and, as before, the expanding tube is filled with eddies. This experiment is typical of a large class of motions. Whenever fluid flows through a narrow neck, as it approaches the neck it is steady, after passing the neck it is sinuous. The same is produced by an obstacle in the middle of a stream, and virtually the same by the motion of a solid through the water.

The object projected on the screen is not unlike a ship. Here the ship is fixed and the water flowing past it, but the effect would be the same were the ship moving through the water. In the front of the ship the stream is steady, so long as it contracts, until it has passed the middle; you then see the eddies formed as the streams expand again round the stern. It is these eddies which account for the difference between the actual and theoretical resistance of ships.

It appears then that the motion in the expanding channel is sinuous, because the only steady motion is that of a stream through still water. Numerous cases in which the motion is sinuous may be explained in the same way, but not all. If we have a parallel channel, neither contracting or expanding, the steady moving streams will be a faggot of steady parallel elementary streams all in motion but having different velocities, those in the middle moving the fastest. Here we have a stream but not through standing water. When this investigation began, it was not known whether such a stream was ever steady; but there was a well-known anomaly in the resistance encountered in parallel channels. In rivers and all pipes of sensible size experience had shown that the resistance increased as the square of the velocity, whereas in very small pipes, such as represent the smaller veins in animals, Poiseuille had proved that the resistance increased as the velocity. Thus since the resistance would be as the square of the velocity with sinuous motion, and as the velocity in the case of direct motion, it appeared that the discrepancy would be accounted for if it could be shown that the motion becomes unstable at sufficiently large velocities according to the size of the pipe. This has been done. You see on the screen a pipe with its end open. It is surrounded by water, and by opening a tap I can draw the water through it. This makes no difference to the appearance until I colour one of the elementary streams, when you see a beautiful streak of colour extend all along the pipe. So far the stream has been running steadily, and it appears quite stable. As the speed increases the colour-band naturally becomes finer, but on reaching a certain speed the colour-band becomes unsteady

and mixes with the surrounding fluid filling the pipe. This sinuous motion comes on at a definite velocity; diminish the velocity ever so little, the band becomes straight and clear, increase it again and it breaks up. This critical speed depends on the size of the tube in the exact inverse ratio, the smaller the tube the greater the velocity. Also the more viscous the fluid the greater the velocity.

We have here then not only a complete explanation of the difference in the laws of resistance generally experienced and that found by Poiseuille, but also we have complete evidence of the instability of steady streams flowing between solid surfaces. The cause of this instability is not yet completely ascertained, but this much is certain, that while lateral stiffness in the walls of the tube is unimportant, inextensibility or tangential rigidity is essential to the creation of eddies. I cannot show you this, because the only way in which we can produce the necessary condition is by wind blowing over the surface of water. When the wind blows over water it imparts motion to the surface of the water just as a moving solid surface. Moving in this way the water is not susceptible of eddies, it is unstable, but the result is waves. This is proved by a very old experiment, which has recently attracted considerable notice. If oil be put on the surface it spreads out into an indefinitely thin sheet with only one of the characteristics of a solid surface, it offers resistance, very slight, but still resistance to extension or contraction. This resistance, slight as it is, is sufficient to entirely alter the character of the motion. It renders the motion of the water unstable internally, and instead of waves what the wind does is to produce eddies beneath the surface. To those who have observed the phenomenon of oil preventing waves there is probably nothing more striking throughout the region of mechanics. A film of oil so thin that we have no means of illustrating its thickness, and which cannot be perceived except by its effects—which possesses no mechanical properties that can be made apparent to our senses—is yet able to prevent an action involving forces the strongest that we can conceive, able to upset our ships and destroy our coasts. This, however, becomes intelligible when we perceive that the action of the oil is not to calm the sea by sheer force, but merely, as by its moral force, to alter the manner of motion produced by the action of the wind from that of the terrible waves on the surface into the harmless eddies below. The wind brings the water into a highly unstable condition, into what morally we should call a condition of great excitement; the oil by an influence we cannot perceive directs this excitement. This influence, although insensibly small, is however now proved to be of a mechanical kind, and to me it seems that this instance of one of the most powerful mechanical actions of which the forces of Nature are capable being entirely controlled by a mechanical force so slight as to be imperceptible does away with every argument against strictly mechanical sources for what we may call mental and moral forces.

But to return to the instability in parallel channels. This has been the most complete as well as the most definite result of the method of colour-bands. The circumstances are such as render definite experiments possible; these have been made and reveal a definite law of instability, which law has been tested by reference to all the numerous and important experiments that have been recorded with reference to the law of resistance in pipes, whence it appears that the change in the variation of the resistance from the velocity to the square of the velocity agrees as regards the velocity at which it occurs with the change from stability to instability. It is thus shown that water behaves in exactly the same manner, whether the channel is, as in Poiseuille's experiments, of the size of a hair, or whether it be the size of a water main or of the Mississippi. The only difference being that in order that the motions may be compared the velocities must be inversely as the size of the channels. This is not the only point explained.

If we consider other fluids than water, some fluids like oil or treacle apparently flow more slowly and steadily than water; this however is only in smaller channels. The velocity at which sinuous motion commences increases with the viscosity. Thus while water in ordinary streams is always above its critical velocity and the motion sinuous, the motion of treacle in such streams as we see is below its critical velocity and the motion is steady. But if Nature had produced rivers of treacle the size of the Thames the treacle would have flowed as easily as water. Thus in the lava streams from a volcano, although looked at closely the lava has the consistency of a pudding, in the large and rapid streams down the mountain side the lava flows with eddies like water.

There is now only one experiment left. This relates to the effect of curvature in the streams on the stability of the motion. Here again we see the whole effect altered by apparently a very slight cause. If the water be flowing in a bent channel in steady streams, the question as to whether the motion will be stable or not turns on the variation of the velocity across the channel. In front of the lantern is a cylinder with glass ends, so that the light passes through in the direction of the axis. The cylinder is full of water, the disk of light on the screen being the light which passes through this water, and is bounded by the circular walls of the cylinder. By means of two tubes temporarily attached, a stream of colour is introduced so as to form a colour-band right across the cylinder, extending from wall to wall; the motion is very slow, and, the taps being closed and the tubes removed, the colour-band is practically stationary. The vessel is now caused to revolve about its axis. At first only the walls of the cylinder move, but the colour-band shows that the water gradually takes up the motion, the streak being wound off at the ends into two spiral lines, but otherwise remaining still and vertical; when the streak is all wound off and the spirals meet in the middle, the whole water is in motion. But as the vessel is revolving, the motion is greatest at the outside, and is thus stable. There are no eddies, although the spiral rings are so close as nearly to touch each other. The vessel stops, and gradually stops the water, beginning at the outside. If this went on steadily, the spirals would be unwound and the streak restored; but as the velocity is now greater towards the centre, the motion is unstable for some distance from the outside, and eddies form, breaking up the spirals for a certain distance towards the middle, but leaving the middle revolving steadily. Besides indicating the effect of curvature, this experiment neatly illustrates the action of the earth's surface on the air moving over it, the variation of temperature having much the same effect on the stability of the moving fluid as the curvature of the vessel. The moving air is unstable for a few thousand feet above the earth's surface, and the motion consequently sinuous to this height. The mixing of the lower and upper strata produces the heavy cumulus clouds, but above this the influence of the temperature predominates; the motion is stable, and clouds, if they form, are stratus, like the inner spirals of the colour-bands.

#### REPORT ON ATMOSPHERIC SAND-DUST FROM UNALASKA<sup>1</sup>

THE specimen of sand which fell during a rain-storm, October 20, 1883, at Unalaska, Alaska, has been submitted to microscopical analysis, and found to be undoubtedly of volcanic origin. It is gray, and the grains are rather uniform in size, rarely attaining a diameter of 0.35 mm. Under a hand lens can be distinguished light-coloured crystals and fragments which are occasionally glassy in lustre, mixed with others of darker colours; both are more or less dusty in appearance from the presence of finer particles. For convenience of manipulation and preservation, as well as to render the optical tests more definite and decisive, the sand was mounted in Canada balsam upon glass slides, after the manner of thin sections of rocks for microscopical investigations. It is composed chiefly of either broken or complete crystals of feldspar, augite, hornblende, and magnetite, with numerous fragments of ground-mass and a few small particles of glass freighted with grains of iron oxide or other heavy minerals. The feldspar frequently occurs in well-preserved crystals. Cleavage plates are common, but irregular fragments predominate. A few thin cleavage lamellæ parallel to the base between crossed nicols show no bending due to polysynthetic twinning, and extinction takes place when the lines which indicate the clinopinacoidal cleavage are parallel to the principal section of either nicol. While it is evident that such thin plates are orthoclase, the prevailing feldspar is undoubtedly basic plagioclase, for chemical analysis shows the sand to contain only 52.48 per cent.  $\text{SiO}_2$ . The perfect crystals are usually about 0.15 × 0.13 mm. in size, and slightly tabular, parallel to the clinopinacoid. At times they present an almost hexagonal aspect, and generally contain inclusions so abundantly as to render the middle portion feebly translucent. Among the imprisoned particles may be recognised hornblende microlites, grains of iron oxide with crystallites of an indeterminable nature, and their arrangement frequently imparts a distinct zonal structure to the feldspar. The hornblende, which is not nearly as

prominent a constituent of the sand as the feldspar, occurs chiefly in cleavage plates and irregular angular fragments. It has a brown to dark brown colour, with deep absorption and strong pleochroism, as in the andesite which it characterises. The size of the hornblende fragments varies within small limits, averaging 0.10 × 0.05 mm., and the extinction angle is about 9°. It occasionally contains numerous crystallites arranged parallel to the vertical ( $c''$ ) axis. In the number of slides examined several brownish foliæ, apparently of biotite, were observed under such circumstances that their characterising optical properties could not be satisfactorily determined. Of the FeMg silicates augite is the most abundant. It is of a pale green colour, non-pleochroitic, and its angle of extinction as seen in the cleavage plates is about 46°. Like hornblende, it is found generally in irregular fragments. The prismatic fragments vary from 0.10 to 0.35 mm. in greatest length. The grains of magnetite, which may, in considerable quantities, be readily picked out of the sand with a magnet, are for the most part of irregular outline and small size. Instead of forming independent grains of themselves, they are generally found cleaving to fragments of the ground-mass, or included in the other minerals.

Besides the mineral ingredients already mentioned, the sand contains numerous irregular grains swarming with clear crystallites and microlites embedded in a grayish translucent to transparent, often amorphous, base. These composite fragments correspond to the ground-mass of the eruptive rocks to which the volcanic sand is allied. They vary in size up to a diameter of 0.26 mm., and are generally rendered heavier than they would otherwise be by small particles of magnetite or augite. The crystal fragments frequently have portions of the ground-mass attached to them, and present that ragged appearance which distinguishes volcanic sand from that which has been produced by other methods. Feldspar, augite, hornblende, magnetite, with fragments of the ground-mass, make up the bulk of the sand. Its composition is that of a hornblende-andesite very like those which occur at many points along the western coast. One is surprised to find a conspicuous deficiency in the most common and generally prevailing element of volcanic ashes. It is true that clear or sparingly microlitic glass particles are found in the sand from Unalaska, but they are rather exceptional and uncommon. This paucity in glass fragments may be readily comprehended by reflecting upon the origin and distribution of volcanic ashes.

The United States Geological Survey party sent out last summer in my charge under the direction of Capt. Dutton for the reconnaissance of the southern portions of the Cascade Range, collected a lot of volcanic sand about a dozen miles north-east of Mount Shasta. It does not form a thick deposit, but is widespread over the basaltic slopes south of Sheep Rock, and like that collected at Unalaska consists chiefly of crystal fragments, of which feldspar is the most abundant. Hornblende, hypersthene, augite, and magnetite are less prominent. In addition to these and numerous fragments of microlitic ground-mass, there are many clear or sparingly crystallitic glass particles of a pumiceous character. The composition of the sand is that of a hypersthene-bearing hornblende-andesite like that which forms the well-preserved and prominent crater springing up from the north-western slope of Mount Shasta, about two miles from that summit. This crater is the counterpart of Shasta cone, when we consider the whole volcanic pile, and has been christened Shastina by Capt. Dutton to indicate the relation it bears to its majestic neighbour. In the volcanic sand which travelled about a dozen miles north-east from Shastina, grains may be found having a diameter of 0.5 mm., so that it is, on the whole, considerably coarser and less uniform than that which fell at Unalaska, October 20, 1883, but like the latter it is made up chiefly of fragments of crystalline matter.

On the other hand, volcanic dust which has been carried long distances is composed principally of glass particles, and there is a conspicuous paucity of crystals and fragments of dense microlitic ground-mass. That which emanated from a crater in Iceland and fell over Norway and Sweden March 29 and 30, 1875, more than 750 miles from its source, is composed almost exclusively of sharp-edged angular glass fragments with curved sides. These splinters, chips, and shards of glass show by their more or less curved outlines, as well as by their tubular or vesicular structure, that they differ from pumice only in being fragmental. In the formation of pumice the inflation and distension by inclosed steam and gases is carried so far as to produce a froth, but if the same process be continued until explosion takes place,

<sup>1</sup> By J. S. Diller, Assistant Geologist, United States Geological Survey.

volcanic dust will be the result. The same might be said of the Krakatoa dust which has been collected far from its source. That which fell August 27 at Batavia, about sixty miles from Krakatoa, according to Renard, consists chiefly of glass particles, with plagioclase, augite, rhombic pyroxene, and magnetite, giving the general composition found in some augite-andesites. In Krakatoa dust and pumice obtained from various localities in the vicinity of the Java coast, I have always found glass the most abundant constituent. The rhombic pyroxene, hypersthene, predominates largely over augite, and as Mr. Iddings has already shown, the ejected material belongs to hypersthene-andesite very like the pumiceous variety of the same rock upon the south-western slope of Mount Shasta in the Cascade Range.

While it is evident that all kinds of ejected material, from the finest dust to the coarsest fragments, may be found upon their parent cone, yet it is true that all ashes which have been transported by the winds for distances greater than one hundred miles are composed chiefly of glass fragments distinguished by their pumiceous character. Volcanic glass may be considered an almost inevitable product of violent eruptions; and of all the important constituents of sand and dust formed in this way, it is the lightest. Furthermore, for a reason easily explained, it is blown to much finer dust-particles than any of the products of crystallisation. In a magma where crystallisation is taking place, the absorbed gases and uncombined water under enormous tension are gradually accumulated in that portion which is most liquid and least individualised. In this way the portion of the magma which upon solidification yields glass becomes stored with the energy that will cause its distension and perhaps blow it to atoms when the mass is relieved from the antagonising pressure. The individualised and unindividualised portions of the magma may be irregularly commingled, or they may arrange themselves, as is frequently the case in obsidians from Oregon, in more or less regular alternating bands. The streams of microlites must necessarily imprison less uncombined water or absorbed gases than the bands between them, so that when the pressure is relieved the latter will suffer the greatest amount of distension. If the tension of the confined water and gases is great enough, the amorphous portion of the magma may be blown to glassy dust, while the individualised portion, pulverised rather by external than internal forces, is not reduced to so high a degree of fineness. Volcanic dust is the extreme term of a series which begins in compact lava, and has for its middle members pumice in different stages of inflation. It appears to be a significant fact, at least as far as I have had an opportunity to observe, that effused pumice, *i.e.* pumice which occurs in places as froth upon a stream of obsidian into which it gradually passes, is highly microlitic. The glassy partitions which bound the more or less rounded vesicles are crowded with microlites and crystallites, while in ejected pumice where long, distended vesicles prevail, or in volcanic glass dust, the products of crystallisation are comparatively few or entirely wanting.

Prof. F. W. Clarke, chief chemist of the United States Geological Survey, has determined the amount of silica in the sand which fell at Unalaska, as well as that from the north-eastern slope of Mount Shasta. The former contains 52.48  $\text{SiO}_2$ . As should be expected, it is more basic than hornblende-andesite, and indicates that the acid portion of the magma—the volcanic glass in the form of dust—was blown away from the sand. It is well known that the glassy base is in general the most acid portion of a rock, and any mechanical means by which the magma is separated into crystal sand and glass dust divides the rock into a basic and acidic portion. This division is in certain degrees indicated by the analysis of Renard and Iddings of material from the recent eruption of Krakatoa. The pumice contained only 62 per cent. of  $\text{SiO}_2$ , while the dust which fell at Batavia, according to Renard, contained 65 per cent. of  $\text{SiO}_2$ . The few observations I have been able to gather indicate that even under favourable circumstances volcanic sand is not carried a hundred miles from its source, while dust from the same vent may be distributed over many hundreds of miles beyond the sand.

It is unfortunate that we do not possess more definite and detailed knowledge with reference to the source and distribution of the volcanic sand from Unalaska. Mr. Applegate, in his letter of transmittal dated October 22, says, "I forward by this mail a sample bottle of sand that fell during the storm of October 20, 1883. At 2.30 p.m. the air became suddenly darkened like night, and soon after a shower of mixed sand and water fell for about ten minutes, covering the ground with a thin layer. The windows were so covered that it was impossible to see

through them. This sand is supposed to have come either from the Makushin or the new volcano adjacent to Bogeslov. The former is a distance of about nineteen miles to the south-west, but for years has only issued forth smoke or steam. The latter is a new one which made its appearance this summer, and burst out from the bottom of Behring Sea. It has been exceedingly active, and has already formed an island from 800 to 1200 feet high. Bogeslov is about sixty miles from here (Unalaska) in a west direction. The new volcano is about one-eighth of a mile north-west of it." Judging alone from the size of the grains of sand it seems probable that it may have been brought from Bogeslov. Its paucity in glass fragments as compared with the coarse sand from a dozen miles north-east of Shastina, indicates that it was carried a considerable distance from its source, so as to allow a pretty complete assorting of the material by the wind.

Grewingk, who has given us the most important contribution to the geology of Alaska, more especially of the Aleutian Islands, has prepared a geological map of Unalaska, and reports the volcanoes there as emitting basic lavas which, from his meagre description, appear to be similar to those poured out by volcanoes of the Cascade Range. It seems very probable that the volcanic sand ejected by Makushin must be of the same general composition as that which lately fell at Unalaska. Grewingk's work contains a description of the island of Bogeslov, but in it are contained no petrographic notes of importance. Of the rocks on the new volcanic island north-west of Bogeslov, for which the name Grewingk has been proposed, we have no information. If the sand under consideration really came from Grewingk, as seems most probable, we should expect the island to be made up of hornblende-andesite.

In connection with the all-absorbing topic, the peculiar sunset phenomena, much has been said of volcanic dust from Krakatoa. A surprisingly wide distribution has been assigned to it, and there is doubtless considerable scepticism concerning its identification. The forms of glass particles in volcanic dust are peculiar, and this, taken in connection with their isotropic character, renders them easily recognised under a polarising microscope. In the annexed figures Series No. 1 gives the outlines of glass fragments in Krakatoa dust. Series No. 2 is taken



from the volcanic dust which fell in Norway and Sweden, March 29 and 30, 1875. Series No. 3 represents the curious fragments found in an old quartz-porphphy tufa at Breakheart Hill, in Sangus, north of Boston. The forms of glass particles seen in the volcanic dust collected by Mr. Russell near the Truckee River are represented in Series No. 4. The fragments represented in Series No. 3 are now chiefly quartz, but were once particles of volcanic glass, and show that in the early geological history of Eastern Massachusetts there were volcanoes belching forth volcanic ashes like that of recent times, and flooding the country with acid lavas whose beautiful and regular fluid banding has puzzled many observers and led them to suspect its sedimentary origin. It seems reasonable to suppose that the Grewingk crater must have yielded dust as well as sand, and that the former can, with a high degree of probability, be distinguished from the dust of Krakatoa. The glass dust from Grewingk, judging from that seen in the Unalaska sand, is less clouded than that from Java. In the Krakatoa dust it is hypersthene which is associated with the feldspar, augite, and magnetite, but in Grewingk dust we should expect to find hornblende.

A complete knowledge of the distribution of volcanic sand and dust has such an important bearing upon meteorological conditions, as well as upon volcanic phenomena, that it is hoped accurate and continuous observations may be made upon this subject at suitable meteorological stations. When we consider the dust in cities rising from the ground into the air during dry weather, as well as contributions, frequently glassy, made by

various furnaces and factories, it is evident that observations for meteoric and volcanic dust should be made at elevated stations far removed from large cities. If a station were established upon Mount Shasta, California, as suggested by Mr. Gilbert Thompson, it would afford excellent opportunity for such observations. The station on Mount Washington is also favourably situated, and if regular observations were made at these stations and in Alaska for small as well as large quantities of such dust, and the sediments collected subjected to microscopical examination, the result would doubtless be of great interest.

Washington, D.C., March 25

### THE POLAR CONFERENCE<sup>1</sup>

THE Fellows need hardly be reminded that it was at the suggestion of an Austrian, the late Carl Weyprecht, that this great international undertaking was set on foot, and accordingly Vienna was the most fitting city in which to welcome the several expeditions on their return to civilisation, and to discuss the best mode of utilising their labours.

The chiefs of nine expeditions were present at the meeting. The unrepresented stations were the two Russian ones, at Nova Zemlya and at the mouth of the Lena (at which latter station the observations will be continued until August 1884); that established by the Society of Science of Finland at Sodankylä, the German station in South Georgia, and the second American station at Lady Franklin Bay. As to the fate of the observers at the last-named locality there are unfortunately grave reasons for anxiety.

Most of the expeditions had brought home a collection of photographs, giving a vivid representation of their respective surroundings during their sojourn. Many of these possess ethnological interest, and one was humorous, as it showed the Dutch Arctic tin band, with instruments made out of preserved meat canisters.

I suppose my audience is aware that the Dutch Expedition was ice-bound and drifted about in the Kara Sea, ultimately saving itself in its boats. The ship was crushed in the autumn of 1882, but did not actually sink for six months, so that all the property was saved. Under such circumstances, however, it is no wonder that no magnetical observations were made.

As regards the publications, these are to be carried out independently in each country, but on a uniform plan. The meteorological observations are to be given in metric and centigrade measures; the magnetical according to the C.G.S. system of units.

The hourly observations are to be published in detail. The barometer observations are not to be corrected for gravity, but the value of this correction is to be given in the tables.

As regards terrestrial magnetism, besides the publication of the term day observations a detailed reproduction of all the observations for certain days of disturbance is to be given. A list of these days will be prepared by Prof. Wild.

All the members of the Conference are requested to collect data for earth currents for their respective countries during the period of the circumpolar observations. The auroral observations are to be published on the scheme proposed by Weyprecht.

As to the magnetic disturbances and their elimination there was, as might be expected, a long debate, but no definite resolutions were adopted.

The publication of a number of observations was left optional, such as evaporation, solar radiation, the resolution of the wind to four components, the calculation of wind-roses according as the pressure was above or below 760 mm., &c.

It is hoped that the whole of the results will have appeared by the end of 1885.

The Conference was most graciously received by the Emperor at an audience. The members were also entertained at a magnificent banquet on April 23 by Count Wilczek, at whose sole expense the Austrian Expedition to Jan Mayen had been fitted out and maintained during its stay.

The detailed report of the proceedings of the Conference will be published in French and German, and will appear before long.

### GEOLOGY IN RUSSIA

ALTHOUGH a large amount of geological work has been done in Russia, especially during the last twenty years, the geological exploration of this wide region has not been carried

<sup>1</sup> Notes on the Proceedings of the International Polar Conference, held at Vienna, April 17-24, 1884. Read at the Royal Meteorological Society by Robert H. Scott, F.R.S., President.

on in the detailed and accurate manner required by modern geology. An important step towards the attainment of more precise knowledge on this subject was taken in 1882 by the formation of a special Geological Commission intrusted with the geological survey of Russia. A yearly subsidy of 30,000 roubles was granted for that purpose by the State, to which must be added various occasional subsidies for special aims, supplied either by Government or by provincial assemblies and private bodies. This Commission has now published two volumes of its *Bulletin* and one fasciculus of *Memoirs*.<sup>1</sup> From these we learn that the chief work undertaken has been the preparation of a geological map of Russia on the scale of 10 verst: (6·7 miles) to an inch. Russia has been divided into ten regions: Baltic, Central, Dnieper, Western Frontier, Volga and Don, Caspian, Ural, Crimea and Caucasus, Northern, and Finland. The survey has been started in several regions at once, each region being subdivided into three parts: (1) those which are well explored, and the maps of which already exist and could be employed for geological purposes; (2) those in which various isolated explorations have been made; and (3) unexplored parts. The explorations will be prosecuted first of all in the second of these three areas. The system of colours for the map will be adopted which was recommended by the Congress of Bologna. The explanations, as also the chief names, will be printed in French, side by side with the Russian text.

The first volume of the *Memoirs* contains a work by M. Lahusen, on the Jurassic fauna of the Government of Ryazan, written in Russian, with a summary in German. It is a complete enumeration of the Jurassic fossils of the region, the deposits of which belong—the black clay, with *Cardioceras cordatum*, to the Lower Oxfordian; the oolitic gray clay, with iron and *Cardioceras lamberti*, to the Upper Callovian; the gray and brown clays, with *Perisphinctes mosquensis* and *mutatus*, to the Middle; and the brown iron sandstone, with sheets of black clay and characterised by *Cosmoceras gouvierianum*, *Cardioceras chamusseti*, and *Stephanoceras elatina*, to the Lower Callovian. The new fossils of the *Aucella* sandstone will be described by M. Nikitin. Eleven quarto plates illustrating a great number of species, many of which are new, accompany the paper.

The *Bulletin* (*Ivestia*) contains, besides the minutes of meetings, a number of preliminary reports of the geologists of the Survey, and the description, by M. Nikitin, of the sheet 58 (*Yaroslavl*) of the geological map of Russia. These notices are full of valuable information regarding the details of the geological structure of Russia. Among papers of more general interest we may mention Prof. Fr. Schmidt's report upon his explorations on the Baltic Railway, which embodies the results of his prolonged researches in the same region (vol. ii. fasc. 5). It has long been known that Esthonia is built up of Silurian formations, from beneath which rises the Cambrian Ungulite sandstone characterised by *Obolus apollinis*. After the emergence of the Silurian deposits, the country remained for a vast period a barren land undergoing atmospheric denudation. During this long lapse of time the terrace of the Glint, which runs from Lake Ladoga to Baltisch Port, was formed. During the Glacial period the country was covered with an immense ice-sheet, which moved south-west in its western parts, due south in the middle, and south-east in its eastern parts. The bottom moraine of this ice-sheet spreads over the country, and consists of a mixture of far-transported boulders with debris of the local rocks. It is the equivalent of the British Till and of the Swedish *Krossstensgrus*. It sometimes gets the local name of *Riekk*. It rises into elongated hills or "drums," which extend also throughout the Government of Novgorod, and must be distinguished from the *Ascar*. These last, in the opinion of Prof. Schmidt, who indorses the explanation of A. Törnebohm, are shore-walls of those mighty sub-glacial rivers, so well described by Nordenskjöld, which circulate on the surface of the ice-sheets, and, after having found an exit through the ice, run beneath it.

During the first part of the Post-Glacial period the Gulf of Finland, and probably all the northern part of the Baltic Sea, formed an immense lake which subsequently was connected with the ocean, and received its brackish-water fauna. The level of this lake was about 60 feet higher than the present level of the Baltic. The presence of Baltic shells at greater heights in the north (the author of this notice found them at 124 feet, on

<sup>1</sup> *Ivestia geologicheskago Komiteta*, vols. i. and ii. (fasc. 1 to 6), 1882 and 1883.—*Izvestiya geologicheskago Komiteta*, vol. i. fasc. 1; 4to. (St. Petersburg, 1883.)

the northern coast of the Gulf of Finland, seven miles distant from the sea-shore) is explained by the increase of the rate of upheaval of the country towards the north. This old lake, like Lake Ladoga of our days, seems to have had but a poor fauna. Many smaller lakes which covered Esthonia, had a peculiar freshwater fauna. Gravel and sand, with *Ancylus fluviatilis*, like that found in Lake Baykal, and *Lymnaeus ovatus*, also *Neritina fluviatilis*, *Paludina impura*, *Unio*, and *Cycas* are found at heights varying from 50 to 150 feet above the actual sea-level. On these deposits are widely spread, and descend to a level of 20 feet above the sea. At a still later period the lakes were filled with ooze, which constitutes now the so-called "marl of prairies" (*Wiesenmergel*) filled up with *Planorbis*, *Lymnaeus*, &c., and containing also remains of man, together with bones of reindeer, as described by Prof. Grewingk.

In connection with this subject reference may be made to the conclusions arrived at as to the glacial formations by M. Nikitin, while making the geological survey within the limits of sheet 58 of the geological map of Russia, comprising Yaroslavl and the eastern parts of Novgorod and Tver. The features of the Till, or Boulder-clay, which covers this region, are so much at variance with the theory of floating ice, which has been proposed to explain them, as well as with every other aqueous theory, and so much in conformity with the idea of a bottom moraine, that M. Nikitin has been compelled to admit the former extension of the northern ice-sheet of the Glacial period through out the region of the Upper Volga (vol. ii. fasc. 3). The Boulder-clay of the Government of Poltava, sometimes 20 m thick, consists of triturated, unstratified materials, partly derived from sources within the region itself, and partly brought from the north. It contains scratched boulders, and though undoubtedly of glacial origin, its precise mode of formation still remains in dispute, notwithstanding the careful attention given to the study of the question by M. Armashévsky (vol. ii. fasc. 6).

### UNIVERSITY AND EDUCATIONAL INTELLIGENCE

CAMBRIDGE.—The Natural Sciences Tripos, Part I., commenced on May 17; Part II. will commence on May 29.

The examiners in the Mathematical Tripos of 1883-84 have reported that the work done in Part II. was on the whole disappointing, and inferior to that usually done in the old "five-days" examination. They suggest that this may be due to its taking place in the Easter Term, in which revision of subjects is usually much interrupted. In Part III. eleven candidates presented themselves, of whom seven were placed in the first division. The work was extremely good, the candidates having judiciously specialised their reading.

### SCIENTIFIC SERIALS

*Bulletin de l'Académie Royale de Belgique*, February 2.—On the crepuscular phenomena of the months of November and December 1883, by F. Terby.—On the physiological action of aspidospermine (bark of *Aspidosperma quebracho*), by Dr. Closson.—Remarks on some Sanskrit verbal roots of the eighth class, by J. van den Gheyn.—Contributions to the biography of the portrait painter A. de Vries, and of the Flemish painter Theodor van Loon, by Auguste Castan.—Biographical notice of the Dutch painter Marin van Romerswael, by Henry Hymans.

March 1.—Note on the Pons-Brooks comet 1812, observed at Louvain during the winter of 1883-84, by F. Terby, and at Brussels by L. Niesten.—On an empirical relation between the coefficient of internal friction of liquids, and its variations under changes of temperature, by P. de Heen.—Preliminary communication on the anatomy of the Acarians, a group of Arachnidæ, by J. MacLeod.—On the changes of refrangibility in the electrical spectra of hydrogen and magnesium, by Ch. Fievez.

*Journal of the Russian Chemical and Physical Society*, vol. xvi. fasc. 1.—The dilatation of liquids, by D. Mendeléeff.—On the tension of vapour of solutions, by D. Konvaloff. The author has resorted in his measurements to a method much like that of Magnus, and gives the results of his measurements (illustrated by curves) for mixtures of water with alcohols and acids: formic, acetic, propionic, and butyric; they

are followed by a discussion on the distillation of solutions, on mixtures, and on the solubility of liquids.—On an acoustic instrument for measuring the number of vibrations, by A. Izraïeff.—New demonstrations of the conditions of minimum of deviation of a ray by the prism, by K. Kraevitch. In most treatises on physics this demonstration is made by means of methods more or less artificial, excepting the treatise of Jamin, who has resorted to differential calculus. However long, M. Kraevitch's demonstration is very simple, and is deduced very naturally out of the fundamental laws of refraction.—On the friction of well lubricated bodies, by N. Petroff.

### SOCIETIES AND ACADEMIES

LONDON

Royal Society, May 8.—"On a Relation between the Coefficient of the Thomson Effect and certain other Physical Properties of Metals." By Shelford Bidwell, M.A., LL.B.

Having observed that the coefficient of the Thomson effect is generally positive in those metals which have a great specific resistance and specific heat, and negative in those which are distinguished by a great coefficient of expansion, the author endeavoured to find an empirical formula expressing the coefficient of the Thomson effect in terms of the specific resistance, specific heat, and coefficient of expansion. Though he was not altogether successful, he believes that the subjoined table points to a close relation between them.

I.	II.	III.	IV.
Metals	Coefficient of Thomson effect.	$H \times R - E^2$	Last column divided by 2400
Ni ...	5.12 ...	12320 ...	5.13
Fe ...	4.87 ...	9918 ...	4.13
Pd ...	3.59 ...	7086 ...	2.95
Pt (soft) ...	1.10 ...	2309 ...	0.96
Pt (hard) ...	0.75 ...	— ...	—
Mg ...	0.95 ...	1384 ...	0.58
Pb ...	0 ...	-604 ...	-0.25
Al ...	-0.39 ...	1942 ...	0.81
Sn ...	-0.55 ...	-868 ...	-0.36
Cu ...	-0.95 ...	-1137 ...	-0.47
Au ...	-1.02 ...	-1172 ...	-0.49
Ag ...	-1.50 ...	-2246 ...	-0.94
Zn ...	-2.40 ...	-2355 ...	-0.98
Cd ...	-4.29 ...	-4958 ...	-2.07

The first column contains the names of the metals, except alloys, given in Tait's thermo-electric diagram (*Trans. R.S.E.*, vol. xviii. p. 125). The second column gives the coefficients of the Thomson effect: these are taken from Everett's table ("Units and Physical Constants," p. 151), which is based upon Tait's diagram.

H, R, and E being numbers proportional to the specific heats, specific resistances, and coefficients of expansion of the various metals,  $H \times R - E^2$  gives the numbers in the third column of the table.  $H = \text{specific heat} \times 10^3$ ,  $R = \text{specific resistance} \times 10^3$ ,  $E = \text{coefficient of expansion} \times 10^6 \div 34$ . The multipliers  $10^3$  and  $10^6$  were used merely for the convenience of getting rid of decimals; the divisor, 34, was so chosen that while the ratio of the first number to the last in Column III. should be as nearly as possible equal to the ratio of the first number to the last in Column II., the number corresponding to lead in Column III. should at the same time be as near zero as possible. Both conditions could not be exactly fulfilled at once. The authorities for the specific heats, specific resistances, and coefficients of expansion are given in the paper.

Column IV. gives the numbers in Column III. divided by 2400, to facilitate comparison with Column I.

It will be seen that with one exception the order of magnitude of the numbers in Column IV. is exactly the same as the order of those in Column II. The rate of decrease is not, however, the same, the numbers diminishing too rapidly in the upper half of Column IV., and too slowly in the lower half.<sup>1</sup>

<sup>1</sup> With regard to aluminium it is suggested that Matthiessen's determination of the specific resistance, 0.009, is possibly too high. Moreover the author found experimentally that the Thomson coefficient of the specimen of aluminium which he used was slightly + instead of -, as given in Column II.: it is also shown as + in the diagram at p. 178 of Jenkin's "Electricity." If its specific resistance were as high as 0.006, it would come between magnesium and lead in Column IV.

**Geological Society, April 23.**—Prof. T. G. Bonney, F.R.S., president, in the chair.—The following communications were read:—On the geology of the country traversed by the Canada Pacific Railway, from Lake Superior to the Rocky Mountains, by Principal J. W. Dawson, C.M.G., F.R.S. This paper recorded observations made by the author with reference to the geology of the North-West Territories of Canada, in an excursion in the summer of 1883, along the line of the Canada Pacific Railway as far as Calgary, at the eastern base of the Rocky Mountains. After referring to the labours of the Canadian Geological Survey, and more especially of Dr. G. M. Dawson, in this region, the author proceeded to notice the Laurentian, Huronian, and other pre-Silurian rocks of the west of Lake Superior and the country between that lake and the Red River. Good exposures of many of these rocks have been made in the railway-cuttings, and important gold-veins have been opened up. The Laurentian rocks present a remarkable uniformity of structure over all the vast territory extending from Labrador to the Winnipeg River, and where they reappear in the mountains of British Columbia. They are also similar to those of South America and of Europe; and there was on the table a collection of Laurentian rocks from Assouan, in Upper Egypt, made by the author in the past winter, which showed the reappearance of the same mineral characters there. In Egypt there is also an overlying crystalline series, corresponding in some respects with the Huronian. The Huronian rocks west of Lake Superior are, however, more crystalline than those of Lake Huron, and may be of greater age. The Palæozoic rocks are exposed in places on the western side of the old crystalline rocks near the Red River, and show a remarkable union and intermixture of Lower and Upper Silurian forms, or rather, perhaps, a transition from the one fauna to the other in a very limited thickness of beds. The collections of Mr. Panton, of Winnipeg, were referred to in this connection. The Cretaceous and Eocene beds of the plains were then noticed, and certain sections showing the coal-bearing series described; and comparisons were instituted between the Cretaceous and Eocene succession in Canada and that in the United States and elsewhere. The Pleistocene drift deposits constitute a conspicuous feature on the western prairies. Along the railway, Laurentian, Huronian, and Palæozoic boulders from the east may be seen all the way to the Rocky Mountains, near which they become mixed with stones from these mountains themselves. The vast amount of this drift from the east and north-east, and the great distance to which it has been carried, as well as the elevation above the sea, are very striking. The great belt of drift known as the Missouri Coteau is one of the most remarkable features of the region. It was described in some detail where crossed by the railway, and it was shown that it must represent the margin of an ice-laden sea, and not a land-moraine, and that its study has furnished a key to the explanation of the drift deposits of the plains, and of the so-called "Terminal Moraine," which has been traced by the geologists of the United States from the Coteau round the basin of the Great Lakes to the Atlantic.—On the Dyas (Permian) and Trias of Central Europe and the true divisional line of these two formations, by the Rev. A. Irving, B.Sc.

**Zoological Society, May 6.**—Prof. W. H. Flower, F.R.S., president, in the chair.—Prof. Bell exhibited some specimens of *Rastheria melitensis* sent from Malta by Capt. Becher, R.A., and stated that, in answer to his inquiries, that gentleman had confirmed the fact of the males appearing in equal number the females, as had been stated by previous observers of the members of the genus.—Mr. G. A. Boulenger read a paper on the reptiles and Batrachians of the Solomon Islands, principally based upon two collections forwarded to the British Museum from that locality by Mr. H. B. Guppy, R.N.—Lieut.-Col. Godwin-Austen, F.R.S., exhibited an old Indian drawing representing a tiger-hunt; and called attention to the colour of one of the elephants engaged, which was of a creamy white.—Prof. Flower, F.R.S., described the state of dentition of a young Capybara (*Hydrochærus capybara*) born in the Society's Gardens, which had died when eight days old. All the teeth of the permanent series were present and in use.—Prof. F. Jeffrey Bell read a paper on *Amphicyclus*, a new genus of Dendrocinotous Holothurians, and its bearing on the classification of the suborder.—A communication was read from Mr. Edgar A. Smith, containing a report on the land and freshwater Mollusca which had been collected during the voyage of H.M.S. *Challenger* from December 1872 to May 1876. The collection contained examples of 152 species, some of which were of interest and several new to science.—A

communication was read from Count Berlepsch and M. Taczanowski, containing an account of a second collection of birds made in Western Ecuador by Messrs. Stolzmann and Siemiradzki. There were stated to be examples of 177 species in this collection, which had been made at various localities on the western slope of the Cordilleras above Guayaquil. The following species were described as new:—*Henicorhina hula-is*, *Chlorospingus ochraceus*, and *Spermophila pauper*. A new genus, *Psittoliticus*, was proposed for *Todirostrum ruficeps* of Kaup.—A paper by Messrs. Godman and Salvin was read, which contained a list of the Rhopalocera obtained by Mr. G. French Angas during a recent visit to the Island of Dominica. The number of species in this collection was twenty-seven, among them being a species of Nymphaline apparently new; this the authors proposed to describe as *Cymatogramma dominicana*.—Mr. Herbert Druce read a paper describing the Heterocera collected by Mr. Angas on the same island.

**Victoria Institute, May 6.**—Vice-Chancellor Dawson, C.M.G., of McGill University, Montreal, read a paper on prehistoric man in Egypt and Syria, and described the investigations which he had carried on during the winter in Egypt and Syria. Dr. Dawson illustrated his paper by diagrams and specimens, among which were several of the bones of animals, in the classification of which Prof. Boyd Dawkins, F.R.S., had taken part; in dealing with his subject Dr. Dawson remarked that great interest attaches to any remains which, in countries historically so old, may indicate the residence of man before the dawn of history. In Egypt, nodules of flint are very abundant in the Eocene limestones, and, where these have been wasted away, remain on the surface. In many places there is good evidence that the flint thus to be found everywhere has been used for the manufacture of flakes, knives, and other implements. These, as is well known, were used for many purposes by the ancient Egyptians, and in modern times gun-flints and strike-lights still continue to be made. The debris of worked flints found on the surface is thus of little value as an indication of any flint-folk preceding the old Egyptians. It would be otherwise if flint implements could be found in the older gravels of the country. Some of these are of Pleistocene age, and belong to a period of partial submergence of the Nile Valley. Flint implements had been alleged to be found in these gravels, but there seemed to be no good evidence to prove that they are other than the chips broken by mechanical violence in the removal of the gravel by torrential action. In the Lebanon, numerous caverns exist. These were divided into two classes, with reference to their origin, some being water-caves or tunnels of subterranean rivers, others sea-caves, excavated by the waves when the country was at a lower level than at present. Both kinds have been occupied by man, and some of them undoubtedly at a time anterior to the Phœnician occupation of the country, and even at a time when the animal inhabitants and geographical features of the region were different from those of the present day. They were thus of various ages, ranging from the post-Glacial or Antediluvian period to the time of the Phœnician occupation. In illustration of this, the caverns at the Pass of Nahr-el-Kelb and at Ant Elias were described in some detail, and also, in connection with these, the occurrence of flint implements on the surface of modern sandstones at the Cape or Ras near Beyrout. These last were probably of much less antiquity than those of the more ancient caverns.

## SYDNEY

**Linnean Society of New South Wales, March 26.**—C. S. Wilkinson, F.G.S., F.L.S., president, in the chair.—The following papers were read:—On plants which have become naturalised in New South Wales, by the Rev. W. Woolls, Ph.D., F.L.S. In this paper the author not only deals with the various importations, whether intentional or otherwise, of new and often injurious weeds, but also with the general and deliberate destruction of the native flora, especially in timber. He also points out that many of our most valuable trees, as for instance the Myall (*Acacia pendula*), are dying out in consequence of the want of any kind of protection for the young plants. They are produced in abundance, but eaten down as fast as they grow. The paper contains a complete account of all the exotic *Mono-* and *Di-cotyledons* known in the colony.—The Australian *Hydromedusa*, part i., by R. von Lendenfeld, Ph.D. It is proposed in this paper to describe a series of new species of *Hydromedusa* of our shores. A new classification of the *Hydromedusa* is proposed. The present paper forms a



*Prodromus* of a system of the *Hydroid Zoophytes* and *Craspedote Medusa*, which will be used and marked out in detail in subsequent papers. The order of the *Hydromedusa* is here divided into five sub-orders and twenty-one families.—The *Scyphomedusa* of the Southern Sea, part ii., by R. von Lendenfeld, Ph.D. This paper is a continuation of the paper read at the last meeting of the Society, and contains a description of all the species of the third order of the *Scyphomedusa*, the *Cubomedusa*, which have been described from the South Sea.—On some fossil plants from Dubbo, New South Wales, by the Rev. J. Milne Curran, F.G.S. This paper, which was illustrated by specimens in an extraordinary state of preservation, and mounted for the microscope, is a very careful essay towards the determination of the (so-called) Hawkesbury beds at Dubbo, and names or describes as belonging to that formation the following forms, viz.:—*Sphenopteris crebra*, *S. glossophylla*, *Neuropteris australis*, *Thinsfeldia odontopteroides*, *T. media*, *Alethopteris Curranii*, *A. concinna*, *Merianopteris major*, and a Conifer, *Walchia milneana*. Of new species Mr. Curran names *Odontopteris macrophylla*, *Alethopteris (Pecopteris) australis*, *Hymenophyllites dubia*, *Podosamites*, sp., and one Conifer set down doubtfully as *Walchia piniformis*.

## BERLIN

**Physiological Society**, April 18.—Prof. Zuntz, with the help of a diagram, described and explained an apparatus for determining the gaseous inhalation and exhalation in the case of animals affected with curare. Essentially it consisted of two glass bells set by means of an electric motor into regular up-and-down rhythmical movements, alternately sinking into a larger vessel filled with mercury, and rising out of it. Each bell had two connecting-tubes, one communicating with the animal under examination, the other with other parts of the apparatus. One bell was connected with a graduated reservoir containing the air that was to be inhaled, while the second communicated with a bell, likewise graduated and filled with mercury, intended to receive the exhaled air. By means of inserted mercurial valves the path of air was so arranged that in the rising of the bells the first came into communication only with the reservoir, and filled itself with the contents of the same, while the second bell had communication solely with the trachea of the animal, and drew in the air of the lungs. In the sinking of the bells, on the other hand, the first communicated with the trachea, and forced the air that was to be breathed into the lungs, while the second communicated with the reservoir, and emptied into it the air previously exhaled from the lungs. This apparatus kept up the most regular artificial respiration in animals paralysed by curare for any length of time, even for many hours, and enabled, on the one hand, gases that might be exactly measured, and of any composition that might be desired, to be employed for the purpose of respiration; on the other, the products that were exhaled to be collected for measurement and chemical analysis. A whole series of other arrangements connected with this respiratory apparatus, provided automatically for supplying the reservoir with exactly the appointed kind of air and in uniformly identical mixture, as also for producing and conducting to the reservoir, automatically, the requisite quantities of oxygen for determinate experiments.—Dr. Kempner, with the apparatus above described, had, in the laboratory of Prof. Zuntz, instituted measuring experiments on the influence of the proportion of oxygen in the air that was to be inhaled on the consumption of oxygen and the exhalation of carbonic acid from the lungs. It was a universally accepted doctrine that the proportion of oxygen in the air to be inhaled might vary within very wide limits, from between 100 and 15 per cent., without essentially affecting the respiration, and that only when the oxygen sank to 5 per cent. or less did phenomena of suffocation appear. This view, which was based principally on the experiments of Regnault and Reiset, was not, in Dr. Kempner's opinion, sufficiently justified by the experiments referred to. In consequence he some years ago carried out experiments on himself by inhaling, for the space of ten minutes on each occasion, by means of forced inspiration, air of different proportions of oxygen, and then analysing the exhaled air. From these experiments he found that respiration and the consumption of oxygen were not influenced by a higher than the normal proportion of oxygen in the air that was breathed. With a reduction, however, of the oxygen in the air to be inhaled below the normal proportion, the consumption of oxygen became likewise reduced. It might be supposed that this result, which was at variance with the general view on the subject, was

due to the abnormal conditions of respiration and the forced inspiration. It was necessary, therefore, that this result should be confirmed by experiments on animals. Such, accordingly, were soon afterwards carried out by Dr. Kempner, and yielded a result similar to that arrived at in the experiments on men. Seeing, however, that the movements of the animal might have affected the result, Dr. Kempner determined on repeating the examination with animals that had been subjected to curare. The experiments were carried out on animals with the respiratory apparatus of Prof. Zuntz. After fasting for twenty-four hours, the animals were kept, throughout the time that the experiments lasted, in exactly the same temperature—which was a warm one—and they made thirty artificial respirations per minute. The result yielded by these last experiments was that with a higher than the normal proportion of oxygen in the air breathed the consumption of oxygen was not different from that in the case of normal air. When, however, the proportion of oxygen sank to 18 per cent., the consumption of oxygen became diminished, and decreased still further in proportion as the oxygen of the air was further lessened. Similarly the amount of carbonic acid exhaled was affected by the reduced proportion of oxygen in the inspired air. Carbonic acid also decreased with the decrease of oxygen, though not in the same degree as did the consumption of oxygen, a circumstance which pointed to the fact that in the exhaled carbonic acid was contained a certain portion of this gas formed by processes of dissociation independently of the oxygen of the inhaled air. An explanation of this fact, of such high importance physiologically, that a reduced proportion of oxygen in the air inhaled was attended by a reduced consumption of oxygen, was next given by the speaker, and in conclusion he indicated a series of practical useful applications which might be made of the fact.

## CONTENTS

	PAGE
Vestiges of Creation. By Dr. George J. Romanes, F.R.S.	73
Natterer's Brazilian Mammals	74
Our Book Shelf:—	
Roscoe and Schorlemmer's "Treatise on Chemistry."	
—Dr. H. Watts	75.
Letters to the Editor:—	
Geology of the Malayan Peninsula.—Rev. J. E. Tenison-Woods	76
The Marine Biological Station and a Coast Survey.—Prof. E. Ray Lankester, F.R.S.	76
Atlantic Ice and Mild Winters.—Dr. John Rae, F.R.S.	76
Right-sidedness.—Prof. Joseph Le Conte	76
Dark Transit of Jupiter's First Satellite.—W. F. Denning	77
The Remarkable Sunsets.—Rev. Arthur Sowerby	77
"Notes on Earthworms."—E. A. Swan	77
The Recent Earthquake.—M. I. Plarr	77
Animal Intelligence.—E. A. Loneragan	77
Agriculture in the United States	77
Bird Skeletons	78
The "Potétomètre," an Instrument for Measuring the Transpiration of Water by Plants. By Prof. H. Marshall Ward ( <i>Illustrated</i> )	79
Auroral Researches in Iceland. By Dr. Sophus Tromholt	80
A Carnivorous Plant Preying on Vertebrata. By Prof. H. N. Moseley, F.R.S.	81
Notes	81
Our Astronomical Column:—	
A New Comet of Short Period	83
Chemical Notes	84
On the Nomenclature, Origin, and Distribution of Deep-Sea Deposits, I. By John Murray and A. Renard	84
The Two Manners of Motion of Water. By Prof. Osborne Reynolds, F.R.S.	85
Report on Atmospheric Sand-dust from Unalaska. By J. S. Diller ( <i>Illustrated</i> )	91
The Polar Conference. By Robert H. Scott, F.R.S.	93
Geology in Russia	93
University and Educational Intelligence	94
Scientific Serials	94
Societies and Academies	94

THURSDAY, MAY 29, 1884

## • THE DILUTION OF DOG POISON

**M.** PASTEUR has communicated to the French Academy of Sciences (May 19, 1884) the results of his experiments on the attenuation of the virus of rabies, which, if they should be confirmed, would furnish us with the means of protecting dogs from rabies, and as a necessary sequel of protecting the human race from hydrophobia, that absolutely deadly and intractable disease which in every country where rabies exists devours every year some hundreds of human victims.

Starting from the idea, now well established for at least some of the infectious maladies, viz. that the virus of a particular disease of this class on its passage through different species of animals is subject to alteration of its virulence, M. Pasteur inoculated monkeys with the virus taken from a dog affected with rabies, and found that it thereby became considerably altered. This alteration consists in a decrease of intensity, and it is the more marked the greater the number of removes. After the third remove (*i.e.* after having passed successively through three monkeys) it becomes attenuated to such a degree that inoculation with it of dogs, rabbits, and guinea-pigs does not produce fatal rabies. Dogs so inoculated remain protected against further virulent poison such as is derived from a rabid dog.

But on the other hand the virus of rabies on its passage through the rabbit and guinea-pig increases in virulence, its intensity becoming even greater than that of the virus taken from a dog, rabid in the usual way (*rage des rues*). The maximum increase in intensity is not, however, attained until several transmissions through the rabbit or guinea-pig.

In this way it is possible to produce virus of various degrees of intensity, from the weakest, *i.e.* virus taken from the rabid dog and passed successively through several monkeys, to the strongest, *i.e.* virus passed successively through several rabbits or guinea-pigs.

M. Pasteur states that he has succeeded, by inoculation of the blood of rabid animals, in devising a simple method of obtaining attenuation of the virus, and of herewith protecting dogs from fatal rabies, but the experiments not being yet completed do not permit of a detailed description.

Without wishing to say anything derogatory as regards these remarkable results, it is greatly to be regretted that M. Pasteur, not being himself a pathologist, has not availed himself of the aid of his medical colleagues, in order to definitely ascertain whether the disease which he produced by inoculation in the dog, monkey, rabbit, and guinea-pig—for this seems to be at the root of his statements—was really rabies. However, he has asked and obtained from the French Minister of Public Instruction a Commission which is to compare the results of the inoculation, from a rabid dog, of twenty dogs, previously treated by M. Pasteur with his attenuated virus, with those of the inoculation of twenty other dogs not previously "vaccinated."

VOL. XXX.—No. 761

This Commission, comprising such acknowledged authorities in physiology and pathology as M. Bécclard, M. Paul Bert, M. Bouley, Dr. Villemin, and Dr. Vulpian, will no doubt soon be able to decide this question one way or the other, and its judgment will be awaited by all medical men as well as by the general public with anything but indifference.

The experiments of M. Pasteur, published in the *Comptes Rendus* of the Academy of Sciences for May 19, are these:—

I. "If rabies is transmitted from the dog to the monkey, and further, from monkey to monkey, the virulence of the virus becomes weakened on each transmission. The virus, having become diminished in virulence by the transmissions from monkey to monkey, if reintroduced into the dog, rabbit, or guinea-pig, maintains its attenuated character. In other words, the virulence does not return at a bound to the virulence of the virus of a dog affected with rabies of the usual kind, *i.e.* produced by the bite of a dog (*à rage des rues*).

"Under these conditions the attenuation can easily be accomplished by a small number of transmissions from monkey to monkey, to such a point that it does not produce rabies in the dog by hypodermic inoculation. Even inoculation by trephining, an infallible method to communicate rabies, cannot produce any result; it creates nevertheless a refractory condition of the animal against rabies.

II. "The virulence of the rabid virus increases on its passage from rabbit to rabbit, and from guinea-pig to guinea-pig. When in this way the virulence has reached its maximum in the rabbit, it can be transmitted in this state to the dog, and it shows here a much greater intensity than the virus obtained from a dog affected with rabies in the usual manner (*rage des rues*). This virulence is of such an intensity that after inoculation into the blood of a dog it invariably produces fatal rabies.

III. "Although the virulence increases on the passage of the virus from rabbit to rabbit, or from guinea-pig to guinea-pig, it requires several successive transmissions through these animals to attain its maximum, having previously become attenuated by its passage through the monkey. Similarly the virulence of the ordinary rabies of the dog, which, as we have just shown, is not by any means the greatest that the rabid virus is capable of attaining, requires several successive transmissions through the rabbit in order to attain its maximum.

"It follows from the experiments just described that we can easily render dogs proof against rabies. It is readily understood that the experimenter can at will procure rabid virus attenuated in various degrees: some, non-fatal, protecting the animal from the effect of more active as well as of fatal virus.

"The following example illustrates this:—Extract by trephining from a rabbit dead of rabies after an incubation prolonged by several days beyond the shortest period of incubation in the rabbit. This latter is generally comprised within seven to eight days after inoculation, by trephining, with the most intensive virus. From the above rabbit, *i.e.* the one with the prolonged incubation, virus is taken and inoculated, always by trephining, into a second rabbit; from this again virus is taken and inoculated into a third rabbit. Each of these different samples

F

of virus, increasing in strength on every transmission, is at the same time inoculated into a dog. This latter will then be found capable of resisting the most fatal virus, having become completely refractory to rabies, no matter whether the virus, derived from a case of common rabies (*rage des rues*), is introduced by intravenous inoculation or by trephining."

### THE MAMMALIA OF INDIA AND CEYLON

*Natural History of the Mammalia of India and Ceylon.*

By Robert A. Sterndale, F.R.G.S., F.Z.S. (Calcutta: Thacker, Spink, and Co.; London: Thacker and Co., 1884.)

THIS book may fairly be described as an attempt by an unscientific writer to compile a scientific work. The author is favourably known as a describer of Indian wild sports, and his observations on the habits of animals are generally good and often original. His best known publication, "Seonee or Camp Life in the Satpura Range," although not quite equal to Forsyth's delightful "Highlands of Central India," rises above the level of ordinary Indian sporting works. In the volume now published he has attempted the somewhat ambitious task of compiling a popular manual of Indian mammalia, comprising not only those described in Jerdon's "Mammals of India" (which is restricted to the kinds found in the Indian Peninsula and the Himalayas), but also the species living in Assam, Burmah, Ceylon, and "the countries bordering the British Indian Empire on the north." By including some (not all) of the mammals described by A. Milne-Edwards from Eastern Tibet, several of those recorded by various authors from Kashgaria, Afghanistan, and Persia, and some Malay types, the total number of species enumerated is brought up to 482. This number, however, is partly made up by nominal species, the writer having compiled his lists from various authorities of unequal value.

Had Mr. Sterndale confined his descriptions to the larger and better known mammals of India and the surrounding countries, he might possibly have achieved greater success. He has bestowed much labour upon the book, and has in some cases, but unfortunately not in all, had recourse to good and recent information. Thus he adopts Flower's and Mivart's classification of the *Carivora*, and Alston's arrangement of the rodents, whilst he places the dugong in the *Cetacea*, and *Galeopithecus* amongst the lemurs.

The actual descriptions of species are for the most part taken from other writers, and the same may be said of localities, which, however, are not always correct, even in the case of the larger and better known animals. Thus the markhor (*Capra falconeri* v. *megaceros*) is said to be found in Ladakh, where it does not occur, although common in Astor and Gilgit, and the hog-deer, *Axis porcinus*, is stated to exist "throughout India, though scarce in the central parts," whereas it is not known with certainty to inhabit any part of the peninsula of India except the plains of the Ganges and Indus. Many other instances might be quoted. Mr. Sterndale is not even aware that *Tragulus kanchil* exists in Tenasserim, although its occurrence there was well known to Blyth, at least twenty-five years ago. He is unaware also that *Canis lupus* has been obtained in Gilgit, and *Nectogale*

*elegans* in Sikkim. But although *Tragulus kanchil* does not receive a number and separate notice as one of the Indian mammalia, *Mustela nudipes*, a purely Malay insular type, not recorded from continental Asia, is included in the list as No. 190, with the remark that "this species may be discovered in Tenasserim." There is a want of system in the admission and exclusion of species throughout. Thus *Macacus thibetanus* (No. 23) and *Nemorhadus edwardsii* (No. 453) are described, whilst *Semnopithecus roxellana*, *Elaphodus cephalophus*, and *Cervulus lachrymans* are ignored, although all are from the same country in Eastern Tibet, and described in the same work by one author. Similarly whilst some Andaman and Nicobar bats, e.g. *Rhinolophus andamanensis* (No. 48) and *Phyllorhina nicobarensis* (No. 63) are included, no mention is made of four *Megacheiroptera* from the same islands, viz. *Pteropus nicobaricus*, *Cynoptyrus brachyotus*, *C. scherzeri*, and *C. brachysoma*.

As might be anticipated, the micro-mammalia are not treated in a manner that will afford much aid to a student. The writer is unacquainted with Mr. Oldfield Thomas's important paper on the rats and mice, and with Mr. Dobson's work on the *Insectivora*. The account of the latter order and of the *Rodentia* is full of errors. The mistakes in the case of the bats are even less excusable, for Dobson's catalogue is quoted, and, to some extent, followed. Had Mr. Sterndale simply taken all his names, descriptions, and localities from Dobson he would have been safe. But he appears to have found a difficulty in making the names and the arrangement in Jerdon's "Mammals" fit into Dobson's scheme, and he has adopted a compromise, with the result that, besides repeating several mistakes of Jerdon's, he has added not a few of his own. Thus, to take a few examples, he gives as two distinct species No. 54, *Hipposideros armiger*, and No. 64, *Phyllorhina armigera*, although he notices that *Hipposideros* and *Phyllorhina* are the same genus. He quotes as distinct species No. 92, *Scotophilus fuliginosus*, and No. 119, *Miniopterus schreibersii*, shown by Dobson to be identical. Similarly No. 58, *Hipposideros larvatus*, is the same as No. 59, *H. vulgaris*. But perhaps the most characteristic instance of error is in the last species in the order No. 121, *Nyctophilus geoffroyi*. This is taken from Jerdon, and no trace of it is said to be found "in Dobson's monograph, which is so exhaustive as far as Asiatic species are concerned." As the bat in question (*N. timoriensis*) is peculiar to the Australian region, it is naturally omitted in Dobson's "Monograph of Asiatic Chiroptera," but it is included in his General (British Museum) "Catalogue of Chiroptera." Jerdon's mistake in classing the species as Indian was founded on what looks very like a printer's error in Blyth's "Catalogue of Mammalia in the Museum of the Asiatic Society."

These details will show the character of the work: mistakes such as those enumerated are to be found throughout. At least a dozen omissions have been noted besides those already mentioned. The book is well printed and illustrated, and many details of osteology, &c., described and figured, so that it is important to show why, despite its merits, it falls far short of what is required in an exhaustive account of Indian mammalia.

There are two portions of the work of which it is possible to speak in terms of high praise. First, wherever

the habits of animals are recorded on personal observation they have evidently been accurately and carefully noted. The author is a genuine naturalist with a thorough love and admiration for animals, and in consequence he possesses considerable power of understanding and appreciating them. Secondly, the woodcuts are numerous and for the most part excellent. A few, such as the big-headed Gaur (*Bos gaurus*) on p. 530 and the musk-deer on p. 493 are less successful, and it may be questioned whether a nylgao can stretch itself into the gallop depicted at p. 477, but the spirit of the cut last-named would atone for a worse fault, and there is far more ground for admiration than for criticism. As an amusing work, with good illustrations, to which residents in India may have recourse for the identification of the principal mammals, this volume will probably find a ready place in the Anglo-Indian library. For the determination of the smaller kinds, and for a knowledge of the less known and more difficult species, the student will do well to search elsewhere.

W. T. B.

#### NORTH AMERICAN MOLLUSCA

*A Review of the Non-Marine Fossil Mollusca of North America.* By Charles A. White. (Washington: Government Printing Office, 1883.)

THE Hon. J. W. Powell, the Director of the Geological Survey in the United States, continues his valuable contributions to scientific knowledge by the publication of his annual reports; and the volume which is now before us forms part of the Report for 1881-82.

This volume contains 144 pages, besides a full index, and thirty-two lithographic plates. It is carefully and modestly written, and the author candidly admits that our knowledge of the subject treated by him is "very imperfect." The title of the work may be open to a slight criticism; and the word "inland" ("binnen" in German) might be preferable to the negative expression "non-marine," which is used by the author.

The geological formations which are embraced in the "Review" are the Devonian, Carboniferous, Jurassic, Triassic, Cretaceous, Laramie, and Tertiary. With respect to the Laramie formation, the author regards the group as occupying a transitional position between the Cretaceous and Tertiary; it is remarkably fossiliferous, inasmuch as a greater number of the species mentioned in the "Review" come from that group than from any other. The total number of North American non-marine or inland fossil species and well-marked varieties appears to be 227, of which 141 are found in the Laramie formation or group. Twelve species are Palæozoic, and of these no fewer than seven species belong to the Pulmonibranchiata, and to the families *Limacidae* and *Helicidae*, which are not only terrestrial mollusca, but undoubtedly air-breathers. *Strophites grandæva* of Dawson, from the Devonian formation, is by far the most ancient land shell hitherto known to us. In the face of these facts and in the absence of any facts to warrant the conclusion of the author, how can we reasonably agree with him "that molluscan life began in the sea, and that all fresh-water and land mollusca have been primarily derived from those of marine origin"? Although no land mollusk has yet been discovered in the oldest fossiliferous formation, it is evident that land and

consequently terrestrial conditions must then and long previously have existed, so as to account for the sedimentary strata of which that formation consisted and for the prevalence of *Lingula* and other shallow-water Brachiopoda in the Silurian epoch.

It is curious to notice that so many species of what are usually considered marine Conchifera (*Ostrea*, *Anomia*, and *Mytilus*) occur in the Laramie group, and one of *Anomia* in the Cretaceous formation. This confirms the experiments of Beudant and other naturalists, that many marine gill-bearing mollusks can live either in their own native and proper element or can gradually become accustomed to a brackish and ultimately a fresh-water habitat. The author also notes the "persistence through long periods of geological time of even the simpler types of non-marine mollusks, after they were once established." And he remarks with respect to the Gastropoda that, "although in geological rank the Gastropoda are so much in advance of the Conchifera, the various families of the former seem to have been developed as early in geological time as those of the latter, and so far as we are now acquainted with the history of the fossil non-marine mollusca of North America, it appears that highly-organised land pulmonate Gastropods were introduced quite as early as any of the Conchifers. Indeed from present indications we are led to believe that the relations of the different classes of non-marine mollusca to each other were much the same in all geological epochs as they are to-day." The following is also interesting:—"Notwithstanding the annual migration of myriads of aquatic birds between the northern and southern provinces of North America at the present time, and doubtless also ever since it has been a continent, the fresh-water molluscan fauna of those regions respectively are still distinct."

A few minor points of classification which are met with in the present work will not be accepted by conchologists without some hesitation, e.g. the extension of the so-called family *Rissoidea* (or more properly *Littorinidae*) so as to include the genera *Hydrobia* and *Bythinella*, which latter is a subgenus of *Bythinia* and belongs to the *Paludinidae*. The families *Pisidiidae*, *Physidae*, *Ancylidae*, *Vitrinidae*, *Artionidae*, *Pupidae*, *Succinidae*, and *Viviparidae* seem to be also superfluous. In every well-organised army there ought to be a due proportion of men to officers of different ranks.

J. GWYN JEFFREYS

#### OUR BOOK SHELF

*Plant-Life.* By Edward Step. Third Edition. (London: T. Fisher Unwin, 1884.)

THIS is another attempt to give a popular description of some of the more sensational parts of the science of botany; though the plan is disconnected, the general idea of the book would not be bad, provided it were well carried out. It is to be regretted that the author has failed to realise that it is necessary to be accurate in popular description. For instance, it is gravely stated in italics that roots are never green (p. 29); we also read that *Ruscus aculeatus* "presents the remarkable appearance of a flower growing in the centre of a leaf" (p. 94), that the Cryptogams have no embryo (p. 211), and that the *Ricciaceæ* and *Characeæ* have stomata (p. 212)! On p. 171 he mistakes intercellular spaces for cells in *Isotiles*, which he classes under the *Marsiliaceæ* (spelt *Marsileaceæ*, p. 212; and on p. 165 we are informed that the elaters

of *Equisetum* are composed of cells. As is usual in works such as this, the terminology of the reproductive organs of the lower forms is very erratic; thus he uses the terms "spore" and "antheridium" as equivalent in *Selaginella* (p. 139), he calls the "sporogonia" of the Mosses "sporangia," and the "oogonia" of *Fucus* "perispires."

On the subject of the lichen-gonidia theory he waxes warm, stating (p. 150) that it has been "termed sensational romance by every well-known practical fungologist and lichenologist." Of course every one is free to express his own opinion, but few who are not blind partisans will be prepared to agree with Mr. Steyermark in excluding such men as De Bary, Schwendener, and Stahl from the list of "well-known practical fungologists and algologists."

Till so-called popular books are written with more accuracy, we should strongly advise those who wish to dabble in science either to abstain, or, better, to brace their minds to attack some text-book which can be depended upon: after this, if they wish, they can easily supply for themselves that cheap sentiment with which "Plant-Life" abounds.

### LETTERS TO THE EDITOR

[The Editor does not hold himself responsible for opinions expressed by his correspondents. Neither can he undertake to return, or to correspond with the writers of, rejected manuscripts. No notice is taken of anonymous communications.]

[The Editor urgently requests correspondents to keep their letters as short as possible. The pressure on his space is so great that it is impossible otherwise to insure the appearance even of communications containing interesting and novel facts.]

#### The Equatorial Coude of the Paris Observatory

IT was only on the 7th of this month that my attention was called to a letter in NATURE (p. 4) from M. Lœwy, headed "Reply to Mr. Grubb's Criticisms on the Equatorial Coude of the Paris Observatory." I deferred answering this letter as I was travelling at the time, and had not the necessary data by me to refer to; further, because I desired to see the second part of M. Lœwy's letter before making my reply; and lastly, because I hoped that some of the errors in M. Lœwy's first letter were misprints, and that he would have corrected them in his second.

I may observe in passing that the paper to which M. Lœwy alludes is a description of an instrument in the construction of which I am at present engaged, and that any criticisms of the equatorial coude which it contained were merely incidental.

M. Lœwy assumes that my instrument is a modification of one which he described in 1871 in the *Comptes Rendus*. This description I have, as it happens, never seen, nor am I much concerned to defend myself from the suggestion of plagiarism, since the fundamental principle of what I have called the "siderostatic telescope" is one of the advantages of which were recognised long before 1871, although mechanical difficulties prevented its application.

I find some difficulty in rendering my reply intelligible to your readers, for although the equatorial coude has been described and figured in NATURE, they are not as yet familiar with the form of the instrument which I am at present constructing. I now proceed to consider M. Lœwy's first letter.

I cannot admit that M. Lœwy's recital of what he is pleased to call my criticisms is accurate. He says:—

"To give weight to his argument Mr. Grubb examines a case of the construction of an instrument of 27 inches aperture, and he anticipates in the construction the following difficulties which he considers insurmountable:—(1) The optical difficulty of constructing a large plane mirror. (2) The practical difficulty of procuring a disk of the necessary dimensions. Mr. Grubb affirms there is no glass-works capable of making a disk of glass so large. (3) The difficulty of moving a mirror of which the weight, according to Mr. Grubb's calculations, will be very nearly half a ton. (4) The dearness of the instrument, which would cost more than an ordinary equatorial plus dome and observatory."

With regard to (1) I may remind M. Lœwy that I distinctly admitted the "possibility" of constructing such a mirror, but I expressed the opinion that inasmuch as no mirror of this size had yet been attempted success was problematical.

I now learn from M. Lœwy that such a mirror has been made,

and that it "leaves absolutely nothing to be desired"; but he has not told us to what tests this mirror has been subjected. I am not aware that there exists in Paris an object-glass of sufficient size to embrace the whole pencil of light reflected from it, and without this it is not possible, in my opinion, to apply tests which can be legitimately considered final.

(2) I did say that I believed it to be impossible to obtain disks of such large dimensions, and I founded my belief on the fact that not many years ago I applied to several of the principal glass manufacturers of England, France, and Germany for prices of disks for mirrors, the weight of which would have been less than those mentioned by M. Lœwy, and none were willing to undertake the work. I am glad, however, to learn from M. Lœwy that the glass manufacturers are now prepared to furnish disks of such a size.

(3) The next difficulty M. Lœwy attributes to me is "the difficulty of moving a mirror of which the weight, according to Mr. Grubb's calculations, will be very nearly half a ton," and this, he says, "has arisen from some error in calculation."

I would ask M. Lœwy to point out where I said anything of the difficulty of moving a mirror of half a ton weight. As I had a considerable share in the construction of the Melbourne mirrors, which weighed nearly four times this, it is hardly likely that I would assert such an absurdity; and as to the allegation of a wrong calculation, I ask M. Lœwy to point out the mistake he refers to, and in order to give him every facility for so doing I append it below. It is necessary first, however, to settle the matter of thickness.

M. Lœwy, in NATURE, May 1 (p. 5), says:—"I have never said that the thickness should be 0.18 of the diameter. I have given 0.18 as a maximum."

I have, however, before me a paper presented by M. Lœwy to the Academy of Sciences, March 19, 1883, in which occurs the following passage:—"Mes recherches m'ont démontré que pour prévenir dans un miroir toute déformation causée par la flexion ou un léger serrage, il faut que l'épaisseur du verre soit de 0.18 du diamètre." Now if I understand this rightly, it means that he has found 0.18 of the diameter to be the *minimum* thickness necessary, and in no part of that paper does he speak of 0.18 as a *maximum*. He mentions in the following paragraph that a thickness of one-fourth is necessary under certain conditions; and further on in the same paper he says:—"C'est dans ces conditions que les miroirs du nouvel instrument ont été construits." This being so, I still think I was justified in assuming 0.225, a mean between one-fifth and one-fourth, as that which he recommended. Now as to diameter. He assumes a diameter of 38 inches to be sufficient for a 27-inch objective, but  $27 \times \sqrt{2} = 38.178$ . Even this would only give full aperture of objective for the central pencil. For a moderate field nearly 38½ would be in actual use.

Again, no optician in practice thinks of making a mirror without some margin; in small sizes one-fourth to one-half of an inch, but in such a size as this three-fourths of an inch all round is not an extravagant allowance, and therefore in adopting 40 inches diameter I did not exaggerate.

I therefore had as my data—

Diameter 40 inches.

Thickness  $40 \times 0.225 = 9$  inches.

The calculation then is simple.

$$\text{Solid contents in cubic feet} = \frac{\text{Area of 40 inch circle} \times 9}{1728} = 6.547 \text{ cubic feet};$$

and, taking a specific gravity of 2.5, each cubic foot would weigh 156½ lbs.; therefore the weight of mirror =  $6.547 \times 156.25 = 1023$  lbs., or rather more than 9 cwt. I said nearly half a ton.

I may add that the specific gravity of the glass supplied to me by Messrs. Chance is rather more, viz. 2.52, which would give a higher result.

In another place M. Lœwy represents me as finding that "the mirror necessary for an equatorial coude of 27 inches would weigh 8½ tons"!!

I never made such a statement, and I challenge M. Lœwy to say what grounds he has for this assertion.

This is the second case in which he attributes to me statements which I have not made. A third and a fourth we shall come to just now. Your readers will remark that M. Lœwy (except in one minor instance) never quotes my words. Hence perhaps have arisen the serious mistakes into which he has fallen. Respecting the matter of thickness, M. Lœwy appears to have

altered his opinion since he presented his paper on March 19, 1883, to the Academy of Sciences; but, as I have shown, *he did make the statement he now repudiates*; and even if the result of my calculations, founded upon that statement, do not agree with what he now considers to be necessary, he has no right to attribute the discrepancy to any error of mine.

M. Lœwy then proceeds to show that it is possible to attach a weight of three-quarters of a ton to end of cross tube. This, I need hardly say, I never disputed; what I did say was, "The absurdity of hanging this three-quarters of a ton" (*i.e.* weight of mirror, objective, and all their supports and attachments) "on end of cross tube, and yet calling the instrument one of precision, is too apparent to need demonstration." If I were asked if it would be possible to hang three-quarters of a ton on each end of the Greenwich transit, I might be able to reply in the affirmative, but if I were asked to guarantee that the instrument would, under its new conditions, be as perfect an instrument of precision as it is in its present state, I would not be inclined to risk my "reputation" by any such guarantee, and yet M. Lœwy compares the equatorial *condé* to a transit instrument in stability.

Lastly, on the question of expense. M. Lœwy is anxious to know where I obtained my information, but as I am content to accept his own figures (see his letter in your issue of May 1), so far as the equatorial *condé* is concerned, there is no occasion to discuss this point. I take the 12-inch size, as it is the nearest to the only one completed, and most likely to be accurate. A 12-inch equatorial *condé* is estimated at 44,000 francs, *i.e.* say 1760*l.*

Now, in estimating the relative costs of the two forms, your readers will agree with me that for our purposes the fair comparison is between the equatorial *condé* and such equatorials as are most generally in use in this country, and it is well known that for 1760*l.* a first-rate 12-inch equatorial and dome can be procured, and *this is as nearly as possible what I said*, and I have to thank M. Lœwy for furnishing me with materials to prove my case with so little trouble.

My paper at the Royal Dublin Society (so far as concerned the equatorial *condé*) was mainly confined to showing that in consequence of its complication it presented many difficulties in its manufacture, particularly for large sizes, and I considered (as I do still consider) that too much was sacrificed in endeavouring to make it an instrument of precision, and to obtain universality. The very fact of its being difficult to construct renders any success the more creditable, and I gladly take this opportunity of expressing my admiration for the excellence of the optical work of the Messrs. Henri, which appears to have withstood the enormous strain put upon it by the peculiarity of construction of the instrument. I still consider, and in this opinion I am joined by the several astronomers of eminence to whom I have spoken on the subject, that the good results are due to the excellence of the optical work, and have been obtained in spite of, and not by reason of, the peculiar form of the instrument.

And now I would say a few words generally on the comparison which has been instituted between the two forms. The claims of the instrument which I propose are very modest. I simply claim for it that by its peculiar construction I can obtain an instrument of large aperture at about one-fourth the usual cost, and that the observer can be situated in a most comfortable position, and free from all the various inconveniences of ordinary observing. I do not claim that the instrument will be one of precision, or that the images will be better after reflection from the mirrors, or that it will be universal, or that it will do all and everything which the equatorial *condé* will do at four times the cost. What the equatorial *condé* claims your readers already know. Like many other matters, this also will probably resolve itself into one of cost. If a director of an observatory has 1760*l.* at his disposal, it is for him to decide whether he will have a 12-inch equatorial *condé*, which commands the whole visible heavens, or a 24-inch telescope on my plan, sacrificing in this case about 20° near the Pole; or, putting it another way, he may consider the question whether he will spend 1760*l.* on a 12-inch equatorial *condé* or 500*l.* on one of my form of same aperture.

On this matter I shall have more to say in my second letter, in which also I propose to answer all the various objections M. Lœwy has raised to my form. It may, however, be interesting for him to learn that, with a single unimportant exception, he has not raised an objection which has not already been discussed and provided for in the new instrument; but he has suggested to me another objection to the equatorial *condé* which I shall also treat of in that letter.

HOWARD GRUBB

Rathmines, Dublin, May 19

### The Earthquake

My yacht, the *Glimps*, lay on the ground in the River Colne at East Donyland, about half a mile above Wivenhoe, and as soon as I was able I joined her in order to study the effects of the late earthquake. I remained in the district about a fortnight, and examined the greater part of the focus of disturbance, over an area of about eight miles long by six broad. I distinguished on the ordnance map by appropriate marks (1) those places where the shock had been so violent that not only nearly all the chimneys had been knocked down but a large proportion of the house walls cracked and some boundary walls thrown down; (2) those where it had been less violent, many of the chimneys having been thrown down, but few or no houses cracked; and (3) those where it had been only sufficiently violent to throw down a few isolated chimneys. This third district extends in some directions much beyond the part examined. District No. 2 may be said to trend from Wivenhoe south-west to somewhat south of Little Wigborough, but sends a small, narrow branch north-west up the Colne valley to Colchester. The main part of District No. 1 is at Peldon, Langenhoe, and Strood Mill, but there are two well-marked outliers, one at Wivenhoe and another at Mortimer in Mersea Island. At and near Wivenhoe the intensity of the shock seems to have been greatest at low levels, and such a supposition would explain the character of that outlier, but no such explanation is applicable to the outlier at Mortimer, since the chief damage there is at a high level, and I was unable to discover any reason for its local character.

A great part of my attention was directed to such facts as indicated the direction in which the disturbance moved. The mate of the *Glimps* was on deck, and says that the yacht was first, as it were, moved violently forwards to the west, and then even more violently backwards to the east. All the circumstances of the case make this a very good observation. In trying to determine the direction of the shock from the effects, I have taken great care to select such cases as would mark the first shock, and not the recoil. Unless this be done, no true result could be obtained, since very commonly the chimneys at one end of a house have been thrown down by the direct shock and those at the other end in the opposite direction by the recoil. On the whole I was able to observe nineteen cases which I looked upon as satisfactory. Almost all these vary from east to south. Perhaps the shock was rather more from the east at Wivenhoe than at Peldon. The mean of the whole is very nearly true south-east, which may be said to agree with the axis of chief disturbance as laid down by me on the map. The only case which is doubtful is that of the church at East Mersea. The manner in which two portions of the tower have been thrown down seem to indicate a shock from north-west. If this could be relied on with perfect confidence, it would show that the church lay on the south-east side of the vertical line, but I saw nothing else to confirm such a conclusion, and I think it quite as probable that the damage was done by the recoil which over the greater part of the district was from that same north-west direction. If this supposition is correct, the shock came up from below somewhat obliquely from south-east under East Mersea, where scarcely any damage has been done, and was most violent along the stroke of the wave at a distance of about three miles to the north-west. This and the general character of the area of chief disturbance seems to me to point to some very irregular distribution of hard rocks at a considerable distance below the surface.

H. C. SORBY  
Yacht *Glimps*, Queenborough, May 25

IN your issue of the 8th inst. (p. 31) Dr. J. E. Taylor draws attention to the fact that sound preceded the Langenhoe earthquake for an appreciable period of time. A similar phenomenon has often been recorded, but as I cannot just now quote another instance, allow me to put forward a personal one.

On the morning of Monday, July 11, 1853, I had just gone to bed when I heard a heavy fast-approaching rumbling sound coming from the direction N.W.  $\frac{1}{2}$  N. I was in St. Jean de Luz, and had stopped at an inn which skirts the high road from Bayonne to Madrid. The noise was coming nearer with the speed of an express train, and knowing that the only heavy coach which plied in those days could not pass at such an hour, I concluded that an earthquake was coming and got up to look at my watch, which I had left on a table at the opposite corner of the room; it was 20m. 8s. past midnight. When the noise seemed to issue from the ground under me, the whole house shook; it was then 24m. 8s. past midnight. Although occurring at a time

when most of the inhabitants were asleep, this earthquake was recorded in all neighbouring villages and at Vera, on the south of the Pyrenees chain. This contradicts the observations made in Japan, where mountains seem to stop earthquakes. Taken unawares at St. Jean de Luz, I did not note down how long the sound lasted before and after the shock. This should be attended to, if possible, in all similar phenomena, for we have as yet no permanent self-recorder of sound.

Although notable earthquakes are of rare occurrence in Europe, slight ones frequently happen. I have observed two microscopical ones near Hendaye. Our imperfect knowledge of their times and causes would be improved if our meteorological observatories had proper seismometers telling their own tales. Perhaps they should be of three kinds: for serious earthquakes, for slight shocks, and for earth-tremors.

Paris, May 26

ANTOINE D'ABBADIE,  
de l'Institut

THE earthquake was felt by an invalid in bed at Dudbridge, a mile south-west of Stroud, Gloucestershire. The house stands on the Middle Lias. It was also felt at Stonehouse, three miles west of Stroud on the Lower Lias. The New Red dips under the Lias, about seven miles west of Stonehouse, at the well-known section at Westbury-on-Severn. It is presumed that the Carboniferous Limestone exists under the New Red. It is visible three miles to the west of Westbury.

May 23

A. SHAW PAGE

#### Instinct in Birds

I READ with special interest the letter signed "Wm. Brown" in NATURE of the 15th (p. 56). I regret I cannot see the letter to which it refers. My excuse for intruding on your limited space is that I have something to say about a magpie's nest. My text is words in Mr. Brown's letter, "I have often seen the nest shot down." Some years ago seeing a magpie fly from her nest I climbed the tree to see what was in it. I found six eggs, but *not magpies'*. They were *starlings'* eggs on which the magpie was sitting. I visited the tree several times, and always found the magpie sitting on the starlings' eggs. To my great regret, on finally coming to see how the magpie and her foster brood were getting on, I found a shot-hole through the nest, and magpie and eggs knocked to pieces.

Edinburgh, May 21

R. S. S.

P.S.—My regret was the greater as I could easily have prevented this by asking a neighbour's keeper to let the nest alone. The magpie lays as a rule seven eggs. There were six starlings' eggs in the nest. I saw no starling near the place, and as it was in the middle of a dense fir wood, I was the more astonished to see starlings' eggs there.

#### A Remarkably Brilliant Meteor

TO-NIGHT, about 10.45 p.m., I was "stepping westward," about half a mile east of my house. Suddenly the ground before me was lighted up with noontide splendour by a luminary that was above me and behind me. Looking back I saw a meteor a good deal east of the Great Bear, and nearly as high in the sky. It was about as big as Venus, and of the same hue. It was speeding from north to south with a slight descent. Its course very soon came to an end. It left behind it a streak of duller lustre: this phosphorus-like trail vanished almost at once. The career of this meteor while that body was visible here, lasted little, if at all, longer than a minute, but its light was remarkably brilliant.

JOHN HOSKYNs-ABRAHAM

Combe Vicarage, Woodstock, May 20

#### Right-sidedness

AN unprofessional account of a case of paralysis lately in the West London Hospital may be of interest as corroborating the assertion of Mr. Wharton (in his letter of March 20) that in paralysis of the left side it is the right eye which suffers, and *vice versa*.

(whom motion, ..... eye, however, was normal and bright; while on the right side of the face, which did all the talking and laughing, the eye was half closed, and one could see under the drooping eyelid that the pupil was dilated till but a narrow margin of iris was visible.

E. H.

#### MODERN TRAVEL—A SCIENTIFIC EDUCATION

THE teaching of geography has come to rather a sad pass in this country, as was evident from the address of the President at the Anniversary of the Royal Geographical Society on Monday. The Society's examiner, Prof. Moseley, reports that it is entirely neglected in our public schools; and the Council of the Society have withdrawn the public schools medals which they have awarded for years, simply because there are so few candidates for them. In our great public schools geographical teaching has no recognised place; if taught at all it is only as a voluntary subject, which may or may not be taken at the caprice of the boys. Some attempt has been made to methodise the teaching of the subject in schools under Government inspection, but so far the result has not been very successful. No doubt the Science and Art Department and the University examiners have done much to improve the teaching of what is known as physical geography in our middle-class schools; but at the very best we are a long way from perfection in this important branch of education, which, were it not for unintelligent teachers and dry text-books, ought to abound with interest. One serious defect in our system of teaching the subject is the want of proper apparatus; maps are good enough in their way, but it is not easy to persuade the pupil that they represent anything more than a flat surface. They are a poor substitute for the models which we find in some Continental schools, supplemented as these are by large-scale, well-executed pictures of the leading natural and artificial features with which geography deals. If Miss North's gallery of pictures at Kew could be taken round the country at intervals for exhibition to our schools, it would do more for giving a real conception of what geography is than many text-books. Let us hope that the step taken by the Royal Geographical Society, in appointing an inspector to visit Continental schools and report on the whole subject, will lead to real reform.

Of course the most effective and impressive method of education in geography would be to take the pupil all over the world, and let him see with his own eyes the many wonderful and beautiful features of our earth, which as lists of dry names weary his soul in his text-book. This is a method recently followed to some extent in certain of the French high schools. The best pupils are taken during the vacation to some important foreign centre, like London or Berlin, Christiania or Stockholm, from which excursions are made to the leading natural and artificial features of the country. Every tourist is indeed more or less of a practical geographer, finding fresh energy, education, and interest in those very things which when at school he abhorred. But we fear that many tourists pass through a country, if not with their eyes closed, at least without any training whatever as to what they are to look for; and unless the best-intentioned tourists have been so far instructed, their travels will do them little good. Hence the great educational value of a carefully-compiled guide-book; and how important such a guide-book might be made as a means of geographical and scientific instruction may be seen from the handsome "Orient Line Guide" before us.<sup>1</sup> It is in most respects very different from any of the volumes with which Murray and Baedeker have made us familiar. It is meant neither for knapsack nor pocket, but evidently for the saloon table. It is a broad folio, handsomely printed and abounding in fine large-scale illustrations and maps by Maclure and Macdonald. Every one who has gone a long voyage must have felt its tedium in spite of amusements of all kinds; but with the aid of the "Orient Guide" every day ought to bring fresh interest and fresh means of instruc-

<sup>1</sup> Illustrated Guide of the Orient Line of Steamships between England and Australia. Issued by the Managers of the Line. (London: Maclure and Macdonald.)

tion. The illustrations themselves are of much interest; plans and portraits of several of the magnificent ships of the Line, views of many places and scenes from Gravesend to New Zealand, star-charts which may furnish a nightly education in astronomy as well as navigation, and maps of all the countries along the route.

When we say the work is edited by the Rev. W. J. Loftie, it will be evident that it is of an unusually high stamp. The special feature of the text is that besides the information about the Line and its ships, instructions to passengers and such like useful hints, we have special articles on seamanship, navigation, natural history at sea, and weather at sea. All the leading features along both the Suez route and the Cape route are pointed out and information given about them as the voyage proceeds, while special chapters are devoted to all the Australian colonies, to Egypt, the Holy Land, Italy, European cities, and the mother country. Thus it will be seen that the "Orient Guide" is adapted for the use of voyagers from both ends of the route.

As a means of conveying some practical knowledge of science, and arousing an interest in the subject, the chapters on seamanship, navigation, meteorology, and natural history must be particularly useful. Under "Seamanship" we are informed about all the most important points in the structure and working of a vessel. Such common terms as "running," "reaching," "beating," are explained, as are also the causes of the various motions of a ship—rolling, pitching, scudding, and so on; the various rigs of ships, the different species of ropes and knots, the various phrases shouted in working the helm, and other terms in nautical phraseology. The chapter on navigation ought to be particularly welcome to landsmen; by means of it the mere progress of the vessel itself, the daily operations of the officers in connection therewith, the conduct of the compass, the reading of charts, the use of the sextant, the various methods of ascertaining longitude, the use of the log, and so on—all can be made to furnish the passenger with constant sources of interest, and give him some idea of the many and complicated scientific principles which underlie so apparently simple a matter as the navigation of a steam vessel. The chapter also contains much information about the stars and their utility to navigation. The star-charts which accompany the chapter are not overloaded with names, and will be found of real utility in detecting the leading stars and watching their nightly changes as the vessel proceeds on her course.

The chapter on natural history contains succinct information on the leading forms of animal life likely to be met with during the voyage—land, coast, and ocean birds, fish of various kinds, cetaceans, the nautilus, zoophytes; while the marvellous phenomenon of the luminosity of the sea is explained. By a study of the chapter on the weather at sea, passengers may be able to throw more intelligence and variety into that monotonous and never-ending topic of conversation.

The more purely geographical part of the work is done in considerable detail. All the features met with on both routes are described in the order of their occurrence. Then for the benefit of those going out there are several chapters on the various Australian colonies, on their various aspects, scientific, geographical, and economical. On the other hand, for the benefit of Australians there is a general chapter on European travel, and special chapters on Egypt, Sinai, and the Holy Land, Italy, European cities, and the mother country—all richly illustrated.

Thus it will be seen that the "Orient Guide" is something very different from the ordinary run of guide-books, and that with it as a constant companion on board ship, a voyage to or from Australia may be made a real education. We should like to see other companies follow the example so well set by that of the Orient Line; travel-

ling by sea has now become so common that thus the serious defects of English education in geography might be largely remedied. But even the railway companies might follow the example. Several years ago we noticed a geological guide to some of the United States railways, in which the various formations along the routes were described in the order of their occurrence as the train proceeded. Something of a similar kind might very well be done for English railways, extending the programme, however, to other features besides those relating to geology. Meantime the Orient Line is to be congratulated on its enterprise, and on the intelligence which has guided the compilation of their handsome work. Mr. Loftie has not only edited the work, but written the chapter on Egypt, while other special subjects have been treated by Dr. Charles Creighton, Mr. G. Baden Powell, Commander Hull, and Mr. H. E. Watts.

#### THE LATE MONSIEUR WURTZ

WE have received the following communication from a Paris correspondent:—

The *eloges* pronounced over M. Wurtz's grave and your estimate of his place in science, doubtless being prepared, will tell your readers the extent of his life-work as a chemist. Indeed the best monument that could be raised to his memory would be a list of the work that has come from the laboratory at the *École de Médecine* during his thirty-four years' direction. But your readers may perhaps also be interested to know something of M. Wurtz as he appeared to those who were his pupils at the time of his death.

The impression one had at the beginning of M. Wurtz's first lecture was one of utter surprise. Organic chemistry was no longer a dry science full of dry formulæ, tiresome, complicated and difficult to remember; for the whole series of chemical transformations appeared as some philosophical romance in which the atoms and groups of atoms had their own particular characters, and could in given circumstances be depended on to act in a particular way. Yet, notwithstanding the picturesqueness of expression, there was no sacrifice of scientific accuracy. His teaching was so skilfully designed that each of his phrases could be interpreted immediately by the theories of thermochemistry and dissociation, which the more advanced student would learn later to apply to the study of organic chemistry, and by whose help the science is being gradually brought more and more to a purely physical stage. In the same way the psychology of the individual characters in life may some day be capable of being interpreted by purely physiological results. But notwithstanding the assertions of some eminent chemists, and notably of Wurtz's great rival Berthelot, no more in chemistry than in psychology is the problem thus reduced to one of rational mechanics. It seems, on the contrary, that for the accomplishment of this end account must inevitably be taken of those atoms for which Wurtz fought so hard, and of which Berthelot and the *École Normale* still deny the probable existence.

Taken aback at first by the new way of presenting well-known facts, one was soon carried along by the stream of Wurtz's eloquence and by his enthusiasm; and as one came out of the theatre, though Wurtz never left his subject to go into transcendental digressions, one had a feeling of being raised from the common things of life—a feeling of being better in every way for the new revelation of scientific truth.

Wurtz's eloquence was exceeded only by his modesty. He spoke of and praised Hofmann's general method for the preparation of the compound ammonias without mentioning the fact that it was he who discovered and recognised the first compound of this type. He eulogised Berthelot's great discovery that glycerine is a triatomic



alcohol, then spoke of the diatomic alcohols or glycols; but no one in the audience could have guessed that it was he who first gave an accurate interpretation to Berthelot's results, and that he followed up and confirmed his generalisation by the brilliant discovery of the glycols.

I cite but two cases out of many, for during the whole of his course Wurtz never alluded to one of his discoveries as being his own; and certainly from his own lectures his large audiences at the Sorbonne could have had no idea of the leading part he played in the grand development of modern organic chemistry.

Having already exercised his immense influence at the *École de Médecine*, he felt himself at too great a distance from his auditors at the Sorbonne, and while he was having a laboratory (still unfinished) built for him, he inaugurated last year a series of weekly *conférences*<sup>1</sup> under his own direction, which might well find their analogues in the English Universities. Each week M. Wurtz gave out two subjects (such as molecular weights, the paraffins, the ethers, &c.), and two students volunteered to give lectures (lasting from half an hour to three-quarters of an hour) on them the week following. The *conférences* were delivered in one of the large lecture-rooms to audiences of from sixty to eighty students; Wurtz himself sat at the end of the lecture-table and gave a kindly and helpful criticism after the *conférence* was over. The last of these *conférences* was given just three weeks ago by the writer of these lines, and M. Wurtz's kind words will always be a precious memory to him:—they were the last he was destined to utter in public.

Wurtz was a fine man, of commanding presence. To alleviate the organic disease from which he suffered, and from which he died, he began by his doctor's orders to work at gymnastics about ten years ago, and he was, notwithstanding his sixty-six years, an accomplished gymnast at the time of his death. The untiring activity of his mind appeared in a certain vivacity and restlessness of manner peculiar to himself; but one felt, as soon as one saw and spoke to him, that he was a straightforward, loyal-hearted gentleman.

M. Wurtz was followed to the grave not only by the official deputations from the *Sénat*, the *Institut*, and the various learned institutions with which he was connected, but also by hundreds of students, principally from the *École de Médecine* and the *Faculté des Sciences*, bearing, according to French custom, wreaths of flowers, and thus paid their last tribute to the memory of their loved master. One could not help noticing especially an immense wreath of white flowers, offered by the women-students of the *Faculté de Médecine*, as a testimony of their gratitude to the man who some fifteen years ago obtained permission for them to study in the Faculty, and whom they followed to his last resting place right across Paris from the Boulevard St. Germain to the cemetery of Père la Chaise.

The sympathy which M. Wurtz inspired in all with whom he came in contact, coupled with his great genius, gave him a personal influence beyond that of most men—for if he is dead to us in the body he is still living in the mind, aye, and in the hearts, of the thousands of students who have listened to him in rapt attention on the benches of the *École de Médecine* and of the Sorbonne. As he said of Dumas: *Forma mentis eterna*.

Paris, May 16

#### ROBERT ANGUS SMITH

ANOTHER of the men of the middle time has passed away. Early on Monday morning, the 12th inst., whilst Adolphe Wurtz lay dying at Paris, Angus Smith breathed his last at Glynwood, Colwyn Bay. Both men were of the same age, and both were pupils of the illustrious Liebig—students in the great chemical school of Giessen. Each, in a sense, was imbued with some one

phase of the spirit of their many-sided master, but in a different manner: Wurtz spent his energies and won his greatest triumphs in the development of chemical theory, and in the elucidation of the structure of organic compounds; Smith had probably little knowledge of, and but little sympathy with, the theories of modern organic chemistry; and although possessed of his countrymen's love of metaphysics, and, as his writings show, capable of much abstract speculation, his conceptions of chemical constitution were probably, in the main, as mechanical as those of Dalton, whose disciple and chief interpreter he considered himself to be. His chief point of contact with Liebig lay in his recognition of the utilitarian side of his science: for upwards of forty years he laboured unceasingly to show how chemistry might minister to the material comfort and physical well-being of men—not in the manufacture of new compounds useful in the arts, or in the establishment of new industries,—but in raising the general standard of the health of communities by checking or counteracting the evils which have followed in the train of that enormous development of the manufacturing arts which is the boast of this century. Sweetness and light were fixed articles in Smith's creed. His love of fresh air, of pure water, of a green hillside was intense. "Where to, sir?" asked a cabdriver whom Smith had hailed on his way home, tired and longing for escape from beneath the dull, murky Manchester sky. "To the sun!" was the answer. And we are told that it was to the credit of that cabman that he did not take the old philosopher to some hostelry with the sign of Phœbus, but trundled him among the green lanes beyond the city's outskirts until it was time to turn the horse's head homeward. To keep the air in our towns fresh and wholesome, to restore the water of our streams to its pristine clearness, to preserve the freshness and verdure of the fields and woods, to sweeten the atmosphere of the crowded dwellings in cities,—this was the kind of work to which Smith dedicated his life, and at which he laboured to the very last. There have been greater chemists, no doubt; his name is not associated with any fundamental discovery in chemistry, and his attempts at theorising were not always very happy; but in his true vocation, as the chemist of sanitary science, Smith worked alone, and we have yet to find the man on whom his mantle has fallen.

Robert Angus Smith was born in the neighbourhood of Glasgow on February 15, 1817. When nine years of age, he was sent to the High School, and at thirteen he entered the University of Glasgow. He quickly showed that liking for the classics, and especially for Greek, which clung to him through life, and his mother, as usual among Scottish matrons, cherished the aspiration that her son should "wag his paw in a poopit." Whether this ambition was ever shared by her son is doubtful; at all events, such a career became impossible for Smith after hearing the preaching of Campbell of Row: he declared that he could not take "holy orders in a kirk which had expelled a man for being apparently both wiser and better than itself." On leaving the University he acted as tutor in various families in the Highlands and in London. What directed him towards science does not appear. In company with his brother John, who is known as the inventor of a chromoscope, and as the author of some speculations on the cause of colour and the nature of light, he had read the standard works of his time on natural philosophy and chemistry. When twenty-two years of age he found himself at Giessen, and after working under Liebig for some time he obtained his doctorate. He returned to England in 1841, and procured employment under Dr., now Sir Lyon, Playfair, in connection with the Health of Towns Commission. It was this circumstance which doubtless served to fix the direction of his future work. His earliest publication—a contribution to the then recently founded Chemical Society of London—was a paper on the air and

<sup>1</sup> I need hardly say all University lectures are quite free in France.

water of towns, and successive memoirs, with almost identical titles, made their appearance either in the Society's *Transactions* or among the Reports of the British Association. The Royal Society's Catalogue shows that Smith was the author of about thirty papers on air and water. These he eventually collected and published, with considerable additions, in the form of a thick octavo volume, entitled "Air and Rain, the Beginnings of a Chemical Climatology," with a dedication to his friend and teacher Liebig. This book shows Smith at his best and at his worst. It is full of facts and quaint out-of-the-way references; on the other hand, it is diffuse, and, as a piece of literary work, badly put together—faults difficult to avoid in a compilation based upon, or largely composed of, papers already published. That Smith had considerable literary skill, and a sound critical faculty, may be seen in the short memoir on Graham prefixed to the collection of that philosopher's papers brought together and published, with a reverential care, by the late Dr. James Young of Kelly. Smith had years before saturated his mind with the notions of the Hellenic atomists, even before the time he wrote his monograph on Dalton, and in this short prefatory memoir of some twenty pages he crystallises out his thoughts on the development of the atomic systems of Kapila, Leucippus, Lucretius, Newton, and Dalton, and shows with admirable lucidity Graham's true relation to these great thinkers. Smith, however, would never have made a good teacher, despite his wish, in early life, to connect himself with some place of higher chemical instruction. When at his best he was not an ineffective speaker; but he was wanting in power of exposition, and his metaphysical tendencies and his quaint playful fancy were only too apt to disturb the even tenor of a sustained description, or closely reasoned argument. No man, however, was more popular among young men, for he had a genuine sympathy with youthful aspirations, and a kindly way of drawing out and encouraging what was good in them, and there are dozens of men still living who have to thank the gentle, quiet-spoken philosopher and friend for their first step in life. He had, too, his countrymen's tenacity of friendship: it took a very violent wrench indeed to disturb a confidence once placed.

From 1842 Smith was closely connected with Manchester. In that year he settled himself in the town as a consulting chemist. Shortly afterwards he became a member of the Literary and Philosophical Society of Manchester—a society made famous by its connection with Dalton and the Henrys—and much of his work appears in the *Memoirs* and *Proceedings* of that body. In 1855-56 he became one of its honorary secretaries, in 1859 a vice-president, and in 1864-65 president. In his "Centenary of Science in Manchester," published a short time ago, he has sketched, in characteristic manner, the growth of that institution, and has sought to trace its influence on the development of scientific life in Lancashire.

In 1863 Smith was appointed Inspector-General of Alkali Works for the Government, and the somewhat delicate task of initiating the working of Lord Derby's Act fell to him. He performed this duty with characteristic tact and with every desire to avoid undue interference with the legitimate business of the alkali maker. The successful working of that Act is largely due to the manner in which Smith and his subordinates set it in operation. On the passing of the Rivers' Pollution Act he was made Inspector for England, and afterwards for Scotland. He held both these appointments up to the time of his death.

Angus Smith had a passionate delight in the Highlands, and the smell of a peat fire was to him as incense. He had something, too, of the Highlander's love of mysticism in his composition, and throughout his life he found pleasure in Celtic literature; and it was with a mind well

stored with legends that he produced "Loch Etive and the Sons of Uisnach," published anonymously in 1879.

Smith lived the "quiet life" of Pope's philosopher. His temper was singularly even and placid: he had his checks and crosses, of course, like other men, and he was occasionally pained to find himself misunderstood. But nothing ruffled his calm. His perfect transparency, his charming simplicity, and a certain quiet playfulness of manner gained for him the sobriquet of "Agnus" Smith. Indeed, his sense of fun could see the latent humour in any situation. Even on his death-bed it was with him. Somebody had said that they were not going to part with him yet. "You will be clever people," he rejoined, with the old twinkle in his eye, "if you keep me here three days longer."

Smith became a member of the Chemical Society in 1845, and a Fellow of the Royal Society in 1857, and in 1882 the University of Edinburgh conferred the honorary degree of LL.D. upon him.

T. E. THORPE

#### NORWEGIAN GEODETICAL OPERATIONS<sup>1</sup>

THE first part of this publication, published in 1882, was reviewed in NATURE, February 8, 1883. The second part, now before us, consists principally of a series of tables giving the results of the observations at the following tidal stations:—Stavanger from 1881 to 1882, Thronhjelm from 1880 to 1881, Kabelvaag from 1881 to 1882, and Vardoe from 1880 to 1882. These tables are arranged precisely as in the first part; it is therefore unnecessary to refer to them more particularly.

A description, accompanied by a drawing, is given of the self-registering apparatus used. The float, placed in a tube, is connected by means of a fine wire to a wheel 50 cm. diameter, and the wire is kept taut by a counter-weight acting on a second concentric wheel. On the axis of these wheels, and rigidly connected to it, is a pinion 2.5 cm. effective diameter, working on a horizontal rack, to which the scribing pencil is attached. Thus the rise and fall of the tide is measured to a scale of  $\frac{2.5}{50}$  or  $\frac{1}{20}$ .

A cylinder, on which is fixed the diagram paper ruled with hour lines, is placed horizontally below the rack, and is driven by a clock connected to it directly by means of gearing, and assisted by a weight attached to a string passing over a pulley. This apparatus is the invention of Lieut.-Col. Haffner, and is made by a watchmaker (G. P. Stenberg) at Bergen.

It is mentioned that, owing to a defect in the self-registering apparatus used at Oscarsborg and at Drontheim, and described in the first part, the observations are not as satisfactory as might be wished. In the instruments used at these stations the motion of the driving clock was communicated to the diagrams by means of a string, and it has been found that the variations in the amount of humidity and of temperature sufficiently affected the length of the string to cause appreciable errors. It should be understood that the readings were taken by means of hour lines ruled on the diagram paper; any alteration in the length of the string clearly affects the accuracy of the position of these hour lines. This source of error has been removed, and new observations taken, which will be published in a succeeding part.

#### SATURN

MESSRS. PAUL AND PROSPER HENRY contribute to *La Nature* some interesting information on the recent aspect of the planet Saturn. During the month of February and the beginning of March last

<sup>1</sup> Publication of the Norwegian Committee of the Association for the Measurement of Degrees in Europe, Part II. (Christiania, 1883.)

several nights were of exceptional purity so far as regards the definition of stars observed in the telescope. Messrs. Henry say:—

“We took advantage of the most favourable moments to observe with our refractor of 0.38 m. the aspect of the principal planets; Saturn and his rings attracted our especial attention. The representations of this planet were often of remarkable precision, even when magnified more than a thousand times. It was possible to notice on several occasions curious inequalities in the equatorial band. Outside the known rings we established, around the principal separation (Cassini's division), the existence

of a new ring, brilliant and perfectly defined, having a breadth of about  $1\frac{1}{2}''$ . It is surprising that this ring, which is quite visible, has not hitherto been perceived. But the fact which more particularly struck us in observing Saturn, and which has induced us to publish the accompanying sketch, is that, notwithstanding extremely favourable conditions of visibility, it was impossible to discover the least trace of the external *anse* (Encke's division). That division, indicated since Encke by all the observers who have published drawings of Saturn, and which we believe we had also seen with instruments of moderate power, may well be only the result of an



Aspect of Saturn, March 4, 1884.

optical illusion. This phenomenon would be produced, in our opinion, by the brilliant ring which we have discovered, and which irradiation causes to appear larger than it really is, while by an effect of contrast we believed we saw, like a black line of separation, what in reality is only a marked difference in the brightness of the rings. By examining at a distance of about three metres the sketch here given, this division may be very clearly noticed as it is usually represented. The experiment will succeed even better if one takes the precaution of slightly closing the eyelids. In these conditions the aspect of the drawing is

pretty much that which Saturn presents when observed with instruments of ordinary dimensions, or even with powerful telescopes when the definition is imperfect. We may then explain by an optical illusion these differences of aspect observed in the external ring, without its being necessary to attribute them to any modification which has taken place in this curious appendage of Saturn. This interesting planet is now too near the sun for useful observations to be practicable. We shall continue our researches by means of powerful telescopes at the next opposition.”

#### EARTH CURRENTS<sup>1</sup>

ONE of the most interesting subjects dealt with at the recent Electrical Congress in Paris was earth currents. The absence of published information in France on the behaviour of these erratic disturbers of telegraphic peace has led to an elaborate and careful study of the whole question by M. Blavier, the well-known and distinguished director of the High School of Telegraphy of the Post and Telegraph Administration in France. This has been printed, published, and circulated by the Minister of Posts and Telegraphs (M. Cochery) for the use of the members of the recent Congress.

These earth currents are always present in telegraph lines, varying in geographical and electrical direction and

<sup>1</sup> "Étude des Courants Telluriques," par F. E. Blavier. (Paris: Gauthier-Villars, 1884.)

in strength, generally scarcely perceptible, but sometimes acquiring such intensity as to acquire the title of "storms." Their direction depends upon the direction of their earth terminals, and in no way on the route of the wires or on the fact of their being overground or underground. The longer the line the greater their strength. Their strength and direction vary with the hours of the day, and they show well-marked periods of maxima and minima. In fact there appears to be a tide in their affairs clearly following solar influence, and it has been believed by more than one observer that the influence of the moon is also perceptible. There is also an annual period of maximum and minimum, and this follows the well-marked eleven-year period of sunspots. We have just been passing through a period of maximum intensity. 1881 and 1882 were years of considerable activity. Their vagaries are exactly coincident

with the variations of the mariner's compass, and are evidently primarily due to the same cause. It is when the aurora is present that they acquire extraordinary energy, and change their direction and intensity with great rapidity. Their effects are then observable simultaneously over the whole globe. They interfere seriously with the transmission of telegraph messages.

They have been studied and examined with great care in England. The eminent engineer, Mr. W. H. Barlow, F.R.S., was the first in the field, and his paper before the Royal Society in 1846 has scarcely been improved upon or added to. The late C. V. Walker was an incessant observer, and sent several papers to the Royal Society. Varley added considerably to our knowledge, and there are several papers by Mr. Preece, F.R.S., on their behaviour. The latter remarked that in the great storm of January 31, 1881, the currents acquired an electromotive force of 3 volt per kilometre of earth surface and an intensity of 30 milliamperes—currents far stronger than those used for telegraphy. The *Proceedings of the Society of Telegraph Engineers* contain several interesting communications from Adams, Dresing, O. Walker, W. Ellis, Saunders, and others. It was warmly discussed at the Congress of 1881, which decided (1) that certain short lines in each country, independent of its general telegraph system, should be exclusively devoted to their study; (2) that long lines, particularly those underground, should be utilised as frequently as possible for the same purpose,—lines N. and S. and E. and W. being taken by preference, and one day per week—Sunday—being simultaneously employed for the purpose.

It was also suggested that during the year 1883 the 1st and 15th of each month should be taken for separate and careful observation. These resolutions have been faithfully carried out in Paris, and M. Blavier's work is the consequence. They have also been followed with great advantage in Germany and in Russia.

Permanent wires at right angles to each other have for many years been fixed and used in Greenwich, but the observations have not been systematically published, though the records are photographically printed.

M. Blavier has, since September 1883, organised a very careful system of automatic observation, by employing a clockwork apparatus similar to that designed by M. Mascart to register simultaneously the three components of terrestrial magnetism. He uses the dead-beat galvanometer of Deprez and d'Arsonval, shunted so as to meet the cases of all currents. As the chief point to be determined is the difference of potentials at the ends of a circuit, M. Blavier made the resistance of each long circuit examined equal to 10,000 $\Omega$ , and each short circuit 1000 $\Omega$ . The ordinates of the curve traced give indirectly the electromotive forces present. His excellent memoir contains a series of these curves, and very instructive they are. A complete lunar month from February 28 to March 28 is given. Observations were taken on aerial and underground wires. The general direction of maximum electromotive force in France is N.W.—S.E., making an angle of 56 $^{\circ}$  with the magnetic meridian. M. Blavier concludes from the deflections of the needles that the disturbances of the magnetic elements are due to accidental electric currents circulating in the higher regions of the atmosphere although the earth currents circulate in the crust of the globe. He favours De la Rive's theory of the aurora borealis as being due to the circulation of electric currents in the higher regions of the atmosphere, in support of which he mentions several atmospheric effects well recorded as simultaneous with earth currents, such as intense scintillation of the stars observed by Montigny, and tempests. He associates earth currents with trade winds, and thereby indirectly with the sun.

Altogether M. Blavier's *brochure* is very ably written and a credit to the department of which he is such an old and distinguished member.

## NOTES

THE French Minister of Education and the Fine Arts has proposed to place at the disposal of M. Pasteur, for the prosecution of his scientific experiments, a large domain situated at Villeneuve-Etang, which belongs to the State.

COLONEL DONNELLY has been appointed Secretary and permanent head of the Science and Art Department of the Privy Council.

THE Paris Academy of Sciences has nominated M. Cailletet, the inventor of the apparatus for the liquefaction of gas, a *Membre libre* in place of the late M. du Moncel. The Academy has appointed a Commission of six members to prepare a list of candidates for the office of Perpetual Secretary.

THE death is announced of M. Bontemps, the author of several volumes on pneumatic telegraphy, and engineer to the French Government for the construction of the Paris system.

A COMMITTEE has been formed at Alais (Gard) for erecting a statue in that city to M. Dumas. A committee will also be established for the erection of a statue to M. Wurtz in Paris.

THE election of Dr. C. S. Roy to the new Professorship of Pathology at Cambridge augurs well for the scientific development of the rapidly-increasing medical school of that University. Dr. Roy's work, both as George Henry Lewes Scholar and as Professor-Superintendent of the Brown Institution, has, it is well known, been of the highest merit and promise.

THE *conversazione* of the Institution of Civil Engineers takes place to-night at the South Kensington Museum.

WE are pleased to learn from a correspondent that the Natural History Department of the University of Edinburgh has undergone remarkable development during the last six months. Two years ago it had no lecture-room, and only one small room serving both as museum and laboratory. Now the old chemistry class-room, in which graduations and other ceremonials used to be held, and which is still the largest class-room in the University, has been handed over to the Professor of Natural History. There has not been time to have the class-room reseated, but the comfort of lecturer and students has been cared for in a still more important way, viz. by the erection of a ventilating fan, which changes the air several times every hour. The great demand for practical teaching which marked Prof. Ewart's advent to Edinburgh could only then be met with by resorting to a remote corner of the College buildings. Now the practical work is carried on in a splendid, beautifully decorated, well-lighted hall—a dingy museum in Jameson's time, but now capable of accommodating about 130 men at a time. In addition to this laboratory there is an adjacent smaller work-room for advanced students. A series of tanks is in process of erection in the lower room, which corresponds in size to the large laboratory, and which it is intended to convert into a laboratory provided with all the necessary apparatus for studying the life-history and development of marine organisms. When the other rooms which formerly belonged to the Natural History Department are added, the arrangements for teaching zoology in Edinburgh will be alike complete and satisfactory.

WE understand that the University of St. Andrew is about to approach the Government with the view of obtaining funds for extending the Natural History Museum and at the same time for providing a marine laboratory within the walls of the University, while the more practical work of hatching, &c., which the Fishery Board for Scotland is carrying on will be provided for

by a laboratory on the cliff immediately behind the College. It is proposed to prosecute the more purely scientific work within the walls of the College itself. The College is so near the proposed hatchery that the same pumping apparatus will serve for both laboratories, and thus, when established, the working expenses will be comparatively trifling. If the University and the Fishery Board succeed in carrying out their plans, biology will receive a mighty impulse at St. Andrew's, and the famous bay once more be peopled with an abundant supply of fish.

THE Clothworkers' Company have voted 2000*l.* towards the fund of 20,000*l.* required for the complete equipment of the new Central Institution of the City and Guilds of London Institute, this being additional to their original building grant of 10,000*l.* and their annual subscription of 3000*l.*

WE learn that orders have been given by the Inspector-General of the Imperial Maritime Customs of China, that meteorological observations made in the Treaty Ports and in the lighthouses are in future to be sent to the Government Astronomer at the Hong Kong Observatory, but that it is not at present the intention of the Chinese Government to start a meteorological service in China. With regard to observatories great progress has been made of late years. Central Government observatories exist in Japan, Peking (Russian), Hong Kong (British), and Batavia (Dutch), while the different Australian colonies which are covered with a network of minor meteorological stations, possess numerous central observatories, and it is very likely that this row of observatories will be extended further south, as steps are being taken to found an observatory in New Zealand, while the Russian Government is likely to extend its stations to the north of Vladivostok. First-class observatories are also supported by the Jesuit Order in Corea, China, and Manila, as well as elsewhere. For the investigation of typhoons, the terrible scourges of the China Sea, Father Faura, at Manila, has done most important work, and the utility of his observatory cannot but be extended when the Chinese Customs start self-recording meteorological instruments at South Cape, Formosa. But while each observatory is individually engaged in studying the peculiar features of its local climate in all its vicissitudes, it is by a comparison of the results exhibited in the different annual volumes published by each of them that we gain an insight into the laws that govern the general motions of the atmosphere and which underlie the peculiar features of each local climate. Thus in the China Sea the typhoons originate from local causes (heat and moisture), but the form and direction of their tracks are determined by the general laws of atmospheric motion in these regions.

THE first Circular of Information issued this year by the United States Bureau of Education relates to the approaching International Prison Congress at Rome in October next. The Bureau considers that the work of education is by no means limited to good children; and certainly, if no other power takes the reformation of the vicious in hand, their reform does become by so much the most important part of the work overlooked by this office, as they that are sick more need the physician than they that are whole. Prison Congresses were held in Europe in 1845, 1846, and 1857, and after an interval were revived through a paper by Count Sollohub of Russia, published in the Report of the New York Prison Association in 1868. His suggestions were adopted by Dr. E. C. Wines, the Secretary of that Society, and a Prison Congress was brought together at Cincinnati in 1870. Dr. Wines was elected Commissioner to act at an International Congress, and he brought about such meetings, first in London, then in Stockholm, and now at Rome. The questions for consideration are:—(1) As to the advantages from a reformatory view of imprisonment, and whether more useful and less degrading labour, without forcible detention, or even simple admonitions, might not be less mischievous and more effectual; as to length of

sentence; as to finding the instigators to crime; and the treatment of juveniles. (2) Upon prison architecture, the keeping of new away from old offenders, Prison Commissions, prison hygiene, dietary and education, the rivalry between prison and free labour, and the remuneration of the former, and the use to be made of Sundays and holidays in the interest of education. (3) International arrangements, repression of vagrancy, and the desirability of societies for the help of discharged convicts.

ANOTHER of the Bureau's publications is a Report of the School of Classical Studies at Athens; and although this hardly falls under the head of Nature studies, yet a journal of science may note with satisfaction the spread of a scientific spirit which feels how far clearer is the knowledge of history after imbibing such object lessons as must be gained from an acquaintance with the climate and aspect of the country, and their natural influence upon the race inhabiting it, from the scene of the philippic, the fight, or the festival.

"To expedite school business and diminish future controversies" the United States Bureau of Education has published a digest of 700 law decisions, which have been made since Col. Eaton has been in office, upon all the details of education in that country. The number of States, each independent of all the rest, has added greatly to the labour of such a digest, and its recommendation that, while variety of systems should be encouraged in different States, uniformity of system should be enforced in each State seems to combine the greatest amount of practical advantage.

THE following alterations have been made in the arrangements for the Friday evening meetings at the Royal Institution:—Mr. Willoughby Smith will give the discourse on June 6, on Experiments in connection with Volta-Electric and Magneto-Electric Induction; and on June 13 (extra evening), Prof. Dewar will give a discourse on Researches on Liquefied Gases.

MESSRS. CHAS. GRIFFIN AND CO. announce the publication of a "Year-Book of the Scientific and Learned Societies of Great Britain and Ireland." It will give some account of the constitution and working of more than 600 societies, distributed under the following heads:—(1) Science generally; (2) Mathematics and Physics; (3) Chemistry and Photography; (4) Geology and Mineralogy; (5) Biology, including Microscopy and Anthropology; (6) Economic Science and Statistics; (7) Mechanical Science and Architecture; (8) Naval and Military Science; (9) Agriculture and Horticulture; (10) Law; (11) Medicine; (12) Literature; (13) Psychology; (14) Archæology. There will also be an appendix giving a list of the chief scientific societies throughout the world.

MESSRS. W. SWAN SONNENSCHN AND CO. request us to announce that the whole edition of Profs. Nägeli and Schwendener's work on the Microscope, which has been in the press for so long a time, and which would have been ready for publication in a few days, was destroyed in the recent disastrous fire in Paternoster Row. A new edition has been at once sent to press, and it is hoped that the work will be in the hands of the public very shortly, since the English editors of the book had already completed their revision of the proof-sheets.

PROF. A. E. VERRILL, *Science* states, has in the press a very important paper, entitled "Second Catalogue of Mollusca recently added to the Fauna of the New England Coast and adjacent parts of the Atlantic, consisting mainly of Deep-Sea Species, with Notes on others previously reported." These are chiefly derived from the dredgings of the Fish Commission, are well illustrated, and worked up in the full and careful manner characteristic of the author. It appears in the *Transactions of the Connecticut Academy of Sciences*, and is illustrated by Emerton.

THE additions to the Zoological Society's Gardens during the past week include a Bonnet Monkey (*Macacus sinicus* ♂) from India, presented by Mr. J. L. Ellis; a Black-backed Jackal (*Canis mesomelas*) from South Africa, presented by Mr. H. P. Plummer; a Spotted Eagle Owl (*Bubo maculosus*) from Africa, presented by Capt. Lerner; a Nicobar Pigeon (*Columba nicobarica*) from the Indian Archipelago, presented by Mr. Thomas H. Haynes; a Herring Gull (*Larus argentatus*), European, presented by Dr. E. H. Crec; a Bonnet Monkey (*Macacus sinicus* ♂) from India, deposited; a Rabbit-eared Perameles (*Perameles lagotis*) from West Australia, two Specious Pigeons (*Columba speciosa*) from South America, purchased; a Bennett's Wallaby (*Halmaturus bennetti* ♂) from Tasmania, received in exchange; a Wapiti Deer (*Cervus canadensis* ♂) born in the Gardens.

### GEOGRAPHICAL NOTES

IN *Petermann's Geographische Mittheilungen*, 1884, Heft iv., is an article on the island of São Thomé, accompanied by maps both of that island and of the neighbouring island of Rolas, by Prof. R. Greff in Marburg. The contribution is the result of several months' residence on those islands in the course of a scientific tour through the islands of the Gulf of Guinea in 1879 and 1880. The map of the two islands in question is the united product of Prof. Greff and of the proprietor of Rolas, Francisco José de Araujo: a map based partly on immediate exploration and observation, partly on careful information derived from natives. It both corrects and supplements in considerable measure the only two previous maps of St. Thomas known to the authors—that of 1829 by the English commander, T. Boteler, and that of 1844 by the Portuguese, Lopez de Lima. In the present map are entered for the first time the districts into which St. Thomas is divided, its "villas," its connecting highways, its more important plantations, and also the demarcation between the comparatively small cultivated part and the large wooded wilderness of the south and the interior. The map of Rolas is the first that has yet appeared of this island, which is intersected by the Equator. The history of St. Thomas is sketched from the year 1470, when it was discovered, without a single human inhabitant and almost wholly overgrown with forest, by the Portuguese sailors, João de Santarem and Pero de Escobar. Prof. Greff calculates the dimensions of the island, which stretches ovally from 0° 2' to 0° 30' N. lat. and from 6° 34' to 6° 54' E. long., at about 52 kilometres by 34 kilometres, or altogether about 920 square kilometres.

WRITING from Bakundu-ba-Nambeleh in October 1883, St. von Rogozinski gives an account of his travels between Cameroon and Calabar. On August 13 he left the coast in company with Clemens Tomczek, made his way up the Mungo for Bakundu, his other fellow-travellers being bound for the station of Mondoleh. On September 11 they determined on traversing the region of the Upper Mungo as far as its falls. Making their way through thick forest and over mountain chains, they came on Eliki, where were three rapids, and from which point the Mungo is no longer navigable. The land to the north-east gets even more elevated, and the path of the travellers became continually crossed by streams. At length, at 4° 46' 15" N. lat. and 9° 33' 30" E. long., they looked down from a hill on the sources of the Yabiang or Abo, a deep and "indescribably beautiful" valley clothed in the most exuberant tropical vegetation. The principal town here is Balombi-ba-Kange, built like all towns of that quarter in the form of a crescent or arch, with fetish houses in the middle. On September 14 they left Kange, and passed the slave town of Bakú. Further to the north they entered, the same day, the large town of Mokonje, the centre of the ivory trade for the lands of Biafra Bay. Next passing Bao, they reached Mambanda, close to the falls and the new lake, Balombi-ba-Mbu, they were in quest of, on the 16th. Quite exhausted, and finding their way further to the north rendered impossible by troops of elephants and the want of any guide that would venture, they were reluctantly obliged to fall back on the mission station of Bakundu, where Rogozinski was compelled to stay and nurse the wounds on his feet and ankles. On the 23rd Tomczek resumed alone the march northwards by a different route, and happily reached the lake M'bu at half a day's march from Bon. The beautiful lake is four miles long, of

round shape, inclosed by thickly-wooded hills, is deep, abounds in fishes, and receives on the west the river Soho, six or seven metres broad. Apparently it is of volcanic origin.

IN a series of papers upon Early Discoveries in Australasia which Mr. E. A. Petherick, F.R.G.S., is contributing to the *Melbourne Review*, some curious and interesting facts are now made known for the first time, namely, the discovery of the west coast of Australia by the survivors of Magellan's expedition in 1522, the passage of Torres Straits by another Spanish vessel in 1545, sixty years before Torres, whose discovery and that of a Dutch vessel, the *Duyphen*, in the same year (1606) are hitherto the earliest authenticated accounts of the sighting of any part of the Australian coast by European vessels. But the most noteworthy statement Mr. Petherick makes is that the name of New Guinea belongs to that part of Australia now known as Queensland, and that the great island of Papua has borne the name of New Guinea erroneously for more than three centuries. Mr. Petherick is also able, from evidence upon a French *mappemonde* dated 1566, now in the Bibliothèque Nationale, Paris, to refute all claims to the discovery of Australia made at various times during the present and the last century on behalf of French navigators. Notwithstanding the early Spanish discoveries of Australia now referred to, Mr. Petherick asserts that the Portuguese were in the eastern seas twenty years earlier, and probably discovered Australia in the first decade of the sixteenth century.

LAST autumn the expedition under Lieut. Holm for exploring the east coast of Greenland, and which is again to start northwards this spring, met a party of about sixty East-Greenlanders—men, women, and children—south of the island of Aluk, on the east coast. They were on the way to the west coast to sell bear-, fox-, and seal-skins. Every attempt was made by the Danish explorer to induce some of them to return and act as guides on his journey northwards, but the prospect of a visit to a Danish settlement proved too great. A considerable number of East-Greenlanders die on their way to the west coast. The East-Greenlanders are reported to differ much from the West-Greenlanders in stature and appearance, the men being often tall, with black beards and European cast of face. This seems to be particularly the case with those living far north. Both East- and West-Greenlanders have small hands and feet. During the year 1883 four boats with heathen East-Greenlanders arrived at Julian-shaab. Three of these came from the distant Angmasalik, and in them there were also, for the first time, natives from Kelalualik, which is five days' journey further north. The latter stated that in the winter they were in the habit, when journeying on sleighs, of meeting with people living much further north. Kelalualik being situated, it is believed, between lat. 67° and 68° N., it may be assumed that the whole line of coast from lat. 65° to 70° is to some degree populated.

FROM the annual report of the Russian Geographical Society for 1883 we learn that the meteorological observations of the Novaya Zemlya Station are expected to be published in full in the course of this year, while the observers of the Sagastyr Meteorological Station, on the Lena, have remained there for a year longer. The publications of the Society, besides the *Investia* have been the following:—Prjevalsky's third journey to Central Asia, Potanin's sketches of North-Western Mongolia, Karelin's travels on the Caspian, and Maynoff's anthropology of the Morovians. The next publications will contain: the report of Unkovsky's embassy to Kontaisha under Peter I., M. Sadovnikoff's folklore of Samara, the third volume of M. Potanin's work on Mongolia, a geological map of the shores of Lake Baikal, by M. Chersky, the remarkable collection of maps of the delta of the Amu-daria, by M. Kaulbars, and the concluding fascicle of the capital work of M. Semenov, the "Geographical and Statistical Dictionary of Russia." The great gold medal has been awarded to M. Severtsoff for his explorations in Turkestan, and Count Lütke's medal to Prof. Wild for his labours in Russian meteorology, and for his work, "On the Temperature of the Air in Russia." The smaller gold medals were awarded to M. Lessar for his journeys, MM. Agapitoff and Khangaloff for their work on Shamanism in Siberia, M. Adrianoff for his journey to the Altay and Kuznetsky Alatau, and M. Usoff, member of the West Siberian branch of the Society. Silver medals were awarded to Lieut. F. Schwatka and Mr. W. Hoffman, Secretary to the Anthropological Society of Washington; to MM. Andréeff, Grinevetsky, Konshin, Kosyakoff, Krivosheya, Kudryavtseff, Prince Urusbieff, Fuss, Wereschaghin, and Dobrotvorsky. The library has been increased by 4001 volumes.

## THE MOVEMENTS OF THE EARTH<sup>1</sup>

### IV.—The Earth's Revolution

IT will be clear from what has gone before that the daily movement of the stars is an apparent one due to the real movement of the earth in an exactly opposite direction, and that the stars in the heavens appear to rise in the east and set in the west, because the earth rotates from west to east. And now comes this question: The period of twenty-four hours which is so familiar, and which is divided roughly into day and night, has apparently two perfectly different sides to it; for a certain period the stars are not seen at all in consequence of a body, which we call the sun, flooding the earth's atmosphere with its own tremendous light. Why should this be? In giving an answer to this question it is enough to say that the sun is a star so close to us, and so entirely outshining the other and more distant stars which are seen in the skies, that they seem to be things of a different order altogether. But they are not things of a different order, they are very much like our sun, and the different appearance is simply the result of the fact that the one is a star very near to us, whilst the others are suns inconceivably remote. In considering this apparent daily movement of the stars, and taking the sun into consideration, the fact is soon arrived at that the stars have another apparent movement differing somewhat from that one with which up to the present time we have alone been engaged. It has been said, and it is so obvious that it might almost have been left unaided, that as a rule the stars are not seen when the sun is visible, so that the question whether the sun moves or appears to move among the stars must be attacked in a rather indirect manner. An observer on that part of the earth's surface directly under the sun sees it as at midday. Under these conditions the stars are of course not seen by him, but if he waited twelve sidereal hours, until that portion of the earth which he inhabited was opposite the sun's place, the stars would then be visible, and by noticing whether those seen by him each night were the same, he would be able to determine whether or not the sun moved or appeared to move among them. In one position of the sun it occupies that constellation of stars known as the Bull. These stars cannot then be seen, because the intense brilliancy of the sun puts them out, but with the sun in this position the group of stars known as the Scorpion is seen opposite at midnight. Then at a later period the sun gets into the constellation called the Crab, and we see at midnight no longer the Scorpion group but the group which is called the Goat. In this way it can be determined that the sun has an apparent movement among the stars, which is completed in a period which we call a year, at the end of which time the sun occupies the same position that it did a year previously, and the same group of stars is seen again in the south at midnight.

Not only, then, do the stars appear to make a complete revolution once a day, in consequence, as we have seen, of the earth's rotation, but once a year they also gradually change their apparent places, so that at the same hour each night different stars appear due south, thus indicating a movement of the sun among them.

The same difficulty that was met with before is again encountered here; is this movement of the sun among the stars a real or an apparent one? It is a question, however, which has been long since answered; and it can be very definitely stated, not only that the earth rotates on its axis in a period of twenty-four sidereal hours, but that it moves or revolves round the sun in a period which we call a year, and that it is this real movement which causes the apparent one of the sun among the stars. Let the reader take a top and spin it. Perhaps the top has a movement of progression as well as a movement of rotation, and it is in that way quite easy to see that the earth may rotate on its axis and revolve about the sun at one and the same time. And with a top of special construction its axis of rotation might be inclined so that its plane of rotation ceased to coincide with the plane of its motion of progression; still the two movements would go on, and in whatever position the top might be placed, its axis might be made to remain practically parallel to itself during its movements.

We may now, then, make the following statements:—*The earth revolves round the sun, and throughout the revolution the axis of rotation remains practically parallel to itself.* With regard to the latter part of this statement it may be added that if this were not so—if the axis of the earth were subject to perpetual change of

direction—the declinations of the stars would also be subject to constant change.

The demonstration of this movement of the earth round the sun depends upon physical considerations in exactly the same way as does the demonstration of the earth's movement of rotation, and to these considerations attention must now be turned. It will be found that we have now to do with an entirely different branch of physics to that which we drew upon when seeking for a proof of the rotation. The utilisation of its principles for the purposes of astronomy is due to Dr. Bradley, a former Astronomer-Royal. In the year 1729 he made a series of observations of stars, expecting certain results to flow from them. Instead, however, of getting the results for which he had looked, his observations gave him some which differed entirely from his predicted ones, and which he failed to understand. For such a thing as this to happen is a piece of good fortune for the scientific investigator; it sets him thinking and working, and frequently leads him to the discovery of some hitherto unknown physical law. It set Dr. Bradley thinking and working. Curious as it may seem, the observation which led him to a complete understanding of this subject was what he observed one day when a boat at anchor near the shore at Greenwich began to get under weigh in a stiff breeze. The little boat had one of those short pennants on its mast, and Dr. Bradley noticed that, as soon as the boat began to move, the direction of the wind, as indicated by the movement of this pennant, changed. Before proceeding to consider the bearing which this fact, seemingly remote from astronomy, has upon star work, it may be advisably

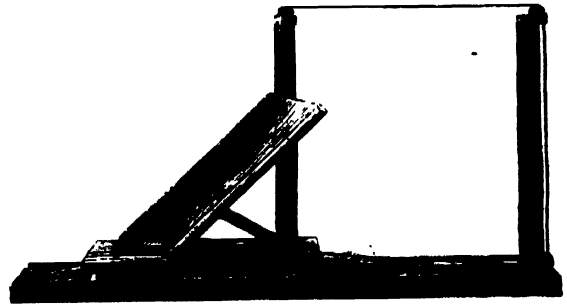

FIG. 35.—Model to illustrate the aberration of light. A square tube, with glass front and a slit along the centre of its upper side to allow the passage of a thread, is inclined at 45° and caused to run along a level track, while a weight suspended from a thread passing round three pulleys and attached at the other end to the front of the carriage is allowed to descend. In this figure the weight is at the commencement of its fall.

to take one or two simple illustrations which will show what must have passed through Bradley's mind as the explanation of the strange unexpected movements of the stars was slowly growing within it. The first illustration is one due to Sir George Airy. Suppose that a vessel is passing a fort, and that a shot is fired from the fort at the moving vessel. The shot will travel in a straight line; but it is evident that since the ship is moving, if that shot really pierces both sides of the vessel, then a line joining the spot where the ball pierced the one side to the spot where it pierced the other side will not be square to the direction of the ship's motion. During the short time taken by the shot to pass from one side of the ship to the other, the vessel has moved through a certain small distance, and if the line joining the two shot-holes were alone considered, it might be inferred that the shot had come from a direction in advance of the true one. That is one illustration, the point of it being that the motion of the vessel seems to have given a new direction to the shot. Take another illustration, more familiar, and perhaps almost as clear. In this country frequent opportunities offer themselves of travelling in cabs or railway trains, with the rain falling on their closed windows. Every one must have noticed that at such times there is always a very curious slant in the apparent direction of the drops whilst the train or the cab is in motion; the rain seems to come from a point in front of us; we always seem to meet the rain. The fact is that a body in motion, and especially a body with the velocity of an express train, does not receive the rain under the same conditions as when it is at rest. The question of its velocity has to be taken into consideration. An experiment will show better what is meant.

<sup>1</sup> Continued from vol. xxix. p. 205. §

Imagine a weight supported by a piece of thread; the moment that thread is cut the weight falls in a straight line to the ground. If it be desired, therefore, to receive the falling weight in a tube at rest under the weight, and to so receive it that it shall not touch the sides of the tube as it passes through, the tube must be held in an upright position. Take another step, and suppose now that it is a question of causing the weight to fall through the tube whilst the tube itself is travelling at a certain rate, say at

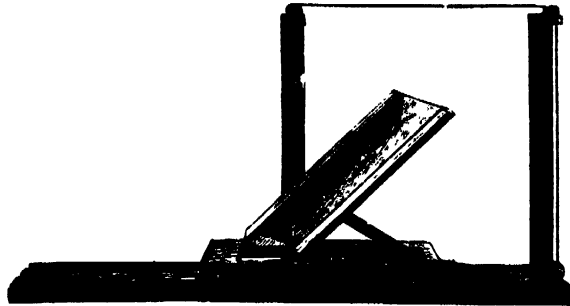

FIG. 36.—Same apparatus as preceding, but with the weight near the end of its fall.

the velocity of the falling weight. It is perfectly obvious that this cannot be done by holding the tube in a perpendicular position, the tube must be inclined, and the angle of its inclination will vary with the varying relative velocities of tube and weight. The more quickly the weight falls the less inclined must the tube be to receive it. This not only supplies the explanation of the slant of the rain on the windows of the railway carriage, but it explains what is very much more important

from an astronomical point of view. Consider Fig. 37 for a moment. Here  $AB$  represents the path of anything falling, and  $aCB$  the angle of the tube destined to receive it. It may be called the angle of slant, but the point is not that we give it any particular name, but that its relation to the velocity of fall is a very fixed and definite one. Accept it as such, and then connect it,

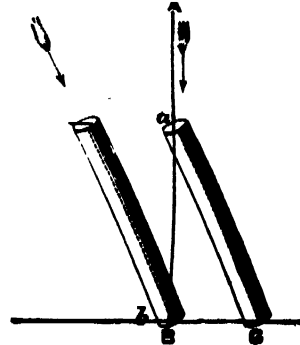

FIG. 37.

not with the falling weight or with the slant of the rain, but with the velocity of the light coming to the earth from any star in the heavens, and the velocity of the earth in its orbit round the sun. It may be said that two assumptions are here made, first that light has a velocity, and secondly that the earth does move round the sun. Consider, then, the first of these, the question of the velocity of light. In our day, with all the experimental methods

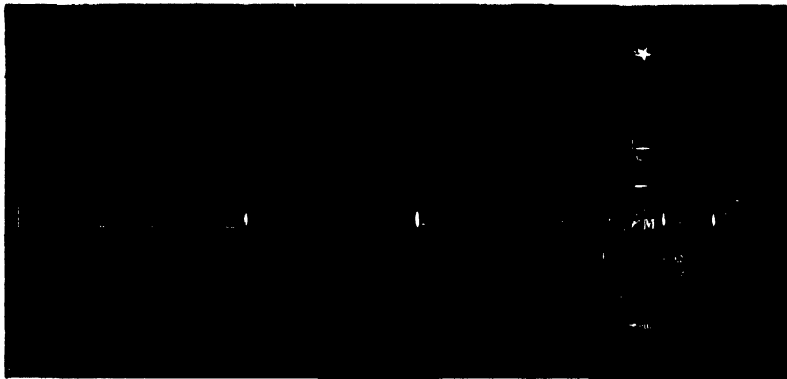

FIG. 38.—Fizeau's mode of determining the velocity of light.

niceties which the labours of those who have gone before have placed at our disposal, this question of the velocity of light can be answered by what may be called a laboratory experiment. The first real attempt to answer the question was made some years ago by a Frenchman, M. Fizeau. His method of observation was a beautifully simple one, and has turned out to be highly satisfactory in its results. All the essential parts of his apparatus are shown in Fig. 38. Light from a lamp was made to pass through a system of lenses and was brought to a focus after reflection from the front surface of a piece of plain glass. The light was then grasped by an object-glass and sent out in a parallel beam to a station distant about five miles. There it fell on another object-glass, which again brought it to a focus on a mirror at the end of this second telescope. Then having got the light to the second mirror, it was reflected on its path back again. When the reflected light returned, part of it was allowed to go through the plain glass mirror to the eyepiece seen at the end of the telescope in Fig. 38. At the point where the rays crossed in the first telescope there was interposed the edge of a cogged wheel, to which a great velocity of rotation could be imparted by clockwork, and through the intervals between the teeth of which the light had to pass. Suppose first

that the wheel is at rest. The lamp is lighted, and looking through the cogs of the wheel the observer sees the image of the lamp reflected back to him as a star of light from that distant

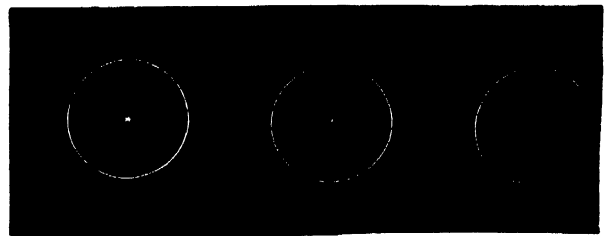

FIG. 39.—Fizeau's velocity of light apparatus. Appearance when the toothed wheel is at rest, when it is in slow motion, and when its rotation is so rapid as to cause complete extinction of the light.

mirror by means of the arrangement to which reference has been made.



Assume now that light occupies no time in travelling from the lamp to the first mirror, through the first telescope, across the space between the two telescopes, and back again after its reflection by the second mirror. Assume, in fact, that the velocity of light is infinite, then it is perfectly clear that an observer would keep on seeing that star of light whether the wheel remained at rest or were put in motion. But now assume that light does take a certain very small time to make the journey spoken of, and that the wheel can be turned with just such a velocity that when the light reaches it on its return it will meet, not an opening, but one of the cogs. Then the light would not be visible; it would find itself a cog behind, so that, if light travels very fast indeed and the wheel is made to travel with a great and known velocity and the relation existing between the velocities be known, the velocity of light can be measured in this way. That is the way in which Fizeau measured it, and he gave the velocity as being 190,000 miles per second.

It may be thought perhaps that this being the first attempt in a matter of this kind it was not very worthy of credit; but the similarity of the results which have been obtained in all such experiments proves that they are all very worthy of credit, and that this velocity must be accepted as established within narrow limits.

We come now to Foucault, the man to whose genius science owes the experimental proof of the earth's rotation, to which reference has already been made. He also attacked this question of the velocity of light. Going to work in quite a different way from Fizeau, he succeeded in enriching science with a method quite as reliable in its operation and as accurate in its results.

A pencil of light coming from a slit at *s* (see Fig. 40) impinges

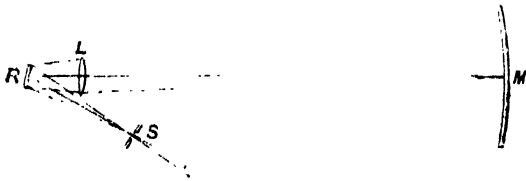

FIG. 40.—Foucault's arrangement for determining the velocity of light.

upon the plane mirror *R*, which is capable of turning round a vertical axis. This mirror reflects the light falling on its surface, and the action of the lens, *L*, causes an image to be formed on the surface of the concave mirror, *M*, the centre of which coincides with the axis at *R*. This concave mirror reflects the image backwards on its path to the slit. Foucault's arrangement, as has been said, was to have the mirror, *R*, made to rotate. If, therefore, *R* be turned about its axis while the light from the slit, *s*, is falling upon its surface, for so long as the light falls on the lens so long will the image of the slit be formed on the surface of the distant mirror. Similarly for so long as the reflected image falls upon the lens, so long will the image be reflected back to the slit. Now if the mirror were made to rotate rapidly, and light were infinite in its velocity, then once during each revolution of the mirror at one particular angle the light would be reflected back to the slit; but assume that light takes some very small fraction of time to travel over the space between the mirrors, it will be observed that the image will not be reflected back to the slit but will suffer a deflection in one direction or the other according as the mirror turns from left to right or from right to left, and, the velocity of the rotating mirror being known, the amount of this displacement will enable the velocity of light to be determined.

With two such different methods it might be supposed that the results obtained were very different. Not so, however; the velocity obtained by Fizeau was, as I have said, 190,000 miles per second, that by Foucault 185,000 per second.

It so happens that both these methods have been gone over quite recently, Fizeau's method by another Frenchman, M. Cornu, and Foucault's by Mr. Michelson, an officer in the American navy.

Mr. Michelson modified Foucault's method somewhat, the fault in which was that the displacement obtained was so extremely small, being but the fraction of a millimetre; and when it is remembered that the image is always more or less indistinct on account of atmospheric conditions and imperfection in the lenses and mirrors employed, it will be seen that it was difficult

for Foucault to attain to any very great accuracy. Mr. Michelson therefore used an apparatus which would give him a greater deflection than that obtained by Foucault. As before, *s* (Fig. 41) was the slit, *R* the rotating mirror in the principal focus

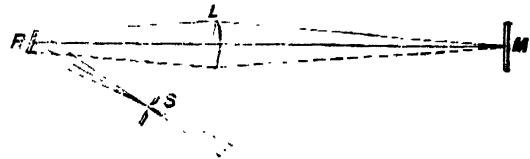

FIG. 41.—Michelson's variation of Foucault's experiment.

of the lens, but the distant mirror, instead of being concave, was a plane one, and the lens one of great focal length, for a reason that will appear immediately. This lens, in consequence of the smallness of its diameter in comparison with its great focal length, was not entirely convenient. In order that the displacement should be great, it is necessary that the distance between *R* and *M*, the distance from the revolving mirror to the slit, and the speed of rotation should be the greatest possible.

Unfortunately, the second condition clashes with the first,<sup>1</sup> for the distance from the revolving mirror to the slit, or the "radius" is the difference between the distances of principal and conjugate focus for the distant mirror *M*, and the greater the distance the smaller the radius. Two methods were employed by Mr. Michelson in overcoming this difficulty: first, he had his lens of great focal length, 150 feet, and he placed the revolving mirror, not at the principal focus, but fifteen feet within it. He thus managed to get a distance between the mirrors of 2000 feet with a radius of thirty feet, and his mirror made 256 revolutions per second. He then obtained a deflection of 133 millimetres, that being about 200 times greater than the deflection obtained by Foucault. This deflection he measured to within three or four hundredths of a millimetre in each observation.

Mr. Michelson's experiments were made along an almost level stretch of sea wall at the Naval Academy.

We are therefore justified in saying, as the result of these experiments of Fizeau and Cornu, Foucault and Michelson, that light has a velocity of some 186,000 miles per second.

If that be so, then, if the statement that the earth revolves about the sun be true, this must follow. In Fig. 42 *a*, *b*, *c*, *d*

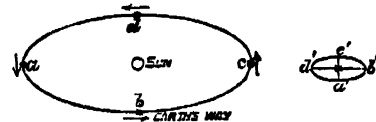

FIG. 42.—Annual change of a star's position, due to aberration: *a b c d*, the earth, in different parts of its orbit: *a' b' c' d'*, the corresponding aberration places of the star, varying from the true place in the direction of the earth's motion at the time.

represent the earth in different parts of its orbit around the sun; the contention is that if there be this revolution of the earth round the sun, and if light really travels with anything short of an infinite velocity, then the position of a star must change, for the reason that the telescope of the astronomer must always be pointed in advance of the star to catch its light in the same way that to catch the falling weight we had to incline the tube in the direction of its motion.

When any observation is made on any star in the heavens, the telescope of the astronomer must therefore be pointed in advance of the star to catch its light, and taking, as in the diagram, four different points in the earth's orbit, it is obvious that the telescope at these four different points must be pointed in four different directions with regard to the star. For instance, if we take a point at *c*, where the earth is travelling in the direction of the arrow, and the point at which the star would be seen if the earth were at rest, or the velocity of light were infinite, be indicated by the star in the figure, *c'* is the direction in which the star would be seen, and in which the astronomer's telescope must be pointed to catch its light. Similarly with the earth at *d* the telescope must be pointed to *d'*, and so with the earth at *a* we must have it pointing towards *a'*. It was this strange anomaly which puzzled Dr. Bradley in the year 1729.

<sup>1</sup> For full details of Michelson's experiments see NATURE, vol. xxi. p. 94 et seq.

He noticed that the stars moved in ellipses every year round a mean point. This fact of aberration, then, is a real thing. It has been said that the angle at which the tube had to be inclined to receive the weight depended upon their respective velocities, that the faster the tube travelled, the greater must be its inclination, and therefore the greater the angle the greater the earth's velocity with reference to the velocity of light. In the case of the majority of the stars what we get is an ellipse, and in an ellipse we have certain differences which have to be taken into account, the last difference of all being that an infinitely elongated ellipse is a straight line, and it is found that from one particular point of the heavens where, in consequence of this aberrational motion, the orbits of the stars round their mean places are almost circular, we at last get to a point where the motion is simply an oscillation of the star backwards and forwards to and from its mean place; we are dealing, in fact, with that form of the ellipse when it is in the form of a straight line. When we deal with an ellipse we no longer talk of the radius, but of the semi-axis major, which is half the greatest length. The angle of aberration of which I have spoken only amounts to  $20''.4451$ , but though small, it is quite enough to prove that the earth does revolve, and that consequently the sun is the centre of the system to which the earth belongs. Now in order to show the importance of physical inquiry in this matter, there is another statement which must be made. If we consider this aberration question fully, we find in it what is perhaps the most perfect way of determining the distance of the sun from the earth, and it will be seen that it is perfectly simple, so simple in fact, that the wonder is that more attention has not been given to it in our text-books. We have first the fact that the inclination of the tube depends upon the relative velocities of the tube and falling body; in the case of light it will of course depend upon the relative velocities of the earth in its orbit and light radiating from a star. Knowing this latter to be somewhere about 186,000 miles per second, and the aberration angle to be  $20''$  and something, we can get the relation of the earth's motion to the velocity of light, and it comes out to be about 1 to 10,089. Now we know that the earth completes a revolution round the sun in 365 $\frac{1}{4}$  days. If it travelled with the velocity of light it would complete a revolution in 52m. 8 $\frac{1}{2}$ s.

Again, we may say, and this is only a rough statement, that the radius of a circle is  $\frac{1}{6}$  of its circumference, so that if it took the earth fifty-two minutes to go round its circumference, or, as we call it, its orbit, it would take  $\frac{1}{6}$  of that time to go along the radius if it travelled with the velocity of light; it would therefore take 8m. 18s. But this radius is the distance of the earth from the sun, and having this time 8m. 18s., we have only to multiply the velocity of light<sup>1</sup> per second, by that, and we get 92,628,000 miles as the distance of the earth from the sun.

J. NORMAN LOCKYER

(To be continued.)

### THE ROYAL COMMISSION ON TECHNICAL INSTRUCTION

WE have just received from the Commission the two volumes of their second Report on Technical Education. We give this week the Recommendations with which the Commissioners conclude their Report:—

Having carefully considered what is desirable and practicable in regard to the general and technical instruction of the various classes engaged in industrial pursuits in this country, we humbly offer the following recommendations, which require the intervention of the Legislature or of public departments:—

I. As to public elementary schools:

(a) That rudimentary drawing be incorporated with writing as a single elementary subject, and that instruction in elementary drawing be continued throughout the standards. That the inspectors of the Education Department, Whitehall, be responsible for the instruction in drawing. That drawing from casts and models be required as part of the work, and that modelling be encouraged by grant.

(b) That there be only two class subjects, instead of three, in the lower division of elementary schools, and that the object lessons for teaching elementary science shall include the subject of geography.

(c) That, after reasonable notice, a school shall not be deemed

<sup>1</sup> The exact value is 186,380 miles according to Michelson, with a possible error of thirty-three miles.

to be provided with proper "apparatus of elementary instruction" under Article 115 of the Code, unless it have a proper supply of casts and models for drawing.

(d) That proficiency in the use of tools for working in wood and iron be paid for as a "specific subject," arrangements being made for the work being done, so far as practicable, out of school hours. That special grants be made to schools in aid of collections of natural objects, casts, drawings, &c., suitable for school museums.

(e) That in rural schools instruction in the principles and facts of agriculture, after suitable introductory object lessons, shall be made obligatory in the upper standards.

(f) That the provision at present confined to Scotland, which prescribes that children under the age of fourteen shall not be allowed to work as full-timers in factories and workshops unless they have passed in the Fifth Standard, be extended to England and Wales.

II. As to classes under the Science and Art Department, and grants by the Department:

(a) That School Boards have power to establish, conduct, and contribute to the maintenance of classes for young persons and adults (being artisans) under the Science and Art Department. That in localities having no School Board the local authority have analogous powers.

(b) That the Science and Art Department shall arrange that the instruction in those science subjects which admit of it shall be of a more practical character than it is at present, especially in the "honours" stage; that payment on results be increased in the advanced stages of all subjects, at least to the level of those now made for practical chemistry and metallurgy, and that greater encouragement be given to grouping.

(c) That the examinations in agriculture be made to have a more practical bearing.

(d) That metallurgy, if it be retained, be divided into groups, as (1) the precious metals, (2) those extracted from metalliferous mines, as copper, tin, lead, &c., (3) iron and steel. That mining be similarly divided into (1) coal and (2) metalliferous mining.

(e) That the inspection of science classes by the Science and Art Department, with a view to ascertain the efficiency of the instruction, and of the apparatus and laboratories, be made more effective, with the assistance, where necessary, of local sub-inspectors.

(f) That it shall not be a requirement of the Science and Art Department that payment of fees be demanded from artisans for instruction in the science and art classes.

(g) That in the awards for industrial design more attention be paid by the Department, than is the case at present, to the applicability of the design to the material in which it is to be executed, and that special grants be made for the actual execution of designs under proper safeguards.

(h) That the limits of the building grants, under the Science and Art Department, to 500*l.* each for schools of Art and of Science should be abolished, and the conditions attached to them be revised.

(i) That, in addition to the loan of circulating collections and the grant of art reproductions at reduced cost, contributions be made to provincial industrial museums of original examples tending to advance the industries of the district in which such museums are situated.

III. Training Colleges for elementary teachers:

(a) That the teaching of science and art in Training Colleges, and its inspection by the Science and Art Department, be made efficient, and that arrangements be made for giving to selected students in those Colleges greater facilities and inducements for the study of art and science in the National Art Training School and the Normal School of Science at South Kensington, the Royal College of Science for Ireland, and other institutions of a similar class approved of by the Government.

IV. Secondary and technical instruction:

(a) That steps be taken to accelerate the application of ancient endowments, under amended schemes, to secondary and technical instruction.

(b) That provision be made by the Charity Commissioners for the establishment, in suitable localities, of schools, or departments of schools, in which the study of natural science, drawing, mathematics, and modern languages, shall take the place of Latin and Greek.

(c) That local authorities be empowered, if they think fit, to establish, maintain, and contribute to the establishment and

maintenance of secondary and technical (including agricultural) schools and colleges.

V. Public libraries and museums:

(a) That ratepayers have power, by vote, to sanction the increase of the expenditure, under the Public Libraries Acts, beyond its present limit, and that the restriction of the Acts to localities having 5,000 inhabitants and upwards be repealed.

(b) That museums of art and science and technological collections be opened to the public on Sundays.

VI. Special recommendations in regard to Ireland:

(a) That steps be taken at the earliest possible moment for the gradual introduction of compulsory attendance at elementary schools in Ireland.

(b) That payments be made by the National Board, under proper regulations, on the results of the teaching of home industries to children, young persons, and adults; as well as in aid of the salaries of industrial teachers.

(c) That systematic instruction be given to primary school teachers, qualifying them to teach the use of tools for working in wood and iron, in the primary schools.

(d) That steps be taken by the Commissioners of National Education in Ireland for the provision of books calculated to assist the teachers of primary schools in giving graduated lessons in rudimentary science.

(e) That grants-in-aid be sanctioned by the Treasury to approved agricultural schools, and to approved schools for instruction in local industries.

(f) That practical evening science classes for artisans form part of the instruction in the Royal College of Science of Ireland, in Dublin.

(g) That the Board of Intermediate Education take steps to insure the provision of adequate means for the practical teaching of science in the schools under their direction.

In addition to the preceding recommendations which necessitate action on the part of the Legislature or of the public authorities, or of both, your Commissioners make the following recommendations, requiring no such action, by way of suggestions for the consideration of those in whose power it is to comply with them:—

I. That it be made a condition by employers of young persons, and by the trade organisations, in the case of industries for which an acquaintance with science or art is desirable, that such young persons requiring it receive instruction therein either in schools attached to works or groups of works, or in such classes as may be available, the employers and trade organisations in the latter case contributing to the maintenance of such classes.

II. That the managers and promoters of science and technical classes should (a) so arrange the emoluments of teachers as to encourage them to retain their students for the advanced stages of subjects in which they have passed the elementary stage, and (b) that they should endeavour to group the teaching of cognate science subjects, as recommended by the Royal Commission on the Advancement of Science, and as provided for by the regulations of the Science and Art Department.

III. That scholarships be more liberally founded, especially for pupils of higher elementary schools, enabling them to proceed to higher technical schools and colleges.

IV. That the great national agricultural societies give aid to the establishment in counties of secondary schools or classes for teaching agriculture.

V. That those responsible for the management of primary schools in Ireland, in the districts where farming is defective, attach small example farms to such schools wherever it is possible; and that Boards of Guardians employ the plots of land attached to workhouses for the agricultural instruction of the children therein.

VI. That the subscriptions given by the liberality of the City of London and of the different Guilds, to the City and Guilds Institute, be made adequate to the fulfilment of the work which that Institute has undertaken, including the equipment and maintenance of its Central Institution.

In closing our Report we think it right to recall the fact that the first impulse to an inquiry into the subject of technical instruction was given by the important letter of Dr., now Sir Lyon Playfair, K.C.B., of May 15, 1867, to the Chairman of the Schools' Inquiry Commission, in which he called attention to the great progress in engineering and manufactures abroad, shown at the Paris Exhibition of that year. In the course of our inquiry we have received much guidance from the letter on the subject by Mr. B. Samuelson, M.P., to the Vice-President of

the Committee of Council on Education, dated November 16, 1867; from the Report of the Select Committee of the House of Commons on Scientific Instruction, 1868; the Report of the Royal Commission on the same subject; the papers by Mr. H. M. Felkin on Chemnitz, by Messrs. McLaren and Beaumont, and various other publications.

We desire also to express our thanks to the public authorities, to the owners and managers of industrial works, and to the numerous other persons, both at home and abroad, to whom we had occasion to apply for information, for the frank and courteous manner in which it was given to us; and also to acknowledge the prompt and valuable assistance which we received from the members of our Diplomatic and Consular services in the prosecution of our inquiry. All of which we humbly beg leave to submit for Your Majesty's gracious consideration.

(Signed)

B. SAMUELSON  
H. E. ROSCOE  
PHILIP MAGNUS  
JOHN SLAGG  
SWIRE SMITH  
WM. WOODALL

GILBERT R. REDGRAVE,  
Secretary,  
April 4, 1884

## ON THE NOMENCLATURE, ORIGIN, AND DISTRIBUTION OF DEEP-SEA DEPOSITS<sup>1</sup>

### II.

*Globigerina Ooze*.—We designate by this name all those truly pelagic deposits containing over 40 per cent. of carbonate of lime, which consists principally of the dead shells of pelagic Foraminifera—*Globigerina*, *Orbulina*, *Pulvinulina*, *Pullenia*, *Sphaeroidina*, &c. In some localities this deposit contains 95 per cent. of carbonate of lime. The colour is milky white, yellow, brown, or rose, the varieties of colour depending principally on the relative abundance in the deposit of the oxides of iron and manganese. This ooze is fine grained; in the tropics some of the Foraminifera shells are macroscopic. When dried it is pulverulent. Analyses show that the sediment contains, in addition to carbonate of lime, phosphate and sulphate of lime, carbonate of magnesia, oxides of iron and manganese, and argillaceous matters. The residue is of a reddish brown tinge. Lapilli, pumice, and glassy fragments, often altered into palagonite, seem always to be present, and are frequently very abundant. The mineral particles are generally angular, and rarely exceed 0.08 mm. in diameter; monoclinic and triclinic feldspars, augite, olivine, hornblende, and magnetite are the most frequent. When quartz is present, it is in the form of minute, rounded, probably wind-borne grains, often partially covered with oxide of iron. More rarely we have white and black mica, bronzite, actinolite, chromite, glauconite, and cosmic dust. Siliceous organisms are probably never absent, sometimes forming 20 per cent. of the deposit, at other times only recognisable after careful microscopic examination. In some regions the frustules of Diatoms predominate, in others the skeletons of Radiolarians.

The *fine washings*, viewed with the microscope, are not homogeneous. The greater part consists of argillaceous matter coloured by the oxides of iron and manganese. Mixed with this, we distinguish fragments of minerals with a diameter less than 0.05 mm., and minute particles of pumice can nearly always be detected. Fragments of Radiolarians, Diatoms, and siliceous spicules can always be recognised, and are sometimes very abundant.

*Pteropod Ooze*.—This deposit differs in no way from a *Globigerina ooze* except in the presence of a greater number and variety of pelagic organisms, and especially in the presence of *Pteropod* and *Heteropod* shells, such as *Diacria*, *Atlanta*, *Styliola*, *Carinaria*, &c. The shells of the more delicate species of pelagic Foraminifera and young shells are also more abundant in these deposits than in a *Globigerina ooze*. It must be remembered that the name "*Pteropod ooze*" is not intended to indicate that the deposit is chiefly composed of the shells of these mollusks, but, as their presence in a deposit is characteristic and has an important bearing on geographical and bathymetrical distribution, we think it desirable to emphasise the presence of these shells in any great abundance. It may here be pointed out that there is a very considerable difference between a *Globigerina*

<sup>1</sup> A Paper read before the Royal Society of Edinburgh by John Murray and Leonard. Communicated by John Murray. Continued from p. 88.

ooze or a Pteropod ooze situated near continental shores and deposits bearing the same names situated towards the centres of oceanic areas, both with respect to mineral particles and remains of organisms.

**Diatom Ooze.**—This ooze is of a pale straw colour, and is composed principally of the frustules of Diatoms. When dry it is a dirty white siliceous flour, soft to the touch, taking the impression of the fingers, and contains gritty particles which can be recognised by the touch. It contains on an average about 25 per cent. of carbonate of lime, which exists in the deposit in the form of small *Globigerina* shells, fragments of Echinoderms and other organisms. The residue is pale white and slightly plastic; minerals and fragments of rocks are in some cases abundant; these are volcanic, or, more frequently, fragments and minerals coming from continental rocks and transported by glaciers. The *fine washings* consist essentially of particles of Diatoms along with argillaceous and other amorphous matter. We estimate that the frustules of Diatoms and skeletons of siliceous organisms make up more than 50 per cent. of this deposit.

**Radiolarian Ooze.**—It was stated, when describing a *Globigerina* ooze, that Radiolarians were seldom, if ever, completely absent from marine deposits. In some regions they make up a considerable portion of a *Globigerina* ooze, and are also found in Diatom ooze and in the terrigenous deposits of the deeper water surrounding the land. In some regions of the Pacific, however, the skeletons of these organisms make up the principal part of the deposits, and to these we have given the name "Radiolarian ooze." The colour is reddish or deep brown, due to the presence of the oxides of iron and manganese. The *mineral particles* consist of fragments of pumice, lapilli, and volcanic minerals, rarely exceeding 0.07 mm. in diameter. There is not a trace of carbonate of lime in the form of shells in some samples of Radiolarian ooze, but other specimens contain 20 per cent. of carbonate of lime derived from the shells of pelagic Foraminifera. The clayey matter and mineral particles in this ooze are the same as those found in the red clays, which we will now proceed to describe.

**Red Clay.**—Of all the deep-sea deposits this is the one which is distributed over the largest areas in the modern oceans. It might be said that it exists everywhere in the abysmal regions of the ocean basins, for the residue in the organic deposits which has been described under the names *Globigerina*, Pteropod, and Radiolarian ooze, is nothing else than the red clay. However, this deposit only appears in its characteristic form in those areas where the terrigenous minerals and calcareous and siliceous organisms disappear to a greater or less extent from the bottom. It is in the central regions of the Pacific that we meet with the typical examples. Like other marine deposits, this one passes laterally, according to position and depth, into the adjacent kind of deep-sea ooze or mud.

The argillaceous matters are of a more or less deep brown tint from the presence of the oxides of iron and manganese. In the typical examples no mineralogical species can be distinguished by the naked eye, for the grains are exceedingly fine and of nearly uniform dimensions, rarely exceeding 0.05 mm. in diameter. It is plastic and greasy to the touch; when dried it coagulates into lumps so coherent that considerable force must be employed to break them. It gives the brilliant streak of clay, and breaks down in water. The pyrognostic properties show that we are not dealing with a pure clay, for it fuses easily before the blowpipe into a magnetic bead.

Under the term red clay are comprised those deposits in which the characters of clay are not well pronounced, but which are mainly composed of minute particles of pumice and other volcanic material which, owing to their relatively recent deposition, have not undergone great alteration. If we calculate the analyses of red clay, it will be seen, moreover, that the silicate of alumina present as clay ( $2\text{SiO}_2, \text{Al}_2\text{O}_3 + 2\text{H}_2\text{O}$ ) comprises only a relatively small portion of the sediment; the calculation shows always an excess of free silica, which is attributed chiefly to the presence of siliceous organisms.

Microscopic examination shows that a red clay consists of argillaceous matter, minute mineral particles, and fragments of siliceous organisms; in a word, it is in all respects identical with the residue of the organic oozes. The mineral particles are for the greater part of volcanic origin, except in those cases where continental matters are transported by floating ice, or where the sand of deserts has been carried to great distances by winds. These volcanic minerals are the same constituent minerals of modern eruptive rocks, enumerated in the description of volcanic

muds and sands; in the great majority of cases they are accompanied by fragments of lapilli and of pumice more or less altered. Vitreous volcanic matters belonging to the acid and basic series of rocks predominate in the regions where the red clay has its greatest development, and it will be seen presently that the most characteristic decompositions which there take place are associated with pyroxic lavas.

Associated with the red clay are almost always found concretions and microscopic particles of the oxides of iron and manganese, to which the deposit owes its colour. Again, in the typical examples of the deposit, zeolites in the form of crystals and crystalline spherules are present, along with metallic globules and silicates which are regarded as of cosmic origin. Calcareous organisms are so generally absent in the red clay that they cannot be regarded as characteristic; when present, they are chiefly the shells of pelagic Foraminifera, and are usually met with in greater numbers in the surface-layers of the deposit, to which they give a lighter colour. On the other hand, the remains of Diatoms, Radiolarians, and Sponge-spicules are generally present, and are sometimes very abundant. The earbones of various Cetaceans, as well as the remnants of other Cetacean bones, and the teeth of sharks, are, in some of the typical samples far removed from the continents, exceedingly abundant, and are often deeply impregnated with, or embedded in thick coatings of, oxides of iron and manganese. The remains of these Vertebrates have seldom been dredged in the organic oozes, and still more rarely in the terrigenous deposits.

The *fine washings*, as examined with a power of 450 diameters, are composed of an amorphous matter, fragments of minerals, the remains of siliceous organisms, and colouring substances. What we call amorphous matter may be considered as properly the argillaceous matter, and presents characters essentially vague. It appears as a gelatinous substance, without definite contours, generally colourless, perfectly isotropic, and forms the base which agglutinates the other particles of the washings. As these physical properties are very indefinite, it is difficult to estimate even approximately the quantity present in a deposit. However, it augments in proportion as the deposit becomes more clayey, but we think that only a small quantity of this substance is necessary to give a clayey character to a deposit. Irregular fragments of minerals, small pieces of vitreous rocks, and remains of siliceous organisms predominate in this fundamental base. These particles probably make up about 50 per cent. of the whole mass of the *fine washings*, and this large percentage of foreign substances must necessarily mask the character of the clayey matter in which they are embedded. The mineral particles are seldom larger than 0.01 mm. in diameter, but descend from this size to the merest points. It is impossible, on account of their minuteness, to say to what mineral species they belong; their optical reactions are insensible, their outlines too irregular, and all special coloration has disappeared. All that can be reasonably said is that these minute mineral particles probably belong to the same species as the larger particles in the same deposit, such as feldspar, hornblende, magnetite, &c. In the case of pumice and siliceous organisms the fragments can, owing to their structure, be recognised when of a much less size than in the case of the above minerals.

It can be made out by means of the microscope that the colouring substances are hydrated oxides of iron and manganese. The former is scattered through the mass in a state of very fine division; in some points, however, it is more localised, the argillaceous matter here appearing with a browner tinge, but these spots are noticed gradually to disappear in the surrounding mass. The coloration given by the manganese is much more distinct; there are small, rounded, brownish spots with a diameter of less than 0.01 mm., which disappear under the action of hydrochloric acid with disengagement of chlorine. These small round concretions, which are probably a mixture of the oxides of iron and manganese, will be described with more detail in the *Challenger* Report.

The following table shows the nomenclature we have adopted:—

Terrigenous deposits.	} Shore formations, Blue mud, Green mud and sand, Red mud, Coral mud and sand, Coralline mud and sand, Volcanic mud and sand,	} Found in inland seas and along the shores of continents.	
			} Found about oceanic islands and along the shores of continents.

Pelagic deposits.

Red clay,  
Globigerina ooze,  
Pteropod ooze,  
Diatom ooze,  
Radiolarian ooze,

Found in the  
abyssal regions  
of the ocean  
basins.

**Geographical and Bathymetrical Distribution.**—In the preceding pages we have confined our remarks essentially to the lithological nature of the deep-sea deposits, including in this term the dead shells and skeletons of organisms. From this point of view it has been possible to define the sediments and to give them distinctive names. We now proceed to consider their geographical and bathymetrical distribution, and the relations which exist between the mineralogical and organic composition and the different areas of the ocean in which they are formed.

A cursory glance at the geographical distribution shows that the deposits which we have designated MUDS and SANDS are situated at various depths at no great distance from the land, while the ORGANIC OOZES and RED CLAYS occupy the abyssal regions of the ocean basins far from land. Leaving out of view the coral and volcanic muds and sands which are found principally around oceanic islands, we notice that our blue muds, green muds and sands, red muds, together with all the coast and shore formations, are situated along the margins of the continents and in inclosed and partially inclosed seas. The chief characteristic of these deposits is the presence in them of continental debris. The blue muds are found in all the deeper parts of the regions just indicated, and especially near the embouchures of rivers. Red muds do not differ much from blue muds except in colour, due to the presence of ferruginous matter in great abundance, and we find them under the same conditions as the blue muds. The green muds and sands occupy, as a rule, portions of the coast where detrital matter from rivers is not, apparently, accumulating at a rapid rate, viz. on such places as the Agulhas Bank, off the east coast of Australia, off the coast of Spain, and at various points along the coast of America.

Let us cast a glance at the region occupied by terrigenous deposits, in which we include all truly littoral formations. This region extends from high-water mark down, it may be, to a depth of over four miles, and in a horizontal direction from 60 to perhaps 300 miles seawards, and includes, in the view we take, all inland seas, such as the North Sea, Norwegian Sea, Mediterranean Sea, Red Sea, China Sea, Japan Sea, Caribbean Sea, and many others. It is the region of change and of variety with respect to light, temperature, motion, and biological conditions. In the surface waters the temperature ranges from 80° F. in the tropics, to 28° F. in the polar regions. Below the surface down to the nearly ice-cold water found at the lower limits of the region in the deep sea, there is in the tropics an equally great range of temperature. Plants and animals are abundant near the shore, and animals extend in relatively great abundance down to the lower limits of this region which is now covered by these terrigenous deposits. The specific gravity of the water varies much, owing to mixture with river water or great local evaporation, and this variation in its turn affects the fauna and flora. In the terrigenous region tides and currents produce their maximum effect, and these influences can in some instances be traced to a depth of 300 fathoms, or nearly 2000 feet. The upper or continental margin of the region is clearly defined by the high-water mark of the coast-line, which is constantly changing through breaker action, elevation, and subsidence. The lower or abyssal margin is less clearly marked out. It passes in most cases insensibly into the abyssal region, but may be regarded as ending when the mineral particles from the neighbouring continents begin to disappear from the deposits, which then pass into an organic ooze or a red clay.

Contrast with these, those conditions which prevail in the abyssal region in which occur the organic oozes and red clay, the distribution of which will presently be considered. This area comprises vast undulating plains from two to five miles beneath the surface of the sea, the average being about three miles, here and there interrupted by huge volcanic cones (the oceanic islands). No sunlight ever reaches these deep cold tracts. The range of temperature over them is not more than 7°, viz. from 31° to 38° F., and is apparently constant throughout the whole year in each locality. Plant life is absent, and although animals belonging to all the great types are present, there is no great variety of form or abundance of individuals. Change of any kind is exceedingly slow.

What is the distribution of deposits in this abyssal region

of the earth's surface? In the tropical and temperate zones of the great oceans, which occupy about 110° of latitude between the two polar zones, at depths where the action of the waves is not felt, and at points to which the terrigenous materials do not extend, there are now forming vast accumulations of *Globigerina* and other pelagic Foraminifera, coccoliths, rhabdoliths, shells of pelagic Mollusks, and remains of other organisms. These deposits may perhaps be called the sediments of median depths and of warmer zones, because they diminish in great depths and tend to disappear towards the poles. This fact is evidently in relation with the surface temperature of the ocean, and shows that pelagic Foraminifera and Mollusks live in the superficial waters of the sea, whence their dead shells fall to the bottom. *Globigerina* ooze is not found in inclosed seas nor in polar latitudes. In the Southern Hemisphere it has not been met with beyond the 50th parallel. In the Atlantic it is deposited upon the bottom at a very high latitude below the warm waters of the Gulf Stream, and is not observed under the cold descending polar current which runs south in the same latitude. These facts are readily explained, if we admit that this ooze is formed chiefly by the shells of surface organisms, which require an elevated temperature and a wide expanse of sea. But as long as the conditions of the surface are the same, we would expect the deposits at the bottom also to remain the same. In showing that such is not the case, we are led to take into account an agent which is in direct correlation with the depth. We may regard it as established that the majority of the calcareous organisms which make up the *Globigerina* and Pteropod oozes live in the surface waters, and we may also take for granted that there is always a specific identity between the calcareous organisms which live at the surface and the shells of these pelagic creatures found at the bottom. This observation will permit us to place in relation the organic deposits and those which are directly or indirectly the result of the chemical activity of the ocean. *Globigerina* ooze is found in the tropical zone at depths which do not exceed 2400 fathoms, but when depths of 3000 fathoms are explored in this zone of the Atlantic and Pacific, there is found an argillaceous deposit without, in many instances, any trace of calcareous organisms. When we descend from the "submarine plateaus" to depths which exceed 2250 fathoms, the *Globigerina* ooze gradually disappears, passing into a grayish marl, and finally is wholly replaced by an argillaceous material which covers the bottom at all depths greater than 2900 fathoms.

The transition between the calcareous formations and the argillaceous ones takes place by almost insensible degrees. The thinner and more delicate shells disappear first. The thicker and larger shells lose little by little the sharpness of their contour and appear to undergo a profound alteration. They assume a brownish colour, and break up in proportion as the calcareous constituent disappears. The red clay predominates more and more as the calcareous element diminishes in the deposit.

If we now recollect that the most important elements of the organic deposits have descended from the superficial waters, and that the variations in contour of the bottom of the sea cannot of themselves prevent the debris of animals and plants from accumulating upon the bottom, their absence in the red clay areas can only be explained by a decomposition under the action of a cause which we must seek to discover.

*Pteropod ooze*, it will be remembered, is a calcareous organic deposit, in which the remains of Pteropods and other pelagic Mollusca are present, though they do not always form a preponderating constituent, and it has been found that their presence is in correlation with the bathymetrical distribution.

In studying the nature of the calcareous elements which are deposited in the pelagic areas, it has been noticed that, like the shells of the Foraminifera, those of the Thecosomatous Pteropoda, which live everywhere in the superficial waters, especially in the tropics, become fewer in number as the depth from which the sediments are derived increases. We have just observed that the shells of Foraminifera disappear gradually as we descend along a series of soundings from a point where the *Globigerina* ooze has abundance of carbonate of lime, towards deeper regions; but we notice also that when the sounding-rod brings up a graduated series of sediments from a declivity descending into deep water, among the calcareous shells those of the Pteropods and Heteropods disappear first in proportion as the depth increases. At depths less than 1400 fathoms in the tropics a Pteropod ooze is found with abundant remains of Heteropods and Pteropods; deeper soundings then give a *Globigerina* ooze without these molluscan remains; and in still greater depths, as before men-

tioned, there is a red clay in which calcareous organisms are nearly, if not quite, absent.

In this manner, then, it is shown that the remains of calcareous organisms are completely eliminated in the greatest depths of the ocean. For if such be not the case, why do we find all these shells at the bottom in the shallower depths, and not at all in the greater depths, although they are equally abundant on the surface at both places? There is reason to think that this solution of calcareous shells is due to the presence of carbonic acid throughout all depths of ocean water. It is well known that this substance, dissolved in water, is an energetic solvent of calcareous matter. The investigations of Buchanan and Dittmar have shown that carbonic acid exists in a free state in sea water, and in the second place, Dittmar's analyses show that deep-sea water contains more lime than surface water. This is a confirmation of the theory which regards carbonic acid as the agent concerned in the total or partial solution of the surface shells before or immediately after they reach the bottom of the ocean, and is likewise in relation with the fact that in high latitudes where fewer calcareous organisms are found at the surface, their remains are removed at lesser depths than where these organisms are in greater abundance. It is not improbable that sea water itself may have some effect in the solution of carbonate of lime, and further, that the immense pressure to which water is subjected in great depths may have an influence on its chemical activity. We await the result of further researches on this point, which have been undertaken in connection with the *Challenger* Reports. We are aware that objections have been raised to the explanation here advanced, on account of the alkalinity of sea water, but we may remark that alkalinity presents no difficulty which need be here considered (Dittmar, "Phys. Chem. *Chall. Exp.*," part i. 1884).

This interpretation permits us to explain how the remains of Diatoms and Radiolarians (surface organisms like the Foraminifera) are found in greater abundance in the red clay than in a Globigerina ooze. The action which suffices to dissolve the calcareous matter has little or no effect upon the silica, and so the siliceous shells accumulate. Nor is this view of the case opposed to the distribution of the Pteropod ooze. At first we should expect that the Foraminifera shells, being smaller, would disappear from a deposit before the Pteropod shells; but if we remember that the latter are very thin and delicate, and, for the quantity of carbonate of lime present, offer a larger surface to the action of the solvent than the thicker, though smaller, Globigerina shells, we shall see the explanation of this apparent anomaly.

(To be continued.)

### UNIVERSITY AND EDUCATIONAL INTELLIGENCE

CAMBRIDGE.—The Special Board for Mathematics has reported in favour of an interval of one year being allowed between the second and the third parts of the Mathematical Tripos, instead of seven months as at present. It is also suggested that the work done in the first two parts of the Tripos has deteriorated in consequence of being held in the latter part of the Easter Term, when men are subject to many distractions.

The new buildings for the Department of Practical Botany are to be proceeded with forthwith, and thus Dr. Vines will gain the much-needed accommodation he has so long waited for.

The thanks of the University have been voted to Sir A. Gordon and to Mr. A. P. Maudslay for their presents of valuable ethnological collections, made by them in Fiji, to the new Museum of Archæology.

The eighteenth annual report of the Museums and Lecture-Rooms Syndicate draws attention to the pressing need of additional accommodation for Human and Comparative Anatomy and for Physiology. Nothing can be done to enlarge the provision of Human Anatomy till the new Chemical Laboratory is completed. A further report as to the accommodation for Physiology and Comparative Anatomy will be made shortly.

Profs. Liveing and Dewar report that additional special courses for medical students have been established. Lord Rayleigh reports that the elementary demonstrations on Physics in the Cavendish Laboratory are attended by forty students, the advanced by twenty, and the professorial lectures by from twenty to thirty students. Numerous additions of physical apparatus have been made during the year.

Prof. Lewis records a continued improvement in the Mine-

ralogical Museum. Prof. J. P. Cooke of Harvard has presented a large and fine series of American specimens. Mr. G. Seligman of Coblenz has sent specimens far exceeding in value those for which they were exchanged. Mr. Solly brought back many excellent specimens from a tour in Norway; and the late Mr. Tawney's polariscope and optic sections have been presented by his brother.

Prof. Stuart has added some large machines to the Mechanical Department. There were sixty-one pupils in the Lent Term, and their work continues to improve. He states that Mr. Lyon's services are of extreme value as superintendent of the workshops, for he combines practical experience and theoretical knowledge in a manner rarely to be met with.

The additions to the Woodwardian Museum include twelve or fourteen thousand specimens, the collection of the late Mr. Montagu Smith, B.A., of Trinity College, a promising young student of geology, given by his parents in fulfilment of his expressed wish. They include several thousand specimens from all the crags of Norfolk and Suffolk, a rich collection of Chalk mollusca from Berkshire, mollusca from the Gault of Folkestone, the Farringdon sponge-bed, and specimens from many Jurassic localities. Mammalian remains from the Hamstead Beds, Isle of Wight, and Vertebrates from the Gault of Folkestone have been purchased. A number of interesting specimens from the Welsh Palæozoic strata, from Lower Llandovery down to Harlech, have been added by Mr. T. Roberts. The Library continues to increase largely.

Mr. J. W. Clark reports that the collection acquired from Dr. Dohrn, exhibited at the Fisheries Exhibition, turns out much more valuable than was anticipated, there being 283 species of Invertebrates, and 38 of fishes in it, each being usually represented by several specimens. All are in first-rate order, and exceptionally good specimens. Mr. H. B. Brady has announced his intention of presenting all his valuable collections of Rhizopoda, chiefly Foraminifera, to be forwarded as the monographs relating to them are completed. Large instalments have already arrived, including the collection of British brackish-water and estuarine forms described in *Ann. and Mag. Nat. Hist.*, 1870, the North Polar Foraminifera from the Nares Expedition, the Carboniferous and Permian Foraminifera ("Pal. Soc. Monograph"), a large series of the genus *Fusulina*, a collection of the genera *Nummulites* and *Orbiloides*, numerous specimens of *Loftusia* and *Parkeria*, *Nummulites* from Egypt, and microzoic rocks illustrating the extent to which Foraminifera are concerned in the building of geological strata.

Mr. Cooke, Curator in Zoology, has catalogued and arranged the specimens of *Murex*, *Purpura*, *Triton*, *Fasciolaria*, *Buccinum*, *Nassa*, *Fusus*, *Voluta*, and *Mitra*, and related genera.

Mr. Hans Gadow, Strickland Curator, has been occupied in arranging the collection of birds' skins in a systematic way, and preparing to exhibit the groups in a complete manner, skins, skeletons, viscera, nests, and eggs, in juxtaposition, but want of space, cases and drawers, is a great hindrance. Valuable donations of birds' skins have been received from Major H. W. Feilden (Natal), Lady Barkly (Penang), and Mr. C. E. Lister (St. Vincent, Antilles), and in exchange from the Australian Museum, Sydney (New Guinea species).

The Morphological Department records good progress; many diagrams and models have been added owing to the liberality of Trinity College, and much valuable material has been brought by students who have visited foreign countries for purposes of morphological research. The Balfour Library is of great value, and Mr. A. J. Balfour, M.P., is defraying the cost of continuing the periodicals. Twelve students have been engaged in research; seventeen have worked in the advanced class; forty-four worked at embryology last year, while nearly fifty have worked at Elementary Morphology during the past winter. Overwhelming pressure has been put upon the department owing to the new arrangements for Elementary Biology in the M.B. examinations; 201 students entered it last term, belonging to more than one year, and no lecture-room or work-room has proved adequate for them all. The work of research, storage of material, and administration of classes are much interfered with by want of suitable rooms, and new rooms are urgently needed. A bust of Prof. Balfour, executed in bronze by Hildebrandt of Florence, has been presented to the Laboratory by Prof. Darwin and Mr. J. W. Clark.

Prof. Michael Foster reports that the teaching of Physiology has been still further developed, but has suffered somewhat from the necessary use of the Laboratory by the class of Elementary

**Biology.** The generous gift by an anonymous donor of 500l. towards new apparatus has been a great boon. A gas-engine and many valuable pieces of apparatus have been added.

Prof. Macalister states that the number of students dissecting has been nearly one hundred, and a still larger number attended the lectures on Human Anatomy. Many important specimens have been presented to the Museum of Human Anatomy by Prof. Macalister.

The Philosophical Library is increasingly used, and many valuable donations of books have been received by Mr. J. W. Clark, Prof. Humphry, Prof. Bahington, Mr. D. McAlister, and Mr. Pitman of Bath.

### SCIENTIFIC SERIALS

*American Journal of Science*, May 1884.—Remarks on Prof. Newcomb's "Rejoinder," in connection with his review of "Climate and Time," by Dr. James Croll.—Communications from the United States Geological Survey, Rocky Mountain Division, VI.—On an interesting variety of Löllingite and other minerals (one illustration), by W. F. Hillebrand. Amongst the ores analysed by the author there is one from the Missouri Mine, Park County, Colorado, which he thinks may probably be a new mineral. It is composed largely of a sulphobismuthite of copper and silver, and occurs in a quartz gangue associated with chalcopyrite and wolframite.—Notes on American earthquakes, with tabulated record of seismic disturbances in every part of the continent during the year 1883, by Prof. C. G. Rockwood.—Thermometer exposure, by H. A. Hazen. The paper is chiefly occupied with questions relating to the locality in large regions where the thermometer should be exposed in order to obtain the most trustworthy results, and to the immediate environment of the thermometer best calculated to fulfil the same requirement. There are several comparative tables of results obtained with various instruments under varying conditions of time, aspect, and altitude.—Hillocks of angular gravel and disturbed stratification associated with glacial phenomena (four illustrations), by T. C. Chamberlain. The paper deals especially with the kames or eskers analogous to the osars of Sweden, occurring in various parts of New Hampshire, Massachusetts, New York, and Wisconsin. The author infers from their inherent characteristics and their association with morainic belts, that the gravel hills in question were formed, not by beach action, but by numerous marginal streams along the edge of the great ice sheet during the Glacial period.—Extinct glaciers of the San Juan Mountains, Colorado, by R. C. Hills.—On the gender of names of varieties and subspecies in botanical nomenclature, by Asa Gray.—On secondary enlargements of feldspar fragments in certain Keweenaw sandstones (four illustrations), by C. A. Vanhise.—Principal characters of American cretaceous Pterodactyls, part i., the skull of Pteranodon (with plate), by Prof. O. C. Marsh. The skull of these Pterodactyls from the Middle Chalk, West Kansas, is described as differing from that of other known Pterosauria in the absence of teeth and of anterior nasal apertures distinct from the ant-orbital openings; in the presence of the elongated occipital crest; lastly, in the whole jaws, which appear to have been covered with a horny sheath, as in recent birds. All belong to the genus Pteranodon, some of the species of which were of prodigious size, with a spread of wings of about twenty-five feet. Remains of over six hundred individuals are now in the museum of Yale College.

*Journal of the Russian Chemical and Physical Society*, vol. xvi., fasc. 2.—On the action of the bromide of aluminium on ethylene and on the bromides of saturated hydrocarbons, by M. Gustavson.—On the specific heat of solutions, and on the thermal effects at their formation, by W. Alexeyeff. Submitting to a closer investigation those solutions which are accompanied by a lowering of temperature, the author comes to the conclusion that such is the case for those liquids which have not a chemical affinity, and that those are true solutions; while in those cases where a rise of temperature is noticed, the dissolved liquid enters into chemical combination with the dissolving one. He makes a series of very interesting experiments in order to determine the thermal effects of various solutions.—On the relations between the chemical composition and the refractive power of chemical compounds, by J. Kanonnikoff (second paper).—On the structure of nitro-compounds of the saturated series, by J. Kissel.—On the composition of the mineral waters of Caucasus, by J. Barilovsky.—On the structure of the blue

indigo, by P. Alexeyeff.—On the action of alkalies on chondrine, by M. Schwarz.—On the azocuminic acid, by P. Alexeyeff (first paper).—On chemical affinity, by A. Bazaroff.—Analysis of the epidermis attacked by the *Prosyarsis rubra*, by K. Wagner.—On the preparation of pure albumin, and on the determination of chlorine in urine, by W. Mikhailoff.—On the structure of the atmosphere and on the general laws of the theory of gases, by E. Rogovsky. The strong mathematical inquiry of the author brings him to the following conclusions:—However the atmosphere has no limits, but at a height of 1000 km. the density of air is very near to zero; its constitution varies with the height, the content of oxygen decreasing as the height increases; this change is very slow for heights less than 10,000 m., still it might be ascertained by accurate measurements; for heights less than 10,000 m. the density of air can be calculated as if it were a simple gas; the decrease of density with the height goes on slower when the temperature at the surface of the earth is higher. The paper has to be continued.—On the theory of measurements, by N. Sloughinoff.—On galvanic batteries, by P. Novikoff.

*Rivista Scientifico-Industriale*, March 31 and April 15.—Electric currents through contact with earth, by Prof. A. Volta.—Experiments with electrified paper, by D. Surdi.—Variations in the electric resistance of solid and pure metallic wires, with variations of temperature, by Prof. Angelo Emo.—On the Gauthier and Walrand methods of distinguishing steel from iron, by the editor.—Note on two hybrids of *Anas boschas* and *Dafila acuta*, by Dante Roster.

*Remediconi del R. Istituto Lombardo*, April 3 and 17.—Programme of prize essays in various departments of Science, Art, and Letters proposed for the years 1884-91.—The Castle of Milan, its historic and artistic associations, by Prof. Giuseppe Mongeri.—On some unpublished fragments of Anatolius's Greek version of the "Codex Justinianus," by Dr. C. Ferrini.—Note on Virgil and his Italian imitator, Parini, by Prof. Cr. Fabris.—On Antonio Angeloni Barbiani and his literary productions, by E. B. Prina.—Analysis of the mineral waters of Acquarossa, Canton of Ticino, by Prof. G. Bertoni.—Malformations in the urinary ducts in Bright's disease, by Prof. C. Golgi.—Meteorological observations made at the Brera Observatory, Milan, during the month of March.

### SOCIETIES AND ACADEMIES

#### LONDON

**Royal Society**, May 1.—"Report to the Solar Physics Committee on a Comparison between Apparent Inequalities of Short Period in Sun-spot Areas and in Diurnal Temperature Ranges at Toronto and at Kew." By Balfour Stewart, M.A., LL.D., F.R.S., and William Lant Carpenter, B.A., B.Sc. Communicated to the Royal Society at the request of the Solar Physics Committee.

It has been known for some time that there is a close connection between the inequalities in the state of the sun's surface as denoted by sun-spot areas and those in terrestrial magnetism as denoted by the diurnal ranges of oscillation of the declination magnet; and moreover the observations of various meteorologists have induced us to suspect that there may likewise be a connection between solar inequalities and those in terrestrial meteorology.

This latter connection, however (assuming it to exist), is not so well established as the former, at least if we compare together inequalities of long period. It has been attempted to explain this by imagining that for long periods the state of the atmosphere as regards absorption may change in such a manner as to cloak or diminish the effects of solar variation by increasing absorption when the sun is strongest, and diminishing absorption when the sun is weakest.

On this account it seemed desirable to the authors to make a comparison of this kind between short-period inequalities, since for these the length of period could not so easily be deemed sufficient to produce a great alteration of the above nature in the state of the atmosphere.

The meteorological element selected for comparison with sun-spots was the diurnal range of atmospheric temperature, an element which presents in its variations a very strong analogy to diurnal declination-ranges.

There are two ways in which a comparison may be made between solar and terrestrial inequalities. We may take each

individual oscillation in sun-spot areas, and find the value of the terrestrial element corresponding in time to the maximum and the minimum of the solar wave. If we were to perform this operation for every individual solar inequality, and add together the results, we might probably find that the magnetic declination range was largest when there were most sun-spots. If, however, we were to make a similar comparison between sun-spot daily areas and diurnal temperature-ranges we might not obtain a decisive result. For at certain stations, such as Toronto, it is suspected (the verification or disproof of this suspicion being one of the objects of this paper) that there are two maxima and two minima of temperature-range for one of sun-spots. The effect of this might be that in such a comparison the temperature-range corresponding to a maximum of sun-spots might be equal in value to that corresponding to a minimum, or, in other words, we should get no apparent result, while, however, by some other process proofs of a real connection might be obtained. But if we can get evidences of apparent periodicity in sun-spot fluctuations when dealt with in a particular manner, we have at once a method which will afford us a definite means of comparison. And here, as Prof. Stokes has pointed out, it is not necessary for our present purpose to discuss the question whether these sun-spot inequalities have a *real* or only an *apparent* periodicity. All that is needful is to treat the terrestrial phenomena in a similar manner, or in a manner as nearly similar as the observations will allow, and then see whether they also exhibit periodicities (apparent or real) having virtually the same times as those of sun-spots, the phases of the two sets of phenomena being likewise allied to one another in a constant manner.

It is such a comparison that the authors have made, their method of analysis being one which enables them to detect the existence of unknown inequalities having apparent periodicity in a mass of observations. A description of this method has already been published in the *Proceedings of the Royal Society* for May 15, 1879. The comparison was made by this method between sun-spot observations extending from 1832 to 1867 inclusive, Toronto temperature-range observations extending from 1844 to 1879 inclusive, and Kew temperature-range observations extending from 1856 to 1879 exclusive. The following conclusions were obtained from this comparison:—

1. Sun-spot inequalities around twenty-four and twenty-six days, whether apparent or real, seem to have periods very nearly the same as those of terrestrial meteorological inequalities as exhibited by the daily temperature-ranges at Toronto and at Kew.
2. While the sun-spots and the Kew temperature-range inequalities present evidence of a single oscillation, the corresponding Toronto temperature-range inequalities present evidence of a double oscillation.
3. Setting the celestial and terrestrial members of each individual inequality, so as to start together from the same absolute time, it is found that the solar maximum occurs about eight or nine days after one of the Toronto maxima, and the Kew temperature-range maximum about seven days after the same Toronto maximum.
4. The proportional oscillation exhibited by the temperature-range inequalities is much less than the proportional oscillation exhibited by the corresponding solar inequalities.

**Chemical Society, May 15.**—Dr. Perkin, F.R.S., president, in the chair.—The following papers were read:—On refraction equivalents of organic compounds, by Dr. J. H. Gladstone. In this paper is given a series of tables embodying the results of observations made from time to time since 1870. In these tables the refraction equivalents for the line A for about 140 substances are given and compared with the refraction equivalents calculated from the following values of the respective elements:—Carbon (saturated) 5.0, carbon in  $C_nH_n$ , 5.95, carbon double-linked 6.1, hydrogen 1.3, oxygen single bond 2.8, oxygen double bond 3.4, nitrogen 4.1, nitrogen in bases,  $NO_2$ , &c., 5.1, chlorine 9.9, bromine 15.3, iodine 24.5, sulphur single bond 14.1, sulphur double bonds 16.0.—On the estimation of silicon in iron and steel, by T. Turner. The author has compared the various methods of analysis, and concludes that the chlorine process suggested by Watts, with certain modifications, is applicable to all classes of iron, and is on the whole the best.—Note on the melting-points and their relation to the solubility of hydrated salts by Dr. W. A. Tilden.—Note on ferric sulphocyanate, by A. J. Shilton. The author finds that a large excess of potassium sulphocyanide or of boiling hydrochloric acid interferes with the well-known blood-red colour given by ferric salts and a sulphocyanide.—A

memoir detailing some minor researches on the action of ferrous sulphate on plant life, by Dr. Griffiths. The author finds that 0.15 per cent. of ferrous sulphate added to a solution of various salts aids, whilst 0.2 per cent. is fatal to, the development of mustard seeds and cabbage plants.

**Physical Society, May 10.**—The meeting was held in the chemical theatre of the Mason College, Birmingham. Members had previously visited some of the factories in the town, including Gillott's pen works.—Dr. Guthrie, president, took the chair at three p.m., when Prof. J. H. Poynting made a communication on an experiment illustrating the refraction of water-waves. The experiment was designed to illustrate by means of waves in water the refraction of waves when they pass from one medium to another in which their velocity is different. The apparatus consisted of a tank 2 feet 6 inches square, with a plate-glass bottom. Water is poured into the tank to a depth of say 5 to 6 mm. The lid of the tank consists of a calico screen, and is slightly tilted up. A limelight under the tank projects the wave on a screen. Plates of glass 3 or 4 mm. thick are placed in the tank, thus reducing the depth of water. If waves are sent across the tank they travel more slowly through the shallow water, and are seen to be refracted. When circular or lenticular plates are used, the refracted waves are seen to converge to a focus.—Mr. C. J. Woodward exhibited an oxy-hydrogen lantern suitable for lecture purposes.—Dr. Gladstone took the chair, and Prof. Guthrie, president, exhibited a sealed tube containing 46.6 of tri-ethylamine, and 53.4 of water. At temperatures between 0° C. and 18.3° C. the liquid forms a clear mixture. At 18.3° it becomes turbid, and at 26° C. almost perfect separation is effected. It was stated that all proportions of the two liquids containing about 15 per cent. and 50 per cent. of triethylamine become turbid at the same temperature. A mixture containing 4 per cent. requires a temperature of 41° C. to produce turbidity, while one containing 90 per cent. is turbid at 6° C. A series of sealed glass bulbs containing the liquids in different proportions can be employed to indicate the fever temperature of the body if placed under the tongue. The author also showed the connection between such separation by heat and the separation between the same two bodies by cold, whereby in the latter case, according to the strength of the solution, either ice or subcryohydrate is separated, until the composition and temperature of the cryohydrate is reached (19.2 per cent.; -3.8° C.). The peculiar white condensed vapour of the chloride of triethylammonium was exhibited. The white fume of this body so quickly aggregates into masses, that the shapes of the smoke-lines and curls are preserved. Dr. Gladstone agreed with the author in supposing that the separation of triethylamine and water was continuous in nature with the separation of ammonia from water by heat. Dr. Tilden exhibited a tube containing a cold, clear solution of amyl alcohol in water which became turbid on gently warming, and clear again on heating to about 60° C. He suggested that a similar remixing might take place with ethylamine and water. Prof. Silvanus P. Thompson recalled the experiments of Prof. Ramsay on the critical state described by Andrews, and the failure of a body beyond the critical condition to retain in solution the substances it held as a liquid. Mr. W. Lant Carpenter suggested the microscopic examination of the triethylamine and water mixture at its critical temperature.—Members then visited the College rooms.

**Royal Microscopical Society, May 14.**—Rev. W. H. Dallinger, F.R.S., president, in the chair.—A resolution was passed altering the by-laws so as to make ladies eligible as Fellows of the Society, but without the right of attending ordinary meetings.—Dr. Golding Bird exhibited a new freezing microtome of his construction, adapted for students and intermittent workers, and for use with ice and salt, or with ether.—Mr. Boecker showed an extensive series of Bacteria, Bacilli, and other Schizomycetes.—A very curious microscope of the date of 1772 was exhibited by Mr. Crisp, in which, with other peculiarities, three objectives were attached to a sliding plate at the end of the nose-piece in a way similar to that adopted in the modern Harley and other microscopes. Also two microscopes by Reichert of Vienna, one with a very simple form of Abbe condenser, and the other with a polarising prism attached to a swinging and rotating diaphragm.—The following apparatus and objects were also exhibited and discussed:—Frog plate made of glass, with serrated edges for the string; Griffiths' multiple eyepiece (an attempt to combine four eyepieces in one by fixing different eye-lenses in a rotating disk); Bradley's "mailing boxes" for sending one or several slides conveniently



by post; Dancer's objects found in flue-dust and coal-ash; Stokes' minnow-trough; B. W. Thomas's Foraminifera obtained by washing clay from the boulder drift in Minnesota, showing forms identical with some now found living in the Atlantic Ocean; some exceptionally well mounted slides of arranged Diatoms by R. Getschmann of Berlin; some curious Schizomycetes by Mr. Cheshire, and a rotalian from closed flint nodular cavity metamorphosed into chalcedony, by Dr. G. C. Wallich.—Dr. P. H. Carpenter gave an account of his views respecting the nervous system of the Crinoidea, and exhibited some preparations in illustration of them. He directed attention more particularly to the branches from the axial cords of the skeleton, which extend upwards into the ventral perisome at the sides of the ambulacra, both of the arms and of the disk.—The President, Mr. Glaisher, vice-president, and Mr. A. W. Bennett, a member of the Council, were appointed a deputation for the Society, to attend the annual meeting of the American Society of Microscopists at Rochester, N.Y., U.S.A., on August 19 next.

**Royal Meteorological Society**, May 21.—R. H. Scott, F.R.S., president, in the chair.—Capt. W. W. Hampton and C. D. F. Phillips, M.D., F.R.C.S., F.R.S.E., were elected Fellows of the Society.—The following papers were read:—Notes on the proceedings of the International Polar Conference held at Vienna, April 17 to 24, 1884, by R. H. Scott, F.R.S., president.—Meteorological observations on the Maloja Plateau, Upper Engadine, 6000 feet above the sea, by Dr. A. T. Wise. The Maloja Plateau is situated at the higher extremity of the Upper Engadine, and is protected from northerly, easterly, and southerly winds. The author gives some account of the meteorology of this plateau, and also the observations made during the four months from November 1883 to February 1884.—On some results of an examination of the barometric variations in Western India, by A. N. Pearson.—Illustrations of the mode of taking meteorological averages by the method of weighing paper diagrams, by R. Inwards, F.R.A.S.—Ten years' weather in the Midlands, by Rupert T. Smith.

## EDINBURGH

**Royal Society**, May 5.—Mr. Robert Gray in the chair.—Dr. Sang gave a paper on the formulae for computing logarithmic sines.—Mr. J. Murray communicated a paper, by Mr. J. T. Cunningham, on a new Trematode.—Mr. George Seton read a paper on the vital statistics of Scotland; and Prof. Turner gave a communication, by Mr. A. Wynter Blyth, on the results of experiments made by him on the chief disinfectants of commerce. His object in experimenting was to discover their efficiency in destroying the spores of *Anthrax bacillus*.

May 19.—Mr. Robert Gray, vice-president, in the chair.—Prof. Chrystal communicated a note, by M. Hermite, "Sur la Reduction des Intégrales Hyperelliptiques."—Prof. Schuster, at the request of the Council of the Society, gave an address on the discharge of electricity through gases. His address was illustrated by several beautiful experiments.

## PARIS

**Academy of Sciences**, May 19.—M. Rolland, president, in the chair.—Note on a theorem of M. A. Lindstedt concerning the problem of the three bodies, by M. F. Tisserand.—On bromic substitutions, by MM. Berthelot and Werner.—Kinematic analysis of the action of walking in man (four illustrations), by M. Marcy.—Note on the twenty-three first sheets of the map of Africa to the scale of 1:2,000,000, presented by Col. Perrier to the Academy, by M. F. Perrier. The map, which is mainly the work of Capt. de Lannoy, will consist altogether of sixty-two sheets, and is expected to be completed towards the end of 1887.—Pathological experiments on rabies, by M. Pasteur, assisted by MM. Chamberland and Roux.—Note on the attenuation of cultivated virus treated with compressed oxygen, by M. A. Chauveau.—Note on the transformation of conicine to propylpyridine; regeneration of conicine, by M. A. W. Hofmann.—Observations on the new planet 236 (discovered at Vienna, by M. J. Palisa, on April 26, 1884), made at the Paris Observatory (equatorial of the west tower), by M. G. Bigourdan.—Determination of the elements of rotation of the sun, by M. Spörer.—Properties of nine points of a left curve of the fourth order, of seven points of a left cubic, of eight associated points, by M. A. Petot.—On a linear equation of the third order analogous to Lamé's equation, by M. E. Goursat.—Remarks relative to the velocity of propagation of the wave produced in the Indian

Ocean by the Krakatoa eruption, by M. Boussinesq.—Adoption by the Vienna International Polar Conference of new absolute magnetic unities (centimetre, gramme, second), by M. Mascart.—New method of measuring the intensity of an electric current in absolute unities, by M. Henri Becquerel.—Note on a new mercurial galvanometer, by M. G. Lippmann.—On the variations of the physical properties of bismuth placed in a magnetic field, by M. Hurion.—On the coefficients of expansion in the elementary gases, by M. J. M. Crafts.—On the various theoretic results that have to be considered in steam engines, by M. P. Charpentier.—On the transmission of sound by gases, by M. Neyreneuf.—Note on the variation of the indices of refraction of quartz under the influence of temperature, by M. H. Dufet.—On the determination of the densities of vapour by gaseous displacement under reduced and variable pressure, by M. J. Meunier.—Action of the sulphuret of potassium on the sulphuret of mercury, by M. Debray.—On the acid phosphates of baryta, by M. A. Joly.—On the solubility of salts, by M. Etard.—Note on crystallised chloride of ammoniacal silver and iodide of ammoniacal silver, by M. Terreil.—On an artificial pseudomorphosis of silica, by M. A. Gorgeu.—Analysis of the mineral waters of Brucourt, Calvados (Normandy), by M. Vulpian.—On the employment of superphosphates in agriculture; observations in connection with a recent note of M. Lechartier, by M. P. P. Déhérain.—Comparative nitrifying action of some salts either naturally contained in or superadded to vegetable soils, by M. P. Pichard.—A new series of experiments on the differential perception of colours, by M. Aug. Charpentier.—Note on the brain of *Eunice harassii* and its relations to the hypoderm, by M. Et. Jourdan.—On the genus *Rhopalea* (simple Ascidians), by M. L. Roule.—On the presence of the Egyptian *Naja* (*Naja haje*, Dumer.) in Tunis, by M. Valéry Mayet.—Pretended influence of light on the anatomic structure of the leaves of *Allium ursinum*, by M. Ch. Musset.—Remarks on a hypsometric map of Russia, by General de Tillo.—On the remarkable solar halo recently observed at Palermo, by M. A. Ricco.—Fresh observations on the crepuscular lights seen in the Isle of Bourbon, by M. Pclagaud.

## CONTENTS

	PAGE
The Dilution of Dog Poison . . . . .	97
The Mammalia of India and Ceylon . . . . .	98
North American Mollusca. By Dr. J. Gwyn Jeffreys, F.R.S. . . . .	99
Our Book Shelf:—	
Step's "Plant-Life" . . . . .	99
Letters to the Editor:—	
The Equatorial Coudé of the Paris Observatory.—	
Howard Grubb, F.R.S. . . . .	100
The Earthquake.—H. C. Sorby, F.R.S.; Antoine d'Abbadie; A. Shaw Page . . . . .	101
Instinct in Birds.—R. S. S. . . . .	102
A Remarkably Brilliant Meteor.—Rev. John Hoskyns-Abraham . . . . .	102
Right-sidedness.—E. H. . . . .	102
Modern Travel—A Scientific Education . . . . .	102
The Late Monsieur Wurtz . . . . .	103
Robert Angus Smith. By Prof. T. E. Thorpe, F.R.S. . . . .	104
Norwegian Geodetical Operations . . . . .	105
Saturn ( <i>Illustrated</i> ) . . . . .	105
Earth Currents . . . . .	106
Notes . . . . .	107
Geographical Notes . . . . .	109
The Movements of the Earth, IV. By J. Norman Lockyer, F.R.S. ( <i>Illustrated</i> ). . . . .	110
The Royal Commission on Technical Instruction . . . . .	113
On the Nomenclature, Origin, and Distribution of Deep-Sea Deposits, II. By John Murray and Rev. A. Renard . . . . .	114
University and Educational Intelligence . . . . .	117
Scientific Serials . . . . .	118
Societies and Academies . . . . .	118

THURSDAY, JUNE 5, 1884

*THE ORIGIN OF THE CRYSTALLINE  
SCHISTS*

*Untersuchungen über die Entstehung der Altkrystallinischen Schiefergesteine mit besonderer Bezugnahme auf das Sächsische Granulitgebirge, &c.,* von Dr. Johannes Lehmann. (Bonn: Hochgürtel, 1884.)

NO problem in modern geology stands out with such prominence as the origin of that remarkable group of rocks to which the name of the Crystalline Schists has been given, and to none in recent years has so large a share of the literature of the science been devoted. The question is attacked on all sides. By some observers its solution is sought in laborious investigations of the hilly and mountainous regions where these rocks hold their empire among the grander solitudes of nature. By others the question is studied in the quiet of their own libraries or laboratories with all the resources of modern chemistry and microscopy. Great progress has indeed been made in these various ways. Regarding certain aspects of the problem a general agreement has been arrived at; but there are others as to which the difficulties remain as persistently obstructive as ever.

One of the most important contributions to the study of this fascinating subject has just appeared in the form of a handsome quarto volume, with a large atlas of plates, by Dr. J. Lehmann. This author has enjoyed exceptional opportunities of qualifying himself for the task he has now undertaken. For nine years, as a member of the Geological Survey of Saxony, he was engaged in the investigation of the classical granulite-region of that kingdom, of which he surveyed the southern and rather larger half, while his colleague, Mr. E. Dathe, investigated the northern part. The maps of this Survey are accompanied with explanatory pamphlets, among which Dr. Lehmann's detailed local observations have already been published. But it was desirable to present a generalised description of the whole region and to discuss the bearings of the observations upon theoretical questions. He originally proposed to undertake this task in association with Mr. Dathe; but his transference to Bonn as Privat-docent in Mineralogy and Geology, and the removal of his friend to the Prussian Geological Survey, having prevented the intended cooperation of the two observers, Dr. Lehmann has himself worked up the mass of materials collected during his long course of work in the field. To enlarge the scope of his inquiries and obtain additional data for comparison he has recently extended his investigations into the Erzgebirge, Fichtelgebirge, and the mountains of the Bavarian and Bohemian frontier. And he now offers what we may hope is only a first instalment of his results.

Naumann, whose early account will always be cited as a model of careful observation and accurate description, regarded the granulite of Saxony as an eruptive rock—an opinion in which he has still modern followers, including our author himself. He recognised a fact which seems in more recent times to have been lost sight of,

that a gradation can be traced from the more highly crystalline condition of the granulite centre, through successive zones of mica-schist, and other schists, into the older sedimentary rocks of the surrounding districts. These schistose rocks have in more recent times been classed as "Archæan," and as such they appear on the maps of the Saxon Geological Survey, Dr. Lehmann having himself accepted this view in his earlier published descriptions. But more extended study of the subject has induced him to abandon the idea of the existence of any Archæan nucleus and to return to a modification of the original conception of Naumann. How he has been led to this conclusion it is the object of his volume and atlas to show.

Under the deep cover of post-Tertiary deposits, the granulite tract of Saxony forms a central ellipse round which zones of various schistose rocks are grouped, that pass outwards into the normal clay-slates of that part of Germany. These slates on the south-eastern margin are unconformably overlaid by Silurian and Carboniferous rocks. On the north-west side a conformable sequence is traceable from the schists and slates upwards into Cambrian and Lower Silurian rocks, which are precisely like those of the adjacent countries. Instead of being Archæan masses, Dr. Lehmann concludes that the whole of the crystalline schists within the granulite area are metamorphosed Palæozoic sediments. They may be originally of Silurian or Cambrian age, and their metamorphism probably took place during the crumpling and upheaval of the area, that is, later than the Devonian and older than the Carboniferous period.

Towards the establishment of this conclusion the author brings forward a vast mass of detail, which he skilfully arranges so that its bearings upon theoretical questions may be clearly seen. At the same time he endeavours to separate rigidly what is demonstrable fact from what is mere inference, and in this lies one of the most valuable features of his memoir. He has collected such a body of evidence as will give a new impetus to the study of metamorphism, while at the same time it provides abundant new and suggestive material for the prosecution of this study. He justly cites the Saxon granulite area as a classic example of the occurrence and origin of metamorphic schists where a complete gradation can be followed from unaltered or little altered sediments into wholly crystalline foliated masses. In this progressive intensity of metamorphism the most notable fact is the corresponding advance in the development of mica. Over and above all local diversities of mineral character, there is a constant augmentation in the quantity and size of the mica-folia. At the same time the muscovite, which is alone present in the outer parts of the area, is replaced further inwards by biotite. Nor is this change confined to the peripheral schists; it extends into the granulite of the centre. Such a rearrangement of the mineral constituents of the rocks cannot be explained by any hypothesis of an eruptive granitic mass. Like so many other concurrent facts, it points to the effects of the molecular movements of the original rocks, sedimentary or other, under the strain to which they were subjected during the process of crumpling and upheaval. Where these movements have been greatest, there the accompanying metamorphism has been most intense, and, as one prominent indication of this change, there is the

most abundant development of biotite. Every student of the crystalline schists can furnish parallel examples to those cited by Dr. Lehmann where, on the zigzag puckerings that form so striking a feature among these rocks, a copious growth of biotite or some other mica has taken place.

Among the metamorphosed rocks of the Saxon region some of the most instructive are bands of conglomerate interstratified among the schists. The sedimentary origin of these zones is of course unquestionable, and so obvious that the alteration to which they have been exposed furnishes a kind of sample of the initial stages of change which are so often lost where the clastic materials are of a less prominent and obdurate character. The pebbles of granite, quartz, &c., have been deformed and more or less altered, so that sometimes they seem to shade off into the surrounding matrix. The latter has become a crystalline micaceous mass by which the pebbles are wrapped round. These conglomerate bands have thus been converted into half-crystalline gneiss-like schists.

A specially important part of the memoir deals with Gabbros and Amphibolites. These rocks, as members of the series of crystalline schists, have long been a puzzle to those who have studied them in the field. That they are metamorphic rocks, and not rocks of original chemical precipitation, has been inferred from their association with masses whose original sedimentary origin admits of no doubt. But even those who have held this view have hesitated as to the nature of the original masses out of which they have come. Many years ago Jukes suggested that hornblende-rocks and hornblende-schists might represent ancient lavas and tuffs interstratified with the sediments which are now schists and quartzites. And it seems probable that this opinion is essentially correct. Dr. Lehmann goes into great detail regarding the structure of the diallage and hornblendic rocks of the granulite tract. His study of them leads him to conclude that the gabbro is an eruptive rock, younger than the granulite but older than the granite, which has been involved in the general metamorphism and has consequently assumed schistose modifications. "I know no rock," he adds, "which illustrates so well the effect of mechanical pressure upon a solid rock as the gabbro of the Saxon granulite tract. While other rocks leave us in doubt as to their original condition, the gabbro supplies us with every stage from the beginning to the end of the metamorphism." These conclusions possess at present a special interest in relation to the crystalline schists of this country. The Geological Survey, in the course of an investigation of the schists of the north of Scotland, has recently come independently to similar deductions with regard to the diorites and amphibolites of Aberdeenshire and Banffshire. Among the schists of that region there occur extensive masses of diorite. This rock presents sometimes the typical composition and structure of a diorite, and under the microscope appears as one of the most beautiful examples of a thoroughly crystalline granitoid mass. It behaves in the field as an eruptive rock, which has risen generally parallel with, but also transgressive across, the bedding of the contiguous schists. It is obviously from these characters a mass that has been intruded into the clay-slates, knotted-schists, and other schists of the district. Being traversed by veins and bosses of granite, its protrusion

was obviously earlier than that of some at least of granite. Further examination of it, however, shows in many places it presents a remarkable parallelism in arrangement of its crystalline constituents. Sometimes this is shown by the orientation of the feldspars in definite direction. In other places the feldspar and hornblende are drawn out into more or less distinct bands. Further stages of change reveal the feldspar segregated into an almost pure labradorite rock, while the hornblende appears as a felted mass of hornblende-schist. Some of these schistose aggregates are of exquisite beauty. Over wide tracts biotite has been abundantly developed in the diorite, and sometimes also numerous and large kernels of garnet. It is observable that the direction of the foliation of the diorite coincides with that of the surrounding schists. There seems no reason to doubt that, as these Scottish schists are metamorphosed Lower Silurian sediments, the diorites and amphibolite-schists represent Palæozoic eruptive rocks that have participated in the general metamorphism. Dr. Lehmann recognises, in the Mica-schist and Phyllite groups, hornblende-schists which he thinks may have been embedded masses of diabase that have been more or less altered.

His general conclusions are thus summed up:—"I cannot regard the metamorphic schists (mica-schists, gneisses, &c.) as 'Archæan' formations. It does not appear to me to be established that genuine gneisses anywhere came out of pre-Cambrian sediments. The production of such rocks as mica-schist, &c., belongs to the time of mountain-upheaval, and in actual fact has involved formations of far younger age than the Cambrian. In the Saxon granulite region it is later than the Devonian period." He draws a distinction between what he considers to be "true gneisses" and other rocks to which the general name of gneiss has been applied. He restricts the appellation to the foliated forms of granite. This foliated or true gneissic structure he believes to be more or less due to metamorphism by stretching, seldom wholly original, so that many gneisses may be called metamorphic; only, the original rock was not a sediment but a mass that consolidated from fusion (Erstarrungsgestein). We fear that a theoretical distinction of this kind will involve all kinds of practical difficulties in its general application.

Reference must be made to the atlas that accompanies the memoir. It contains 28 plates, on which are placed no fewer than 159 photographs of thin sections of the rocks described in the text. Unlike the usual illustrations of this kind, these photographs represent the objects of the natural size, or less, or at most only slightly magnified. They are not microscopic studies, but show the actual structure of the rocks as seen by the naked eye or with a weak lens. It is impossible to speak too highly of the success with which they have been produced. With their aid we are rendered in some measure independent of the actual specimens, and can follow with pleasure and satisfaction the detailed descriptions of the author. No such wealth of accurate illustrations has yet been furnished for the study of this important series of rocks. Dr. Lehmann, however, is, we hope, only on the threshold of his inquiries. A vast domain lies before him where the problems are many and the qualified observers are but few. He has done excellent service by presenting in this compendious form such

an array of facts as a trained geologist can gather in the field, and by boldly announcing the conclusions to which the study of these facts has led him. But much more may be made of them than he has yet given us. And we trust he may be encouraged to continue the investigation he has so well begun.

ARCH. GEIKIE

### LETTERS TO THE EDITOR

[The Editor does not hold himself responsible for opinions expressed by his correspondents. Neither can he undertake to return, or to correspond with the writers of, rejected manuscripts. No notice is taken of anonymous communications.]

[The Editor urgently requests correspondents to keep their letters as short as possible. The pressure on his space is so great that it is impossible otherwise to insure the appearance even of communications containing interesting and novel facts.]

#### The Marine Biological Association

WILL you allow me space to ask all naturalists and lovers of science who intend to become members of the above Association to send their names and subscriptions *without delay* to Mr. Frank Crisp, 6, Old Jewry, London, E.C. The subscription is one guinea annually, or fifteen guineas for life membership. It is highly desirable that intending members should at once enrol themselves, since the first meeting of the Association for the election of officers and council for the year 1884-85, and for the ratification of by-laws, will be held in London at the end of this month, when Prof. Huxley will be nominated as President. Donations, whether large or small, are earnestly solicited. Those who are interested in the natural history of marine plants and animals, and who foresee the immense help to this study which a well-equipped laboratory will afford, are begged not only to give some pecuniary aid to the present enterprise, but to constitute themselves agents of the Association and to do their best to persuade others to contribute to the fund required for building the first biological laboratory on the English coast. It is only by hearty and earnest support of this kind that our object can be realised.

I may add that several naturalists have contributed each 100*l.* to the Association, others 25*l.*, and others less, according to their means and their sympathy with our object. Of the 10,000*l.* required, we have not yet obtained half.

E. RAY LANKESTER,  
Secretary (*ad interim*)

11, Wellington Mansions, North Bank, N.W.

#### The Equatorial Coudé of the Paris Observatory

IN continuation of my first letter I now proceed to answer M. Lœwy's second letter, as published in your issue of May 15 (p. 52).

M. Lœwy has not, as I said in that former letter, raised a single objection which had not already been anticipated and discussed with the exception of one which I shall treat of further on. The several points in this letter I shall dispose of very shortly.

1. As to the dialyte construction, I have to reply that that particular method of achromatising the objective is not an *essential* feature of this instrument. Whether it be adopted or not is in fact much a question of *cost*. If the purchaser desires to get the largest possible aperture at least expense, then I would make it a dialyte, for, notwithstanding all M. Lœwy says, good work can be and has been done with dialytes. If, however, the most perfect instrument is desired, I would dispense with the dialyte construction, and achromatise the object-glass in the ordinary way, which is quite as applicable to my construction of equatorial as is the dialyte. If I mistake not, the celebrated observer M. Dembowski observed for many years with a dialyte, and spoke highly of it; he says: "*L'achromatisme est excellent*." Again, the present director of the observatory, for whom the first of these instruments is to be made, has worked already with dialytes, and he would not be likely to recommend this construction if his experience agreed with M. Lœwy's. I desire to notice just one further point in this part of M. Lœwy's letter, as it is another example of how his own words (unintentionally, no doubt) confirm my statements. He says (speaking of the limited field of view of dialytes): "But, in order to turn the difficulty, he" (Mr. G.) "suggests that since the field of view

becomes smaller as the instrument becomes larger, we may content ourselves with observing at a central point." I never said this; my words were: "The definition at the edge of the field, however, is not so good as in the ordinary form, but this would not be of so much consequence in large instruments, as the field in such cases is never of great extent." And M. Lœwy himself corroborates this for me when he says: "For the observation of comets I have such an eyepiece, which magnifies fifty times, and has a field of view such that I can observe a degree (*i.e.* with the 12" equatorial *coudé*); for a telescope of 27 inches we might have such an eyepiece with a field of 24 minutes." Thus I have a distinct corroboration from M. Lœwy of what I said above.

2. Writing on the matter of stability, M. Lœwy curiously mixes up stability and accuracy of movement. Now while I claim that I can and will obtain greater stability in my form than exists in M. Lœwy's, I do not claim accuracy of movement, but on this point I propose to say very little at present for several reasons. In the first place, it would hardly be possible to discuss this and put it in an intelligible form to your readers without a careful drawing; secondly, the well-known stability of the instruments which have emanated from my workshops are quite sufficient guarantee that this point is not one likely to be neglected in any of my work; and thirdly, I find it utterly impossible to understand the sentences of M. Lœwy's paper bearing on this point, and if I, though familiar with the proposed construction, fail to understand them, I am hopeless of serving any useful purpose by discussing them in your columns, particularly as few of your readers have ever seen the design of the instrument referred to. M. Lœwy talks of "all movements of transmission being broken at right angles." I do not know what he means, but he omits to tell your readers that, according to my design, in the larger sizes I propose that all movements be effected by two hydraulic cylinders the valves of which are within reach of the observer while sitting in his chair; so that, without more physical exertion than is necessary to open a water-tap, he has full command of all the movements of the great instrument, a pair of vertical scales on the walls of his study giving the approximate position of instrument in *AR* and declination, an arrangement eminently calculated to reduce the work of the observer.

3. Lastly, as to its want of universality. This is distinctly stated in my paper as a disadvantage of my form; but when M. Lœwy asserts that "it is based on a principle which no astronomer can admit, viz. that it is superfluous to observe the greater part of the northern heavens," it is evident that M. Lœwy has here gone too far, since that portion of the heavens within 20° of the Pole is only about 6 per cent. of the northern hemisphere. Ask any practical astronomer possessing a moderate-sized equatorial how many hours out of the total number of hours which he has worked in the year has his instrument been pointed to objects within 20° of the Pole, and, with the exception of a few who apply themselves to special work, the great majority will give a reply which will show how very little will be lost by the fact that this instrument cannot command that portion of the heavens. I have myself put this question to many, and with the result above mentioned. On this point I cannot do better perhaps than give an extract from a letter I have just received from the director of one of our public observatories:—"Instruments of large aperture are rarely if ever used for observations where extreme accuracy of measurements is required, such as annual parallax, nor for searching for nor observing comets, except to search along a known track for an expected periodical comet. This your instrument could do well. There is hardly an instrument in existence which is equally well adapted to all kinds of observations. The circumpolar zone of about 20° may be explored by other instruments, but for almost every kind of *systematic* work the remainder of the visible heavens will give plenty to do." The foregoing would be a sufficient answer to a question which M. Lœwy has put directly to me.

He says:—"Permit me to ask Mr. Grubb how he is going to study that part of the heavens which lies between 20° from the zenith and the Pole."

To any one who has seen my paper it will be evident that this point, which in M. Lœwy's letter is put forward as a discovery of his own, was already fully dealt with by me. I said: "The instrument commands the heavens from east to west and from south horizon to about 20° beyond zenith." And again: "As regards this instrument (*equatorial coudé*) I would observe that it possibly possesses an advantage over my form in being absolutely universal."

No doubt universality unaccompanied by such disadvantages as the equatorial *coude* possesses is very much to be desired, but I do not yet see how it is to be obtained. With respect to the solitary original objection that M. Lœwy has raised, viz. that the light reflected by the mirror varies with the different angles of inclination, and therefore renders the instrument unfit for photometric researches, I confess this objection did not occur to me before, and I am inclined to think M. Lœwy is right, and that my instrument will not be well adapted for photometric researches, but I ask: Is the equatorial *coude* any better? On consideration it will be evident to your scientific readers that the light after the first reflection is elliptically polarised, and if so the quantity reflected by the second mirror is variable at the various angles of declination; consequently photometric observations made with the equatorial *coude* cannot be relied upon.

In attempting to prove his case M. Lœwy gives in his first letter a considerable number of numerical details, and no doubt most of your readers have taken these figures as correct. I will ask them, however, to verify for themselves a few of them, and the result will, I think, show how very loosely M. Lœwy has put these data together. For instance, he mentions the weight of a 40-inch mirror, whose thickness is just one-sixth of the diameter, to be 380 kilos., and he calculates (see further down) that a mirror of 38 inches diameter and proportional thickness would weigh 280 kilos.—100 kilos. less. Now, if the thickness be proportional, the weight should be as the cube of the diameter. If your readers will try this themselves, they will find that M. Lœwy has in this case exaggerated the difference to the amount of about 100 per cent.

I find I omitted to notice just one point in Mr. Lœwy's first letter. He says:—"If Mr. Grubb had looked at the drawing which I published in the *Journal de Physique* of last year, he would have seen that it is almost identical with that which he has communicated to the Royal Dublin Society, so far as the general arrangements for sheltering the observer and instrument are concerned."

Permit me to inform M. Lœwy that this would hardly have been a novelty to me last year, inasmuch as I had such arrangements not only on paper but in actual work for some years back, and a description of the same was published in the Royal Dublin Society's *Proceedings*, April 1879.

Your readers will see from the foregoing that M. Lœwy's whole letter is based on a series of misconceptions of statements in my paper in the *Transactions* of the Royal Dublin Society.

Some of the mistakes that M. Lœwy has fallen into were perhaps due to the fact that the plate issued with the Royal Dublin Society's *Transactions* was merely a diagram without details, introduced to illustrate the principle of the mounting. He assumes that details not figured in the diagram are not to be provided, in spite of the fact that in the text of my paper I discussed several of them.

M. Lœwy occupies nearly half a column of NATURE in speaking of the labour involved in working this instrument, because no tube is shown in the diagram connecting the equatorial part with the ocular; all this trouble would have been saved if he had read my paper a little more carefully, for then he would have found that not only did I say, "In most cases it would be desirable to have a connecting tube," but I even discuss the best form of tube for the purpose. There are some special cases in which a tube would not be actually necessary.

It appears to me that M. Lœwy is very unnecessarily disturbed in his mind by the advent of my instrument. No doubt the equatorial *coude* and my siderostatic telescope have each their own sphere of work, and there may be room for both. An observatory having at its back a generous individual who (as was stated at a late meeting of the Royal Astronomical Society), has already expended a quarter of a million on astronomical observatories and is willing to spend more, can afford a large instrument perhaps on M. Lœwy's plan; but as all observatories are not equally fortunate, there may occasionally be one found which will be glad to get equally great optical power at one-third the cost.

I barely alluded in my last letter to this question of cost. On this point it may be desirable to supplement what I have said in my former letter, bearing in mind that the cost of the instrument will, as I have above stated, depend somewhat on whether or not the objective is achromatised on the ordinary principle or that of the dialyte.

In order to put the matter of cost in the clearest light, let us consider the four forms which we have at present to select from, viz. the ordinary equatorial, M. Lœwy's equatorial *coude*, my

siderostatic telescope with objective achromatised in the ordinary way, and the same instrument with objective achromatised on the dialyte principle.

Let us consider first what apertures we can obtain in the several forms for a given sum; assuming M. Lœwy's figures for the equatorial *coude*. For 1760*l.* can be obtained—

(a) Equatorial *coude* of 12-inch aperture.

(b) Ordinary equatorial of 12-inch aperture, including its dome and observatory.

(c) Siderostatic telescope with objective achromatised in the ordinary way of 18 inches aperture.

(d) Siderostatic telescope with objective achromatised on the dialyte principle of 24 inches aperture.

It would be for the astronomer to say whether the double aperture of the objective would not more than counterbalance the disadvantages of want of absolute universality.

Let us, secondly, consider for what prices the same aperture could be obtained in the various forms:—

(a) Equatorial *coude* 12" aperture ... .. £1760

(b) Ordinary equatorial of 12" aperture, including dome and observatory ... .. 1760

(c) Siderostatic telescope of 12" aperture with objective achromatised in the ordinary way ... 1000

(d) Siderostatic telescope of 12" aperture, with objective achromatised on the dialyte principle 500

The difference between cost of equatorial *coude* and siderostatic dialyte (about 1200*l.* for this size) will probably be considered by the purchaser rather too large a sum to pay for the possibility of examining the 6 per cent. of the northern hemisphere which is beyond the reach of my siderostatic telescope, particularly when it is borne in mind that that portion is the least important part of the heavens.

M. Lœwy does not say whether the 1760*l.* includes cost of observing hut. If not, the comparison is still more striking, for, although the equatorial *coude* requires a special building, my siderostatic telescope does not.

HOWARD GRUBB

Dublin, May 27

### The Earthquake

CHANCE brought me to Colchester about a week after the earthquake, and since then I have been amusing myself mapping the effects of it, and hope to read a paper on the subject at the meeting of the Royal Geological Society, Ireland, next month. In the meantime I would like to draw attention to a few of the general facts that seem not to be recorded.

The area of structural damage lies at and southward of Colchester, principally to the west of the Colne estuary, and in it there are five smaller areas in which are found the greatest damage. These areas occur in the following order:—Wivenhoe, Peldon, Abberton and Langenhoe, Colchester, and West Mersea; each of these have two or more well-marked margins; where these margins can be easily studied, there are found to be lines of breaks, and alongside one, or in places two of them, the greatest destruction occurred, while at the other side of such lines the damage is a bagatelle in comparison.

Thus at Wivenhoe, where there was the greatest damage done, the shock came from the north-east; but when it reached the break of the Colne River valley, it seems to have recoiled as if from a percussion blow. Westward of the estuary of the Colne the damage at Rowhedge was slight when compared with that at Wivenhoe, while at Hornwood it was still slighter, although the last is only divided from Wivenhoe and Rowhedge by the valleys of the Colne and Roman Rivers.

At Peldon, where the shock appears to have been nearly as bad as at Wivenhoe, the damaged area is very well defined, being bounded northward and southward by stream valleys. The shock seems to have travelled southward and to have recoiled from the southern boundary, causing excessive damage alongside it. Here also the shock appears to have had a rotary motion, which possibly may be due to the recoil against the southern boundary.

In the Abberton and Langenhoe area the shocks seem also to have had a rotary motion, the main direction seems to have been from the south-east; here the greatest damage occurs at the western boundary.

At Colchester the shock was going north, while at West Mersea it went south. In both of these places the boundaries of the areas are in part obscure. In the first, however, we can trace the tract of maximum damage from Head Gate along the south Roman wall and eastward to Colne valley, east of which very

little damage was done. Thus everywhere except at West Mersea there are one or more lines, at one side of which there was excessive damage not to be found at the other side.

In the area of excessive damage, according to Mr. Dalton's map, the geological formations are *Alluvium*, *Glacial Drift*, and *London Clay*. On the first we find damage done to houses near Eastbridge, Colchester, and at Wivenhoe, although elsewhere they escaped. In the north portion of Wivenhoe and the north portions of Colchester, structures on the Glacial Drift were injured, but elsewhere the damage nearly invariably is confined to tracts and small exposures of the London Clay. This is very conspicuous in places—at Colchester there is a narrow outcrop of London Clay which widens eastward near the Colne, and on this narrow tract the greatest damage was done; similarly at Wivenhoe the excessive damage is along the outcrop of the London Clay. At Fingrinhoe and Frenchman's Lane the damage margins an outlying tract of Glacial Drift, while very good examples can be seen between Colchester and Ardeigh, the structures on narrow tongues of the clay being injured, while those on the intervening tracts of gravel have escaped, except in one instance.

Victoria Road, Colchester

J. HENRY KINAHAN

ONE of the most curious effects of the earthquake in the Peldon district is the evidence of a decided *twist* or apparent rotation of the shock evident in many cases upon standing buildings. Is is very apparent in the cracks throughout Dr. Green's house, which take a complete screw round some of the rooms and the staircase. It is also evident in the twist of the tapering mill chimney shaft where the upper 20 feet (still standing) is screwed round at the fracture upon the lower part about one inch. The same is apparent in a chimney at the "Peldon Rose" Inn, the screwing in this instance being about two inches. As such twists as are evident could not exist within the areas of separate single buildings, it appears to me that they must have been the resultants of the effects of two separate shocks, the first about north to south, and the second immediately following about east to west. That there were two shocks appears to be the general impression of the inhabitants of whom I made inquiry. Another matter of interest is the very peculiar fracture of the eastern side of Dr. Green's house. This fracture leaves the lower northern corner of the wall, and passes diagonally across the house to the upper southern corner. The crack is open about one inch through solid modern brickwork. In this case the line of fracture does not follow a line of weakness in the wall, but cuts directly through the thick chimney breasts, and equally across a window opening, as though there was present no difference in resistance. The angle of fracture is about 47° to the horizon, and it appears to me that this must have been the direction of the first or greater shock in this district, which was therefore more one of upheaval than of horizontal motion. This is also confirmed upon inquiry, as I find many persons in the district felt distinctly the motion of upheaval, but no one who was standing at the time is known to have been thrown down.

W. F. STANLEY

DARWIN relates that the earthquake of February 20, 1835, which overthrew Concepcion, although it was severely felt in Chiloe, yet on the neighbouring Cordillera (near Mellipulli) it was not felt at all. "Some men who had been employed in the mountains splitting fir planks, when they returned in the evening to Calbuco and were told of the shock, said that 'about the time mentioned they recollected that they had not been able to strike fair with the axe, and that they had spoilt a board or two by cutting too deep.' This probably is not so fanciful as it appears; at least it shows that if there was any motion it was of an exceedingly gentle kind" (*Trans. Geol. Soc.*, vol. v. p. 605).

A parallel case occurred during the late earthquake in Essex. Some men hoeing wheat at Frating, about seven miles north-east of the focus of the shock, did not perceive the shock, but felt as if they could not get their hoes to the ground.

May 30

O. FISHER

Jupiter

THIS planet is now so unfavourably placed that very few further opportunities will occur of observing the chief features during the present apparition. It is, however, important that the red spot and equatorial white spot should be followed as long

as practicable, and I give a list of the times when they will be situated on or near the central meridian:—

	Red spot		White spot
	h.		h.
June 5	8·8	June 5	9·1
7	10·4	7	10·3
10	7·9	12	8·3
12	9·5	14	9·5
17	8·7	21	8·8
22	7·8	28	8·1

The two spots will come to the same longitude on June 7, but at the time of their transit Jupiter will be too low to admit of satisfactory observation.

*Erratum.*—The dark satellite transit which I observed on May 18 (*NATURE*, May 22, p. 77) referred to the *fourth* satellite and not to the first as described. The three dark spots seen were really the shadows of the first and second satellite and the fourth satellite itself. The first satellite was also projected on the disk of Jupiter at the time of the observation, but it was not seen under the form of a dark spot. The error in the original description arose from a mistake in the identification of the satellites and their shadows, four of which were on the planet at the same time.

W. F. DENNING

Bristol, June 1

Animal Intelligence

THE instances of intelligence which I am about to relate, to the credit of a cockatoo, were described to me by the owner, a lady, in whose presence they were displayed, as well as in that of several other witnesses, one of whom (her husband) was also present on two occasions when I heard the accounts.

The bird is fond of white lump-sugar, and ordinarily drops it into his saucer of tea or other drink to soften it. On one occasion when he was thought to be thirsty, a glass of water was offered him, which appears to have been of the goblet kind, about 6 inches high, with a foot and stem, and holding, it would seem, something more than a large wine-glass and less than a small tumbler. Shortly after, the bird received a piece of sugar, and, as usual, dropped it into the water. But now, alas! the depth of liquid was too great for him to recover the saturated lump; and unfortunately, not having myself witnessed the occurrence, I am unable to describe the indications of mental effort which doubtless preceded the attempt to solve the problem of extracting the lump of sugar before it should disappear. I was told that the like difficulty recurred next day, and, whether on account of the practical failure of the first attempt, or in consequence of a fresh inspiration at the moment, a different and *entirely successful* plan was then adopted. It is no doubt to be regretted that the experiment was not followed up, but the reason will shortly be apparent. Now, as to the first attempt. There was no endeavour to upset the glass; it was too high for the claw to be used, and too deep for the beak to be plunged in. To *drink* all the water would indeed have been, as remarked by the narrator, "an heroic remedy." What "Koko" *did* do was to *bale* the water out with his scoop-like lower mandible. Here again I find myself unable to describe the action more exactly, but it must have been in the highest degree interesting to watch the operation, with its increasing difficulty, and constantly diminishing prize at the bottom. Finally we may suppose that the sugar having disappeared the last portions were at least partly enjoyed. Still the result was to some extent evidently a disappointment; for on the next occasion "Koko," without the least hesitation, put in practice a device which we may fairly suppose he had thought out meanwhile. He began forthwith to drop in lumps of sugar one after another until the last was level with the surface, when he recovered that one and left the rest to their natural fate, while he peacefully enjoyed the fruits of his invention.

I have unfortunately too slight an acquaintance with the ways of these birds to know certainly whether this is above the average of their intelligent acts and as such worthy of space in your columns. For the same reason I hesitate to give, at second hand, other indications which, however interesting to me, might prove less so to others. I will only add that it is so distressing to see so nice a creature almost naked, through its inveterate propensity to pluck out every feather within reach, that I should be glad to hear of any possible remedy.

J. HERSCHEL

23, Suffolk Street, Pall Mall East, S. W.

P. S.—At the suggestion of a gentleman whose name is well

[The following is M. d'Abbadie's letter:—]

MY DEAR SIR,—I have met few people who can pen a narrative quite accurately as you have done. Were I writing history, I should add that "Koko" (a *Cacatua moluccensis*) seems to hail with satisfaction the appearance of a coffee-tray. As soon as it is laid on the table he lifts by its central knob the sugar bowl's cover, picks up a lump of sugar, and drops it in an empty cup, on which he taps with his beak to intimate that he is thirsty, for dry sweets are not to his taste.

This bird is the wonder and plague of my life. One day curiosity (?) impelled him to pull into shreds my only kaleidoscope. He got for his industry a few touches of a whip, which he tore to pieces twenty-four hours later, showing apparently that memory is one of his gifts. He has a knack of tearing my pens and papers, sometimes with good reason. As, however, I arrogate those privileges to myself, "Koko" is excluded from my study. Its door, partly glazed, has a pad to prevent draughts, and, before I added a bolt, was closed only by a knob two centimetres thick. Climbing along the pad eighty centimetres above the floor, he looked slyly with one eye through the glass, and if the coast was clear he then proceeded to business by turning the knob with his powerful beak and then pulling it, while one claw pushed against the doorpost, the other holding on to the pad. Another door has a lock, and servants thought to exclude the intruder by turning the key, but "Koko" soon learnt to turn it back before applying his energies to the knob. Having thus put the door ajar, he descends cautiously with beak and claws along the pad, opens the door by a push or pull of his beak, as the case may be, and, stopping on the threshold, exclaims modestly, "Koko!" like a Wolseley or a Graham announcing his recent victory.

I say modestly, for this bird assumes often a haughty tone when uttering what we call his public speech. It is a rambling gabble, and, like the sayings of a French orator who shall be nameless, it is wholly unintelligible. However, its varying tones are splendid. Those of indignation and command prevail, but in the course of seeming argument "Koko" expresses also and most forcibly concession, interrogation, pity, disdain, ridicule, contradiction, and even logical inference. Without having read the Roman author who advises orators to take hold of their beards when pausing to reflect, "Koko" halts now and then his wordy torrent to seize his chin with his claw, as if pondering on the best line of action. Other appropriate gestures add to the seeming reality of his discourse. I have seen him stand suddenly on one leg, double up the other claw like a fist, and deal a blow on the air as if to knock down an enemy. In spite of their wide sleeves, our barristers might well envy the fulness of gesture imparted by his wings. He raises them expanded over his head, then throws them down impetuously before himself with a seemingly clenching argument. I have heard that Burke used his arms in the same way when beginning his outbursts of eloquence.

The wisdom of nations has sometimes found it necessary to put even statesmen in durance vile, and "Koko" has not escaped the lot of his betters. As, however, he contrived to unfasten several kinds of common spring padlocks, and even one which requires, like my door, three simultaneous manoeuvres, my astronomical artist boasted of making one which would puzzle even a Christian. Our bird was chained with this ingenious invention, and immediately busied himself for about two hours pressing on every side the brazen problem. It seemed to cause a heavy expense of thought for his slender brains. On the following day he opened this new-fangled padlock, but with evident difficulty. Finally, having mastered it the third morning, he then freed himself with the greatest ease. Withal he cannot get rid of a padlock that requires a key, nor has he yet pushed back a loose bolt on the very door where he overcomes a fastening apparently more complicated. May we infer that bird reason differs from human reason?

sideways, like the players, and took good care to laugh loudly at each pretended stumble.

The foregoing facts, where a bird's reasoning powers seem to rival those of men, suggest two questions: (1) Where is the boundary between them? and (2) whether intelligence depends, as is often supposed, merely on size of brain? Unable to answer these queries, I remain very truly yours,

ANTOINE D'ABBADIE,  
de l'Institut de France

Paris, May 20, 1884

### METEOROLOGY IN VICTORIA

THE monthly and other publications on meteorology and terrestrial magnetism issued by the Melbourne Observatory continue to be regularly received by us, the last *Monthly Record* being for December 1883. Since we reviewed these *Records* (*NATURE*, vol. xiv. p. 153) we have observed with much interest the steady, and latterly the rapid, extension of climatological stations over the colony. During the ten years ending December 1883, while the number of fully equipped stations has remained nearly the same, stations at which temperature is observed have increased from 10 to 27, and stations for rain observations from 34 to 170. These 170 stations are conveniently classed into coast, watershed, and river-basin groups, and the individual gauges of each group are further arranged in the tabular returns in the order of their heights, which rise to about 4000 feet. The *Records* conclude with a detailed report for all the stations of thunderstorms, hail, snow, frost, gales, hot winds, auroras, earthquakes, &c., observed during the month.

While isobars can be drawn with tolerable correctness from the observations of a small number of stations, and isothermals from the returns of a few more, but still a comparatively small number of stations, it cannot be too strongly insisted on that a very large number of rain-gauges are required to give even a tolerable approximation to the actual rainfall of a country for a definite period, say, a week or a month, which may not seriously mislead those interested in the rise and fall of prices of agricultural and other products that depend on the weather. The meteorological authorities of South Australia and New South Wales are, equally with Mr. Ellery, so fully alive to the paramount importance of an adequate observation of the rainfall, that after a few years' continued vigorous effort this large portion of Australia will take rank, in respect of its rainfall, as one of the best observed regions of the globe.

At Melbourne the wind is observed and the results are discussed with admirable fulness. In summer the prevailing winds are southerly, and in winter northerly. The strongest winds are north and north-west, and the lightest east and south-east, the south-easterly winds in some seasons blowing with only about a third of the velocity of the north-westerly winds. The diurnal velocity of the wind falls to the minimum from about midnight to 4 a.m., and rises to the maximum from about 10 a.m. to 4 p.m. As regards season, the absolute maximum occurs at noon in winter, but in summer two hours later. Another important feature in the diurnal velocity of the wind is that from April to August the daily maximum is only a half more than the minimum velocity, whereas from October to February it is more than double. In other words, the maximum velocity rises to a greater extent above the daily mean during the period of the year when the temperature

is rising from winter to summer than when it is falling from summer to winter, agreeing in this respect with what has been observed in similar regions.

The *Monthly Notices* give, in addition to the month's results, the averages of that month for each station based on previous years' observations. In the review referred to above we drew attention to the temperature observations at Portland as being evidently too high. In the following February (1877) the mistake was rectified, and since then the observations of temperature at this station agree with those made at the other stations. A comparison shows that down to January 1877 the published temperatures at Portland were about 5° too high. As regards the averages published since then, however, no allowance has been made down to December 1883 for this large error. The result is that while at the other stations of the colony the mean temperatures of the months since February 1877 rise above and fall below their averages as at other places, Portland all but uninterruptedly appears as very much below its average. Indeed, except the unusually warm months of September 1879 and February 1880, not one of the other forty-six months shows a temperature as high as the average. It is the more necessary to draw attention to this point seeing that the faulty mean temperatures of Portland still continue to appear in works on climatology, either in the text, or they have been used along with the means of other places, similarly faulty, in drawing the isothermals of the globe.

HABITS OF BURROWING CRAYFISHES IN THE UNITED STATES

ON May 13, 1883, I chanced to enter a meadow a few miles above Washington, on the Virginia side of the Potomac, at the head of a small stream emptying into the river. It was between two hills, at an elevation of 100 feet above the Potomac, and about a mile from the river. Here I saw many clayey mounds covering burrows scattered over the ground irregularly both upon the banks of the stream and in the adjacent meadow, even as far as ten yards from the bed of the brook. My curiosity was aroused, and I explored several of the holes, finding in each a good-sized crayfish, which Prof. Walter Faxon identified as *Cambarus diogenes*, Girard (*C. obesus*, Hagen), otherwise known as the burrowing crayfish. I afterwards visited the locality several times, collecting specimens of the mounds and crayfishes, which are now in the United States National Museum, and making observations.

At that time of the year the stream was receding, and the meadow was beginning to dry. At a period not over a month previous, the meadows, at least as far from the stream as the burrows were found, had been covered with water. Those burrows near the stream were less than six inches deep, and there was a gradual increase in depth as the distance from the stream became greater. Moreover, the holes farthest from the stream were in nearly every case covered by a mound, while those nearer had either a very small chimney or none at all; and subsequent visits proved that at that time of year the mounds were just being constructed, for each time I revisited the place the mounds were more numerous.

The length, width, general direction of the burrows, and number of the openings were extremely variable, and the same is true of the mounds. Fig. 1 illustrates a typical burrow shown in section. Here the main burrow is very nearly perpendicular, there being but one oblique opening having a very small mound, and the main mound is somewhat wider than long. Occasionally the burrows are very tortuous, and there are often two or three extra openings, each sometimes covered by a mound. There is every conceivable shape and size in the chimneys

ranging from a mere ridge of mud, evidently the first foundation, to those with a breadth one-half the height. The typical mound is one which covers the perpendicular burrow in Fig. 1, its dimensions being six inches broad and four high. Two other forms are shown in Fig. 2. The burrows near the stream were seldom more than six inches deep, being nearly perpendicular, with an enlargement at the base, and always with at least one oblique opening. The mounds were usually of yellow clay, although in one place the ground was of fine gravel, and there the chimneys were of the same character. They were always circularly pyramidal in shape, the hole inside being very smooth, but the outside was formed of irregular nodules of clay hardened in the sun and lying just as they fell when dropped from the top of the mound. A small quantity of grass and leaves was mixed through the mound, but this was apparently accidental. The size of the burrows varied from half an inch to two inches in diameter, being smooth for the entire distance, and nearly uniform in width. Where the burrow was far distant from the stream, the upper part was hard and dry. In the deeper holes I invariably found several enlargements

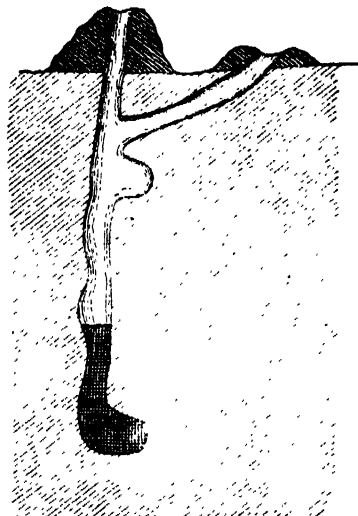

Fig. 1 Section of Crayfish burrow

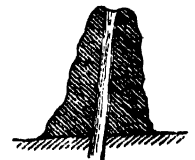

Fig. 2 Crayfish mound



Fig. 2 Crayfish mound

at various points in the burrow. Some burrows were three feet deep, indeed they all go down to water, and, as the water in the ground lowers, the burrow is undoubtedly projected deeper. The diagonal openings never at that season of the year have perfect chimneys, and seldom more than a mere rim. In no case did I find any connection between two different burrows. In digging after the inhabitants I was seldom able to secure a specimen from the deeper burrows, for I found that the animal always retreated to the extreme end, and when it could go no farther would use its claws in defence. Both males and females have burrows, but they were never found together, each burrow having but a single individual. There is seldom more than a pint of water in each hole, and this is muddy and hardly suitable to sustain life.

The neighbouring brooks and springs were inhabited by another species of crayfish, *Cambarus bartonii*, but although especial search was made for the burrowing species, in no case was a single specimen found outside of the burrows. *C. bartonii* was taken both in the swiftly-running portions of the stream, and in the shallow side nooks, as well as in the springs at the head of small



The brook near where my observations were made was fast decreasing in volume, and would probably continue to do so until in July its bed would be nearly dry. During the wet seasons the meadow is itself covered. Even in the banks of the stream, then under water, there were holes, but they all extended obliquely without exception, there being no perpendicular burrows, and no mounds. The holes extended in about six inches, and there was never a perpendicular branch, nor even an enlargement at the end. I always found the inhabitant near the mouth, and by quickly cutting off the rear part of the hole could force him out, but unless forcibly driven out it would never leave the hole, not even when a stick was thrust in behind it. It was undoubtedly this species that Dr. Godman mentioned in his "Rambles of a Naturalist," and which Dr. Abbott (*Am. Nat.*, 1873, p. 81) refers to *C. bartonii*. Although I have no proof that this is so, I am inclined to believe that the burrowing crayfishes retire to the stream in winter, and remain there until early spring, when they construct their burrows for the purpose of rearing their young, and escaping the summer droughts. My reason for saying this is that I found one burrow which on my first visit was but six inches deep, and later had been projected to a depth at least twice as great, and the inhabitant was an old female.

I think that after the winter has passed, and while the marsh is still covered with water, impregnation takes place and burrows are immediately begun. I do not believe that the same burrow is occupied for more than one year, as it would probably fill up during the winter. At first it burrows diagonally, and as long as the mouth is covered with water is satisfied with this oblique hole. When the water recedes, leaving the opening uncovered, the burrow must be dug deeper, and the economy of a perpendicular burrow must immediately suggest itself. From that time the perpendicular direction is preserved with more or less regularity. Immediately after the perpendicular hole is begun, a shorter opening to the surface is needed for conveying the mud from the nest, and then the perpendicular opening is made. Mud from this and also from the first part of the perpendicular burrow is carried out of the diagonal opening and deposited on the edge. If a freshet occurs before this rim of mud has a chance to harden, it is washed away and no mound is formed over the oblique burrow. After the vertical opening is made, as the hole is bored deeper, mud is deposited on the edge, and the deeper it is dug the higher the mound. I do not think that the chimney is a necessary part of the nest, but simply the result of digging. I carried away several mounds, and in a week revisited the place, and no attempt had been made to replace them; but in one case, where I had, in addition, partly destroyed the burrow by dropping mud into it, there was a simple half rim of mud around the edge, showing that the crayfish had been at work; and as the mud was dry the clearing must have been done soon after my departure. That the crayfish retreats as the water in the ground falls lower and lower

for them to live in, and they must migrate. It would be interesting to know more about the habits of this peculiar species, about which so little has been written. An interesting point to settle would be how and where it gets its food. The burrow contains none, either animal or vegetable. Food must be procured at night, or when the sun is not shining brightly. In the spring and fall the green stalks of meadow grasses would furnish food, but when these become parched and dry they must either dig after and eat the roots, or search in the stream. I feel satisfied that they do not tunnel among the roots, for if they did so these burrows would be frequently met with. Little has as yet been published upon this subject, and that little covers only two spring months, April and May, and it would be interesting if those who have an opportunity to watch the species during other seasons, or who have observed them at any season of the year, would make known their results.

RALPH S. TARR

#### THE YOUNG GORILLA OF THE JARDIN DES PLANTES

THROUGH the courtesy of the editor of *La Nature* we are able to give an illustration from an instantaneous photograph of a young male gorilla obtained at the commencement of last winter by the Natural History Museum at Paris. It had been imported from the Gaboon, and it was the first living specimen of this great anthropomorphic ape which had been brought to France. Its study would have presented many points of interest, not alone from the Natural History point of view, but also from the opportunity it would have afforded of studying the development of its intellectual faculties. This young specimen was about three years of age, he had already his full complement of milk-teeth, and the long and sharp canines were decidedly longer than the molars. In disposition he appeared to be very different from either the orang-outan or the chimpanzee. While these in a state of captivity are mostly gentle and sociable, this young gorilla on the other hand was savage, morose, and brutal; he never gave his keeper the least mark of affection; he never allowed himself to be touched without evidencing the greatest aversion, and for the most part he returned caresses by snappings. He never took the least part in the games of the other apes, and he most reluctantly tolerated having them near him. He was but little active, and most generally kept himself crouched up in a corner of the cage, or sitting on a branch with his back up against the wall, and scarcely ever moved but to look about for something to eat. He used his hands with much readiness, and they were extremely well developed. His lips were less mobile than in the chimpanzee, especially the lower lip, which was never pouted out when drinking into a spoon-shaped form. His eyes were extremely mobile, and were crowned with immense superciliary ridges; his nose was flat, with excessively large nostrils, giving him a quite peculiar physiognomy.





His intelligence was feebly developed, and was in any case quite below that of the other anthropoid apes, or



even of the gibbons. Since the above note was presented by Alph. Milne-Edwards to the Paris Academy of Sciences the young gorilla died at the Jardin des Plantes.

### NOTES

THE portrait of the late Sir William Siemens, which we give this week as one in our series of Scientific Worthies, belongs to the previous volume of NATURE, and is intended to accompany the memoir at p. 97.

THE Secretary of State for India has determined that India shall be represented at the forthcoming International Prime Meridian Conference at Washington, and has nominated as the India Office delegate Lieut.-General R. Strachey, C.S.I. Capt. Sir Fred. J. O. Evans, R.N., K.C.B., F.R.S., and Prof. J. C. Adams, F.R.S., on the recommendation of the Science and Art Department, have been appointed delegates to represent the United Kingdom at the Conference.

ON May 28, at an extraordinary meeting of the Vienna Academy of Sciences, Count Hans Wilczek was elected Honorary Member. In the Mathematical and Natural Science Section, Dr. Albrecht Schrauf, Professor of Mineralogy at the Vienna University, and Dr. Leopold Gegenbauer, Professor of Mathematics at the Innsbruck University, were elected Corresponding Members. As Foreign Honorary Members were elected Sir William Thomson, and Charles Hermite (Paris); as Foreign Corresponding Members, Prof. L. Leuckart (Leipzig), Prof. Edward Frankland, and Prof. Carl Nägeli (Munich).

THE "Rede" Lecture was delivered on Wednesday, last week, in the Cambridge University Senate House, by Mr. Francis Galton, M.A., F.R.S. Mr. Galton, who had selected as the subject for the lecture "The Measurement of Human Faculty," stated that, although it had been a matter of controversy whether a more complete measurement of man's capacity could be attained than was already discovered by means of examinations which measured intellectual capacity, yet he would endeavour to demonstrate that as the capacity of man, taken in its widest sense, including character and physique, was finite, therefore it was measurable. He pointed out that an important adjunct to the attempt to measure human faculty would be records containing particulars regarding eyesight, colour-sense, hearing, breathing capability, height, span of arms, &c. At the Johns Hopkins University in America physical education and hygiene were compulsory on all students, and although the physical measurements taken were not compulsory yet few objected, and the result was that the most valuable statistics were collected, and in many instances good advice given to the students in what way to counteract the effects of any abnormal condition observed, such as irregularity of muscular development. Mr. Galton concluded by suggesting that a laboratory should be opened at Cambridge to investigate this new science. The cost would be small; the result, he ventured to predict, would be large and beneficial, for, by the compiling of continuous records of health, growth, and disease, much useful knowledge would be acquired, and by a long series of observations on the lines he had indicated it would be possible to measure the human faculty as accurately as, if not more so than, our system of examinations measures the intellectual faculty.

We understand that the Fishery Board for Scotland is anxious to have powers enabling it to remove obstructions which interfere with the ascent of salmon up several Scottish rivers. It is specially desirous to introduce as soon as possible a fishway at the falls, and this, when done, would open up some 500 miles of excellent fishing and spawning ground. Last week there were several interesting arrivals from fishery officers:—(1) A fine specimen of the "Opah fish" (*Lampris guttata*) was taken off Unst Island, Shetland, on May 22, and forwarded by the fishery officer to Prof. Ewart, University of Edinburgh. The fish, which measured 4 feet in length and over 2 feet in depth, has been handed over to Prof. Turner. This Opah will enable Prof. Turner to complete an account of the fish begun some years ago, when he received a somewhat smaller specimen from the Moray Firth. (2) A turbot with peculiar frontal process, an eye on each side of the head, both sides of the body equally dark, and provided with spines. (3) Mature sprats. It seems proved that sprats leave the estuaries in spring to spawn at sea. (4) Developing herring eggs. Taken along with similar specimens which have been arriving since October last, these show that herring spawn on the east coast from August until May, and not, as is usually supposed, only during August and September and during February and March.

IN response to the appeal of the Prince of Wales, as President of the City and Guilds of London Institute, the following contributions have been already promised to the General Fund and to the Equipment Fund of the Central Institution, Exhibition Road, by the undermentioned Companies:—Fishmongers, 4000*l.*; Mercers, 2000*l.*; Clothworkers, 2000*l.*; Corporation of London, 1000*l.*; Skippers, 1000*l.*, and an increased subscription of 500*l.* annually; Leather-sellers, 500*l.*; Carpenters, 500*l.*; Armourers and Braziers, 300*l.*; Tallow Chandlers, 105*l.*; Scriveners, 105*l.*; Stationers, 52*l.* 10*s.* annually; Clock-makers, 26*l.* 5*s.* The letter of the President is still under the consideration of the Courts of several Companies, and it is confidently expected that the sum required will be obtained.

A CORRESPONDENT writes:—"Last week you had occasion to refer to the little attention which is given in our schools to the study of geography, and the consequent withdrawal of certain medals which were awarded by the Royal Geographical Society to the most proficient candidates from the public schools. The superiority of our Continental neighbours in this matter will be apparent to any one who visits the Educational Section of the International Exhibition, which has been so well organised in the new Technical Schools by Mr. R. Cowper. Here a society of teachers, known as the Brothers of the Christian Schools, exhibit a number of hypsometrical wall maps and physical atlases admirably calculated to give correct notions of the real configuration of the earth's surface. There is also a collection of small models in relief, some of local topographical interest, and others of general utility as illustrating the definitions and leading facts of physical geography. These maps and reliefs were all made by a member of the Society—Brother Alexis—who has successfully striven, in France and Belgium, to introduce rational methods into the teaching of political and physical geography. The interest taken in this subject by students in the schools and colleges of the Brothers in France is shown by a large number of albums of maps sent in by them. It is interesting to notice that many of the local maps were drawn from surveys made by the students under the direction of their teachers. Such field-work is decidedly the best for advanced students, and is sure to be done *con amore*. A second collection sent from the Collegiate Schools of the same Society in Belgium will be found in the Belgian Court. The teachers of those of our public schools from which geography has not been absolutely ostracised will do well to carefully examine the physical maps and reliefs of the Brothers, as well as the cartographical work of their students. The result must be an improvement in our methods. If the Educational Exhibition does no more than raise the standard of geographical teaching throughout the country, it will have served a useful purpose."

It is worthy of note that the General Assembly of the Free Church of Scotland have approved of the establishment of a Chair of Natural Science in their Glasgow Theological College.

THE Council of the Hartley Institute, Southampton, have issued a circular with reference to the Geological Survey of Hampshire and the Isle of Wight. The Council think that it would be of great service to the landowners and inhabitants of the county that the Geological Survey should now be revised on the map of the 6-inch scale. This revision of the work previously carried out on the old 1-inch map would enable many errors in detail in the former work to be corrected, and would give the county a much more valuable and detailed geological map, the sheet of which relating to any parish could be had separately by paying the cost of the map and the cost of colouring. At present this is not to be obtained, nor is it likely to be obtainable unless the Government can be induced to survey the county, geologically, on the map of the 6-inch scale as some other counties have been surveyed. This work, taking the old Survey as the basis, would not be expensive. The Hartley Council intend to request the members of the House of Lords connected with the county, and the representatives of the county and boroughs of Hampshire in the House of Commons, to urge the Government to revise the County Geological Survey upon the 6-inch map. We trust the Government will readily accede to the request; a minute revision of this geologically interesting district would be of great service to science.

ONE afternoon, *Science* states, during the recent cruise of the *Albatross* in the Caribbean Sea, several boobies were flying around the ship, and finally one of them alighted on the fore-castle, when he was caught by one of the men, who, after amusing himself and his shipmates a while, tossed it overboard,

expecting it would take itself off as quickly as possible; but, to their surprise, it returned immediately, alighting on the rail, where nearly every man of the crew had congregated to watch its performance. It did not seem to be distressed in any way, and went deliberately to work rearranging its plumage, which had been somewhat ruffled by handling, calmly surveying the noisy crowd of men gathered around it. They tried to feed it, offering everything that could be found, but nothing seemed to suit its taste. It would not submit quietly to being handled, but made no attempt to fly away; and, although tossed overboard six times during the afternoon, it returned as often, invariably alighting in the same place among the men, where it finally took up its quarters for the night, remaining till six o'clock the next morning, when it left without ceremony, and was not afterwards seen.

THE Esposizione Generale Italiana was opened at the end of April in Turin, and at the end of May the inauguration of the International Electrical Exhibition took place. Prof. Ferraris is the director of the International Department. A good display of meteorological instruments has been made in a tower belonging to the front monumental entrance. An inscription states that the Italians having inaugurated meteorology in the world are anxious to show the progress which this department of knowledge has made in its native country. The extent of the exhibition is about 1 kilometre by 450 metres on the banks of the Po, in the old gardens of Valentino Castle, where Beccaria executed his celebrated experiments on thunderstorm phenomena about 100 years ago.

A VIOLENT shock of earthquake occurred on the night of May 19 at the Island of Kishm, near the mouth of the Persian Gulf. No less than twelve villages were destroyed. Two hundred people were killed, and many others injured. Kishm is the largest island in the Persian Gulf, and is surrounded by many smaller islands. It is seventy miles long, and averages twelve miles broad. The population, chiefly Arabs, number about five thousand.

THE latest news from the Sagastyr Meteorological Station on the Lena, published by the St. Petersburg *Izvestia*, is dated November 25. The expedition remained to winter a second year, and will continue its observations until the present month. Last summer M. Ligner made the survey of two branches of the Lena, from the place where Capt. De Long landed on his sad journey. Dr. Bunge revisited the place where the Adams mammoth was found, and mapped also the place where De Long perished with his companions. The summer was altogether very cold, the average temperature of the three summer months being only 3°·25 C. The sky was cloudy throughout, and fogs were nearly continuous. The lowest temperature observed last winter was on February 7, when the thermometer fell to -52°·3 C.

THE East of Scotland Union of Naturalists' Societies holds its first annual meeting at Dundee to-morrow and Saturday.

MR. ARCHIBALD BARR, B.Sc., C.E., "Young" Assistant to Dr. James Thomson, F.R.S., Professor of Civil Engineering and Mechanics in the University of Glasgow, has been appointed Professor of Civil and Mechanical Engineering in the Yorkshire College.

MR. W. PHILLIPS, F.L.S., of Shrewsbury, has in preparation "A Manual of the British Discomycetes, with Descriptions of all the Species of Fungi hitherto found in Britain, included in the Family, and Illustrations of the Genera."

THE last volume of the *Memoirs* of the Ethnographical Section of the Russian Geographical Society (vol. xii.) contains a rich collection of Russian folk-lore collected in the Samara province on the Volga, by D. N. Sadovnikov.

THE additions to the Zoological Society's Gardens during the past week include a Himalayan Bear (*Ursus tibetanus*) from

North India, presented by Lieut. E. A. P. Hobday; three Black-eared Marmosets (*Hapale penicillata* ♂ ♂ ♂) from South-East Brazil, presented by Mr. H. F. Makins, F.Z.S.; a Purple-faced Monkey (*Semnopithecus leucopymnus* ♀) from Ceylon, presented by Mr. J. W. Dring; a Common Heron (*Ardea cinerea*), British, presented by Mr. T. E. Gunn; a Leach's Laughing Kingfisher (*Dacelo leachi*) from Queensland, presented by Dr. Carl Lumholtz; a Laughing Kingfisher (*Dacelo gigantea*) from Australia, presented by Mr. E. R. Oliver; a Great Grey Shrike (*Lanius excubitor*), British, presented by Mr. J. Pratt, F.Z.S.; a Spotted Bower Bird (*Chlamydobera maculata*) from Australia, presented by Lieut.-Col. W. Hill James; four River Frogs (*Rana fortis*) from Germany, presented by Mr. G. A. Boulenger, F.Z.S.; a Green Turtle (*Chelone viridis*) from West Indies, presented by Mr. J. Wyan Thomas; a Tarantula Spider from Brazil, presented by Mr. C. A. Craven, C.M.Z.S.; a Common Boa (*Boa constrictor*) from South America, deposited; a Chimpanzee (*Anthropopithecus troglodytes* ♀), a Bosman's Potto (*Perodicticus potto* ♂) from West Africa, a Duyker-bok (*Cephalophus mergens* ♀) from South Africa, a Ring-tailed Coati (*Nasua rufa*) from South America, two Blood-stained Finches (*Carpodacus hamorrhous*) from Mexico, a Snow Bunting (*Plectrophanes nivalis*), North European; an Angola Vulture (*Gypohierax angolensis*) from West Africa, a Guatemalan Amazon (*Chrysotis guatemalae*) from Central America, four Elegant Grass Parrakeets (*Euphonia elegans*) from South Australia, two Wild Ducks (*Anas boschas*), two Call Ducks (*Anas boschas*, var.), two Common Wigeon (*Mareca penelope*), two Common Pintails (*Dasila acuta*), six Common Teal (*Querquedula crecca*), two Muscovy Ducks (*Cairina moschata*), European, two Mandarin Ducks (*Aix galericulata*) from China, purchased; a Common Wombat (*Phoscolomys wombat*) from Tasmania, received in exchange.

OUR ASTRONOMICAL COLUMN

THE TOTAL SOLAR ECLIPSE OF 1889, JANUARY 1.—The general circumstances of most of the total eclipses of the sun more or less available for physical observations before the close of the present century have been already described in this column: it remains, however, to make reference to that which will take place on January 1, 1889, and which will be total in the western part of the United States.

The central eclipse commences on the North Pacific Ocean in about longitude 178° E. and latitude 53° N.; it occurs with the sun on the meridian in 137° 57' W. and 36° 42' N., and ends in about 95° W. and 52° 15' N. It strikes the American coast in the State of California in latitude 38° 50', and the town of Hamilton, according to our approximate computation, would appear to be upon the central line: here the middle of totality occurs at 1h. 40m. 34s. local mean time, with the sun at an altitude of nearly 25°, and the duration of the total phase is 2m. 4s. The important observatory lately established on Mount Hamilton is outside of the zone of totality, the magnitude of the eclipse at that station being 0.98, and the middle at 1h. 45m. The following are points upon the line of central eclipse:—

Longitude 112 34 W.	Latitude 43 15 N.	Sun's altitude 15.9
" 106 14 "	" 46 15 "	" 10.2
" 100 21 "	" 49 9 "	" 5.0

It will be seen that the sun will set totally eclipsed on British territory after the total phase has crossed the Assiniboine River and the southern extremity of Lake Winnipeg.

The second total solar eclipse in 1889 was described in NATURE in June 1877. It will be visible in Martinique, St. Lucia and Barbados, but with the sun at a low elevation, totality continuing about one minute and three-quarters, and will meet the coast of Africa in Angola in about 10° south latitude, where the total phase will have a duration of 3m. 30s., the sun at an altitude of 56°.

VARIABLE STARS.—In 1859 Hencke of Driesen drew attention to a star in Carrington's Redhill Catalogue which he had found to be variable. It is No. 1902, and was observed on

three nights in March and April 1856, the magnitude being twice noted 9.5 and once 10.5. Hencke had observed it 8m. at the time he wrote, but believed it had probably been invisible with his means for some years previously. His notice appears in Peters' *Zeitschrift für populäre Mittheilungen aus dem Gebiete der Astronomie* &c., vol. i. p. 131. The star is not found in the catalogues of Fedorenko or Schwed. Its approximate position for the beginning of 1885 is in R.A. 12h. 44m. 49s., N.P.D. 7° 39' 8".

At p. 150 of the Redhill Catalogue Carrington mentions that Oeltzen's No. 515, a seventh magnitude once observed by Schwed had been looked for ineffectually. Oeltzen had re-examined his reduction of the observation which was made at Speyer on October 19, 1826, and found it correct. The star's place for 1885 is in R.A. 8h. 27m. 54s., N.P.D. 6° 52' 7". Close to this position there is a star in Fedorenko's catalogue from Lalande's observations (Nos. 1305-6) which is once called 8m., and once 5.6, the observations having been apparently made on March 19 and 20, 1790. It is 6m. in Groombridge, and 7m. in the *Durchmusterung* and in the Radcliffe Catalogue. Perhaps the discordance in Lalande's published estimates is occasioned by a misprint, and unfortunately there are several obvious errors of this kind in the catalogue deduced from his observations. The star in question is Groombridge 1431.

While writing upon polar variables we may once more refer to Bradley 396, R.A. (1885) 2h. 53m. 58s., N.P.D. 8° 58' 6", which, unless the existence of very improbable errors of estimation in the various catalogues is admitted, would appear to vary between the fifth and seventh magnitudes at the least, and there is a suspicion that the period may not be long.

A minimum of  $\chi$  Cygni was due on May 22, and a maximum may be expected about November 16; from three determinations Schmidt found that the minimum preceded the maximum 178 days. The average period since 1877 has been 408.4 days. The variable is the true  $\chi$  (Bayer) Cygni, not the 17 Cygni of the catalogues.

GEOGRAPHICAL NOTES

THE fifth fascicule of A. E. Nordenskjöld's "Popular Scientific Appendix to the Voyage of the *Vega*" ("Studier och Forskningsförelädda af mine resor i höga Norden") will be most welcome to the general reader, and we hope it may be translated into English. It contains a profusely illustrated, lively sketch, by M. Hans Hildebrand, on art among lower primitive populations. The drawings of the Chukches are especially remarkable. Caravans of sledges drawn by reindeer or by dogs, hunting scenes, splitting drift-wood, and sea-hunting, are most interesting, and not the slightest mistake is possible as to what the Chukche artist intended to represent. The Chukches are as successful, too, in drawing subjects less known to them, such as the *Vega* at its winter-quarters, or two men of the crew exercising in fencing. The most remarkable piece is that given to Baron Nordenskjöld by Lord Walsingham, which is reproduced by means of photography. The original is drawn on walrus-skin, and represents on the borders of the skin the shores with their hills, Chukche settlements, and a variety of scenes from Chukche life on shore; while the interior contains a variety of scenes from sea-hunting, harpooned whales pretty well represented with their waterspouts, ships, boats, and so on. The Europeans, sometimes with umbrellas, sometimes fighting with Chukches, are perfectly recognisable. The engravings showing the carvings in bone that are made by Chukches and Esquimaux are also very interesting, whilst other drawings allow us to compare the Northern primitive art with the art of Boshmans and North American Indians. M. Hildebrand's remarks on the art of prehistoric man and his parallels with the Normannic drawings—also well illustrated—will be equally attractive to the general reader. The same fascicule contains the first pages of a paper on the life of insects in Arctic regions, by M. Christopher Aurivillius.

THE *Bolletino* of the Italian Geographical Society for May contains a brief account of Signor Maurizio Buonfanti's late expedition across North Africa. The traveller, leaving Tripoli early in the month of April 1881, proceeded first in the direction of Lake Chad, mainly along the route already followed by Denham and Clapperton, Barth, Rohlfs, and other modern explorers. His chief object was to penetrate into the hitherto unexplored region stretching south from Adamawa, which territory was reached by the direct road from Kuka on Lake Chad through

Dikoa to Doloo. But a further advance in this direction was prevented by the disturbed state of the frontiers between Bornu and Adamawa. Buonfanti was consequently compelled to retrace his steps to Kuka, whence he turned westwards along the route recently opened by Lieut. Massari to Kano. After some trips to Yakoba and other little-known parts of Sokoto, he made his way through Gando to the Niger at Say, about midway between Timbuktu and the Binue confluence. Here he turned north, and for the first time ascended the Niger as far as Timbuktu. This feat, hitherto supposed to be impossible, was performed in the dry season, and the problem thus successfully solved possesses considerable geographical and commercial importance in connection with the attempts now being made to establish regular lines of water communication between Western and Central Sudan and the Gulf of Guinea. From Timbuktu the route lay through the States of Massina and Bambarra to the almost unknown territory of Tombo, the attempt to explore which region ended in disaster. Attacked in the Sanghi district by the natives, the expedition was plundered and almost completely dispersed, being reduced from an escort of 250 to six persons. Thus reduced to the greatest straits, the traveller was driven eastwards, and after enduring fearful sufferings reached the Bussanga country north of Dahomey. Here he fortunately came upon a Roman Catholic mission, which provided him with the means of continuing his journey southwards to the coast of Guinea. He arrived at Lagos on March 5, 1883, having lost all his scientific collections during the disastrous journey through Tembo.

WE received last year complete reports of the state of the ice around Greenland, from Nordenskjöld, and in the Siberian Seas, from Hovgaard, but no report as to the conditions around Spitzbergen. As complete reports of the state and conditions of the ice in the various Arctic seas from year to year will greatly tend to assist glacialists in their researches and future Polar travellers, we publish some particulars furnished by the well-known Arctic hunter, Capt. M. E. Arnesen, of Tromsø, of his voyages in the Spitzbergen seas last summer:—Leaving Tromsø on April 21, he encountered the ice on April 28 in lat. 68° 28' N. and long. 41° 18' E. On May 4 the first seal was shot in lat. 68° 50' N. and long. 42° 10' E. A storm clearing the ice away, he was able to sail as far as 69°. Here a large ice-field stretched west-north-west as far as lat. 69° 55' N. and 44° 30' E., where it curved in a north-easterly and easterly direction. During the fifteen years Capt. Arnesen has sailed in the Arctic seas he never experienced such an early and warm spring. The heat was at times quite oppressive. On the night of July 14 he rounded South Cape at Spitzbergen. The ice lay towards Whales Point, close to the western shore. The Thousand Islands were on July 16 entirely surrounded with ice, stretching about a mile out to sea on the west side. From High Rocks an ice-field runs to the south-south-west. The wind was generally northerly and light, with alternating fogs and clear weather. Deicrow's Sound was entirely free from ice, but, at Black Point, passage between Halfmoon and the other islands was impossible. Encountering the ice on July 20, west of Whales Point, he found no change in its state. On July 22 the edge of the ice was lying from High Rocks to the southern point of Hope Island. For two days a thick fog prevailed. On July 24 the southern point of Hope Island was passed, where close ice stretched south-south-west. The wind was during this week slight, but came alternately from all quarters, sometimes with rain and fog. On July 28 the current set the ice southwards, so that the Thousand Islands were in open water, and towards Hope Island only a few floes were seen. The Halfmoon Islands were in clear water. On the 29th the wind fell, "ice-blink," i.e. the reflection of new ice in the sky, being seen to the eastward. On the 30th compact ice was encountered south of Ryk Vs's Islands. On July 31 Whales Point was found free from ice. On August 4 the country at the mouth of Walter Thyrnen Strait was perfectly free from ice, only old glaciers being visible on the mountains. The grass was quite out. The north-eastern part of Hans Foreland forms a great low plateau with good grazings for the reindeer, where large herds are found. The reindeer were in a very good condition, a circumstance which further proves the early and mild spring of last year. On the afternoon of August 6 the temperature in the shade was 12° C., and that of the surface of the water 9° C. On the night of the 17th a little snow fell in the mountains. An old ox, castrated and marked in the ear, was shot. It was believed to be one of those which escaped from Nordenskjöld at Mossel Bay in 1872. East of Hans Foreland

and Barents Land there was then no trace of ice; in fact the sea ran mountains high on that side.

THE last volume of the *Memoirs of the Russian Geographical Society* (vol. xii. No. 4) contains the "Memoirs of the Interpreter Otano Kigoro on Corea," translated from the Japanese by M. Dmitrevsky. The author was interpreter of the Korean language on the Tsousima Island, and compiled his book in 1794 on information gathered from Korean officials, as also from Chinese and Japanese works on Corea. The Russian translator of this book has added to it most valuable information gathered especially from the great Korean Code, published in 1785 (Da-dyang-tun-byang), which contains a detailed description of Corea, as well as from several other Chinese and European works, such as the "History of the Korean Church," by Dallet. The extracts from the Korean Code are especially numerous and of great value. The work of Kigoro contains interesting descriptions of the "Customs at the Court," the provincial administration, the geography of Corea, its inhabitants, their customs, habitations, food, and agriculture, as also notes on the Korean administration, army, and literature.

THE last number of the *Irkutsk Vestest* contains an interesting paper by Dr. Martianoff on his journeys in the north-eastern part of the Minusinsk district. In a note on antiquities in the basin of the Yenisei M. Bogolubsky mentions, among others, that on the Ouzynjoul gold-washings on a river of the same name belonging to the basin of the Abakan, implements consisting of a red copper nail, a marmor ring, and a knife and an arrow of bone, were found, together with bones of mammoth, rhinoceros, *Bos urus*, horse, antelope, wolf, and domestic animals, at a depth of from ten to thirteen feet. If implements from different levels were not confounded together, this find would surely be of great value. We notice also a note on a little-known subject, the "Scythic disease" among Aleutes and Kamchadales, by M. Grebnitzky, and another on the rapids of the Angara, with a map.

THE prospects of a trade between Europe and Siberia, through the Kara Sea, do not seem to be cheering. According to a private correspondent in Moscow, the steamer *Dallmann*, built at the Vulcan Engineering Works, Stettin, for towing on the Yenisei, lies at the trading station, Strelka, 75 versts south of Yeniseisk, where also two iron lighters of 5000 poods carrying capacity, and a wooden one capable of carrying 2000 poods, as well as two steam launches, now are. They are all to be sold, along with the buildings, depots, and factories at Strelka and the stations not far from the mouth of the Yenisei, about 800 versts north of Turukhansk. At the latter station large quantities of wheat, rye, and oats have been collected with a view to being exported to Europe. There seems at present little probability of their ever reaching their destination. During the last five or six years the steamer *Louise* has only twice succeeded in reaching the Yenisei and returning with cargo to Europe; three times the vessel failed in the attempt.

THE last issue of the *Journal of the Ceylon Branch of the Royal Asiatic Society* (Colombo, 1883) is wholly occupied by a translation of that part of Ibn Batuta's travels relating to Ceylon and the Maldiv Islands, accompanied by notes. The account of the customs of the primitive inhabitants of the Maldives is especially interesting.

### ON THE NOMENCLATURE, ORIGIN, AND DISTRIBUTION OF DEEP-SEA DEPOSITS<sup>1</sup>

#### III.

IT remains now to point out the area occupied by the red clay. We have seen how it passes at its margins into organic calcareous oozes, found in the lesser depths of the abyssal regions, or into the siliceous organic oozes or terrigenous deposits. In its typical form the red clay occupies a larger area than any of the other true deep-sea deposits, covering the bottom in vast regions of the North and South Pacific, Atlantic, and Indian Oceans. As above remarked, this clay may be said to be universally distributed over the floor of the oceanic basins; but it only appears as a true deposit at points where the siliceous and calcareous organisms do not conceal its proper characters.

Having now indicated its distribution, we must consider the mode of its formation, and give, in addition, a concise descrip-

<sup>1</sup> A Paper read before the Royal Society of Edinburgh by John Murray and René Renard. Communicated by John Murray. Continued from p. 117.

tion of the minerals and of the organic remains which are commonly associated with it. The origin of these vast deposits of clay is a problem of the highest interest. It was at first supposed that these sediments were composed of microscopic particles arising from the disintegration of the rocks by rivers and by the waves on the coasts. It was believed that the matters held in suspension were carried far and wide by currents, and gradually fell to the bottom of the sea. But the uniformity of composition presented by these deposits was a great objection to this view. It could be shown, as we have mentioned above, that mineral particles, even of the smallest dimensions, continually set adrift upon disturbed waters must, owing to a property of sea water, eventually be precipitated at no great distance from land. It has also been supposed that these argillaceous deposits owe their origin to the inorganic residue of the calcareous shells which are dissolved away in deep water, but this view has no foundation in fact. Everything seems to show that the formation of the clay is due to the decomposition of fragmentary volcanic products, whose presence can be detected over the whole floor of the ocean.

These volcanic materials are derived from floating pumice and volcanic ashes ejected at great distances by terrestrial volcanoes, and carried far by the winds. It is also known that beds of lava and of tufa are laid down upon the bottom of the sea. This assemblage of pyrogenic rocks, rich in aluminous silicates, decomposes under the chemical action of the water, and gives rise, in the same way as do terrestrial volcanic rocks, to argillaceous matters, according to reactions which we can always observe on the surface of the globe, and which are too well known to need special mention here.

The detailed microscopic examination of hundreds of soundings has shown that we can always demonstrate in the argillaceous matter the presence of pumice, of lapilli, of silicates, and other volcanic minerals in various stages of decomposition.

As we have shown in another paper,<sup>1</sup> the deposit most widely distributed over the bed of modern seas is due to the decomposition of the products of the internal activity of the globe, and the final result of the chemical action of sea water is seen in the formation of this argillaceous matter, which is found everywhere in deep-sea deposits, sometimes concealed by the abundance of siliceous or calcareous organisms, sometimes appearing with its own proper characteristics associated with mineral substances, some of which allow us to appreciate the extreme slowness of its formation, or whose presence corroborates the theory advanced to explain its origin.

In the places where this red clay attains its most typical development, we may follow, step by step, the transformation of the volcanic fragments into argillaceous matter. It may be said to be the direct product of the decomposition of the basic rocks, represented by volcanic glasses, such as hyalomelan and tachylite. This decomposition, in spite of the temperature approximating to zero (32° F.), gives rise, as an ultimate product, to clearly crystallised minerals, which may be considered the most remarkable products of the chemical action of the sea upon the volcanic matters undergoing decomposition. These microscopic crystals are zeolites lying free in the deposit, and are met with in greatest abundance in the typical red clay areas of the Central Pacific. They are simple, twinned, or spheroidal groups, which scarcely exceed half a millimetre in diameter. The crystallographic and chemical study of them shows that they must be referred to Christianite. It is known how easily the zeolites crystallise in the pores of eruptive rocks in process of decomposition; and the crystals of Christianite, which we observe in considerable quantities in the clay of the centre of the Pacific, have been formed at the expense of the decomposing volcanic matters spread out upon the bed of that ocean.

In connection with this formation of zeolites, reference may be made to a chemical process whose principal seat is the red clay areas, and which gives rise to nodules of manganiferous iron. This substance is almost universally distributed in oceanic sediments, yet it is not so much of the areas of its abundance that we intend to speak as to the fact of its occurrence in the red clay, because this association tends to show a common relation of origin. It is exactly in those regions where there is an accumulation of pyroxenic lavas in decomposition, containing silicates with a base of manganese and iron, such for example as augite, hornblende, olivine, magnetite, and basic glasses, that manganese nodules occur in greatest numbers. In the regions where the sedimentary action, mechanical and organic, is, as it were,

suspended, and where, as will appear in the sequel, everything shows an extreme slowness of deposition,—in these calm waters favourable to chemical reactions, ferro-manganiferous substances form concretions around organic and inorganic centres.

These concentrations of ferric and manganic oxides, mixed with argillaceous materials whose form and dimensions are extremely variable, belong generally to the earthy variety or wad, but pass sometimes, though rarely, into varieties of hydrated oxide of manganese with distinct indications of radially fibrous crystallisation. The interpretation to which we are led, in order to explain this formation of manganese nodules, is the same as that which is admitted in explanation of the formation of coatings of this material on the surface of terrestrial rocks. These salts of manganese and iron, dissolved in water by carbonic acid, then precipitated in the form of carbonate of protoxide of iron and manganese, become oxidised, and give rise in the calm and deep oceanic regions to more or less pure ferro-manganiferous concretions. At the same time it must be admitted that rivers may bring to the ocean a contribution of these same substances.

Among the bodies which, in certain regions where red clay predominates, serve as centres for these manganiferous nodules, are the remains of Vertebrates. These remains are the hardest parts of the skeleton—tympenic bones of whales, beaks of Ziphius, teeth of sharks; and just as the calcareous shells are eliminated in the depths, so all the remains of the larger Vertebrates are absent, except the most resistant portions. These bones often serve as a centre for the manganese iron concretions, being frequently surrounded by layers several centimetres in thickness. In the same dredgings in the red clay areas some sharks' teeth and Cetacean ear-bones, some of which belong to extinct species, are surrounded with thick layers of the manganese, and others with merely a slight coating. We will make use of these facts to establish the conclusions which terminate this paper.

In these red clays there occur in addition the greatest number of cosmic metallic spherules, or chondres, the nature and characters of which we have pointed out elsewhere.<sup>1</sup> We merely indicate their presence here, as we will support our conclusions by a reference to their distribution.

Reviewing, then, the distribution of oceanic deposits, we may summarise thus:—

- (1) The terrigenous deposits, the blue muds, green muds and sands, red muds, volcanic muds and sands, coral muds and sands, are met with in those regions of the ocean nearest to land. With the exception of the volcanic muds and sands, and coral muds and sands around oceanic islands, these deposits are found only lying along the borders of continents and continental islands, and in inclosed and partially inclosed seas.
- (2) The organic oozes and red clay are confined to the abyssal regions of the ocean basins; a Pteropod ooze is met with in tropical and subtropical regions in depths less than 1500 fathoms, a Globigerina ooze in the same regions between the depths of 500 and 2800 fathoms, a Radiolarian ooze in the central portions of the Pacific at depths greater than 2500 fathoms, a Diatom ooze in the Southern Ocean south of the latitude of 45° south, a red clay anywhere within the latitudes of 45° north and south at depths greater than 2200 fathoms.

*Conclusions.*—All the facts and details enumerated in the foregoing pages point to certain conclusions which are of considerable geological interest, and which appear to be warranted by the present state of our investigations.

We have said that the debris carried away from the land accumulates at the bottom of the sea before reaching the abyssal regions of the ocean. It is only in exceptional cases that the finest terrigenous materials are transported several hundred miles from the shores. In place of layers formed of pebbles and clastic elements with grains of considerable dimensions, which play so large a part in the composition of emerged lands, the great areas of the ocean basins are covered by the microscopic remains of pelagic organisms, or by the deposits coming from the alteration of volcanic products. The distinctive elements that appear in the river and coast sediments are, properly speaking, wanting in the great depths far distant from the coasts. To such a degree is this the case that in a great number of soundings, from the centre of the Pacific for example, we have not been able to distinguish mineral particles on which the mechanical action of water had left its imprint, and quartz is so rare that it may be said to be absent. It is sufficient to indicate these facts in order to make apparent the profound differences which separate the de-

<sup>1</sup> "On Cosmic and Volcanic Dust," *Proc. Roy. Soc. Edin.*, 1883-84.

<sup>1</sup> "On Cosmic and Volcanic Dust," *Proc. Roy. Soc. Edin.*, 1883-84.



posits of the abysmal areas of the ocean basins from the series of rocks in the geological formations. As regards the vast deposits of red clay, with its manganese concretions, its zeolites, cosmic dust, and remains of Vertebrates, and the organic oozes which are spread out over the bed of the Central Pacific, Atlantic, and Indian Oceans, have they their analogues in the geological series of rocks? If it be proved that in the sedimentary strata the pelagic sediments are not represented, it follows that deep and extended oceans like those of the present day cannot formerly have occupied the areas of the present continents, and as a corollary the great lines of the ocean basins and continents must have been marked out from the earliest geological ages. We thus get a new confirmation of the opinion of the permanence of the continental areas.

But without asserting in a positive manner that the terrestrial areas and the areas covered by the waters of the great ocean basins have had their main lines marked out since the commencement of geological history, it is, nevertheless, a fact, proved by the evidence derived from a study of the pelagic sediments, that these areas have a great antiquity. The accumulation of sharks' teeth, of the ear-bones of Cetaceans, of manganese concretions, of zeolites, of volcanic material in an advanced state of decomposition, and of cosmic dust, at points far removed from the continents, tend to prove this. There is no reason for supposing that the parts of the ocean where these Vertebrate remains are found are more frequented by sharks or Cetaceans than other regions where they are never or only rarely dredged from the deposits at the bottom. When we remember also that these ear-bones, teeth of sharks, and volcanic fragments, are sometimes incrustated with two centimetres of manganese oxide, while others have a mere coating, and that some of the bones and teeth belong to extinct species, we may conclude with great certainty that the clays of these oceanic basins have accumulated with extreme slowness. It is indeed almost beyond question that the red clay regions of the Central Pacific contain accumulations belonging to geological ages different from our own. The great antiquity of these formations is likewise confirmed in a striking manner by the presence of cosmic fragments, the nature of which we have described ("On Cosmic and Volcanic Dust," *Proc. Roy. Soc. Edin.*). In order to account for the accumulation of all the substances in such relatively great abundance in the areas where they were dredged, it is necessary to suppose the oceanic basins to have remained the same for a vast period of time.

The sharks' teeth, ear-bones, manganese nodules, altered volcanic fragments, zeolites, and cosmic dust are met with in greatest abundance in the red clays of the Central Pacific, at that point on the earth's surface furthest removed from continental land. They are less abundant in the Radiolarian ooze, are rare in the Globigerina, Diatom, and Pteropod oozes, and they have been dredged only in a few instances in the terrigenous deposits close to the shore. These substances are present in all the deposits, but owing to the abundance of other matters in the more rapidly forming deposits their presence is masked, and the chance of dredging them is reduced. We may then regard the greater or less abundance of these materials, which are so characteristic of a true red clay, as being a measure of the relative rate of accumulation of the marine sediments in which they lie. The terrigenous deposits accumulate most rapidly, then follow in order Pteropod ooze, Globigerina ooze, Diatom ooze, Radiolarian ooze, and, slowest of all, red clay.

From the data now advanced, it appears possible to deduce other conclusions important from a geological point of view. In the deposits due essentially to the action of the ocean, we are at once struck by the great variety of sediments which may accumulate in regions where the external conditions are almost identical. Again, marine faunas and floras, at least those of the surface, differ greatly, both with respect to species and to relative abundance of individuals, in different regions of the ocean; and as their remains determine the character of the deposit in many instances, it is legitimate to conclude that the occurrence of organisms of a different nature in several beds is not an argument against the synchronism of the layers which contain them.

The small extent occupied by littoral formations, especially those of an arenaceous nature, shown by our investigations, and the relatively slow rate at which such deposits are formed along a stable coast, are matters of importance.

In the present state of things there does not appear to be anything to account for the enormous thickness of the clastic sediments making up certain geological formations, unless we

consider the exceptional cases of erosion which are brought into play when a coast is undergoing constant elevation or subsidence.

Great movements of the land are doubtless necessary for the formation of thick beds of transported matter like sandstones and conglomerates.

In this connection may be noted the fact that in certain regions of the deep sea no appreciable formation is now taking place. Hence the absence, in the sedimentary series, of a layer representing a definite horizon must not always be interpreted as proof either of the emergence of the bottom of the sea during the corresponding period, or of an ulterior erosion. Arenaceous formations of great thickness require seas of no great extent and coasts subject to frequent oscillations, which permit the shores to advance and retire. Along these, through all periods of the earth's history, the great marine sedimentary phenomena have taken place.

The continental geological formations, when compared with marine deposits of modern seas and oceans, present no analogues to the red clays, Radiolarian, Globigerina, Pteropod, and Diatom oozes. On the other hand, the terrigenous deposits of our lakes, shallow seas, inclosed seas, and the shores of the continents, reveal the equivalents of our chalks, greensands, sandstones, conglomerates, shales, marls, and other sedimentary formations. Such formations as certain Tertiary deposits of Italy, Radiolarian earth from Barbados, and portions of the Chalk where pelagic conditions are indicated, must be regarded as having been laid down rather along the border of a continent than in a true oceanic area. On the other hand, the argillaceous and calcareous rocks recently discovered by Dr. Guppy in the upraised coral islands in the Solomon Group are nearly identical with the Pteropod and Globigerina oozes of the Pacific.

Regions situated similarly to inclosed and shallow seas and the borders of the present continents appear to have been, throughout all geological ages, the theatre of the greatest and most remarkable changes; in short, all, or nearly all, the sedimentary rocks of the continents would seem to have been built up in areas like those now occupied by the terrigenous deposits, which we may designate "*the transitional or critical area of the earth's surface.*" This area occupies, we estimate, about two-eighths of the earth's surface, while the continental and abysmal areas occupy each about three-eighths.

During each era of the earth's history the borders of some lands have sunk beneath the sea and been covered by marine sediments, while in other parts the terrigenous deposits have been elevated into dry land, and have carried with them a record of the organisms which flourished in the sea of the time. In this transitional area there has been throughout a continuity of geological and biological phenomena.

From these considerations it will be evident that the character of a deposit is determined much more by distance from the shore of a continent than by actual depth; and the same would appear to be the case with respect to the fauna spread over the floor of the present oceans. Dredgings near the shores of continents, in depths of 1000, 2000, or 3000 fathoms, are more productive both in species and individuals than dredgings at similar depths several hundred miles seawards. Again, among the few species dredged in the abysmal areas furthest removed from land, the majority show archaic characters, or belong to groups which have a wide distribution *in time* as well as over the floor of the present oceans. Such are the Hexactinellida, Brachiopoda, Stalked Crinoids and other Echinoderms, &c.

As already mentioned, the transitional area is that which now shows the greatest variety in respect to biological and physical conditions, and in past time it has been subject to the most frequent and the greatest amount of change. The animals now living in this area may be regarded as the greatly modified descendants of those which have lived in similar regions in past geological ages, and some of whose ancestors have been preserved in the sedimentary rocks as fossils. On the other hand, many of the animals dredged in the abysmal regions are most probably also the descendants of animals which lived in the shallower waters of former geological periods, but descended into deep water to escape the severe struggle for existence which must always have obtained in those depths affected by light, heat, motion, and other conditions. Having found existence possible in the less favourable and deeper water, they may be regarded as having slowly spread themselves over the floor of the ocean, but without undergoing great modifications, owing to the extreme uniformity of the conditions and the absence of competition. Or we may suppose that, in the depressions which

have taken place near coasts, some species have been gradually carried down to deep water, have accommodated themselves to the new conditions, and have gradually migrated to the regions far from land. A few species may thus have migrated to the deep sea during each geological period. In this way the origin and distribution of the deep-sea fauna in the present oceans may in some measure be explained. In like manner, the pelagic fauna and flora of the ocean is most probably derived originally from the shore and shallow water. During each period of the earth's history a few animals and plants have been carried to sea, and have ultimately adopted a pelagic mode of life.

Without insisting strongly on the correctness of some of these deductions and conclusions, we present them for the consideration of naturalists and geologists, as the result of a long, careful, but as yet incomplete, investigation.

### THE FIXED STARS<sup>1</sup>

THERE is no science which has so long and so continuously occupied the thoughtful minds of successive generations of men as has astronomy; and of its various branches there is one which has for all ages possessed a special fascination, viz. that of sidereal astronomy.

There has ever been a desire to burst aside the constraints imposed upon our research by the distances of space, to pass from the study of the planets of our solar system to that of the suns and galaxies that surround us, to determine the position and relative importance of our own system in the scheme of the universe and the whence we have come and the whither we are drifting through the realms of space.

Questions without number crowd upon the mind. The galaxy or Milky Way—what is it? Is our sun one of its members? What is the shape of that galaxy? What are its dimensions? What is the position of our sun in it?

The star-clusters—what are they, these wondrous aggregations where hundreds and even thousands of suns may be seen in the limited field of view of a powerful telescope? Are these clusters galaxies? Have these suns real dimensions comparable with those of our sun, and is it distance alone that renders their light and dimension so insignificant to the naked eye? Or are the real dimensions of the clusters small as compared with our galaxy? Are their component suns but the fragments of some great sun that has been shattered by forces unknown to us, or have they originated from chaotic matter, which, instead of forming one great whirlpool and condensing by vortex action into one great sun, has been disturbed into numerous minor vortices, and so become rolled up into numerous small suns?

The nebulae—what are they? Are they too condensing into clusters or stars, or will their ghost-like forms remain for ever unchanged amongst the stars? or do they play some part in the scheme of nature of which we have as yet no conception?

These and many others are the questions which press on the ardent mind that contemplates the subject; and there arises the intense desire to answer such questions, and where facts are wanting to supply facts by fancy. The history of deep and profound thought in some of these subjects goes back through 2000 years, but the history of real progress is but as of yesterday. The foundation of sidereal astronomy may be said to have begun with the art of accurate observation. Bradley's meridian observations at Greenwich about 1750, his previous discovery of the aberration of light in 1727, and Herschel's discovery of the binary nature of double stars, his surveys of the heavens, and his catalogues of double stars—these are solid facts, facts that have contributed more to the advancement of sidereal astronomy than all the speculations of preceding centuries. They point to us the lesson that "art is long and life is short," that human knowledge, in the slow developing phenomena of sidereal astronomy, must be content to progress by the accumulating labours of successive generations of men, that progress will be measured for generations yet to come more by the amount of honest, well-directed and systematically-discussed observation than by the most brilliant speculation, and that in observation concentrated systematic effort on a special thoughtfully-selected problem will be of more avail than the most brilliant but disconnected work.

I hope that no one present thinks from what I have said that I undervalue the imaginative fervid mind that longs for the truth,

<sup>1</sup> Lecture on Friday evening, May 23, at the Royal Institution, "On Recent Researches on the Distances of the Fixed Stars, and on some Future Problems in Sidereal Astronomy," by David Gill, LL.D., F.R.S., Her Majesty's Astronomer at the Cape of Good Hope.

and whose fancy delights to speculate on these great subjects. On the contrary, I think and I believe that without that fervid mind, without that longing for the truth, no man is fitted for the work required of him in such a field—for it is such a mind and such desires that alone can sweeten the long watches of the night, and transform such work from drudgery into a noble labour of love.

It is for like reasons that I ask you to leave with me the captivating realms of fancy this evening, and to enter the more substantial realms of fact. And if at any time I should become too technical or dry I beg that you too will remember the noble problems for the solution of which such dry work is undertaken.

We suppose ourselves then face to face with all the problems of sidereal astronomy to which I have hastily referred—the human mind is lost in speculation, and we are anxious to establish a solid groundwork of fact.

Now what in such circumstances would be the instinct of the scientific mind?

The answer is unquestionable—viz. to measure—and no sooner were astronomical instruments made of reasonable exactness than astronomers did begin to measure, and to ask, are the distances of the fixed stars measurable?

I should like to have given a short history of the early attempts of astronomers to measure the distance of a fixed star. I had indeed prepared such an account, but I remembered that there is in this theatre a relentless clock that has curbed the exuberant verbosity of many a lecturer before me, and I found that if the real subject-matter of this evening's lecture were to be reached and dealt with before 10 o'clock, I must pass over this earlier history, instructive and interesting though it is, and come at once to the time when the long baffled labours of astronomers began to be crowned with success.

Perhaps I cannot summarise it better than in the words of Sir John Herschel. In one of his presidential addresses he says:—"The distance of every individual body in the universe from us is necessarily admitted to be finite. But though the distance of each particular star be not in strictness infinite, it is yet a real and immense accession to our knowledge to have measured it in any one case. To accomplish this has been the object of every astronomer's highest aspirations ever since sidereal astronomy acquired any degree of precision. But hitherto it has been an object which, like the fleeting fires that dazzle and mislead the benighted wanderer, has seemed to suffer the semblance of an approach only to elude his seizure when apparently just within his grasp, continually hovering just beyond the limits of his distinct apprehension, and so leading him on in hopeless, endless, and exhausting pursuit."

Those who have read the history of exact astronomy from the days of Flamsteed—*i.e.* from 1689—down to 1832, will understand how exactly these words of Sir John Herschel describe the position of the problem.

But these laborious pursuits, like all honest researches in quest of truth, were not without reward, even though the immediate object in view was not attained. Bradley was rewarded by his great discovery of aberration, and Sir William Herschel by the greatest of his great discoveries, the binary nature of double stars, when engaged in vain attempts to measure the distance of a fixed star. Time forbids that I should tell more of this instructive story—for the story of failure is often fully as instructive as that of success—and I must begin the history of our problem between 1832 and 1842, when success was first attained.

But before I begin it will save both time and circumlocution if I define a word that we must frequently use—viz. the word *parallax*.

Here on the table is a large ball representing the sun, and here, travelling on a circular railway round the larger ball, is a smaller ball which we shall suppose to represent the earth. The larger ball is suspended from the ceiling by a white string, the small ball is suspended from the same point by a red string. At the far end of the white string you can suppose a star whose true direction is represented by this white string, and whose apparent direction as looked at from the earth is represented by the red string. Now if the star is within a measurable distance, the red string which indicates the star's apparent direction as seen from the earth will always be displaced inwards towards the sun. This displacement is called "*parallax*." It may be defined as the change in the apparent place of a star produced by viewing it from a point other than that of reference. Our point of reference for stars is the sun, and as we view the stars now from one side of the sun, and six months afterwards from a point on the

opposite side of the sun—that is, from two points 186 millions of miles apart—we might expect to find a considerable change in their apparent places.

But previous to 1832 astronomers could not discover with any certainty that such changes were sensible—that, in other words, the red and the white strings met at a point so distant that, as far as they were able to measure, the two strings were practically parallel—or, putting it another way, the stars were so distant that the diameter of the earth's orbit viewed from the nearest star subtended a smaller angle than their instruments could measure. Bradley felt sure that if the star  $\gamma$  Draconis were so near that its parallax amounted to 1" of arc he would have detected it—that is, if the earth's orbit viewed from  $\gamma$  Draconis measured 2" in diameter, that is, if it looked as big as a globe one foot in diameter would look if viewed at forty miles distant, he would have detected it. But the real distances of the stars were greater than that.

The time at last arrived when the two great masters of modern practical astronomy, Bessel and Struve, were preparing by elaborate experiment and study for the researches which led to ultimate success. After vain attempts to obtain conclusive results by endeavours to determine the apparent changes in the absolute direction of a star at different seasons of the year, both astronomers had recourse to a method which, originally proposed by Galileo in 1632, was carried out first on a large scale by Sir William Herschel. I shall refer in the first place to the researches of the great Russian astronomer Struve.

Astronomers had sufficiently demonstrated that the distances of the stars were very great, and it was reasonable to argue that as a rule the brighter stars would be those nearest to us. If, therefore, two stars are apparently near each other—the one bright, the other faint—the chances are that in reality they are far apart, though accidentally nearly in a line.



FIG. 1.

If two such stars are represented by  $s$  &  $S$  in Diagram 1., they would appear near each other viewed from one side of the earth's orbit at A, but not so near each other viewed from B, the opposite side of the earth's orbit, the red lines obviously indicating the apparent angle between the stars when they are viewed from A, and the black lines the apparent angle when they are viewed from B. Struve selected for the star  $s$  the bright star Vega ( $\alpha$  Lyrae). From its brilliancy he considered it probably one of our nearest neighbours amongst the stars, and a faint star apparently near it seemed to afford a suitable representative of the really distant star  $S$ . Struve was careful to ascertain that this comparison star was not physically connected with a Lyrae, and he was able to prove this from the fact that whilst  $\alpha$  Lyrae has a small annual motion relative to all neighbouring stars, this motion is not shared by the faint comparison star. Struve was provided with a telescope driven by clockwork to follow the diurnal motion of a star, and thus the hands of the observer were free to make the necessary measures. These were accomplished by an instrument such as I hold in my hands applied to the telescope. This micrometer contains two parallel spider webs each attached to a slide, one slide being moved by one screw, the other by the other screw. The screws are provided with drum-heads divided into 100 parts. One web was placed on the image of  $\alpha$  Lyrae, the other upon that of the faint comparison star, and the angle between the stars was thus read off in terms of the number of revolutions and decimals of a revolution of the screws. A number of such observations was made on each night, and the result for each night depended on the mean of the numerous observations made each night.

By observations on ninety-six nights between November 1835 and August 1838, he showed that the distance between  $\alpha$  Lyrae and the faint comparison star changed systematically with a regular annual period, and that the maxima and minima of those distances corresponded with the times of the year at which these

maxima and minima should occur if the brighter star were really much nearer than the fainter one.

Assuming that the fainter star is at a practically immeasurable distance, Struve showed that  $\alpha$  Lyrae had a parallax that amounted to about a quarter of a second of arc, which is equivalent to the statement that a globe whose diameter is equal to that of the earth's orbit—that is, to 186,000,000 of miles—would at the distance of  $\alpha$  Lyrae present an apparent diameter of half a second of arc. If you wish to realise this angle, place a globe one foot in diameter at a distance of eighty miles, or look at a coin half the diameter of a silver threepenny piece at a distance of one mile from the eye, and try to measure it.

The great German astronomer, Bessel, was simultaneously engaged in like work at Königsberg. He selected as the object of his researches a very remarkable double star—61 Cygni.

This star had already been the subject of similar researches on his part with much inferior means. He now attacked the problem with the splendid heliometer which had been made for him by Fraunhofer for the purpose. The principle of this instrument I shall presently explain. His reasons for choosing 61 Cygni were that the two components of this star, though not remarkable for brightness—they are just visible to the naked eye—yet have this peculiarity, that they have a remarkably large proper motion, the largest then known, though now surpassed by that of two other stars which I shall afterwards mention. They have an apparent angular motion relative to other stars of more than five seconds of arc per annum.

Struve had argued that if the stars were on the average of similar brightness, those stars which were brightest would probably be those nearest to us, and Bessel, in like manner, argued that if the absolute motions of the stars were similar on the average, those motions which appeared the largest belonged to stars which on the average were nearest to us—just as the motion of a snail could be easily watched at the distance of two or three feet from the eye, but could not be detected except after a long interval, if the animal were a good many yards distant.

Bessel employed two faint comparison stars at right angles to each other with respect to 61 Cygni, and he made two separate series of observations, the first extending from August 1837 to October 1838, the second from October 1838 to March 1840.

Both series confirm each other, and the results deduced separately from the measures of the two comparison stars also agree within very narrow limits. From all the observations combined Bessel found the parallax of 61 Cygni to be 35/100 of a second—a quantity which has been shown by the modern researches of Prof. Auwers and Dr. Ball to be more nearly half a second of arc. Thus at 61 Cygni the diameter of the earth's orbit round the sun would appear of the same size as a globe a foot in diameter viewed at forty miles distance, or of a silver threepenny piece a mile off. But whilst these great masters of astronomy—Struve and Bessel—had been exhausting the resources of their skill in observation, and that of the astronomical workshops of Europe in supplying them with the most refined instruments, a quiet and earnest man had been at work at the Cape of Good Hope, and, without knowing it at the time, had really made the first observations which afforded strong presumptive evidence of the existence of the parallax of any fixed star.

Henderson occupied the post of Her Majesty's Astronomer at the Cape of Good Hope in 1832 and 1833, and during his brief and brilliant tenure of office there he made, amongst many others, a fine series of meridian observations of a Centauri—a bright and otherwise remarkable double star. When, after his return to England, Henderson reduced these observations, and compared them with the earlier observations of other astronomers, he found that  $\alpha$  Centauri had a large proper motion; he was therefore led to examine and see whether his observations gave any indication of an annual parallax. He found that they did so, and not of a small parallax but of one amounting to nearly a second of arc. But it was not till this was confirmed, not only by the observations with the mural circle but by those of the transit instrument also, not only by his own observations but by those of Lieut. Meadows, his assistant, that Henderson ventured to publish his remarkable result.

In the year 1842 it was felt by the astronomical world at large that the problem which hitherto had baffled astronomers had begun to yield, that some approximation to the truth had at last been arrived at with regard to the distance of a fixed star, and it was fit and proper that the Royal Astronomical Society

of London should acknowledge the labours of him who had most effectually contributed to this end.

Henderson's results seemed sufficiently convincing, but they depended upon determinations of the absolute place of  $\alpha$  Centauri. The experiences of the skillful astronomer Brinkley at Dublin were still fresh in the minds of astronomers. He had arrived by similar though less perfect means at results like those of Henderson; but his results had been proved to be fallacious, though the causes of their being so still remain somewhat inexplicable. In the case of Struve's observations the weight of evidence which he produced and the excellence of his method were admitted, but men were not prepared by experience for accepting as accurate the minute changes of angle which Struve had to measure—nor, I am bound to admit, was the proof afforded by Struve's series of observations so entirely convincing as that afforded by the series of Bessel. Therefore to Bessel the well-earned medal was given, but the labours of Struve and Henderson received high and honourable mention. I quote from the speech of Sir John Herschel in awarding that medal. He says of Henderson's researches on  $\alpha$  Centauri:—

"Should a different eye and a different circle continue to give the same result, we must of course acquiesce in the conclusion; and the distinct and entire merit of the first discovery of the parallax of  $\alpha$  fixed star will rest indisputably with Mr. Henderson. At present, however, we should not be justified in anticipating a decision which time alone can stamp with the seal of absolute authority."

So much for Sir John Herschel's official opinion. I can state now, and as Henderson's successor I do so with pride and pleasure, that a different eye (that of his able and sympathetic successor, Sir Thomas Maclear) fully confirmed Henderson's result with another circle; and further, that Henderson's result has been still further confirmed by additional researches of which I shall presently speak.

I must now pass over briefly the history of succeeding researches, and indeed it has been so admirably and so recently told within these walls by Dr. Ball that it is quite unnecessary I should enter upon it in detail. The most reliable values arrived at for the parallaxes of the stars of the northern hemisphere are given in the following table, and to these results I shall afterwards refer:—

TABLE I.—Parallaxes of Stars which have been determined in the Northern Heavens with considerable Accuracy

	Magnitude	Proper motion	Parallax
61 Cygni	6	5'14	0'50
Lalande 21185	7½	4'75	0'50
$\alpha$ Tauri ... ..	1	0'19	0'52
34 Groombridge	8	2'81	0'29
Lalande 21258	8½	4'40	0'26
O.Mg. 17415	9	1'27	0'25
$\sigma$ Draconis ...	—	1'87	0'25
$\alpha$ Lyrae ... ..	1	0'31	0'20
$\rho$ Ophiuchi ...	4½	1'0	0'17
$\alpha$ Bootis... ..	1	2'43	0'13 ?
Groombridge 1830	7	7'05	0'09
Bradley 3077	6	2'09	0'07
85 Pegasi ... ..	6	1'38	0'05

The recent researches referred to in the title of this evening's lecture are some investigations which, in conjunction with a young American friend, Dr. Elkin, who was my guest for two years, I have recently carried out at the Cape of Good Hope.

The instrument employed was a heliometer—my own property—the good qualities of which I had previously tested at Mauritius in 1874 and at the Island of Ascension in 1877.

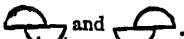
Now what is a heliometer? It is a telescope of which the object-glass is divided thus , and the two segments so formed can be moved with respect to each other, thus .

Here is a model which has been constructed to illustrate the principle of the instrument. You see that when the two segments are brought into what we may call their natural position, thus , that a heliometer differs in no way from an ordinary telescope—its divided lens produces a single image of a point of

light, as will be evident from the image of the single artificial disk now on the screen. In optical language, the optical centres of the two segments are in coincidence, and so the images produced by each segment of the lens are in coincidence. But now, if the segments are separated, either segment produces a separate image of the artificial star, and the separation of the images is proportional to the separation of the segments.

Now, to illustrate how this instrument is used in observation, let there be two artificial stars— $a$  and  $b$ . When the optical centres of the segments are in coincidence, we have on the screen—or in the field of view of the telescope—the images of these two stars. By separating the optical centres of the segments thus  we obtain double images of each of the stars  $a$  and  $b$ . Now

if we turn the direction of the line of motion of the divided segments parallel to the direction of the stars  $a$  and  $b$ , and if we separate the lenses sufficiently we can make one of the images of the star  $a$  coincide with one of the images of star  $b$ . Similarly if we cross the segments we can bring the second image of star  $b$  into coincidence with the second image of star  $a$ , and if we have finely divided scales attached to the slides by which the segments are separated we can read off, in terms of these scales, the amount of this separation, and this separation is obviously twice the angle between the stars  $a$  and  $b$ .

There is now upon the screen a photograph from a drawing illustrating the arrangements by which the segments of my heliometer are moved, and showing the scales by which the amount of the movement is measured; and these scales are read off by a powerful microscope from the eye end of the telescope, as in the photograph of the instrument now on the screen.

There is now on the screen a photograph of a drawing of the most perfect heliometer in the world, recently made by Messrs. Repsold of Hamburg for the Observatory of Yale College, New Haven, U.S. That instrument is now under the charge of my young friend, Dr. Elkin, of whom I have already spoken. If then we wish to observe the angle between two stars, it is only necessary to separate the segments of the object-glass by the required amount, to rotate the tube till the line of section of the object-glass is in the line joining the stars, to direct the axis of the telescope to a point in the heavens midway between the two stars under observation, and then we shall find in the field of view the two stars the angle between which we wish to measure. Then by slow and delicate changes in the distance of the optical centres of the segments, whilst the images of the stars are made to pass and re-pass through each other—thus—we are able to exactly adjust the angular distance of the segments to correspond truly with angular distance of the stars.

(To be continued.)

### UNIVERSITY AND EDUCATIONAL INTELLIGENCE

CAMBRIDGE.—The Museums and Lecture-Rooms Syndicate have recommended the immediate erection of a new lecture-room for physiology, with large additions to the rooms for practical physiology and to the work-rooms adjoining the Comparative Anatomy Museum, at an estimated cost of 7500*l.* These are to be carried along Corn Exchange Street. A work-room for the large class of Elementary Biology is also recommended to be built as an additional story above the Museum of Mineralogy, at a cost of about 2500*l.* It is also recommended that 1000*l.* be laid out in the purchase of microscopes.

The Board of Biology and Geology have modified their report respecting demonstrators and lecturers in Animal Morphology, on learning that the General Board of Studies cannot support their former proposals owing to the financial state of the University. They now ask for a lecturer on Vertebrates at 100*l.* and one on Invertebrates at 50*l.*, together with a demonstrator at 150*l.*, to be appointed by the Senior Lecturer in Animal Morphology.

The Rev. J. Venn, of Gonville and Caius College, has been approved for the degree of D.Sc.

### SOCIETIES AND ACADEMIES LONDON

Royal Society, May 15.—"Some Experiments on Metallic Reflection. No. V. On the Amount of Light Reflected by Metallic Surfaces. III." By Sir John Conroy, Bart., M.A. Communicated by Prof. G. G. Stokes, Sec.R.S.

*On Silvered Glass Mirrors.*—The first set of photometric determinations were made with a silver film deposited on a flat and well-polished glass plate 76.5 mm. long and 51 mm. wide.

The glass plate was weighed before and after being coated with silver, and the weight of the film was found to be 0.0035 grm.; assuming the density of the silver to be 10.62, that being the value for silver finely divided by precipitation given in "Watts's Dictionary," vol. v. p. 277, the thickness of the film calculated from the area and weight was 0.0008447 mm.

The film appeared opaque by ordinary daylight, but when examined with sunlight was seen to be slightly transparent and of a deep blue colour.

The photometrical determinations were made in exactly the same way as those with the speculum metal and steel mirrors (*Proc. Roy. Soc.* vol. xxxvi. p. 187), and the observations were about as concordant as those contained in the Tables I. and II. of the paper giving an account of the experiments.

Two complete series of observations were made with light polarised in, and perpendicularly to, the plane of incidence, and the results are given in Tables I. and II.

The angles of incidence are given in the first column, the percentage amount of light reflected in the second and third, the means of the two sets of observations in the fourth, and the amount of light which ought to have been reflected according to Cauchy's formulæ in the fifth.

TABLE I.—*Silver Film, with Light Polarised in the Plane of Incidence*

Angle of incidence	Observed		Calculated	
30	96.74	98.39	97.56	96.66
40	97.06	97.13	97.09	97.01
50	98.35	99.67	99.01	97.45
60	97.06	98.40	97.73	98.02
65	100.0	99.04	99.52	98.29
70	99.02	98.41	98.71	98.61
75	99.02	99.05	99.03	98.94

TABLE II.—*Silver Film, with Light Polarised Perpendicularly to the Plane of Incidence*

Angle of incidence	Observed		Calculated	
	C	Mean		
30	89.25	86.30	87.77	95.74
40	90.69	87.02	88.85	95.30
50	89.31	87.09	88.20	94.66
60	85.10	86.41	85.75	93.75
65	86.09	85.0	85.54	93.22
70	86.33	86.50	83.85	92.73
75	83.91	87.55	86.17	85.88

The principal incidences and the principal azimuths were determined, and the means of two sets of eight observations each are given in Table III.

The values of the principal azimuths are higher than any obtained before in the course of these experiments, whilst those of the principal incidences are nearly the same as those obtained with the silver plate polished with rouge (*Proc. Roy. Soc.* vol. xxxi. p. 493), but considerably in excess of the determinations previously made with silver films.

TABLE III.

Principal incidence	Principal azimuth
75 38	44 07
75 36	43 40
Mean .. 75 37	43 53

The calculated and observed values for the light polarised in the plane of incidence agree very fairly, the calculated values being slightly the lowest.

For light polarised perpendicularly to the plane there is considerable difference between the two sets of numbers, the calculated values being considerably the highest.

As has already been stated, the silver film was, to some extent at least, transparent, and it was found that when a Nicol was held between the eye and the silvered glass, and sunlight was incident obliquely upon the film, the brightness and colour of the transmitted light varied with the position of the Nicol; the image of the sun being brightest when the short diagonal of the Nicol was in the plane of incidence, and darkest and of a deep blue colour when the long diagonal was in that plane. Hence it would appear that at oblique incidences light which is polarised perpendicularly to the plane of incidence penetrates to a greater depth in the film than that polarised in the plane—a result that is in accordance with the conclusion drawn from the experiments with silver films already referred to, and one that may account for the difference in the observed and calculated intensities of light polarised perpendicularly to the plane of incidence reflected by the silver film.

In order to ascertain whether the difference between the observed and calculated results was really due to this cause or not, a thicker film was prepared by depositing a second coating of silver on a freshly-prepared film.

The same glass plate was used; the silver weighed 0.0072 grm., and its thickness was therefore 0.0001737 mm., or as nearly as possible double that of the single film.

The thick film was not absolutely opaque, as the disk of the sun on a clear day could just be seen through it, but it transmitted much less light than the film previously used.

Tables IV. and V. give the results of two series of observations made with it, and also the theoretical amount of light which should have been reflected, calculated from the values of the principal incidence and principal azimuth given in Table VI.

TABLE IV.—*Double Silver Film, with Light Polarised in the Plane of Incidence*

Angle of incidence	Observed		Calculated	
		Mean		
30	97.24	97.39	97.31	97.04
40	98.27	98.87	98.57	97.35
50	98.62	101.10	99.86	97.74
60	98.97	99.62	99.29	98.22
65	100.0	99.25	99.62	98.45
70	100.0	100.0	100.0	98.79
75	99.31	99.62	99.44	99.06

TABLE V.—*Double Silver Film, with Light Polarised Perpendicularly to the Plane of Incidence*

Angle of incidence	Observed		Calculated	
		Mean		
30	98.77	100.40	99.92	96.21
40	100.60	97.50	97.55	95.82
50	97.60	96.28	97.24	95.24
60	98.20	95.67	96.64	94.43
65	97.62	95.68	95.78	93.94
70	95.88	93.11	93.66	93.48
75	94.20	93.77	93.90	93.26

TABLE VI.

Principal incidence	Principal azimuth
75 50	43 52
75 45	44 07
Mean ... 75 47	44

The values of the principal incidence and azimuth are slightly higher than those obtained with the thinner film, and therefore the percentage amount of light which, according to theory, should be reflected by the silver, is also higher.

The tables show that both for light polarised in and perpendicularly to the plane of incidence the observed intensity exceeds the calculated intensity, in the former case by about 1, and in the latter by about 2 per cent., except at incidences of 30° with light polarised in the plane, and 70° and 75° for light polarised perpendicularly to the plane, for which angles the observed and calculated intensities agree closely.

These results appear to confirm the general conclusion arrived at in the former paper, that, although the received formulæ for metallic reflection are approximately correct, they are not a complete expression of the facts of the case.

**Zoological Society, May 20.**—Sir Joseph Fayrer, F.R.S. vice-president, in the chair.—Mr. W. T. Blanford, F.R.S., exhibited and made remarks on a series of horns of the Wild Sheep of the Pamir, *Ovis polii*, Blyth, which had been obtained by the Hon. Charles A. Ellis, F.Z.S., from the Pamir district during his recent journey to Yarkand.—Mr. R. Bowdler Sharpe exhibited and made remarks on a second specimen of the new European Nuthatch (*Sitta whiteheadi*) recently discovered by Mr. Whitehead in Corsica.—Dr. J. G. Garson exhibited and made remarks upon a specimen of *Lithodes maia*, the Northern Stone-Crab.—Mr. Frank E. Beddard, F.Z.S., read the first of a series of papers on the Isopoda collected during the voyage of H.M.S. *Challenger*. The present communication treated of the genus *Serolis*, sixteen species of which were represented in the specimens obtained during the expedition. Of these nine were described as new. The author also gave a short account of the geographical distribution of the genus, and pointed out some of its peculiar structural points.—Mr. Gwyn Jeffreys, F.R.S., read the eighth part of his papers on the Mollusca of the *Lightning* and *Porcupine* Expeditions. It included the families Acilidae, Pyramidellidae, and Eulimidæ, with seventy-five species. Two genera and twenty-three species were described by the author as new to science.—Prof. Jeffrey Bell read the fourth of his series of papers on the Holothurians. The present communication gave an account of the structural characters of the Cotton-Spinner (*Holothuria nigra*), and especially of its Cuvierian organs.—Mr. F. Day read a paper on races and hybrids among the Salmonidæ, in continuation of a former communication made to the Society, and continuing an account of the experiments made by Sir James Gibson-Maitland in the hybridisation of Salmonidæ in the ponds at Howietown.—A communication was read from Mr. R. Collett, C.M.Z.S., containing the description of some apparently new Marsupials obtained by Dr. Limholtz in Northern Queensland. These were described as *Phalangetta archeri*, *Ph. herbertensis*, *Ph. lemuroides*, and *Dendrolagus limholtzi*.

**Geological Society, May 14.**—Prof. T. G. Bonney, F.R.S., president, in the chair.—John Ruscoe was elected a Fellow of the Society.—The following communications were read:—On the pre-Cambrian rocks of Pembrokeshire, with especial reference to the St. David's district, by Dr. Henry Hicks, F.G.S., with an appendix by Thomas Davies, F.G.S. The author in this paper gave further detailed evidence in addition to that already submitted by him, to show that the Geological Survey Map of the district of St. David's and of other parts of Pembrokeshire is incorrect in some of its most essential features, and inaccurate in very many of its petrographical and stratigraphical details. Some new areas in South Pembrokeshire were also referred to. He replied also to the criticisms contained in the paper by the Director-General of the Survey, read last year before the Society, and indicated that Dr. Geikie had completely misunderstood the sections and the order of succession of the rocks at St. David's. He pointed out that the views so elaborately worked out by the Director-General to show the evidence of metamorphism in the rocks, were based on the entirely false supposition that the granitoid rocks were intrusive in the Cambrian rocks, and that the felsites were merely peripheral masses. He showed, by producing abundant fragments of the granitoid rocks and of the felsites from the basal Cambrian conglomerates, that the granitoid rocks were the very oldest rocks in the district, and that they must undoubtedly be of pre-Cambrian age. He proved, from microscopical evidence, that the rocks supposed to have been altered by the intrusion of the granitoid rocks, were in the condition in which they are now found before the Cambrian rocks were deposited, and, moreover, that the supposed concretions in the porcellanites and conglomerates, claimed to have been due to metamorphism, had turned out, on microscopical evidence, to be actually fragments of old pre-Cambrian rhyolites inclosed in the sediments. It was shown also that at the points indicated by the Director-General, where the evidences

of intrusion were supposed to be seen, there was not the slightest change of a metamorphic character induced in the sedimentary rocks in contact with the granitoid rocks. The only difference that could possibly be recognised in them by the aid of the microscope was such as is well known to be the result of crushing when in the neighbourhood of faults. Indeed there was the clearest evidence possible to show that the junctions were merely fault junctions. The supposed fold in the Peibidian rocks, the author stated, was impossible if petrological evidence was of any value. The author also produced many facts to show that the conglomerates at the base of the Cambrian constantly overlapped the different members of the series which he claimed to be of pre-Cambrian age, and that the unconformity was very marked and to be clearly seen in many coast sections. The conglomerates were shown also to contain well-rolled pebbles of all the series included under the names Dimetian, Arvonian, and Peibidian, as proved by careful microscopical examination of the fragments by Mr. T. Davies and himself. An appendix by Mr. Davies, describing the microscopical character of the rocks, accompanied the paper.—Note on a specimen of iron amianthus, by the Rev. J. Magens Mello, M.A., F.G.S. The accompanying specimen was found at the bottom of one of the Wingworth iron-furnaces, near Chesterfield, and was given to the author by Mr. Arthur Carrington, one of the owners. The furnaces have been lately blown out for repairs, and in the mass of slaggy refuse at the bottom a thin layer of the curious product known as iron amianthus was interposed between the sand and the iron refuse. The red sand at the bottom of the furnace was converted in its upper part into a compact, hard, white sandstone an inch or two in thickness, and upon the top of this the iron amianthus occurred in snow-white fibrous masses, the fibres radiating in a concentric manner, and forming more or less botryoidal concretions, somewhat resembling hæmatite in appearance, and separated by extremely thin plates or septa of iron, by which the entire mass is divided into irregular prisms of about half an inch in diameter.

**Physical Society, May 24.**—New member, Mr. F. C. Phillips, electric engineer.—Prof. W. G. Adams took the chair while the President, Dr. Guthrie, gave a brief summary of his recent researches on eutectic alloys, that is alloys of low fusing point. The complete research will be published in the Society's *Proceedings*. Dr. Guthrie showed by means of tables and curves of results that mixtures of water and nitre, nitre and nitrates, &c., behaved in the same way as fusible alloys, such as alloys of lead and bismuth. On cooling down the alloy or mixture, the ingredient present in richer quantity crystallised out. There seemed to be no definite molecular proportions in these alloys. A "tetra-eutectic" alloy of bismuth 47·38, tin 19·97, lead 19·36, cadmium 13·29 per cent., was exhibited by the author, which fused at 71°, or in boiling alcohol. Rose's fusible metal melts at 93°. Results were given of the behaviour of mixtures of water and the aniline salts, salicylate, oxalate, &c.; also of water and tri-ethylamine, and other members of the ammonia group. Dr. Guthrie's observations tended to show that fusion and solution were of the same nature. He pointed out their bearing on mineralogy and geology, and inferred that water in igneous rocks was there from the first, and not by infiltration, as some suppose.—The President then took the chair, and Dr. W. H. Stone exhibited a simple, cheap, and portable galvanometer for hospital use, made of a boxwood cylinder with coils wound round it, and a needle with mirror, inserted into a test-tube, and pushed into the hollow of the cylinder. The needle is made dead-beat by putting paraffin oil into the tube. He also exhibited a Kohlrausch metre bridge for alternating currents, a telephone playing the part of indicator. Dr. Stone employs it for measuring the resistance of the human body, which he finds to be less than 1000 ohms. With high-tension currents it appears lower than with low-tension currents. Another metre bridge of the kind with a longer wire (3 m. in this case as compared with  $\frac{1}{4}$  m. in the other) was also shown in connection with a sledge induction-coil, by which the power of the current can be regulated to suit the patient. Dr. Stone stated that the body acts more like a solid than a liquid conductor. Mr. Glazebrook said he had used a similar plan with a telephone to measure the resistance of electrolytes; but found the telephone too sensitive for induction, though in Dr. Stone's work this objection might not apply. Prof. G. Forbes stated that the telephone had been applied in a similar way to comparing capacities. With regard to the danger from currents, Prof. Ayrton said the E.M.F. of the railway current at Bushmills was 250 volts, and pointed out that very intermittent currents

were more dangerous than fairly continuous ones. Dr. Stone thought that with good skin contact (as with salt and water) this E.M.F. would be dangerous. Mr. Lecky instanced the reported death of a horse at Bushmills by a shock.—A new speed indicator, especially for marine engines, was exhibited by Mr. W. T. Gooden and Sir A. Campbell of Blythwood. Its action depended on the rolling of a disk on a cone, the disk traversing a screw driven by the engine-shaft. The disk forms the nut of the screw, and rotates in an opposite direction to the latter. Its position on the screw depends on the surface velocity of the cone, which is kept turning at a uniform rate by clockwork. In travelling, the disk makes a series of electric currents which indicate its position on a set of dials detached. Recording apparatus can be added. The apparatus was made by Mr. A. Hilger.—Mr. W. Baily exhibited a similar device, in which the cone was replaced by a circular plane or disk. He had invented this independently, and it had the advantage of giving a zero position to the rolling disk, though the cone was the more compact arrangement. The idea of using a screw in this manner was suggested by Mr. Shaw of Bristol some three years ago.

BERLIN

**Physiological Society, May 2.**—Dr. Bender gave a short description of a preparation which he exhibited at the end of the meeting. It was an axolotl in the stage of development in which the heart consists of a tube with a sacular expansion at one part, corresponding to the atrium, and then forms a loop, the ventricle, afterwards passing over into a second expansion, the bulb; the animal is in this stage still transparent enough to permit of the movement of the blood through the three chambers of the heart being seen distinctly.—Dr. Herter described the experiments which Dr. Lukjanow had made in his laboratory upon the influence of increased tension upon the absorption of oxygen. The question is of physiological importance because, if it is decided by experiment in the negative, the existence of an optimum amount of oxygen in the air will be proved, which would coincide with normal percentage proportion of oxygen in the air, whereas if the experiment should result in proving that the absorption of oxygen increases with the increase of the oxygen tension, then this oxygen absorption and the consequent oxidations would have to be included in the general combustion processes whose intensity is known to increase with the increased tension of oxygen. The experiments were conducted after the method of Regnault and Reiset. The animals were placed inside a bell-jar, into which the air entered on one side along with an additional quantity of oxygen, which could be varied at pleasure, and from which it was drawn off on the opposite side by a tube which passed into the absorption vessels where the carbonic acid was removed, and the residue was provided with fresh oxygen and led back into the bell-jar. An offset from the air tube allowed of a sample of the expired air being drawn off at any time for analysis. In all fifty animals were experimented upon, which were kept fasting for half a day before commencing the experiment. The oxygen of the inspired air varied between 30 and 90 per cent. The mean result of all the experiments on guinea-pigs, rats, dogs, and cats, was a slight increase of the oxygen absorption, to wit 104 volumes as against 100 absorbed from normal air. Dr. Herter is of opinion that this small increase cannot be regarded as a consequence of the increased oxygen tension, because, in individual animals, the means of oxygen absorption sometimes fell below, and sometimes exceeded the normal amounts, and further, because they did not vary proportionally with the increased tension of oxygen in the air. The small increase of the general mean must be referred to other causes, *i.e.* the movements of the animals during the experiments. No increase of temperature was observed under the increased pressure of oxygen. Further experiments were made upon animals in which one could assume an increased demand for oxygen in consequence of high fever being present, but not even did the animals that had fever take up more oxygen from the air that was charged with a more than normal amount of oxygen. Likewise, animals from whom a large quantity of blood had been withdrawn behaved in exactly the same way as normal animals in presence of the surplus of oxygen. The conclusion to be drawn from all these experiments is that the absorption of oxygen is not an ordinary combustion process, and that the normal composition of the atmosphere contains an optimum percentage amount of oxygen.—Prof. Busch spoke about caries of the teeth which has been so little scientifically investigated, because in studying it the external hurtful processes have been alone considered, whereas the second important factor, the resisting power

of the teeth, has been quite overlooked. In regard to the latter, Prof. Busch called attention to the fact that caries of the teeth had been observed in no animal, and that it appeared to be peculiar to man. Caries of the teeth, however, appears not to be a characteristic of civilised man alone, but it has been observed in large collections of skulls even in those of prehistoric time. Some races are more disposed to it than others. For instance, the Celtic, Arabian, and Polish races appear to possess a relative immunity. This is less the case with the Indo-Germanic race. Certain families are particularly predisposed to it. General habit of body has a pronounced influence upon its development, as well as menstruation and pregnancy in women, chlorosis, typhoid, &c. Disposition to caries shows itself even in the developing tooth in the composition of its enamel, which is undulating, whereas teeth with quite smooth enamel have much greater power of resistance. The enamel appears to be the only tissue in the body which is subject to no metabolism, and which remains quite unchanged. Every alteration in it which is caused by external influences, and every defect of the enamel remains during the whole of life, and can never be repaired. Dentine also shows differences in its structure as regards its disposition to caries. The dentine tubes either run regularly close side by side to each other, such teeth having a greater power of resistance; or the dentine tubes branch and surround cellular bodies, or even small air vesicles, such teeth falling an easy prey to caries. If dentine has been decalcified at any place by the action of acids, it undergoes putrefaction under the influence of bacteria which do not seem to belong to any specific species. Dentine is sensitive, although nerve filaments have not as yet been traced into it. Actual toothache does not occur in the course of caries until it has reached the pulp. The inflammation of the pulp is particularly violent and painful, because the tissue is so richly supplied with blood-vessels and nerve-filaments. As the products of inflammation cannot escape, they collect and work their way downwards, where they produce the most painful inflammation of the roots and the periosteum. The chief object of the rational treatment of caries of the teeth consists in the removal of every particle of carious substance out of the diseased tooth and to protect the sound dentine that has been exposed against external injurious influences by covering it with a firm substance which is not attacked by acids: gutta-percha, cement, or gold. Although the dentine is not as unchangeable as the enamel, but manifests, by its becoming firmer or softer, that it is not quite uninfluenced by tissue changes, yet its caries is not an irritative process that the dentine takes an active part in, but a passive process, and consequently the removal of all diseased portions, and the protection of the non-carious part of the tooth by filling with a resistant mass suffices to stay the morbid process completely.

CONTENTS

	PAGE
The Origin of the Crystalline Schists. By Arch. Geikie, F.R.S. . . . . .	121
Letters to the Editor:—	
The Marine Biological Association.—Prof. E. Ray Lankester, F.R.S. . . . . .	123
The Equatorial Coudé of the Paris Observatory.—Howard Grubb, F.R.S. . . . . .	123
The Earthquake.—J. Henry Kinahan; W. F. Stanley; Rev. O. Fisher . . . . .	124
Jupiter.—W. F. Denning . . . . .	125
Animal Intelligence.—Col. J. Herschel; Antoine d'Abbadie . . . . .	125
Meteorology in Victoria . . . . .	126
Habits of Burrowing Crayfishes in the United States. By Ralph S. Tarr. ( <i>Illustrated</i> ) . . . . .	127
The Young Gorilla of the Jardin des Plantes. ( <i>Illustrated</i> ) . . . . .	128
Notes . . . . .	129
Our Astronomical Column:—	
The Total Solar Eclipse of 1889, January 1 . . . . .	131
Variable Stars . . . . .	131
Geographical Notes . . . . .	131
On the Nomenclature, Origin, and Distribution of Deep-Sea Deposits, III. By John Murray and Rev. A. Renard . . . . .	132
The Fixed Stars. By David Gill, LL.D., F.R.S. ( <i>Illustrated</i> ) . . . . .	135
University and Educational Intelligence . . . . .	137
Societies and Academies . . . . .	137

THURSDAY, JUNE 12, 1884

## BRITISH MITES

*The British Oribatida.* By A. D. Michael. (Ray Society, 1884.)

WE congratulate the Ray Society on this valuable addition to their excellent series of monographs. Mr. Michael indeed modestly asks us to "kindly remember that this book is the record of work done in the scanty leisure of a very busy man," but though this may add to our gratitude, and serve as an encouragement to others, no one, we think, after reading the book will feel that any excuse or apology was needed. When Mr. Michael commenced his study of this curious family of mites scarcely any species were recorded as British, there were very few of which the whole life-history was known, and Nicolet's was the only work dealing with the anatomy of the family.

Mites are not perhaps a very attractive group, nevertheless many species are extremely curious and some very pretty, as a glance at Mr. Michael's excellent figures is sufficient to show, especially those of *Tegeocranus latus*, *Letosoma palmicinctum*, and *Cepheus ocellatus*; possibly indeed, says Mr. Michael, "no more bizarre or remarkable creatures exist than these, when nearly fully grown, and bearing on their backs, ring within ring, concentric circles or ovals of these curious and disproportionately large line-of-beauty shaped spines formed of clear, colourless chitin, and strongly serrated in the first species, and of the beautiful and iridescent membranous fans in the two latter."

Some, he adds, especially "of the immature stages are amongst the most beautiful creatures of the order; and only those who are not acquainted with the Acarina can suppose that none are beautiful. It is needless to say that the Oribatidæ are highly interesting and instructive, because the same thing may be said of every family of created beings; no one can devote himself to the study of any class of organism without becoming from day to day more deeply impressed with the admirable manner in which its members are adapted to their wants, and the marvellous way in which the different parts are varied in different species, so as to provide more efficiently for their protection and continuance. This fact of having constantly before his eyes the wonders of the individual family or order which he is investigating is apt to cause the specialist to forget for the time that there are hundreds of other families equally interesting, beautiful, and wonderful in their construction and life-histories. It is only by endeavouring to base his special knowledge upon the wider foundation of general interest in the works of nature that the naturalist escapes this error, and appreciates the harmony between the particular class and other equally glorious types of life. Endeavouring to bear all this in mind, I feel that I am not justified in saying that the Oribatidæ have any claim on the biologist beyond that of any of the endless varieties of other forms of animals; but I do say that they have an equal claim; and I think I may confidently assert that any observer who inquires into the complex structure

of these minute creatures, their singular life-histories, or the quaint and somewhat exceptional habits of some of the species, will rise from his task fully rewarded for the time that he has spent."

The work is divided into two parts: in the first the author gives an account of the terminology, literature, classification, development, habits, methods of collection and preparation, and anatomy; while the second is devoted to descriptions of the genera and species.

The principal home of the Oribatidæ is in moss of various sorts, on lichens, and in fungi; others live in dead wood, many are found in the debris under furze bushes, in the needles of which the nymphs burrow. Pelops, Hoplophora, and others are found among the fallen leaves of Scotch pines; some frequent other trees, while *Oribata sphagni* and *Notaspis lacustris* are aquatic. The whole family with one doubtful exception are vegetable feeders; and, being without any weapons of offence, are all the more in need of defensive arrangements, with which indeed they are liberally provided. Their carapace is thick, with in many cases curious provisions for the protection of the legs, and they most of them have the habit of shamming dead.

Mr. Michael differs from the account given by Nicolet of the internal anatomy in several important respects, and considers that the conspicuous organs, usually called stigmata, are really organs of sense, probably of hearing or smell, and he says, "I incline to the former."

The life-history falls into four well-marked periods—the egg, larva, nymph, and imago. Dujardin indeed asserted that the Oribatidæ are viviparous, and the statement has been repeated in various standard books, but as a general rule the reverse is the case. The egg is generally elliptical, or cylindrical with rounded ends. In some cases it absorbs moisture, and the exterior membrane, being hard and brittle, splits longitudinally and allows the inner or vitelline membrane to be seen through the opening. This constitutes the stage called by Claparède the "Deutovum."

The larva is invariably hexapod, and all six legs are monodactyle, tridactyle tarsi being confined to the imagos. The larval stage is comparatively short, generally lasting from three weeks to two or three months. Mr. Michael does not consider that the larva undergoes any change of skin until it passes into the nymph.

The nymph "may be defined as the creature after it has become octopod," but before the first month. It is the principal period of growth and occupies a considerable proportion of the lifetime; "it is also the time of gay colouring and of beauty." "When the nymph is fully fed, and is about to become an imago, it creeps into a hole, or some other sheltered position, stretches out its legs, fixing its large monodactyle claws firmly into the substance it is resting on, and then gradually becomes inert, perfectly motionless, and to all appearance dead; it ceases to feed, and does not exhibit any sign of life if touched or injured."

Mr. Michael coincides with the opinion of Claparède and Mégnin that during this period there is an entire re-organisation of the internal structures, and "the different parts of the body of the adult are formed, not at the expense of the same parts of the nymphs, but from the general body substance."



Till Mr. Michael traced the life-histories of these creatures, the immature stages of eight species only were known to us. Nicolet, indeed, gives eleven, but as to three he is, in Mr. Michael's opinion, certainly in error. In all other species the life-history when known has been traced by Mr. Michael himself.

In breeding Mr. Michael used glass cells "composed of ordinary microscopical glass slips  $3 \times 1$  inch, having in the centre, fastened by marine glue or Canada balsam, a glass ring made of a transverse slice of glass tubing about  $\frac{1}{4}$  or  $\frac{1}{8}$  inch in diameter, the length of the tube, and consequently the depth of the cells, being usually about  $\frac{1}{8}$  inch. The tubing I employ is of tolerably thin glass, if very thick it is opaque, and leaves little room inside the cell. Over this a thin glass cover, rather larger than the diameter of the tubing, was laid, either a circle or a square; the latter is often handy, as the projecting corners are convenient to take it on or off by, or sometimes a second slide or a broken piece of one is more serviceable. This cover was always quite loose, and simply held on by an ordinary brass-wire microscopical spring-clip; of course the upper edge of the slice of glass tube required to be smooth, so that the cover would lie flat upon it, and not allow the minute prisoners to escape. A cell so prepared was carefully cleaned out, and examined under the microscope, to see that it did not contain Acarina or ova. A small piece of thick white blotting-paper, not large enough to cover the whole bottom of the cell, was then placed in it and damped; a piece or two of growing moss or fungus was then placed in the cell, having first been carefully examined under the microscope to see that it also was free from Acarina and ova, and the cell was then ready for use. One or two specimens of the larva, nymph, or species to be observed, were placed in the cell, never so many but what I knew each individual specimen; the cover was put on, fixed with the clip; a label with a statement of what was inside affixed to the slip, and the whole put away in the dark or very dull light."

Another good mode of providing the fungus-eating species with food Mr. Michael found to be by putting a minute piece of mouldy cheese in the cell; this soon bore a fine crop, which was highly appreciated. He found these simple cells answer better than any more elaborate apparatus. Mr. Macintyre's ingenious cork cells, so useful for many small insects, are not suitable for Oribatidæ, in the first place because many are wood-borers, and even those which are not often get lost in the interspaces of the cork. He also found that these cells got dry more rapidly.

He tells us indeed (and having had some experience in similar observations I doubt not that it is so) that no portion of his work has been either more laborious or more interesting than that of tracing the life-histories of the different species through their immature stages. The creatures are minute, scarcely visible indeed to the naked eye, they avoid the light and always endeavour to hide themselves, and yet they must be frequently examined to see what is going on. They must not be touched with any hard instrument, and lastly their transformations last for many months, sometimes for more than a year.

It is obvious indeed that his observations required great and constant care. The hygrometric condition of the cell required continued watching, since if it were made too

damp or allowed to get too dry, even for an hour, the labour of months would be lost. Mr. Michael carried his mites about with him on any journey, but it is obvious that alone he would have been wholly unable to devote sufficient time to the care of them, and it was, he tells us, mainly to his wife's patient attention and skilled fingers that his success in rearing them was due. To Mrs. Michael then, as well as to her husband, we will tender our warm thanks and congratulations on this excellent contribution to the natural history of the British Isles.

JOHN LUBBOCK

### INJURIOUS INSECTS

*Reports of Observations of Injurious Insects and Common Crop Pests during the Year 1883; with Methods of Preservation and Remedy.* By Eleanor A. Ormerod, F.R.Met.Soc., &c. Pp. 1-80 and 1-16. (London: Simpkin, Marshall, and Co., 1884.)

WE have to congratulate Miss Ormerod on having again produced an excellent summary of the evil doings of injurious insects in this country during the past year. It is full of interesting and useful information, from personal observation, and from the reports sent in by the staff of assistants she has enlisted into her service. Regarded from a popular point of view these annual Reports do great service by explaining to those interested the real nature of their insect foes; from a scientific point of view they may do good service by stimulating inquiry, and occasionally bringing to light the hitherto unknown life-histories of certain species; and they should do paramount service from an economical point of view. This latter is really the most important of all, and the item of *expense* in application of remedies is always a serious consideration. With some crops it may sometimes be doubtful if the outlay would be sufficiently recouped; with others (hops for example) the case different. In that year of hop-famine, 1882, we heard of one grower who expended 15*l.* an acre on washing, and was amply and abundantly repaid, but if all had done the same his profit would have been much less, though the general advantage would have been much greater: possibly in his case his gardens were comparatively isolated, and not subject to migrations from those of less careful neighbours. While on this point we observe that Miss Ormerod is inclined to believe in the supposed migration of the hop-aphis from plum to hop. The habit of migration in *Aphides* from one plant to another totally different is most strongly asserted by Lichtenstein, and almost as strongly pooh-poohed by others. At present we incline to the side of the observant French *savant*, because he states results from actual observation and experiment, whereas his opponents simply deny the possibility.

On one point we do not think Miss Ormerod has proved her case. She inclines to the belief that Myriopods ("False wire-worms" as she terms them) are "pests," and do devour healthy vegetable growth; nothing is impossible, but more proof than that given will be required in order to convince those who hold a contrary opinion.

That much vexed sparrow question is touched upon, not in a manner favourable to the sparrow. It is really a vexed question, and we fear will remain so. In the

writer's garden the sparrows are at this moment doing their best to clear the rose-trees of the "green-fly" that infest them, and there can be no doubt that at this season the sparrow is almost entirely insectivorous; at other seasons it is almost equally granivorous; possibly a judicious thinning of sparrows may be salutary, but those who advocate wholesale slaughter should bear in mind the results of the indiscriminate destruction of raptorial birds in these islands.

Miss Ormerod is not always happy in her nomenclature. Excepting in one book there is no such thing known as "*Hybernia prosapiaria*" (p. 5), the specific appellation rightly belonging to an entirely different insect; moreover had she consulted any recent work or list on *Micro-Lepidoptera* she would not have penned the footnote that appears at p. 67.

The illustrations (even if most of them be old and familiar) are good, and add to the usefulness of the Report.

In future Reports we think it deserves Miss Ormerod's consideration whether a meteorological summary in tabular form would not prove a useful addition, compiled especially with regard to the comparative abundance or scarcity of particular injurious species in former years, in connection with the temperature and rainfall in every month of each year.

R. McL.

#### OUR BOOK SHELF

*An Elementary Treatise on the Integral Calculus, containing Applications to Plane Curves and Surfaces; with Numerous Examples.* By B. Williamson, F.R.S. (London: Longmans, 1884.)

A WORK by Mr. Williamson is like good wine, and needs no commendation from us. We note that this has reached a fourth edition, but Mr. Williamson does not rest content with what he has already achieved. He has given a touch here, brought out into greater prominence a feature there, and not only so, but he has at last added a new detail in the shape of a chapter on multiple integration. In our notices of former editions we have drawn attention to the absence of such a chapter, and we are glad to see that he has at last introduced what he hopes "will be found a useful addition to the book." We need only remark further that this edition has 393 pages against 375 pages in the third edition.

*An Elementary Treatise on Solid Geometry.* By Charles Smith, M.A. (London: Macmillan and Co., 1884.)

MR. SMITH has already won his spurs as a mathematical writer by his admirable "Conics." This work, as far as possible, is on the same lines. It is not intended to supersede the classic treatises by Salmon and Frost any more than his former book was to take the place of the splendid work on "Conics" by the former of the above-named writers. A feature in Mr. Smith's treatment of the subject is the early discussion of the different surfaces which can be represented by the general equation of the second degree; and in the way in which these surfaces are here handled we think the student will be much interested. The discussion is full and very clear. An excellent collection of exercises adds much to the value of the book for students: those in the body of the chapters being well fitted to bring the text home to the reader. For the majority of students we should say, "Read Smith's 'Solid Geometry,' and you will not need any other work." Those who wish to penetrate into the inmost recesses will find that they have been helped by the study of this work

to attack the masterpieces referred to at the outset of our notice.

*A Collection of Examples on the Analytic Geometry of Plane Conics; to which are added some Examples on Sphero-Conics.* By R. A. Roberts, M.A. (Dublin University Press Series, 1884.)

WE had the pleasure of noticing with commendation (NATURE, vol. xxvi. p. 197) a previous collection of examples by Mr. Roberts on conics and some of the higher plane curves. This has all the merits of the former work, with, we fancy, increased power and skill in the methods employed. A portion of the exercises is common to both works. Much space is devoted to the discussion of properties of circles connected with a conic, especially of circles having double contact with the curve. Great use is here made, and effectively, of elliptic coordinates. "This method simplifies greatly the study of relations involving the angles of intersection of such systems," *i.e.* as have double contact with two fixed conical conics, "whose differential equations take a simple form." In all there are fifteen chapters, the last of which treats of sphero-conics; in this chapter also much use is made of elliptic coordinates. The collection is likely to be very serviceable to junior students, and will be convenient for reference generally. After perusal we have not detected, we believe, any errata that will cause such students as can use the book with profit any trouble.

*Mineralogy.* Vol. II. Systematic and Descriptive. By J. H. Collins, F.G.S. (Collins's Advanced Science Series.) (London and Glasgow: W. Collins, Sons, and Co., 1883.)

THIS little book is not, neither does it profess to be, more than a dictionary of minerals. The names, localities, and general characters are given as briefly as possible; and the work seems to be brought up to latest date.

The only point in which the author lays claim to originality of treatment is the classification, and it is precisely here that exception may be taken to the book, with its system of Pyritoids, Spathoids, Haloids, Plethoids, Brithoids, &c., and partial neglect of isomorphous groups. Cerussite, for example, is grouped with phosgenite instead of with aragonite, witherite, &c.

There are a number of crystal figures, but the notations, where used, are not consistent; and in one case, where the cleavages of barytes are wrongly described, the notation is meaningless.

There are several typographical and other errors which should be corrected in a second edition—*e.g.* "Senaviza" (p. 61) should be "Serravezza"; feather-ore (p. 60) should be referred to jamesonite, and not to berthierite; "eulitite" (p. 239) should be "eulytite."

It can scarcely be expected that the book will be much used by the "practical miners, quarrymen, and field-geologists" for whom it is intended. The other readers for whom the author writes, "students of the science classes," may however find it a useful and compendious book of reference, as containing a very complete list of minerals.

*Handbook of Vertebrate Dissection.* Part III. "How to Dissect a Rodent." By H. Newell Martin, D.Sc., M.D., M.A., and William A. Moale, M.D. (New York: Macmillan and Co., 1884.)

IN the third of their series of Handbooks of Vertebrate Dissection, Drs. Martin and Moale describe a mammal, taking as a type the common rat.

In spite of the authors' remark in the preface that "he who aspires to become a comparative anatomist, and yet finds a rat too small for the observation of all the main facts in its structure, has mistaken his vocation," we think that, for beginners, a larger mammal would have been preferable—at any rate for those who do not aspire to

measurement of the resistance of the human body, suggested that the latter instrument was too sensitive, and that from self-induction perfect silence could not be obtained. Both these remarks are true; but if time and the chairman had permitted, I should have said that absolute silence is rarely got, but that the minimum of sound is so easy, after a little practice, to estimate, that one-hundredth of a revolution on either side of it is instantly detected. The bridge wire takes ten turns on the barrel; consequently this amount is the thousandth part of a wire three metres long. Using a fixed resistance of 100<sup>ohms</sup>, the possible error is quite unimportant, and even with 1000<sup>ohms</sup> it is far within other instrumental accidents.

But as in the somewhat similar case of counting "beats" between tuning-forks, a sensitive and an educated ear is needed. At first starting I found that I made considerable mistakes, one of which is recorded in a paper contributed to NATURE some weeks back.

W. II. STONE

Wandsworth

### Simple Methods of Measuring the Transpiration of Plants

THE "potéomètre" described in NATURE, May 22, p. 79, appears to be an ingenious but a rather complicated instrument. Experience has, however, taught me that the extremest simplicity is most desirable. Mr. Ward hints at difficulties of manipulation which are quite conceivable. The plan I have adopted, and find to answer, as far as it goes, is to insert the cut end in a small test-tube and cover the surface of the water with a little oil. The whole can then be weighed to three places of decimals, and the absolute amount of loss in a given time is easily ascertainable.

But a serious objection must be made against all experiments with cut shoots and leaves, for they can only give, at best, unsatisfactory results. The amount of transpiration varies so much under the ever-changing conditions of light, heat, dryness, &c., that it is only by a long series of comparative experiments with the same specimen that the differences peculiar to each kind of plant can be ascertained; and no cut shoot can be employed for two or three days, much less for several days, as are necessary for obtaining satisfactory results; as the amount of loss steadily decreases till death ensues, although the shoot may be apparently quite healthy for a long time. I have been experimenting for several summers on the transpiration of plants under coloured lights, and at first used cut specimens, as so many experimenters have done, but I found they were most untrustworthy. I now grow the plants in miniature pots, which are covered up in gutta-percha sheeting. These can be weighed to two places of decimals. By this simple method all difficulties are entirely obviated.

GEORGE HENSLAW

Drayton House, Ealing

### Worm-eating Larva

THE following note, which I received from the Rev. Robt. Dunn of Cricklade, may be worth publishing in reference to Prof. McKenny Hughes's "Notes on Earthworms." Mr. Dunn says: "This afternoon (May 6) on a gravel path I saw a worm wriggling in an unusual way, and stooping down I saw that a big earthworm had a smaller worm hanging on at the belt or knob, or whatever you call it; so I got a bit of stick and pushed off the parasite and found it no worm, but I should say a sort of centipede, with a very red head, about one inch long. So I captured him and put him in methylated spirit, when he vomited what I presume was worm's blood." He further adds that what the beast vomited was a stream of crimson fluid; it separated at once into white flocculent matter with brick-red specks, but since it has all turned into a white sediment. Mr. Dunn sent me the animal, which proves to be the larva of a beetle, either one of the Staphylinidæ or Geodephaga.<sup>1</sup>

Southampton

W. E. DARWIN

### Cultivation of Salmon Rivers

I HOPE we may assume, from the paragraph which appears among the "Notes" in your issue of last Thursday (p. 129), that the Fishery Board for Scotland is about to take some active course towards the removal of obstructions to the ascent of

<sup>1</sup> Mr. W. F. Blandford has called my attention to an account of a similar encounter between a worm and a larva given in Dallas's "Elements of Entomology," p. 6.

salmon up Scottish rivers. When you say the Board "is specially desirous to introduce as soon as possible a fishway at the falls, and this, when done, would open up some 500 miles of excellent fishing and spawning ground," I hardly think you can be alluding to any one particular river. Am I correct in supposing you refer to the aggregate mileage of rivers in Scotland now closed by natural obstructions, i.e. waterfalls? The Report of the Special Commission to inquire into the condition of the salmon fisheries of Scotland, published in 1871, informed us that the River Tay alone had some 115 miles of river blocked against the salmon by the two natural obstructions of the Tummel Falls and the Falls of Garry on the two important Tay tributaries from which the respective waterfalls are named. If your "Note" meant to include the entire mileage of Scottish rivers seriously affected by artificial dams of a more or less obstructive character (and their name is legion in Scotland), as well as by the natural barriers that occur, I think 500 miles of obstructed fishing and spawning ground is far too low an estimate; it might in fact, I should say, be multiplied at the very least by three. Now that theoretical playthings are being laid aside, and in their place appears a prospect of a more sound, natural, and scientific basis being made the foundation of our future salmon cultivation, the absolute necessity of opening up the natural breeding-beds of the fish will, it is hoped, become patent to every one, and the dream of my old friend the late William J. Ffennel, the father, so to speak, of our modern salmon fishery legislation and salmon river cultivation may at last be realised. "If I live," he said to me one day (I hardly care to remember how long ago it was, or how soon after he was taken from us), "I shall never rest until every weir and mill-dam in the three countries—England, Ireland, and Scotland—has a thoroughly good and permanent salmon ladder built upon it, or into it, or around it. We have shown we can restore the fisheries; we must now restore the rivers. That, sir, is the true position to take up, and that must be our next aim." Had Mr. Ffennel lived, river restoration would probably have progressed more than it has during the last decade.

MARK HERON

June 9

[The falls referred to in our note on the Fishery Board for Scotland last week (p. 129) are the Falls of the Tummel.—Ed.]

### A RARE BRITISH HOLOTHURIAN

OF the six species of Holothurians with shield-shaped tentacles (the Aspidochirotae) that are known to occur on the shores of the North Atlantic Ocean, two—*H. obscura* and *H. agglutinata*—were so shortly described by Le Sueur as to be still strange to American naturalists; no definite statement as to the presence of a true, that is, aspidochirote, Holothurian in the British seas has ever made its way into any systematic revision or synopsis of the class.

Shortly, however, after the publication of Forbes' "British Starfishes," Mr. Peach of Gorran Haven, Cornwall, published in the *Annals and Magazine of Natural History* for 1845 (vol. xv. p. 171) a short article on the "Nigger" or "Cotton-Spinner" of the Cornish fishermen, in which he quite rightly remarks that no typical Holothurian with twenty tentacles had been observed by Forbes, and exhibits a just pleasure in being able to say that he had discovered one. Later, two Irish naturalists—Prof. Kinahan and Mr. Foot—separately noted the existence of what one called *Cucumaria niger* and the other *Holothuria niger*. With an exception to be mentioned immediately, no writer has for nearly forty years given the least indication of a knowledge of the existence of this "Cotton-Spinner," and it may therefore be supposed that it was always with interest that I examined any form that came from the British seas. A short time since, on opening a Holothurian that had been in the British Museum for nearly twenty years, I found that, instead of those tubules which, arising from the wall of the cloaca, were first seen by Cuvier, and called Cuvierian organs by Johannes Müller, being small and inconspicuous, or, as often happens, altogether absent, they formed rather a large, almost solid, compact mass of

closely-packed tubes, which overlay the rectal portion of the intestine, and occupied nearly one-third of the general body-cavity.

On comparing the general structure of this animal with the account given by Mr. Peach, I found that his article dealt so little with anatomical points that it was impossible to say whether or no there was any real relation between his "Cotton-Spinner" and my specimens, which, like his, were of Cornish origin. There was, however, a physiological experiment that could be made, and which might, I hoped, be successful. In the description given by our modern master of Holothurian organisation, Semper says, in speaking of the Cuvierian organs: "The sticky property of these organs is known in the true Holothurians, and in England they have even given the name of the 'Cotton-Spinner' to *Holothuria nigra*." I attempted to draw out one of the tubes of the mass, and, as I hoped, I found it extend. I threw it into water, and I found that it swelled out. More accurate experiment showed that it could be made to elongate twelve times and to swell out in water to seven times its diameter. It was at once clear that I had before me the creature of whom Peach had written: "It is extremely irritable, and, on being touched or disturbed, throws out a bunch of white tapered threads about an inch in length and one-eighth in thickness." Peach goes on to say that they "soon become attenuated, either by the agitation of the water or the coming into contact with something;" but as he goes on to say that they stick to everything they touch, I doubt not that, when that thing is alive it tries to run away, till the moral effect of the gradually elongating and as regularly swelling threads paralyses it with fear. At Dr. Günther's suggestion I tested the strength of these elongated threads, and I found that, when so thin as to be barely visible, six were strong enough to hold up a weight of between 800 and 1000 grains.

I communicated a paper detailing the zoological and anatomical characters of this very rare form, which seems to be known only to the fishermen of Cornwall, to the Zoological Society at their meeting on May 20, and I direct attention to it in this more widely circulated journal because it seems to show in a very pointed way how from the absence of opportunity for investigating animals that live not deeper than twenty fathoms we do not only remain ignorant of the contents of our own seas, but that we have in this "Cotton-Spinner" an opportunity of testing the hypothesis of Semper as to the function of these Cuvierian organs, and of putting on the basis of scientific observation and experiment the "great detestation" in which, as Peach tells us, they are held by the fishermen. While Cuvier regarded the organs to which in later years he was made name-father as testes, and Jäger and the great majority of subsequent writers as kidneys, Semper, who had unexampled opportunities of watching and examining them in the Philippines, came to the conclusion that they were organs of offence or defence. To this conclusion the French naturalist Jourdan and the German Dr. Hamann have been led on the ground of histological observation; in England the only observations yet made have been such as are possible in a museum with specimens that have been in spirit for nearly twenty years. I earnestly hope that the line of investigation indicated by the facts that are here recorded will be soon followed out by one who is working in a marine biological laboratory on the British coast.

F. JEFFREY BELL

VISITATION OF THE ROYAL OBSERVATORY

THE visitation of the Royal Observatory, Greenwich, took place on Saturday last, when there was a very numerous attendance of astronomers and representatives of the allied sciences. The Report this year does not

contain anything striking, but enables us to see how usefully and smoothly the work of the Observatory has been going on during the past year. Still novelties were not entirely absent, chief among them being the new La: sell reflector.

The new dome for this telescope was completed by Messrs. T. Cooke and Sons at the end of last March, and is in every respect satisfactory. It is thirty feet in diameter, covered with *papier-mâché*, on an iron framework, and turns with great ease. The shutter-opening extends from beyond the zenith to the horizon and is closed by a single curved shutter (3 feet 6 inches wide at the zenith and 6 feet wide at the horizon), which turns about a point in the dome-curb opposite to the shutter-opening, and runs on guiding-rails at the horizon and near the zenith, the curved shutter being continued by an open framework to complete the semicircle. This arrangement appears to leave nothing to be desired as regards ease of manipulation. After the completion of the dome, the carpenters' work on the flooring, &c., of the building and the attachment of the observing-stage (which is fixed to the dome) have necessarily occupied much time, and the building is hardly yet complete in all details. The equatorial has required a number of small repairs and general cleaning, some parts of the mounting having been probably strained in process of removal, and the bearings in particular having suffered from wear and subsequent disuse, so that it has been necessary to raise the instrument and regrind these in several instances. The mirror has been cleaned, and appears to be in very good condition as regards polish. The definition on stars seems to be very good as far as it has been practicable to test it before the mounting of the telescope has been put into proper order. The delay in the completion of the dome has necessarily delayed the work on the instrument, which is now rapidly advancing to completion.

First among the astronomical observations properly so called referred to by the Astronomer-Royal was the work done by the transit-circle. "There is no change of importance to notice in this instrument, which has been kept in good working order. A reversion-prism for use with the collimators as well as with the transit-circle is being made by Messrs. Troughton and Simms. The sun, moon, planets, and fundamental stars have been regularly observed throughout the year, together with other stars from a working catalogue of 2600 stars, comprising all stars down to the sixth magnitude inclusive which have not been observed since 1860. Considerable progress has been made in obtaining the requisite three observations of each star, and there is a good prospect that by the end of next year, when it is proposed to form a new Nine-Year Catalogue, the whole of the stars will be cleared off. The annual catalogue of stars observed in 1883 contains about 1550 stars."

The following statement shows the number of observations with the transit-circle made in the year ending 1884 May 20:—

Transits, the separate limbs being counted as separate observations	5213
Determinations of collimation error	303
Determinations of level error	360
Circle observations	5049
Determinations of nadir point (included in the number of circle-observations)	353
Reflection-observations of stars (similarly included)	548

As regards the computations—

Clock times of transit over the true meridian, corrected for collimation, level and azimuth errors, are prepared to	1884 May 18
Clock errors and rates are determined to Mean R.A.'s for 1884 January 1 <sup>st</sup> prepared to	May 11
	May 11

In connection with this class of observation it is interesting to remark that the mean error of the moon's tabular place deduced from the meridian observations of 1883 has been brought down to  $+0.03s$ . in right ascension and  $+0.42$  in longitude. This result has arisen because in this year Prof. Newcomb's corrections to Hansen's tables have been applied in the *Nautical Almanac*, so that the comparison has reference to Hansen's theory without his empirical term of long period (intended to represent the direct action of Venus) and with an empirical alteration in the epoch of the inequality resulting from the indirect action of Venus. The mean error of Hansen's tables uncorrected was  $+0.82s$ . in R.A. for the year 1882.

The most important reference to the spectroscopic work is the following:—

"For the determination of motions of stars in the line of sight, 412 measures have been made of the displacement of the F line in the spectra of 48 stars, 91 measures of the  $\delta$  lines in 19 stars, and two measures of the D lines in one star, besides measures of the displacements of the  $\delta$  and F lines in the spectra of the east and west limbs of Jupiter, and in the spectra of Venus and Mars, and comparisons with lines in the moon or sky spectrum made in the course of every night's observations of star-motions, or on the following morning, as a check on the adjustment of the spectroscope. Some preliminary measures have also been made of the F line in the spectrum of the Orion Nebula. The progressive change in the motion of Sirius, from recession to approach, alluded to in the last two Reports, is fully confirmed by numerous observations since last autumn, and a change of the same character is indicated in the case of Procyon. A discussion of the measures of all the stars observed here, on which I am now engaged, shows that the results of the four periods—1875 June to 1877 May, 1877 June to 1880 December, 1881 January to 1882 March 10, 1882 March 11 to 1884 March 31, in each of which the instrumental conditions were different—accord generally within the limits of the probable errors, and that there is no systematic change from recession to approach, so that the presumption against error arising from defective instrumental adjustment appears to be strong."

Passing on to another branch of the work at present undertaken by the Observatory, that connected with photographs of the sun with the view to determine the amount of spotted area, &c., we learn that two important changes have been made. First, the heliograph, which up to the present time has only given us pictures 4 inches in diameter, has been altered, as was suggested two years ago by the Solar Physics Committee, so as to take pictures of 8 inches. This necessitated a new micrometer which has already been constructed. Again, the photographs taken in India under the auspices of the Solar Physics Committee are now sent to Greenwich to be reduced with those of the previous series, and the result is a considerable increase in the number of days for which photographs are available. Thus in the year 1883 the 215 days of Greenwich are supplemented by 125 days of India, making a total of 340 out of 365 days. In 1882 we had Greenwich, 201, India 142, making up 343.

There is nothing new to remark with regard to magnetical work. We may state however that the magnetic elements for the past year were determined to be as follows:—

Approximate mean westerly declination . . . . .	} $18^{\circ} 25'$ .
Mean horizontal force . . . . .	{ $3.926$ (in English units). $1.810$ (in metric units).
Mean dip . . . . .	{ $67^{\circ} 31' 10''$ (by 9-inch needles). $67^{\circ} 31' 36''$ (by 6-inch needles). $67^{\circ} 31' 59''$ (by 3-inch needles).

The doings of the Deal time-ball and Westminster clock are thus referred to:—

"As regards the Deal time-ball, after various delays the arrangement, referred to in the last Report, for sending a current to Deal and receiving a return-signal through the chronopher of the Post Office telegraphs, was brought into operation on February 29, and has worked well since. The change has necessitated some slight alteration in our arrangements in order that we may be able to receive the Westminster signal through the same wire which is now used for the Deal current and its return signal. There have been 16 cases of failure in the dropping of the Deal time-ball owing to interruption of the telegraphic connections, 12 under the old system, and 4 since the new arrangement with the Post Office. On 19 days the current was weak and required the assistance of the attendant to release the trigger, and on 9 days the violence of the wind made it imprudent to raise the ball.

"The errors of the Westminster clock have been under 1s. on 53 per cent. of the days of observation, between 1s. and 2s. on 30 per cent., between 2s. and 3s. on 13 per cent., between 3s. and 4s. on 3 per cent., and between 4s. and 5s. on 1 per cent."

#### THE NORTH CAPE WHALE

THE North Cape or Biscay whale belongs to the group of true *Balanae*, or smooth whales, *i.e.* those whales which have no fin on the back or furrows along the throat, as is the case with the so-called fin-whale group. It has most in common with the South Sea whale (*Balana australis*). Its systematic name is *Balana biscayensis* (Eschricht).

The habitat of the North Cape whale is limited to the north temperate zone of the Atlantic Ocean, whereas the Greenland whale is found most frequently in the closer vicinity of the Pole. Along the coasts of Europe the North Cape whale used to be found from the Mediterranean to the sea north of Norway, as far as the Beeren Island. Its true home, was, however, according to earlier writers who have dealt with the whale-fisheries in the preceding centuries, between Iceland and Norway, its original name—the North Cape whale—being derived from its frequent appearance around that promontory some centuries ago.

It visited the coasts of Central and South Europe regularly during the winter months, its favourite haunt appearing to be the Bay of Biscay. There it began to be pursued very early—perhaps as far back as the eleventh or twelfth century. In the fourteenth century the whale-fishery was an established industry here. It was also, according to the Icelandic Saga, "Kongespeilet," written in the twelfth century, already at that period largely caught by the Icelanders. It was called by the latter *sláttbag* (smooth-back), and it was in all probability the catching of the North Cape whale of which the bard Othar of Haalogaland, *i.e.* Nordland in Norway, gave such an interesting account before King Alfred the Great of England. He stated that its haunts were then the shores of Northern Norway.

The principal expeditions for catching the whale were, however, despatched from the Bay of Biscay, but as it became more and more scarce in this part, it was followed as far as Iceland, where the Biscay fishermen found formidable rivals in the old Icelanders. It was these expeditions to Iceland which brought the Greenland whale under the notice of the southerners, and from the beginning of the seventeenth century the Greenland whale fishery around Spitzbergen became the leading industry.

In the middle of the seventeenth century the Americans began to catch whales. The Biscay whale was then very plentiful around the east coast of North America, and from the ports of "New England" numerous expeditions

for hunting this species were yearly despatched. The Americans called it "black whale," a denomination which, by the bye, also applies to other kinds.

Its range on the shores of America seems to have fallen a little south of that of Europe. It is in fact most probable that the whale visited the coast of Florida during the winter months, perhaps even more southern latitudes. Northwards it might be found as far as the sea is free from ice, but several circumstances seem to indicate that it preferred a temperate zone, and that its appearance on the shores of Greenland were merely migratory visits during the hot season. It may in fact be assumed that the North Cape whale made its regular migrations like the Greenland whale; in support of which I may point out that from the thirteenth to the fifteenth centuries the whale-hunting in the Bay of Biscay was carried on only during the winter months, and around America was limited to the season between November and April, at all events on the coast of New England.

What is known as to the principal haunts of this species of whale is alone based on the reports we possess of its hunting in the preceding centuries.

From the eighteenth century we hear no more about the catching of the North Cape whale in European waters, and in the beginning of the present century it also ceased to be hunted on the shores of America in consequence of its great scarcity.

It is therefore exceedingly interesting to find that the North Cape whale is again appearing on the east coast of America in such numbers that its catching is being resumed.

On the coasts of Europe the whale has only been discovered twice during this century, viz. in 1854, when a young one was caught at Pampeluna, the mother escaping; and in 1877, when the carcass of one—thirty-six feet in length—was cast ashore in the Bay of Toronto in Southern Italy. The skeleton of the former was brought to Copenhagen by the late Prof. Eschricht, where it now is.

The discovery which I made in 1882 on the shores of Finmarken of remains of this species of whale, hunted there by the Dutch in the sixteenth century, gave rise to further investigations as to the probable reappearance also in these parts of the North Cape whale, and from reports and circumstances brought to my knowledge, I feel convinced that considerable numbers of the North Cape whale again yearly appear on the coast of Northern Norway, where they were once so common. I must indeed regret that to ascertain with positive certainty whether this is a scientific fact is very difficult for a scientist whose stay in a certain part for scientific research is limited to a month or so. I hope, however, to obtain substantial proof of my belief at no very distant date.

For a figure of the North Cape whale I may refer the reader to that published in May 1883 in the *Bulletin* of the American Museum of Natural History, New York.  
The University, Christiania G. A. GULDBERG

## MEASURING EARTHQUAKES

### I.—METHODS

IT is difficult to define the word earthquake in terms which will not cover cases to which the name is inappropriate. To say that an earthquake is a local disturbance of the earth's crust, propagated by the elasticity of the crust to neighbouring portions, is true, but the definition does not exclude, on the one hand, such tremors of the soil as are set up by the rumbling of a carriage, by the tread of a foot, or even by the chirp of a grasshopper, nor, on the other, those slow elastic yieldings which result from changes of atmospheric pressure, from the rise and fall of the tides, and perhaps from many other causes. One

writer, in his definition of the word, limits the name earthquake to disturbances whose causes are unknown—a course open to the obvious objection that if the study of earthquakes ever advanced so far as to make the causes perfectly intelligible we should, by definition, be left with no earthquakes to study. It must be admitted, however, that in the present state of seismology this objection has no force, for in assigning an origin to any disturbance likely to be called an earthquake, we have, so far, been able to do little more than guess at possibilities. The more practicable task of determining what, at any one point within the disturbed area, the motions of the ground during an earthquake exactly are has lately received much attention, and in this department of seismology distinct progress has been made.

Apart from its scientific interest, this absolute measurement of earthquake motion is not without its practical use. Though the recent sharp earthquake in the Eastern Counties has reminded us that no part of the earth's surface can be pronounced free from liability to occasional shocks, these occur so rarely in this country that English builders are little likely to let the risk of an earthquake affect their practice. If Glasgow or Manchester had

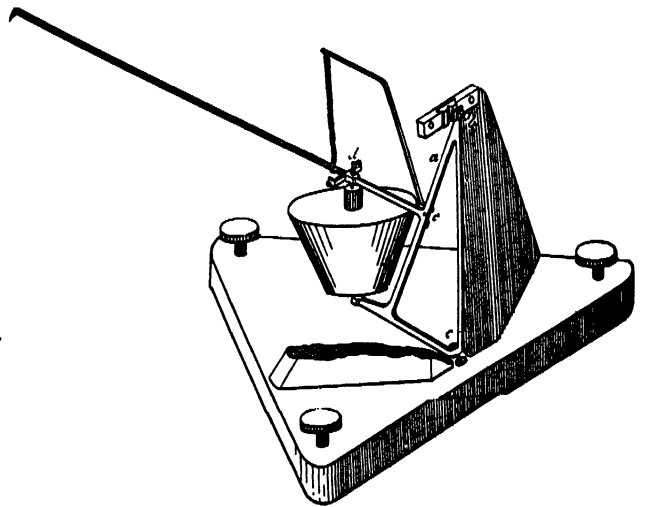

Fig. 1

been shaken instead of Colchester, the chimneys of the mills would, we suppose, have risen again in a few weeks no less tall than before. The case is different in an "earthquake country," such, for example, as some parts of Japan, where the present writer had the good fortune to experience, during five years, some three hundred earthquakes. Where the chances are that a structure will have to stand a shock, not once in a few centuries, but half-a-dozen times a month, the value of data which will enable an architect or engineer to calculate the frequency and amplitude of the vibrations, and the greatest probable rate of acceleration of the earth's surface, does not need to be pointed out.

To know how the earth's surface moves during the passage of a disturbance we must obtain, as a standard of reference, a "steady-point," or point which will remain (at least approximately) at rest. This is a matter of no small difficulty, for (as will be shown in a second paper) the motions during any single earthquake are not only very numerous but remarkably various in direction and extent. Most early seismometers were based on the idea that an earthquake consists mainly of a single great impulse, easily distinguishable from any minor vibrations which may precede or follow it. The writer's observa-

tions of Japanese earthquakes do not bear this out. They show, on the contrary, during the passage of almost every earthquake, scores of successive movements, of which no single one is very prominently greater than the rest. Moreover, the direction in which a particle vibrates is so far from constant that it is usually impossible to specify even roughly any particular direction as that of principal movement. For these reasons attempts are futile to obtain knowledge of earthquake motions from instruments intended to show only the greatest displacement or "the direction of the shock." The indications of such instruments are, in fact, unintelligible, and it is safe to say that no seismometer is of value which does not exhibit continuously the displacement of a point from its original position during the whole course of the disturbance. The value of the observation is enormously increased if, in addition to the amount and direction of the successive displacements being shown, these are recorded in their relation to the time. We can then, besides seeing the frequency of the vibrations, calculate the greatest velocity of the motion of the surface, and also its greatest rate of acceleration—an element of chief importance in determining an earthquake's capacity for mischief, since in a rigid and rigidly founded structure the shearing force through the base is equal to the product of the acceleration into the mass, and the moment tending to cause overthrow is that product into the height of the centre of gravity.<sup>1</sup>

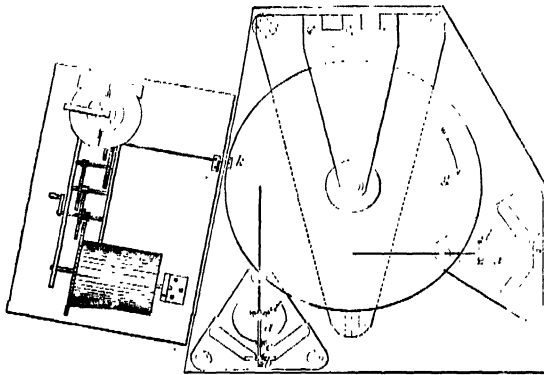

Fig. 2

Seismographs used during the last three or four years by the writer and others in Japan give a record of the earth's motion during disturbance by dividing that into three components, along the vertical and two horizontal lines. In the writer's apparatus these three are independently recorded on a revolving sheet of smoked glass, which is either maintained in uniform rotation, ready for an earthquake to begin at any moment, or is started into rotation (by help of an electro-magnetic arrangement) by the earliest tremors of the earthquake itself. The relative position of the marks on the glass serves to connect the three components with each other, and a knowledge of its speed of rotation connects them with the time. It is sufficient that the "steady-point" for each of the three components should be steady with respect to motion in one direction only. It may move with the earth in either or both of the other two directions, and in fact it is generally most convenient to provide three distinct steady-points, each with no more than one degree of freedom.

In that case each steady-point is obtained by pivoting a piece about an axis fixed to the earth, and in nearly neutral equilibrium with respect to displacements about the axis of support. When the earth's surface shakes in

the direction in which the piece is free to move, the support, which is rigid, moves with it, but the centre of percussion of the pivoted piece remains approximately at rest, and so affords a point of reference with respect to which the earth's movements may be recorded. If we could get rid of friction, and if it were practicable to have the equilibrium of the pivoted piece absolutely neutral, the centre of percussion would remain (for small motions) rigorously at rest even during a prolonged disturbance. But there must be some friction at the axis of support and also at the tracer which records the relative position of a point moving with the earth and the steady-point of the seismograph. And the pivoted mass must have some small stability, to prevent a tendency to creep away from its normal position during a long continued shaking, or in consequence of changes of the vertical. If, however, the mass be so nearly astatic that its free period of oscillation is much longer than the longest period of the earthquake waves, and if great care be taken to avoid friction, the centre of percussion behaves almost exactly as a true steady-point with respect to all the most important motions of even a very insignificant earthquake. The effective inertia of the system may be further increased by pivoting a second mass on an axis passing through the centre of percussion of the first piece and parallel to the axis of support. An instrument designed on these lines in which the pivoted pieces in neutral equilibrium were

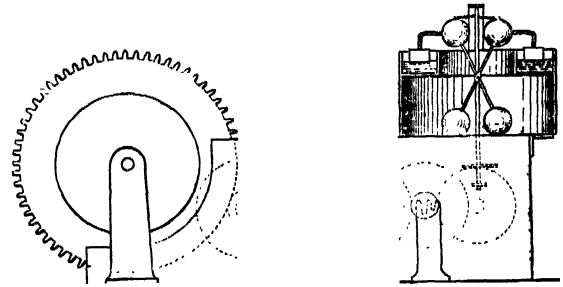

Fig. 3

two light frames supported as horizontal pendulums at right angles to each other, and with a massive bob pivoted at the centre of percussion of each, gave (in 1880) the earliest complete records of the horizontal movement of the ground during an earthquake. A description of it has been given in the *Proceedings of the Royal Society*, No. 210.

Figs. 1 and 2 show this seismograph, improved in many of its details. The form shown is one which has done excellent service in a seismological observatory which the writer was enabled to establish in the University of Tokio, through the interest of the Japanese directors. A similar instrument has also been supplied to the Government of Manila. Fig. 1 shows one of the two horizontal pendulums with a portion of one of its upright supports removed. The axis of support (which slopes very slightly forward to give a small degree of stability) is formed by two steel points, *b* and *c*, working in an agate V-groove and a conical hole. The frame of the pendulum is a light steel triangle, *a*, the effective inertia being given almost wholly by a second mass pivoted at *d* on a vertical axis which passes through the centre of percussion of the frame. The tracer, which serves to magnify as well as to record the motion, is a straw, tipped with steel, and attached to the pendulum by a horizontal joint at *e*, which allows it to accommodate itself to any inequalities in the height of the glass plate on which its distant end rests. A portion of its weight is borne by a spring, adjustable by a

<sup>1</sup> The case is different and much less simple where the structure is so flexible as to have a period of free vibration comparable with the periods of the earthquake vibrations.

clamp at *e*, by which the pressure of the tracer on the glass plate may be reduced to an amount just sufficient to scratch off a thin coating of lamp-black with which the glass is covered. In Fig. 2 the two pendulums are seen in plan, with their tracing pointers touching the glass plate *g* at different distances from its centre. The plate and pendulums are mounted on a single base, which is very rigidly secured to the top of a broad post, stuck firmly in the earth and projecting only a few inches above the surface. Continuous rotation is communicated to the plate by a friction-roller, *k*, held in a slot guide and connected by a universal joint to one of the arbors of a clock, which is wound up once a day. Government by an escapement being out of the question, the clock is controlled by a fluid-friction governor connected to the wheel train, also by friction gear, as shown in Fig. 3. The balls are four in number to prevent disturbance of them by an

ment is to be preferred. When an earthquake has occurred, the plate is removed, varnished, and photographed by using it as a "negative."

The bob of each pendulum may of course be rigidly attached to instead of pivoted on the pendulum frame. In that case the centre of percussion of the frame and bob together (which will then be a little farther from the support than the centre of the bob) will be the steady-point. The writer, however, prefers the arrangement described above, which gives great compactness and a maximum of effective inertia, and which has the advantage of making the position of the steady-point at once determinate.

It would take too much space to describe or even to enumerate the many other devices which have been suggested to secure a steady-point by various methods of astatic support,<sup>1</sup> leaving one, or in some cases two, degrees of freedom to move horizontally. The horizontal

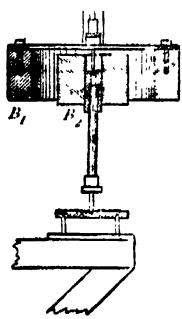
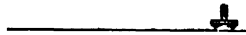

Fig. 4

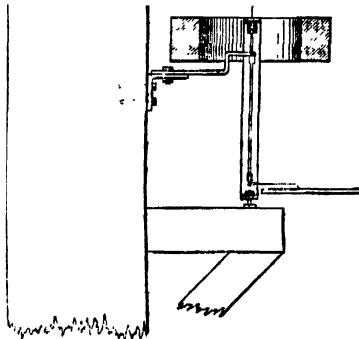

Fig. 5

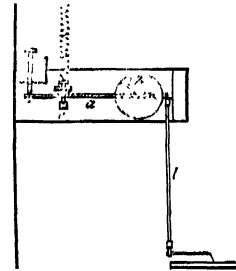

Fig. 6

earthquake. The vanes dip into oil, and are drawn back by two springs which tie them to the spindle.

When the earth shakes, the axis, *a*, of each bob remains sensibly at rest as regards components of motion perpendicular to the corresponding pendulum, and the tracing point is therefore displaced over the glass plate, in the direction of the plate's radius, through a distance which in this case is four times the motion of the earth. So long as no earthquake occurs each pointer traces over and over again a single circle on the plate. The circle frequently tends to widen inconveniently, especially if the pendulum is very nearly astatic. This is in part at least due to such changes of the vertical as have been observed by d'Abbadie, Plantamour, G. H. Darwin, and others. The plate consequently requires frequent attention, and where that cannot be given, an electric starting arrange-

pendulum has been modified by substituting a flexible wire and spring for its rigid pivots, thereby avoiding all but molecular friction at the axis of support. Spheres and cylinders, free to roll on plane or curved surfaces with or without a slab above them, have been tried, but their friction is excessive. The approximate straight-line motions of Watt and of Tchebicheff have been pressed into the service as means of suspending a mass with freedom to move in a horizontal path. The common or vertical pendulum, an old favourite with seismologists, has suffered many transformations in the effort to reduce its stability, which is preposterously great unless we make the pendulum very long. A 20-foot pendulum consisting of a cast-iron ring weighing half a hundredweight, hung

<sup>1</sup> See papers by Gray, Milne, the writer, and others in the *Transactions of the Seismological Society of Japan*, vols. i. to vi.; or a memoir on "Earthquake Measurement," published a year ago by the University of Tokio.



by three wires from a rigid tower, has done good work in the writer's observatory, but such an instrument has obvious drawbacks. Fig. 4 shows an arrangement, also used by the writer, and called a "duplex pendulum." A common pendulum with a ring bob,  $B_1$ , is connected to an inverted pendulum,  $B_2$ , by a ball-and-tube joint, which compels the bobs to move horizontally together. The combination can be made as nearly astatic as may be desired by proportioning the masses of the bobs to the lengths of the suspension-rods. The inverted pendulum stands on a joint which gives two freedoms to rotate but prevents twisting about a vertical axis; an extension of its rod upwards forms the multiplying arm, and carries a tracing pointer.

Another plan is shown in Fig. 5, which may be described as a duplex pendulum with a single bob, whose weight is borne partly by a socket below and partly by a spring from a support above. Any one of these instruments affords a single steady-point with respect to all motions in azimuth. Their principal use is to give "static" records of the horizontal motion, that is, records traced on *fixed* plates, which show at a glance the changes in direction of displacement during the occurrence of an earthquake.

In attempting to register the vertical component of earthquake motions, we meet with the difficulty that the weight of the mass whose inertia is to furnish a steady-point acts in the direction in which freedom of motion is to be retained. A weight hung by a spiral spring from a support above it is too stable to act as a seismometer, unless the spring be impracticably long. A horizontal bar fixed to a wall by a flexible joint and loaded at its end—an old device used by the British Association Committee at Comrie in 1842—is open to the same objection. If the loaded bar is rigid, but pivoted about a fixed horizontal axis, and held up by a spiral spring near the axis of support, we obtain a much slower period of free oscillation than if the spring were directly loaded with a weight which would stretch it to the same extent. Mr. Gray has rendered this device as nearly astatic as may be desired by adding a small tube containing mercury, whose effect is to increase the load when the bar goes down and to decrease it when the bar goes up. Another and simpler way of attaining the same result is shown in Fig. 6, which represents the vertical seismograph used in Japan by the present writer. There  $a$  is a horizontal bar pivoted about a horizontal axis on two points at  $c$ , with a heavy bob,  $b$ , whose weight is borne by a pair of springs,  $d$ . But the upward pull of the springs, instead of being applied to the bar in the line joining the axis  $c$  with the centre of gravity, is applied *below* that line by means of the stirrup  $e$ . Consequently, if the bar goes down, the pull of the springs, although increased above its normal value, is applied nearer to the axis, and (by properly adjusting the depth of  $e$  below the bar) the moment of the pull of the springs may thus be kept as nearly equal to the moment of the weight as may be desired—a condition which of course secures astaticism. The centre of percussion of the loaded bar is the steady-point, with respect to which the vertical motions of the ground are recorded by the multiplying lever  $l$  on the rim of a revolving glass plate,  $o$ , which may be the same plate as that which receives the record of the two horizontal components.

The instruments which have been briefly described succeed in registering very completely all the movements of the ground at an observing station during the occurrence of an ordinary earthquake, and some of them could be adapted with little difficulty to the registration of violent convulsions. It would be outside the scope of this paper to deal with the appliances by which Rossi and others have investigated those minute and almost incessant tremors of the soil whose very existence no observations less fine and careful would serve to detect.

J. A. EWING

## NOTES

THE meeting for organisation of the American Association for the Advancement of Science will be held on Thursday morning, September 4; and on Friday evening, September 5, after the address of the retiring President (Prof. Charles A. Young, of the College of New Jersey), a general reception will be tendered by the citizens and ladies of Philadelphia to the members of the British and American Associations, and the ladies accompanying them. The British Association has been cordially invited, both by the American Association, to take part in their proceedings, and by the Local Committee representing citizens of Philadelphia, to accept the warm welcome which will be tendered them during the joint session. The Local Committee for the Philadelphia meeting is divided into a number of sub-committees, which have been specially created to render the stay of their visitors agreeable. It is earnestly requested that every one who intends to participate in this meeting will send his name, together with the number of ladies and gentlemen in his party, at as early a date as possible, to Dr. Persifer Frazer, Secretary of the Committee on Invitations and Receptions, 201, South Fifth Street, Philadelphia. During the week occupied by the session a number of receptions, entertainments, and excursions will be given, and a day will be set apart for the examination of the International Electrical Exhibition, to be held at Philadelphia, under the auspices of the Franklin Institute, and commencing September 2. By an arrangement between the Canadian and United States trunk lines, the members of the British Association will be furnished with first-class passage from Montreal to Philadelphia and return for 15 dollars (3*l.* 1*s.* 8*d.*), or for the single trip from Montreal to Philadelphia for 9 dollars (1*l.* 17*s.*). It is to be hoped that these rates will be further reduced before the members of the British Association will be ready to take advantage of them.

THE Executive Council of the International Health Exhibition have determined to hold an International Conference on Education in connection with the Education Division of the Exhibition: they have appointed a Committee of Management, who have drawn up a programme. For convenience of discussion all papers to be read will be printed beforehand, and they will subsequently be published by the Executive Council. Persons desirous of attending the Conference are invited to send in their names to Mr. R. Cowper, Secretary to the Committee of Management, International Health Exhibition, South Kensington, to whom any inquiries can be addressed. The following are the subjects for discussion:—1. Conditions of Healthy Education. 2. Infant Training and Teaching: (a) Kindergarten; (b) Instruction generally. 3. Technical Teaching: (a) Science; (b) Art; (c) Handicrafts; (d) Agriculture; (e) Domestic Economy. 4. Teaching of Music in Schools. 5. Museums, Libraries, and other Subsidiary Aids to Instruction in Connection with Schools. 6. Training of Teachers. Under this head will be considered the right professional preparation for teachers in (a) elementary, (b) intermediate and higher, (c) special and technical schools. 7. Inspection and Examination of Schools: (a) by the State; (b) by the Universities; (c) by other public bodies. 8. Organisation of Elementary Education. 9. Organisation of Intermediate and Higher Education. 10. Organisation of University Education. 11. Systems of Public Instruction in various Countries.

THE Albert Medal of the Society of Arts has been awarded by the Council of the Society, with the approval of the Prince of Wales (the President), to Capt. James Buchanan Eads, "the American engineer, whose works have been of great service in improving the water communications of North America, and have thereby rendered valuable aid to the commerce of the world."

THE death is announced of the celebrated Danish entomologist, Prof. J. C. Schiödte, at the age of sixty-nine.

THE St. Petersburg Academy of Sciences intends to publish the valuable documents which came into its possession from the great expeditions of the last century, of Krashennikoff, Müller, Pallas, and Messerschmidt; they are still unknown, as also the correspondence of the great explorers of Russia and Siberia.

A NEW scheme of a Polar expedition has been recently submitted by several officers of the Russian Navy to the Minister, Admiral Shestakoff. Starting from the idea that it is impossible to reach the North Pole by sea on account of the archipelagos that cover the circumpolar region, the Russian officers propose to start an expedition on sledges from the New Siberia Islands, which are 900 nautical miles distant from the Pole. This space is to be covered by sledge parties, who would make depots of provisions on the newly-discovered islands, and thus slowly but surely advance towards the north, securing at the same time the return journey of the expedition. When elaborated, the scheme will be submitted to the learned Societies, and the necessary money raised by subscriptions.

WE understand that the Commissioners under the new Universities (Scotland) Bill, if passed as it stands at present, will have power to establish, if they find it expedient, a Science Faculty in the Universities or in some of them, and to make provision for a curriculum or course of study in such Faculty which shall be coordinate with the curriculum or course of study in the Faculty of Arts. The Bill has the approval of the Senatus Academicus University of Edinburgh.

MR. JAMES JACKSON, the librarian of the Paris Geographical Society, has drawn up a useful table showing the extent to which the metrical system is used. In the following countries the system is legally obligatory:—

Argentine Republic	Population 2,830,000	Italy ... ..	Population 28,459,451
Austria-Hungary...	37,786,346	Mexico	10,046,872
Belgium ... ..	5,520,009	Netherlands	4,172,971
Bolivia ... ..	1,957,352	Norway	1,806,900
Brazil ... ..	9,883,622	Paraguay	346,048
Chili ... ..	2,199,180	Peru ...	2,699,945
Colombia ... ..	4,000,000	Portugal	4,160,315
Denmark ... ..	1,969,039	Roumania	5,073,000
Equador ... ..	946,033	Spain ...	16,634,345
France & Colonies	46,843,000	Sweden	4,579,115
Germany ... ..	45,234,061	Switzerland ... ..	2,846,102
Greece... ..	1,979,305		
			241,973,011

In the following countries the metrical system is optional:—Canada, 4,324,810; United States, 50,419,933; Great Britain and Ireland, 35,241,482; Persia, 7,653,600; total, 97,639,825. In the following countries the system is often used without its having legal value:—

India... ..	Population 6,820,000	Uruguay... ..	Population 438,245
Russia ... ..	198,755,993	Venezuela .. ..	2,075,245
Turkey ... ..	100,372,553		
	24,804,350		333,266,386

THE Duke of Norfolk has indicated his intention of contributing 3000*l.* towards the technical department of the Firth College, Sheffield.

THE East of Scotland Naturalists' Union held a very successful meeting in Dundee on Friday and Saturday last. Dr. Buchanan White gave an instructive and interesting address; various reports were given in, papers read, and a largely-attended *conversazione* held in the evening. On the Saturday a dredging excursion was made to the Bell Rock.

THE Manchester Field Naturalists have been spending the Whitsuntide holiday in Sherwood Forest. On the way to

Mansfield, which was chosen as the head-quarters of the party, a short stay was made in the mountain limestone region of Derbyshire, to examine the geology of Brick Cliff. An interesting feature of the programme was the visit made to the Creswell Caves (in a pretty ravine of the magnesian limestone) under the guidance of the Rev. J. Magens Mello, one of the principal explorers of the caves, from which, it will be remembered, important remains of the post-Pleiocene Mammalia and Neolithic instruments have been obtained. The weather was very propitious, and the visit very enjoyable.

THE seventh annual meeting and *conversazione* of the Midland Union of Natural History Societies will be held at Peterborough on Wednesday, June 25. Excursions will be made to Stibbington Hall, Bedford Purlieu, and the Decoy in Borough Fen and Croylund on Thursday, June 26. The annual meeting will be held in the Fitzwilliam Hall, Peterborough, on Wednesday, June 25, at three o'clock, the President of the Union (the Very Rev. the Dean of Peterborough) in the chair. The business of the meeting will be to receive the Report of the Council and the Treasurer's accounts; to fix the place of the next annual meeting in 1885; to award the Darwin Medal for the year 1884; to consider any suggestions that members may offer; to discuss the work of the Union during the coming year; and to transact all necessary business. The President will open the meeting with an address.

MR. F. W. EASTLAKE of Tokio informs us that the well-known Devonian Brachiopod, *Spirifer disjunctus*, in common with several other Devonian genera such as *Rhynchonella*, *Cornulites*, *Spirorbis*, and the like, is called by the Chinese *shi-yên* or "Stone Swallow," and that the powdered shell is largely sold by the native druggists as a specific in urinary and renal disorders. He has obtained a specimen of the shell from South Formosa, which he regards as indicating a prolongation of that Devonian formation which, commencing with Hainan and Southern China, is traceable throughout the Loochoos and the southern provinces of Japan. *Spirifer disjunctus* is not uncommon in the Mikado's Empire, but as it is highly prized on account of its supposititious medicinal virtues, it is possible, if not probable, that the fine specimens obtained from the Japanese were originally brought from China. The very fact that *Spirifer disjunctus* is one of the ornaments of the Eastern Asiatic pharmacopeia renders it unusually difficult to trace the locality whence the Brachiopod may have been brought.

THE new Scandinavian mathematical journal, *Acta Mathematica*, has already gained such a reputation that the French Government has decided to subscribe for fifteen copies for the Faculté des Sciences. In his note to the Swedish Ambassador in Paris on this subject M. Jules Ferry points out that it is the first time his Government has supported a foreign publication, which he trusts will be an acknowledgment of the high international position the *Acta Mathematica* has gained and of the value it has become to French science. This journal is also supported by the three Scandinavian Governments.

WITH the brig *Lucinde*, which has just left Copenhagen, Lieut. Jensen of the Danish Navy, Dr. Lorentzen, and the painter Ris-Carstensen, left for Greenland for the purpose of measuring, and exploring geologically and geographically, the country between Holstensborg and Sukkertoppen, the shore of which is very broad—it is estimated about sixty miles. As this part of Greenland has never been visited by Europeans, our knowledge of its natural condition is limited. The natives state that there are deep fjords here, and great high plateaux partly covered with glaciers.

ON May 14, at 12.30 a.m., a remarkable phenomenon was observed at Nyköping in Sweden. The weather was dull and

rainy, when suddenly streamers of light were seen in the northern sky running from west to east. They were seen twice, the first time lasting about a minute, but the second very short. The light was so intense that the streets became quite light.

THE Museum of the Kendal Literary and Scientific Institution possesses a valuable series of Carboniferous fossils. Most of the zoological groups are well represented, especially in relation to Brachiopoda and Gasteropoda, the former containing large examples of *Productus giganteus*, Martin, and the latter important specimens of *Euomphalus croctolostomus*, M'Coy, and *Phanerotinus cristatus*, Sowerby. The fossils are chiefly local, many of them having been collected by the once well-known geologist of Kendal, John Ruthven, who prepared the geological map for Miss Martineau's "English Lakes." This collection has recently been named, classified, and catalogued by Mr. R. Bullen Newton, F.G.S.

IN the letter by M. Antoine d'Abbadie in NATURE for May 29 (p. 101), the passage, "it was then 24m. 8s. past midnight," should be omitted.

THE additions to the Zoological Society's Gardens during the past week include two Squirrel Monkeys (*Chrysothrix sciurea* ♂ ♀) from Brazil, presented by Mr. Robert Thom; two Black-cared Marmosets (*Hapale penicillata* ♂ ♂) from South-East Brazil, presented by Mr. C. D. Middleton; a Common Squirrel (*Sciurus vulgaris*), British, presented by Mrs. Grover; a Marsh Ichneumon (*He. pestes galera*), a Dusky Ichneumon (*Herpestes pulverulentus*) from South Africa, presented by Dr. Holub; C.M.Z.S.; two Sociable Vultures (*Vultur auricularis*) from Africa, an Angolan Vulture (*Gypohierax angolensis*) from West Africa, presented by Sir Donald Currie; a Gray Amphispæna (*Bianus cinereus*) from Spain, presented by Mr. W. C. Tait, C.M.Z.S.; a Burchell's Zebra (*Equus burchellii* ♀) from South Africa, two Common Camels (*Camelus dromedarius*) from Egypt, five Horned Lizards (*Phrynosoma cornutum*) from North America, deposited; five Goldeneyes (*Clanula glaucion*), five Common Snakes (*Tropidonotus natrix*), twenty-four Green Lizards (*Lacerta viridi*), European, purchased; and a Japanese Deer (*Cervus sika* ♀), a Mexican Deer (*Cervus mexicanus* ♀), a Long-fronted Gerbille (*Gerbillus longifrons*), born in the Gardens.

#### OUR ASTRONOMICAL COLUMN

THE OBSERVATORY OF PARIS.—Admiral Mouchez's report on the state of this establishment and the work accomplished therein during the past year commences with some details of his scheme for erecting a succursal observatory at a distance from Paris, where the disadvantages of location in the midst of a great city would be avoided. His proposal was to dispose of a part of the actual grounds of the Observatory, a step which would be likely to realise a sum adequate to the erection of the new building, at the same time retaining the present one to form the head-quarters of the Bureau des Calculs, the Archives, and the Museum, the two establishments to remain under the same direction and to constitute together the Observatory of Paris. This scheme, it is known, has not met with general acceptance at the hands of the scientific authorities.

M. Lœwy, in charge of the Meridian Service, has been occupied with the reobservation of stars in the Catalogue of Lalande, while a large number of observations of the sun, moon, and planets has also been made, eighteen observers taking part in this work in the course of the year. The equatorials of 12 and 14 inches aperture and the equatorial *coude* were employed on observations of comets and small planets. The Ecliptical Charts Nos. 12, 19, 48, and 67 have progressed, and attention has been paid to double-star measures. M. Mouchez reports that the construction and installation of the great telescope (0.74 m.) has been retarded by the difficulty of establishing it in the grounds of the Observatory at Paris. In the Department of Astronomical Physics MM. Thollon and Trépiéd had been occupied for six weeks on the Pic du Midi, where, with M. Naussinat, in

present charge of the Observatory, they studied the advantages of the station, more especially for solar observations, concluding that great scientific interest would attach to work that might be accomplished during the four or five weeks of the fine season in a small observatory at that point. Funds for the purpose are not yet available.

M. Mouchez further reports upon the distribution of time in Paris, the additions to the Museum during the year, which consist of instruments of the last century found in the Observatory of Toulouse, a portrait of Copernicus, &c.; the work of the Bureau des Calculs, which remains in charge of M. Gaillot; the publications of the Observatory during the year, including vol. xvii. of the *Annals*, in which are some important memoirs theoretical and practical; and the personal work of the staff.

A plan of the grounds of the Institution is appended, on which are distinguished those portions which M. Mouchez had proposed to alienate with the view to providing means for the erection of an observatory at a distance from Paris.

THE GREAT COMET OF 1882.—In an appendix to the Washington Observations, 1880, is an account prepared by Mr. W. C. Winlock, at the desire of the Superintendent of the Naval Observatory, Admiral Shufeldt, on the great comet of 1882 as observed at Washington, first with the 9.6 inch and subsequently with the 26-inch refractor. The latest date on which the comet's position was determined is April 4, 1883. Micrometrical measures of the nucleus were made on a number of evenings, and from a plate showing its aspect and formation between February 1 and March 3 the difficulty of deciding upon the proper point for observations of position, owing to the existence of several almost equally luminous condensations in the head of the comet, is very apparent. For a similar reason, in another plate the points observed with the transit-circle from September 19 to March 3 are shown. There has rarely, if ever, existed a greater need for precautions of this nature, to assist in the combination of the places obtained at various observatories, for the accurate determination of the orbit. The comet was first seen at Washington shortly after noon on September 19, and was visible for several hours to the naked eye about twenty-eight minutes preceding the sun and 1° 2' further south. In the 9.6-inch equatorial "it presented the appearance of a bird with wings extended," a description that applies to other comets that have been seen in daylight or in a very strongly illuminated sky, as for instance the first comet of 1847, figured in Johnston's "Atlas of Astronomy."

#### GEOLOGICAL NOTES

CANADIAN COALS AND LIGNITES.—Dr. G. M. Dawson collects and publishes, chiefly from the Reports of the Geological Survey of Canada, some useful Notes on the Coals and Lignites of the Canadian North-West. These mineral fuels are all of Cretaceous and Tertiary age. They are extensively developed near the Bow and Belly Rivers and their tributaries, extending eastward from the base of the mountains to about the 111th meridian; but as this is the only region yet examined in detail by the Survey, there may yet prove to be other districts of equal value. Where the Cretaceous rocks have been much disturbed and folded, the coal passes into the condition of anthracite, of which a seam occurs on the Cascade River near its confluence with the Bow River and close to the line of the Canadian Pacific Railway. Out on the plains, however, the strata are nearly flat, and as they recede from the mountains the coals show a larger percentage of water, and assume more or less completely the character of lignites.

BELGIAN ERRATICS.—To the already cited examples of fragments of Scandinavian rocks in the post-Tertiary deposits of Belgium Mr. E. van den Broeck has recently added the discovery of a piece of granite (measuring 0.8 × 0.5 × 0.6 metre) in the most northern part of the kingdom, embedded in the fine Campinian sands of Wortel—apparently the first Belgian example of any fragment large enough to claim perhaps the name of an erratic block (*Ann. Soc. Géol. du Nord*, xi. p. 2).

POSITION OF THE CALLOVIAN ROCKS.—M. Paul Choffat protests against the inclusion of the Callovian among the Upper Jurassic formations, as was decided at the last Conference of the International Commission on Geological Nomenclature. This decision, based on the palæontological affinity of the Callovian and Oxfordian stages he believes to be theoretically false and to be practically impossible of application in any general map of the whole of Europe. He gives a *résumé* of obser-

vations which in his opinion demonstrate that in the chain of the Jura, the east of the Paris basin, and in Portugal the lower part and even the whole of the Callovian are locally replaced by an extension of the Bathonian deposits. — (*Jornal de Sciencias Mathematicas, &c.*, Lisboa, No. xxxvii., 1884.)

**THE GLACIAL BOUNDARY IN OHIO.**—Prof. G. F. Wright has for ten years past been studying the glacial phenomena of the Eastern States of the Union. Beginning with the kames of the Merrimac Valley in Eastern Massachusetts, he has followed the last edge of the glacial trail from the Atlantic border across to the southern part of Illinois. How much further he may have to trace it westwards he is at a loss to know. Meanwhile he gives an interesting outline of his labours in a pamphlet just issued by the Western Reserve Historical Society of Cleveland, Ohio. The edge of the deposits left by the ice-sheet of the Glacial Period or "terminal moraine," as the American geologists call it, has been traced by him from the western part of Pennsylvania across the southern counties of Ohio and the northern margin of Kentucky to near the Miami and Ohio Rivers. It then enters Indiana and makes a great northward sweep as far as Martinsville, a little south of Indianapolis, whence it turns south-westwards and passes into Illinois a little above the confluence of the Wabash with the Ohio. The Report gives detailed maps of the "moraine" in its passage across Ohio, with descriptions of the nature and form of the drift ridges in the different counties and townships.

**HYPERSTHENE-ANDESITE AND TRICLINIC PYROXENE IN AUGITIC ROCKS.**—The United States Geological Survey has begun the issue of a *Bulletin* designed to appear from time to time in single parts, each containing a single paper complete in itself. These papers are to be such as relate to the general work of the Survey, but do not properly come within the scope of the Annual Reports or Monographs. The first number is devoted to the rocks of Buffalo Peaks, Colorado. A sketch of their geology by Mr. Emmons, the geologist in charge of the Rocky Mountain Division of the Survey, is followed by a detailed description of some volcanic masses by Mr. Whitman Cross, in which he continues his interesting researches on pyroxenic rocks. As fragments among the beds of tuff and likewise in place on the shoulder of the main Buffalo Peak, there occur certain augite-andesites the microscopic study of which reveals some important peculiarities. The pyroxenic constituent shows that a rhombic mineral, probably hypersthene, is largely predominant, while a great number, if not all, of the remaining crystals must be considered as triclinic. The occurrence of triclinic pyroxene had already been detected by the author among the crystalline schists of Brittany. He has been led to re-examine many pyroxenic rocks (diabase, melaphyre, basalt, &c.) from widely separated localities, with the result of finding, in some common rocks from well-known localities, that the augite, when placed between crossed Nicol prisms, is extinguished at a very decided angle from the diagonals of the prism. This abnormal action he thinks must show either that the mineral in question is triclinic or that there is an "optical anomaly." Following the example of Fouqué, who isolated and analysed the normal augite and unsuspected hypersthene of the Santorin andesite, Mr. Cross isolated the rhombic pyroxene of the rock of Buffalo Peaks, and proved its crystalline form by examining detached crystals under the microscope. He likewise submitted it to chemical determination, which proved it to be true hypersthene. These researches induced him to test the character of the pyroxenic constituent in other andesites from all parts of the world. He has found that a rhombic pyroxene is much more abundant in porphyritic crystals than augite. He suggests the need of a reclassification of andesite rocks, of which he thinks three main groups may be distinguished. At one extreme are the varieties with a trachytic character rich in felspar, often containing quartz or tridymite, and with a more crystalline ground-mass. At the other extreme are some basalt-like masses, but with little or no olivine. The normal "augite-andesites" form the intermediate group.

### KRAKATOA AND THE SUN-GLOWS

IN the last issue of the *Bulletin of the St. Petersburg Academy of Sciences* (vol. xxix. No. 2), M. Rykatcheff publishes a very interesting paper on the atmospheric waves produced by the Krakatoa eruption. General Strachey and Mr. R. H. Scott

(NATURE, vol. xxix. p. 181) have already shown how the eruption must have produced an atmospheric wave which has been noticed by the barometers at many meteorological observatories. The wave was propagated in concentric circles, increasing in diameter until it reached the great circle; then, it contracted until reaching a point on the antipode of Krakatoa, whence the wave returned in the same way to its point of origin; then, gradually diminishing in intensity, it made for a second and third time its way around the earth. M. Rykatcheff now publishes the curve of the barograph of Pavlovsk for August 27 to 30, where the influence of the atmospheric wave is pretty well seen; and he discusses the results obtained from observations at thirty-one different stations (Pavlovsk, St. Petersburg, Berlin, Leipzig, Magdeburg, Brussels, Paris (I. and II.), Toulouse, Greenwich, Kew, Aberdeen, Stonyhurst, Liverpool, Glasgow, Falmouth, Armagh, Valentia, Georgia Island, Coimbra, and Toronto). It appears from these observations, when calculated according to Gen. Strachey's method, that is, by taking the time between two successive passages of the wave at the same station, that, for European stations, on the average the wave took 36h. 38m. to make its way around the earth when it was going from east to west, and 35h. 54m. when going from west to east. The accordance of the figures for different observatories is striking (excepting Tolosa), the greatest deviation from the average being only + 33m. and - 38m. in the first case, + 27m. and - 39m. in the second. The average speed would thus be: for the first wave, 303.3 metres, and 316.1 metres for the second. The calculated time of the Krakatoa eruption would be between 9h. 6m. and 9h. 42m. Krakatoa mean time; or, on the average, 9h. 23m. When the calculations are made on M. Wolf's method (which admits the same speed in both directions), the average speed of the wave is 334.3 metres, and the time of the eruption would be 10h. 39m. Krakatoa mean time. Finally, M. Rykatcheff makes the calculations by deducing both speed and time of eruption from observations made at two stations next to Krakatoa (Pavlovsk and St. Petersburg), and then he calculates from equations made for all other stations the error of the two observations. He receives thus 321.4 metres for the speed of the wave, and 10h. 16m. for the time of the eruption at Krakatoa. These results are more in accordance, he says, with the result obtained by Herr Wolf's method, and, combining both, M. Rykatcheff takes as probable 327.9 metres for the speed, and 10h. 27m. for the time of the eruption. As to the amplitudes of the oscillations of the barometers at different stations, they vary from 0.9 to 1.7 mm. and reach 2.5 mm. at Georgia Island.

To the *Meteorologische Zeitschrift* for 1884 Dr. G. Hellmann contributes a learned paper on the recent glows. No theory is advanced as to their origin, and the interest of the paper is mainly historical. The oldest reference to similar phenomena the writer has been able to discover is that of the Flemish physician, H. Bruceus, who, in 1570, dedicated a "Tractatus de Crepusculis" to Tycho Brahe. In this work occurs the passage: "Cum autem diluculum initium sumat, ubi aer splendescere incipit, idque eveniat cum lumen solis ab aere, ob vapores permixtos crassiores, versus horizontem reflectitur, patet non in eadem distantia solis ab horizonte crepuscula semper incidere, quod non una sit semper aeris densioris sive vaporum, a quibus fieri possit radiorum reflexio, altitudo."

In the *Annales de Chimie et de Physique*, sixth series, vol. i. 1884, MM. Perrotin and Thollon deal with the same subject from the physical standpoint. They give an able *résumé* of the various accounts that have appeared, especially in NATURE, and seem on the whole disposed to accept the theory of the volcanic origin of the after-glows.

A correspondent, F. A. R. R., sends us the following communication on the subject:—

The matter projected into the upper atmosphere appears to have passed round the globe westwards with great velocity, and to have diffused itself towards north and south much less rapidly. A stratum of fine dust thus formed itself at an elevation probably exceeding the altitude of the known upper currents. This stratum caused the sun to look green or blue on the Gold Coast, in the West Indies, at the Sandwich Islands, in India and the Indian Ocean, and last, as late as September 24, in the Soudan, nearly a month after the eruption of Krakatoa. The moon and stars were frequently greenish in Europe in December and January, up to four months and a half after the eruption, and the sun whiter than usual towards setting. The finely divided matter which thus deprived the sun and moon of

part of the rays which go to form the compound white, was plainly of a different grain from the small particles commonly present in the sky, for these arrest the blue rays and scatter them, allowing the rays towards the red end of the spectrum a freer passage, so as to impress the eye with the predominant red colour of luminous objects seen through a long stretch of atmosphere. Since the declining sun in India turned strongly green, the particles competent to arrest the red rays must have exceeded, in the path of the rays, the ordinary blue-arresting particles in quantity or power. But as the sun approached close to the horizon, the lower atmosphere, by cutting off the more refrangible rays, reduced the green, and sometimes caused the red to predominate in the setting sun. The particles of a common blue haze cause the sun to set deep red. The volcanic dust particles may have exceeded in magnitude the particles which cause haze, and possibly the stratum may have contained particles which might be visible under the microscope. That this dust stratum was still present in the higher atmosphere in January was indicated by the greenish tinge of moon and stars. It was largely composed of particles of sufficient magnitude to reflect white light, for a little before sunrise the sky seemed clouded over with something resembling white cirrus haze; but like a film of dust on a mirror, or the floating dust in a room, it was not visible except at certain angles. Condensed vapour, or ice particles in a very fine state of division, would account for the persistent halo or corona of varying radius, but so also would particles of transparent pumice. Assuming the red-arresting stratum to have remained during the autumn and winter months at altitudes from forty to twenty miles, descending say 1000 feet per day during 100 days, the effects observed after sunset and before sunrise were only what might be expected to follow by reflection from the minute surfaces. In the case of ordinary cirrus, the tints up to half an hour after sunset are as follows: white, pale yellow, yellow, orange, pink, red, deep red; or the red only may be visible if the texture be thin and the early twilight strong. With a continuous red-arresting stratum, however, we must consider what influence its horizontal breadth, through which the sun's rays must pass when near setting, would have upon the light reflected from the western sky. At a height of thirty miles the sun would be shining through a great length of the stratum, as viewed from the elevated point, when it had already set on the earth immediately below. At this point, thirty miles above the earth's surface, supposing that to be the height of the stratum, the vapour of the lower air would not yet be strongly exerting its influence in arresting the blue rays, but the sheet of dust would exert its maximum power of stopping the red rays, and the light which survived best, and which from the earth's surface we should see reflected soon after sunset from above the western horizon, would be green. The stratum being so composed as to be capable of reflecting all kinds of light, but by its own action through a great breadth filtering out some of the less refrangible rays, as it did more powerfully in India when less attenuated, the reflected light of the sun above the western horizon, and indeed towards north and south as well, could not fail to be affected with an excess of green. As the sun sank still lower, viewed from the height of thirty miles, it would begin to be largely robbed of the blue and green rays by the ordinary lower atmosphere, and the next colour in the western sky would consequently be yellow, which would equally be reflected by the matter composing the stratum. The yellow would be the result of a competition between the red-arresting upper dust and the blue-arresting lower air. As the sun descended still lower, the power of the ordinary vapour-charged strata would assert itself, and the yellow would pass to orange, pink, and crimson, just as the colour of the sun seen from any eminence commonly changes in setting. The upper haze would merely reflect these naturally changing colours, but the later tints would be more striking as darkness increased. All the changes observed in the first after-glow are thus fully accounted for by larger than ordinary sky particles arresting red waves and the general mass of the stratum reflecting all rays falling upon it. The secondary after-glow would show similar gradations if the first were strong enough to emit much light, but the red in it would be most conspicuous, for the action of the lower air in eliminating blue would be more powerful than the thin veil of dust in eliminating red. There was, however, a distinct greening of the eastern sky on several occasions, signifying the approach of the secondary after-glow. The increase of apparent brilliancy of both glows as they sank westwards would of course be due to perspective.

## THE FIXED STARS<sup>1</sup>

### II.

I HAVE said that the angle between the stars is measured in terms of the scale, but the scale-value, in seconds of arc, may change by the effects of temperature and from other causes.

Bessel, in his researches on the parallax of 61 Cygni, determined by independent means the effect of temperature on his scale-value, and applied corresponding corrections to his observations. But he also took the precaution to employ two stars of comparison situated at right angles to each other with respect to the principal star, so that the effect of parallax would be at a maximum for one comparison star at the season of the year when it was at zero for the other, and *vice versa*.

But in the course of previous researches I found that there were sources of error other than mere change of the temperature of the air, viz. differences of temperature in different parts of the instrument, and changes in the normal focus of the observer's eye, which exercised a very sensible influence on the results. It was necessary to devise some method by which these should also be eliminated.



DIAGRAM II.—Showing comparison stars employed in determining the parallax of a Centauri.

There is a very simple means of doing this. Instead of taking two comparison stars at right angles, take two comparison stars situated nearly symmetrically on opposite sides of the star whose parallax is to be determined—such, for example, as the stars  $\alpha$  and  $\beta$  in Diagram II. Now observe these distances in the order  $\alpha$ ,  $\beta$ ,  $\beta$ ,  $\alpha$ , on each night of observation; so that on each night the observations of both distances are practically made at the same instant. Then, whatever causes have combined to create a systematic error in the measurement of one of these distances, precisely the same causes must create precisely similar systematic error in the measurement of the other distance. Thus if, by the regular or irregular effects of temperature or by changes in the normal condition of the observer's eye, we measure the distance  $\alpha$  too great, so for the simultaneous observations of the distance  $\beta$  we shall from precisely the same causes measure that distance too great also.

But the *difference* of the distances will be entirely free from all errors of the kind; and, if the distances are not quite equal, it is very easy to apply a correction on the assumption that the sum of the distances is a constant.

In Diagram II. the circle represents a radius of  $2''$  surrounding the star  $\alpha$  Centauri. The distance of the component stars  $\alpha_1$  and  $\alpha_2$  Centauri in the diagram is enormously exaggerated for the sake of clearness. Guided by the principles just explained, search was made for comparison stars in pairs symmetrically situated with respect to  $\alpha$  Centauri, and otherwise favourably situated for measurement of parallax.

You will remember that from the effects of parallax all stars appear to describe small ellipses about a mean position; stars near the pole of the ecliptic describing nearly circles, and those

<sup>1</sup> Lecture on Friday evening, May 23, at the Royal Institution, "On Recent Researches on the Distances of the Fixed Stars, and on some Future Problems in Sideral Astronomy," by David Gill, LL.D., F.R.S., Her Majesty's Astronomer at the Cape of Good Hope. Continued from p. 137.

near the ecliptic very elongated ellipses. Obviously, then, those pairs of stars are most favourable—other conditions being equal—which lie near the major axis of the parallactic ellipse. The dotted ellipse in Diagram II. represents the form of the parallactic ellipse; that is to say, the form of the apparent path which  $\alpha$  Centauri must describe if it is affected by parallax. Of course the size of the ellipse is exaggerated—in fact in the diagram nearly 5000 times—therefore remember that the diagram represents only that which we can compute before we have observed, viz. the *shape* of the ellipse, or the relations of the lengths of the two axes; the *absolute* size has to be determined from the observations.

The most favourable couple of comparison stars in our drawing

is that marked  $\alpha$  and  $\beta$ —they are nearest to the major axis of the parallactic ellipse, and they are very symmetrically situated with respect to  $\alpha$  Centauri.

Now turn to Diagram III. Here is exhibited the results of my measures on a very large scale—in a manner similar to that in which the height of the barometer for different hours of the day, or the comparative price of wheat at different seasons of the year or in different years, is now exhibited in the daily papers. Imagine the star  $\alpha$  about a mile immediately below any point of that curve, and the star  $\beta$  rather over three-quarters of a mile immediately above the same point, and you would then have a diagram to scale.<sup>1</sup> The middle horizontal line represents the mean difference of these two distances, and each dot or

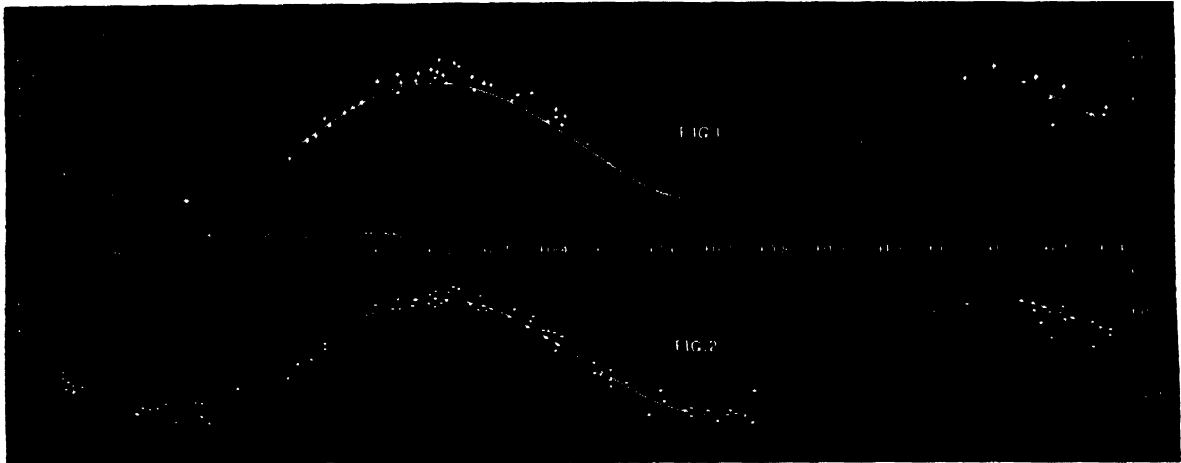

DIAGRAM III.—Curves showing the results of the observations of  $\alpha$  Centauri relative to the comparison stars  $\alpha$  and  $\beta$ .



DIAGRAM IV.—Curve showing results of observations of Sirius for parallax.



DIAGRAM V.—Curve showing results of observations of  $\epsilon$  Indi for parallax.

mark on Fig. 1 of the diagram represents the variation of that distance according to each successive observation. The different kinds of dot represent measures made at different hour angles, or when the relation of the direction of measurement to the line joining the observer's eye is different. These different kinds of personal errors were separately investigated, and they were then allowed for and the observations were corrected accordingly.

The observations so corrected are represented in Fig. 2, where each black dot expresses the result of the observations of a single night, and the curve is the computed curve resulting from a mathematical discussion of the observations.

You must be careful to understand that this is not simply the kind of curve which best represents the observations. The curve is limited by purely geometrical conditions to have its maximum on March 7 and its minimum on September 10, and to follow a

precise form of curve according to a simple law. The observations only determine the range from maximum to minimum, and yet you see how perfectly the maximum of the observations agrees with the maximum of the curve, and the minimum of the observations with the minimum of the curve, and how closely the law is followed throughout.

The result was that from these observations the parallax of  $\alpha$  Centauri was  $0''.747$ , or practically three-quarters of a second of arc.

But I was not content with this result alone. I wished further confirmation, and selected another pair of stars,  $\alpha'$  and  $\beta'$ , shown in Diagram II.

<sup>1</sup> In the wall diagram one second of arc was represented by about 15 inches.

From similar observations with these comparison stars I obtained for the parallax of  $\alpha$  Centauri  $0''\cdot760$ , a result which is identical with the last within the limits of the probable error of either.

My friend Dr. Elkin selected the stars  $a\delta$  and  $a'\delta'$  as his comparison stars, and in a precisely similar way he obtained as the mean of his results a parallax of  $0''\cdot752$ , a result identical with my own, so that we may conclude as one of the most certainly established facts of astronomy that the parallax of  $\alpha$  Centauri relative to an average star of the seventh or eighth magnitude is three-quarters of a second of arc.

It is therefore beyond all doubt that Henderson's discovery was a real one. Herschel's verdict must therefore be confirmed, and the palm for first breaking down the barriers that separated us from any knowledge of the distances of the fixed stars be accorded to the memory of the Cape Astronomer Henderson.

So far as all existing researches go,  $\alpha$  Centauri is the nearest of the fixed stars. Regarding the faint comparison stars as practically infinitely distant, let us try to realise how near or how far distant  $\alpha$  Centauri really is.

There are, of course, an infinite number of illustrations which one might employ to convey some idea of such a distance. I shall content myself with one of them—something akin to which has already been used by Dr. Ball within these walls.

We are a commercial people, we like to make our estimates in pounds sterling. We shall suppose that some wealthy directors have failed in getting Parliamentary sanction to cut a sub-Atlantic tunnel to America, and so for want of some other outlet for their energy and capital they construct a railway to  $\alpha$  Centauri. We shall neglect for the present the engineering difficulties—a mere detail—and suppose them overcome and the railway open for traffic.

We shall go further, and suppose that the directors have found the construction of such a railway to have been peculiarly easy, and that the proprietors of interstellar space had not been exorbitant in their terms for right of way. Therefore, with a view to encourage traffic, the directors had made the fares exceedingly moderate, viz. first class at one penny per 100 miles.

Desiring to take advantage of these facilities, an American gentleman, by way of providing himself with small change for the journey, buys up the National Debt of England and of a few other countries, and, presenting himself at the booking-office, demands a first-class single to  $\alpha$  Centauri. For this he tenders in payment the scrip of the National Debt of England, which just covers the cost of his ticket; but I should explain that at this time the National Debt, from little wars coupled with some unremunerative Government investments in landed property, had run up the National Debt from 700 millions to 1100 millions sterling. Having taken his seat, it occurs to him to ask—

At what rate do you travel?

Sixty miles an hour, sir, including stoppages, is the answer.

Then when shall we reach  $\alpha$  Centauri?

In forty-eight million six hundred and sixty-three thousand years, sir.

Humph, rather a long journey.

But enough of joking. If we wish to deal with distances so immense, we must adopt a more convenient unit of measure.

The most convenient unit for our purpose is the number of years that light would take to reach us. Light takes almost exactly 500 seconds of time to come from the sun; this is a figure easy to remember, and is probably exact to a single unit. The sun is ninety-three millions of miles distant, and this figure I believe to be exact within 200,000 miles.

Quite recently the accuracy of these figures has been confirmed in a very remarkable way by different kinds of investigations by different observers; otherwise I should not have quoted them with so much confidence.

The parallax of  $\alpha$  Centauri is three-quarters of a second of arc; therefore its distance is 275,000 times the distance of the earth from the sun, and therefore light, which travels to the earth from the sun in 500 seconds (*i.e.* in  $8\frac{1}{2}$  minutes) would take  $4\cdot36$ , or a little more than  $4\frac{1}{2}$  years to come from  $\alpha$  Centauri.

You will find in the accompanying table a specific account of the other results which were arrived at by Dr. Elkin and myself by precisely similar means, and you will find on the wall diagrams representing my own detailed observations in the case of Sirius and  $\epsilon$  Indi.

TABLE II.—Results of Recent Researches on the Parallax of Stars in the Southern Hemisphere

Name of Star	Observer	Annual proper motion in arc	Parallax	Star's distance in light units, or number of years in which light from star would reach the earth	Velocity of star's motion in miles per second at right angles to line of sight
$\alpha$ Centauri ...	G. & E.	3 <sup>h</sup> 67	0 <sup>h</sup> 75	4 <sup>h</sup> 36	14 <sup>h</sup> 4
Sirius ...	G. & E.	1 <sup>h</sup> 24	0 <sup>h</sup> 38	8 <sup>h</sup> 6	9 <sup>h</sup> 6
Lacaille 9352	G.	6 <sup>h</sup> 95	0 <sup>h</sup> 28	11 <sup>h</sup> 6	73
$\epsilon$ Indi ...	G. & E.	54	0 <sup>h</sup> 22	15	63
$\sigma_2$ Eridani ...	G.	44	0 <sup>h</sup> 17	19	69
$\epsilon$ Eridani ...	E.	44	0 <sup>h</sup> 14	23	64
$\zeta$ Tucanæ ...	E.	2 <sup>h</sup> 05	0 <sup>h</sup> 06	54	101
Canopus ...	E.	0 <sup>h</sup> 00	Insen- sible		
$\beta$ Centauri ..	G.	—	Insen- sible		

Time does not permit me to go into more detail as to each of these separate results, full of interest though they are, and each of them representing months of labour.

My object now is to generalise, to point out the conclusions that must be drawn from these two tables of parallax (Tables I. and II.), and to see what are the broad lessons that they teach us.

A glance is sufficient to show that neither apparent magnitude nor apparent proper motion can afford a definitive criterion of the distance of any fixed star—that different stars really differ greatly in absolute brightness and in absolute motion.

And now, what is the work before us in the future?

The great cosmical problem that we have to solve is not so much what is the parallax of this or that particular star, but we have to solve the much broader questions—

1. What are the average parallaxes of stars of the first, second, third, and fourth magnitudes, compared with those of fainter magnitude?

2. What connection does there subsist between the parallax of a star and the amount and direction of its proper motion, or can it be proved that there is no such relation or connection?

With any approximate answer to these questions we should probably be able to determine the law of absorption of starlight in space, and be provided with the data at present wanting for determining with more precision the constant of precession and the amount and direction of the solar motion in space. And who can predict what hitherto unknown cosmical laws might reveal themselves in the course of such an investigation?

It is important to consider whether such a scheme of research is one that can be realised in the immediate future, or one that can only be carried to completion by the accumulated labours of successive astronomers.

I have very carefully considered this question from a practical point of view, and I have prepared a scheme, founded on the results of my past experience. I have submitted that scheme for the opinion of the most competent judges, and in their opinion, as well as my own, the work can be done, with honest hard work for one hemisphere, within ten years. I have offered to do that work for the southern hemisphere with my own hands, and a proposal for the necessary instruments and appliances is now under the consideration of my Lords Commissioners of the Admiralty. I need hardly add that in this matter I look confidently for that complete consideration and that efficient support which I have never failed to receive at their hands since I have had the honour to serve them.

The like work will be undertaken for the northern hemisphere by my friend Dr. Elkin, who is now in charge of the heliometer at Yale College in America. It is at present the finest instrument of the kind in the world, and a photograph of it you have already seen upon the screen.

I most earnestly trust that we may be granted health and strength for this work, and that no unforeseen circumstances will prevent its complete accomplishment.

Before closing this lecture I wish briefly to allude to another engine of research in sidereal astronomy which quite recently

has received an enormous development, and whose application appears to offer a rich harvest of results. I refer to the application of photography to astronomical observation.

Your respected member, Mr. De la Rue, is the father of this method. Time does not permit me to dwell on his early endeavours and his successful results, but they are well known to you all. He opened up the field, and he cleared the way for his successors.

The recent strides in the chemistry of photography and the production of dry plates of extreme sensibility have permitted the application of the method to objects that formerly could not be photographed. Here, on the screen, are the spectra of stars photographed directly from the stars by Dr. Huggins, the lines which tell of the chemical constitution and temperature of the star's atmosphere being sharply defined.

Here are photographs of the great comet of 1882, which, with the cooperation of Mr. Allis of Mowbray, I obtained at the Cape, by attaching his ordinary camera to an equatorially mounted telescope, and with its aid following the comet exactly for more than two hours. Each one of the thousands of points of light that you see is the picture of a fixed star. The photograph suggests the desirability of producing star maps by direct photography from the sky.

Here on the screen is a photograph of the great nebula of Orion, or rather a series of photographs of it made by Mr. Common of Ealing. You will note the gradual development of detail by increase of exposure, and the wonderful amount of detail at last arrived at. Here are photographs from drawings of the same, and you will note the discrepancies between them. And here is a photograph of a star cluster also by Mr. Common.

No hand of man has tampered with these pictures. They have a value on this account which gives them a distinct and separate claim to confidence above any work in which the hand of fallible man has had a part.

The standpoint of science is so different from that of art. A picture which is a mere copy of nature, in which we do not recognise somewhat of the soul of the artist, is nothing in an artistic point of view; but in a scientific point of view the more absolutely that the individuality of the artist is suppressed, and the more absolutely a rigid representation of nature is obtained, the better.

Here is a volume compiled by one of the most energetic and able of American astronomers—Prof. Holden. It contains faithful reproductions of all the available drawings that have been made by astronomers of this wonderful nebula of Orion from the year 1656 to recent times.

If now we were to suppose one hundred years to elapse, and no further observation of the nebula of Orion to be made in the interval; if in some extraordinary way all previous observations were lost, but that astronomers were offered the choice of recovering this photograph of Mr. Common's, or of losing it and preserving all the previous observations of the nebula recorded in Prof. Holden's book—how would the choice lie? I venture to say that the decision would be—Give us Mr. Common's photograph.

Is it not therefore now our duty to commence a systematic photographic record of the present aspect of the heavens? Will not coming generations expect this of us? Does not photography offer the only means by which, so far as we know, man will be able to trace out and follow some of the more slowly developing phenomena of sidereal astronomy?

Huggins has shown how the stars may be made to trace in the significant cipher of their spectra the secrets of their constitution and the story of their history. Common has shown us how the nebulae and clusters may be separately photographed, and it is not difficult to see how that process may be applied, not only to special objects, but piece by piece to the whole sky, till we possess a photographic library of each square half-degree of the heavens. But such a work can only be accomplished by consummate instruments, and with a persistent systematic continuity which the unaided amateur is unable to procure and to employ. It is a work that must be taken up and dealt with on a national scale, on lines which Huggins and Common have so well indicated, and which has already been put in a practical form by a proposal of Norman Lockyer's at a recent meeting of the Royal Astronomical Society.

I would that I had the power to urge with due force our duty as a nation in this matter, but my powers are inadequate to the task.

I employ rather the words of Sir John Herschel, because

no words of mine can equal those of him who was the prose-poet of our science, whose glowing language was always as just as it was beautiful, and whose judgment in such matters has never been excelled. They were spoken in the early days of exact sidereal astronomy, when the strongholds of space were but beginning to yield the secret of their dimensions to the untiring labour and skill of Bessel, of Struve, and of Henderson. Think what they would have been now when they might have told how Huggins' spectroscope had determined the kinship of the stars with our sun, how it had so far solved the mysteries of the constitution of the nebulae, and pointed out the means of determining the absolute velocity of the celestial motions in the line of sight. Think what Herschel would have said of those photographs by Common that we have seen to-night of that nebula that Herschel himself had so laboriously studied, and whose mysterious convolutions he had in vain endeavoured adequately to portray; and think of the lessons of opportunity and of duty that he would have drawn from such discoveries, as you listen to his words spoken forty-two years ago:—

“Such results are among the fairest flowers of civilisation. They justify the vast expenditure of time and talent which have led up to them; they justify the language which men of science hold, or ought to hold, when they appeal to the Governments of their respective countries for the liberal devotion of the national means in furtherance of the great objects they propose to accomplish. They enable them not only to hold out but to redeem their promises, when they profess themselves productive labourers in a higher and richer field than that of mere material and physical advantages.

“It is then, when they become (if I may venture on such a figure without irreverence) the messengers from heaven to earth of such stupendous announcements as must strike every one who hears them with almost awful admiration, that they may claim to be listened to when they repeat in every variety of urgent instance that these are not the last of such announcements which they shall have to communicate, that there are yet behind, to search out and to declare, not only secrets of nature which shall increase the wealth or power of man, but TRUTHS which shall ennoble the age and country in which they are divulged, and, by dilating the intellect, react on the moral character of mankind. Such truths are things quite as worthy of struggles and sacrifices as many of the objects for which nations contend, and exhaust their physical and moral energies and resources. They are gems of real and durable glory in the diadems of princes, and conquests which, while they leave no tears behind them, continue for ever unalienable.”

#### UNIVERSITY AND EDUCATIONAL INTELLIGENCE

CAMBRIDGE.—The following are among the Readers and University Lecturers just now appointed:—Readers—Comparative Philology, Dr. Peill; Botany, Dr. Vines. University Lecturers—Comparative Philology, Mr. E. S. Roberts; Sanskrit, Mr. Neil; Mathematics, for Part 3 of the Tripos, Division A, Mr. Forsyth; Division B, Mr. Hobson; Division C, Mr. Glazebrook; Division D, Mr. J. J. Thomson; Applied Mechanics, Mr. Macaulay; Botany, Mr. F. Darwin; Animal Morphology, Mr. A. Sedgwick; Advanced Physiology, Dr. Gaskell and Mr. Lea; Histology, Mr. Langley; Geology, Mr. D. Roberts; Moral Science, Mr. Keynes.

Prof. Colvin has presented to the Fitzwilliam Museum between eight and nine hundred books on Classical Archaeology, on behalf of certain members of the University, to be deposited in the library of the Museum of Classical Archaeology.

A warm discussion arose on the 30th ult. in the Arts School, on the Report recommending the erection of new lecture-rooms and work-rooms for Biology and Physiology. Mr. Huddleston said the estimate of 3000*l.* a year ago had grown to 10,000*l.* now. He had hoped that finality was reached last year. Mr. Oscar Browning objected to the proposals that they were reckless and extravagant. Why not ventilate the present lecture-rooms, if they were so much used as was described? The proposal to buy 150 microscopes for 1000*l.* was one of the most ridiculous he ever heard of. Why should not each student bring his own? A science man's library was exceedingly small and inexpensive. Mr. Mayo thought sufficient accommodation might be provided by using the Museum of Zoology as a lecture-room for large classes. Mr. Sedgwick described the inconveniences felt in the late course of Elementary Biology, when 206 men had to peck



themselves where only 140 could properly sit. Many sat on the stairs, and in positions where they could not see the blackboard. Mr. Trotter urged that the medical students could not be expected to provide capital sums for buildings. The large class in Elementary Biology this year would want to attend Physiology next year. It was impossible that finality could be attained. Prof. Foster explained the serious inconveniences of requiring every student to bring his own microscope to these classes; they ought to belong to and remain in the laboratory. The difficulties that now arose had occurred because of past under-estimates. He had been laughed at a few years ago for suggesting that space for one hundred students of Physiology would be wanted soon. He had no lecture-room under his control, and no room in which he could give demonstrations to a large class, yet so important did he deem the practical work of the class in Elementary Biology that, if no new accommodation could be given to it, he should feel compelled to close the practical work of his own large class, and simply give lectures in Physiology, and give up his laboratory for the class in Elementary Biology.

### SCIENTIFIC SERIALS

*Journal of the Franklin Institute*, No. 700, April.—Prof. Coleman Sellers, mechanics: introductory. Abstract report of a public lecture exposing various fallacies.—W. Dennis Marks, initial condensation of steam cylinders.—W. E. H. Jobbins, an investigation locating the strongest of the bronzes. The tests were made with Thurston's recording testing-machine, and gave for the two strongest bronzes the following:—Cu57, Zn42, Sn1, and Cu56, Zn42, Sn2.—J. C. Hoadley, a tilting water-meter.—S. Lloyd Wiegand, cast-iron in steam-boilers.—G. M. Bond, standards of length and their subdivision. W. Dennis Marks, economy of compound engines. Final agreement cannot be reached until "a more complete and rational set of experiments are made on the compound engine than now exist."—Dr. P. Frazer, reply to T. D. Rand's paper on the geology of Chester Valley, &c.

No. 701, May.—De Volson Wood, the most economical point of cut-off, a dialogue criticising Prof. Marks' paper.—J. P. Church, alleged remarkable error in the theory of the turbine water-wheel.—N. B. Clark, petroleum as a source of emergency power for war-ships. Proposes to employ furnaces into which petroleum is sprayed along with superheated steam and heated air.—S. L. Wiegand, cast-iron in steam-boilers.—R. Grimshaw, hanging the levers for indication.—R. Grimshaw, doctoring indicator cards.—Pliny Earle Chase, the sun-earth balance. This paper briefly expounds the author's views about harmonic relations in the solar system, and deduces values from them for the earth's mean radius of orbit, and for the weight of the sun.—G. M. Bond, standards of length and their subdivision.

*Annalen der Physik und Chemie*, Band xxi. No. 4, April, 1884.—G. Hansemann, on the diffusion of gases through a porous partition. The author concludes that Stefan's theory is not confirmed, but finds that the gaseous molecules within the pores offer a much greater mutual resistance than Stefan supposed.—G. Kirchhoff, on the theory of the diffusion of gases through a porous partition; a mathematical discussion of Stefan's theory.—Oskar Rother, on capillarity-measurements of salt solutions and their mixtures.—H. C. Vogel, remarks on Dr. O. Fröhlich's paper on the measurement of sun-temperature.—E. Warburg, on the electrolysis of solid glass. He concludes that in this obscure phenomenon the silica is not affected, and that the sodium only is moved electrically through the mass.—Emil Cohn, on the validity of Ohm's law for electrolytes.—A. Oberbeck, on electric oscillations: their magnetising action (part v.). The author concludes that undulatory currents exercise magnetising effects on iron and steel cores entirely as theory would indicate, provided account be taken of the internally induced currents.—L. Grunmach, absolute barometric measurements under a control of the vacuum by means of phenomena of electric illumination. The refusal of induction sparks to pass, or the phosphorescing of the glass surface, are chosen as indices of the exact state of the barometric vacuum.—W. Voigt, on the history of the Nobili-Guebbardt rings.

No. 5, May.—A. Winkelmann, on the diffusion of gases and vapours. This paper discusses the bearing of the formulæ of Meyer on certain changes in the coefficient of diffusion observed by Stefan's method.—L. Boltzmann, on a relation discovered by Bartoli between heat-radiation and the second law of thermodynamics.—

L. Boltzmann, on the quantity of work which can be obtained in chemical combinations. An important discussion of formulæ, and bears on dissociation heat.—A. Overbeck, on electric oscillations, especially on their magnetising effect, and on the propagation of magnetic oscillations. Describes a method of experiment employing an electro-dynamometer, and concludes that the magnetic oscillations propagated along an iron rod decrease in amplitude at points successively distant from the origin of the oscillations, but that the magnitude of the decrement depends only on the quality of the iron, and is independent of its cross-section.—W. Hallwachs, on the electromotive force, the resistance, and the efficiency of secondary batteries. This paper, reprinted from the *Elektrotechnische Zeitschrift*, recounts researches by the author, and gives a summary of others by Tresca and Ayrton and Perry.—J. Stephan, on the calculation of induction-coefficients of wire coils. This paper re-discusses the formulæ used by Maxwell and by Lord Rayleigh for the coefficients of the coils used in the determination of the ohm.—J. Fröhlich, notice on the calculation of the potential of coils. This paper concludes with two convenient approximate formulæ for controlling more elaborate calculations.—S. Wietig and S. Henrichsen, on the magnetism of organic bodies. Gives values for a number of alcohols.—J. Elster and H. Geitel, on the electricity of flame; a reply to J. Kollert.—H. Merzcyng, on Fresnel's measurement of wave-length. The author contends that Fresnel never made his well-known determination with the well-known "Fresnel's mirrors," but by diffraction.—J. L. Andréux, Boyle's law: a lecture-experiment. A thread of mercury is introduced into a long narrow vertical glass tube closed at the top, and hangs inclosing a certain volume of air permanently.—Carl Kirn, on a mercury interrupter with which the oxidation of the mercury is obviated. The contact is broken in a closed vacuum vessel.—G. Krebs, three ozone apparatus.—V. Pierre, apparatus for demonstration of the laws of elasticity of traction; apparatus for demonstration of the constitution of a longitudinal wave; galvanoscope for lecture-demonstration; apparatus for freezing water quickly under the air-pump. There is nothing very new in the first two of these. The galvanoscope is a simple modification of the vertical Bourbouze instrument. The air-pump apparatus is identical with forms often used in this country.

*Bulletins de la Société d'Anthropologie de Paris*, tome vi., série iii., 1883.—The conclusion of M. Ujfalvy's notes on the so-called Kaffir-Giapochs of Hindoo-Koosh, based on his own observations and those of Biddulph, Elphinstone, and other English authorities.—Communications from M. Ten Kate, on the results of his anthropometric observations of the Yaquis Indians of Sonora and Arizona; from M. Errington de la Croix, on the fish-eating modern cave-dwellers of the Island of Socotra; from M. Hamy, on the dental mutilations of the modern Huastecs; and from M. Manouvrier, on the force of the flexible muscles of the fingers in men and women, having reference to the weight of the brain at different anatomical and physiological periods.—On the Japanese races, by M. de Quatrefages.—Reports of the Commissions appointed to examine the Cinghalese Araucarians and Kalmuks who have been brought to the Jardin d'Acclimatation for purposes of ethnographic investigation. The reports on the two latter have been drawn up by M. Deniker, whose intimate acquaintance with the language and homes of the Kalmucks gives special value to his comprehensive exposition of the ethnological and social characteristics of these people.—Recollections of Paul Broca as a student, by M. Eschenauer.—On the "Tzompantli," or sacrificial cranium, exposed in Aztec temples, by M. Hamy.—On the cranial differences observable in men and women, by M. Manouvrier, who considers that while the parietal is less developed in the latter, the occipital is generally larger in women than in men.—On the microscopical characters of the blood in the principal races, by Dr. Maurel, whose investigations do not appear to have demonstrated any very precise ethnic difference in the relations of the red and white corpuscles, unless we may accept as such his observation that the red globules of different races show different degrees of resistance to different artificial reagents.—On the use of iron in Egypt, by M. E. Soldi; and on the use of iron in China, by M. Milloud.—A résumé, by M. G. Hervé, of the various medical and other reports of the dimensions of Cuvier's brain. M. Hervé, basing his remarks on Dr. E. Rousseau's report of the autopsy in which the latter took part, gives the weight as 1830 grm., and the horizontal circumference as 60.45 cm. He denies that Cuvier had ever suffered from any malady capable of affect-

ing the size or condition of the brain.—On muscular anomalies of the diaphragm; suggestions for a planispheric representation of the cerebral convolutions, by M. Duval.—On the disappearance of the more fitting in the struggle for existence, by M. Delaunay. The author endeavours to show that superior as well as inferior species have disappeared, leaving only the intermediate species; the inferior having succumbed to the superior, while the latter have become extinct through sterility.—On the dog of the Tertiary period in Europe, by M. Zalorowski.—On the value of the information to be deduced from ancient Egyptian paintings by the naturalist, ethnographer, and historian, by M. Piétrement.—On a supernumerary nipple with mammary glands in a young woman, by Dr. Testut.—On the origin of right-handedness in man, by Mme. Clémence Royer.—On the symmetrical character in anomalies in man, and on the influence attributable to atavism in such anomalies, by M. Verrier.—On the geographic distribution of the Opatas, Pimas, &c., with an ethnographic chart of the Basin of the Rio Grande de Santiago, by M. E. T. Hamy.

*Bulletin de la Société des Naturalistes de Moscou*, 1883, No. 3.—History of the hypothesis of the cosmical waves proposed for explaining the forms of the comets, by Prof. Bredichin (with two plates), being a discussion of M. Schwedoff's hypothesis on this subject; and on some apparent anomalies in the structure of the tails of the comets, by the same (both in French). Prof. Bredichin arrives at the conclusion that, more than ever, he is right in affirming that the theory of repulsive forces is enabled to explain and to predict by means of calculus, not only the whole of the phenomena afforded by the comets and their leading features, but also the slightest details of their structure.—A reply of Dr. Morawitz to General Radoszkowsky's critics with regard to the Russian species of *Bombus* (in German).—On the *Pecten excisus* and *pyxidatus*; note by M. Ant. de Gregorio (in French).—Monopetal plants of Dr. Radde, being a continuation, in German, of Dr. Fred. von Herder's capital description of these plants.—Materials to the fauna of Russian Hemiptera, by W. Yakovleff; three new Russian species of *Olotarsus* and one *Emblethis tenuillus* from Northern Persia are described (in Russian).—On the beans of *Abrus precatorius* compared with seeds of other Papilionaceae, by Col. Tichomirov (in German), with two plates.—On the remains of *Edestus* and other fishes from the Lower Carboniferous of Moscow, by Prof. H. Trautschold (in German); the new species *Cymatodus reclinatus*, *Pecilotodus undatus*, and the new genus *Eucanthus margaritatus*, are described.—On the chief problem of higher geodesy, by Th. Sloudsky (with a plate); a mathematical discussion (in French) of the best means for determining the figure of the earth.—Letters from A. Regel from Central Asia.

*Atti della R. Accademia dei Lincei*, April 6.—Report on Alfonso di Legge's memoir on the length of the solar diameter, by S. Schiaparelli.—On the compressibility of fluids, and especially of water under temperatures varying from 0° to 99° C., and under pressures of from 1 to 4½ atmospheres, by Stefano Pagliani and Giuseppe Vicentini.—On the symbolic meaning of the Egyptian pyramids, by Dr. Ernesto Schiaparelli.—On the theory and classification of homographies in a linear space to any number of dimensions, by Dr. Corrado Segre.—On the equilibrium of flexible and rigid surfaces, part i., by Vito Volterra.—Remarks on the observations of the solar spots and facules made at the observatory of the Collegio Romano during the first quarter of 1884, by Pietro Tacchini.—On some transformations of ortho-nitroaniline and orthodiammine, by G. Koerner.—On the action of phthalic anhydride on pyrolignite, by G. L. Ciamician and M. Dennstedt.—On the molybdate of didymium, by Alfonso Cossa.—On the geological constitution of the Maritime Alps, by S. Capellini.—On some psychological difficulties which may be explained by the idea of the infinite, by Francesco Bonatelli.—Some fresh experiments with neurine, by Aliprando Moriggia.

*Rendiconti del R. Istituto Lombardo*, May 1.—Biographical notice of Prof. Giovanni Polli, part i., by Prof. Gaetano Strambio.—On a problem in mathematical analysis, by Prof. F. Brioschi.—Note on certain variations in the stem and blossom of *Gagea arvensis*, Schult., by Silvio Calloni.—On the struggle for existence between the *Staphylinus olens*, Müll., and the *Lumbicus agricola*, Hoffm., by the same author.—The Court of Cassation in connection with the question whether women should be admitted to the legal profession, by Prof. E. Vidari.—Meteorological observations made at the Brera Observatory, Milan, during the month of April.

*Rivista Scientifico-Industriale*, April 30.—On certain works required to be carried out in the Island of Ischia, in order, if possible, to prevent the disastrous consequences of future earthquakes, by Prof. Temistocle Zona.—Installation of the electric light in the railway station of Porta Nuova at Turin.—Considerations and suggestions regarding the adoption of earthenware tubes in underground telegraphs, by the engineers R. Fabri and G. A. Romano.—Obituary notice of Quintino Sella, with a list of his scientific writings, by Giuseppe Grattarola.

## SOCIETIES AND ACADEMIES

### LONDON

**Royal Society, May 15.**—"On the Influence of Coal-dust in Colliery Explosions, No. V." By W. Galloway. Communicated by R. H. Scott, F.R.S.

At the beginning of the first paper on this subject, which I had the honour of reading before the Fellows of the Royal Society now somewhat more than eight years ago (*Proc. Roy. Soc.*, vol. xxiv. p. 354), I gave a short account of what appeared to me to be a rational mode of explaining the occurrence of all great explosions in dry and dusty collieries; and since then I have had opportunities of studying several remarkable instances of this class of phenomena, with the result that I am now more than ever satisfied with the correctness of the views which I then expressed. It is true, as some subsequent writers, among whom I may name Sir Frederick Abel, F.R.S., have observed, that coal-dust had been previously recognised as a factor in colliery explosions. I think I may safely claim, however, that no earlier author had gone the length of crediting it with the rôle of principal agent, and relegating fire-damp to a secondary position.

It is also admitted, I believe, by every one familiar with the subject, that my experiments with mixtures of coal-dust and air containing a small proportion of fire-damp were original. Similar experiments were subsequently made by members of the North of England Institute of Mining and Mechanical Engineers, by a committee of the Chesterfield Institute of Engineers, by Prof. Abel on behalf of the Home Office and the Royal Commission on Accidents in Mines, and by others in this country, by MM. Mallard and Le Chatelier for the Commission du Grisou in France, and by others on the Continent, all of which led to the same conclusion, namely, that air containing too small a proportion of fire-damp to render it inflammable at ordinary pressure and temperature becomes so when coal-dust is added to it. Differences of opinion were expressed as to the actual proportion of fire-damp, the comparative fineness of the coal-dust, and the quality of the coal necessary to the attainment of this result, but the general conclusion, in every case, was the one I have stated above.

In my first paper, already referred to, I had said: "If it could be shown therefore, that a mixture of air and coal-dust is inflammable at ordinary pressure and temperature, there could be no difficulty in accounting for the extent and violence of many explosions which have occurred in mines in which no large accumulations of fire-damp were known to exist," and, immediately following these words, I gave what appears to me to be a new hypothesis regarding the mode of occurrence of great colliery explosions.

My reasons for thinking it necessary to show that a mixture of air and coal-dust alone is inflammable were, first, that after some great explosions it was found that the flame had passed through very long galleries, containing presumably nothing but pure air, and of course dry coal-dust in a state of greater or less purity; and secondly, it was impossible to account for certain other explosions, except on the supposition that they had been originated by the firing of a shot in pure air in galleries containing dry coal-dust as in the last case. To have proved that a mixture of air, coal-dust, and fire-damp is inflammable did not appear to me fully to meet the case, and it was for this reason that I made further experiments with the help of a grant made to me by the Lords of Committee of Council on Education at the recommendation of this Society. The results have been described in some of the former papers of this series. In making these experiments, and in drawing certain conclusions from them, all favourable to the hypothesis referred to, I was simply carrying out the details of the work then begun, and nothing more.

In former papers I referred to several great explosions which had come under my own immediate observation. In particular I had made a very careful and complete examination of Peny-graig Colliery after the explosion there in December 1880 (*Proc.*

Roy. Soc., vol. xxxii. p. 454), when I found that the flame had penetrated into every working place in the mine. The plan which accompanies No. III. paper shows that all the working places were ventilated by what was, practically, a single current of air. It was, therefore, open to those who attribute every great explosion to the occurrence of a sudden outburst of fire-damp, and, as the annals of mining show, they constituted a very large majority before the appearance of my first paper on coal-dust, to say that this explosion was due to the same cause. For this reason I have paid particular attention to the phenomena due to the explosion which occurred at Dinas Colliery on January 13, 1879. I do not propose to enter into the minute details of this case, as I should to a large extent simply be repeating what I stated about Penygraig explosion, but will confine myself to those which are necessary or new. I had frequently inspected the workings before the explosion, and I have done so at intervals of one month or less since then, so that I have been intimately acquainted with all the conditions of the mine for many years. I know also that no sudden outburst of fire-damp has ever been known to take place in it. The workings were naturally very dry, the temperature ranging from 75° to 82° F., and the floor was covered with coal-dust. Shot firing was carried on by night when the explosion happened. The damage done by the explosion was very great, the workings being wrecked to such an extent as to lead to their temporary abandonment. They were reopened after a large expenditure of time and labour, and it was only towards the end of last year that I was able to inspect one of the districts of working places, and early in the present year that I could get into the other. With the exception of some burnt hay or dried grass which I found in one of the return air-ways, I saw no traces of burning nor deposits of coked coal-dust in any of the main roadways, but I found well-marked deposits of coked coal dust in all the working places in both districts of workings as far as I was able to penetrate. The plan shows that the current of fresh air which came down the downcast shaft was split up into three separate currents. The two districts were thus ventilated quite independently of each other, and it was therefore impossible for any outburst of fire-damp which might take place in one of them to affect the quality of the air in the other.

We are thus compelled to fall back upon some other mode of explanation in this case, and I now submit that in the present, and in my previous papers, I have brought forward sufficient evidence to show that the coal-dust hypothesis is the only tenable one. If it be admitted, however, that this hypothesis is applicable to Dinas explosion, the conclusion is inevitable that, *ceteris paribus*, it is equally applicable to every case of the same kind that has ever occurred.

**Zoological Society, June 3.**—Prof. A. Newton, F.R.S., vice-president, in the chair.—A letter was read from Mr. Albert A. C. Le Souëf, C.M.Z.S., of the Zoological Gardens, Melbourne, giving an account of the unusual occurrence of two young ones being produced from one egg laid by a black-necked swan. The writer described the appearance of these cygnets, which were much smaller than a companion bird of the same age.—Mr. F. E. Beddard read a paper upon the visceral anatomy of *Hapalemur griseus*, and called attention to the various points of difference between this species and *Hapalemur sinus*.—Mr. A. D. Bartlett read a paper on some singular hybrids of bovine animals bred in the Society's Gardens.—Mr. G. E. Dobson, F.R.S., read a paper on the unimportance of the presence or absence of the hallux as a generic character in Mammalia, as evidenced by the gradual disappearance of this digit within the limits of a single genus (*Erinaceus*).—A communication was read from Mr. H. W. Bates, containing a list of the Coleoptera of the families Carabidæ and Scarabæidæ collected by the late Mr. W. A. Forbes on the Lower Niger. Of these three appeared to be previously undescribed.—Dr. Carl Lumholtz read a paper containing notes upon some mammals which he had recently discovered in Queensland.

**Anthropological Institute, May 13.**—Prof. Flower, F.R.S., president, in the chair.—Dr. Maxwell T. Masters exhibited a series of agricultural implements brought by Mr. Livesay from the Naga Hills, at the north-east corner of Assam. The tools were chiefly such as are used for rice culture on the irrigated slopes of the hills, and consisted of rakes made of bamboo and wood, a hoe and iron knife with wooden sheath and cord for suspension.—Dr. J. Stephens sent a drawing of a large pointed palæolithic implement recently found near Reading, length 9½ inches, weight 2 lbs. 3¼ oz.—Mr. W. G. Smith exhibited two

palæolithic implements recently found in North London. One was made of quartzite, and is the first example of this material met with in the London gravels; the other was a white implement from the "trail and warp." He also exhibited two white porcellaneous palæolithic flakes replaced on to their original blocks; the four pieces were found by him in North London, wide distances apart, at different times during the last six years.—Mr. Smith also exhibited a large axe from New Guinea with a keen blade of siliceous schist or banded chert, 9½ inches long, and weighing over 2½ lbs. The axe was sent home by a sailor, and Mr. Smith purchased it of a person who was using it in North London for chopping up firewood.—A paper on the ethnology of the Andaman Islands, by Mr. E. H. Man was read.—Prof. Flower read some additional observations on the osteology of the natives of the Andaman Islands. Since reading a paper before the Institute on the same subject in 1879, the author had had the opportunity of examining ten additional skeletons, two of which are in the Museum of the University of Oxford, and eight in the Barnard Davis Collection now in the Museum of the Royal College of Surgeons. Five are males and five females, and all are adult. The measurements of these specimens have thoroughly established the fact that the twelve skulls of each sex previously examined furnished a very fair average of the characters of the race.

## CAMBRIDGE

**Philosophical Society, April 28.**—Mr. Glaisher, president, in the chair.—The following communications were made to the Society:—By Mr. R. T. Glazebrook, on the electro-magnetic theory of light.—By Mr. A. H. Leahy, on the pulsation of spheres in an elastic medium. The problem of two pulsating spheres in an incompressible fluid has been discussed by several writers. The author considers the analogous problem in the case in which the medium surrounding the spheres has the properties of an elastic solid. He finds that the most important term in the expression of the law of force between the two spheres varies inversely as the square of the distance between them. This force will be an attraction if the spheres be in unlike phases, a repulsion if they be in like phases at any instant. The next term in the expression varies inversely as the cube of the distance between the two spheres, and is always a repulsion.

## EDINBURGH

**Royal Society, June 2.**—Sheriff Forbes Irvine in the chair.—Prof. Tait communicated a paper by the Rev. T. P. Kirkman on the enumeration, description, and construction of knots. The paper described the application of a particular set of the polyhedra investigated by the author to the investigation of the subject.—Prof. Tait then read the second part of a former paper of his own on knots. He first considered the modification required to be made on Mr. Kirkman's diagrams so that they might represent actual knots. He also took up the question of the identity of some of the figures with the view of determining the actual number of different knots having a given number of crossings. Finally he recurred to the problem of knottedness, showing how it was to be determined in any case upon the consideration that *locking* may occur with two strings, and even with one, as well as with three.—Mr. John Aitken read a second note on the recent sunsets, showing how all the phenomena observed received a satisfactory explanation on the hypothesis that they resulted from the presence of abnormal quantities of dust particles in the air. He pointed out that the facts considered adverse to this conclusion really furnished additional proof.—Mr. Aitken then read a paper on thermometer screens, which gave rise to an animated discussion.

## DUBLIN

**Royal Society, May 19.**—Section of Physical and Experimental Science.—G. F. Fitzgerald, F.R.S., in the chair.—On the pitch-curves of cogged wheels, by A. H. Curtis, LL.D. The author showed that a pitch-curve *A*, of any form, its axis *a*, and also the axis *b* of the corresponding pitch-curve *B*, being given, the curve *B* must be such that, if it roll without sliding on *A* (the initial point of contact *c* being of points which in working would come together), carrying *b* with it, the roulette thus described by *b* will be a circle having *a* for centre; hence he deduced the known result that the point of contact of the pitch-curves must be situated on *ab*—for the tangent at *b* to the roulette must be perpendicular to *bc*, while, as this roulette is a circle, this tangent must also be perpendicular to *ab*; he proved that, if  $\rho = \phi(r)$  be the equation of *A*,  $\rho' = \frac{r}{\kappa - r} \phi(\kappa - r)$ ,

where  $\kappa = \text{length } a b$ , will be the equation of  $B$ . He mentioned also that Prof. Willis had proved that all working teeth on corresponding pitch-curves are roulettes of the same curve and generated by the same point, and also that, with circular pitch-curves, teeth which were involutes of circles concentric respectively with the corresponding pitch-curves, and having the same centre of similitude with them, would work correctly, and stated that these theorems taken together had suggested to him the question, What curve rolling on a circle will generate, and by what point, the involute of a concentric circle? This curve he proved to be an equilateral spiral whose pole is the generating point.—On the alleged effect of magnetism on the human body, by Prof. W. F. Barrett. In a recent address Sir W. Thomson drew attention to the "marvellous fact" that a powerful magnetic field appeared to exert no action on the human body, and stated his conviction that, "if there is not a distinct magnetic sense, it is a very great wonder that there is not." The object of the present paper was to describe certain facts which had come under the author's observation, and which pointed in the direction of a distinct sensory and therapeutic effect produced by a powerful electro-magnet upon certain individuals. A careful examination of upwards of 100 persons had led to the discovery of three individuals who could instantly detect by their sensations when the current was put on or taken off a large electro-magnet, between the poles of which their heads had been placed. In an absolutely darkened room a singular luminous glare was also seen over the magnetic poles by these three observers. Every care was taken to avoid collusion or chance coincidence, and the observers had no means of knowing by any other means when the current was put "on" or "off." If a distinct magnetic sense exist, as these experiments seem to suggest, it is doubtless rare and fitful, depending possibly on the state of the percipient's health. The author then described experiments that had been made by Charcot in Paris, Dr. W. H. Stone at St. Thomas's Hospital, London, and Prof. Dreschfeld at the Manchester Infirmary, to ascertain the pathological effect of a powerful magnet. The two former authorities had noticed the transference of sensation produced by magnetism in patients suffering from hysteria or hemianæsthesia, under conditions which appeared to preclude the possibility of imagination coming into play. Dr. Dreschfeld describes three cases which came under his own observation where anæsthesia was cured by a large electro-magnet. In one case, particulars of which were published in the *British Medical Journal*, every care was taken to eliminate causes other than the specific effect of magnetism, and there seemed no doubt that the patient's complete restoration to health was due to the latter cause alone. In conclusion Prof. Barrett remarked that should the therapeutic value of magnetism in certain specific disorders be established, it would obviously give no support to certain magnetic appliances which are sold as nostrums for all diseases, and of the specific value of which he was not aware that there exists the smallest medical evidence.—On the substitution of sodium bichromate for the potassium salt in bichromate batteries, by Prof. W. F. Barrett. Prof. Barrett stated that a week or two ago Mr. Moss placed in his hands a specimen of bichromate of soda, and asked him to try whether it would efficiently replace the potash salt which is invariably employed in bichromate cells. The result of his examination showed that there was no appreciable difference between the electromotive force, the internal resistance, and the constancy of the two cells, charged with equal weights of the soda and of the potash salt respectively.—Reply to the criticisms of M. Lœwy, by Howard Grubb, F.R.S. (see NATURE for May 29, p. 100).

Section of Natural Science.—V. Ball, F.R.S., in the chair.—On the origin of freshwater faunæ, a study in evolution, by Prof. W. J. Sollas, D.Sc., F.G.S. The poverty of freshwater faunæ as compared with marine is commonly attributed to a supposed inadaptability on the part of marine organisms to existence in fresh water. That this explanation is inadequate is shown by the existence of freshwater jelly-fish such as *Limnocoelium*, and still more directly by the experiments of Beudant, who succeeded in accustoming several kinds of marine mollusca to a freshwater habitat. The view of Von Martens that the severity of a freshwater climate is prohibitive of the existence of most marine forms in rivers is insufficient, and a more thoroughgoing explanation is necessary. This is to be found in a study of the means by which the distribution of marine animals is secured. In the case of stationary forms free-swimming embryos are distributed over wide areas by currents, and they can never pass from the sea into rivers, in which the current is always directed seawards. Nor,

probably, could an attached form once introduced into a river permanently establish itself so long as its propagation took place exclusively through free-swimming larvae, for these would gradually be borne out to sea. Hence, freshwater animals should not, as a rule, pass through a free larval stage of existence, nor, as a matter of fact, do they. In Hydra, freshwater sponges, and Polyzoa, the young usually emerge from a horny cyst in the complete state. In the Unionidæ, the glochidium stage provides for distribution without involving a seaward journey. The young of freshwater mollusks do not enter upon a free existence till they are similar to their parents, and Paludina is viviparous. The suppression of a free-swimming larval stage not only occurs in freshwater but in many marine invertebrates. This is connected with the fact that the larval stage is in a position of disadvantage as compared with the adult. Hence there is an advantage to the organism if the larval stage can be passed over in a state of seclusion. From this various other modifications follow; development in seclusion involves a supply of accessible food, hence the appearance of yolk and other kinds of nourishment furnished by the parent to the imprisoned embryo. Again, the secluded larva being spared the drudgery of working for its own existence, and supplied with nutriment in a form that puts the least tax on its digestive powers, a larger balance of energy remains available for metamorphic changes. Thus arise the phenomena of accelerated and abbreviated development. Further, the shortening of the larval life probably leads to the lengthening of the adult life, and shifts the chances of variation and selection forward into the adult stage. Thus animals which hatch out in a complete state will most probably suffer modifications of that state, and not of previous ones, except very indirectly. Here we discover a direct tendency towards a mode of development which explains the "arborescent" character of our zoological classifications, i.e. the tendency of the tree of life is now to produce leaves rather than new branches. In the case of freshwater fauna very direct reasons have existed for the suppression of the free larval stage. In this connection may be noticed the richness in species and the poverty in genera of the freshwater mollusca. In discussing the origin of freshwater faunæ there are three hypotheses from which we have to select: (1) that marine forms have migrated into rivers; (2) that they have migrated into marshes and thence into rivers; and (3) that marine areas have been converted into freshwater ones. The last course has been the most usual, especially in the case of non-locomotive forms. Hence the origin of freshwater invertebrates is connected with the great movements which have affected the earth's crust. The earliest well-known lacustrine areas are those of the Old Red Sandstone, in one of which we meet with the earliest known freshwater mollusk, *Audontia jubesi* (Forbes). The lakes of the Permo-Triassic period contributed additions to the freshwater fauna of the globe. The *Neritidæ* and *Cerithiidae* are probably post-Palæozoic families, and, as the *Neritina* and *Melaniidæ* are so closely connected with them, they may be regarded as their collateral or direct descendants, and thus may have originated in Triassic lakes, but not earlier. Other genera probably arose at the same time; and the occurrence in Cretaceous deposits of *Unio*, *Physa*, *Valvata*, and *Lymnaea* in the Nearctic, Palearctic, and Oriental regions, suggests a high antiquity for these genera; and they may have existed in Palæozoic times. The lakes of the Tertiary period furnished probably further contributions to our freshwater fauna, such as *Lithoglyphus* and *Dreissena*. Thus, existing freshwater genera are probably descended from marine forms which became metamorphosed in the waters of the Devonian, Triassic, and Tertiary lakes. In the lakes of Central Africa the Tertiary freshwater fauna still survives, nearly all of the genera from Lake Tanganyika being referable to genera already in existence in Mesozoic and Tertiary times. The lakes of the Northern Hemisphere received on subsiding beneath the glacial sea such Arctic forms as *Mysis relicta* and *Pontoporeia affinis*, but most of their existing inhabitants have re-entered them since their emergence from the sea.

## PARIS

Academy of Sciences, May 26.—M. Rolland, president, in the chair.—Observations of the small planets made with the great meridian instrument of the Paris Observatory during the first three months of the year 1884; communicated by M. Mouchez. The observations of January 11, February 11 and 12, March 14 and 15, were made by M. P. Puiseux, all the rest by M. H. Renan.—Remarks on the sense of sight in its relations with different colours placed in juxtaposition, by M. Chevreul.—Fresh experiments made with a view to determine the locality

and mode of formation of urea in the animal system, by MM. Gréhan and Quinquaud. From these experiments, which consisted mainly in making a quantitative analysis of the urea in the blood flowing to and from a given organ, the authors infer that the abdominal viscera are the seat of a continuous formation of urea.—Experimental studies on the anæsthetic properties of the chloruretted derivatives of formine, by MM. J. Regnaud and Villejean.—On the theory of quaternions: a demonstration of Sylvester's proposition that the theory of quaternions is identical with the theory of binary matrices, by M. Ed. Weyr.—On the circulation of the liquid mass of the sun, by M. P. Lamey. Assuming as a postulate the total fluidity of the solar mass, the author endeavours to show that, in virtue of the continuous cooling of the surface layer, the whole volume must be in constant circulation, and that the circuit thence resulting may be represented by a simple geometrical figure, which has several points at a tangent with the surface of the solar globe.—Note on the electric conductivity of the liquid and solid anhydrous salts, by M. Fousereau.—On the gaseous tensions of liquid amalgams, by M. Isambert.—Thermic studies of the alkaline fluosilicates; three methods of obtaining fluosilicates of potassa, soda, and lithia, by M. Ch. Truchot.—Fresh researches on bromuretted carbolic acids—their melting heat, specific heat, and heat of neutralisation, by M. E. Werner.—On some reactions of albumen, by M. E. Grimaux.—Analytical study of the chief mineral fertilisers contained in arable lands, by M. G. Lechartier.—Note on the alluvial and lacustrine formations of the basin of the Shott Melrirk, Eastern Sahara, by M. G. Rolland.—On the transformations of a parasitic Peridinium (*Gymnodinium pulvisculus*, Bergh.), by M. G. Pouchet.—A contribution to the study of the virulent principle in puerperal septicæmia, by M. S. Arloing.—On a new method of transfusion of blood previously subjected to the action of peptone, by M. Afanassiew.—On the exaggerated statements regarding the intensity of atmospheric evaporation during the spring equinox, with comparative readings of the evaporimeter during the years 1873-1884, by M. L. Descroix.

June 2.—M. Rolland, president, in the chair.—Arithmetical commentary on the theorem discussed by Gauss in his "Disquisitiones," § 357, by M. de Jonquières.—Note on the theory of the winding-gear employed in extracting ores from deep mines, by M. Haton de la Goupillière.—On the mean reciprocal distances of the planets in the primordial state of the solar system; letter addressed to M. Hermite by M. Hugo Gylden. The respective mean distances, supposed to be far less absolutely than at present, are determined as under:—Mercury, 0.443; Venus, 0.519; Earth, 0.562; Mars, 0.625; Jupiter, 0.850; Saturn, 0.988; Uranus, 1.177; Neptune, 1.322.—Explanation of a method of determining the temperature of the parts of the sun below the photosphere, by M. Hirn.—Fermentation of saccharine juices; experimental researches on the influence of the pneumatic treatment by a current of purified air at the ordinary temperature, or heated to 65° C., by M. P. Calliburcés.—Suggestions for constructing a mercurial galvanometer (hydrostatic galvanometer), by M. J. Carpentier. The paper refers to experiments made as early as January 1881, and are here reproduced as having preceded the apparatus of a similar character submitted to the Academy by M. Lippmann on May 19, 1884.—On the reaction of fused gold and silver in the vapour of phosphorus, by MM. P. Hautefeuille and A. Perrey.—On the action of the sulphuret of mercury on the sulphuret of potassium, by M. A. Ditte.—Note on the combination of chlorides of gold with chlorides of phosphorus by M. L. Lindet.—On the anatomy and nervous system of the Australasian Gasteropod, *Parmophorus australis* (*Scutus*), by M. Boutan.—Contributions to the natural history of the Haliotides, by M. H. Wegmann. The author, who had previously submitted a study of their nervous system, here completes the subject by a full anatomical description of these animals.—Account of the freshwater *Lithoderma fontanum*, Nob., a species of brown Alga (Melanophyceæ) from Montpellier, by M. Ch. Flahault.—On a new genus of vegetable fossils discovered by M. Fayol in the coal-mines of Commentry, by MM. B. Renault and K. Zeiller. The authors, who, from their discoverer, propose the generic name of *Fayolia* for these plants, give full-size illustrations of two species, *F. dentata* and *F. grandis*.—On some new types of rocks from the volcanic Mount Dore (Clermont), with a description of the successive formations in that district, by M. A. Michel Lévy.—Hydrology of the Ohio Basin, in connection with the recent disastrous inundations in that region, with map, by MM. Fr. Mahan and G. Lemoine.—

On the pseudo-meningitis (pseudo-meningitis otopieisis) observed in young deaf-and-dumb subjects, by M. Boucheron.

VIENNA

Imperial Academy of Sciences, May 8.—R. Latzel, on the Myriopoda of the Austro-Hungarian Empire (containing the description of Symphylezæ, Ponropoda, Diplopoda).—K. Deschmann, on the tumuli of Rovisce in the parish of Bründl in Lower Carniola.—L. Boltzmann, on the possibility of basing a kinetic theory of gases on attractive forces alone.—P. Czermak, on the value of some integrals of Maxwell's theory of gases based on a certain law of forces.—F. Zehden, method for calculating a true moon distance by an observed one.—E. Zuckerkandl, on the apparatus of circulation in the nasal mucous membrane.—F. Rimmer, experiments on nutations and directions of growth of seed-plants.—T. Habermann, on diethylalizerin-ether.—F. Fiala, on some mixed ethers of hydroquinone.

May 15.—A. Rollett, contribution to a knowledge of the process of contraction in striated muscles.—F. Kolacek, on a method for determining the electric conductivity of liquids.—A. G. Nathoritz, remarks on Herr von Ettingshausen's essay, "On the Tertiary Flora of Japan."—C. Langer, on the origin of the internal jugular vein.—D. Lersch, notes on comets.—E. von Hærdtl, contributions to Assyrian chronology.

CONTENTS

PAGE

British Mites. By Sir John Lubbock, M.P., F.R.S.	141
Injurious Insects . . . . .	142
Our Book Shelf:—	
Williamson's "Elementary Treatise on the Integral Calculus" . . . . .	143
Smith's "Elementary Treatise on Solid Geometry" . . . . .	143
Roberts's "Collection of Examples on the Analytic Geometry of Plane Conics" . . . . .	143
Collins's "Mineralogy" . . . . .	143
Martin and Moale's "Handbook of Vertebrate Dissection" . . . . .	143
Parker's "Course of Instruction in Zootomy" . . . . .	144
Hopkinson, Shoolbred, and Day's "Dynamic Electricity"; and Thompson's "Dynamo-Electric Machinery" . . . . .	144
Swinton's "Principles and Practice of Electric Lighting" . . . . .	144
Letters to the Editor:—	
The Rings of Saturn.—A. Ainslie Common . . . . .	144
An Experiment in Thought-Transference.—Prof. Oliver J. Lodge . . . . .	145
The Earthquake.—R. Meldola; Col. H. H. Godwin-Austen, F.R.S.; Mrs. K. M. Bernard . . . . .	145
Kohlrausch's Meter-Bridge.—Dr. W. H. Stone . . . . .	145
Simple Methods of Measuring the Transpiration of Plants.—Rev. George Henslow . . . . .	146
Worm-eating Larva.—W. E. Darwin . . . . .	146
Cultivation of Salmon Rivers.—Mark Heron . . . . .	146
A Rare British Holothurian. By Dr. F. Jeffrey Bell . . . . .	146
Visitation of the Royal Observatory . . . . .	147
The North Cape Whale. By Prof. G. A. Gulberg . . . . .	148
Measuring Earthquakes, I. By Prof. J. A. Ewing. ( <i>Illustrated</i> ) . . . . .	149
Notes . . . . .	152
Our Astronomical Column:—	
The Observatory of Paris . . . . .	154
The Great Comet of 1882 . . . . .	154
Geological Notes:—	
Canadian Coals and Lignites . . . . .	154
Belgian Erratics . . . . .	154
Position of the Callovian Rocks . . . . .	154
The Glacial Boundary in Ohio . . . . .	155
Hypersthene-Andesite and Triclinic Pyroxene in Augitic Rocks . . . . .	155
Krakatoa and the Sun-Glows . . . . .	155
The Fixed Stars, II. By David Gill, LL.D., F.R.S. ( <i>Illustrated</i> ) . . . . .	156
University and Educational Intelligence . . . . .	159
Scientific Serials . . . . .	160
Societies and Academies . . . . .	161

THURSDAY, JUNE 19, 1884

## THE LONDON WATER-SUPPLY

*The London Water-Supply; its Past, Present, and Future.*

By G. Phillips Bevan, F.S.S. With a Map showing the Districts of the Water Companies. (London: E. Stanford, 1884.)

THE London water-supply is so important a question, and at the same time one upon which there prevails so much misapprehension, that the appearance of an impartial, candid, and, in the main, accurate treatise like the one before us must be judged seasonable. A full discussion, indeed, of so many-sided and complicated a subject cannot be expected within the compass of 112 pages. Nor is there, perhaps, any man living who is qualified to give an authoritative deliverance on all the considerations involved,—on the one hand, medical, chemical, and engineering, and on the other hand, financial, legal, ethical, and municipal, if not actually political. These two main branches of the inquiry should be kept substantially distinct. For it is at least conceivable that a water-supply might be found irreproachable in quality and ample in quantity, and yet might be furnished on terms so iniquitous as to call for a sweeping reform. Again, a contaminated water might be dealt out in a manner which at least involved no injustice or oppression.

As a matter of course, we shall discuss Mr. Bevan's pamphlet mainly from the sanitary point of view, though we admit that as a whole it well merits the careful study of the ratepayers of the metropolis.

Our author begins with an account of the ancient supply down to the reign of Charles II. This chapter, like history generally, is mainly a record of errors and oversights. It would seem that whilst as individuals we recommend forethought and prudence, yet as a community we very literally "take no thought for the morrow," and thus drift into positions from which we can escape, if at all, only at great cost.

The second chapter deals with the modern supply. It appears that as far back as 1821-28 there was general dissatisfaction both with "the high-handed and arbitrary character of the rates" and with the quality of the water furnished. One company, we learn, took in its supply from the Thames at the mouth of a main sewer, and served out this liquid to its customers without any process of purification. As a specimen of neglect on the part of Government, we may mention that a Royal Commission was appointed to examine the water-supply as far back as 1828. A Select Committee of the House of Commons was still "considering" the report of the Commissioners just six years afterwards, while the Select Committee of the House of Lords took another six years over the matter, and did not consider it until 1840.

Even in those early days attention was drawn to "the filthy and polluted state of the cisterns and butts into which water is received." This nuisance is a necessary consequence of the intermittent system of water-supply. In addition comes the fact that the cistern is generally placed where it is fully exposed to the sun in summer and to the frost in winter.

VOL. XXX.—No. 76

We find next a history of the cholera epidemics, their bearing on the water-supply question, and the evidence which they yielded as to the influence of sewage pollution. This influence, as worked out by Mr. Simon, is most striking. Among the population of 166,906 persons supplied with a fairly good water by the Lambeth Company in 1854, the deaths from cholera were at the rate of 37 to 10,000 living. Among the 268,171 persons supplied by the Southwark and Vauxhall Company with a polluted water, the death-rate from cholera was 130 per 10,000. Now, as the two companies at that time competed with each other, their "mains branching within the same area, often running parallel in the same streets," this case was a truly crucial instance. The observations thus made proved to be of no small value. The water companies introduced a variety of improvements. The intakes were removed further from sources of pollution, and more efficient arrangements for filtration were adopted. In 1856 Professors Hofmann and Blyth were able to announce that the organic matter in the water supplied was nearly one-half less than it had been in 1851. It is to be regretted, however, that the lesson was over-learned, and that fanciful and exaggerated notions concerning "contamination" became fashionable. The dogma—for it is not a demonstrated truth—was put forward that all nitrates present in subsoils and rocks result from the decomposition of animal matter. Hence the presence in a water of such salts was deemed a proof that sewage or kindred matters had at some time gained access to the source in question. To this subject, however, we shall have to return below.

An important step has been the closing of the public wells and pumps in and near London. The water of these wells was not merely found to be grossly polluted, but positive proof was obtained that those who drank it suffered exceptionally from cholera. The popularity of these wells may strike us as remarkable. But we must remember that such water cost the consumer nothing. In addition, as Mr. Bevan points out, "the cisterns of the neighbouring houses were generally foul and the water heated, while the well water came up fresh, cool, and sparkling, from the quantity of carbonic acid contained in it."

Mention is made of the establishment in 1868 of a system of inspection of the water supplied to the metropolis. It is not, however, generally known that all the reports issued prior to the investigations undertaken by Mr. Crookes and by Drs. Odling and Meymott Tidy have been based on the analysis of "a single sample of each company's water, taken on one day only in the course of the month." It is plain that such an examination is not alone "rather of a perfunctory nature," as Mr. Bevan says was the case previous to 1865, but positively misleading. We must agree with Messrs. Crookes, Odling, and Tidy that it is "quite impossible to judge fairly the purity or otherwise of a month's supply by an odd sample taken at random in the manner adopted." Hence we are by no means satisfied that the monthly reports issued by Colonel Sir Francis Bolton are of the "immense practical value" which Mr. Bevan seems to believe.

The third chapter is devoted to the existing water companies—their supplies or feeders, reservoirs, and filterbeds; the statistics of the districts supplied, and, above all, their scale of charges. Into these questions, important

as they are, we cannot here enter. We notice merely Mr. Bevan's argument against the compulsory sale of water by meter. He contends that it would "simply result in the greatly decreased use of the water, very much to the detriment of cleanliness and godliness." Surely this hypothetical objection can count for little when weighed against the illogical rating system, which makes a man liable to pay more for his water-supply because his rent and taxes have been raised, *i.e.* because he is poorer! Mr. Bevan, in concluding this chapter, expresses the hope that "either from the operation of purchase, control, or competition, the water question will soon reach a fair and equitable level to both consumer and supplier."

We come now to the main question: Is the existing water-supply satisfactory in quality? and, granting this point, is it not self-evident that, as Mr. Bevan puts it, "it is impossible that the enormous drain upon the Thames can be kept up without its showing signs of exhaustion." The existing supply must, therefore, be supplemented by some new source. Now, in spite of the alarmist speeches, papers, and letters, some of them by authorities of eminence, we still hold that the waters of the Thames and the Lea are not contaminated in such a manner as to render their use inadmissible. It is perfectly true that the country along the Thames and its tributaries above the points where the water companies take in their supplies is inhabited by a large population, whose drainage, not always purified, finds its way ultimately into the river. Now, the late Royal Rivers Pollution Commission, upon what to us seems very scanty evidence, committed itself to the dogma that, "if a river was once polluted with sewage matter, the water of that river was for ever unfit for dietetic purposes, and no practical distance of flow would render such a river safe."

On the other hand, the Royal Commission on Water-Supply (1869) declare in their report (§ 180) that "the organic compounds dissolved in water appear to be of very unstable constitution and to be very easily decomposed, the great agent in their decomposition being oxygen, and the process being considerably hastened by the motion of the water. This purifying process is not a mere theoretical speculation; we have abundant practical evidence of its real action on the Thames and other rivers."

Further (§ 193), "These analyses of Thames waters made for the Commission (by Drs. Frankland and Odling jointly) are sufficient to show, not only the absence of any increase of objectionable matter in the river from Lechlade to Hampton, but that the variations in quality which commence at Lechlade, after showing several temporary changes in many parts of the river's course, fall at Hampton in general to a point as low as at Lechlade (110 miles up stream), and in one respect, *viz.*, the organic nitrogen, to a point even lower."

One more extract may be permitted (§ 214): "Having carefully considered all the information we have been able to collect, we see no evidence to lead us to believe that the water now supplied by the companies is not generally good and wholesome."

It may be urged that these conclusions being based upon evidence obtained in 1869 may not be strictly applicable at the present day. To this the reply is very simple: the results obtained by Messrs. Crookes, Odling, and Tidy in 1881 and subsequently "are in complete agreement with

those of the Commission on Water-Supply." Further, certain improvements have since been effected which must lessen the contamination of the Thames above Hampton. We need merely refer in passing to the corroboration which the views of the Water Supply Commission have received from the recent analyses and observations of Dr. F. Hulwa on the Oder at Breslau, of Prof. Leeds on the Brandywine and Passiac Rivers at Paterson, Jersey City, and Newark, or of Delalande on the Vesle at Rheims. All these chemists agree that, since rivers have a self-purifying power, this power, if not interfered with by the continuous introduction of pollution along their course, restores them, not indeed to absolute purity, but to a condition fit for all practical purposes. The public are apt to forget that pure water is a mere abstraction, like the lines and points of the mathematician. It has no existence in nature, and were it procurable might prove ill-adapted for domestic and dietetic purposes.

Taking all that has been said into consideration, we think that all judicious men will be slow to abandon the present supplies of water. There is one especial reason against such a change, which, though not of a sanitary nature, cannot in these days be left out of sight. In such a vital matter London must not make itself dependent upon any one source. Let us for a moment suppose that the alarmist succeeds in prevailing upon us to abandon the Thames, the Lea, and the other gathering-grounds in the neighbourhood of London, and that our entire supply is conveyed from Wales or Cumberland by a gigantic aqueduct. Would it be possible to guard all points of such a line, so as to be safe against the outrages which seem now the order of the day? A quantity of nitroglycerine, which a man might carry in a carpet-bag without exciting suspicion, would suffice, if skilfully applied, to cause a breach in some part of the structure. And then? How long it might take to make good such a rupture we cannot estimate. In a railway accident, materials, tools, and workmen can be run along the line to the spot where they are required. An aqueduct would present no such facilities. It may be said that a reservoir might be constructed at the London end of the line of sufficient size to tide us over such a possible calamity, but the size and strength of such a store-tank would have to be enormous, and this in itself would present another element of danger.

But whilst it might thus be perilous to supersede the present supply, an addition to our resources will ultimately become needful. Of course, with Mr. Bevan, we can only hope that the additional supply will be the best procurable. But the author here reminds us that, "however pure may be the water at the outset, no power on earth can prevent careless, wilful, or accidental pollution in some part of its long course." In fact, experience tells us that no water-course, exposed to the air for any distance, will contain less than about 0.06 to 0.07 parts of "albuminoid ammonia" per million. The excellent waters of Manchester and Glasgow—the former collected on the barren and unpeopled moorlands of North Derbyshire, and the latter drawn from Loch Katrine—contain this proportion, and the New River water shows no more! It is, therefore, quite an open question what we should gain by going so far afield.

There is another very grave consideration: the soft

waters with which not a few towns in the North of England are supplied, act upon the leaden service-pipes to such an extent as to become dangerous. It may even be questioned whether an occasional epidemic of fever is not a smaller evil than the continued occurrence of lead-poisoning. The use of iron service-pipes, or of lead thickly lined with tin, is troublesome and expensive. Perhaps sooner or later some unobjectionable material may be found to take the place of lead in the manufacture of water-piping.

A well-known authority on water analysis reminds us that waters from the mountains of Wales, Cumberland, &c., may possibly hold lead and copper in solution, and one has been found to contain appreciable quantities of arsenic. Great care would therefore be necessary in the selection of a supply from such districts.

The hardness of the New River water, of that furnished by the Kent Company, and indeed of the London water-supply in general, has often been complained of, and the softness of the northern waters has been urged in their favour. It is, however, by no means certain that from a sanitary point of view a soft water deserves the preference. Many medical authorities contend that a water of moderate hardness is preferable, for dietetic consumption, to such waters as are supplied to Huddersfield, Leeds, Manchester, &c. It is urged, not without a show of probability, that a supply of calcareous salts in drinking-water is especially advantageous in the formation of the bones of young children. Dr. C. Cameron of Dublin, however, maintains that there has been an improvement in the public health of Dublin since the soft water of the Vartny was substituted for the hard water with which that city was formerly supplied. Further inquiry, therefore, is necessary in this direction. It seems to us, however, that there is hardness and hardness. The hardness of water may be due to lime salts or to magnesian compounds. For the latter there is comparatively little need in the human system, and their regular ingestion is found unfavourable to health. But to condemn any water as prejudicial merely on the ground of hardness seems to us rash in the extreme, in view of the high standard of health existing in districts where hard waters only are available.

It has been proposed to increase the London supply by means of a system of artesian wells. Unfortunately, though a single such well may yield a large and continuous supply of water, this quantity cannot be multiplied by sinking similar wells in the neighbourhood, as has been found in the case of the celebrated well of Grenelle. Among the many schemes enumerated by Mr. Bevan, there is one prominent in its singularity. Shafts were to be sunk down to the chalk on each side of the Thames every quarter of a mile. Each such shaft was to have a canal communication with the river between high and low water mark, through which these shafts were to be filled with water. At some distance from each descending shaft another was to be sunk, into which the filtered water would flow as in an inverted siphon, until it rose to the level of the river. The water of deep wells is in general remarkable for its freedom from organic pollution. But this purity probably depends on the slowness of the filtration by which they are supplied.

Our author, after giving the details of a great number of projects, comes to no decided conclusion. He remarks

that one of them will ultimately be adopted for the very good reason that a change of some kind will eventually be necessary. But he judiciously adds, "It need not be looked upon as in any way superseding the arrangements of the present supply."

### FLOWERS AND THEIR PEDIGREES

*Flowers and their Pedigrees.* By Grant Allen. (London: Longmans, Green, and Co., 1883.)

THIS book consists of eight short essays on the evolution and distribution of plants which originally appeared as articles in several of the London magazines, supplemented with an introductory chapter. Two of these essays treat of the reasons for the presence of certain plants in our insular flora, as illustrated by the Hairy Spurge (*Euphorbia pilosa*, L.) and the Mountain Tulip (*Lloydia serotina*, Rchb.). The remainder discuss the evolution of certain types of plants, the examples taken being the daisy, strawberries, cleavers, wheat, the family of Rosaceæ, and the cuckoo-pint. The articles are written in the author's well-known pleasant style, and cannot fail to attract and interest many who have never previously turned their attention to the study of our common weeds.

Mr. Grant Allen has a great horror of a "microscopical critic," which he defines as "a learned and tedious person who goes about the world proclaiming to everybody that you don't know something because you don't happen to mention it." After reading this book, however, one feels tempted to reassure him on this head. For the work contains a considerable number of things which we may venture to state nobody ever knew before. Take, for instance, the text of the fifth essay, that on the origin of wheat: "Wheat ranks by descent as a degenerate and degraded lily"; and again, "While the daisy has gone constantly up and while the goose-grass has fallen but a little after a long course of upward development, the grasses generally have from the very first exhibited a constant and unbroken structural decline." This, we think, will be an entirely new view to the botanical morphologist. On these lines he proceeds to trace the evolution of the wheat-plant, from an imaginary primitive Monocotyledon, and suggests that *Alisma ranunculoides* might represent the earliest petal-bearing type in this line of development, except for the fact that its petals are pinky-white instead of yellow! From this plant he traces the descent of the wind-fertilised rushes, the stamens of which he states hang out pensive to the breeze on long slender filaments. This is certainly not the case: the filaments of the rushes are short and rather broad, and the anthers are usually fixed by the base, and not at all more adapted for wind-fertilisation than those of such a plant as the bog-asphodel, which is regularly fertilised by insects.

From the rushes both the sedges and grasses are derived, but on different diverging lines. The former class of plants Mr. Grant Allen considers to be very degenerate in type, the calyx and petals, which were brightly coloured in the lilies, being reduced to the six small dry bristles which we find in some species of *Scirpus*. He does not explain, however, how it is that some Cyperaceous plants possess seven or eight of these bristles. But the most extraordinary suggestion is that



the female flower of a *Carex* is represented by "a single ovary inclosed in a loose bag, which may perhaps be the final rudiment of a tubular bell-shaped corolla like that of a hyacinth"! Surely the nature of the utricle of a *Carex* has been clearly enough demonstrated by the structure of the flowers of monstrous specimens and of allied genera. To complete his remarks upon the sedges he adds a footnote, in which he says: "The sedges are not in all probability a real natural family, but are a group of heterogeneous degraded lilies, containing almost all those kinds in which the reduced florets are covered by a single conspicuous glume-like bract." Now there is probably hardly any large order in the vegetable kingdom so natural as that of the Cyperaceæ, so little connected with any other, and of which the genera are so closely allied together, as is proved by the comparatively small number of genera in it, and the large number of species which many of the genera contain.

The wheat plant being a degraded lily, it becomes necessary to trace the development of the flower of the one into that of the other, which is done by considering the palea of the wheat-flower as homologous with the calyx, and the lodicules as representing the corolla, a view which has long been considered untenable.

The two essays upon the distribution of plants call for some comment. Here the author is on firmer ground, for, thanks to the researches of Forbes and Watson, we have a much clearer notion of the origin of our flora than we can have of the pedigrees of the plants themselves. At the same time we must take exception to the suggestion that the seeds of the northern Holy Grass, which Robert Dick discovered in Caithness, were introduced into New Zealand from Siberia upon the feet of a belated bird. The plant in question does not occur, as far as is known, in New Zealand. The species which does occur both in New Zealand and Europe is found throughout the temperate Antarctic zone, extending even to the Cape. Nor is this distribution, as the author states, a very rare and almost unparalleled coincidence. The fact is that there is a very considerable number of plants common to the north and south temperate regions, most of which occur in North America, and seem to have descended towards the Antarctic regions along the line of the Andes.

But, apart from improbabilities in theory, there are numerous statements which cannot fail to convey erroneous impressions of plant-physiology. What, for instance, could be more misleading than the following statement concerning *Potentillas*? Those "which raised their leaves highest would best survive, while those which trailed or kept closely along the ground would soon be starved out for want of carbonic acid!" It is not the absence of carbonic acid gas that the plant would suffer from, but from the loss of light by which it could utilise it. These statements, and many others of a similar nature, suggest that Mr. Grant Allen has confined his observations too much to the flora of the British Islands. It is utterly impossible to form any correct idea of the history of the evolution of a plant without knowing thoroughly the structure of all the plants in any way related to it, and without having, moreover, a much clearer knowledge of the effects produced by external circumstances in modifying organs than we at present possess. In the meantime dogmatic statements concerning the evolution of

any given plant are in the highest degree unsatisfactory, and likely to lead to error.

The book is nicely got up, and the language is in that easy and fluent style in which Mr. Allen is so proficient, and which goes so far towards investing the driest details of science with a poetical and even romantic interest.

H. N. R.

### OUR BOOK SHELF

*Wonders of Plant-Life.* By Sophie Bledsoe Herrick. (London: W. H. Allen and Co., 1884.)

THIS is another well-intentioned but unsuccessful attempt to deal in a popular style with some of the more sensational parts of the science of botany. Inaccuracy is again the glaring fault: thus we read on p. 4 that "vegetable cells, in the earlier stages of development, generally approximate to the sphere in form"; on p. 17 that the vessels "serve to convey air through the tissues of the plant," and "are the lungs of the plant"; and again, on p. 24, that the red and ultra-red rays are those actively concerned in the process of assimilation. Similar inaccuracy may be traced in those of the illustrations which are original; for example, the drawing of *Penicillium* on p. 60. The frequent production of popular treatises shows that there must be some demand for such books. It is much to be desired that some botanist who is really master of his subject would take the matter up, and write in a popular style a trustworthy account of those parts of the science of botany which are of especial interest to the general public.

*Histological Notes for the Use of Medical Students.* By W. Horscraft Waters, M.A. (London: Smith, Elder, and Co., 1884.)

IN the introduction to this little work of 65 pages Mr. Waters states that, in taking the class of Practical Histology at the Owens College Medical School during the summer sessions of 1882-83, it had been his custom to give each student "sheets" containing a short account of the chief points to be observed in the specimens for examination. The present work has grown out of these notes, after careful revision and additions thereto by the author. Students of histology have already numerous similar treatises placed at their disposition, describing the various methods of staining, clearing, and mounting specimens; but room will always be found for additional ones bearing on this subject, provided they are the outcome of practical experience. These notes have been carefully prepared; the directions given are clear and concise, and beginners cannot do better than carefully follow them.

### LETTERS TO THE EDITOR

[The Editor does not hold himself responsible for opinions expressed by his correspondents. Neither can he undertake to return, or to correspond with the writers of, rejected manuscripts. No notice is taken of anonymous communications.]

[The Editor urgently requests correspondents to keep their letters as short as possible. The pressure on his space is so great that it is impossible otherwise to insure the appearance even of communications containing interesting and novel facts.]

#### Pile-Dwellings on Hill-tops

I OBSERVE this question to the fore in *NATURE* of February 21 (p. 382), and as I have lived many years among races who build various forms of pile-houses, and have often resided in them for a time, I trust you can allow me a few words on the subject. The custom seems attributed to several causes, *i.e.* to excessive moisture and as a protection against wild beasts, by Mr. Keane; to excessive rain and a wet climate, by Col. Godwin-Austen; to damp exhalations from tropical soil, by Mr. Dallas; and to the

survival of a purposeful habit of building over water, by Mr. Tylor.

A considerable experience among Nogas, Miris, Singphus, Kamtis, Deodhains, and Duonias, who all build pile-houses a little varied in kind, convinces me that the above reasons are not strictly correct.

Possibly the Swiss lake-dwellers descended from Eastern races who built over water, and inherited a custom that perhaps subsequently proved to be beneficial to them when and where large Carnivora were common. As regards India, it seems to me there are good reasons for believing these pile-builders are the direct descendants of the pre-Aryan aboriginals, and if they brought the custom with them from the south, it must be of extreme antiquity, and have developed adaptations to local needs, as it is not here used over water.

It seems hardly due to moisture and tropical rains, as the Kasias, Augamis, and Garos, who live in the wettest climate of all, build on the ground. Again, among those who build on piles many live and sleep on the ground, using the piled part of the house for other purposes. The platforms also are generally too low to afford safety from tigers, and if so needful for health, why is the custom not more general?

Among the Miris, Singphus, Kamtis, Nogas, Mismis, and Deodhains that I have questioned as to the origin of the custom of building on piles, the answer is invariably that they do not know, that it is their tribal custom, &c. Pressed as to the advantages of it, or why they could not build on the ground like Hindus, they generally end by urging the absolute necessity of keeping things out of reach of the ever-present pig.

Section through Noga house, say 60 feet (1 to 4), E.S.E. Sibsagar.

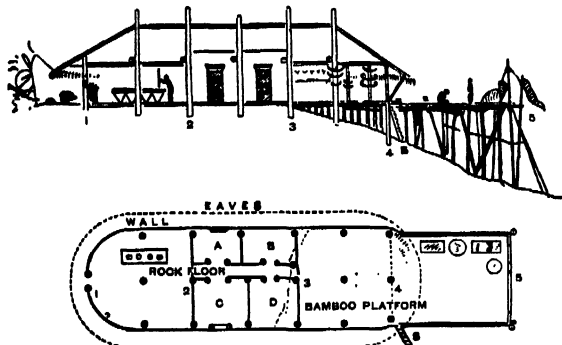

1 to 2, Rice husking; 2 to 3, Sleeping, cooking; 3 to 4, Audience, &c.  
5, "Chang" outside; 6, Steps up; A B C D, Sleeping-rooms.

Among many of these tribes, where stone for walls is not easily procurable, the jums even have to be at some distance for the same reason.

As an illustration of how this animal practically affects the question of house-building, I append a section of a typical average Noga house, as built by the tribes south-east of Sibsagar to the Upper Dihing. One end generally rests on the ground, while the other overhangs a slope for which there often seems to be no occasion, as plenty of level land is about. In all houses of this type the end devoted to husking rice rests on the ground, and the door at that end has a slab that can be raised to admit pigs to eat the husks. This compartment (one-third of the house) is divided from the living and sleeping part by a wall and a door with a stile to keep out pigs. There are generally from two to six, or more, sleeping-rooms on the ground, and beyond them again is an open room used for visitors, or to sit and work in during wet weather. It is hung round with horns and trophies, contains hunting and fishing gear, arms and utensils, and small stores. It is the recognised audience-hall, and built on piles; the floor of it is generally carried out beyond the eaves of the roof, often supported on long bamboos (where the slope is steep), and this outer part or raised floor is seen in some shape or other in all these houses. It is used to sit out on in fine weather, to work on; rice, yams, sliced vegetables, fruit, fish, flesh, &c., are put there to dry; pottery is made, and things laid while they are gone to the jums, safe from the prowling From one end of the house to the other, indeed, these pr scavengers are apparent as an institution.

As a rule these pile-houses run from thirty to two hundred feet

long, and are wholly on piles if in the level plains, but the several tribes have slight modifications. They are still built by the Deodhains, a remnant of the Shans who came into Assam in 1228, and gave it their name (from Ahom); about five hundred of these people still remain in some six or eight villages not far off, though dying out. Their language and written character possibly is a unique case of a written language not yet secured. While they remain Ahoms they keep and eat the pig and build on piles, but when converted to Hinduism the pig and piles are given up together.

I am aware that pigs are kept by Kasias and Garos, &c., who yet do not build on piles, but stone for walls and slabs of gneiss are there *alone* common, and are effectually used as inclosures or as barriers. There is practically no building-stone where we see the piles in use; and also bamboo is there common.

But there are many other things besides pile-dwellings that prove these now distinct tribes to have descended from a common stock. The "morongs," or houses in which the lads and single men sleep at night, away from their parents' houses, are seen under various names all through these hills, north, south, and east of Assam, a custom that has survived the differentiation of the languages. There are also "morongs" for the girls and single young women, and there are special and peculiar laws relating to morongs.

Liberty of the sexes before marriage is indeed practically so complete among all these tribes that really *morals begin with marriage*. After marriage they are better, I think, than civilised nations.

These customs and pile-buildings, &c., indicate a common origin, but there are also means by which we can ascertain the common *home* more or less accurately, and which show that these pile-builders are descended from the pre-Aryans of the plains, from Assam to the Indus, who named so many of the rivers. In and around Assam we find these names often begin and end with Di and Ti—as Dihing, Dihong, Dibong, Dibru, Dima, DIPA; Timu, Tiok, Tisa, Tiru, Tiwa, Tista, or Aiti, Galti, Seti, Tapti, Rapti, Kamti, Gulmthi, Ningthi, Lathi, &c. This Di, Ti, means in all cases "water,"—as Ti, water; Sa, the little, young = Tisa, the "young river"; and there are other forms—as Lushai Tui, Kachari Doi, Noga Ti, Tsi, Tzu; Chu is also Thibetan, Bhotan, and Chinese; Mongolian being Su, Ussu.

But the Himalaya has acted as a conspicuous speech-parting. South of it we have the pile-builders' form—Di, Ti, Doi, Da, Dzu; and north of it, from the east of China, all across Central Asia, Persia, and Asia Minor, to the Gulf of Salonica even, we have the northern Chu and Su in some form. Of Kara Su = black water, and Ak Su = white water (our Oxus) there are scores of instances; even the "Ind-us" and Eu-phrat-es, and many others, fall into the group.<sup>1</sup>

I drew up lists of these river-names some years ago in the *Journal A. S. Bengal*, vol. xlviii, part 1, 1879, pp. 258-70.

Thus it would seem as though the races who now build these pile-houses, often on hill-tops, are the descendants of those who named so many of the Indian rivers south of the Himalaya, *i.e.* the pre-Aryan inhabitants.

Whether these races originally came from the south or not we cannot yet be certain. But there are several customs, such as "head-hunting" and "pile-dwelling," held in common with races of the Archipelago; and among the most eastern Nogas the dress is as nearly as possible *identical* with that of the Dyaks, as illustrated in Dr. E. B. Tylor's "Anthropology," so that eventually it may be possible to say.

In conclusion, I might mention that the word "Naga," as applied to the tribes south and south-east of Assam, is an Anglo-Bengali-ism, and misleading. It should be Noga, which is the name by which these tribes are known in Assam. It is not a racial name in the hills at all, and has originated from the Noga word "Nok" for folk.

Thus, Who are you? is "tem nok?" or "o nok e?" N and L are interchangeable letters, and thus Dr. Rajendralala, Mitr, pointed out to me that the Noga Nok and the Sanskrit Lok = man, seem the same word. We use the word Log = folk (logue) almost hourly in Assamese, Bengali, and Hindi, and philologists may perhaps be able to say if we get our word folk from this same root, and for which it is the exact equivalent. But the word for these hill-men is "Noga," and they do *not* worship snakes. The real Nagas are in another part of

<sup>1</sup> The Assyrian hu, Greek eu, Scythian ku = water (A. Cunningham "Anct. Geo.," p. 37).

India, and I trust Dr. Hunter and Mr. Phil Robinson will excuse my saying they are both wrong *re* this name.

These hill-men have histories, if we could only get at them. This I find by having traced forty-six villages (now nine or ten different clans) as being offshoots of "Sang-nu," east-south-east of Sibsagar. Twenty-five generations ago they began to spread.

S. E. PEAL

Sibsagar, Assam, May 5

#### Atmospheric Dust

ON Thursday, April 24, showers of discoloured rain fell at Inglewood, Sandhurst, Castlemaine, Kyneton, Daylesford, and the districts adjacent, that is to say, over an area of more than 2,500 square miles in extent. The heaviest showers—called by all who were out in them "showers of mud"—occurred at 7 o'clock p.m. and near midnight. The leaves of trees and shrubs, roofs of buildings, fences, and everything on which it could rest were more or less covered with red mud. The weather at Sandhurst for some ten days prior to this occurrence had been dry, and for a long period there had been a drought in New South Wales and in many parts northward. At several places in Victoria and New South Wales violent dust-storms occurred on the morning of the 24th immediately preceding the commencement of the rain. Some of the mud, of a bronze colour, collected by Mr. Edward Hurst of Sandhurst, was found by microscopical and chemical examination to be composed of quartz, oxide of iron, and mica; some taken from the rain-gauge stand at the School of Mines was, when dried, an almost impalpable powder of a pale reddish chocolate colour. It was seen to consist of ferruginous quartz and minute particles of black oxide of iron; and a smaller quantity collected at my private meteorological observatory—about three-quarters of a mile distant—was paler in colour, and consisted of quartz (much of it iron-free), alumina, sesquioxide of iron, and white and reddish-yellow mica. A small proportion of it was attracted by the magnet. The water collected in the rain-gauges when agitated was reddish-brown in colour, and the proportion of sediment was very large, leaving no room for doubt that the dust was brought down by the rain. Its composition and the times at which it fell lead me to believe that it came from the north and had travelled far.

R. BROUGH SMYTH

School of Mines, Sandhurst, Victoria, Australia,  
May 1

#### The "Red Glow" after Sunset

BEING out on Sandymount Strand last night, whence the western sky may be well observed, I noticed, about 8.45 p.m., the "red glow" over the yellowish sky where the sun had set. It was quite as distinct as during certain evenings at the end of last year.

J. P. O'REILLY

Royal College of Science for Ireland, Stephen's Green,  
Dublin, June 12

#### The Earthquake

As communications on this subject are still being received by NATURE, and as the records for London and its immediate vicinity have been few, it occurs to me to note the following facts:—At the time of the earthquake I was sitting in my study here. There are several heavy insect-cabinets in the room, and a loud "groan" proceeded from one or more of them, indicating "settling" from some cause or other. Furthermore, the door of the room would not lock on the evening of that day, although the lock had moved freely down to then. And a clock in a bed-room was found to have stopped without any apparent cause at the hour indicated for the earthquake; but as the discovery was not made until late in the evening, it was not possible to decide whether the stoppage had occurred in the morning or evening. As no sensation was felt, these matters would have held no significance had it not been for the news in the evening papers of that day.

R. MCLACHLAN

Clarendon Road, Lewisham, S.E., June 13

#### Intelligence in Animals

THERE is at Walham Green a daily illustration of intelligence in a donkey which may interest those of your readers who collect such facts. Old Bob the waterman has been known for so many

years that it is impossible to say how many. He is one of the few surviving carriers who take round for sale water in a tub on wheels, which is drawn by a donkey. Bob, the tub, and the donkey are one of the institutions of Walham Green. Years ago Bob used to guide his donkey to the pump near the church and then drive him round to his customers. How long the donkey was learning his rounds I do not know. Three years ago Bob used one shaft as a sort of movable crutch, and seemed to trust much to his donkey to go the right way. Now he appears quite blind, for a few days ago he was noticed going into the yard where the pump stands, when the donkey stopped. He asked a boy what his donkey had stopped for, and was told that a cart was in the way. It is interesting to note that the donkey conducts by his own intelligence all the business of water distributor, while Bob has sunk to the condition of mere pumper and of money collector attached to and led by the shafts, which latter duty might be done by an intelligent dog. M.

#### ADOLPHE WURTZ AND HIS CHEMICAL WORK

BY the death of Adolphe Wurtz on May 12 last, the world, and especially the scientific world, has lost one of its brightest and most energetic leaders,—a successful leader indeed, through perhaps the most difficult period of chemical history—the earliest years of the development of our "modern chemistry." His loss is felt all the more acutely, coming as it does so suddenly and so close upon that of his master and friend, Dumas, whose mantle had fallen upon him.

Charles Adolphe Wurtz was the son of a Protestant clergyman, and was born on November 26, 1817, at Wolfsheim, near Strasburg. He studied in the University of Strasburg in the Medical Faculty, in which he took the Doctor's degree with honours in 1843. He came to Paris in 1844, where he soon attracted the attention of Dumas, and after occupying several positions successively at the École Centrale and the Faculty of Medicine he became Professor at the Institute Agronomique of Versailles, and in 1853 succeeded to the duties of Dumas and Orfila as Professor at the Faculté de Médecine.

Wurtz united in himself all the better qualities of the Gallic and Teutonic character, in his activity of mind and untiring perseverance in the search for truth. He was elected a member of the Academy of Medicine in 1856, and in 1865 was awarded the prize of 20,000 francs for his chemical researches. He became Dean of the Faculty in 1866, and Professor at the Sorbonne in 1878, in which year also he gave the Faraday Lecture at the Royal Institution; the subject of which was the condensation of gases, and his hearers on that occasion will not readily lose the impression of his earnestness and vivacity, especially on the appearance of the liquefied gas (ammonia), and his exclamation, "Voilà ! voilà le liquide," &c.

His earnestness of purpose, conjoined with a most genial manner and expression, gave him very great influence over those students who worked with him; and a long list of names might be given of students who have done good service to the science under his guidance and encouragement.

But he not only encouraged the students who came to learn under him, but strove to spread a knowledge of science amongst the mass of the public, in which task he was eminently successful.

In addition to his onerous duties as professor, Wurtz was in 1881 elected permanent Senator, and rendered most valuable services to his country as recorded in his Reports of Commissions on the trichinosis outbreak and on scientific education.

While there are chemists the work and example of Adolphe Wurtz will serve as a beacon and guiding light to still wider and more important facts in our science.

The Royal Society's Catalogue of Scientific Papers contains a list of no fewer than one hundred and four papers to which the name "Adolphe Wurtz" is alone

attached; of these a large proportion recite particulars of researches which have furnished results of high theoretical importance, and which entitle their author to be reckoned as one of the chief contributors to the foundation of systematic chemistry. In him French chemists lose their chief leader; but their loss is also that of the scientific world at large. His logical clearness of thought, his breadth of view, and the precision of his statements secured Wurtz an influence wherever chemistry was taught; and at the present time, overwhelmed as we are in the chaos of facts brought to light with such astounding rapidity by the labours of chemists in all parts of the world, the loss of such a master-mind, of a man possessed in so high a degree of the power of co-ordination, is indeed grievous. His "Introduction to Chemical Philosophy," his "History of Chemical Theory," and his "Atomic Theory," of all of which English translations have been published, afford striking illustrations of the character of his teaching, and are unsurpassed as introductions to the study of the historical development of our science.

Wurtz's first paper, published in 1842, was "On the Constitution of the Hypophosphites," and, together with another on the same subject put forward a year or so later, forms not the least important of his contributions. Hypophosphorous acid had been discovered by Dulong and afterwards examined by Heinrich Rose, but their results were not in accordance; Wurtz therefore undertook the study of the acid. He established its composition and prepared and analysed a large number of its salts, and was thereby led to the conclusion that hypophosphorous acid contained two atoms of hydrogen which could not be displaced by metals, being, in fact, a monobasic acid; he also showed that of the three atoms of hydrogen in phosphorous acid only two were displaced in the formation of salts. This research was carried out in Dumas' laboratory; it may even now serve as a model of what such work should be.

In the course of his study of the hypophosphites, Wurtz was led to make what probably was his most interesting, although not his most important, discovery: that of copper hydride,  $\text{Cu}_2\text{H}_2$ . Even at the present day, although we have reason to believe that the alkali metals and palladium and platinum form compounds with hydrogen, copper hydride is the only hydride of a metal with which we are acquainted which has anything like definite and specific properties. It is obtained by acting on copper sulphate with hypophosphorous acid as a yellow or reddish-brown precipitate, which when heated readily decomposes into hydrogen and copper, and on treatment with muriatic acid yields cuprous chloride and twice the volume of hydrogen which is obtained on merely heating it. This reaction, as Brodie first pointed out, affords an almost conclusive argument for assuming that the hydrogen molecule is compound in its nature. Berthelot having called in question the existence of cuprous hydride, Wurtz in 1880 maintained the correctness of his original statements. It is to be hoped that this remarkable compound will ere long again attract attention, as it is more than probable that it will be of service as a reducing agent; its thermo-chemical investigation may be expected to furnish important information on the affinity of hydrogen atoms for hydrogen atoms: indeed it is remarkable that it has so long escaped attention from this point of view.

Wurtz paid much attention to the investigation of the cyanogen compounds, and in studying the cyanic ethers was led in 1847-49 to make the most brilliant of his discoveries, that of the compound ammonias. These bodies were obtained by the action of alkali on cyanic ethers, just as ammonia is formed from cyanic acid. In properties they were the precise analogues of ammonia, and on this account, and on account of the manner in which they were produced, Wurtz at once regarded them as ammonias in which an atom of hydrogen is displaced by an alcohol

radicle such as methyl or ethyl, thus giving rise to the idea of the ammonia type. Hofmann's discovery, a few months later, of diethylamine and triethylamine, compounds resulting from the displacement of two and three atoms of hydrogen in ammonia by ethyl, and of the method of preparing amines by the action of the alcoholic iodides on ammonia, was a fitting corollary to that of Wurtz. The combined result of these two classical researches was that chemists have ever since accounted for the properties of the organic bases generally by regarding them as derivatives of ammonia, which they all so closely resemble in chemical behaviour.

Passing over numerous investigations of minor value, we come to a paper published in 1855, "On Simple and Mixed Organic Radicles," which at that time was of great importance, and well illustrates Wurtz's method of almost invariably choosing subjects the investigation of which was of special interest as bearing on the advance of chemical theory. This paper is also memorable as con-



ADOLPHE WURTZ (from *La Nature*).

taining the first description of the method now so commonly employed of preparing hydrocarbons by the action of sodium on the iodides and bromides of alcohol radicles, a method which some years afterwards was applied with such success by Fittig in elucidating the constitution of the homologues of benzene. Frankland and Kolbe had maintained that the hydrocarbons of the empirical composition of the so-called alcohol radicles which they had prepared were of the same composition in the free state as in combination: for example, that the hydrocarbon obtained from ethyl iodide,  $\text{C}_2\text{H}_5\text{I}$ , was free ethyl,  $\text{C}_2\text{H}_5$ . Gerhardt, Hofmann, Laurent, Brodie, and Wurtz, however, sought to show that they should be represented by a doubled formula: that the so-called ethyl, for instance, had the composition  $\text{C}_2\text{H}_{10} = 2\text{C}_2\text{H}_5$ . This Frankland strenuously opposed, mainly on the ground of the complete homology of the hydrocarbons in question with hydrogen, the formula of which was then almost universally written H. The arguments used were chiefly of a physical character. Wurtz put an end to the controversy

by introducing an argument which at once appealed to the sympathy of the chemist, by showing that, if a mixture of the iodides of two distinct radicles, such as ethyl,  $C_2H_5$ , and butyl,  $C_4H_9$ , were submitted to the action of sodium, a hydrocarbon was produced which consisted of ethyl and butyl united together. There was no reason to suppose that when a single iodide was thus treated the radicle remained free, and Wurtz showed that the physical properties of the hydrocarbons produced from single iodides were such as to prove that they were formed by the union of two similar radicles, as on no other hypothesis could they be ranged in a series with the hydrocarbons resulting from the association of two dissimilar radicles. It was a logical extension of this discovery to double the formulæ of free hydrogen, a step which, indeed, Brodie had already advocated, and which Frankland had clearly maintained was an essential preliminary to the doubling of the formulæ of the organic radicles. Wurtz also pointed out that the idea that the hydrogen molecule is compound must be extended to other elements, and that generally the simple bodies, like compounds, are composed of groups of atoms, and react not by combining but by exchange of elements.

The number of elements of which the molecular weight has been ascertained is, however, very small, and although the idea thus put forward by Wurtz undoubtedly applies to all the gaseous elements, and to bromine, iodine, sulphur, phosphorus, and arsenic, we now know that the only *metals* of which the density in the gaseous state has been satisfactorily determined, viz. mercury and cadmium, form distinct exceptions to the rule; we can therefore draw no conclusions of any value as regards the molecular composition of the metallic elements. It is a striking illustration of the slowness with which knowledge extends into that lower stratum which is governed by the textbooks, that the view put forward by Wurtz, and which, with the above-mentioned limitation, is so clearly justified by facts, is almost universally disregarded by hand-books of chemistry; in fact, there is a most astounding superstition among students of chemistry that the elements generally have diatomic molecules.

In 1855 Wurtz was led by the brilliant experimental results of Berthelot to discuss the formula of glycerin, and he was the first to point out that this body is to be referred to the type of three molecules of water; that, in fact, it can be regarded as an alcohol formed by the displacement of three atoms of hydrogen in three molecules of water by the radicle  $C_3H_6$ . Nearly all the alcohols known at that time could be referred to the type of a single molecule of water. Recognising the want of an intermediate series of alcohols, Wurtz was led in 1856 to the discovery of the glycols, and in this case again his work was of the highest value as a contribution to chemical theory.

Space does not permit of reference to the numerous other investigations of Wurtz, many of which have exercised an important influence upon chemical thought at the time of their publication. Only one must be mentioned, as it may ultimately prove to have been the first step towards the elucidation of the nature of the process of digestion in plants and animals. The investigation referred to is that on the sap of *Carica papaya*. He showed that alcohol precipitates from this a body presenting the characters of a strong digestive "ferment," capable of dissolving moist fibrin in large quantities. Experiments made with papaine, as the so-called ferment is termed, appear to show that papaine begins by combining with the "ferment," and that the insoluble product then undergoes gradual change in contact with water, the "ferment" being liberated and thus becoming free to do new work. There is much to indicate that mineral acids act in this way, and it is to be hoped that the suggestion put forward by Wurtz will not long escape notice, and that his investigation may be extended.

## AFRICAN EXPLORATION

LETTERS addressed to the Secretary of the Committee of the British Association for the exploration of Kilimanjaro have just been received from Mr. H. H. Johnston, dated from the British Residency, Zanzibar, May 13. After consultation with Sir John Kirk, Mr. Johnston had selected the Mombasa route for Kilimanjaro, and was expecting to depart for that port in about a fortnight's time. The country between Mombasa and Chaga was said to be quiet, and to present no serious difficulties in the way. Mr. Johnston had succeeded in obtaining the services of three of the same bird-skinners that had been employed by Dr. Fischer, and of a botanical collector trained under Sir John Kirk, of whose kindness and assistance he speaks in the highest terms. Mr. Johnston, in spite of the trying climate of Zanzibar, was in excellent health, and had strong hopes of the success of the expedition.

We are pleased to learn that Mr. Joseph Thomson has arrived safely at Zanzibar from the expedition he undertook to the Masai region. It will be remembered that Mr. Thomson left England in the end of the year 1882, his object being to proceed by Mount Kilimanjaro to the almost unknown country of the Masai, and to settle the question of the existence of a Lake Baringo to the east of Victoria Nyanza. Mr. Thomson left Zanzibar in the

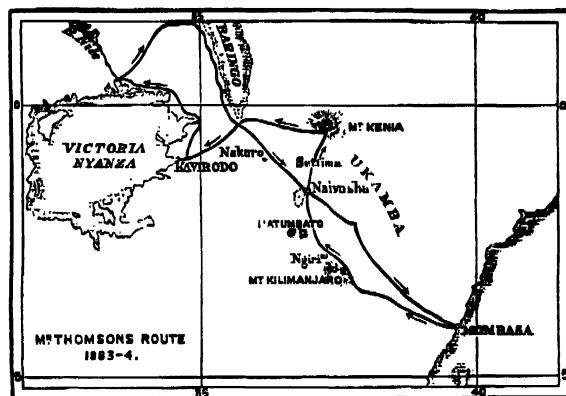

spring of last year, but after proceeding some distance found the country so disturbed owing to the recent passage of a German explorer, Dr. Fischer, that he was compelled to return precipitately to Mombasa. In July last, however, he started again, and has evidently accomplished his work in a way quite worthy of his previous record. Passing round the north-eastern side of Mount Kilimanjaro, Thomson proceeded north to Lake Naivasha, halfway between Kilimanjaro and Mount Kenia; then on to the latter mountain, and by way of Lake Baringo to the shores of Victoria Nyanza. This latter lake he skirted as far as the outlet of the Nile, returning by a more northerly route, striking the west coast of Lake Baringo, and proceeding south and south-east by Ukambani to Mombasa. It is satisfactory to record that no lives have been lost except by illness. The telegram which the Geographical Society have received from Sir John Kirk does not, of course, enter into minute details, but from its general tone it is evident that Mr. Thomson will have an interesting and instructive story to tell when he returns. The telegram does not state positively that Mr. Thomson found a lake where Baringo is placed on our maps, but as Baringo is mentioned as having been touched at, it seems most probable that the information obtained from natives by the sagacious Wakefield is correct. All the country traversed by Mr. Thomson's expedition to the north of

Lake Naivasha is new ground, hitherto untraversed by any explorer. Dr. Fischer in his recent expedition reached only as far as the lake just mentioned.

### A NEW ASTRONOMICAL JOURNAL<sup>1</sup>

AN astronomical serial, under the auspices of the Observatory of Paris, will be a welcome addition to the literature of the science, and may well be expected to occupy a prominent place on the list of such periodicals.

Admiral Mouchez, in his introductory note, alludes to the great impetus which has been lately given in France to the progress of astronomy by the establishment or re-suscitation of observatories, aided as well by national funds as by contributions from the municipal authorities of the places where they are located. In a few years these various observatories will be completely organised, the *personnel* consisting in part of astronomical students who have obtained their acquaintance with the practical branches of the science in the Observatory of Paris. The director therefore aims at providing a medium in the *Bulletin Astronomique* whereby the work of French astronomers may be speedily made known, and where at the same time an analysis of the contents of the principal foreign periodicals, &c., may be available to them.

The *Bulletin* will thus present two distinct sections: the first will be composed of observations of current interest, ephemerides of planets and comets, and memoirs or notices on various questions in theoretical and practical astronomy. The second will comprise as complete a *résumé* as possible of astronomical intelligence and an analysis of the principal periodicals and newly-published works. Further, in a supplementary section it is intended to introduce articles on subjects relating to the sciences allied to astronomy, as terrestrial physics, geodesy, and meteorology, not excluding points of interest in the history of the science: contributions from foreign astronomers are invited.

In the first four numbers of the *Bulletin* are articles bearing upon sidereal, planetary, and cometary astronomy. There is a series of measures of double-stars in 1883, made by M. Perrotin at Nice in continuation of previous series which have appeared in the *Astronomische Nachrichten*. M. Perrotin has habitually used powers of 750 and 1000; objects not too frequently measured of late will be found in his list, which is to be continued. M. Henry has a note upon the planet Saturn as viewed in the refractor of 0.38 m. at the Observatory of Paris, in which reference is made to a narrow bright ring limited by a dark line, outside the principal division, the breadth equal to that of the division of Cassini, which they consider to be a new feature. It is stated that the Encke division has completely disappeared; notwithstanding extremely favourable atmospheric circumstances, nothing was remarked upon the outer ring except the narrow bright zone just mentioned. M. Henry invites communications on this subject from other observers provided with large telescopes. M. Baillaud publishes observations of *Mimas* made at Toulouse between October 24, 1876, and December 5, 1883. The telescope employed has an aperture of 0.83 m., the mirror being the work of M. Henry, the mounting by Secretan. A power of 335 was usually employed; the observations for the most part consist of the times of elongations, but during the opposition of 1882-83 M. Fabre succeeded in observing several conjunctions with the minor-axis of the ring N and S. From these observations M. Tisserand has drawn several conclusions respecting the motion of the satellite, to which he directed attention in a paper submitted to the Paris Academy of Sciences on January 28, and printed in the *Comptes Rendus*. He fixes the mean daily

motion at  $381^{\circ}.9934$ , and his observations are compared with calculation on this hypothesis, the orbit being supposed circular. But he infers that there is an inequality in the mean longitude, of which the period is about five years, and the coefficient approximately  $8^{\circ}$ ; further he finds that the eccentricity does not exceed one-tenth. The longitudes of the perisaturnium, deduced from observations during five periods, may be fairly represented on the assumption of an annual motion of  $447^{\circ}$ . It is intended to observe *Mimas* at Toulouse as frequently as possible, and, so far as circumstances admit, the same observer will undertake them, it having been found that observations made by different persons with the same instrument are not strictly comparable.

In the February number of the *Bulletin* M. Schulhof has the earliest notification of his discovery of the periodicity of the third comet of 1858, upon which he enters into details in the number for April; the most probable period of revolution resulting from the few observations which were secured in America (the comet was not seen in Europe) is 6.61 years, and the limits somewhat insecurely assigned are 5.80 and 7.54 years. As in other cases, this comet approaches very near to the orbit of Jupiter, to which we may attribute the limited dimensions of the orbit, according to M. Schulhof. There are several communications on Pons' comet, physical and otherwise; amongst them a note by M. Trépid and Rambaud, of the Observatory at Algiers, on the remarkable variation in the head of the comet, observed on January 19, and one by M. Rayet on the *aigrettes*, &c., remarked near the time of perihelion passage. M. Radau treats on the theory of the heliostats, and M. Bigourdan on a means of rendering more convenient the use of the equatorial. We find also in these numbers of the *Bulletin* a description and plan of the buildings of the Observatory at Marseilles, by M. Stephan; and a list of discoveries of small planets and comets made at that establishment: amongst the latter we note that the discovery of the first comet of 1867 on January 25 is attributed to M. Coggia; at the time it was announced to have been made by M. Stephan, at least in a letter from M. Tempel, then residing at Marseilles, to the *Astronomische Nachrichten*; as Mr. Searle has shown that the comet is one of comparatively short period (thirty-three years) and may therefore want a name, it might be well to settle the point as to who was the actual discoverer. There is a note on an Observatory to be erected at La Plata, the recently founded capital of the province of Buenos Ayres; a director has been already nominated in the person of M. Beuf, an officer of the French Marine, formerly in charge of the Observatory of Toulon; 100,000 francs have been allowed for the Observatory and instruments, with an annual subsidy of 24,000 francs. Such liberal encouragement of science does honour to M. Dardo Rocha, the Governor of the Province of Buenos Ayres, and it is due to him to add that he had previously done much for recent progress in the Argentine Republic.

As a specimen of the miscellaneous articles in the *Bulletin*, we may mention M. R. Radau's interesting account of the recent crepuscular phenomena, in which he has availed himself of the numerous facts relating thereto which have been published in *NATURE*. He does not profess to decide upon the cause of these phenomena, or to make choice between the explanations which have been offered, but we may quote his concluding paragraph: "Ce qui semble prouvé, c'est qu'il s'agit ici, très-probablement, de phénomènes de réflexion, dus à la présence de matières finement divisées dont la nature reste à déterminer; la lumière ainsi réfléchie n'est, sans doute, que la lumière ordinaire du soleil couchant, colorée par transmission à travers les couches basses, chargées de vapeurs."

The typographical execution of the *Bulletin* leaves nothing to be desired. The March number contains a photolithograph of the aspect of Saturn as viewed at the Observatory of Paris on the 4th of that month.

<sup>1</sup> *Bulletin Astronomique*, publié sous les auspices de l'Observatoire de Paris, par M. F. Tisserand, &c. (Paris: Gauthier-Villars, 1884.)

MEASURING EARTHQUAKES<sup>1</sup>

## II.—RESULTS.

IN this paper a short account will be given of the chief results of two and a half years' observations in the Seismological Observatory of the University of Tokio. The first instruments to be successfully used were the horizontal pendulum, or rather a pair of horizontal pendulums writing a multiplied record of two rectangular horizontal components of the earth's motion on a revolving plate of smoked glass, and also a very long common

pendulum. The duplex pendulum, an astatic vertical-motion seismograph, and other instruments which have been mentioned in the former article, were added later.<sup>1</sup>

The earliest records were those of five small earthquakes in November 1880.<sup>2</sup> In the first of these the vibration of the ground lasted continuously for  $1\frac{1}{2}$  minutes, and no fewer than 150 complete oscillations could be counted in the record. The shaking began feebly, speedily rose to a maximum, fluctuated irregularly, and died out very gradually. The greatest movement from side to side was less than one-third of a millimetre. Both

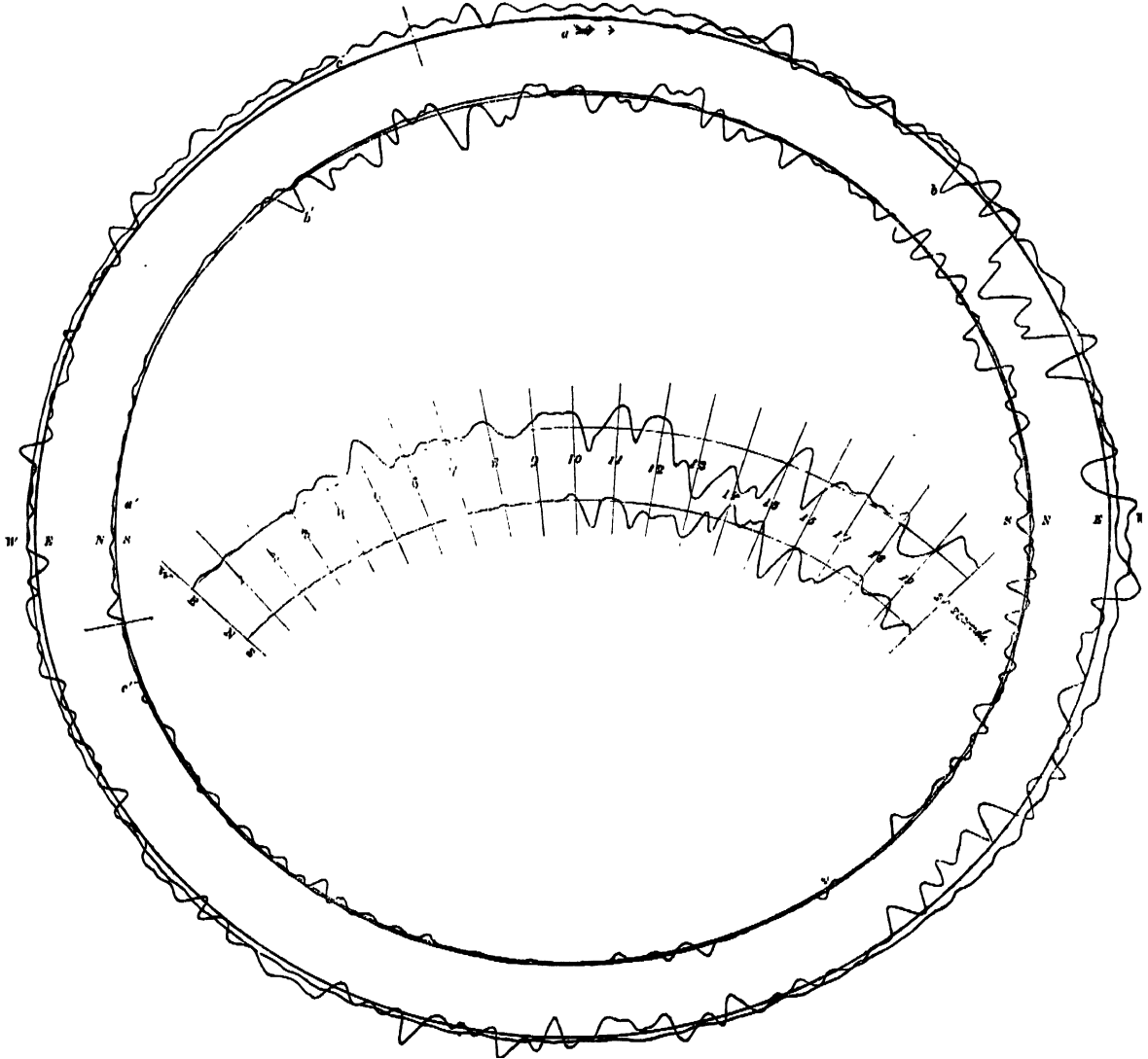

FIG. 7.

in amplitude and in period the successive waves were far from equal. A rough idea of the greatest velocity and greatest acceleration was, however, obtained by treating the greatest movement as a simple harmonic vibration, with a period of three-fifths of a second. This gave 1.6 mm. per second for the greatest velocity, and 16.4 mm. per second per second for the greatest acceleration, showing that bodies attached rigidly to the earth's surface must have experienced a horizontal force equal to about one-sixth-hundredth of their own weight. In three of the five earth-

<sup>1</sup> Continued from p. 159.

quakes recorded in the same month the greatest range of motion was less than one-fifth of a millimetre. In all of them there were many and unequal vibrations, but in none was there any single impulse prominently greater than the other movements.

Later observations showed that these were fairly repre-

<sup>2</sup> For a fuller account of the methods and results of these observations the writer may be permitted to refer again to his memoir on Earthquake Measurement, published as No. 9 of the *Memoirs of the Science Department of the University of Tokio*.

<sup>3</sup> Described in the *Transactions of the Asiatic Society of Japan*, vol. ix. p. 40.

representative of a very large proportion of the earthquakes which occur so frequently in the Plain of Yedo. Earthquakes of this class do no damage to buildings, but they are strong enough to make their presence felt by the shaking and creaking of houses, and even, in the night, to startle residents out of sleep. Lamps and other pendulous bodies are frequently set into considerable oscillation through the long continuance of the disturbance, the period of some consecutive vibrations of the ground being nearly uniform and equal to the free period of the lamp. The shaking lasts rarely less than one and sometimes as much as ten minutes.

In some cases, however, the amplitude of the earth's motion is considerably greater; occasionally it rises to 5 and even 7 mm. With such an amplitude as this, and with the ordinary frequency which the earthquake waves have, the shock is more or less destructive—walls are cracked and chimneys are overthrown. The writer's observations do not include any earthquake of first-rate violence, but they show by several examples that in the alluvial soil of Tokio a sufficiently alarming and even damaging earthquake may occur, in which the range of horizontal motion is less than a single centimetre.

In the Yedo earthquakes the vertical motion is generally much less than the horizontal, and, as a rule, forms an unimportant part of the disturbance.

Fig. 7 is a copy, reduced to about half size, of the record of one of these more considerable earthquakes (on March 8, 1881), traced by a pair of horizontal pendulums on a revolving plate. The inner circle shows the N.S. component, and the outer circle the E.W. component of the displacement. The records begin simultaneously at the points marked  $a'$  and  $a$  respectively, and extend in the direction of the arrow over nearly two complete revolutions of the plate. At the point marked  $c$  in the outer circle, when the earthquake oscillations were slowly dying away, the writer (who happened to be present) withdrew the plate, to prevent the later portions of the record from confusing the earlier portions. By this time the earthquake had lasted for two minutes and a half, and some 200 vibrations had been registered. The motion, as recorded, was exaggerated in the ratio of 6 to 1; hence in the diagram as it appears here the displacements are nearly three times the natural size.

For the sake of exhibiting some interesting features of this earthquake more clearly, the records of the two components during the first twenty seconds of visible motion have been reproduced in the centre space of the diagram in such a manner that simultaneous parts of both are on the same radius. The short radial lines mark seconds of time. It will be seen that for three seconds the motions were very minute; then the E.W. seismograph became pretty sharply disturbed, but the other component was scarcely visible until the tenth second from the beginning.

During the tenth and eleventh seconds the phases of the two components agree in the main, but they soon diverge; and in the fifteenth second, when the motion is greater than at any other part of the whole disturbance, they differ by about a quarter of a period. Hence at that time points on the earth's surface were vibrating not in a rectilinear path but in *loops*. This is strikingly shown by Fig. 8, which shows the path (exaggerated in the ratio of 6 to 1) of a point on the earth's surface, during three seconds at this epoch in the disturbance. Starting from  $p$  at 13.7 seconds from the beginning of the earthquake, a surface particle described the tortuous path shown in the figure, and reached  $q$  three seconds later. Similar rapid changes of phase-relation occur throughout the rest of the disturbance, and in the slowly dying oscillations with which the earthquake drew to a close the writer noticed one of the pointers moving vigorously when the other was nearly at rest, and *vice versa*.

The evidence, first clearly given in this earthquake, of the non-rectilinear character of the ground's motion, was

confirmed by very many later observations. In fact in every case where the records were sufficiently large and well-defined to admit of a satisfactory comparison of the phases of the two components, the same thing was exhibited. And not only in those cases, but even in very minute earthquakes, instruments having two degrees of horizontal freedom, such as the duplex pendulum, showed in the most direct manner that the earth's movements consisted of a multitude of twists and wriggles of the most fantastic character.

An excellent example of a still sharper earthquake is given in Fig. 9—a record (reduced to half size) given by two horizontal pendulums with a multiplying ratio of four to one on a plate which was turning once in fifty-four seconds. The beginning of motion can be detected on the outer circle at  $a$ . At  $b$  and the corresponding point  $b'$  it increases somewhat suddenly, and during the next few seconds we have the principal motions, followed during many minutes by a long trail of lesser irregular oscillations, in which a marked lengthening of period may be detected towards the close. To allow the phase-relation during the principal part of the shock to be examined, lines (numbered 1 to 16) have been drawn by the aid of templates through corresponding points in the two records. An examination will show that the phase-relation changes: in fact when the two components are combined the movements are found to be loops, agreeing very closely with the larger loops of Fig. 10, which is a "static" record of the same earthquake given by the duplex pendulum. In a

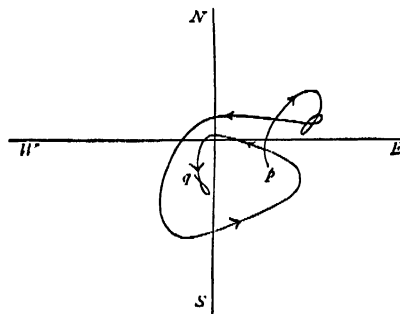

FIG. 8.

part of Fig. 10 the motions are so numerous and so much distributed over all azimuths, that the film of lamp-black has been completely rubbed away from a portion of the plate which received this record.

It frequently happens in the record of an earthquake that the motions which are first recorded are rapid vibrations, of short period and small amplitude, which are immediately followed by larger and less frequent movements. Sometimes, indeed, the former appear as a ripple of small waves superposed on larger ones. But in all cases where the short-period waves can be detected they die out early, and the later part of the earthquake consists of relatively long-period waves alone. Records of this class are exceedingly suggestive of the arrival of first a series of normal waves (that is, waves of compression and extension), constituting the rapid tremor, and then a series of transverse waves (that is, waves of distortion), forming the principal motions of the earthquake.

In fact it is difficult to explain the rapid changes of phase in the two components, or, in other words, the curved character of the horizontal movement, which most if not all the recorded earthquakes exhibit, otherwise than by supposing that the principal movements are transverse waves occurring in a plane not very much inclined to the horizon, and this conclusion is supported by the smallness of the vertical component.

It is true that the appearances presented by the diagrams could be accounted for by assuming the presence,



together, of normal and transverse waves, with a nearly horizontal direction of propagation; but in that case we should expect to find normal waves occurring alone at the beginning of the earthquake with much greater amplitude than they actually have. Other still less probable solutions might be referred to; but it is safe to say that the evidence furnished by these observations goes far to prove that the earthquakes of the Plain of Yedo consist chiefly of distortions, not compressions, of the ground, and emerge at Tokio in a direction not very far from vertical.

In the older seismology it was generally assumed not

only that an earthquake consists mainly of one impulse, but that the motion of the ground has a definite direction, and that that is the same as the direction of propagation of the wave. All three assumptions were false. An old piece of seismic apparatus, based on these ideas, was a group of columns of various heights standing on a plane horizontal base. These were intended to show the direction and "intensity of the shock" by falling over. It is clear enough, however, that no appliance of this kind can give intelligible results from earthquakes of such complexity as those described above. The very word

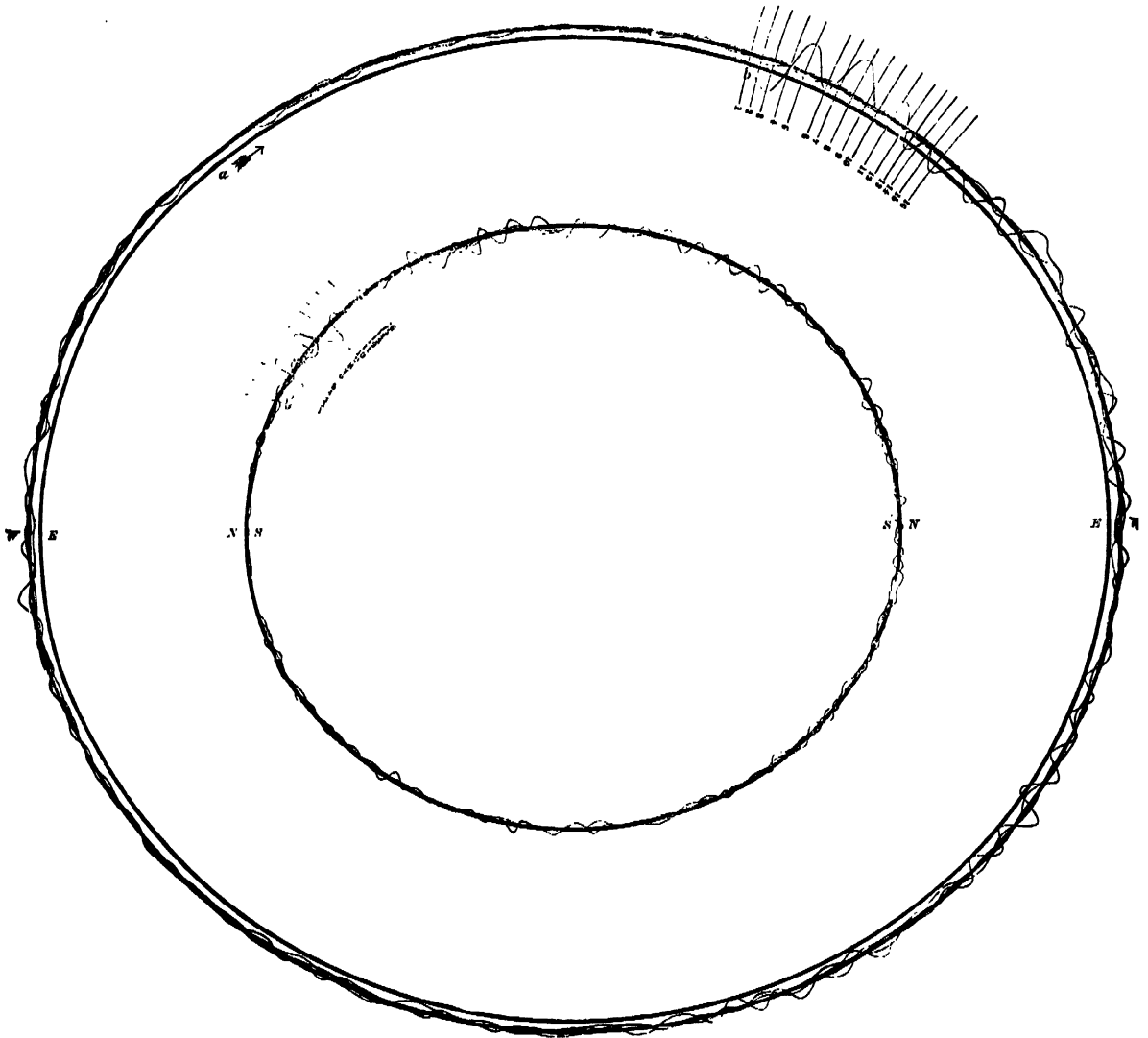

FIG. 9.

"shock," accurately as it describes the feeling produced by an earthquake, is a singularly inappropriate name for what an apathetic seismograph records.

As evidence of the accuracy of the apparatus by which the foregoing results were obtained, it should be mentioned that the records given at the same place by different instruments during the same earthquake were found to agree remarkably well. Further, the instruments were tested experimentally by placing them on a shaky table, and obtaining, side by side, two records of table-

quakes, one from the so-called "steady-point" of the instrument, and the other from a point in a fixed bracket projecting from a neighbouring wall, and known to be truly steady. When the table was shaken in such a way as to give records resembling those of actual earthquakes, the agreement of the two showed conclusively that the steady-point of the instrument did remain very nearly undisturbed, and that the records were in all important particulars substantially correct.

We have then the means of accurately observing the

nature of the surface motion at an earthquake observatory. But this of itself tells us nothing of the speed and direction of transit of the disturbance, particulars which are only to be learnt by connected observations made at several stations. Any one earthquake, as a whole, lasts far too long and begins too gradually to admit of the measurement of time-intervals between its arrival at different points, but if we can identify any single vibration in the records given at several stations—spread over a moderate area, and connected telegraphically with each other—the problem admits of a fairly easy solution. A recording seismograph at each station will give a complete record of the earthquake as it appears there, and if, during its progress, time signals be sent from one station and marked on all the revolving plates, it will be possible to



FIG. 70.

determine the differences in time of arrival of the same phase of the same wave at the successive stations in the group. From this, if the stations be sufficiently numerous, the speed and direction of transit, and even the origin of the disturbance, may be found with more or less precision. But all this depends on our being able to recognise at the various stations some one wave out of the complex records deposited at each, and, especially in view of the curvilinear nature of the motion, it would be hazardous to say without trial whether this can be done. To ascertain whether it can be done, and if so to organise groups of connected stations to carry out the scheme roughly sketched above, should be the next step in observational seismology.

J. A. EWING

University College, Dundee

NOTES ON A FEW OF THE GLACIERS IN  
THE MAIN STRAIT OF MAGELLAN MADE  
DURING THE SUMMERS OF 1882-83 IN  
H.M.S. "SYLVIA"

THE western part of the main Strait of Magellan, to which my remarks are confined, lies between rugged and abrupt mountains, of rock mainly crystalline, but in parts of slate.

The highest peaks are not over 4500 feet high, and the height of the snow-line is about 2700 feet. The land is cut up into small areas by numerous and tortuous channels, and, on the southern side certainly, no large masses of land exist. The mountain ridges are mostly sharp and steep, and afford but little area for snow to lie in quantities, but wherever a mountain slope is moderate, there it accumulates, and forms *névé*, which may or may not descend to lower levels.

From this it will be seen that the glaciers spoken of are small, only one snow-field, the "Northbrook," being of any size. Much larger glaciers of course exist in these regions, but were not in my beat, lying either to the south about Mount Darwin and Mount Sarmiento, 7000 feet high, or to the north on the mainland bordering the western channels.

Some ice-masses are ridiculously small, one I remarked, at the end of summer, on a ledge a little below a very sharp ridge 2700 feet high, was not probably larger than 10,000 tons. It lay entirely bare of snow on the southern or shady side of the ridge, and was of blue ice.

It is evident that it is the enormous amount of the supply of material which accounts for the existence of glaciers from such small origins, and in fact the deposition of snow is going on all the year round for the majority of hours out of the twenty-four. The winds are eternally

from the western quarter, are usually fresh, and, arriving moist from the Pacific against the rampart of mountains, rush up their western slopes into the colder regions, where constant condensation takes place. During my stay—about eight months—the summits of the higher snow-fields (3500 to 4500 feet) were only seen twice or thrice, so continually are the mists around them.

The daily duration of rain at the water-level during the *Sylvia's* stay of about eight months west of Cape Forward was eleven hours out of every twenty-four. The quantity corresponded to a yearly fall of 180 inches.

Though the mean temperature for the year is low, the range, summer and winter, is very small, so that flowering plants which grow on the borders of the glaciers and on exposed hills perish in England, from inability to withstand the sudden changes and lowness of the winter temperature.

The inference would seem to be that a Glacial period need not so much depend upon extreme cold as on an unlimited condensation with an equable temperature, low enough at moderate altitudes to form snow.

The glaciers are nearly entirely devoid of erratic blocks or surface moraines. Coming, as they do, over everything, down a hill-side, there is seldom an overhanging mountain to discharge blocks; where there is, the rock is so solid that the very slight changes of temperature (for the sun has no power here) is not sufficient to disintegrate it. Even the glaciers therefore that descend nearly to the sea are quite clean and spotless to the very end.

I could never make out any raised beaches, nor other signs of former lower level of the land; all the evidence is the other way. No beaches exist at the water-level of the present day. There is not enough sea in these confined channels to wash away the land, even if it was of a softer nature. The steep rocky mountain-sides dip clean into the water nearly everywhere. Thick moss covers the hill-sides wherever it can get a hold, so that it is not easy to see the true contours of them, and a more experienced eye than mine might perhaps detect a raised beach where I have failed to do so.

Glacier from Mount Wharton

Mount Wharton, 4400 feet high, on the south shores of Long Reach, sends down what I consider a rather remarkable glacier, despite its small size.

The upper part of the mountain, of a tolerably gentle slope, is of an area of about four square miles. This terminates everywhere in steep precipices, over which in different directions the blue ice, which can be seen lining the edge, tumbles, and forms *glaciers remanés* in hollows at lower levels in several places. On the south-eastern side only is a steep slope, down which, after a series of ice-falls, a leg of glacier, one-third of a mile wide, and one mile and a half long, extends to within 150 feet of the sea-level, and a quarter of a mile from the shore. At its end it abuts against a hill, and from the fact of the ground sloping away on either side from this glacier leg, it appears that this slope is a ridge, down which the glacier comes, as it were, astride. Where it strikes the hill, it divides, and sends a final short leg towards the sea on either side of the peninsula formed by the hill.

The slope of the lower part of the glacier is 15°, and it is much crevassed, and squeezed into pinnacles and ridges, so that, when tolerably clear of snow, it looks like frozen waves.

There is no moraine on it, and, wherever I could see, it lies on the solid rock, but a few stones are carried along at the bottom of the ice, and, at its end, where it abuts against the hill, the latter is a mass of loose rounded stones (very few angular ones), up to the limit occasionally reached by the glacier, which is well and curiously marked by a narrow belt of trees, growing on the edge of the tumbled stone moraine. Behind them the hill is of solid rock, bare or moss-covered (see illustration).

The side limit of the glacier, where it sometimes flows down the slope on its right and left, is also marked by a similar line of trees, the intervening space of about 300 yards being partly strewn with loose stones and coarse gravel, and partly perfectly bare, highly polished, striated rock. This rock has a somewhat remarkable appearance, as it is composed of a fine dark stone (a metamorphosed slate?) with intrusive parallel veins of white crystalline rock. The bands of black and white are very even in width, and there is as much of one rock as the other, so that, as the strike of the veins is in the same direction as the flow of the glacier, they look, at a little distance, like gigantic striæ.

I marked the foot of this glacier in December 1882, and found by March 1883, after the summer, that it had retreated 30 yards. After the winter, I fully expected to find that it had again advanced, but in December 1883 the edge of the ice was 50 yards farther back than in the previous December. They reported a very mild winter at Sandy Point, but I was not prepared to find the glacier retreating throughout the year, as it was manifestly at its full limits not many years ago.

I could not procure any evidence as to its rate of motion. The sides are so broken up, by great pieces

falling off and slipping down the slope, that it is almost impossible to get at the main body of the ice to put a mark in.

The head of West Havergal Bay, into which the glacier stream falls, is filled with a level bottom of sand with about 10 fathoms of water over it. This has a very steep edge to the deeper part of the basin. I imagine this to have been the delta formed by the glacier stream, when the land was at a slightly higher level. It is very rare in the Straits of Magellan to have anything but uneven, rocky bottoms to these deep basins, and they are generally steep to the edge of the shore. I have only found these sandy flat bottoms in the vicinity of glaciers, and as a sandy flat always forms around the *embouchure* of the glacier streams, a subsidence of the land would account for the existence of flats under water.

The hill-sides around Havergal Bay, where bare, show glaciation to a height of about 700 feet above the present sea-level. I think the land must have been higher when the ice was at this height, as the channel just below some of these marked hills being 60 fathoms deep, it would require the glacier to be 1000 feet thick, which seems to me hardly possible with such a small area for the production of *névé* as there is now, even supposing a greatly



Havergal Bay, Strait of Magellan. End of Glacier from Mount Wharton.

increased fall of snow and a much lower average of temperature than at present.

I visited one of the *glaciers remaniés* on the north-west side of Mount Wharton. It lies in a hollow about 1500 feet above the sea, and at the foot of cliffs 1000 feet high or more, and is three-quarters of a mile long by 400 yards wide. It is an excellent example of regelation, as the fragments which form it must be dashed to small pieces in their fall. It was at the end of summer, and only insignificant bits were coming over the cliff from the ice-field above. These fell on the *glacier remanié* broken into minute fragments with a patter as of heavy hail. Larger masses would be similarly broken, and yet the ice-mass was as clear and compact as if it had never been disturbed.

There were signs here on all sides, in the striations and *moutonnée* shape of all the rock above it, that this reorganised mass was once much larger; and 500 feet below, on a tolerably level part of the otherwise steep hill-side, bordering the stream that issues from the glacier, were low lines of moraine that were evidently once at the lower part of its sides.

A snow-field on a flattish mountain 3100 feet high, near Mount Wharton, has no proper glacier, but the ice falls over precipices and forms *glaciers remaniés*.

#### Glacier from Mount Wyndham

Mount Wyndham, on the opposite side of the Strait to Mount Wharton, sends a glacier down a valley, but has no surface moraine nor blocks. Its length is about two miles and a half, and the width, at the bottom, half a mile. Like others, it is very steep, and its surface is broken into pinnacles with deep crevasses. As I never saw the landward side of Mount Wyndham, I cannot exactly say what other glaciers may take their rise in it, nor what the size of the snow-field may be, but it probably does not exceed more than four or five square miles.

The foot of the glacier is not more than 100 feet above the sea, and is half a mile from the head of Glacier Bay, in a broad flat between the mountain slopes. A thick belt of tangled forest intervenes. This glacier is much shrunken also, a wide space of ground, covered with rounded stones, sand, and gravel, extending all round the foot to the edge of the trees in front, and the hills at the sides.

Signs of glaciation are abundant about this glacier, at far higher levels than it now reaches. Glacier Bay itself has been filled with it. This is a deep basin (70 fathoms deep) with islands stretching across its entrance. Rock Island, the largest of these, is *moutonnée* to the top, 560 feet, and the striæ are plain to see on its smooth

precipitous sides. Several perched blocks stand on the mountain-sides about, but as I did not visit these, I cannot say whether they may not have simply come from the heights above, though their precarious positions would indicate not.

Outside Rock Island is another area of even, sandy, and muddy bottom, in from 10 to 6 fathoms water, with a steep edge to the deep water of the Strait, similar to that at the head of Havergal Bay. This, I take it, must have been formed by the glacier stream, and was once its delta when the land was higher.

A sandy flat, mixed with rounded stones, now surrounds the glacier stream where it falls into Glacier Bay, and only wants a subsidence of the land to convert it into a counterpart of Havergal Bay. I do not know how else to account for this flat outside Glacier Bay, which was as unexpected as it was welcome, since it forms one of the best anchorages in the Straits, where even bottoms for the anchors are at a premium.

#### Northbrook Glacier

A snow-field in King William's Land between Northbrook Sound and Beaufort Bay is the largest in these parts, but I do not know much of it. It lay unfortunately just outside my work, and was so uniformly covered with clouds that I only saw the summit once.

It has probably an area of from fifty to seventy square miles. It is a flattish mountain about 4500 feet high. The ice descends on all sides in a succession of ice-falls, exhibiting lines of blue ice, most beautiful to see, about two or three miles long. Only when within 800 or 1000 feet of the sea is a true glacier formed.

These glaciers at the head of Northbrook Sound reach to within 100 feet or so of the shore level. In Beaufort Bay I rather think they reach the water. In Northbrook Sound the glacier at a mile from the coast, is about a mile and a half wide, but it is shortly after broken by a protruding hill, and divides into two legs, each half a mile wide. This glacier was also much shrunken. It brings down no moraine, and flows over solid rock.

W. J. L. WHARTON

#### NOTES

THE Council of the Mathematical Society have awarded the first De Morgan Gold Medal to Prof. Cayley, F.R.S.

M. PASTEUR has been awarded a gold medal by the Société Centrale pour l'Amélioration des Races des Chiens for his work on rabies.

THE jury of the International Horticultural Exhibition at St. Petersburg have awarded a gold medal to Dr. Regel, Director of the St. Petersburg Botanical Garden. The other awards for scientific work were to Dr. Gobi, the Russian algologist, for his remarkable herbarium; to Mr. Hartnack, for his microscope; and to Countess Zichi for her picture representing the *Serapias*. A gold medal was awarded to the Japanese University of Tokio for its collection of fruits.

M. JAMIN has been elected Perpetual Secretary in the Section of Physical Sciences of the Paris Academy in succession to the late M. Dumas.

DR. ADAM PAULSEN has been appointed Director of the Danish Meteorological Institute in succession to the late Dr. Hoffmeyer. Dr. Paulsen was the Chief of the Danish Polar Expedition to Godthaab.

PROF. W. GRYLLS ADAMS, as President of the Society of Telegraph Engineers and Electricians, will hold a *conversazione* in the Museum, Physical Laboratory, and Art Galleries of King's College on Thursday evening, July 3, from nine to twelve o'clock.

BY invitation of the Executive Council of the International Health Exhibition, a conference of the Society of Telegraph Engineers and Electricians will be held in the Conference Room of the Exhibition, South Kensington, on Friday, July 4. The chair will be taken by Prof. W. Grylls Adams, F.R.S., President of the Society, at 11 o'clock a.m., when the following paper will be read and discussed: "On Electric Lighting in Relation to Health," by R. E. Crompton, member. An adjournment for luncheon will take place at 1.30, and at 2.30 the following paper will be read and discussed, viz.: "The Physiological Bearing of Electricity on Health," by W. H. Stone, M.A., M.B. Oxon, F.R.C.P., member.

A LARGE number of guests, including ladies, assembled by invitation of the President of the Royal Society at a *conversazione* held at Burlington House on Wednesday last week.

ARRANGEMENTS have been made by the Council of the Scottish Meteorological Society for the completion this season of the Observatory of Ben Nevis. The first portion of the Observatory was, it may be remembered, opened in October last, and since the observers went into residence continuous hourly observations have been made of the conditions of the atmosphere at the top of the Ben, with special reference to temperature, pressure, humidity, and motion. From the discussion of these, and what were daily made by Mr. Clement L. Wragge in the summers of 1881 and 1882, by the Secretary, Mr. Buchan, the Council have been fully confirmed in the high expectations they had formed concerning the value of a high-level station, both in its bearing upon general meteorological problems, and also with reference to possible forecasts for the British Islands. The problem, however, is great and many-sided, and is one which can only be solved after much patient investigation and labour. The additions to be made to the Observatory will just double its size, and enable the three observers—who during the winter have been considerably cramped in their one apartment—to work under more comfortable conditions. On the south of the present doorway there is to be erected a shelter for tourists. On the north side of the existing building there is to be erected a new sitting room or office, 15 feet by 13 feet, while off this apartment there will be two bed-rooms, each 9 feet by 7 feet. The office will be lighted by two windows; and in each bed-room there will be one window. Opening from the east side of the office is a short passage leading to an octagonal tower, the walls of which will be 6 feet in thickness, and its internal diameter 8 feet. The tower, which will be 25 feet high, will be divided into three apartments, the lower being a dark chamber for photographic purposes, the centre one a spare room, and the upper a depository for observing instruments. The stonework of the tower is carried up to the height of the ceiling of the second chamber. The upper room is a superimposed wooden cabinet, the exposed parts of which are covered with lead. The floor of this apartment is carried out over the stone walls and firmly fixed to the tower below by iron rods, and to the roof above by strong wooden braces, so that it cannot possibly be upset. In the upper chamber are four windows, one facing each of the cardinal points of the compass, and at one of these is a ladder leading down to the roof, so that, should the doorway be blocked by snow, this would form a means of exit for the observers; the ventilating and smoke pipes, which are contained in one casing, are carried up through the roof of the tower, while, rising 6 feet above the ventilator, will be two anemometers, specially constructed by Profs. Chrystal and Crum Brown, for continuously recording the direction and velocity of the wind. These instruments will be self-registering, the apparatus for this purpose being in the chamber below, where it will be accessible at all times. On the eastern face of the tower a door has been left, so as to provide for future extension for magnetic and seismic observations. The estimated cost of the

completion of the Observatory in the manner now explained will be 800*l.*, which is, however, irrespective of a heavy item of charge for conveying on horseback the materials to the top of the hill. It is understood that the cost of equipment and maintenance of the Observatory heretofore has been heavier than was anticipated. The directors intend shortly to make a fresh appeal for funds to the public, which will no doubt be as liberally responded to as was their last.

THE first annual conference of the National Association of Science and Art Teachers will be held in the Liverpool Institute, Mount Street, Liverpool, at half-past two on Saturday, June 21. Prof. Silvanus P. Thompson, D.Sc., will preside. The following arrangements have been made for the day's proceedings:— Meeting in the vestibule of the Free Museum, William Brown Street, at 10.30 a.m. The members and delegates will view the museum, library, and art gallery. At 12.5, train to Bootle from L. and Y. station, for Alexandra Dock, to view the National Liner *America*. Return per train to Liverpool, for refreshments and inspection of Liverpool Institute and School of Art. Business meeting at 2.30 p.m. Paper by Prof. Thompson at 7 p.m.

PROF. STRICKER of Vienna has in the press a work on which he has been engaged for some time. Under the title "Physiologie des Rechts" he has applied modern scientific methods to the investigation of ethical problems. The aim of the book is to examine the correlative conceptions of right and law in the light which is cast on them by the conceptions of development and of society as something more than a mechanical aggregate of independent units. The first part of the inquiry is psychological. The second treats of the relations of ethics to jurisprudence, dealing with the question of connection of right with might as part of the general problem of evolution. The third discusses the question of punishment and responsibility. The book is to be published by Toeplitz and Deuticke of Vienna.

WE have on several occasions drawn attention to the good work which is being done by the Royal Victoria Coffee Hall, Waterloo Bridge Road. The entertainments provided are healthy, instructive, and popular; among other items in the programme are lectures by some of our best known men of science. The undertaking is in want of funds to further extend operations, and those willing to contribute to a really good cause should communicate with Miss Cons at the Hall.

THE death is announced of the eminent scientific geographer, Dr. G. von Boguslawski; his "Handbuch der Oceanographie" has only just been published.

TORTOISES and snakes are intimately associated together in Chinese mythology and records of natural history, and hence one of the commonest emblems current in China, and a very favourite ornament, is a tortoise encircled by a snake. During the Chow Dynasty (B.C. 1122-255) these animals were chosen as emblems of martial security against attack, from the defences which nature has given them in the shell of the one and the scales of the other, and to the present day flags bearing a device in which they both appear as emblematic of this idea are usually carried by troops in the field. But it is further commonly stated as a fact that the greatest affection exists between these two creatures. Is there any ground for this last assertion? A passage in a letter lately published in the *China Mail* from a correspondent in Shanse seems to give a certain colour of probability to it. He says that one evening as he was walking on the bank of a certain river he saw a tortoise swimming across the current. Having his rifle with him he fired at the creature, upon which the tortoise dived under water, and a snake, cut in two by his bullet, floated on the surface. From the writer's account the snake appears to have been crossing the river on the back of the tortoise.

WE trust that the effort being made by the Sunday Society to obtain the opening of the Health Exhibition on Sundays will be successful. In the memorial of the Society to H.R.H. the Prince of Wales and the Executive Council of the International Health Exhibition, a letter is given from Sir Joseph Hooker to Prof. Tyndall, in which the former insists strongly on the beneficial results to the working-classes of the opening of Kew Gardens on Sunday. In this letter Sir Joseph Hooker says:—"If there is one matter that gratifies me more than another in respect of the administration of the Kew Gardens and Museums by the Government, it is the opening them to the public on Sundays. On no day of the week have we more interested visitors or more of that class which we should wish to see profiting by the instructive contents of this Institution. The Museums especially are crowded, and when it is considered that the exhibits in them are not of articles that strike the eye or gratify the senses of colour or form, the interest they excite is almost to be wondered at. The artisan classes are great frequenters of these Museums with their wives and families, and it is pleasing to see the delight with which the children recognise such articles as the sugar-cane, the coffee-plant, and its products, and the various implements used in their preparation, manufacture, &c. I should add that this interest in the instructive character of the Gardens is largely on the increase, and is manifest to the most careless observer. It is further accompanied by a marked improvement in the conduct of certain classes which were formerly troublesome in many ways and a nuisance to quiet visitors. It speaks volumes for the moral effect of the Sunday opening when I add that such classes no longer exist at Kew. Whether it is that such no longer come, or that coming they now behave themselves, is immaterial: the moral gain is great. During the last two years we have had in each year a million and a quarter of visitors, of whom the greater proportion are Sunday afternoon arrivals from every quarter of the Metropolis and its surroundings. Let the numbers speak for themselves:—1882, Sunday visitors, 606,935; week-days, 637,232; 1883, Sundays, 616,307; week-days, 624,182." Equally beneficial results, we are convinced, would follow the opening of the Health Exhibition on Sundays.

THE World's Industrial and Cotton Centennial Exposition, sanctioned by an Act of Congress of February 1883, and to be opened at New Orleans, December 1, proposes to bring together a magnificent international collection of plants and shrubs, in the largest conservatory ever erected, 600 feet in length, 194 feet in centre, with glass tower 90 feet in height, where Mexico and Central America will be the principal exhibitors. Six lakes will be contained in the grounds, round which will be groves of cedar, pine, pomegranate, magnolia, lemon, palm, orange, cocoa-nut, banana, &c. But the United States Bureau of Education in a preliminary circular calls attention to the very large and varied collection which will be found there of educational appliances of every description; plans of schools and methods of teaching all classes of scholars from the deaf and dumb or imbecile to the technical or university student; books in all their parts and stages; stationery, and materials for drawing, extending to photography; maps; instruments and apparatus mathematical, medical, and musical. The Bureau gives the managers of the Exposition credit for considering the improvement of schools as among the most beneficial results to be gained by their efforts.

THE Presidency of the Social Science Association for the ensuing year has been accepted by Mr. G. J. Shaw-Lefevre, M.P., First Commissioner of Works. The preparations for the Annual Congress, which is to take place at Birmingham from September 17 to 24, are being vigorously pushed forward by the different Local Committees, and a largely attended and success-

ful meeting is anticipated. It is sixteen years since the Association met for the second time in Birmingham, and twenty-seven years since it held, in 1857, its first meeting, which also took place in that town.

We learn from a communication of Dr. Glasenap to the Russian newspapers that there are in Russia the following private observatories: at Pervin, near Torjok, in the Government of Tver, belonging to General Maievsky; at Bunakovka, in the Government of Kharkoff, belonging to Prince Liven; and at Odessa, belonging to M. Gildesheim. A Polish gentleman, M. Wuczihowski, is building a private observatory at Belkave, near Breslau; and a Russian gentleman, W. P. Engelhardt, has a fine observatory at Dresden. The last is provided with an equatorial which has a 12-inch refractor, and is one of the most perfect telescopes. The equatorial is provided also with a 4-inch telescope with a large spectroscope. There is also a 6-inch searcher for comets, with a wide field of sight, and a selection of the best physical instruments.

The Rev. John Stevenson is preparing for publication, by subscription, through Messrs. Blackwood and Co., a "Flora of British Fungi (Hymenomycetes)," with illustrations by Worthington G. Smith, F.L.S. The author states that he has the co-operation of the most eminent mycologists. It may be added that the value of the "Flora" will be greatly enhanced by embodying the views of Fries, contained in his "Monographia Hymenomycetum Sueciæ," a work which cannot now be obtained, only 100 copies having been originally printed. The issue of the work will depend on a sufficient number of subscribers being received by an early date, in which case the first volume will be published without delay.

A GENERAL meeting of the Mineralogical Society will be held in the library, Museum of Science and Art, Edinburgh, on Tuesday, June 24, at 12 o'clock noon. The following papers will be read:—Forms of silica, by John Ruskin, D.C.L., Slade Professor at Oxford (communicated by the Local Secretary for Scotland); application of the periodic law to mineralogy, by Thomas Carnelley, D.Sc., F.C.S., Professor of Chemistry, Univ. Coll. Dundee (communicated as above); the origin of the andalusite schists of Aberdeenshire, by John Horne, F.R.S.E., H.M. Geol. Survey; on the occurrence of prehnite and other zeolites in the rocks of Samson's Ribs and Salisbury Crags, by Andrew Taylor, F.C.S., A.G.S.E. (communicated as above); on a new locality for zoisite, by W. Hamilton Bell, F.G.S.E. (communicated as above); on diatomaceous deposits in Scotland, by Prof. W. I. Macadam, F.C.S., Hon. Sec. G.S.E.; notes on the albertite beds of Strathpeffer, Ross-shire, by William Morrison, M.A., Academy, Dingwall (communicated as above); kyanite localities in the north, and staurolite from Presholme, Enzie, Banffshire, by Thomas Wallace, High School, Inverness; the crystallography of bournonite, by H. A. Miers, B.A., British Museum, Nat. Hist. Dept.; notes on the metallic veins of the Upper Hartz, Germany, by H. M. Cadell, B.Sc., H.M. Geol. Survey (communicated as above); Scottish localities for actinolite, by Rev. W. W. Peyton; on a peculiar development of crystals of tourmaline from Lockport, N.Y. County, U.S., by R. H. Solly, F.G.S.

FATHER DENZA, Director of the Meteorological Observatory of the Turin Exhibition, is taking steps for organising observations on board the Godard captive balloon, which ascends to an altitude of from 200 m. to 300 m. The principal scientific features of the Turin Exhibition are:—(1) The collection exhibited by Prof. Sylvestri, Director of the Etna Observatory, and containing a number of specimens of amber collected on this mountain. (2) The methods employed by M. de Rossi, head of the newly-created Seismographic Service for issuing warnings of earthquakes and describing the observed

phenomena. M. de Rossi has issued a catalogue of 200 pages octavo describing the principal objects exhibited, the instruments tried, the methods adopted, and the results arrived at. (3) An historical Borgho, exhibiting mediæval costumes, buildings, instruments, furniture, and methods of working. A number of people of both sexes wearing the costumes attend to this part of the Exhibition.

THREE Ministers inaugurated in state, on June 14, the National Exhibition of Rouen, which will be international for electrical purposes. In the official speeches allusion was made to the Universal Commemorative Exhibition which is to be held in Paris in 1889. The site selected is the celebrated Park of St. Cloud, and a Crystal Palace is to be built on the ruins of the old Imperial palace.

UNDER the auspices of the Norwegian Association for the Promotion of Fisheries an establishment for the hatching of cod and soles' ova has been prepared near Arendal in the Christiania Fjord. From the excellent results already obtained it has been decided to found another hatching station near Christiania.

A LARGE copper basin consisting of small pieces riveted together and several wooden kegs containing "bog butter" were recently found at a depth of 7 feet in a peat-moss, Kylealsin, Skye. The kegs are each hollowed out of a solid block of wood, and show traces of burning all over the surface. The largest measures 1 foot 7 inches in height and 3 feet 6 inches in circumference.

THE additions to the Zoological Society's Gardens during the past week include a Vervet Monkey (*Cercopithecus lalandi* ♂) from South Africa, presented by Mr. J. Bulteel; a Bonnet Monkey (*Macacus sinicus* ♀), a Macaque Monkey (*Macacus cynomolgus* ♂) from India, presented by the Committee of the Latimer Road Mission; two Black-eared Marmosets (*Hapale penicillata* ♂ ♂) from South-East Brazil, presented by Mr. J. H. Bentley; two Vulpine Phalangers (*Phalangista vulpina*) from Australia, presented respectively by Mr. McClellan and Mr. Jay; a Marsh Ichneumon (*Ilerpestes galera*) from South Africa, presented by Mrs. Frank; two Angolan Vultures (*Gypohierax angolensis*), a White-necked Stork (*Ciconia episcopus*), an African Tantalus (*Pseudotantalus ibis*) from West Africa, presented by Mr. Thomas J. Alldridge; a Spur-winged Goose (*Plectropterus gambensis*) from West Africa, presented by Mr. J. B. Elliott; two Mute Swans (*Cygnus olor*), European, presented by Mr. H. Welch Thornton; two Angulated Tortoises (*Chersina angulata*) from North Damara Land, presented by Mr. F. R. Hemming; a Slow-worm (*Anguis fragilis*), a Common Viper (*Vipera berus*), British, presented by Mr. T. E. Gunn; a Bonnet Monkey (*Macacus sinicus* ♂) from India, four Muscovy Ducks (*Coirina moschata*), five Royal Pythons (*Python regius*) from West Africa, deposited; an Echidna (*Echidna hystrix*), a Brush Turkey (*Tallegala lathamii*) from New South Wales, two Red-cheeked Colys (*Colius erythronelon*) from South Africa, four Bronze-winged Pigeons (*Phaps chalcoptera* ♂ ♂ ♀ ♀) from Australia, a Great-billed Parrakeet (*Tamnygnathus megalorhynchus*) from Ceram, a Mealy Amazon (*Chrysotis farinosa*) from South America, four White Storks (*Ciconia alba*), European, a Kingfisher (*Alcedo ispida*), British, purchased; a Collared Fruit Bat (*Cynonycteris collaris*), a Japanese Deer (*Cervus sika* ♀), six Chiloe Wigeons (*Mareca chilensis*), four Chinese Blue Magpies (*Cyanopollus cyanus*), bred in the Gardens.

#### OUR ASTRONOMICAL COLUMN

RECENT IMPROVEMENTS IN ASTRONOMICAL INSTRUMENTS. —Acting under the directions of the Secretary of the Navy, Prof. Newcomb last year visited the principal Observatories on the continent of Europe for the purpose of collecting information relating to the most recent improvements in astronomical

instruments and methods of observation; and in a Report which has been laid before Congress and printed he has embodied the main results of his journey. The establishments visited were the Observatories of Paris, Neuchâtel, Geneva, Vienna, Berlin, Potsdam, Leyden, and Strasburg, and the workshop of Messrs. Repsold at Hamburg. Prof. Newcomb acknowledges the cordial reception he met with from the directors and astronomers of the various observatories, and the facilities everywhere afforded him for the execution of his mission. Most interest attached to the great refractor constructed for the Observatory at Vienna by Howard Grubb of Dublin, which was completed in 1881, but, owing to various delays, had hardly been brought into active operation at the time of Prof. Newcomb's visit in April 1883. Nevertheless he was able to compare it in several respects with the great Washington telescope, which is of only one inch less aperture. He considers that "as a piece of mechanical engineering it reflects great credit upon its designer and constructor." The chief drawback he remarked, the reasons for which were not evident either to him or to Dr. Weiss, the Director of the Observatory, consisted in the failure of the friction-rollers for easing the motion in declination; this motion was found much more difficult than in the case of the Washington telescope. Prof. Newcomb also points to the absence of any rough setting either in right ascension or declination, and the impossibility of seeing the pointing in declination except when the observer was at the eyepiece. With regard to the objective he considers, from such observations as he was able to make, that, "if any defects exist, they are so minute as not to interfere in any important degree with the finest performance of the instrument," and its proper figuring is rightly considered the most difficult task in the construction of a large telescope. In the workshops of Messrs. Repsold at Hamburg Prof. Newcomb had the advantage of meeting M. Otto Struve, and discussing with him the arrangements for mounting the 30-inch refractor intended for the Imperial Observatory at Pulkowa, the most striking feature in which is the absence of friction-rollers from the declination axis; he describes the system of wheelwork destined to obviate the difficulty of turning so large an instrument either by hand or a rope attached to the two ends of the axis, as at Washington and Vienna, owing to the amount of the friction. The eyepiece micrometers, as now constructed by the Repsolds, are commended for their rapid and convenient use. Amongst his general practical conclusions Prof. Newcomb expresses the opinion that in the mounting of instruments of the larger size, in order to secure necessary stiffness with the least weight, the axes should be hollow. He does not consider that it is worth while to attach friction-rollers to the declination axis, unless further experiment should show that they can be rendered more effective than in the Vienna equatorial. The old system of attaching a single finder to that side of the telescope which is opposite the declination axis, he remarks, is insufficient in the case of a large instrument, owing to the necessity of setting the opening in the dome not only to the telescope but to the finder, and suggests the desirability of adopting the plan in the Vienna instrument, which has two finders, the one above and the other below the telescope when in the meridian—a plan obviating all difficulty. The Report further explains the principle of the equatorial *coudé*, or elbow-shaped equatorial, of the Paris Observatory. The Strasburg meridian-circle, "commonly considered to embody the latest conceptions in astronomical mechanics," is noticed in some detail; Prof. Newcomb thinks a degree of stability has been secured in it which has never before been reached, and he was at much pains to obtain data for comparing the instrument with the meridian-circle at Washington; its general design he describes as similar to that of the great meridian-circle at Harvard College Observatory, which was constructed by Troughton and Simms of London. The reader must be referred to the Report for other particulars bearing upon meridian instruments.

**THE ASPECT OF URANUS.**—In a note communicated to the Paris Academy of Sciences on June 9, MM. Henry state that, observing on very fine nights with the 15-inch refractor, they have satisfied themselves of the existence of two gray belts, straight and parallel, and placed almost symmetrically with respect to the centre of the disk of Uranus, and that, by measures of their direction, they have found an inclination of about 41° to the direction of the orbits of the satellites; they assume that the planet's equator is in the direction of the belts. Astronomers will probably look for confirmation of such an anomaly to our larger instruments.

### THE CONTINUITY OF THE PROTOPLASM THROUGH THE WALLS OF VEGETABLE CELLS

AMONG the numerous generalisations of modern botany there are perhaps few that promise to have more important consequences than the recent statements to the effect that the protoplasmic contents of the cells of plants are not entirely shut off from one another by the cell-walls, but that arrangements exist of such a kind that more or less delicate strands of protoplasm pass through from one cell to another, piercing the cell-walls either at numerous points at certain thinner spots, or simply here and there.

Th. Hartig in 1837 distinguished certain constituents of the bast of phanerogams which we now know as sieve-tubes. Investigated later by the same observer and by Mohl, Nägeli, Sachs, and Hanstein, the question as to whether the septa between the cylindrical constituents of these tubes are really perforated, or simply studded with thin pits, was set at rest by the demonstration that strands or cords of protoplasmic substance pass through definite pores or passages in the septa or cell-walls. This discovery then became common property, abundantly confirmed, and is now practically demonstrated by students in every properly conducted botanical laboratory: it remained somewhat isolated for many years, however.

In 1880 the botanical world was startled by Tangi's discovery that the cells of the endosperm of certain seeds (*Strychnos*, *Areca*, &c.) present a similar feature—that delicate filaments of protoplasm traverse the cell-walls through fine perforations, and so place the protoplasmic contents of the cells in direct continuity one with another.

In 1882 Gardiner showed that a similar continuity of the protoplasm exists between the cells of the motile organs of certain sensitive plants, and there can be no doubt that the communication thus established through the cell-walls is instrumental in causing the propagation from cell to cell of the stimulus which induces the movement. It thus becomes established that the cell-walls of plants can no longer be regarded as entirely separating off the contents of one cell from those of another; but that, in many cases at any rate, the idea of the individuality of the vegetable cell becomes as difficult to maintain as did that of animal cells after the first struggles which resulted in the overthrow of the old cell theory.

Since 1882, Gardiner has succeeded in extending his results, and has shown that the cells of numerous other parts of plants are in continuity in the same manner, by strands of protoplasm passing through the cell-walls. These researches are, moreover, confirmed by Russow for certain cells of the parenchyma of bast and medullary rays; and there seems little need of hesitation to accept generally the view that the cells of plants are not closed sacs as was formerly believed, but are provided with passages through their walls, through which fine filaments of protoplasm communicate. Such at least results from the observations so far, and especially those of Gardiner, on the endosperms of a large series of plants. It may now be stated, however, that this is not the only evidence to be quoted in support of the above generalisation. In addition to the observations of Nägeli, Pringsheim, and others, pointing out that the protoplasm frequently adheres to the cell-walls so closely at certain places that it may be pulled out into strands, or even break away, leaving portions on the walls, Gardiner has also made observations which confirm this, and which strongly favour the view that the protoplasmic strands are held fast at the points where they traverse the cell-walls. Bower has also observed similar phenomena in the withdrawal of the peripheral protoplasm in plasmolysis.

Moreover, it has been pointed out that in the case of cells with very thick walls, the thin pits are normally found to meet on opposite sides; the same is the case with the radiating strands in *Vibror*, and where two opposite strands reach the common cell-wall at different angles, they nevertheless meet at a point.

So far, however, there is no evidence to show whether the continuity of the protoplasmic strands is maintained from the earliest stages, or is established later. This, however, is a very important question in connection with this subject, since the answer to it will materially affect our views as to the nature of the cell. If the cell-walls produced in vegetative division are not complete septa, but membranes filling up the interstices between continuous strands of protoplasm, then the continuity of the protoplasm through the wall of vegetable cells is simply to be regarded as an expression of the fact that the entire plant or

organ is practically one whole—one mass of protoplasm cut up into chambers which communicate with one another, and bounded by a membrane on the exterior. If, on the other hand, the communications between the protoplasm of neighbouring cells are only established after a complete septum has been formed, then it may or may not be that the above view holds,—so far as the continuity of the protoplasm of mature cells is concerned, it affords no conclusive proof against the very generally accepted idea that the plant consists of cell units aggregated into colonies, tissues, &c.

Turning for a moment to certain investigations which throw light on this matter from totally different directions, it will be seen that there is much to be said for the view lately stated by Sachs, and first hinted at by Hofmeister, that a much closer relation of cell to cell exists than can be well explained by the theory that a plant is a sort of cell republic, consisting of aggregated cell units.

Strasburger's well-known investigations on the process of cell division have led to the remarkable and startling result that the septum or partition-wall, formed when a cell divides, is in general a solid membrane built up by the aggregation of certain particles (microsomes) which become arranged into a plate (the cell-plate) at the equator of the dividing mass of protoplasm. These microsomes are conducted to this equator, and there mobilised by certain delicate fibrillæ in the protoplasm; these fibrillæ form the well-known spindle-like figure, and are continuous across the equator. If the microsomes travel along the fibrillæ from either side, and are fitted together between them, it seems difficult to doubt that the continuity of the protoplasm observed later simply depends upon the persistence of this primitive continuity, and such appears to be the case.

The proof that the primitively continuous fibrillæ remain continuous throughout does not yet exist however; and although it is so likely, it cannot be forgotten that protoplasm possesses a marvellous power of boring through and dissolving even adult cell-walls, as is evident in the exit of zoospores or the entrance of parasites through cell-walls, the formation of pollen-grains, &c.

But we have not yet exhausted the evidence for the view that the continuity of the protoplasm through the cell-walls of fully developed organs exists from the first.

The investigations of Strasburger, Schmitz, and others, on the protoplasm and nucleus of vegetable cells, have yielded the results that, in the first place, many cells believed to be devoid of nuclei really possess these structures, and often in enormous numbers; and, secondly, that many cases of division occur where a delicate cell-wall is formed in the equatorial plane between the two dividing nuclei, but only to disappear later. In many other cases no recognisable septum is formed at all. The internodes of *Chara* and the zoosporangia of *Achlya* may be cited as examples. In *Vaucheria*, *Caulerpa*, &c., again, we have plants each of which is practically a single cell with numerous nuclei: these nuclei divide as the cell grows, but no cell-walls are formed—the plant remains "unicellular."

If in such cases a septum were formed each time a nucleus divides, the protoplasm of the *Vaucheria*, *Caulerpa*, &c., would become divided up into cells; and if the septum in each division were incomplete only in so far that it allowed the fibrillæ of protoplasm which carry and arrange the microsomes to remain continuous through it, we should have essentially the condition of things demonstrated by Hanstein, Tangl, and especially by Gardiner.

But it would in such a case be imperative to express the facts in accordance with the primitive state of affairs—the protoplasm of the hypothetical plant would be cut up into compartments or cells, communicating throughout. Now it is just this view which Sachs has lately brought forward so clearly and ably. A multicellular plant does not grow and become complex because it consists of numerous aggregated cells which increase and divide; but it becomes multicellular because it grows larger, and partition walls are placed in the mass partly for mechanical purposes, partly to insure physiological distribution of labour.

It is impossible, Sachs thinks, to hold the view that *Vaucheria*, *Caulerpa*, and such plants have arisen by the degradation of ancestors which formed cell-walls. It is also suggestive that the nuclei in such "unicellular" plants are more closely packed at the growing apex of the vesicle; for we may thus understand how the growing point of an organ with a single large apical cell only differs in degree from one with numerous small apical cells.

The consideration of all these matters leads to the conviction that the cell-theory so long taught may have to be modified even

more than it has been during the last ten or twelve years; and that once more we are being driven back to that centre of all biological phenomena—the properties of protoplasm, multiple and various in degree and in kind as they are.

In conclusion, we cannot omit drawing attention to the improved and refined methods employed by the careful and skilled botanists of the younger school; and it is to be hoped that those who pass over the ground again will be at least equally well equipped. It is not only reagents that are necessary in such matters—critical power is indispensable as well as pure chemicals, as any one may convince himself by the study of the recent memoirs referred to, including the careful papers from Gardiner's hands. One more point may well be insisted upon here: the exhaustive study of a series of facts invariably brings them at length into relation with other facts, and where neither series is alone sufficient to base a scientific induction upon, converging groups of observations may result in the establishment of very important generalisations, leading to the recognition of still larger consequences. There can be no question of the intrinsic value of the observations on the continuity of protoplasm, apart from the information they give in connection with physiological matters; but it is certain that they gain immensely in scientific importance when looked at in the light afforded by recent discoveries as to the behaviour of the nucleus and protoplasm in cell division.

### NATIONAL WORK AND HEALTH

THE work of the International Juries was formally inaugurated at the Health Exhibition on Tuesday by H.R.H. the Prince of Wales. The principal address was given by Sir James Paget, who chose as his subject "The Relation between National Health and Work," especially as it may be shown in a few of the many examples of the quantity of work which is lost to the nation either through sickness or through deaths occurring before the close of what may fairly be reckoned as the working time of life.

Sir James Paget went on to say:—I think it may be made clear that this loss is so great that the consideration of it should add largely to the motives by which all people may be urged to the remedy of whatever unwholesome conditions they may live in. It is a subject which is often in the minds of the real students of the public health, but the public itself is far too little occupied with it.

In view of the national health and welfare, the pattern healthy man is one who lives long and vigorously; who in every part of his life, wherever and whatever it may be, does the largest amount of the best work that he can, and, when he dies, leaves healthy offspring. And we may regard that as the healthiest nation which produces, for the longest time and in proportion to its population, the largest number of such men as this, and which, in proportion to its natural and accumulated resources, can show the largest amount and greatest variety of good work.

Here let me insert, as an interpretation clause, that in all this and what is to follow the word "man" means also "woman," and "he" also means "she"; and that when I speak of work I mean not only manual or other muscular work, but work of whatever kind that can be regarded as a healthy part of the whole economy of the national life. And I shall take it for granted that a large portion of all national welfare is dependent on the work which the population can constantly be doing; or, if I may so express it, that the greater part of the national wealth is the income from the work which is the outcome from the national health.

It is a common expression that we do not know the value of a thing till we have lost it; and this may be applied to the losses of work which are due to the losses of national health. There are very few cases in which these can be estimated with any appearance of accuracy; but I am helped to the best within our present reach by Mr. Sutton, the Actuary to the Registry of Friendly Societies. In his office are the returns, for many years past, of the sickness and mortality among the members of a very large number of these Societies; and, among other things, there is recorded the number of days on which each member, when "off work" on account of sickness, received money from his Society. Hence Mr. Sutton can estimate, and this he has been so good as to do for me, the average number of days' sickness and consequent loss of work among several hundred thousands of the workmen and others who are members of these Societies. From the entire mass of these returns, he deduces that the



average number of days' sickness, per member, per annum, is very nearly a week and a half; and this agrees, generally, with the estimates made in other Societies by Mr. Neison and others. But the averages thus obtained include the cases of members of all ages, and among them many cases of chronic sickness and inability to work during old age. In order, therefore, to get a better idea of the actual annual loss of work through sickness, he has taken the published experience of the members of the large group of Friendly Societies known as the Manchester Unity of Odd Fellows; and then, on the fair assumption that the rates of sickness of the whole population during the working years of life would not be far different, he has calculated the following tables, showing the average annual rates of sickness of each person, enumerated in the Census of 1881, as living between the ages of 15 and 65:—

Ages.	Number of Males: Census of 1881 (England and Wales).	Weeks' Sickness per annum, according to the experience of the Manchester Unity.	Average Sickness per individual per annum (in weeks).
15-20	1,268,269	844,428	.666
20-25	1,112,354	820,183	.737
25-45	3,239,432	3,224,134	.995
45-65	1,755,819	4,803,760	2.736

All ages from 15-65 ... 7,375,874 ... 9,692,505 ... 1.314

Ages.	Number of Females: Census of 1881.	Weeks' Sickness per annum, according to the experience of the Manchester Unity.	Average Sickness per individual per annum (in weeks).
15-20	1,278,963	851,701	.666
20-25	1,215,872	896,685	.737
25-45	3,494,782	3,476,146	.995
45-65	1,951,713	5,368,229	2.751

All ages from 15-65 ... 7,941,330 ... 10,592,761 ... 1.334

Briefly, it appears from these tables that the average time of sickness among the male population during the working years is a small fraction more than 9 days each in each year—and that among the female population it is yet a small fraction more; the excess arising from the larger proportion of persons at the later ages. The result is that among males there is a loss of 9,692,505 weeks' work in every year, and among females a loss of 10,592,761 weeks. Thus we may believe that our whole population between 15 and 65 years old do, in each year, 20,000,000 weeks' work less than they might do if it were not for sickness. The estimate is so large that it must, on first thoughts, seem improbable; but on fair consideration I believe it will not seem so. For the members of the Manchester Unity who are in the working time of life the reckoning is certainly true, and it is founded on the experience of between 300,000 and 400,000 members. In respect of health they may represent the whole population at least as well as any group that could be taken. They are not very strictly selected, they are not picked lives, yet they are such as are able, when they are in health, to earn good wages or good salaries, and, as their prudence in joining this association shows, they are comparatively thrifty and careful persons. They do not, at all events, include many habitual drunkards, cripples, or utter invalids, or those who, through natural feebleness or early disease, or mere profligacy, cannot earn enough to become members or maintain themselves in membership. Neither do they include many of the insane or imbecile and idiotic, of whom there are, in our population, nearly 70,000 doing no work, and losing not less than 3,500,000 of weeks' work in the year.

It would be tedious to tell the grounds on which the estimate may be deemed too high, for just as many and as good could be told on which it might be deemed too low. And it is rather more than confirmed by some estimates of the annual sickness in other and very different groups of persons.

In the Army, at home, the average number of days' sickness in each year is, for each soldier, about 17; and as the number of the troops in the United Kingdom is more than 80,000, we have here a loss of about 200,000 weeks' service in each year.

In the Navy, on the home stations, the average number of days' sickness in each year has been in the last five years for each man nearly 16; so that for the total of about 20,000 men there is a loss of 45,000 weeks' service in each year.

The amount of sickness in the services thus appears much

higher than in the Friendly Societies. This is due, in great part, to the fact that a soldier or a sailor is often put off duty for a day or two for much less illness than that for which a civilian would "go on his club." Still, the one estimate may confirm the other; for the sickness in the Army and Navy is that of picked men, who were selected for the services as being of sound constitution, and who are in what should be the best working years of life: and if it includes many cases of sickness for only a day or two, it excludes nearly all cases of more than a few months, such as make up a heavy proportion of the average sickness in the Friendly Societies and in the general population.

And I may add that the estimate from these Societies, that 9 days in the year may justly be thought a fair estimate of the working time lost by sickness, is confirmed by the records of sickness among the 10,000 members of the Metropolitan Police Force; for among these, including cases of long illness such as are also in the Societies, the average is more than 9 days in the year.

I think, then, that we cannot escape from the reasons to believe that we lose in England and Wales, every year, in consequence of sickness, 20,000,000 of weeks' work; or, say, as much work as 20,000,000 of healthy people would do in a week.

The number is not easily grasped by the mind. It is equal to about one-fortieth part of the work done in the year by the whole population between 15 and 65 years old. Or, try to think of it in money. Rather more than half of it is lost by those whom the Registrar-General names the domestic, the agricultural, and the industrial classes. These are rather more than seven millions and a half in number, and they lose about 11,000,000 of weeks; say, for easy reckoning, at a pound a week; and here is a loss of 11,000,000/ sterling from what should be the annual wealth of the country. For the other classes, who are estimated as losing the other 9,000,000 weeks' work, it would be hard and unfair to make a guess at the loss in any known coin; for these include our great merchants, our judges and lawyers, and medical men, our statesmen and chief legislators; they include our poets, and writers of all kinds, musicians, painters, and philosophers; and our Princes, who certainly do more for the wealth and welfare of the country than can be told in money.

Before I speak of any other losses of work or of wealth due to sickness, permit me, as in parenthesis, to point out to you how very imperfectly their losses are told or even suggested by our bills of mortality. These, on which almost alone we have to rely for knowing the national health—these tell the losses of life; and more than misery enough they tell of; but to estimate rightly the misery of sickness and the losses of all but life that are due to it, we need a far more complete record than these can give.

Take, for example, such a disease as typhoid fever—that which Mr. Huxley has rightly called the scourge and the disgrace of our country. It has of late destroyed in England and Wales, among persons in the working time of life, nearly 4000 in the year. Its mortality is about 15 per cent., so that if in any year 4000 die of it, about 23,000 recover from it. Of these the average length of illness is, on the authority of Dr. Broadbent, about ten weeks. Here, therefore, from one disease alone, and that preventible, we have an annual loss of 230,000 weeks' work, without reckoning what is lost with those who die. And the same may be said of nearly all the diseases that are most prominent in the bills of mortality. The record of deaths, sad as it is, tells but a small part of the losses of happiness and welfare that are due to sickness. It is as if, in a great war, we should have a regular return of the numbers killed, but none of the numbers sick and wounded, though these, more than the killed, may determine the issue of the war.

Let me now tell of another loss of work and of money through sickness and early death. In all the estimates I have yet referred to, no account is taken of those who are ill or die before they are 15 years old. They are not reckoned as in the working-time of life, though in some classes many thousands of them are. [In the domestic, agricultural, and industrial classes of the Registrar-General nearly half a million of them are included.] And yet the losses of work due to sickness among children must be very large. Consider the time which might be spent in good productive work, if it were not spent in taking care of them while they are ill. Consider, too, the number of those who, through disease in childhood, are made more susceptible of disease in later life, or are crippled, or in some way permanently damaged; such as those who become deaf in scarlet

fever, or deformed in scrofula or rickets, or feeble and constantly invalid, so that they are never fit for more than half work or work which is only half well done. These losses cannot be counted, but they must be large; and there are others more nearly within reckoning; the losses, namely, which are due to the deaths of those who die young. It may justly be said that all that they have cost during their lives is so much money sunk; so much capital invested and lost. If they had lived to work, their earnings would have been more than sufficient to repay it; but they have died, and their cost is gone without return. The mortality of children under 15 in 1882 was nearly a quarter of a million: what have they cost? If you say only 8*l.* a piece, there are more than 2,000,000*l.* sterling thus lost every year. But they have cost much more than this, and much more still is lost by the loss of the work they might have lived to do.

I will add only one more illustration of these losses, which is always suggested by looking at tables of mortality. The deaths of persons between 25 and 45 years old, that is during what may be deemed the 20 best working years of life, are annually between 60,000 and 70,000; in 1882 they were 66,000. Think, now, of the work lost by these deaths; and of how much of it might have been saved by better sanitary provisions. If one looks at the causes of their deaths, it is certain that many might have been prevented, or, at least, deferred. Say that they might have lived an average of 2 years more; and we should have had in this year and last an increase of work equivalent to that of at least 6,000,000 weeks; as much, in other words, as 6,000,000 people could do in one week.

More instances of losses of work by sickness and premature death might easily be given, but not easily listened to in this huge hall. Let these suffice to show something of our enormous annual loss, not only of personal and domestic happiness—that is past imagining—but of national power and wealth. Surely we ought to strive more against it.

But, some may ask, can these things be prevented? are they not inevitable consequences of the manner of life in which we choose or are compelled to live? No; certainly they are not. No one who lives among the sick can doubt that a very large proportion of the sickness and the loss of work which he sees might have been prevented; or can doubt that, in every succeeding generation, more may be averted, if only all men will strive that it may be so.

Let me enumerate some of the chief sources of the waste as they appear to one's self in practice, or as one looks down a table of mortality.

Of the infectious fevers, small-pox might be rendered nearly harmless by complete and careful vaccination. Typhus and typhoid, scarlet fever and measles, might, with proper guards against infection, be confined within very narrow limits. So, probably, might whooping-cough and diphtheria.

Of the special diseases of artisans there are very few of which the causes might not be almost wholly set aside. Of the accidents to which they are especially liable the greater part, by far, are due to carelessness.

Of the diseases due to bad food and mere filth; to intemperance; to immorality; in so far as these are self-induced, they might, by self-control and virtue, be excluded. And with these, scrofula, rickets, scurvy, and all the widespread defects related to them, might be greatly diminished.

It can only be a guess, but I am sure it is not a reckless one, if I say that of all the losses of work of which I have spoken, of all the millions of weeks sadly spent and sadly wasted, a fourth part might have been saved, and that, henceforth, if people will have it so, a still larger proportion may be saved.

We may become the more sure of what may be done by looking at what has been done already. Let me show some of it; it will be a relief to see something of the brighter side of this picture.

In a remarkable paper lately read before the Statistical Society, Dr. Longstaff says:—"One of the most striking facts of the day, from the statistician's point of view, is the remarkably low death-rate that has prevailed in this country during the last eight years." In these years the annual death-rate has been less than in the previous eight years, in the proportion of two deaths to every 1000 persons living. The average annual number of deaths has been 50,000 less in the last than in the previous eight years. Doubtless many things have contributed to this grand result, and it is not possible to say how much is due to each of them; but it would be unreasonable to doubt that the chief

good influence has been in all the improved means for the care of health which recent years have produced. This is made nearly certain by the fact that the largest gains of life have been in the diminution of the deaths from fever, and of the deaths in children under 15 years old; for these are the very classes on which good sanitary measures would have most influence.

The annual number of deaths from typhus, typhoid, and the unnamed fevers, has been about 11,000 less than it was about 20 years ago. The annual number of deaths of children under 5 years old has been about 22,000 less than it was; and that of children between 5 and 15 has been upwards of 8,000 less.

These are large results, and though they tell of only deaths, yet they bear on the chief subject I have brought before you—the working power of the nation; for, however much of the average we might assign to improved methods of medical treatment of fever, yet the diminished number of deaths means a very large diminution in the total number of cases. The deaths during the working years of life were 6,500 less; and, this being so, we may hold that, if the average mortality was, say, 25 per cent., the diminution in the total number of cases must have been at least 25,000; and if we may believe, as before, that each of the-e involved ten weeks of sickness, we have, in these fevers alone, a clear saving of 185,000 weeks' work in every year.

And so with the diminution of the mortality among children, there must have been a greater diminution in the number of costly and work-wasting illnesses, and a large saving of money that would otherwise have been sunk. And not only so: but many of the children saved in the last eight years will become bread-winners or care-keepers; and who can tell what some of them will become? or what the world would have lost if it had lost them?

Let me add only one more reckoning. In a paper last year, at the Statistical Society, Mr. Noel Humphreys said "that if the English death-rate should continue at the low average of the five years 1876-80, the mean duration of male life in this country would be increased by two years, and that of female life by no less than 3.4 years as compared with the English Life-table." And he showed further that "among males 70 per cent. and among females 65 per cent. of this increased life would be lived between the ages of 20 and 60 years, or during the most useful period."

I should like to be able to tell the value in working-power of such an addition to our lives. It is equal to an addition of more than 4 per cent. to the annual value of all the industry, mental and material, of the country.

But some will say—admitting that it is desirable, seeing how keen the struggle for maintenance already is, can more than this be done? and the answer may be and must be, much more. In this, as in every case of the kind, every fruit of knowledge brings us within reach of something better. While men are exercising the knowledge they possess, they may be always gaining more. This Exhibition has scores of things which are better helps to national health than those of the same kind which we had twenty years ago, and with which the gains already made were won. If I were not in near official relation with the jurors I would name some of them: there are truly splendid works among them.

But do not let me seem to disparage the past in praising the present. It is difficult to speak with gratitude enough of what has been done, even though we may now see ways to the yet better.

Any one who has studied the sources of disease during the last thirty years can tell how and where it has been diminished. There is less from intemperance, less from immorality; we have better, cheaper, and more various food; far more and cheaper clothing; far more and healthier recreations. We have, on the whole, better houses and better drains; better water and air, and better ways of using them. The care and skill with which the sick are treated in hospitals, infirmaries, and even in private houses, are far greater than they were; the improvement and extension of nursing are more than can be described; the care which the rich bestow on the poor, whom they visit in their own homes, is every day saving health and life; and, even more effectual than any of these, is the work done by the medical officers of health and all the sanitary authorities now active and influential in every part of the Kingdom.

Good as all this work has been, we may be sure it may become better. The forces which have impelled it may still be relied on. We need not fear that charity will become cool, or

philanthropy inactive, or that the hatred of evil will become indifference. Science will not cease to search for knowledge, or to make it useful when she can; we shall not see less than we do now, and here, of the good results of enterprise and rivalry, and of the sense of duty and the sorrow for shame that there should be evil in the land.

What more, then, it may be asked, is wanted? I answer, that which I have tried to stir: a larger and more practical recognition of the value and happiness of good national health; a wider study and practice of all the methods of promoting it; or, at least, a more ready and liberal help to those who are striving to promote it. In one sentence, we want the complete fulfilment of the design of this Exhibition, with all the means towards health and knowledge that are shown in it, and with its handbooks, lectures, conferences, and the verdicts of its juries.

We want more ambition for renown in health. I should like to see a personal ambition for renown in health as keen as is that for bravery, or for beauty, or for success in our athletic games and field-sports. I wish there were such an ambition for the most perfect national health as there is for national renown in war, or in art or commerce. And let me end soon by briefly saying what I think such health should be.

I spoke of the pattern healthy man as one who can do his work vigorously wherever and whatever it may be. The union of strength with a comparative indifference to the external conditions of life, and a ready self-adjustment to their changes, is a distinctive characteristic of the best health. He should not be deemed thoroughly healthy who is made better or worse, more or less fit for work, by every change of weather or of food; nor he who, in order that he may do his work, is bound to exact rules of living. It is good to observe rules, and to some they are absolutely necessary, but it is better to need none but those of moderation, and, observing these, to be able and willing to live and work hard in the widest variations of food, clothing, and all the other sustentances of life.

And this, which is a sign of the best personal health, is essential to the best national health. For in a great nation, distributed among its people, there should be both muscular and mental powers suited to the greatest possible variety of work. No form or depth of knowledge should be beyond the attainment of some among them; no art should be beyond its reach; it should be excellent in every form of work. And, that its various powers may have free exercise and influence in the world, it must have, besides, distributed among its people, abilities to live healthily wherever work must be or can be done.

Herein is the essential bond between health and education; herein is one of the motives for the combination of the two within the purpose of this one Exhibition; I do not know whether health or knowledge contributes most to the prosperity of a nation; but no nation can prosper which does not equally promote both; they should be deemed twin forces, for either of them without the other has only half the power for good that it should have.

It is said, whether as fact or fable, that the pursuit of science and of all the higher learning followed on the first exercise of the humanity which spared the lives of sick and weakly children; for that these children being allowed to live, though unfit for war or self-maintenance, became thinkers and inventors. But learning is not now dependent upon invalids; minds are not the better now for having to work in feeble bodies; each nation needs for its full international influence both health and knowledge, and such various and variable health that there should be few places on earth or water in which some of its people cannot live, and multiply, and be prosperous.

If, therefore, we or any other people are to continue ambitious for the extension of that higher mental power of which we boast, or for the success of the bold spirit of enterprise with which we seek to replenish the earth and subdue it; if we desire that the lessons of Christianity and of true civilisation should be spread over the world, we must strive for an abundance of this national health, tough, pliant, and elastic, ready and fit for any good work anywhere.

### UNIVERSITY AND EDUCATIONAL INTELLIGENCE

CAMBRIDGE.—The Senior Wrangler, Mr. W. F. Sheppard, scholar of Trinity College, is a native of Australia; the Second Wrangler, Mr. W. P. Workman, also a scholar of Trinity, is the son of a Wesleyan minister.

The Natural Sciences Tripos, Part 1, contains the names of fifty-three men, of whom thirteen are placed in the first class; in addition six are allowed an ordinary degree, and six are excused the general examination. Two ladies attained a first class, four a second, and one a third.

In the Natural Sciences Tripos, Part 2, the first class includes the names of Messrs. Adami (Physiology) Christ's College; Chree (Physics), King's; Green (Botany, Physiology), Trinity; Head (Physiology), Trinity; Laurie (Chemistry), King's; Phillips (Botany), St. John's; Shipley (Zoology), Christ's; and Threlfall (Chemistry, Physics), Caius. The subjects mentioned are those for distinction in which the candidates are placed in the first class.

Mr. C. Potter will give lectures on Systematic Botany with field excursions and practical work, in the long vacation, beginning July 8.

### SOCIETIES AND ACADEMIES

#### LONDON

**Mathematical Society**, June 12.—Prof. Henrici, F.R.S., president, in the chair.—Mr. G. S. Ely, Fellow of the Johns Hopkins University, Baltimore, was elected a member.—The chairman announced that the Council had awarded the first De Morgan gold medal to Prof. Cayley, F.R.S.—A note on the induction of electric currents in a cylinder placed across the lines of magnetic force, by Prof. H. Lamb, was read in abstract.—Mr. J. Hammond gave some results of a paper which is shortly to appear in the *American Journal of Mathematics*.

**Linnean Society**, June 5.—Wm. Carruthers, F.R.S., vice-president, in the chair.—Messrs. J. Starkie Gardner, F.G.S., and J. H. Leech were elected Fellows of the Society.—Mr. J. Harris Stone exhibited and made remarks on specimens and photographs, viz. portion of the wood and of a remarkable wart (as large as a cocoa-nut) from the famous dragon-tree, *Dracana draco*, of the Canaries; photograph of the young dragon-tree planted by the Marquesa de Sawyal, and now growing on the site of the old celebrated tree of Oratova; photograph of the dragon-tree of Icod-de-los-Vinos in Tenerife; and a photograph of the Peak of Tenerife, showing how the "Retana" grows on the Cañadas.—There was shown, on behalf of Mr. R. Morton Middleton, a small branch of *Cotoneaster microphylla* grown at Castle Eden, Co. Durham, and a good example of fasciation in this plant.—Dr. R. C. A. Prior afterwards drew attention to specimens of the rare *Potentilla rupestris* from Craig Breidhin, Montgomeryshire, and of *Rumex sanguineus*, from the neighbourhood of Bristol, both freshly gathered by Mr. T. Bruges Flower, F.L.S.—A paper by Mr. G. Claridge Druce was read, in which he describes a new variety of *Melampyrum pratense*, L., and which he suggests should be known as var. *hians*.

—Prof. J. Martin Duncan read a paper on a new genus of recent Fungida allied to the fossil form *Micrabacia*; the genus being based on a specimen of coral obtained from shallow water in the Corcan Sea.—A communication was made by Mr. Arthur R. Hunt, on the influence of wave-currents on the fauna inhabiting shallow seas. The author refers to various physical data, among others quoting Prof. Stokes and Mr. T. Stevenson, the latter stating that a current of 0.6819 of a mile per hour will carry forwards fine gravel, and that of 1.3638 roll along pebbles an inch in diameter. From this and other facts Mr. Hunt argues that wave-currents do materially influence the marine fauna inhabiting shallow water, not only those of the tidal strand, but likewise those inhabiting the deeper sea-bottom. He adduces instances of animals living among or on rocks, and of those frequenting sand or other deposits, enumerating species of star-fish, mollusks, shrimps, crabs, and fish. He says that even the flat-fishes (Pleuronectidæ) seem to have changed their original forms and habits for the purpose of being able to live in shallow waters agitated by waves. Referring more particularly to species of *Cardium*, he endeavours to show how, under the influence of wave-currents, the variation of species may be promoted and even their local extinction brought about.—A paper was read, on the Longicorn Beetles of Japan, by Mr. H. W. Bates. In a former paper (in 1873), on the same subject, the author treated of 107 species, but now adds many new genera and 129 more species, or a total of 236 specific forms as at present known to belong to the Japanese fauna. This great accession is due to the later collections of Mr. Geo. Lewis, who made a second

visit to the islands in 1880-81. Mr. Bates, reasoning from this fresh material, is inclined to modify his previously-stated views as to the predominance of a supposed tropical element in the Longicorn group in question; the relative number of absolutely new genera now turning the scale in favour of Palearctic or Nearctic affinities.—The last zoological communication taken was on three new species of *Metacrinus*, by P. Herbert Carpenter, with note on a new *Mysostoma*, by Prof. von Graff. Mr. Carpenter describes *Metacrinus rotundus* from Japan, dredged there by Dr. Doderlein of Strasburg, and *M. superbus* and *M. stewarti*, two remarkable forms obtained by the Telegraph Company on picking up a cable near Singapore. The *Mysostoma curripedium* was found on the Japan Crinoid.

**Chemical Society, June 5.**—Dr. Perkin, F.R.S., president, in the chair.—It was announced that a ballot for the election of Fellows would take place at the next meeting.—The following papers were read:—On  $\beta$ -naphthaquinone, by C. E. Groves. In a preliminary notice read before the Society some time since (*Chem. News*, xliii. 267) the author mentioned that he had carefully repeated some experiments of Liebermann. In the present paper full details are given of the preparation of amido- $\beta$ -naphthol hydrochloride from  $\beta$ -naphthol orange by reduction with stannous chloride and with alkaline sulphides. This reaction is very inferior in simplicity and economy to the process originally proposed by Stenhouse and the author. Several improvements in the original process are suggested, and the author gives an account of some products obtained by the action of reducing agents on the nitroquinone.—On a by-product of the manufacture of aurin (part ii.), by A. Staub and Watson Smith. The authors have prepared a perfectly pure specimen of this product, phenylorthoaxalic ether; they conclude that it plays no part as an intermediate product in the formation of aurin. Analogous compounds with  $\alpha$ - and  $\beta$ -naphthols were prepared, but no compound with resorcinol could be obtained.—On calcium hydrosulphides, by E. Divers and Tetsukichi Shimidzu. When hydrogen sulphide is passed through milk of lime, the lime dissolves; by adding more lime, a solution is finally obtained, which, after decantation and cooling, deposits colourless prismatic crystals of the hydrosulphide; by the action of water on this body, calcium hydroxyhydrosulphide is formed. The authors find that hydrogen sulphide decomposes calcium carbonate. They have also studied calcium monosulphide and the formation of the thiosulphate from the hydrosulphide and the pentasulphide.

**Anthropological Institute, May 27.**—Prof. Flower, F.R.S., president, in the chair.—The election of F. C. J. Spurrell was announced.—Mr. H. O. Forbes read a paper on the Kubus of Sumatra. The Kubus are a nomadic race inhabiting the central parts of Sumatra. In their wild state they live in the deep forest, making temporary dwellings, consisting of a few simple branches erected over a low platform to keep them from the ground, and thatched with banana or palm leaves. They are extremely timorous and shy, so that it is a very rare thing for any of them to be seen, and if suddenly met in the forest by any one not of their own race, they drop everything and flee away. They cultivate nothing, and live entirely on the products of the chase. Their knives and the universal spear with which they are armed are purchased from the Malays, with whom they trade. They are of a rich olive-brown colour, and their jet-black hair, apparently far less straight than that of the village Malays, was always in a dishevelled state and in curls. The average height of the males was about 1'59 m. and that of the females 1'49 m.—Dr. Garson read a paper on the osteology of the Kubus.—Mr. Theodore Bent read some notes on prehistoric remains in Antiparos, and exhibited several specimens of pottery, some rudely carved marble figures, and a skull, from cemeteries in that island.

**Institution of Civil Engineers, May 20.**—Sir J. W. Bazalgette, C.B., president, in the chair.—The paper read was on the passage of upland water through a tidal estuary, by W. R. Peregrine Birch, M.Inst.C.E.

## CAMBRIDGE

**Philosophical Society, May 12.**—Mr. Glaisher, president, in the chair.—The following were elected Honorary Members:—On the Foreign List—A. Baeyer, Professor of Chemistry at Munich; Anton Dohrn, Director of the Zoological Station at Naples; Carl Gegenbaur, Professor of Comparative Anatomy in the University of Heidelberg; G. Mittag Leffler, Professor of

Mathematics in Stockholm; E. F. W. Pflüger, Professor of Physiology in the University of Bonn; Gustav Quincke, Professor of Physics in the University of Heidelberg; H. A. Rowland, Professor of Physics in the Johns Hopkins University, Baltimore, U.S.A.; Julius Sachs, Professor of Botany in the University of Würzburg; H. G. Zeuthen, Professor of Mathematics in Copenhagen. On the Home List—R. Stawell Ball, Astronomer-Royal for Ireland; W. T. Thiselton Dyer, Assistant Director of the Royal Gardens, Kew; J. Whitaker Hulke, ex-President of the Geological Society.

May 26.—Mr. Glaisher, president, in the chair.—Prof. E. Ray Lankester was elected an Honorary Member. Mr. S. L. Hart, St. John's College, was elected a Fellow.—The following communications were made:—On some irregularities in the values of the mean density of the earth as determined by Baily, by Mr. W. M. Hicks. The author showed that the numbers obtained by Baily for the mean density of the earth depended on the temperature of the air at which the different observations were made; and he exhibited a table showing that as the temperature increased from 40° F. to 60° F. the deduced mean densities fell continuously from 5'734 to 5'582. He considered several possible causes of error, but showed that they were either inadequate to explain the irregularities, or tended in the opposite direction. The only further suggestion that occurred to him was that Baily's personal equation was a function of the temperature, leading him, as his temperature rose, to estimate distances more liberally.—On some physiological experiments, by Dr. Gaskell.—On a method of comparing the concentrations of two solutions of the same substance but of different strength, by Mr. A. S. Lea.—On the many-layered epidermis of *Chtia nobilis*, by Mr. W. Gardiner.—On the possible systems of jointed wickerwork and their degrees of internal freedom, by Mr. J. Larmor.

## DUBLIN

**University Experimental Science Association, June 3.**—Dr. Tarleton, F.T.C.D., in the chair.—G. F. Fitzgerald, F.T.C.D., F.R.S., on Prof. Osborne Reynolds' mechanical illustrations of heat-engines.—J. Joly, B.E., on the eruption of Krakatoa.—The Cambridge Instrument Company's reflecting galvanometer was exhibited by Prof. Fitzgerald, and a portable calorimeter designed for approximately determining the specific heats of minerals, by J. Joly.—An apparatus for determining the latent heat of vaporisation was exhibited by F. Trouton. The chief gain in the use of the apparatus is, that to effect a determination by its means it is not requisite to know either the boiling-point of the liquid or the specific heat of the body in either the liquid or gaseous condition. Both of these are very irregular and extremely difficult to determine at temperatures approaching the boiling-point. The use of calorimeters is also avoided, often a source of serious error. In the vessel in which the liquid is placed there is a spiral of platinum or other substance unattacked by the liquid. On passing a current of electricity (the difference in potential being insufficient to decompose the body if a compound) through the spiral, heat is generated, and the liquid vaporised if at the boiling-point. According as the body is vaporised it is conducted away to a condenser, collected, and weighed. All sensible loss of heat is prevented by surrounding the vessel by a larger one full of vapour obtained by boiling some of the liquid itself in the bottom of the outside vessel under the same pressure as in the inner one; so that, if in any experiment the weight is determined of the liquid vaporised while a known quantity of electricity passes, the heat required to vaporise unit weight of the body can be deduced, the resistance of the spiral being also known. As the electrical measurements are difficult to make sufficiently accurate, it is simpler to compare the latent heat of the body with that of a liquid of which the latent heat is known. This may be easily effected by employing a second apparatus similar to the first, in which the liquid taken as the standard (say water) is put. The same current is passed through both spirals, so that the ratio of the latent heats may be deduced on weighing the quantities vaporised, if the ratio of the resistances of the spirals is known. This, if both liquids boil at nearly the same temperature, may be obtained by a previous experiment where one of the bodies is put into both apparatuses, the ratio of the resistances being that of the weights of the substance to be vaporised.

## EDINBURGH

**Mathematical Society, June 13.**—Mr. A. J. G. Barclay, vice-president, in the chair.—Mr. William Peddie read a paper,

illustrated by models, on the graphical representation of physical properties; and Mr. David Traill one on geometry from first principles.

## PARIS

**Academy of Sciences, June 9.**—M. Rolland, president, in the chair.—Remarks on the apparent contour of the planet Venus, based on the study of the photographic plates obtained at Puebla during the recent transit of Venus, by MM. Bouquet de la Grye and Arago.—Note on heavy ordnance in connection with the large gun (16 cm.) lately supplied to the Spanish Government by the Société des Forges et Chantiers de la Méditerranée, by M. Dupuy de Lome.—Memoir on the presence of manganese in plants and animals, and on the part played by this substance in the animal system, by M. E. Maumené. Tea and tobacco are found to contain the largest quantities of metallic manganese, which is on the whole injurious to animals, and constantly rejected by them, hence it should no longer be employed medicinally.—On the aspect of Uranus and the inclination of its equator, as observed at the Paris Observatory during the first days of the present year, by MM. Paul and Prosper Henry.—Note on the symmetrical functions of the differences in the roots of an equation, by M. J. Tannery.—Description of a dynamo-electric machine on a new principle, a model of which has been constructed by MM. A. Damoiseau and G. Petitpont. For this engine it is claimed that it does double the work of those now in use.—On the property of silver to absorb oxygen gas at high temperatures, by M. L. Troost.—Note on the action of the sulphuret of copper on the sulphuret of potassium, by M. A. Ditté.—On the solubility of the bromides, iodides, and chlorides of potassium, sodium, calcium, and other halogenous salts, by M. A. Etard.—Observations on some colloidal substances, by M. E. Grimaux.—Synthesis of pyridic hydrides, results of two years' researches with  $\beta$ -lutidine and  $\beta$ -collidine (boiling at 196° C.), derivatives of cinchona and brucine, by M. Oechsner de Coninck. These somewhat incomplete results are now published in consequence of the remarkable facts recently disclosed by MM. Hofmann and Ladenburg.—On tribenzoylmesitylene, by M. E. Louise.—On crystallised colchicine, by M. A. Houdés.—Experiments on manure artificially prepared with a view to determining the amount of loss of nitrogen sustained during the process of fermentation, by M. H. Joulie. The loss of nitrogen was found to be about 20 per cent., a proportion inferior to what takes place in practice.—Note on the minerals associated with the diamond in the newly-discovered diamantiferous district of Salobro, province of Bahia, Brazil, by M. H. Gorceix.—Anatomy of the Echinoderms; on the organisation of the Comatules, by M. Edm. Perrier.—On the constitution of the Echinoderms, by M. C. Viguier.—Objections to the theory that the Sahara was a marine basin during the Quaternary period, by M. G. Rolland. From more recent surveys in various parts of this region the author concludes that since the Tertiary period the Sahara was mainly dry land, while at the close of the Miocene all North Africa had been upheaved, and since then during the Pliocene and Quaternary the South Mediterranean coast-line has undergone no important modifications.—On the lesions of the nerve-ducts of the spinal marrow in sclerotic affections, by M. J. Babinski.—M. Jamin was elected Perpetual Secretary in the Section of Physical Sciences in place of the late M. Dumas.

## BERLIN

**Physical Society, May 23.**—Prof. H. W. Vogel reported on the final practical results of his researches conducted for many years on the means of photographing coloured objects in their natural shades. Sensitive plates are known to be affected only by the more refrangible rays, the less refrangible remaining inoperative. Hence, of coloured objects quite unnatural pictures are obtained, even the darkest shades of blue appearing as white; yellow and red, however bright and dazzling, as black; and so on. Starting from the idea that the sensitive collodium is affected only by such rays as are absorbed by it, Prof. Vogel had years ago been occupied with the attempt to render his plates sensitive to less refrangible rays, by alloying the silver coating with a substance capable of absorbing these rays. The results corresponded at once with this *a priori* assumption. In fact, plates so prepared invariably produced an effect in the solar spectrum wherever the absorption bands of the alloy were found. It was impossible, however, to obtain like results with artificial colours. Many colouring substances which, when blended with the collodium, beautifully reproduced the yellow of the solar

spectrum, were ineffective against the artificial and infinitely fainter yellow of painters. Prof. Vogel was induced constantly to resume these attempts by the progress made both in the preparation of photographic appliances and in the discovery of new organic substances possessing a power of absorption more intense and lying nearer to the yellow of the spectrum. He has thus at last succeeded in obtaining in eosine, and more especially its various derivatives, colouring substances which scarcely possess more than a broad absorption band in the yellow, and which led to the desired result. When these bodies were mixed in due proportion with the dry gelatine plates, the yellow of the coloured objects already appeared quite clear on the photograph; but the blue was still always brighter. No satisfactory result was obtained until Herr Vogel had inserted between the object and the camera a yellow glass, which partly absorbs the blue rays while leaving the yellow unimpaired. He now obtained photographs in which the blue, as well as the green and yellow, and partly even the red parts of the coloured objects, presented to the observer's eye the same vivid effects as the original. A series of photographs exhibited by Herr Vogel side by side with the original pictures attest the good results with which this method may be carried out in practice.—Prof. Landolt referred to the controversy between MM. Pasteur and Jungfleisch, the former of whom had obtained from the optically inactive racemic acid dextro-gyrate tartaric acid by the culture of *Penicillium*. This he explained by supposing that the mould assimilates the other constituent of the inactive racemic acid, that is, the lævo-gyrate tartaric acid, leaving the other constituent over, whereas Mr. Jungfleisch accounts for the elimination of the dextro-gyrate tartaric acid simply by its greater solubility. In support of Pasteur's view Prof. Landolt now adduced the experiment with amygdalic acid made last year by Dr. Lewkowitsch in his laboratory. Inactive amygdalic acid was by him, also by means of *Penicillium*, converted into dextro-gyrate amygdalic acid, which, jointly with the lævo-gyrate amygdalic acid formed from amygdaline, constituted inactive amygdalic acid, such as is obtained from prussic acid. Herr Landolt further reported that in his laboratory it had recently been demonstrated that tyrosine and leucine are optically active. Hence, according to the still unshaken theory of van 't Hoff, these substances must contain unsymmetrically united atoms of carbon.

## CONTENTS

## PAGE

The London Water Supply	165
Flowers and their Pedigrees	167
Our Book Shelf:—	
Herrick's "Wonders of Plant-Life"	168
Waters' "Histological Notes for the Use of Medical Students"	168
Letters to the Editor:—	
Pile-Dwellings on Hill-tops.—S. E. Peal. ( <i>Illustrated</i> )	168
Atmospheric Dust.—R. Brough Smyth	170
The "Red Glow" after Sunset.—Prof. J. P. O'Reilly	170
The Earthquake.—R. McLachlan, F.R.S.	170
Intelligence in Animals.—M.	170
Adolphe Wurtz and his Chemical Work. ( <i>With Portrait</i> )	170
African Exploration. ( <i>With Map</i> )	172
A New Astronomical Journal	173
Measuring Earthquakes, II. By Prof. J. A. Ewing. ( <i>Illustrated</i> )	174
Notes on a Few of the Glaciers in the Main Strait of Magellan made during the Summers of 1882-83 in H.M.S. "Sylvia." By Capt. W. J. L. Wharton, R.N., Hydrographer to the Admiralty. ( <i>Illustrated</i> )	177
Notes	179
Our Astronomical Column:—	
Recent Improvements in Astronomical Instruments	181
The Aspect of Uranus	182
The Continuity of the Protoplasm through the Walls of Vegetable Cells	182
National Work and Health	183
University and Educational Intelligence	186
Societies and Academies	186

THURSDAY, JUNE 26, 1884

## SCIENCE AND THE WOOLWICH AND SANDHURST EXAMINATIONS

IT will be known to most readers of NATURE that after 1884 considerable changes will be made in the various subjects in the examinations for admission to Sandhurst, and it is generally understood that an extension of similar changes to the examination for Woolwich is in contemplation. When these changes were announced, those interested in the matter at once saw that one of their chief effects would be to greatly discourage science teaching in our schools, &c., in consequence of the extremely low marks allotted to it under the new scheme. Representations were made on the subject at the War Office by the President of the Royal Society, and subsequently it was stated in the House of Lords, in reply to a question put by Lord Salisbury, that the final position of the subjects is still under consideration. As there is every reason to suppose that the object of the War Office authorities is to secure as good an examination as possible, and as they can have no possible reason for wishing to discourage scientific candidates only because they are scientific, it would seem that the present is a favourable opportunity for bringing the subject into public notice. The following are perhaps the most important points in connection with it:—

1. How far the choice of subjects made by the candidates has hitherto been affected by the marks allotted to them, and hence in what degree the new regulations or any similar regulations will influence science studies in our public schools.
2. How far it is true that science subjects have been good (?) cram subjects, since from the discussion in the House of Lords it appears to be considered by the War Office authorities that they have been good cram subjects.
3. To what extent the subjects examined and their grouping is at present satisfactory, and in what respects they would be better for amendment.
4. Whether the standard of the examination is, as has been urged by some, too high.

In the consideration of 1 and 2 the statistics of past examinations will give much help; 3 and 4 are, no doubt, to a greater degree matters of opinion.

I. As the result of tabulating the proportions of the successful candidates who have selected each subject in the competitions for entrance into Woolwich and Sandhurst during the years 1880, 1881, 1882, 1883, very interesting information has been arrived at, which is given in a condensed form in the tables below.

Only the selections made by successful candidates have been considered, for on the whole they will show best which subjects have been most conducive to success. And as the marks allotted to the subjects are different in the two examinations, they afford a good criterion by which to judge in what way marks have during the last four years affected the selection of subjects. Compulsory subjects are not included. The percentages relating to Woolwich are calculated from data which include all the examinations in the years 1830, 1881, 1882, 1883. Those

concerning Sandhurst are from data not quite so complete, but, as the larger tables from which these are taken exhibit considerable regularity, this is not of material importance.

		Mathe- matics	English	Latin	Greek	French	German	Experi- mental Scien...	Engl Geogr &c
SANDHURST	Marks allotted...	3000	3000	3000	2000	2000	2000	2000	2000
	Percentage of successful candidates taking the subject.....	70	91	73	22	91	25	8	10
WOOLWICH	Marks allotted...	4000	2000	2000	2000	2000	2000	2000	
	Percentage of successful candidates taking the subject.....	97	60				46		

The influence of the maximum marks allotted to the subjects is perceptible at a glance. The increased marks given for mathematics in the Woolwich competition raises the proportion of those who take up that subject from 70 per cent at Sandhurst to 97 per cent. at Woolwich. Similarly English and Latin are selected by 60 per cent. and 52 per cent. at Woolwich, where the maximum is 2000, against 91 per cent. and 73 per cent. at Sandhurst, where the maximum is 3000. And Greek, German, and Experimental Science are taking 29 per cent., 46 per cent., and 22 per cent. at Woolwich, where there is the same mark as for English and Latin, against 22 per cent., 25 per cent., and 8 per cent. at Sandhurst, where English and Latin have the higher mark of 3000, and the others only 2000. The positions of French is peculiar, but we observe the relatively better marks given in the Woolwich competitions has its effect, though there is less room for much increase. The selection of French by so large a proportion of the successful candidates both at Sandhurst and Woolwich, is probably largely due to the circumstance that it is taught in nearly all divisions of our schools, and that it is often begun earlier than Greek, German, and science, so that when candidates select the subjects they will study for these competitions, they already very often have made some progress in French and much less in the other subjects. Statistics, however, seem to show that French is more liberally marked than some of the others.

In the remaining subject, General and Physical Geography and Geology, there is a similar though smaller increase in the number of candidates taking it at Woolwich examinations, where its mark value is higher than at Sandhurst. This is just what the opinions of teachers have foretold. They say to do poorly in a subject counting 3000 will pay so much better than to do well in one counting only 1500, that in future nearly all candidates will take up the four subjects which are to count 3000; some who are very weak in one of these will take one of those marked 2000; and the rest of the subjects, including the science, they do not see their way to using at all. Accordingly, science teachers, even in those schools where science is most valued, are already hearing proposals to drop the regular science work hitherto done by boys who are looking forward to joining the army, and to substitute for it extra Latin. In other words, the new

regulations are already discouraging general education and encouraging an unfortunate system of specialisation.

II. The proportions of candidates who have chosen one of the branches of experimental science in these examinations show clearly that they are not generally regarded as paying subjects. At Sandhurst especially it is quite evident that there has been no considerable success in consequence of cramming in this subject. It has plainly not been worth while to cram it, nor to teach it for this examination, except in a few cases. At Woolwich under fairer conditions, it has been chosen by a greater number. Experience shows that in the Woolwich examinations candidates of real scientific ability who work well can do fairly, but only fairly, well, and accordingly such candidates are encouraged in those schools where science is taught to take up experimental science unless they are decidedly strong in some other subject. But the marks they get, even when successful, are not such as to encourage its adoption by any except those of a scientific ability quite above the average, and these do not want cramming. For example, a candidate standing second in order among the experimental science candidates lately obtained only 33 per cent. of the nominal maximum. And in one subject, chemistry, lads of such ability as would give them a fair chance of scholarships at our Universities had they time for sufficiently wide reading, will usually fail to get marks more than slightly exceeding 40 to 50 per cent. of the maximum, with the greatest diligence, even though their position on the list of experimental science candidates is a good one. These facts, and the absence of any rush on the subject seems quite inconsistent with the charge that experimental science has been a subject in which there has been much successful cramming—some there has no doubt been in this and in all subjects; candidates who have first-rate memories, and only moderate intelligence, will from time to time succeed by sheer industry in these and in all other competitions. Probably mathematics and experimental science suit these less than any other subject.

Geography, physical geography, and geology have been selected by rather more candidates both at the competitions for Sandhurst and Woolwich. From the nature of this subject it seems not impossible that there has been cramming in preparing for it. If so, the evil could surely be met, possibly by the changes proposed in Section III., combined with great care in setting the papers, and by the introduction of a *vivâ voce* examination.

III. As physiology is now extensively studied in the Universities, whence some of the Sandhurst candidates come, and is successfully taught in at least one great school—Eton—it is a question if the time has not come when it should be added to the science subjects examined.

And as practical physics is now taught in some schools, and examined at the scholarship competitions at Cambridge, it would be a gain if there could be a practical examination for candidates who take up physical subjects as there is for those who take up chemistry. This would act as a check on cramming, and would encourage students of a practical turn, and would encourage, as its absence discourages, this valuable branch of work in our public schools. One subject, chemistry, is encumbered by the addition of heat to it. Chemistry would be at least as difficult as the other divisions without this addition;

with it, and its practical examination, it is in a most unfair position. It would probably be advantageous to add light to heat, and make them a new division. The scheme would then stand as follows:—

DIVISION *a*.—*Experimental Science*

1. Chemistry. With a practical examination.
2. Light and Heat. " " "
3. Electricity and Magnetism. " " "

DIVISION *b*

1. Physiology. With some practical work.
2. Geography, Physical Geography, and Geology. With a *vivâ voce* examination on specimens.<sup>1</sup>

Candidates might be allowed to take one subject in Division *a* and one in Division *b*, which would be in accordance with the present plan at Woolwich, but would give greater choice of subjects. It would also be much fairer to one much-taught subject—chemistry.

IV. The very small proportion of the candidates for Sandhurst who select experimental science does suggest that in this case too high a standard is perhaps expected by the examiners, though it is probably a question of marks to a great extent. But with this exception, and if that very difficult subject, chemistry, were relieved of the addition of heat, on the whole it does not appear that the standard expected is much too high. It is true that there are other subjects marked more liberally; yet on the whole a high standard is more in the interests of science than a low one. The latter would encourage superficial teaching, and so lead to the discredit of the subject. Hitherto candidates of good scientific ability have been able to take advantage of their science at Woolwich if well taught, and if proper appliances for the work have been available. There does not seem therefore much ground for complaint on this score, though there has been a certain want of regularity in the marks awarded to similar boys in different subjects and at different examinations, which would probably be to a great extent removed if two papers instead of one were set on each subject, the papers being as far as possible of different characters. It has, however, been only just possible, even under the Woolwich system, for the scientific candidates to take up experimental science with the present standard of knowledge demanded, and a small difference in raising this standard or depressing the marks allotted to it would undoubtedly have very serious effects. The fairest method of allotting marks seems to be that adopted at Woolwich, where mathematics, which are essential, are marked above the rest, and the others are all upon an equal footing, free choice being allowed. To offer 3000 marks for four subjects, 2000 marks for two others, and 1500 for the rest, and to limit the candidates to four subjects, is equivalent to cutting out those for which 1500 are given, especially when it is a condition that of the four subjects selected three shall be taken from those for which 3000 marks are given, and only one at most from all the others. No doubt other plans which would be more satisfactory than that which has been employed at Woolwich could be suggested. But it is certain from past experience that a scheme of examination on the lines of the new regulations will seriously discourage the teaching of science in our public schools, and indeed will tend to narrow the instruction they give in all respects.

<sup>1</sup> Probably if the Geography were dropped and a higher standard of knowledge in the other two subjects were demanded, it would discourage superficiality, the Geography being retained in the preliminary examination, however, as a qualifying subject.

## PROFESSOR TAIT'S "HEAT"

*Heat.* By P. G. Tait, M.A., Professor of Natural Philosophy in the University of Edinburgh. (London: Macmillan and Co., 1884.)

A TREATISE on heat by one so eminent, both as physicist and teacher of Physics, needs no apology, and yet no doubt the author is right in stating that his work is adapted to the lecture-room rather than to the study or the laboratory. Freshness and vigour of treatment are its characteristics, and the intelligent student who reads it conscientiously will rise from it not merely with a knowledge of heat but of a good many other things besides.

"If science," says our author (p. 368), "were all reduced to a matter of certainty, it could be embodied in one gigantic encyclopædia, and too many of its parts would then have . . . little more than the comparatively tranquil or, rather, languid interest which we feel in looking up in a good gazetteer such places as Bangkok, Ak-Hissar, or Tortuga." Not a few text-books of science are precisely of the nature of such a guide without its completeness, and while they carry the student successfully to the end of his journey, the way before him is made so utterly deficient in human interest that he reaches his goal with a sigh of relief, and looks back upon his journey with anything but satisfaction—as a task accomplished rather than as a holiday enjoyed. Now the presence of such a human interest is the great charm of the work before us. It may be a fancy on our part, but we cannot help likening our author to the well-known guide of Christiana and her family. Both have been equally successful in the slaughter of those giants whom the older generation of pilgrims had to find out for themselves and encounter alone. But here the likeness ends, for it is quite certain that those who place themselves under the scientific guidance of our author will not be treated like women or children, but they will be taught to fight like men. And surely to combat error is an essential part of the education of the true man of science, for, if not trained up as a good soldier of the truth to defend the king's highway, he will be only too apt to turn freebooter, and gain his livelihood by preying on the possessions of others.

The first chapter contains the fundamental principles. "Heat," says our author, "whatever it may be, is SOMETHING which can be transferred from one portion of matter to another; the consideration of temperatures is virtually that of the mere CONDITIONS which determine whether or not there shall be a transfer of heat, and in what direction the transfer is to take place."

Then follows a preliminary historical sketch of the subject, the result of which is that heat is now proved to be a form of energy. Again: "The mechanism upon which heat-energy depends is (probably at least) approximately known so far as regards heat in a gas and as regards radiant heat. Beyond these we have, as yet, little information on the subject."

The following is a digression by the way:—

"There can be no question about the fact that the *metre* is inconveniently long, and the *kilogramme* inconveniently massive, for the ordinary affairs of life. The average length of the arms of shop-girls, and the average quantity of tea or sugar wanted at a time by a small purchaser, have no conceivable necessary relation to the

ten-millionth part of the quadrant of the earth's meridian passing through Paris, or the maximum density of water. But the standard *yard* and *pound* were, no doubt, originally devised to suit these very requirements as regards the average dimensions of the shop-girl or the paying powers of the ordinary customer. Yet this invaluable superiority of our *units* over those of the metrical system is, with an almost over-refinement of barbarism, thrown away at once when we come to multiples or sub-multiples."

It may be desirable to quote the author's own words regarding his classification of different kinds of heat:—

"In the first place, we have absolutely no proof that radiation from the sun is in any of the forms of energy which we call heat while it is passing through inter-planetary space. That it is a form of energy, and that it depends upon some species of vibration of a medium, we have absolute proof. But it seems probable that we are no more entitled to call it heat than to call an electric current heat; for, though an electric current is a possible transformation of heat-energy, and can again be frittered down into heat, it is not usually looked upon as being itself heat. Just so the energy of vibrational radiation is a transformation of the heat of a hot body, and can again be frittered down into heat—but in the interval of its passage through space devoid of tangible matter, or even when passing (unabsorbed) through tangible matter, it is not necessarily *heat*."

That this is not a mere question of words may be seen from the following considerations. According to theory, all kinds of radiant heat, whether these have issued from a source of high or from one of low temperature, are in presence of an absolutely black surface at once and entirely converted into absorbed heat. On the other hand, absorbed heat is only entirely converted into radiant heat when the body from which it issues has been cooled down to the absolute zero of temperature, a condition which is practically unapproachable.

The following are the subjects which appear to us to be treated in the most original manner:—Thermo-electricity, combination and dissociation, conduction, convection, and radiation, discussion of isothermals and adiabatic lines. In the development of thermo-electricity and of conduction the author has taken a prominent part, and probably we must blame the late mild winter for our not hearing more about his latest research regarding the effect of pressure upon the point of the maximum density of water.

We cannot do justice to such a book in the course of a short notice like the present; we will therefore content ourselves with a few quotations and remarks. The following (p. 72) is an excellently clear definition of an isotropic body:—

"An isotropic body is one from which, if a small sphere were cut, it would be impossible to tell by any operation on it how it originally lay in the solid—it has, in fact, precisely the same properties in all directions."

In p. 91 an increase in clearness is produced by giving the coefficient of dilatation of mercury at various temperatures under three different heads, namely, mean coefficient of dilatation from 0°, coefficient referred to volume at 0°, true coefficient. The following statement will be found useful to meteorologists:—

"Vertical (convection) currents at definite places may be at once produced either by heating the requisite part of the lower portions of a fluid mass, or by cooling that of the upper portions. But the effects of cooling part of the lower portions, or heating some of the upper, are usually



much less important. Hence the grander phases of *ocean circulation* (except in so far as they depend on winds, and therefore on *atmospheric circulation*) are much more dependent upon polar cold than upon tropical heat. On the other hand, those of atmospheric circulation depend more upon tropical heat than on polar cold. For the great temperature effects are produced mainly at the upper surface of the ocean, and at the lower surface of the atmosphere. Hence, if there were no great modifying causes, we should expect to find (on the whole) the lower water, as well as the lower air, coming from both sides towards the equator, and the upper currents of each flowing to the poles."

Chapter XXI. is entitled "Elements of Thermodynamics." The subject is nevertheless treated in a very complete manner, and is evidently regarded by our author as something in the shape of a *header*. We gather this from the very characteristic invitation to take the leap which is addressed to the student in Art. 381. We shall not, however, repeat the invitation, but rather leave the reader to find it out for himself and then—take the leap.

Let us conclude with one more quotation:—

"We have merely to think of the ideas which we try to express by such words as Time, Space, and Matter, to see that, however far discovery may be pushed, our little 'clearing' can never form more than an infinitesimal fraction of the 'boundless prairie.' No part of this, however, can strictly be called inaccessible to unaided human reason, if time and patience fail not. But far beyond in one sense, though in another sense ever intimately present with us, are the higher mysteries of the true Metaphysic, of which our senses and our reason, unaided, are alike unable to gain us any information."

While cordially indorsing these views, the writer of this notice would remark how admirably fitted is such a science as Physics for the discipline of the human mind. It possesses that boundlessness which is the *ultimate* characteristic of all true knowledge, and this is so obvious that few are bold enough to represent our "little Physical clearing" as bounded by an "impenetrable wall" or by the "abyss."

The scientific incendiary (to change the metaphor somewhat) prefers to confine himself to regions where there is a large collection of inflammable materials, until at length his attempts are brought to an end by the copious stream of cold water with which the physicist is able to deluge the scene of his exploits.

BALFOUR STEWART

### OUR BOOK SHELF

*Beiträge zur Kenntniss der Liassischen Brachiopodenfauna von Südtirol und Venetien.* Von Hyppolyt Haas, Dr. Phil., Privat-docent an der Universität Kiel. Mit 4 lithographirten tafeln. 4to. (Kiel: Lipsius und Tischer, 1884.)

THIS is one of the numerous works which have been published during the last half century on the fossil forms of Brachiopoda, that most ancient, abundant, and anomalous class of the Invertebrata. Dr. Davidson has devoted the greater part of a tolerably long life to the study of this exceedingly interesting group; and the volume of the Palæontographical Society's publications for the present year will complete and close his valuable labours on the fossil Brachiopoda of Great Britain. He has kindly furnished me with the following critical notice of Dr. Haas's work, the title of which is above given:—

"Dr. Haas describes in his memoir some 40 species of

Liassic Brachiopoda, and of which number 12 are new. In four admirably drawn quarto plates he gives figures of 32 species. The Liassic Brachiopoda from South Tyrol and Venetia are very remarkable, and have in part been described and beautifully illustrated by Gemmellaro, Böckh, Uhlig, Meneghini, Canavari, Oppel, Zittel, and Schmid; *Waldheimia perforata*, Piette, and *Spiriferina rostrata*, Schl., being the only species out of the number that occur in the Liassic rocks of Great Britain. Dr. Haas's work adds much to our knowledge with respect to the Liassic Brachiopoda, and his descriptions have been carefully drawn up. In 1881 and 1882 Dr. H. Haas and Dr. Camille Petri published a very important work, entitled 'Die Brachiopoden der Juraformation von Elsass-Lothringen,' accompanied by 18 beautifully drawn quarto plates. In this work the authors describe some 92 species from the Lias and Inferior Oolite, and of which a large proportion occur likewise in our British rocks. It is to be hoped that Dr. Haas will continue his valuable researches among the Brachiopoda."

'Non meus hic sermo!'

J. GWYN JEFFREYS

*Tricycles of the Year 1884.* By H. H. Griffin. (London: L. Upcott Gill, 1884.)

WHATEVER improvement in health and strength may have resulted from the now prevalent exercise of cycling, there seems to be a mental improvement, for a knowledge of the science of mechanics is more widely spread, or at any rate there is a more general desire to understand this science in so far as its application to the bicycle and tricycle is concerned. For this reason such a book as Mr. Griffin's "Tricycles of the Year" is likely to be of value, for in it he describes in simple language most of the tricycles which can now be obtained, giving particulars of dimensions and weight, and other information which a cyclist may require.

It is a pity that many well-known machines are not so much as mentioned, among which are the "Rudge," the "Cheylesmore," and the direct-action machines. Is it that there has been no improvement in any of these since last year? If so, why should the "Oarsman" be omitted or some others be described at length?

The good qualities and advantages of each machine are set forth plainly enough, while the defects are left to be discovered by riders. The author has no doubt acted wisely here; it would be next to impossible in dealing with such a multitude of often similar machines to make comparisons which cyclists who hold opposite opinions would not consider unfair.

The action of parts that are peculiar to any machine is carefully described, figures being inserted where necessary to make the text more comprehensible. The general appearance which many tricycles present is shown by a series of woodcuts.

Bicycles are not discussed, as they form the subject of a corresponding work.

C. V. B.

### LETTERS TO THE EDITOR

[The Editor does not hold himself responsible for opinions expressed by his correspondents. Neither can he undertake to return, or to correspond with the writers of, rejected manuscripts. No notice is taken of anonymous communications.]

[The Editor urgently requests correspondents to keep their letters as short as possible. The pressure on his space is so great that it is impossible otherwise to insure the appearance even of communications containing interesting and novel facts.]

#### Chalk and the "Origin and Distribution of Deep-Sea Deposits"

I LOOKED forward with great interest to the conclusion of Messrs. Murray and Renard's "Origin and Distribution of Deep-Sea Deposits," hoping that some useful comparisons would

have been made between the present sea-beds and the Chalk, the Gault, and the Greensands, which appear to be among the deepest water deposits now accessible as dry land. Instead of this we are merely told that chalk "must be regarded as having been laid down rather along the border of a continent than in a true oceanic area" (NATURE, p. 134). All geologists are aware, since the publication of Dr. Gwyn Jeffreys' address to the British Association, and the appearance of Mr. Wallace's "Island Life," that some naturalists regard the Chalk as a shallow-water formation, but the former opinion, pronounced as it was by one of the most competent judges, was based exclusively on the present habits of the very few genera of Mollusca that have survived from the Chalk period, and seems quite in contradiction to the far more important groups, the Sponges, Echinodermata, and the minute organisms of which the formation is so largely composed, while no opinion has yet found its way into the hands of geologists regarding the depth of water indicated by the Crustacea and the fishes of the Chalk. Mr. Wallace's collation of the Chalk, as a formation, with the decomposed coral mud of Ooahu, is so fantastic as to have failed to carry conviction to the mind of any competent geologist. The points of resemblance between some Globigerina ooze and the Chalk are so numerous and peculiar, that surely the assertion that the latter is a littoral formation, while the former is oceanic, requires strong support. The relative analyses of chips from the Chalk and of Globigerina ooze, quoted by Mr. Wallace, are not by any means final or conclusive. We all know that the silica has been removed and segregated into flints from the White Chalk at Shoreham, and that the iron and other metals are also segregated into crystallised masses, so that a comparison of the Chalk, minus these, is misleading. In like manner the Grey Chalk at Folkestone has lost all its oxide of iron by segregation and crystallisation, and many of the layers are cherty, and unduly rich in silica obtained probably at the expense of other layers in which it is now relatively scarce. During the ages that Chalk has been elevated and has acted as a sponge for the collection of rain water, who can say what other of its constituents may not have been dissolved away or metamorphosed? Siliceous sponge skeletons have been replaced by calcite, calcite shells have been replaced by silica, whilst aragonite shells have been entirely dissolved away. In like manner, can it possibly be contended that the absence of volcanic matter in the Chalk is an important distinction between it and Atlantic ooze? It is an accidental lithological distinction, but nothing more, and merely shows that volcanic dust was not being ejected in the same masses as at present. The Cretaceous and Eocene eruptions, so far as I am aware, are all fissure eruptions of vast magnitude, and the contemporary rocks in their vicinity seem to show that they were not accompanied by the showers of ash that mark eruptions from craters at the present day. Messrs. Renard and Murray have had exceptional opportunities of studying this question, and have no doubt convincing proofs of their statement regarding the littoral character of the Chalk deposit; but I really think that, considering the national character of the undertaking which made the collection of proof possible, it should no longer be withheld. Geologists at present, supposing my feelings are generally shared, are asked to believe that an enormous formation, which shows little, if any, trace of the proximity of land, and abounds with the remains of deep-sea life, was laid down upon a coastline; but beyond the extravagant assertion that it is decomposed coral-mud no reasons whatever for this belief are brought forward, nor are any areas pointed out in which an equivalent to the Chalk is in course of deposition. I cannot conceive why our official geologists have ignored this, one of the most important questions in the whole range of the science. It is little to our national credit that, having spent vast sums in the collection of evidence, we are still in the dark as to its geological significance.

J. STARKIE GARDNER

#### A Rhyolitic Rock from Lake Tanganyika

THE interesting note by Dr. H. J. Johnston-Lavis on a volcanic rock from the shores of Lake Nyassa (NATURE, p. 62) calls to my mind a couple of specimens in my collection which, with not a few others of interest, have perforce remained for some time undescribed. They were given to me by N. F. Robarts, Esq., F.G.S., who received them from Capt. Hore of the London Missionary Society, by whom they were collected at Cameron's Bay on the south-west of Lake Tanganyika, a little north of the Lofu River. As they are evidently fragments of the same kind of rock, I have only had a slide prepared from one of them. The rock

is externally of a pale yellowish- to reddish-gray colour; compact, but exhibiting faint traces of a fluidal structure, with occasional spots resembling small crystals of decomposed felspar. A fresh broken surface, however, shows the real colour to be a purplish brown, streaked and mottled with a pale reddish tint. Microscopic examination shows that the rock is a rhyolite, somewhat darkened with numerous specks of disseminated ferrite, with many clearer bands, indicative of a fluidal structure. In this matrix are scattered crystals of decomposed felspar, not exceeding  $\frac{1}{8}$  inch in diameter, and a few plates of a ferruginous mica, also exhibiting signs of decomposition, with two or three granules of quartz. With crossed Nicols a minute devitrification structure is exhibited by the slide as a whole, and this is coarser and stronger in the clearer bands. Here crystalline quartz is developed, which assumes with the felspars on occasion a spherulitic or sometimes approximately micrographitic structure. The larger felspar crystals are rather decomposed, but orthoclase and a plagioclastic felspar can be recognised. Many distinct granules of iron peroxide (?hematite) are scattered about. Examination with high powers causes me to doubt whether the devitrification is complete in all parts of the slide, and whether the phenomena are not rather due to the development of a large number of minute crystallites of not very regular form in an isotropic base. In this, however, there is nothing exceptional.

From the structure I should consider it more probable that the specimen had been taken from a flow than from a dyke. I should suspect the devitrification structure to be the result of secondary change, and the rock not a very modern one. In some respects it reminds me of the pre-Cambrian rhyolites (devitrified) of Britain, but I should think it had not quite so high a percentage of silica, *i. e.* that this did not exceed 70, and perhaps was rather less. Among the rhyolitic rocks which I described from Socotra (*Phil. Trans.* 1883, p. 273), collected by Prof. J. B. Balfour, were some of a rather dark purple colour, not unlike to this specimen from Lake Tanganyika.

T. G. BONNEY

#### Aseismic Tables for Mitigating Earthquake Shocks

IN Mr. Topley's paper on the Colchester earthquake, which appeared in NATURE, vol. xxx. p. 60, he mentions the aseismic joint designed by my father, Mr. David Stevenson, for mitigating the effects of shocks on lighthouses in countries subject to earthquakes, and from information which Mr. Topley has received and cites it would appear that the appliance had been tried in Japan, found wanting, and abandoned. The facts of the case, however, are as follows, and are supplied to me by Mr. Simpkins, who was engaged in fitting up the apparatus sent out from here, and has only recently returned from Japan. Of the seven lighthouse apparatus designed by Messrs. D. and T. Stevenson and furnished with the aseismic joint and sent out to Japan, there are three at present in action, and have been so for ten years, viz. Mikomoto, Siwomisaki, and Yesaki. At Iwosima and Satanomisaki, in the south end of the island, the tables are screwed up so as not to act, as it is reported that no earthquakes are felt at these stations. At Tsuragisaki and Kashmosaki, which are revolving lights, the steady screws sent out with the apparatus (to prevent the table oscillating while winding up the machine, which is the main inconvenience felt, and which was foreseen) were for some reason not put in at these stations, and the tables were firmly strutted with timber to prevent any motion. These two are the only lighthouses at which any damage has been done; while those stations at which the tables are in operation have never suffered at all, although they have been repeatedly subjected to shocks.

With regard to the effect of wind, to which Mr. Topley alludes, I may say that none of the towers are placed on tables, it is only the apparatus inside the lantern which is so treated, although my father proposed it for the towers themselves, and I have no doubt that, from the experiments I saw made here, they would have been equally effective. Two towers fitted with the tables were made and sent out to Japan, but were unfortunately lost at sea and not replaced.

CHARLES A. STEVENSON

45, Melville Street, Edinburgh, June 16

#### The "Cotton-Spinner"

ON seeing my article on this rare British Holothurian, Mrs. Fisher—who, as Miss Arabella B. Buckley, is well known to a

large circle of readers—kindly sent me an account of her experience of the offensive use of the Cuvierian organs. She tells me that in the Bay of Rapallo at Santa Margherita, near Porto Fino, she dredged a large black Holothurian, and that "the tangled mass of white threads you mention is so sticky and in such quantity that, after having taken one of these animals out with my hand, I had considerable difficulty in freeing my fingers from the threads; indeed, my hand was not comfortable till I had washed it in hot water." On the other hand, an inquiry made of a gentleman living at Penzance, and interested in Echinoderms, resulted in the answer that he had never heard of the "Cotton-Spinner." [F. JEFFREY BELL

### The Red Glow

IN your issue of April 10 (p. 549) is the statement by an observer in Australia that the "red glow" was margined by an immense black bow stretching across from north-west to south-east."

I wish to say that the above language almost exactly describes the appearance to which I alluded on the same page as "the earth shadow cutting off the upper rim of the first glow." The "black bow" of the Australian was evidently the shadow of the horizon projected on the haze stratum. In both the above cases the lower surface of the haze was evidently well defined, so that as the horizon intercepted the direct rays of the sun, a well-marked shadow moved westward and downward. Above this black rim or bow appeared the secondary glow, produced by the reflection of the sun's rays from that portion of the haze surface which was directly illuminated. Very often the second glow was more conspicuous and impressive than the first, because it shone against the dark sky of night.

In the *Proceedings* of some association I have just read an astonishing estimate of the height of the haze as 141 miles, based on the fact that it received the sun's rays one hour after sunset, the fact being strangely overlooked that the late reflection was a secondary one.

One evening the shadow or "black bow" was beautifully indented or serrated, doubtless by the shadows of remote cumuli such as are commonly seen in platoons on our evening horizons. The "black bow" was seen only during the first few days of the glows in September. S. E. BISHOP

Hawaiian Government Survey, Honolulu, May 20

P. S.—I hoped long ere this to have sent you data from the Caroline Islands received per *Morning Star*, now much overdue. We fear she has suffered disaster.

### Light Phenomenon

THIS evening towards sunset, at 7.55 p.m., there was a column of light extending from the upper part of the setting sun to about 20°, the column being truncated and perpendicular to the horizon. After remaining thus for about two minutes, the sides of the pillar lost somewhat of their perpendicularity, and, with the whole volume of the sun, put on prismatic colouring, the ray (a single one, and still truncated) at times appearing to be a wave of flame. I observed this, with four or five other persons, from the cliffs, and should like to know if the peculiarity of this sunset was observed by others. It continued until 8.20 p.m., when the sun was below the horizon, and the wave of flame ceased. I can hardly better describe this ray than as being very like a northern light, only extremely circumscribed in size, and intensely brilliant. R. D. GIBNEY

Falmouth, June 21

### Atmospheric Dust

IN connection with the recent experiments of Dr. Lodge and Mr. John Aitken (described in late numbers of *NATURE*) on the filtration of dusty atmospheres, I have ventured to call your attention to the following, as of possible interest. I have had frequent occasion to note the intensity of the so-called "rain-band," an absorption-band of terrestrial origin, due probably to the dust and water-vapour present in the atmosphere, and of just less refrangibility than the less refrangible of the D lines, and have at present two continuous records of observations taken, in the main, five times a day, running back a year and a half or so. I have also a very thorough list of the auroral displays which have occurred for the same period in this vicinity. Granting that the aurora is an electric discharge in high regions of the

atmosphere, or, more accurately, where its density is inappreciable compared with that at the earth's surface, and knowing that according to these recent experiments an electric discharge is capable of precipitating the dust-particles in the atmosphere, it should follow that at times of auroral display, or immediately following, the intensity of this rain-band should be at a minimum. Searching the records to ascertain if any such correspondence could be noticed, it is quite astonishing to find how distinct and well marked this variation in the intensity of the rain-band at times of auroral occurrence is. The atmosphere is full of fine dust-particles, and our very general, though not yet decisively proven, belief is that the aurora is somewhat of a glow-like discharge from electrified air strata, in whose vicinity the density of the dielectric is inconsiderable. The direct inference is that at such times the fine dust and vapour particles are deposited, made to settle, or, uniting together, form an agglomeration, and become perhaps cloud-nuclei. Perhaps other evidence on this matter can be elicited. The records at hand show very plainly just such an agreement as was anticipated.

ALEXANDER MCADIE

26, Garden Street, Cambridge, Mass., U.S.A.,

June 5

### Some Botanical Queries

THERE is a plant here with a very large bulb, *Scilla maritima* (?), whose flower I have not seen. I grew two of them in pots last year, but they failed. This plant is set by the peasants near the fig-trees with the idea that these latter will produce better fruit. Is this a mere superstition? or can the *Scilla* be connected in any way with caprification?

Is *Lilium bulbiferum* known to be polygamous? The greater part of the specimens I have found in the mountains near here are staminate, but in some there is a very minute though perfectly formed pistil. Müller, my only book of reference, says nothing on this point.

Is *Trifolium repens* among the list of cleistogamous plants? I am watching a specimen which seems to produce abundant fruit, but no ordinary flowers. [LIGUS

Nice, France, June 20

### Primæval Man and Working-Men Students

UNDER the above heading you published a letter from me in *NATURE*, August 2, 1883, p. 320, giving the names of four thoughtful artisans, who, after studying the Pitt-Rivers collection of antiquities, and reading my notes in *NATURE*, had made finds of Palæolithic implements in Essex. Ten months have passed since that letter was published, and a fifth student, Mr. W. Swain, has now joined the original party of four. On Sunday, June 15, these admirable workers called upon me with their recent discoveries. They consisted of fifteen Palæolithic implements found in the drift gravels of Leyton, Wanstead, and Plaistow, with the usual complement of flakes. Some of the implements were of the older abraded class, others were as keen as knives, and from my "Palæolithic Floor," traces of which, as I have pointed out, may be seen in Essex. Three nondescript tools were also lighted on, and four hammer-stones of quartzite with abraded ends, one from Nazing; five Neolithic instruments from Jordan's Wood, and a large collection of flakes.

The excursions for these tools and flakes have necessarily all been made on Sundays. The finders of the stones are not mere collectors, but men who have mastered the meaning of their subject. W. G. S.

### FORESTRY

THE approaching International Forestry Exhibition at Edinburgh, which is to open on July 1 next, and which promises to be a very successful affair so far as the variety of the exhibits and the general arrangements of the Exhibition are concerned, will, it is hoped, prove something more than a mere show during the months it is open to the public. Though the objects exhibited will, in all probability, be a source of considerable attraction and instruction, inasmuch as the arrangement and scope of the several classes seem to have been carefully considered, it is much to be hoped that the Exhibition will be

the means of leaving a lasting improvement on the condition of forestry in this country. One thing it certainly must do, and that is it will draw attention to the great importance of practical forestry in utilising and developing the resources of forest produce, and in directing attention to these products the eyes of many will be opened as to their value, whether to the consumer or to the producer. There is, however, a higher aim in the prosecution of scientific forestry than even these points just referred to, namely, the preservation of indigenous arboreal vegetation and the securing of a sufficient rainfall.

The superiority of our Indian Empire and many of the British colonies, as well as France and other countries of continental Europe, over Great Britain itself must, from the nature of things, be prominently seen in the forthcoming Exhibition, whether in the character of the exhibits themselves, or in the exemplification of forest workings. This, then, should bring some good results towards putting our own country on a more satisfactory footing regarding the teaching of the principles of forestry, so that we may not in the future stand in the unenviable position of being about the only country of any importance which has not its School of Forestry or some institution or college where the Government recognises the importance of the subject by a grant from the Imperial Exchequer. The position of England in this respect as compared with other countries was admirably shown by Col. Pearson in his paper on "The Teaching of Forestry," read before the Society of Arts on March 1, 1882. He then pointed out that, "besides the establishments for teaching forest management in Germany and France, schools of silviculture now exist in all the principal countries of Europe except in Great Britain. Austria, Italy, Russia, Switzerland, and even Roumania, most of them, after sending pupils for a few years to the French and German schools, have set up schools of their own, and thus rendered themselves independent of foreign educational aid." After referring to the fact that America was at that time about founding a similar school, Col. Pearson says:—

"It is to be regretted that as yet no steps have been taken to do the same in Great Britain, for with us, as elsewhere, a forest school would become not only an establishment for teaching silviculture, but also a centre of study and practical observation from whence a knowledge of silviculture as a science would be spread abroad for the benefit of society in general.

"It is certain that, unless the forests of a country are properly and economically managed, the time may come when, as was the case in India, it will find itself without the means of procuring the needful supply of timber, except at an extravagant price; while at the same time the general interests of the community require that a fairly abundant and cheap supply should be constantly available. This is especially the case where, as in the great continental areas, deficiency in the means of transport, or the distance from the timber-producing tracts, adds materially to its cost. In such cases experience has shown that the only practicable way out of the difficulty is for the State to intervene; and although in England we have special facilities for supplying our wants from abroad, owing to our extended commerce with all countries, the extreme limits of a reasonably cheap supply seem to have been reached; and at all events State action seems so far desirable as to help private proprietors to make the best use of their timber-producing lands."

Following on this, namely, in August last, Sir John Lubbock asked from his place in the House of Commons whether Her Majesty's Government, during the autumn then ensuing, would consider the question of forest education in this country, and whether the national forests might not be utilised for this purpose, taking occasion to point out that our woods and plantations amounted in

round numbers to 2,500,000 acres, and, moreover, that in Scotland and Wales it was calculated that there were 5,000,000 or 6,000,000 acres at present almost valueless, which, if judiciously planted, would give large results, thereby showing that the subject was one of vast importance. Sir John Lubbock further said:—"We were the only important nation in Europe without a forest school, and yet if we included our colonies, our forests were the largest and most valuable in the world. It appeared to be a very strong argument in favour of the establishment of a forest school in this country that at present the young men who were going out to manage our Indian forests had to be sent for instruction to the great French Forest School at Nancy. No doubt that this was a most excellent institution, and we were indebted to the French Government for the courtesy with which they had received our English students; but the system of education given there naturally contained some branches—as, for instance, the study of French law—that were not adapted to English students, while there were many other considerations, such as climate, which rendered a Continental school less suitable for English requirements. He might add that no young Englishman as a matter of fact, went there excepting those intended for the Indian service. For our colonies, again, the establishment of a good forest school here would be of very great importance. A judicious management of their woods would add considerably to their income." As an illustration of the need of some system of forest teaching in this country, Sir John Lubbock referred to the recent appointment of a Forest Commissioner by the Government of the Cape of Good Hope at a high salary, a French gentleman having been selected in consequence of the failure to find a properly qualified Englishman.

India was perhaps the first country belonging to the British Empire to organise a complete system of forest conservancy, and this was not effected before it was absolutely needed, for many of the valuable timber trees of India were threatened with annihilation in consequence of the reckless manner in which they were felled to supply the wants of the people. The appointment of Dr. Brandis as Inspector-General of Forests, in 1863, was the commencement of a better state of things, "and in 1867 his scheme for training foresters for India in the schools of France and Germany was, after much discussion, adopted finally by both the Home and Indian Governments." The outcome of this is well known, and India now has a large and well-trained staff of educated forest officers, who not only furnish valuable and interesting periodical reports on the forests of their respective districts, but standard works on the subject of India's arboreal vegetation are not amongst the least important result of their labours. As a proof of this we need only mention the titles of Beddome's "Flora Sylvatica of Madras," published in 1873; Brandis's "Forest Flora of North-West and Central India," published in 1874; Kurz's "Forest Flora of British Burma," published in 1877, and last, though not by any means least, Gamble's "Manual of Indian Timbers," published in 1881.

Trained as Indian forest officers now are before commencing their duties, and with the books we have mentioned as their guides, it is not difficult to understand that our Indian Empire possesses a well-organised Forest Department, and many of the colonies are following, if not on exactly similar lines, the example set for the preservation of their forests. With all these indications around us that foreign countries and our own dependencies are fully alive to the importance of a proper management of their forests, it is not a little remarkable that we in this country are no farther advanced in the matter of establishing forest teaching here than we were two years since, when the subject was so strongly represented by Col. Pearson, or when nearly a year since Sir John Lubbock revived it, and placed the matter prominently before the

present Government. It is therefore sincerely to be hoped that the forthcoming Exhibition at Edinburgh will be the means of putting a new spoke in the wheel, and that before the close of the Exhibition, or soon after, something tangible may have resulted in making forestry one of the branches of education either in distinctly constituted forest schools, or in our present agricultural colleges.

It is satisfactory to know that the arrangements of the Exhibition are in a forward state, and that, if the promises which have been received by the executive are fulfilled, the Exhibition will exceed the anticipations of the promoters.

JOHN R. JACKSON

#### RAINFALL OF NEW SOUTH WALES<sup>1</sup>

UNDER the energetic direction of Mr. Russell the investigation of the rainfall of New South Wales is being prosecuted with much success, and the interest of the colonists may now fairly be regarded as awakened to the importance of the inquiry. This is evidenced by the recent rapid increase of stations, the number of rain stations for the five years ending 1882 being 96, 153, 191, 256, and 308, having thus trebled during this brief interval. A comparison of the maps of stations for 1878 and 1882 shows that the increase has been pretty evenly distributed over the whole colony; and of particular importance is it to note the spread of the rain-gauge over the extensive regions which lie to the north and north-west of the Murray River.

Mr. Russell draws pointed attention, in the following extract, to the practical value to the colonists of well kept rain registers:—

“As a proof of the necessity for the use of the rain-gauge all over the colony, not only for purposes of science, but also as a necessary instrument on every run, I may mention that on Goolhi station six gauges are kept on various parts of the run, and the records range from 19'81 inches to 27'75 inches. It would obviously lead to a false estimate of the grass the run would produce if only one gauge had been used, and that one where only 19'81 inches were recorded. I hope that the facts which the yearly records bring to light will have the effect of awakening those interested to the immense importance of collecting these statistics carefully and at once, so that every year will add to the knowledge which will be of such value in forming estimates of the seasons which are to come, and of the possibility of conserving water.”

Lately much speculation was indulged in, and various schemes were proposed of increasing by artificial means the rainfall of New South Wales, particularly in seasons of drought when day after day the sky becomes covered with dark, dense-looking clouds which regularly pass away without a drop of rain. In these cases, science can as yet hold out no hopes to the agriculturist. The successful instances of rain-production by artificial means have occurred when the atmosphere in the district where the experiment was made was at or near the point of saturation, a state of things which does not exist in the arid plains of the interior of Australia under the meteorological conditions when clouds daily darken the skies and as regularly mock the expectation of the farmer.

It must then be to a judicious and skilful cropping of the rainfall that the Australian farmer must look for the supply of his wants in the dry season and still more in seasons of exceptional drought. Now, as contributions towards the solution of this problem, the annual rainfall reports of Mr. Russell are simply invaluable. These reports give the rainfall and total days of rain for each month and for the year, to which is added the mean annual rainfall and rainy days calculated from previous years' observations at each place available for the purpose.

<sup>1</sup> “Results of Rain and River Observations made in New South Wales during 1878-82.” By H. C. Russell, B.A., Government Astronomer for New South Wales.

The annual rainfall for each year is represented on a large map of the colony, 22 by 26 inches, where the fall for each station is entered in its place as a black spot, the diameter of which is proportioned to the quantity of rain. By this device, the eye takes in readily and at a glance the distribution of the rainfall for the year. The comparative results of the five years for the different districts of the colony are most instructive.

Owing to its position on the globe and its physical configuration, New South Wales presents extremely different climates according to the varying amounts of the rainfall. Thus at Antony, on the coast near the borders of Queensland, the mean annual rainfall amounts to 65'15 inches; whereas at Mount Poole, in the extreme north-west, it is only 8'38 inches. For the nine years beginning with 1874, an approximation to the annual rainfall of the colony for each year has been calculated by Mr. Russell, the results for the separate years being 33'46, 29'38, 27'66, 20'48, 25'05, 30'75, 19'93, 20'73, and 20'11 inches, each of the last three years showing a marked deficiency. Now the interesting point is this, and it is a peculiarity which every other country possesses, but particularly those which exhibit climates so diversified as New South Wales, viz. that the rainfall of any month, or of any year, is very far from being equably distributed. The amounts of the excesses above, or the defects from, the average, tend really to partition the country into several well-defined rain districts for the time, these being determined apparently by river basins, watersheds, and other features of its physical configuration taken in connection with their relations to the thunderstorms and the rain-bringing winds. It is quite in the future, as an outcome of Mr. Russell's work, that the settlers in different parts of the colony will receive specific directions as to the cropping of their rainfall so as to provide even against the recurring calamitous droughts of the Australian climates.

An interesting feature of the reports are the diagrams, showing, by curves, the heights for each day of the Darling, Murrumbidgee, and Murray Rivers. A heavy flood occurred at Bourke, on the Darling River, on February 4, 1882, and reached its maximum, 26 feet 2 inches, by the end of the month, and the river did not fall to its summer level until April 5. This flood was occasioned by heavy tropical rains, from February 1 to 7, that fell over the northern part of the Darling watershed, which took two months to drain off, as is proved by the fact that little or no rain fell during the latter half of February and all March. In a few years these systematic observations of the heights of the principal rivers of Australia will furnish invaluable data for the determination of not a few important problems of meteorology and physical geography, which the marked insular character of this continent is so well suited to elucidate.

#### CALCUTTA BOTANIC GARDEN

SIR JOSEPH HOOKER has kindly placed at our disposal the following letter on the Calcutta Botanic Garden:—

“Our beautiful garden is now looking very nice. Let me tell you what I am looking out upon. On the right is a fine *Terminalia Catappa*, a mass of dark green foliage from base to summit, its branches with a quantity of *Soranthus longiflorus* on them. Further off, towering in the distance, is a clean-stemmed, stately-looking *Dipterocarpus alatus*, its branches the roost of vultures and cheels. Almost as tall, to one side of the *Dipterocarpus*, is a beautiful *Terminalia Arunja*, with mahoganies and the golden-flowered *Peltophorum* in front. *Dillenia pentagyna* in front, and *Morinda tinctoria* covered with masses of *Vanda Roxburghii*. There is a fine *Adina cordifolia*, one of the monarchs of the garden; its straight, sturdy stem, disdaining to bend in the sudden squalls and rain-storms, bears evidence of having been topped before,

and I am always expecting to see it go. At its feet cluster our bed of Cycads, the latter shaded by young *Oreodoxas* and *Caryotas*, and with the margin of the bed fringed by the long feathered leaves, plume-like, of *Phanix rupicola*. Here and there gleams of silver catch the eye, as the sun, striking on the ornamental stretches of water, glances through the foliage. To the left another member of that beautiful section of the *Rubiaceæ*—the *Nauclea*—occupies a prominent place, its stem the home of the handsome blossoms of *Vanda teres*. The pretty marble pillar and urn to the memory of Col. Kyd is seen through the branches. From it roads lead to the principal landing-stage bordered by *Oreodoxas*, mahoganies, and our only attempt at ribbon gardening, long lines of *Acalyphas*, &c. Another road, straight for nearly, if not quite, half a mile to one of the exits, has an avenue of *Polyalthia longifolia*, sacred to the Hindoos, and groups of *Betle* palms; then of *Oreodoxas*, and lastly of *Inga Saman*. We have great difficulty with the *Oreodoxas* on account of a beetle that lays its eggs in the terminal buds. Still another road leads to the Orchid House bordered by clumps of graceful bamboos. In the house we generally manage to have a pretty show, and its neighbourhood in the proper season is gay with the blossoms of *Amherstia Gustavia*, *Thunbergia Napoleona*, &c. *Magnolia grandiflora* is flowering with us just now. What a glorious flower it is! Yesterday and the day before there came down on us one of the sudden miniature cyclones that we are so liable to have at the approach of the change of the monsoon. It blew, rained, and hailed tremendously. The trees tossed their arms and wailed, poor things, with such effect that their branches everywhere broke and strewed the ground. However only one small mahogany fell. It was quite cold, and the rain froze, as it was falling, into lumps as big as marbles."

#### THE EXTINCT LAKES OF THE GREAT BASIN

THE Great Basin of North America presents the most singular contrasts of scenery to the regions that surround it. East of it rise the dark pine-covered heights of the Rocky Mountain system, with the high, bare, grassy prairies beyond them. To the west tower the more serrated scarps of the Sierra Nevada, with the steep Pacific slope on the other side. The traveller who enters the Basin, and passes beyond the marginal tracts where, with the aid of water from the neighbouring mountains, human industry has made the desert to blossom as the rose, soon finds himself in an arid climate and an almost lifeless desert. The rains that fall on the encircling mountains feed some streams that pour their waters into the Basin, but out of it no stream emerges. All the water is evaporated; and it would seem that at present even more is evaporated than is received, and that consequently the various lakes are diminishing. The Great Salt Lake is conspicuously less than it was a few years ago. Even within the short time that this remarkable region has been known, distinct oscillations in the level of the lake have been recorded. There are evidently cycles of greater and less precipitation, and consequently of higher and lower levels in the lakes of the Basin, though we are not yet in possession of sufficient data to estimate the extent and recurrence of these fluctuations.

It is now well known that oscillations of the most gigantic kind have taken place during past time in the level and condition of the waters of the Great Basin. The terraces of the Great Salt Lake afford striking evidence that this vast sheet of water was once somewhere about 1000 feet higher in level, and had then an outflow by a northern pass into the lava deserts through which the cañons of the Snake River and its tributaries wind their way towards the Pacific. Mr. Clarence King, Mr. Gilbert, and their associates in the Survey of the 40th Parallel, threw a flood of light upon the early history of

the lake and the climatic changes of which its deposits have preserved a record. They showed that the present Great Salt Lake is only one of several shrunken sheets of water, the former areas of which can still be accurately traced by the terraces they have left along their ancient margins. To one of the largest of these vanished lakes the name of the French explorer Lahontan has been given. The geologists of the 40th Parallel Survey were able to portray its outlines on a map, and to offer material for a comparison between it and the former still larger reservoir of which the present Great Salt Lake is only a relic. The United States Geological Survey has since begun the more detailed investigation of the region, so that ere long we shall be in possession of data for a better solution of some of the many problems which the phenomena of the Great Basin present. In the meantime Mr. J. C. Russell, who has been intrusted with this work, has written an interesting and suggestive preliminary report of his labours.

The average rainfall of the area of the Great Basin is probably not more than 12 or 15 inches. In the more desert tracts it may not exceed 4 inches, though in the valleys on the borders of the Basin it may rise to 20 or 30 inches. The rain falls chiefly in autumn and winter, consequently many of the streams only flow during the rainy season, and for most of the year present dry channels. Even of the perennial water-courses, the larger part of their discharge is crowded into a brief space towards the end of the rainy season. Most of the streams diminish in volume as they descend into the valleys, and many of them disappear altogether as they wander across the blazing thirsty desert. Loaded with sediment, and more or less bitter with saline and alkaline solutions, they do little to redeem the lifelessness of these wastes.

Over the lower parts of the surface of the Basin are scattered numerous sheets of water. Where these have an outflow to lower levels they are fresh, as in the examples of Bear Lake, Utah Lake, and Tahoe Lake. But the great majority have no outflow. Some of them are merely temporary sheets of shallow water, appearing after a stormy night, and vanishing again beneath the next noon-day sun, or gathering during the rainy season, and disappearing in summer. Yet in some cases these transient lakes cover an area of 100 square miles or more. When they dry up, they leave behind them hard smooth plains of grayish mud, that crack up under the burning sun, and then look like a broken mosaic of marble. Of the permanent lakes the largest is the Great Salt Lake. It is also by much the most saline. Though all of them are more or less charged with alkaline and saline solutions, the percentage of these impurities is in some cases not so great as to prevent the water from being drunk by animals, or even on an emergency by man himself. Nothing in the physics of the Basin is more remarkable than the great diversity in the amount and nature of the mineral substances in solution in the lakes.

The vanished sheet of water, or "fossil lake," as the American surveyors call it, known as Lake Lahontan, lay chiefly in the north-west part of Nevada, but extended also into California. In outline it was exceptionally irregular, being composed of a number of almost detached strips and basins connected by narrow straits, and sometimes separated only by narrow ridges. It inclosed a rugged mountainous island 126 miles long from north to south, and 50 miles broad, which contained two lakes, neither of them apparently overflowing into the main lake. The Central Pacific Railroad passes for 165 miles through the dried-up bed of Lake Lahontan. From the windows of the car one can look out upon the ancient clay floor of the lake and mark the marginal terraces winding with almost artificial precision along the bases of the hills. The larger basins, which were formerly united into one continuous sheet of water, still hold lakes, all of which are more or less saline and alkaline, but they are far from being such concentrated brines as might be

expected were they due to the progressive evaporation of the large original lake.

In tracing back the history of this interesting topography, we are first brought face to face with the fact that the area of the Great Basin has within recent geological times been subject to powerful and long-continued subterranean movements. In numerous cases, rocks have been fractured and displaced to an extent of 4000 or 5000 feet. So recent are some of the fractures that they actually cut through the alluvial cones that stream out from the base of the mountains, and in numerous instances displace the terraces of the old lake to the extent of 50 or 60, or sometimes even 100 feet. There seems no reason to dispute the conclusion to which Mr. Russell and his colleagues have come, that the movements are actually still in progress, and that the constant occurrence of hot springs along the lines of recent fracture may be taken as evidence of the conversion of the subterranean movement into heat.

What may have been the topography of the region before the first depression and isolation of the Great Basin is still unknown. Doubtless the ground had undergone extensive denudation as well as great subterranean disturbance. Considerable irregularities of surface would also necessarily be produced by the intermittent discharge of volcanic rocks. When this uneven floor sank below the level of the surrounding tracts so as to become a basin of inland drainage, a magnificent series of lakes was established. Of these the largest, to which the name of Lake Bonneville has been given, and of which the Great Salt Lake is the diminished representative, covered an area of not less than 19,750 square miles. Lake Lahontan was of hardly inferior dimensions, these two hydrographic basins occupying the whole breadth of the Great Basin in the latitude of the 41st parallel. No fewer than fifteen other smaller basins have been discovered, which, though now either dry or partially covered with saline or alkaline waters, were well-filled lakes at a former period.

It is some years since Mr. Gilbert, from a study of the deposits left by Lake Bonneville, announced his conclusion that they bear testimony to a remarkable oscillation of climate between humidity and aridity. Similar deductions have now been drawn from the deposits of Lake Lahontan. Previous to the appearance of this body of water the climate is believed to have been at least as dry as it is at present, when alluvial cones were pushed outwards from the base of mountains into the area of the future lake. Then came a moist period, when the hollow of Lahontan was filled up with water to a depth of 500 feet above its present desiccated floor in the Carson Desert. At or about this height the water must have stood a long time, for it has deposited, along its rocky margin and round its islets, a thick mass of calcareous tufa. That the water, if not fresh, was at least not so saline as to be inimical to life, is shown by the abundant occurrence in it of fresh-water gasteropods. An epoch of aridity ensuing, the lake fell to so low a level as to become intensely bitter and alkaline, depositing thickly along its margin crystals, six or eight inches long, of gaylussite (a hydrated carbonate of soda and lime). The soda of these crystals having been subsequently removed, the deposit is one of tufa, mainly composed of calcareous pseudomorphs after gaylussite. Next followed a period of increased precipitation, when the lake rose to within 200 feet of its highest level, and when the thickest and most abundant of the tufa deposits of the region was laid down to a depth of sometimes 20 or even 50 feet. This third incrustation of tufa was formed mainly along the rocky shores and islands; but curious mushroom-like protuberances of it likewise gathered upon stones lying on the floor of the lake. The water then rose to the highest level it ever reached, since which time the climate has again become arid. From the fact that the isolated lakes of

the Lahontan Basin are not the saturated alkaline and saline solutions which they would certainly have been had they resulted from the evaporation of such a sheet of water as that in which the three tufa terraces were elaborated, it is inferred that the whole of the original lake was evaporated to dryness, and that its alkalis and salts, having been precipitated at the bottom, were covered over with a layer of mud so as to be partially protected from rapid solution. The existing lakes may thus be supposed to be the result of a subsequent diminution of the extreme aridity, but the time within which they have been in existence has not been long enough to enable them to become as bitter and saline as the original lake.

Such are some of the views which renewed exploration of this weird region has suggested to the able surveyors who have undertaken its investigation. Mr. Russell's report, lucid and interesting as it is, must be regarded as merely a prelude to the fuller results which he and his colleagues are gathering for the good of science, and to the credit of the admirably organised and administered Geological Survey of the United States.

#### NOTES

PROF. FLOWER, F.R.S., will preside at a meeting which it is proposed to hold on Tuesday next, July 1, in the lecture-room of the Natural History Museum, when Mr. R. Bowdler Sharpe will read a paper on the expediency or otherwise of adopting trinomial nomenclature in zoology. Many British naturalists have been anxious to meet the distinguished American naturalist, Dr. Elliott Coues, who is now on a visit to this country, and to exchange views with him on the subject of nomenclature. Invitations have been sent to a large number of the leading British zoologists, and an interesting discussion is expected.

THE Prince of Wales, President of the City and Guilds of London Institute, opened the Central Institution, Exhibition Road, yesterday afternoon at four o'clock. The Education Section of the International Health Exhibition, in the south wing of the Central Institution, was opened at the same time.

THE following additional donations to the Equipment Fund of the Central Institution of the City and Guilds of London Institute have been voted in response to the appeal of the Prince of Wales:—The Goldsmiths' Company, 4000*l.* (subject to confirmation); the Salters' Company, 525*l.*; the Cordwainers, 250*l.* The Plasterers have increased their annual subscription from 50 guineas to 100*l.*

IT is stated that the English Foreign Office is endeavouring to obtain the co-operation of the German Government in the International Educational Conference to be held at the South Kensington Health Exhibition about the middle of August. The Committee attaches special importance to the attendance of representative German pedagogues (this word being used in the higher and German sense) at this conference to read or communicate papers especially on the subjects of technical and secondary education and the organisation of universities; and it is particularly anxious to know, as early as possible, the names of any Germans of note who may be disposed to attend, and the subjects likely to be selected for papers.

A LARGE and influential deputation, including the Earl of Rosebery, the Earl of Fife, Mr. Stephen Williamson, M.P., Hon. R. P. Bruce, M.P., Prof. Cossar Ewart, Prof. Macintosh (St. Andrew's), a number of Scotch M.P.'s, and other gentlemen, waited last Monday on the Home Secretary with the view of impressing on the Government the importance of granting further funds to the Scottish Fishery Board to further scientific investigation into the habits of herring and other food fishes. The principal lines of proposed inquiry are: (1) The examination of the spawning beds around the Scottish coast with the

view of increasing the fishing, more especially on the west coast ; (2) the further collection of material for determining the nature of the food of the useful fishes met with on the Scottish coast ; (3) the further investigation of the percentage of immature herring and other food fishes destroyed under present methods of fishing ; (4) the investigation of the influence of sea-birds, parasites, &c., on the supply of food fishes ; (5) the study of the development, rate of growth, and general life history of the herring and other economic fishes, and the further study of the spawning process, and the nature of the eggs of fish ; (6) the determination of the best means of restocking deserted fishing grounds, by artificial cultivation or otherwise, of herring, cod, flat fish, &c. ; (7) the determination of the practicability of increasing the supply by artificial means of lobsters, mussels, oysters, and other shell fish ; (8) the inquiry as to the influence of fungi and other minute organisms in destroying the life of useful fishes, and the conditions which predispose to the attacks of these organisms. The Board estimates that a sum of at the very least 1000*l.* will be required during 1884-85 in order to carry on such inquiries properly. It would also immensely facilitate matters if the sailing cruiser belonging to the Board were superseded by a steam-vessel of somewhat larger size, and H.M.S. *Jackal* replaced by a seaworthy boat adapted for the work of a fishery cruiser. It is also of importance that the Admiralty should encourage and take part in scientific researches, not only on our own coasts but all over the world. Comparatively little has been done by Great Britain for the furtherance of our knowledge of the nature and habits of fish on her coast, important as these are as articles of food and commerce. The Board confidently anticipates that with the assistance now asked the investigations would yield most excellent results, as the Board is already an institution with a large staff of intelligent officers capable of making observations, collecting materials, &c., as several distinguished naturalists and the scientific members have promised to assist it gratuitously, and, moreover, that the exertions already made have yielded results of the highest promise. The deputation was most favourably received.

THERE has been considerable alarm recently with reference to the parasites in that useful and plentiful fish, mackerel ; so much so that Prof. Huxley has thought it advisable to write a letter to Mr. J. L. Sayer of Lower Thames Street, showing that any such alarm is unnecessary :—"It is perfectly true," he writes, "that mackerel, like all other fish, are more or less infested by parasites, one of which, a small thread-worm, is often so abundant as to be conspicuous when the fish is opened. But it is not true that there is any reason to believe that this thread-worm would be injurious to a man, even if he swallowed it uncooked and alive, and to speak of it as a possible cause of cholera is sheer nonsense. I have no doubt that the 'excessive use of mackerel and mild ale,' whether separately or in combination, would be followed by unpleasant results, not only at this season of the year but at any other. But I undertake to say that the consequences would be the same whether the fish contained thread-worms or not. It is very much to be regretted that the food-supply of the people should be diminished, and that the fishing population should be robbed of the fruit of their labours by the authoritative propagation of statements which are devoid of foundation ; and if you think the publication of this letter will be of any use to the public and to the fishing interest, it is at your service."

A *conversazione* will be held at the International Health Exhibition by the Council of the Society of Arts, in conjunction with the Executive Council of the Exhibition, on Wednesday, July 9. The whole of the buildings will be open, and the gardens will be illuminated.

THE Council of the Society of Arts have awarded the Society's Silver Medals to the following readers of papers during the

Session 1883-84 :—The Most Hon. the Marquis of Lorne, K.T., for his paper on "Canada and its Products" ; Rev. J. A. Rivington, for his paper on a "New Process of Permanent Mural Painting, invented by Joseph Keim" ; C. V. Boys, for his paper on "Bicycles and Tricycles" ; Prof. Fleeming Jenkin, F.R.S., for his paper on "Telpherage" ; I. Probert, for his paper on "Primary Batteries for Electric Lighting" ; H. H. Johnston, for his paper on "The Portuguese Colonies of West Africa" ; Prof. Silvanus P. Thompson, for his paper on "Recent Progress in Dynamo-Electric Machinery" ; Edward C. Stanford, F.C.S., for his paper on "Economic Applications of Seaweed" ; W. Seton-Karr, for his paper on "The New Bengal Rent Bill" ; C. Purdon Clarke, C.I.E., for his paper on "Street Architecture in India." Thanks were voted to the following Members of Council for the papers read by them :—W. H. Preece, F.R.S., vice-president of the Society, for his paper on "The Progress of Electric Lighting" ; B. W. Richardson, M.D., F.R.S., vice-president of the Society, for his paper on "Vital Steps in Sanitary Progress" ; Col. Webber, R.E., C.B., Member of Council, for his paper on "Telegraph Tariffs" ; B. Francis Cobb, vice-president of the Society, for his paper on "Borneo" ; J. M. Maclean, Member of Council, for his paper on "State Monopoly of Railways in India" ; W. G. Pedder, Member of Council, for his paper on "The Existing Law of Landlord and Tenant in India."

THE Italian Government proposes to found a central magnetic observatory at Rome, to be placed under the direction of the Meteorological Office. The Government asks for a vote of 176,000 francs, in addition to an annual sum of 5550 francs for general expenses, and 11,500 francs for *personnel*.

THE *Times* Berlin correspondent, telegraphing on Thursday last, states that the reddish-brown atmosphere and the peculiar appearance of the sun and sky which were noticed last year, especially in November, reappeared on the previous evening almost as vividly as ever.

THE results of the analyses made at the Municipal Laboratory of Paris are so satisfactory that tradesmen of that city are holding indignation meetings on behalf of the liberty of watering their liquors and mixing the different kinds of wine. It is needless to state that the public and the administration are equally hostile to any alterations being made in the existing law. But greater precision will now be introduced into the verdict of the experts, and when they declare any liquor to be bad they will state whether it is by adulteration, or alteration of its primitive elements, or mixing with inferior sorts. The development of the institution is so important that forty persons are now engaged in this kind of work. Similar institutions have been created in provincial cities, and a central administration established in Paris. The late M. Wurtz was the head of this useful Bureau ; his place is now filled by M. Berthelot.

THE Russian Admiralty has under consideration a plan for an expedition to the North Pole, with a view to benefit by the experience gained by the *Jeannette* disaster. The expedition is proposed to start from the Jeannette, Bennet, and Henriette Islands, where large depots will be established. The journey will be continued thence to Franz-Josef Land by steamer, and further northwards by sledges and on foot. The expedition would be divided into three parties, the first of which would act as a kind of vanguard, the two following not moving forward until suitable camping places had been found and depots established. This system would make the progress safe and systematic. It is estimated that the expedition would require three years to reach the Pole and to return to Northern Siberia. The expenses of the same will probably be covered by a national subscription, the Government, and the Russian Geographical Society.



THE Prussian Government having requested the Swedish to effect measurements of the tide, &c., on the Swedish coasts in the Baltic, similar to those which for some time have been carried out on the Pomeranian coast, Capt. Malmberg and Prof. Rosen have been commissioned to visit the German stations during the summer, and select the most suitable places on the Swedish coast for realising this proposal.

THE Norwegian Storting has voted the entire sum proposed for scientific and literary purposes—about 5000*l.* Among these we note 150*l.* to the *Technical Journal*, 350*l.* to Dr. Norman's "Flora," 60*l.* to Dr. Sophus Tromholt for prosecuting his auroral researches, 50*l.* each to the *Acta Mathematica* and the "Fauna litoralis Norvegiæ."

AT Weimar, Munich, Elberfeld, and some other German towns have been erected what are called "pyramids of instruction." They show on their various faces the elevation of the place above the level of the sea, the population, the difference of local time from that of Vienna, Paris, London, New York, &c. There are also a clock, barometer, thermometer, vane, and a variety of statistical information.

MR. H. W. EATON of Louisville, Kentucky, writes to *Science* that the *Commercial* of that city for May 17 and 18 gave accounts of a tailed child recently born there. As such cases are of scientific interest, and are very rare, a party of four, including a prominent doctor and Mr. Eaton, concluded to investigate the case. "We found a female negro-child, eight weeks old, normally formed in all respects, except that slightly to the left of the median line, and about 1 inch above the lower end of the spinal column, is a fleshy pedunculated protuberance about 2½ inches long. At the base it measures 1¼ inch in circumference. A quarter of an inch from the base it is somewhat larger, and from that it tapers gradually to a small blunt point. It closely resembles a pig's tail in shape, but shows no sign of bone or cartilage. There seems to be a slight mole-like protuberance at the point of attachment. The appendage has grown in length about a quarter of an inch since the birth of the child. The mother, Lucy Clark, is a quadroon, seventeen years old, and the father a negro of twenty,—both normally formed. In Darwin's 'Descent of Man,' vol. i. p. 28, he speaks of a similar case, and refers to an article in *Revue des Cours Scientifiques*, 1867-68, p. 625. A more complete article is that by Dr. Max Bartels, in *Archiv für Anthropologie* for 1880. He describes twenty-one cases of persons born with tails, most of them being fleshy protuberances like the one just described."

ON May 27, at about 8.45 p.m., immediately after sunset, a magnificent meteor or fireball was seen at Skonevik, on the west coast of Norway. It went in a perfectly horizontal line to north-north-west, leaving a bright tail behind appearing like steam. This trail was distinctly observable for quite five minutes, when it gradually spread in the shape of a light cloud, which was soon hidden in the approaching darkness. About two minutes after the ball had passed out of sight a loud report was heard in the same direction; it was very much like ordinary thunder heard from a distance, with the exception of its lasting twice as long. The sky was perfectly clear, and several persons witnessed the phenomenon. The meteor was also observed in the Kvinsherød parish.

ANOTHER "blue grotto," or, rather, series of three large grottoes, 87 metres in length, has been discovered on the Dalmatian island of Buoi, lying to the south-west of Lissa. The cave is described by its discoverer, Baron Ramsonnet, Austrian Secretary of Legation, as surpassing the famous Capri Grotto.

THE additions to the Zoological Society's Gardens during the past week include two Macaque Monkeys (*Macacus cynomolgus* ♀ ♀) from India, presented respectively by Mr. Howard

Lane and Madam Kettner; two White-fronted Capuchins (*Cebus albifrons* ♂ ♀) from South America, presented by Mr. Messum; a Coypu (*Myopotamus coypus*) from South America, presented by Mrs. Constance Keely; a Harpy Eagle (*Thrasaetus harpyia*) from South America, a Red-billed Tree Duck (*Dendrocygna autumnalis*) from America, presented by Capt. H. King; a White-tailed Buzzard (*Buteo albicaudatus*) from America, presented by Mr. Lewis; a Wedge-tailed Eagle (*Aquila audax*) from Queensland, presented by Mr. Henry Ling Roth; two Choughs (*Pyrrhocorax graculus*), British, presented by Mr. J. Compton Lees; a Gray-breasted Parrakeet (*Bolborhynchus monachus*) from Monte Video, presented by Mrs. Moore; two Cape Crowned Cranes (*Balaerica chrysolargus*) from South Africa, presented by Mr. J. R. Chapman; a White Stork (*Ciconia alba*), European, presented by Mr. Hubert D. Astley; a Partridge (*Perdix cinerea*), British, presented by Mr. George Rubie; a Blue and Yellow Macaw (*Ara ararauna*) from South America, deposited; a Brush-tailed Kangaroo (*Petrogale penicillata*) from New South Wales, four White Storks (*Ciconia alba*), three European Pond Tortoises (*Emys europæa*), European, a Common Boa (*Boa constrictor*) from South America, purchased; a Black-necked Swan (*Cygnus nigricollis*) from Antarctic America, received in exchange.

#### OUR ASTRONOMICAL COLUMN

THE OXFORD UNIVERSITY OBSERVATORY.—The Savilian Professor of Astronomy has issued his Annual Report to the Board of Visitors of the University Observatory, which was read on the 5th of the present month, and forms a supplement to No. 493 of the *Oxford University Gazette*. The attendance of students at the lectures has been greater than at any previous time, and the Professor mentions "the phenomenon" of the regular appearance of two ladies at his lectures on the planetary and lunar theories, at the same time reminding the Board what even the approximate mastery of such theory implies.

On the astronomical work of the staff of the institution during the year, Prof. Pritchard's Report is a most favourable one. He refers to three memoirs on important astronomical questions which have issued therefrom, and which have been printed in the *Memoirs of the Royal Astronomical Society*. These include an extensive memoir by himself on the "Photometric Determination of the Relative Brightness of the Brighter Stars North of the Equator," in which his work at Cairo is brought to bear, and a memoir by the first assistant, Mr. W. F. Plummer, on the probable motion of the solar system in space, the data for which depend upon Mr. Stone's recent catalogue of southern stars; it is a memoir very similar in character to the well-known one by the late Mr. Galloway. Further, Prof. Pritchard has communicated to the Royal Astronomical Society a paper which was read at the last meeting, demonstrating, as he thinks, the existence of small displacements among the Pleiades. Upwards of a thousand measures of the relative brightness of stars were made, leaving about the same number to be made in the next year. This measurement of all the naked-eye stars from the Pole to the Equator will furnish a *Uranometria Nova Oxoniensis*, and Prof. Pritchard hopes that its publication may be undertaken by the University Press. The measures of the Pleiades having been completed, he now intends to devote himself to lunar work—the determination of selenographical longitude and latitude of a large number of points on the moon's surface by means of a valuable series of lunar photographs at the Observatory. Reference is made, in addition to the Pleiades work, to the existence of measures of some 250 stars in another cluster made at the Observatory a few years since, and to be shortly reduced and published; the particular cluster is not indicated in the Report, but presumably may be M. 39 in Cygnus, described by Messier when he observed it in 1764 as "a star-cluster of 1° diameter."

VARIABLE STARS.—In a communication to the Liverpool Astronomical Society Mr. Baxendell notifies that his determinations of the times of eight maxima between 1861 October 16 and 1881 November 21 are not satisfied by a constant period, but that, dividing them into two groups, he obtains the following results:—

Group 1. Mean period 206.37 days. Ep. 1864 Jan. 17.47.  
Group 2. Mean period 212.52 days. Ep. 1880 Sept. 24.21.

Such a difference is well worthy of further investigation. The magnitude at maximum has varied between 7.8 and 9.3.

There does not appear to be any earlier observation of this star than that by Bessel on January 6, 1833, when it was estimated a ninth magnitude. It was not observed either by Lalande or D'Agelet. Prof. Schönfeld's elements in his second catalogue, which assume a uniform period of 208.8 days, would give a maximum on October 6, 1881; according to Mr. Baxendell, it took place on November 21.

Communications from Mr. Knott and Herr Wilsing, of the Observatory, Potsdam, on Ceraski's short-period variable, U Cephei, have appeared in the *Astronomische Nachrichten*. Mr. Knott, from 20 minima observed by him between 1880 October 23 and 1884 March 20 finds for elements—

Ep. 1882 April 19.92641 G.M.T. + 2.4928722 d. E.

Herr Wilsing has collected 61 minima by different observers between 1880 July 3 and 1884 April 9, and finds (similarly expressed)—

Ep. 1881 Nov. 21.34640 G.M.T. + 2.4928646 d. E.

To the suspected circumpolar variables recently named in this column may be added Bradley 392, which figures in our catalogues with various estimates of magnitude from 4.5 (Argelander's Zones) to 7 and 8 (Taylor and Lalande); generally, however, it has been called a sixth magnitude. Doubtless in many, perhaps in most, cases, such discordances arise from errors of estimation, through clouds, &c., or from misprints, but in others, as in the case of Schwed's magnitudes of U Cephei (6.7, 8, 10 respectively), they are known to have been caused by a real fluctuation in the star's brightness, and hence it seems worth while to examine similar instances of disagreement in the catalogues.

MISSING NEBULÆ.—In Rümker's Catalogue are two objects observed as nebulae which were missed by D'Arrest and Auwers. In No. 1542 of the *Astronomische Nachrichten* Mr. G. Rümker has given the particulars of the observations from his father's manuscripts. The first nebula was observed on May 27, 1841, and its apparent place was R.A. 13h. 52m. 38.20s., Decl. + 45° 36' 13.78". The Hamburg mean time of the observations was 9h. 31m. 43s. In the *Durchmusterung* we find a star thus—

8.8 ... 13h. 53m. 10.0s. + 45° 31' 7 ... R.

Consequently Argelander identifies this star 8.8 m. with Rümker's nebula. Two questions arise in such a case, and not for the first time: Was a comet projected on the place of Argelander's object at the time of Rümker's observation? or (more improbably), Was the star at that time surrounded by nebulosity which has since become invisible? Bessel, we know, observed a nebulosity on November 8, 1832, in a position where only a star 9.3 m. was subsequently seen by Argelander and D'Arrest. We refer to Rümker's first nebula more especially because its place was not very far from that which might have been occupied by the third comet of 1858, recently shown to be periodical by M. Schulhof. If that comet were at perihelion about 1841 April 21.8, its right ascension might have agreed with that of Rümker's nebula, but the declination would be given by calculation about 6° further north. Whether with the consequent period of revolution, which, assuming three periods, 1841-58, would be near M. Schulhof's lower limit, the action of the planet Jupiter during the first revolution could have caused such difference from the orbit for 1858 as to reconcile the discordance in the observed and computed declination, we cannot say, though it hardly appears likely. Still it may be worth while to mention the above approximate coincidence, as M. Schulhof has searched unsuccessfully for an indication of a former appearance of the comet in question.

### GEOLOGICAL NOTES

TRICLINIC PYROXENE.—Mr. J. J. Harris Teall points out to us that since the paper was written on this subject by Mr. Whitman Cross, to which reference was made in NATURE (*ante*, p. 155), this author has found that, after reconsidering the matter in the light of the researches of Fouqué and Michel Lévy on the optical properties of monoclinic pyroxene, a great majority of the instances cited by him as indicating a triclinic pyroxene are explainable as augite, and that the few cases which still seem

anomalous are not in themselves sufficient to justify a reference to the triclinic system. The mistake was made in specimens not cut rigidly parallel to the axis, for it appears that the ellipsoid of elasticity is so situated as to produce very great variations in optical behaviour in sections which are but little inclined to each other. [*Amer. Journ. Science*, No. 151, xxvi. p. 76].

THE BRUSSELS MUSEUM AND ITS WORK.—The second volume of the *Bulletin of the Musée Royal d'Histoire Naturelle de Belgique* has just been completed by the issue of a fourth fasciculus. In this part geology and palæontology continue to assert their supremacy. M. Dollo supplies a paper on a gigantic fossil bird (*Gastornis Edwardii*, Lemoine) from the lower part of the Landenian stage at Mesin, near Mons. Having completed the summary description of the Iguanodons, but not being yet in a position to publish his expected large monograph on that important group, he has in the meantime turned to the Crocodilians of Bernissart, of which he furnishes here a preliminary notice. They consist of four individuals capable of division into two well-marked groups—two large specimens indicating an animal about two metres in length, to which he gives the name of *Goniopholis sinus*, and two small forms which he regards as belonging to a new genus, named by him *Bernissartia*. M. Ernest Van den Broeck, following up the memoir published in a previous number of the *Bulletin* by his colleague, M. A. Rutot, offers a note on a new mode of classification and of graphic notation for geological deposits, based upon the study of marine sedimentation. The veteran palæontologist, Dr. L. G. De Koninck, contributes an essay on the *Spirifer mosquensis* and its affinities with other species of the same genus.

GEOLOGICAL SURVEY OF BELGIUM.—Appended to the last number of the *Bulletin of the Musée Royal* is a Report by M. Dupont, Director of the Museum, on the state of the detailed geological map of Belgium, which is being prepared under his supervision. The preliminary examination, which was estimated to require six years, having been completed, the continuous survey of the formations has been prosecuted, each important group being intrusted to an officer specially qualified for its investigation. Nineteen sheets are in the course of preparation for publication. Of these the greater number belong to the remarkable Devonian territory which forms so interesting and important a part of Belgian geology. We see from the map that these sheets are mainly the work of M. Dupont himself. He spent 100 days in the field last year almost entirely among the Devonian rocks. M. Mourlon devoted his time to tracing the area of the Famennian beds. The third section, under the charge of M. Van den Broeck, has made progress among the oligocene Tertiary deposits of Central and Northern Belgium. The fourth section, supervised by M. Rutot, spent half of the season in mapping the Eocene deposits of Limbourg, and the remainder in prosecuting the investigation of Hainault, Brabant, Flanders, and the study of the Upper Cretaceous rocks and base of the Eocene series, the Eocene part of three sheets being finished. Dr. Purves, in charge of the fifth section, has devoted his energy to the mapping of the Jurassic rocks of Luxembourg, and the study of the Cretaceous series of Hainault and Limbourg. The total number of days spent in field-work by the whole staff has been 512.

GEOLOGY OF FINMARK.—Mr. Karl Pettersen continues his contributions to our knowledge of the geology of the Norwegian coast. In a recent memoir (*Archiv for Math. og Naturvidenskab*, Bd. viii. p. 322) he describes that picturesque tract lying between the mouth of the Kvenangen Fjord and the Refsbotten, which includes the lonely Jökelfjord and Bergsfjord with the islands of Stjernö, Seiland, Sörö, and Kvalö. The greater portion of this area is occupied by various crystalline rocks—gneiss, mica-schist, gabbro, diorite, &c.—referred by the author to the Laurentian series. Above these lie certain certain mica-schists with included beds of limestone, which, under the name of the Tromsö mica-schist group, are assigned to the Cambrian system.

AMERICAN JURASSIC DINOSAURS.—In the *American Journal of Science* (April 1884) Prof. Marsh continues the valuable series of papers which he has contributed to our knowledge of the structure and affinities of the Jurassic Dinosaurs. In part viii. he discusses the carnivorous order Theropoda, two nearly perfect skeletons belonging to which have enabled him to throw some new and most important light on the order. An almost perfect skeleton, above seventeen feet long, has been named by him *Ceratosauros*, and presents some novel features in dinosaurian organisation. It has a large horn on the skull, a new, strange,

and unexpected type of vertebra, a pelvis with all the bones co-ossified as in existing birds, and a set of osseous dermal plates extending from the base of the skull along the neck over the vertebrae.

GEOLOGICAL SURVEY OF NEW ZEALAND.—Dr. Hector's Report for 1882 has just been received. It contains some additions to our knowledge of the geological structure of the country, but these do not involve any marked alterations in the system of classification already adopted for the formations, but rather tend to establish its general applicability. The Report is specially characterised by the attention paid to the development of the mineral resources of the colony. Mr. S. H. Cox, in compliance with specific instructions, made a careful examination of the gold-fields of the Cape Colville Peninsula and of other mineral tracts, while Mr. A. McKay reported on some antimony and other lodes. The geology, petrography, and palæontology of the islands have likewise received attention. The schists of the Reefton district are regarded as a metamorphic series of Silurian age, as they can be traced into fossiliferous Silurian strata. The granite-porphyrates by which they are traversed were intruded into them subsequent to the Devonian rocks. The metamorphic series is covered in some places by the Devonian beds, from which fossils have been obtained at a number of new localities. The auriferous rocks of Reefton are referred to the Matai or Carboniferous formation, and are believed to lie unconformably on the younger Devonian rocks. The Cretaceous and Cretaceous-Tertiary series form a continuous sequence in which coal has long been known to occur. Seams of coal, four to ten feet thick on an average, characterise certain horizons, one seam at the head of the Murray Creek reaching even to thirty or forty feet. The coarse sandstones and grits among which the coals lie are represented as being conformably overlaid by Miocene gravels.

THE AUSTRIAN GEOLOGICAL INSTITUTE.—This admirable organisation, under the energetic management of its Director, F. Ritter von Hauer, shows no sign of any diminution in its activity or of any lessening of the wide scope of its labours. Among the recent numbers of its *Verhandlungen* some interesting papers have appeared, of which may be mentioned: A. Bittner, on the Limestone Alps of Salzburg; E. Tietze, on the occurrence of turquois in Persia; V. Hilber, on the geology of the region between Krzyzanowice and Tarnobrzeg; D. Stur, on some fossil plants from South Wales; A. Böhm, on geothermal lines under mountains. The last two numbers of the *Fahrbuch* are full of important memoirs. Among these reference may be made to Bittner's Report on the survey of the Triassic region of Recoaro; Paul's "Recent Additions to our Knowledge of the Carpathian Sandstone"; Dr. Tietze's essay on the geology of Montenegro, and the continuation of his contributions to the geology of Galicia.

#### ON NORTHERN NORWAY UNDER THE GLACIAL AGE

*THE Stream of Inland Ice.*—From the broad sound between the Kval Island and the province of Finmarken, from which the Troms Island juts forth, the Kval Sound—about 20 km. in length—leads to the open ocean. Outside the Kval Sound several little islands rise from the sea, while beyond the coast is girded by holms and rocks termed the "Skjærgaard." A little south of the Troms Island the Balsfjord, about 60 km. in length, cuts into the land, closed at the bottom by small ridges leading up to the valley in which the Maals River flows, and to the borderland between Norway and Sweden, chiefly through the long Divi Valley. The borderland embraces large mountainous tracts, where peaks rise to an elevation of 1569 m., crossed by dales and high valleys.

In the district described, the local conditions during the Glacial age seem to have been remarkably suited to the formation of large masses of ice. These would have their natural outlet towards the Maals River, through the Divi Valley, and the main stream has no doubt therefrom flown down the Maals Valley, but an arm may have curved more to the north along the northern slope of the Mauken ridge, and by ice-streams from this and from the gigantic high plateaux around the Maar peaks down to the bottom of the Balsfjord. From here the joint stream would have moved further forward to the sounds along both sides of the Troms Island, and thence, through the Kval Sound, over the islands in the Skjærgaard. The channel described has a length of 215 km.

As is generally known, the inland ice of Scandinavia is assumed to have shot far beyond the edges of the peninsula. Thus from Southern Norway the inland ice is believed to have moved forward along the fjords, and filled the entire North Sea as far as England, while further north it has been curved in a more northerly direction, by the ice-streams issuing from Scotland, towards the Orkneys and the Shetlands. It might be supposed that similar conditions existed during the Glacial period in the north of Norway; but from what is known at present there is nothing indicating that the Glacial age has appeared in a more severe form in the southern than in the northern part of Norway; it seems, in fact, from the geographical situation of the land, that the reverse must have been the case. There are besides, as I will presently show, indications which seem to demonstrate that the ice-masses of the Glacial age, at all events in certain parts of Northern Norway, have attained an extent which equals those of Southern Norway, as, for instance, those along the Sognefjord, 1700 m. to 1800 m. in depth. On the high plateau behind the Divi Valley, close to the frontier, the cone of the Great Jerta, built of amphibolitic slate, rises to a height of 1569 m. Nowhere have granite strata been found intercepting this slate. On the top of this peak a large travelled granite block was found, which in most probability has been transported thither from the extensive granite field which stretches forward on both sides of the frontier. The ice which has moved down the Divi Valley must therefore have been very nearly 600 m. in depth.

There seems every reason to suppose that the channel from the bottom of the Balsfjord to the Skjærgaard has, during the Glacial age, boasted a comparatively uniform depth; and, supposing the sea to have been about 188 m. higher than at present, this channel would nowhere have been deeper than 470 m. An ice-stream moving forward by this channel, and which probably had a thickness of 1600 m., must have moved forward along its bottom, and most probably with a quick motion. If the ice-streams from the south-west of Norway have, as assumed, moved forward, and filled not only the fjords to the bottom, but the entire North Sea to England, we may conclude that this should also have been the case in the channel in question during the Glacial period. If this has been so, marked traces of such an ice-stream would, no doubt, have been visible from the very bottom of the Balsfjord right out to the Skjærgaard; but the researches made here point in a different direction. I will elucidate this by following the channel referred to from the ocean coastwards.

About 11 km. from the mouth of the Kval Sound, in the open ocean, lies the little Ris Island, surrounded on south, west, and north by a great number of tiny islands, reaching a height of 100 m. It is formed of a ridge running north to south, in the west sinking abruptly into the sea, but which in the east sinks into a low-lying plain, from which several isolated knolls spring forth. Several of these knolls are connected with the main island by sand dunes, and have most probably at no distant time formed separate holms. Most of the numerous holms surrounding the Ris Island are small, and only rise a few feet above the water. The mineral of which this group of islands is formed is a hard kind of gneiss, greatly interspersed with granite more or less pure; the mineral is, in fact, with its petrographical variations and forms, rather to be considered a kind of granite-gneiss, a name which is given to it in these parts. The strike of the granite strata is, roughly speaking, north to south, with a sudden dip to the east. By its structural condition this mineral should be greatly affected by smoothing and polishing agencies, and also retain the traces of such. Should, therefore, the inland ice at a certain period have moved forward along the Kval Sound, the group of islands around the Ris Island would undoubtedly bear the most patent indications of this action. The polishing phenomena are often met with at lower levels, which either lie within the littoral belt, at high tide under the sea, or rise only a few feet above high tide, but with the sea continually washing over them. At higher elevations these phenomena are rarely discovered. Here severe destructive forces have been at work on the previously polished surfaces, and the numerous sea-birds breeding on these islands have further contributed to the corrosion.

Several circumstances seem, however, to indicate that the polishing in question cannot be referred to the scourings of the ice in the Glacial period, but is of a far later date. The rapid destruction seems in fact to demonstrate that the smoothing must be referred to agencies of shorter duration. The smooth,

ings which are shown—certainly not very marked—seem to point in this direction, while the smoothing along the lower levels of the holms referred to above are generally met with more in the parts most exposed to the fury of the sea than inland. The smoothing appears but rarely in spots on the lee side of the ocean, even where they might be assumed to have been very exposed to the glaciers. I have therefore come to the conclusion that the smoothing phenomena observed here must be ascribed to the erosion of the sea, which, under its action in the littoral belt, carries with it finer as well as coarser materials of scouring. Striæ have nowhere been observed on the Ris Island or the surrounding islands.

If ice-streams from the southern part of the Scandinavian peninsula have carried blocks from the mountain plateaux of Sweden and Norway across the Central European plain to England, to the Orkneys, and the Shetlands, an ice-stream moving along the Balsfjord and further along the channel described above through the Kval Sound should naturally have progressed in the same manner, and strewn blocks along its whole course. This is, however, not the case. On the Ris Island, thus, and surrounding islands, not a single boulder or travelled block whose place of birth could have been on the upland behind has been found. The mountains along the Balsfjord and towards the Troms Island is mostly built of slaty minerals, such as glimmer-slate (interspersed with crystalline chalk), quartz, sandstone-like slate, &c. Such minerals might have been greatly subjected to being ground away during a longer transport, and that travelled blocks of this kind are not found might be ascribed to this circumstance; but among the travelled blocks strewn over the Central European high plateau there are found also many of slate, which are supposed to have been transported thither from Scandinavia, and if these have been able to resist the destructive agencies during such a long transport, they would decidedly have done so here where the distance is so short.

Among the softer minerals forming the mountains from the Balsfjord there frequently occur strata of harder nature, as, for instance, of gneiss, massive amphibolites, and eclogites, while Saussurite appears in the bottom of the fjord. There are minerals whose composition would enable them to resist the severest destructive agencies even during the longest journey. The total absence of foreign travelled blocks on Ris Island and adjacent holms is therefore hardly to be reconciled with the supposition that continuous streams of ice from the inland moved thither. Neither is moraine drift met with about the archipelago in question.

Just north of the Ris Island, the Sandviks Island, 407 m. in height, rises above the sea. Along the whole eastern side extensive accumulations of sand containing marine shells are met with to a height of 63 m. In the higher-lying layer the sand is, however, poor in such remains, although fragments may be found at an elevation of 56 m. Here it seems as if the coast districts must have been earlier denuded of the local glaciers of the post-Glacial period than the upland behind. Along the Troms Island and the adjacent district the shell-bearing layer of sand is never found above 13 m., while in the clay deposits along the rivers fossil shells are never found at a higher elevation than 38 m. The Troms Island has, however, at a time when the sea in relation to the rock was 40 m. higher than at present, been greatly covered by local glaciers, while the coast district beyond must have been almost free from such. The conditions for the development of a more copious fauna of mollusks have thus existed along the outer coast earlier than in the fjords behind. It appears therefore that during the transition from the Glacial to the post-Glacial period the milder climate has spread from the sea coastwards, although, as it seems, very slowly.

We now turn to the district behind the channel referred to, particularly to the little Troms Island, where there has been special opportunity of examining these indications. The island is 11 km. long and 157 m. in height, and, lying just in the flow of the ice-stream, was situated so that the travelling glaciers should have left lasting traces on it. By a cursory glance the glacialist is led to believe that the markings must be referred to the streams of inland ice, particularly as the island is all along the southern part, at higher as well as at lower elevations, covered with a layer of drift from the "ground" moraine several feet in thickness, while old boulder drift-wolds may be seen in several places. Besides this, foreign travelled blocks are strewn in great numbers along the sides of the island, while striæ

appear in many places along the littoral belt and adjacent levels. A closer examination will, however, put these indications in a different light. Thus, with regard to the boulder drift, it will be found that most of the stones and blocks embedded in the same belong to the island itself, and none can with certainty be asserted to have belonged to mountains beyond the island. These drifts must therefore be ascribed to local glaciers, which at one time partly covered the island. With regard to the striæ, which appear in some places at lower levels, I am of the opinion that they were made in what is at present the littoral belt. Foreign travelled blocks, *i.e.* those consisting of various species of granite, are, as stated, only found here at low levels, *viz.* from the present seashore to an elevation of 38 m. These blocks have, however, I believe, been transported thither by floating glaciers. The elevation, even, in which they are found, indicate that the transport of these foreign blocks can only have begun at a period when the more continuous layers of inland ice were broken up.

The district along the Balsfjord is, on the other hand, to a great extent built of the same kind of crystalline slate rocks which form the Troms Island, and it is therefore impossible to deny with certainty that there are boulders in the drift which have been carried from the land behind. But there is another circumstance which I believe will make this point plainer still. Between the minerals of the district around the Balsfjord there is, as stated above, also a stratum of Saussurite gabbro, which at the bottom of the fjord is of enormous thickness. The Saussurite gabbro is a remarkably tough rock, especially qualified to resist the destructive agencies under a long transport. Should therefore a continuous stream of ice at one time have moved forward along this fjord and its bottom, there seems every reason to assume that fragments of Saussurite gabbro would have been carried with it and now be found along its track, which should particularly be the case with the Troms Island, more advantageously situated for receiving the same than any other spot. But in spite of the most careful search the scientist has not succeeded, either between the loose, solitary blocks or in the Glacial drift here, in discovering a single fragment of Saussurite gabbro. There is, therefore, every reason to assume that the ice-streams which moved down the Balsfjord cannot have reached the Troms Island.

If this conclusion be correct, traces of the Balsfjord ice-stream will not be found along the channels outside, *i.e.* north of Tromsø, *viz.* neither in the Kval Sound nor in the others in which the ice moved to the sea. There has not been any opportunity of proving this, but from impressions during my frequent journeys along these inlets, I can with confidence assert that no travelled blocks will be found here either whose birth-place was on the upland behind.

A few years ago I examined the greater part of the mouth of the Balsfjord, and I have neither there observed travelled blocks which were transported from the bottom of the fjord. I have therefore come to the conclusion that the continuous ice-stream of the Glacial period cannot have reached beyond the basin of the fjord.

From the premises thus set forth we may draw the deduction that the inland ice in North Norway during the Glacial age did not move forward along the above-described line, *viz.* through the sounds to the ocean, while we may presume that neither did they travel through the Balsfjord.

By the foregoing line of argument the conditions of Northern Norway must have differed greatly from those which we assume prevailed in Southern Scandinavia under the Glacial period. These two deductions, so much at variance, lead to the following conclusions: (1) That either the Glacial period must have appeared in a far severer form in the southern than in the northern part of the peninsula, or (2) that the conclusions here arrived at are based on an erroneous construction of the evidence presented to us.

With regard to the first of the points, I have already pointed out that every sign seems to indicate that somewhat similar conditions prevailed throughout the Scandinavian peninsula during this period. If thus the inland ice in Northern Norway was not powerful enough to move to the ocean along the sounds, there is but little probability of the conditions having differed in this respect in the southern part. And if, on the contrary, this has been the case in the southern half of the peninsula, there is every reason to suppose that it was so also in Northern Norway, and that ice has moved coastwards, scouring the surface wherever the depth permitted. It seems, therefore, necessary to assume that

the second suggestion is correct, and that erroneous conclusions have been arrived at. There seems, for instance, reason to suggest that these deductions, even if logically correct for the district delineated, may not apply to the entire northern half of Norway in general before they have been more extensively corroborated. As to this suggestion, I may reply that the district described above comprises a great area. It includes thus channels of continuous fjords and sounds close upon 120 km. in length, and a coast line 90 km. long, and what is most important, that the channel in question is one which, by the orographical structure, has offered one of the most suited channels for the flow of the ice. If the inland ice has not been powerful enough to move forward by this channel, there is, I believe, little probability of finding a single similar channel in Northern Norway in the district between Salten and the North Cape by which the inland ice has moved to the coast.

If, on the other hand, the southern part of the Scandinavian peninsula is examined, where the inland ice is supposed not only to have filled the fjords but also the entire North Sea and the Baltic, such a circumstance presupposes, in my opinion, conditions so gigantic that they may even from the first be doubted. In fact, the area of the snowfall from which these enormous masses of ice must have been originated is not proportionate to the supposed results. Anything corresponding with such a result is not to be found even within the Arctic zone, which at present suffers most from glaciation. The Polar basin itself is, I believe, nowhere filled with ice masses, which reach the bottom. It is, in my opinion, filled with sea ice in constant drift.

My deduction is, therefore, that the theory of the ice-streams from the Scandinavian peninsula having advanced and covered the North Sea, the Baltic, and reached the Central European plain, England, the Orkneys, and the Shetlands, cannot with the facts at our disposal be accepted as a scientific doctrine.

*Travelled Granite Blocks in the Neighbourhood of Tromsø.*—Of the loose blocks and boulders which are found in such large numbers about this town, partly embedded in the sand, and partly in old moraine drift, or strewn over the ground, the greatest number had their origin in the solid mountains in the vicinity. These may, as we may have reason to assume, be found at the most different elevations, as the agencies which produced them have been in continuous action down to our time. Real travelled blocks, transported to their present place from a distance, appear also in quantities in this district, but the latter seem to be confined to certain levels. Of these foreign kinds of travelled blocks, most are of granite, and I draw particular attention to these, not only on account of their frequent occurrence, but also from their great dimensions, a great many being thus from a half to one cubic metre, and more. These blocks are mostly rounded, without, however, showing any greater polishing. Striae are never found on them.

They appear in greatest number up to a height of 25 to 30 m., and more seldom between 30 and 38 m. Up to the former height they are everywhere to be found, while in higher elevations they are difficult of discovery. The line of demarcation upwards is pretty distinctly defined, but the blocks are not always to be found to the above height. There are lines along which the granite blocks are heaped up to this height, and beyond they suddenly disappear. The change is so startling that attention is at once arrested. It should, however, be stated that the line mentioned at 38 m. very nearly answers to the level of the shore line graven in the solid rock, which, greatly pronounced in this place, may be traced for miles.

During the summer of 1882 I carefully examined these conditions, paying the most minute attention to the two sides of Tromsø Island, 11.3 km. in length, whence I extended my researches along the sounds on both sides of this island, viz. southwards to the tracts about the mouth of the Balsfjord, about 11 km. in length. But while the travelled blocks will be confined upwards to certain levels, no such demarcation will be found downwards. They are to be found down to the lowest level of the littoral belt. Particularly there will within this belt often be found heaps of large blocks ranged in rows along the central tide line, i.e. the line marking half tide. On the Ren Island, too, some eighteen miles north of Tromsø, I found once a great number of granite travelled blocks strewn along the lower levels in a line from south to north. With the exception of certain parts of Kvals and Ringvats Islands, the mountains along this district will nowhere be found to consist of granite, neither will there be found strata of granite nature to which these travelled rocks might be ascribed. I must, of course, admit that a series

of continuous researches are certainly required before it is possible with certainty to fix the place of birth of these blocks. With the materials at present at our disposal, however, we may arrive at some safe conclusions.

The granite field nearest from the sea inland is found far up in the Divi Valley. Of other granite strata inland there cannot here be a question.

This granite field is 124 km. from the Troms Island. Nearer than the above-described district is, however, the coast with extensive strata of gneiss-granite, which appears particularly prominent over the Kval Island situated just west of the Troms Island. From either of these the travelled blocks must have their origin.

If, now, the Divi Valley is accepted as their place of origin, the transport has been effected from the inland coastwards. If, on the other hand, the Kval Island is designated as their place of production, the transport must have taken place in opposite directions, viz. from the coast landwards.

If we now examine the petrographical composition of the travelled blocks, a great many will be found to be formed of varieties which belong to the gneiss-granite of the coast. But there may, on the other hand, be found many blocks among them which seem petrographically to be less related to the gneiss-granite, but to resemble typical inland granite far more.

At first sight, therefore, one would conclude that the travelled blocks might have been brought by both named roads. In this respect I must, however, point out that the gneiss-granite of the coast may petrographically vary considerably, and that it may be interspersed by or run into granite of purer character. In spite even of the greatly varying petrographical forms under which the travelled granite blocks may appear in the neighbourhood of Tromsø, I do not therein see any reason for denying that the travelled blocks may in general have their origin from the gneiss-granite. There are, however, several circumstances which tend to refute the theory of the blocks having been moved thither from the granite fields in the Divi Valley. If the blocks were thus carried down to the Troms Island and adjacent sounds, it must have been effected in either of the following ways:—

1. Either from the upper part of the Maals River across the mountain ridges down to the bottom of the Balsfjord, and thence outwards to the Troms Island.

2. Or along the bed of the Maals River to the bottom of Malangen, and thence further through the sounds which here run in an easterly direction towards the Troms Island, between the mainland and the southern side of the Kval Island.

And here I must point out that the granite stratum in the Divi Valley appears with its western edge at a height of about 188 m. above the sea. The Divi River runs, however, into the Maals River at an elevation of about 78 m. above the sea, while the bottom of the Balsfjord is separated from the Maals Valley and thus also from the Divi Valley by a higher mountain ridge in which the deepest sections, leading towards the Balsfjord, lie at an elevation of about 160 m., i.e. about 78 m. higher than the conflux between the Divi and the Maals Rivers. If, therefore, the blocks from the Divi Valley travelled down to the bottom of the Balsfjord, they must have done so over passes which lay 78 m. higher than the conflux between the two rivers! Although it might be most natural to assume that the ice-streams of the Divi Valley followed the bed of the Maals River, the suggestion that an arm from the same might have moved over the higher ridges down to the bottom of the Balsfjord is certainly one which cannot be ignored. But, if this was the case, the granite blocks which had been carried from the Divi Valley in this way ought to be found at the bottom of the Balsfjord at a higher elevation than 30 m. above the sea. Whether travelled granite blocks will be found at the bottom of this fjord is a question which cannot be answered, as but little attention has yet been paid to the same. I am, however, of the opinion, from my own investigations, that they are totally absent in this place.

If granite blocks were, on the other hand, carried down into the Balsfjord by this road, they must, judging by the height to which they are found near Tromsø, have been carried from this place further by drift ice. The beginning of the transport belongs thus to a period when the real Glacial age was closed, and the continuous ice-layer broken up. In this case it might be assumed that the travelled blocks should be found in large numbers along the sides of the Balsfjord, and decreasing in numbers from the bottom of the fjord outwards to

Tromsø. On this point, too, we are without conclusive proofs, but the examinations have, as already stated, been extended inwards to the mouth of the Balsfjord and its environs, and the results of these disprove such an assumption. Granite blocks are thus to be found about the mouth of the Balsfjord, but in far lesser numbers than over the Troms Island. It is just on the southern part of this island that travelled blocks are found in largest numbers in the whole district; while the circumstance that neither blocks nor fragments of Sausurite gabbro, which, as pointed out, are found in enormous quantities in the neighbourhood of the Balsfjord, can be discovered among the travelled blocks on the Troms Island, further corroborates my belief that no transport of blocks from the Balsfjord outwards to the sea has taken place. In fact, I am fully convinced that the block-transport has taken place from the coast inwards.

There is thus every reason to believe that the travelled granite blocks have not been carried out to the Troms Island through the Balsfjord. In fact, there seems more probability that the transport was effected through the Maals River. But, if this was so, travelled granite blocks would have been found on the slopes of the Malang, and here too in decreasing numbers from the inland towards the outer islands, which appears, however, not to be the case. I have therefore come to the conclusion that the birthplace of the travelled granite blocks in the vicinity of Tromsø must be referred to the gneiss-granite stratum of the coast, and thus again chiefly to that part of the same which appears at the Kval and Ringvats Islands west of Tromsø. This assumption is supported too by the circumstance that a great number of the travelled blocks, judging by the petrographic composition of the mountains in question, undoubtedly belong to the gneiss-granite of the coast, and that there is nothing to disprove the theory that even the blocks which petrographically seem to differ in composition also belong to the same stratum in composition.

The highest elevation in which the travelled blocks are found in the neighbourhood of Tromsø indicates that the transport of the same has taken place after the close of the Glacial period, *i.e.* in an age when the continuous layer of the Ice age had broken up into more or less separated glaciers. Under these circumstances the transport of the blocks from the Kval Island inwards to the Troms Island must have been effected by floating ice. The highest line of elevation in which the blocks along the sounds are deposited indicates, therefore, the height of the sea at the commencement of the block-transport. And as the blocks are often found in greatest number somewhat below this line, I have come to the conclusion that block-transport has progressed more rapidly as this period advanced. I may, however, add that the whole epoch of the block-transport has probably been a short one.

The local conditions of Kval Island seem also to have greatly favoured even the most extensive block-transport at an early age. The continuous layer of ice of the Glacial period has thus, as demonstrated above, been broken up thus early, that the ice remained only in local glaciers of great extent. So early must the block-transport have taken place also in an easterly direction, both through open channels of the Balsfjord and the Kval Sound, and unimpeded by the ice-streams moving down from the mainland. When, however, this, as appears from the blocks in the neighbourhood of Tromsø cannot have been the case, at all events to a limited extent alone, there is herein an obvious proof that special conditions which favoured the current carrying the blocks to the shore did not exist before the epoch which corresponds with the highest level in which the blocks are found.

If the blocks were, as I believe is demonstrated beyond doubt, transported to their places by floating ice, the flow of the current must have greatly influenced the direction of the block-transport. At a period, therefore, which is determined by the transport commencing eastwards, special conditions must have existed which have caused a stronger flow of the current from the outer coast inwards. There are, in fact, several circumstances which seem to point in this direction. There is in particular that of the Gulf Stream. It is thus evident that the Gulf Stream, which during the Glacial age was diverted from the coast of North Norway, has, in a comparatively recent era, curved towards the coast to a considerable extent.

As is generally known, a complete Arctic Sea fauna existed along the coast of Norway in the early part of the Quaternary age; but by degrees this has been more and more mixed with southern species, an encroachment which continued without interruption to the present time, and is, I believe, still in full operation. Some perfectly pure species of the Arctic fauna may

still be met with in some of the deepest fjords of Norway, but even these remains are most probably in retrogression. This constant retrogression of the original Arctic Sea fauna on the coast, and the encroachment of a more southern, must naturally be dependent on currents of warm water coming from the south, and as long as the Arctic fauna alone supervened, these warm currents must have been entirely absent from the coast line referred to in this paper. From the moment access was made for the same, the southern fauna began to manifest itself. In the block-transport here described, which began at a period when the surface of the sea lay, in relation to the fundamental rock, about 30 m. higher than at present, I believe we may find a more exact determination of the time when this curve in the current took place.

There is, besides this circumstance, another of equally great importance which points in the same direction. It is a fact, thus, that fragments of pumice-stone are constantly washed ashore on the coasts of North Norway, and even on those of the Polar lands as far as the Gulf Stream reaches, but pumice-stone is not found at any elevation in Northern Norway, but only at the lowest by the shore. In fact, the highest line along which pumice-stone is found here coincides nearly exactly with that of the travelled granite blocks in the neighbourhood of Tromsø. In no case does it exceed the same.

KARL PETERSEN

Tromsø Museum, Finnmarken, Norway

### A NEW FORM OF SPRING FOR ELECTRIC AND OTHER MEASURING INSTRUMENTS<sup>1</sup>

IN steam- and gas-engine indicators the pressure of the fluid on a piston produces a slight shortening of a spiral spring which is magnified by a lever, and so the pressure of the steam or gas is recorded. In what are usually known as spring balances there is also occasionally a magnification of the elongation of a spiral spring effected by the use of a rack and pinion. Such magnifying arrangements, however, not only introduce inaccuracy by the bad fitting of hinges or of teeth, an inaccuracy which



FIG. 1.

FIG. 2.

is aggravated by wear, but they increase the cost of measuring-instruments and their liability to get out of order.

And, as an example of the difficulty of using the wheel and pinion for the magnification of an angular motion produced by a small force, the authors mentioned the fact that although they used this plan for a year or more in their electric measuring-

<sup>1</sup> Abstract of a paper read before the Royal Society by Prof. W. E. Ayrton, F.R.S., and John Perry, M.E.

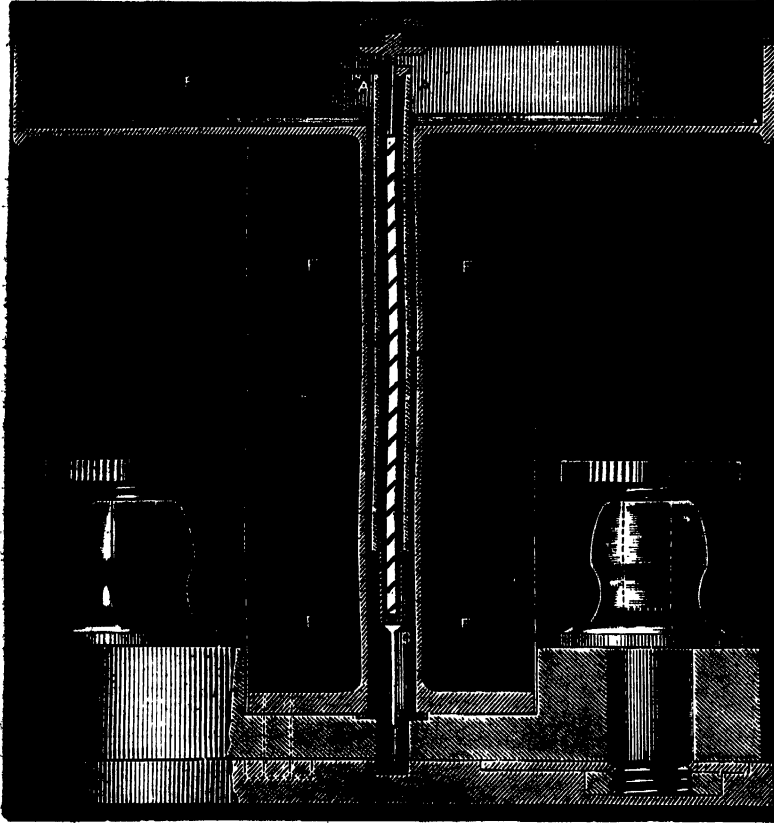

FIG. 3.

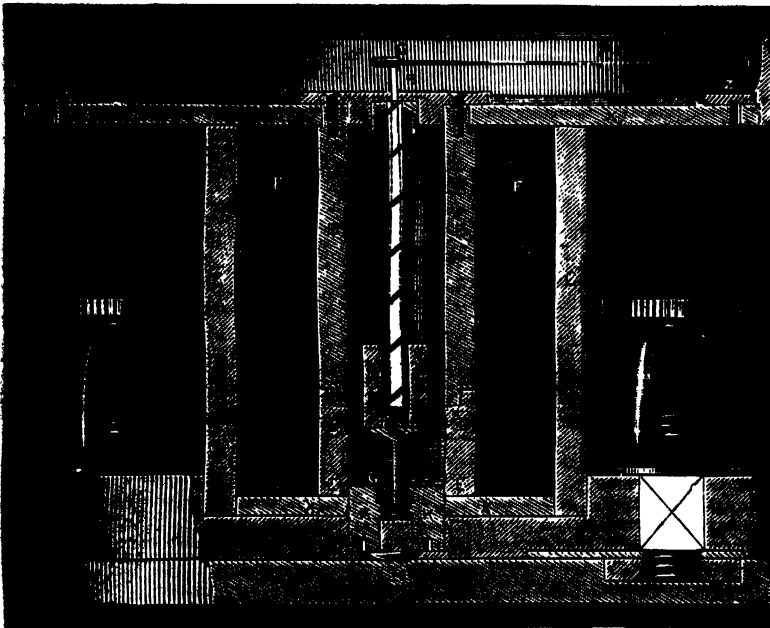

FIG. 4.

instruments, and although the wheels and pinions were made by a good watchmaker, still the friction involved in such a plan has induced them to abandon it in favour of the new arrangement which is the subject of their present communication.

The telescopic method employed by Weber, and the spot of light method due to Sir W. Thomson, for magnifying the effect of an angular motion are, of course, unequalled for stationary measuring-instruments, but for instruments which must be carried about and used quickly without the necessity of adjustment, these most ingenious reflecting methods are quite unsuitable.

With an ordinary cylindric spring, having a small angle between the osculating plane and a plane perpendicular to the axis, as is the case with all spiral springs such as are in practical use, it is well known that but very little rotation is produced between its ends by the application of an axial force. Consequently with such springs it is only possible to obtain magnification by the employment of a system of levers, or of a rack and pinion. It occurred to the authors, therefore, to consider whether it would not be possible to make a spiral spring of such a nature that for a comparatively small axial motion of its ends there should be considerable rotation of one end relatively to the other, and by the employment of which all levers, racks, and pinions could be dispensed with, so that no error could be introduced by wear and tear, or by want of fitting of joints, and further so that the temperature correction should be merely one affecting the rigidity of the material used as a spring, and not a correction such as had to be applied in consequence of the contractions and expansions of the various parts of an ordinary magnifying apparatus.

The theory of the strength and stiffness of the ordinary cylindric spiral spring of small angle was given for the first time in 1848 by Prof. James Thomson, and he authors follow his method in investigating the laws governing the behaviour of spiral springs generally. They find that if the centres of all cross-sections of the wire, or strip, forming the spring lie on a right circular cylinder of radius  $r$ ; if the spiral have everywhere an inclination  $\alpha$  to the plane perpendicular to the axis of the cylinder, and if a force  $F$  act at one end of the spring along the axis, the other end of the spring being fixed; if  $B$  is the flexural rigidity of the wire in the osculating plane, and if  $A$  is the torsional rigidity about the spiral line at any place; if the angular motion, in a horizontal plane, of the free end of the spring relatively to the fixed end be called  $\phi$ , and if the axial increase of length be called  $d$ , and the whole length of the spring along the spiral  $l$ , then—

$$\phi = l F r \sin \alpha \cos \alpha \left( \frac{1}{A} - \frac{1}{B} \right) \dots (1),$$

and

$$d = l F r^2 \left( \frac{\cos^2 \alpha}{A} + \frac{\sin^2 \alpha}{B} \right) \dots (2).$$

Assuming for the general investigation that the cross-section of the wire is elliptic, it is found that the rotation of the free end of a spring like Fig. 1 or Fig. 2 is greater the greater the inequality in the principal diameters of the elliptic section.

In Fig. 1 it is found that there is an uncoiling on the application of an axial pull. Fig. 2 shows a spring made of the same material, but the wire has been passed through rolls so as to flatten it in the opposite way, and now a rotation tending to coil it up is found to be produced by the application of an axial pull.

The twisting torque to which the spring is subjected is  $F r \cos \alpha$ , and the bending torque to  $F r \sin \alpha$ . But the twist must be multiplied by  $\sin \alpha$ , and the bend by  $\cos \alpha$  when we project these motions on a horizontal plane. So far then as the total rotation in a horizontal plane of the free end of the spring relatively to the fixed end is concerned, it may be regarded as being produced by equal twisting and bending torques, each of them equal to  $F r \sin \alpha \cos \alpha$ ; and the total rotation of the free end of the spring relatively to the fixed end, which is the special feature of the springs considered, is proportional to the difference between the two angular rotations produced in the wire by these equal bending and twisting torques. The twist alone would cause an increase in the number of coils, that is, a rotation in the direction of coiling which is the positive direction, while the bending, or rather the unbending, alone would cause a negative rotation, or one tending to uncoil the spring. When both occur together in the actual spiral spring subjected to an axial force, the total rotation is positive or negative, according as the angular twist or the angular bend is the greater. Hence the flexura and torsional rigidities of the wire alone determine whether the rotation is positive or negative.

It is well known, for example, that, when a wire of circular section is subjected to equal twisting and bending torques, the twist is greater than the bending for almost all substances, that is, substances in which the ratio of the modulus of rigidity to Young's modulus is between one-third and one-half. Hence we may expect that in a spring made of round wire, and with the spires making an angle of  $45^\circ$  with a plane perpendicular to the axis, the total rotation will be positive for an axial force applied so as to lengthen the spring. And experiment shows that this is the case.

If the wire be flattened and bent so that the flat side of the strip touches the cylinder on which the wire is coiled, as shown in Fig. 1, then the arrangement is such that the bending is greater than the twist. Hence an axial force applied so as to lengthen this spring causes a negative rotation, whereas if the strip be coiled as in Fig. 2, so that the edge of the strip lies against the cylinder on which it is coiled, an axial force similarly applied will now cause a positive rotation. It is almost certain that for any strip of material the positive value of  $\phi$  obtained with the latter form of spring is likely to be greater than the corresponding negative value with the former kind, but the difficulty of manufacturing the second form of spring compelled the authors to confine their attention to the former type.

Having constructed some very delicate springs of the first kind, one of the first difficulties which the authors met with arose from the liability of such springs to acquire a permanent set, so that it became necessary to determine the dimensions of the spring which would give the largest amount of rotation with the minimum amount of stress in the material. Having made their calculation of the greatest amount of stress, the general conclusions arrived at are, that in order, with a given axial force, to obtain a

large amount of turning of the free end of the spring, combined with small maximum total stress in the material, and not too much axial motion of the free end of the spring, the strip of elliptic section should be as long and as thin as possible, should be wound in a spiral such that the osculating plane makes an angle of  $40^\circ$  to  $45^\circ$  with a plane perpendicular to the axis of the spiral, and so that the smaller diameter of the elliptic section is at right angles to the axis of the spiral.

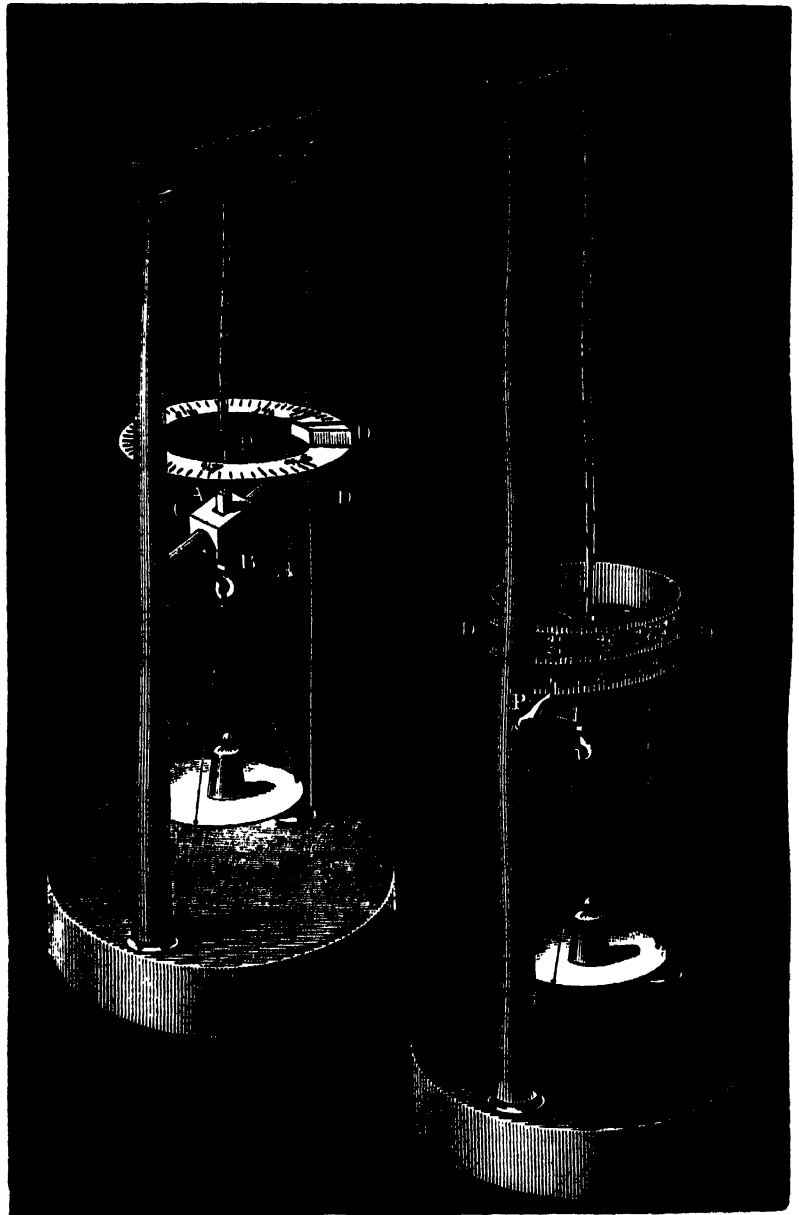

FIG. 5.

FIG. 6.

In the springs employed by the authors in measuring-instruments the edges of the strip nearly touch one another in consecutive coils, so that the strip forms almost a continuous cylindrical surface, the angle of the spiral being  $45^\circ$ , the cross-section of the strip being rectangular, and they find the following laws:—

$$\phi \propto \frac{1}{2} F \left( \frac{1}{AN} - \frac{1}{E} \right)$$



$$d \propto \frac{I F r}{\delta^3} \left( \frac{1}{N} + \frac{1}{E} \right)$$

$$f \propto \frac{F}{\delta^3}$$

where  $f$  is the greatest stress in the material,  $\delta$  the thickness of the strip,  $N$  the modulus of rigidity, and  $E$  Young's modulus for the material.

The authors now show how their springs may be used to determine directly the ratio of the modulus of rigidity of a material to its Young's modulus, and they conclude their paper by describing some practical applications of their springs which they have already made in measuring-instruments. Thus by the employment of springs such as those described, they have succeeded in making *ammeters* and *voltmeters*, or instruments for measuring respectively electric currents and differences of potential, in which the pointer moves over in some cases as much as  $270^\circ$  of the scale instead of only  $50^\circ$ , which is all that can be obtained with ordinary galvanometers. One form of the instrument is shown in Fig. 3, where  $AA$  is a thin, hollow tube of charcoal iron attached at its lower end to a brass piece  $G$  guided at the bottom in the way shown. To  $G$  is attached the lower end of a spring made in the way described, of silver or hard phosphor-bronze, the upper end of which is attached rigidly by a thin rod to the glass top of the instrument, which itself is fastened rigidly to the framework of the instrument. The rod attached to the glass, and to which the upper end of the spring is attached, also serves as a guide to the top of the iron tube. In the space  $FF$  a solenoid wire or strip is wound, its ends being attached to the terminals shown. Hence, when a current is passed through the wire, the iron tube is sucked into the solenoid, and its lower end  $G$ , to which the spring is attached, receives a large rotary motion, which is communicated directly to the pointer attached to the top of the iron tube. Parallax in taking readings of the pointer is avoided by the horizontal scale being on looking-glass in the well-known way.

By making the iron tube  $AA$  very thin, so that it is magnetically saturated for a comparatively weak current, by fixing it so that it projects into the solenoid a fixed distance which has been carefully determined by experiment, and by constructing the spring in conformity with the conditions worked out in this paper, so as to obtain a large rotation with minimum stress, and with not too much axial motion of the free end of the spring, they have succeeded in obtaining deflections up to  $270^\circ$  directly proportional to the current, and without any permanent set being given to the spring.

To prevent a spring taking a permanent set for a large deflection, it is of great importance that the spring after being delivered by the maker should receive a large degree of permanent set in the direction in which we wish it to be afterwards strained in ordinary working.

In spite of the fact that Prof. J. Thomson in the *Cambridge and Dublin Math. Journ.*, November 1848, explained the importance of initial strains in materials, the reason is not yet sufficiently well understood why when a round bar has been well twisted beyond the limit of permanent set in a certain direction it has twice as much elastic strength to resist torsion in this direction as in the opposite direction. Now in the very act of manufacturing these springs, that is in the bending of the strip, the material acquires strains which are just opposite in character to the initial strains which we wish it to possess, for, as already explained, if the spring be constructed as in Fig. 1, an extension of the spring produces a rotation tending to uncoil it. Hence a spring must not be regarded as ready for use until it receives a good set by means of a weight hung from its end.

This instrument is *direct reading*, the adjustment for sensibility being made by a small sliding coil, the correct position of which is initially determined experimentally by the makers, and in which position the coil is permanently fixed.

*Theory of the Solenoid Spring Ammeter or Voltmeter.*—If  $C$  is the current in amperes flowing through the coil, the attractive force on the iron core is

$$\frac{K C^2}{1 + S C}$$

where  $S$  is a constant, which is the greater as the current is smaller for which the iron tube  $AA$ , Fig. 3, becomes saturated with magnetism. The position of this iron core in the solenoid is so selected that  $K$  remains practically constant throughout the small range of downward motion of the core.

Since the rotation  $\phi$  has been produced by an axial force, we

know from the theory of the spring already given, that this axial force is  $p\phi$ , where  $p$  is some constant. Hence

$$p\phi = \frac{K C^2}{1 + S C}$$

and since  $S C$  is great in comparison with unity for such currents as we wish to measure, we have

$$\frac{p\phi}{K} = \frac{C}{S} - \frac{1}{S^2}$$

or

$$C = \frac{S p}{K} \phi + \frac{1}{S}$$

that is, equal divisions of the scale correspond with equal additions to the strength of the current except close to the zero, and the authors do not usually graduate these instruments within  $5^\circ$  of the zero.

*Shielded Measuring-Instruments.*—When it is desired to use the instrument close to a dynamo machine or electromotor in action, they have adopted a different and somewhat special form of construction, which is shown in Fig. 4, by means of which the instrument is to a great extent shielded from even powerful external magnetic fields. In this instrument the electromagnet consists of a hollow core, part of which,  $BB$ , is of charcoal iron, and part,  $DE$ , of brass, or other non-magnetic metal. The outside tube,  $CC$ , and the plates,  $XX$ , top and bottom, are also of charcoal iron. The space  $FF$  is filled with insulated wire or strip in electric connection with the terminal, so that when a current is sent through the instrument an intense magnetic field is formed between  $D$  and  $E$ , which are the poles of the electromagnet. To the iron tube  $AA$ , also made of charcoal iron, the spiral spring, in this case made of extremely thin hard steel, is attached, the other end being attached to the piece  $F$ , which is fixed relatively to the bobbin. The spindle  $GG$ , which is fixed to the moving iron core  $AA$ , moves freely in bearings  $HH$ , so that the only movements of which  $A$  is capable are one of rotation and one parallel to the axis of the bobbin. As the iron core  $A$  projects into the strong magnetic field between  $D$  and  $E$ , it is strongly attracted towards  $E$  when the current flows, and, as before, causes a large rotation of the pointer  $P$  over the scale. As a means of varying the power of the instrument an adjustable iron piece  $K$  is provided, which can be screwed nearer to or farther from the core  $A$ , and by the use of which the sensibility of the instrument can be adjusted so as to make the instrument "direct reading," that is to say, each division of the scale can be made to correspond with 1 ampere of current, or 1 volt difference of potential, and the employment of a constant such as 1.34 amperes, or volts, per degree, which hitherto been necessary with our measuring-instruments, is now avoided. This power of adjustment produced by the use of the movable iron piece  $K$ , combined with the ease with which more or less wire can be wound on to the instrument, which also constitutes a second adjustment of sensibility, is of considerable importance, since the employment of a constant has not only led to error and delay in measurements made in electric-light factories, but has caused the breakage of the pointer or the destruction of an instrument from a far too powerful current being sent through it by an observer (often a man with little experience in the employment of instruments) having confounded the constant of some other instrument with that of the one he was using.

In the first of these magnifying spring ammeters and voltmeters made by the authors, the instrument did not show the *direction* of the current, but they have since added on the base of the instrument a small compass needle (not seen in the accompanying illustrations), which points out at which of the terminals the positive current enters, while the main pointer of the instrument shows as before the magnitude of the thing to be measured.

*Weighing-Machine.*—Another class of instruments in which they have practically employed this spring are weighing-machines, and Fig. 5 shows one of the arrangements adopted. The scale-pan is prevented from turning by the part  $AB$  being square and fitting very loosely a square hole in  $C$ . This arrangement introduces practically no friction, and prevents the moment of inertia of the scale-pan and load interfering, by means of a rotary motion, with the rapidity with which the pointer comes to rest when a load is put into the pan. The position of the pointer  $P$ , which revolves when a weight is placed in the scale-pan, is read off upon the spiral scale  $D$ , which in the specimen shown was graduated in pounds. In another of these weighing-machines, shown in Fig. 6, the arrangement is the same with the exception that a cylindrical scale  $D$  is fixed to the end of the

spring and turns with it; the pointer P fixed on the frame of the instrument points to an indication of the weight on a spiral line drawn on the cylinder D. This second arrangement allows of the employment of springs whose ends have a relative motion of five or six revolutions.

The authors also brought before the Royal Society a model showing a combination of bifilar and spiral spring suspension, in which great rotation and small axial lengthening or shortening are produced by an axial force.

### UNIVERSITY AND EDUCATIONAL INTELLIGENCE

CAMBRIDGE.—Mr. A. E. Shipley, of Christ's College, will give a repetition of the Elementary Biology course in the Morphological Laboratory during the Long Vacation, beginning July 7.

The workshops of Mechanism will be open during the Long Vacation.

The Observatory Syndicate report 2305 observations of R. A. and N. P. D. in 1883-84, including 1579 observations of zone-stars made on 100 nights. The observations of standard stars are reduced to about the end of 1883. The zone-stars are completely reduced to end of 1881, the mean R. A. and N. P. D. to end of 1877.

It appears that the new expenditure entered into for professors, readers, University lecturers and demonstrators, and for apparatus and buildings, already exceeds the annual receipts from the colleges under the recent Act. Thus there is little chance at present of the appointment of the numerous readers contemplated by the University Commissioners.

The placing of a new story over the Mineralogical Museum for a laboratory of Elementary Biology has been sanctioned. The recommendations regarding a lecture-room and additions to the Physiological Laboratory are in abeyance.

The Botanic Garden Syndicate reports that during the past year the houses have been improved in many details. The Bromeliaceæ are now represented by fifty species. A new fern pit for filmy ferns is well stocked. The collection of Irises has been greatly improved, largely by Prof. Michael Foster's generous contribution, making it probably the finest in any botanic garden. The liberality of Mr. Barr has contributed a very fine collection of daffodils, and one of Funkias, not surpassed anywhere. Numerous plants of scientific interest have flowered in the Gardens and been figured. Col. T. Clarke has contributed a set of important Croci; Messrs. Low of Clapton a fine set of orchids.

The local lectures in provincial centres continue to gain large audiences, many courses of lectures on physical science and biology being given. Great difficulty, however, is felt in establishing sufficiently continuous courses of lectures in successive years, so as to give complete schemes of study.

The Cavendish and the Chemical Laboratories will be open during July and August.

Prof. Macalister will hold a class in Osteology during the Long Vacation. The Demonstrator will take a class in Practical Histology.

### SCIENTIFIC SERIALS

THE *Journal of Botany* for May contains several articles of interest to cryptogamists:—Mr. W. B. Grove describes a number of fungi, some of them but little known or new; and the paper is illustrated by two plates.—Mr. S. Le M. Moore has paid special attention to the small class of endophytic algæ, and gives some interesting particulars regarding the structure and reproduction especially of *Chlorochytrium Lemnae* and *Scotinosphaera paradoxa*.—Dr. Hance describes, under the name *Phlopteria*, a new genus of polydipodiaceous ferns; and Mr. J. G. Baker several new species of ferns in the collection of M. Humboldt from Madagascar.—Among the minor notes evidence is given that *Centaurea Jacea*, L., must be regarded as a true British species.

In the number for June the only original article of importance is an exhaustive monograph by Mr. F. Townsend, of the variable species *Euphrasia officinalis*. He classifies the various forms under eight groups, only three of which are found in the British Islands.—A large portion of this number is occupied by the completion of the annual list (continued from the previous number) of new flowering plants published in periodicals in Britain during 1883. The length of this list affords evidence that the

study of descriptive and systematic botany is not altogether neglected in this country.

*Rendiconti del R. Istituto Lombardo*, May 15.—Biographical notice of Giovanni Polli, with a list of his scientific productions, by Prof. Gaetano Strambio.—Influence of Virgil on the style of Dante, Petrarch, Metastasio, and Parini, by E. Giulio Carcano.—On the present condition of agricultural interests in Europe and North America, by Prof. Gaetano Cantoni.—On surfaces of the third order, by Prof. E. Bertini.—Experimental studies on the cure and prevention of tuberculosis, by Prof. G. Sormani.

*Journal de Physique*, April.—E. Blavier, study of earth-currents. In France these currents generally flow from north-west to south-west, and inversely; but often their direction changes and they go from north to south, north-east to south-west, east to west, or inversely. It is still impossible to give a general law.—E. Mascart, on the reciprocal action of two electrified spheres, shows that if the distance between centres is triple the diameter the law of Coulomb is correct to 2 per cent.—M. Brilloin, duration of swing of a magnetic system with its index.—M. Izarn, electro-dynamic and electro-magnetic experiments. An astatic float based upon that of Ampère is used to demonstrate the law of repulsion of consecutive elements of the current. The apparatus does not disprove Maxwell's view, however.—M. Buguet, action of two consecutive portions of one current.

May.—E. Mercadier, on the laws of transverse vibrations of elastic rods. From experiments on rods of steel and iron held at two points it appears that the number of vibrations is proportional to the thickness in the direction of the displacement, inversely proportional to the square of the length, and independent of the breadth.—P. Garbe, on Joule's law. Experiments made with an incandescent lamp placed in a calorimeter.—M. Marey, analysis of movements of photography. Gives a diagram of movements of a man running.—E. Mathieu, figures of liquid drops at the moment when they are about to detach themselves from a capillary tube fastened to the bottom of a vase.—M. Neyreneuf, on the transmission of sound.

*Bulletin de l'Académie R. de Belgique*, April 5.—Investigations on the spectra of the comets and on the luminous spectra of the hydrocarbonic gases, by Nicolas von Konkoly.—On the presence of the Biscay whale (Nordcap) on the coasts of Norway in ancient and modern times, by G. A. Guldberg.—On the influence of temperature on the bands of the spectrum, by Ch. Fievez.—On the sand-heaps and sandstone boulders scattered over the Upper Devonian hills in the Sambre and Meuse districts, by Michel Mourlon.—On the influence of the atmospheric conditions on the appearance of certain colours in the scintillation of the stars; application of these observations to the prediction of changes of weather, by Ch. Montigny.—Spermatogenesis in *Ascaris megaloccephala*, by Edouard Van Beneden.—On the advanced state of vegetation in Belgium in the month of March, 1884, by G. Dewalque.—Remarks on the cause of metamorphism in the rocks of the Recogne district, Luxemburg, by Jules Gossclot.—On the existence of a fourth species (*Balanoptera borealis*) of the genus *Balanoptera* in the North European waters, by G. A. Guldberg.

*Journal of the Russian Chemical and Physical Society*, vol. xvi. fasc. 3.—On the formation of amides of ammoniacal salts, by N. Menshutkin. The speed of amidation of the investigated acids increases with the increase of temperature, and the influence of temperature could be represented by similar curves for the different acids. The velocity of amidation depends also on the molecular weight, that of formic acid going on at a greater speed than those of acids which have higher molecular weights. Even with the aromatic acids the speed of amidation depends on the isomeric form of the acid. The results as to the dependency on isomerism and molecular weight are identical with those arrived at with regard to the compound ethers.—On the hydrates of the chloride of cobalt, and on the cause of the changes of colour of its dissolution, by A. Potilitzin.—On the action of the haloid salts of aluminium on the saturated hydrocarbons, by G. Gustavson. Organic bodies undergo great modifications when they enter into reactions with these salts, even when they enter into unstable temporary combinations; they acquire the capacity of entering into several new reactions, and undergo deep modifications even without being heated. The experiments might throw a new light on the part played by mineral salts in organisms, the component parts of which may be thus submitted to changes that are favourable for life.—On a new salt of rhodium, by Th. Wilm.—Note on M. Kanonnikoff's memoir on the refracting power of organic substances, by F.

Flavitsky.—On the preparation of animal colours from albumoids, by W. Mihailoff.—Notes on the pseudosulphocyanogen, and on the dissolution of fibrine, by A. Lidoff.—On the thermal phenomena due to magnetism, by P. Bakhmetieff.—On the reproduction of curves traced by a point of the axis of a revolving body suspended at a point of its axis, by D. Bobyleff. The author publishes a photolithographed plate showing the different curves described by a conical pendulum revolving around its axis of symmetry, and balancing at the same time about its point of suspension. The apparatus having been improved, the curves are very symmetrical, and, notwithstanding the influence of the decrease of the oscillations, the curves are most like those deduced from the integration of the differential equations.—A preliminary note on the electrical properties of quartz, by G. Wouff.—On the conditions of sensibility of the method of Mance, a mathematical inquiry by D. Zolstareff.—On the changes produced in the intensity of an induction current by the introduction of a branch containing a bobbin, by J. Borgmann.—Notes on elementary optics, by P. Ziloff and M. Wolkoff.—Note on friction, by M. Kraicwitsch.

### SOCIETIES AND ACADEMIES

LONDON

Royal Society, June 19.—“On the Structure and Development of the Skull in the Mammalia. Part II. Edentata.” By W. K. Parker, F.R.S.

My former paper on the structure and development of the mammalian skull was published in the *Philosophical Transactions* in 1874; it was on that of the Pig.

Since then, whilst gathering fresh and fresh mammalian materials, the greater part of my actual work has been on the skull of the other classes.

I have come to the conclusion that the Edentata are nearer of kin to the Monotremata than to the Marsupialia, and that if they did, as indeed they must have done, pass through a Metatherian, or Marsupial stage, they did not utilise it, but ran through it in an abbreviated *pre-natal* stage.

Of course the remarkable modification of their jaws, due to abortion, and in some cases complete suppression, of their teeth, is that which makes these forms so abnormal to the morphologist as well as to the zoologist.

As it happens, the most primitive form of Mammalia existing, the Prototheria (*Ornithorhynchus* and *Echidna*), are also abnormal on the same account, and thus the best standard existing by which to measure the height of the platform on which we find the Edentata is not itself normal, or straight, or perfect.

Now none of the Metatheria or Marsupials have suffered from this kind of degenerative specialisation; they therefore come in well as standards of measurement and comparison for the Insectivora next above them, but of little use here among the Edentata.

Prof. Flower, after working out the general anatomy of this group (*Proc. Zool. Soc.* 1882, pp. 358-367), has come to the conclusion that the Edentata of the Old World have little to do with those of the New.

That sounds like a hard saying to one not familiar with the structure of the group; it did to me, no long time ago, although what I had done at the group, long ago, went to prove the same thing; now, however, I am quite satisfied of the truth of my friend's deductions.

The Neotropical Edentata hold together much more than might have been expected; the Armadillos are the most isolated, but much as the Aard-Vark of the Cape looks like an archaic Armadillo without armour, he is not more than a very distant relative of the modern armed Armadillos.

Indeed, the curious coincidences that I have found between the structure of the Aard-Vark and that of a large Insectivore from a contiguous region, namely, the *Rhynchocyon* from Zanzibar, lead me to suspect that the Cape Anteater is an offshoot from the same stock, and is, indeed, the only Edentate that can be looked upon as probably arising originally from a Metatherian or Marsupial stock, like the Insectivora.

The other Palæotropical Edentata—the Pangolins—are perhaps still more isolated than the Aard-Vark, but they have not come so near extinction, and are found in more than one continent of the Old World.

If the term *Reptilian* might be applied to characters seen in any Placental Mammal, it might to what I find in this. This creature has most remarkable correspondences with the Reptilian

group. Of course, the scaly covering is mimetic of the Lizard's scales, and is in reality made up of cemented hairs; that may pass; but not the structure of the sternum in some species, with its long “xiphisternal horns,” as in the *Stellionidae*, nor the cartilaginous abdominal ribs, as in the Chameleons and some other kinds. (See my memoir on the “Shoulder-girdle and Sternum,” *Ray. Soc.*, 1868, plate 22, fig. 13).

But the curious *ornithic* nasal bones, deeply cleft in front, the imperfect desmognathism of the palate, the feeble and segmented state of the anterior sphenoid, and the open pituitary space of the embryonic cartilaginous skull, all these things suggest that the Pangolins, whatever degenerative specialisation they may have undergone, never did rise to any height as Mammals.

Indeed, to me their *pre-natal* development—the Eutherian placentalion—seems to be their best title to be ranked even amongst the low forms of the high Mammalia.

If a complete series of fossil types could be found, on one hand stretching backwards (or downwards) from the Glyptodonts, and, on the other, from the Megatheroids, then, long before these two groups merged into a common Prototherian root-stock, we should find their differences one by one dying out.

Embryology would help us here very much if materials could be obtained. Even with the scanty treasures that I have been able to obtain, most remarkable things are shown.

Of the two Anteaters I have only been able to obtain the young (not the embryo) of the smallest and most aberrant type—*Cycloturus*—and of the Sloths only two embryos, and one of these considerably advanced, belonging to two genera, namely, *Cholepus* and *Bradypus* (*Arctopithecus*, Gray).

But every step backward in the structure of the skull of the Sloth brings me nearer and nearer to what I see even in the young of the Little Anteater, and that it is possible for both of these types to have arisen from the same stock is no longer a doubtful thing.

But the skull of developing embryos of the Sloth (of either kind) forms a very valuable and easy-working key to what is difficult in the skulls of the extinct gigantic Megatheroids.

If this be the case, if Sloths, extinct or recent, have arisen during time from the same stock as the great terrestrial Anteater, and the little prehensile-tailed *Cycloturus*, then there is nothing in any other Order to shock the mind or to be a stumbling-block in the path of the most timid evolutionist.

That in the Armadillos the new hushandry, or growth, of hair—the correlate of milk glands—should thrive badly on the old stony ground of Reptilian horn-covered scales, breaking out where it can among the clefts, is not more wonderful than that this same new growth of hair in the Pangolin should mat itself together and imitate the scales of Reptiles and Fishes.

Physical Society, June 14.—Dr. Guthrie, president, in the chair.—New Member, Mr. Stanley Butler.—Mr. Hoffart read a paper on a new apparatus for colour synthesis, which he exhibited. The colours are obtained by sending through prisms the light from a series of platinum wires made incandescent by Grove or other cells. Three different rays can be compared or superposed at a time by the instrument shown. The rays are received into the eye through an adjustable eyepiece; and various ingenious devices are adopted in the construction of the apparatus. The intensities of the lights are regulated by rheostats in the circuits of the platinum electro-pyres. Lord Rayleigh, Mr. Stanley, and Prof. Perry commented on the apparatus, and Dr. Guthrie thought that it would be useful in studying colour-blindness.

—Mr. Blaikley read a paper on the velocity of sound in small tubes—a continuation of experiments formerly brought before the Society by the author. Mr. Blaikley showed experimentally how his measurements were made. He found that pipes in which the upper proper tones were in harmonic order, or, better still, those in which they were far removed from the harmonic order, and therefore dissonant, were best for the purpose. He had obtained velocities from fine tubes varying from 11'4 to 88'2 mm. in diameter, the former giving 324'38, and the latter 330'13 m. per second as the velocity of sound. In free air Mr. Blaikley thought the velocity would come out 331 m. per second. The differences of velocity for the different pipes were very regular. Lord Rayleigh, Dr. Stone, and Dr. Guthrie made some observations on the paper, Dr. Stone remarking that the diameter of a pipe modified the pitch of the same rate, a fact noticed in musical instruments. In experiments on water-waves Dr. Guthrie had found that in rectangular troughs the rate of oscillation was less than in circular ones.—Mr. Howard read a paper by himself and Mr. Hayward, on the thermal relation-

ship between water and certain salts, such as sulpho-ethylate. &c. Curves of results were given and interpreted.

**Royal Meteorological Society, June 18.**—Mr. R. H. Scott, F.R.S., president, in the chair.—Dr. Benjamin A. Gould, Director of the Cordova Observatory, Argentine Republic, was elected an Honorary Member.—The following papers were read:—The equinoctial gales—do they occur in the British Isles?, by Mr. R. H. Scott, F.R.S. The period investigated was the fourteen years 1870–84, and only those storms were selected which had attained force 9 of the Beaufort scale at more than two stations. The results show that the storms are all but exclusively confined to the winter half-year; and also how, for a certain interval, the stream of storm depressions sets over the British Isles, and then for a time takes another path, leaving this country at rest. In some years there are as many as four or five storms in a fortnight, and in others there are none, or only one. It is further shown that there is no strongly marked maximum at either equinox.—On the physical significance of concave and convex barographic or thermographic traces, by the Hon. R. Abercromby, F.R. Met. Soc. The author shows that a falling barogram is convex when the rate of the fall is increasing, concave when decreasing; and conversely, that a rising barogram is convex when the rate is decreasing, concave when increasing. As the rate of barometric change is proportional to the steepness of the gradients which are passing, and the wind also depends on the gradients, the author suggests the following rules for judging the coming force of a gale from the inspection of a barogram:—A convex barogram is always bad with a falling barometer, and good with a rising one; and a concave trace is sometimes a good sign with a falling barometer, and not always a bad indication with a rising one. The convexity or concavity of a thermogram is likewise shown to depend on the rate of thermal change. A method is given by which the distribution of diurnal isotherms over the globe can be deduced from the diurnal thermograms in different latitudes, and it is shown that the shape of diurnal isotherms on a Mercator chart for a limited number of degrees of latitude is similar to the shape of the curve of diurnal temperature range, if we turn time into longitude, and temperature into latitude, on a suitable scale.—Maritime losses and casualties for 1883 considered in connection with the weather, by Mr. C. Harding, F.R. Met. Soc.—The helm wind, by the Rev. J. Brunskill, F.R. Met. Soc. This is an account of a wind peculiar to the Crossfell Range; and its presence is indicated by a belt of clouds, denominated the "helm barr," which settles like a helmet over the top of the mountain.—Climate of the Delta of Egypt in 1798 to 1802 during the French and British campaigns, by Surgeon-Major W. T. Black, F.R. Met. Soc. The author has collected and discussed the meteorological observations made in Egypt during the French and British campaigns at the beginning of the present century.

**Geological Society, May 28.**—Prof. T. G. Bonney, D.Sc., F.R.S., president, in the chair.—John George Goodchild, Alexander Johnstone, and John Taylor were elected Fellows, and Prof. G. Meneghini, of Pisa, a Foreign Member of the Society.—The following communications were read:—The Archæan and Lower Palæozoic rocks of Anglesey, by Dr. C. Callaway, F.G.S., with an appendix on some rock-specimens, by Prof. T. G. Bonney, F.R.S. The object of the author was to furnish additional proof of the Archæan age of the altered rocks of the island. He held that the Pebidian mass on the north was fringed by Palæozoic conglomerates containing, amongst other materials, large rounded masses of limestone, derived from the calcareous series on the north coast, these conglomerates being probably a repetition by reflexed folding of those which lie at the base of the Palæozoic series. In like manner conglomerates which margined the western (Holyhead) schistose area contained angular pieces of altered slate undistinguishable from some of the Pebidian rocks of the north-west. These conglomerates dipped to the east, forming the western side of a syncline. Near Llanfihangel were sections which showed not only the Archæan age of the gneissic and slaty (Pebidian) groups, but also the higher antiquity of the former. These conclusions were derived from the occurrence of granitoid pebbles in the slaty series, and from the presence of masses of the slate, as well as gneissic fragments, in the basement Palæozoic conglomerates. The author was at present unable to accept the Cambrian age of the Lower Palæozoic rocks, and considered that the fossils he exhibited tended to confirm the views of the Survey on the correlation of those strata. The paper concluded with a sketch of the physical geography as it probably existed in Ordovician

times. An appendix furnished by Prof. Bonney tended, by microscopic evidence, to confirm the proof furnished by the paper.—On the new railway-cutting at Guildford, by Lieut.-Col. H. H. Godwin-Austen, F.R.S., and W. Whitaker, F.G.S. In this paper the authors described a section exposed in a new railway-cutting just north of Guildford station. The beds exposed are chalk and Eocene strata at the base, with overlying Pleistocene or drift-beds. The Eocene beds appear at each end of the cutting, the London Clay resting upon Woolwich and Reading beds as described in 1850 by Prof. Prestwich; and the interest of the section is due in part to this exposure of the Woolwich and Reading beds, which are rarely seen in this neighbourhood, and in part to the thick mass of Pleistocene clays and gravels overlying the lower Tertiary deposits. The authors pointed out that the most interesting questions connected with these high-level gravels and sands of the ancient Wey are as follows:—1. What was their relation to the topography of the country in the past? 2. What relation do they bear to the outlines of the country at the present day? 3. What is their age? They showed that when the gravels and sands were deposited the main drainage of the country was the same as it now is, though the river was sixty feet above its present level. The sands with mammalian bones were probably an accumulation in a re-entering bend of the river, similar to one now existing a little further north. The river appears at first to have been more rapid, when the lower ironstone gravels were deposited; then slower, when the sands accumulated. Some change of levels ensued, and a considerable portion of the deposits was removed before the upper strata of loam and flints were formed. It is probable that the gorge of the Wey was no longer an outlet to the north whilst these beds were being deposited. In general the loam and flint beds are horizontal, whilst in some localities they are displaced in a manner remarkably like what is seen in the Glacial deposits of Alpine valleys. They contain land shells in places. The land surface indicated by the lower gravels and sands at Guildford is of older date than that described by Mr. R. A. C. Godwin-Austen in the country to the southward, and especially in the valley of the Tillingbourne. The deposits near Guildford belonging to the two epochs were noticed in some detail. Both are pre-Glacial, and have been formed when the climate was temperate. The overlying Glacial deposits formed of chalk-detritus, flints, and loam are attributed to the action of land ice, and the probable effects of a low temperature are described and illustrated by those observed on the plateaus around Chang Cheumo in Tibet.—On the fructification of *Zelleria* (*Sphenopteris delicatula*, Sternb., sp., with remarks on *Ursalopteris* (*Sphenopteris*) *tenella*, Bronng., sp., and *Hymenophyllites* (*Sphenopteris*) *quadridactylites*, Guitb., sp., by R. Kidston, F.G.S.—On the recent encroachment of the sea at Westward Ho!, North Devon, by Herbert Green Spearing. Communicated by Prof. Prestwich, F.R.S.—On further discoveries of footprints of Vertebrate animals in the Lower New Red of Penrith, by George Varty Smith, F.G.S.

## PARIS

**Academy of Sciences, June 16.**—M. Rolland, president, in the chair.—Obituary notices of M. Bouisson, by M. Larrey; of M. Girardin, by M. Peligot; and of Mr. MacCormick, by M. Peligot.—Note accompanying the presentation of the second edition of his "Elementary Treatise of the Celestial Mechanism," by M. H. Resal.—Note on a communication from Dr. Tholozan regarding a meteorite reported to have fallen in February 1880, at Veramin, in the district of Zerind, sixty miles west of Teheran, Persia, by M. Daubrèe. An analysis of the fragments submitted to the author revealed the presence of bronzite, peshamite, peridote, nickel, and granulated iron, thus showing the same constitution as that of the remarkable meteorites of Logroño (1842), Estherville (1879), Hainholtz (1856), and Newton County, Arkansas (1860).—Graphic methods applied to the art of engineering: historic aspect of the question and claim of priority of invention of certain appliances for transporting large and bulky masses, by M. L. Lalanne.—Identification of the recently-explored Wed Margellil and Lake Kelbiah, Tunis, with the ancient River Triton and Triton Gulf, by M. Rouire. Lake Kelbiah, which still communicates intermittently with the sea between Carthage and Hammamet (Hadrumetum), appears to be the largest in North Africa, with a circumference of nearly thirty miles at low water and a length of twelve miles. It is flooded throughout the year, and was evidently a marine inlet within comparatively recent times.—Description of a new apparatus for evaporating and distilling, specially suitable for the pneumatic

treatment of saccharine juices (two illustrations), by M. P. Caliburès.—Remarks on the Polar spots observed on the planet Venus at the Meudon Observatory, by M. E. L. Trouvelot.—On the irrational roots in equations of the second degree, by M. A. E. Pellet.—On the position to be assigned to the mean fibre in curved pieces in the theory of resistances, by M. H. Léauté.—Note on some colloidal compounds derived from hydrate of iron, by M. E. Grimaux.—Chemical researches on the nitric acid of the nitrates present in vegetable tissues, by MM. A. Arnaud and L. Padé.—Description of a new and effective process of soldering aluminium and using aluminium in the soldering of other metals, by M. Bourbouze.—Account of a simple process for purifying arseniferous zinc, by M. L. L'Hôte.—Note on the nervous system of *Hyalinacia tubicola*, Mull., *Eunice torquata*, Quatr., *Lumbriconereis impatiens*, Clap., and other members of the Eunice family, by M. G. Pruvot.—Researches on antiseptic substances and the consequences resulting from their use in surgical practice, by M. B. Ratimoff.—Remarks accompanying the presentation of M. Capellini's work on "The Upper Chalk and Priboma Group in the Northern Apennines," by M. Hébert.

BERLIN

**Physiological Society**, May 16.—Prof. Waldeyer read a communication from Mr. Hoggan of London, on an investigation upon the nerve-endings in the skin of the Polar bear. The results of this investigation have already been published in English. The preparations which had been sent over by Mr. Hoggan were exhibited in the demonstration-hall of the Institution.—Herr Schmey gave a short account of an investigation upon the alterations in the sense of touch which supervene in the skin after certain treatment. After having by several weeks' practice fixed a determinate constant for his "sensation-circles" (i.e. for the territories on his skin which corresponded to a unit of sensation), he made experiments upon himself to determine the influence of the fatigue of an extremity upon the sensibility of the skin, further, as to the effects of the application of a mustard sinapism, of a hyperæmia produced by nitrite of amyl, and again of pressure on the nerve supplying the particular portion of skin experimented upon. He found among other things that in the first stage of skin irritation by a sinapism the sensibility of the skin was increased, in the second stage it was diminished, and that pressure upon the ulnar nerve was followed by a lessened sensibility in the area of its distribution.—Prof. Kronecker described the experiments made by Dr. Markwald to determine accurately the effects of *Secale cornutum* and its various constituents,—the physiological effects of the following preparations in particular, which are known in commerce and have been introduced into practical medicine, were the subject of investigation; these were Extractum Secalis cornuti, Ergotin from various sources, Ergotinin, and Sclerotinic acid. All the physiological actions, those upon the uterus as well as those upon the regularity of the heart-beat, upon the blood-pressure, and the hæmostatic effects were investigated, in some cases individually, in others collectively, on dogs and rabbits. The Extractum Secalis cornuti first raised the blood-pressure, which afterwards sank to below the normal, and afterwards gradually rose again to the normal height or to a little above it. The presumption that a complex preparation caused the mixed action was verified in subsequent experiments. For the ergotin produced in different degrees, according to the purity and goodness of the preparation, a more or less marked increase of the blood-pressure, which was followed by a sinking to the normal level; whereas sclerotinic acid always produced a fall of the blood-pressure, followed by a rise to the normal pressure. The pulse showed slowings after the exhibition of ergotin, interrupted by successions of accelerated pulsations, giving rise to the impression that this drug elicited a periodic stimulation of the vagus. This phenomenon did not occur after section of the vagi, and was peculiar to this preparation. Satisfactory evidence of the existence of hæmostatic properties in ergotin could not be obtained, though these were present in an eminent degree in sclerotinic acid; the amount of blood that flowed out of a cut artery in a unit of time after the exhibition of ergotin actually increased to an insignificant extent, whereas it decreased very considerably after exhibition of sclerotinic acid. Upon the contraction of the uterus the preparations secale extract, ergotin, and sclerotinic acid have alike a decided effect, but ergotinin, which occurs in commerce in the form of a solution, was in this respect, as well as in the other respects previously investigated, sometimes inoperative and at other times uncertain. Rules for

the therapeutical use of the preparations can easily be deduced from the physiological actions above described, but it is to be remarked that sclerotinic acid is very painful as a subcutaneous injection. This is not the case with a solution of ergotin. The results of the investigations were illustrated by Prof. Kronecker by means of numerous diagrams of curves.

VIENNA

**Imperial Academy of Sciences**, May 23.—L. Karpelles, on gall-mites (Phytoptus, Dug.).—L. Doederlein, contributions to a knowledge of the Japanese fishes.—R. Wegscheider, on isobutyl-naphthalene.—E. Spiegler, on an acetamine of the fat-series of high molecular constitution.

May 29.—Anniversary Meeting.—The meeting was opened in presence of the Crown Prince Rudolf by the Curator of the Academy, Archduke Rainer.—The Reports of the past year were read by the General Secretary, Prof. Siegel, and the Secretary of the Mathematical and Natural Science Class, Prof. Stefan.—Obituary Notes were read by the Secretaries on the members deceased—Prof. T. W. Gintl (Prague), Sir Edward Sabine, Jean Baptiste Dumas, Joachim Barrande, Julius Schmidt (Athens), Adolphe Wurtz.—The Reports were also read on the work done by the Prehistoric Commission and the Central Institute of Meteorology by Prof. Stefan. It was stated in this Report that the meteorological stations increased in number during 1883, ten stations being added during this year, and that a registering anemometer had been set up on the summit of the Obir Mountain (2147 m.), which works regularly.—Prof. Emil Weyr of Vienna University gave an address on the geometry of the ancient Egyptians, dealing with the contents of the papyrus, Rhind.

CONTENTS

PAGE

Science and the Woolwich and Sandhurst Examinations	189
Professor Tait's "Heat." By Prof. Balfour Stewart, F.R.S.	191
Our Book Shelf:—	
Haas's "Beiträge zur Kenntniss der Liasischen Brachiopodenfauna von Südtirol und Venetien."	
Dr. J. Gwyn Jeffreys, F.R.S.	192
Griffin's "Tricycles of the Year 1884"	192
Letters to the Editor:—	
Chalk and the "Origin and Distribution of Deep-Sea Deposits."—J. Starkie Gardner	192
A Rhyolitic Rock from Lake Tanganyika.—Prof. T. G. Bonney, F.R.S.	193
Aseismic Tables for Mitigating Earthquake Shocks.—Charles A. Stevenson	193
The "Cotton-Spinner."—Dr. F. Jeffrey Bell	193
The Red Glow.—S. E. Bishop	194
Light Phenomenon.—Major R. D. Gibney	194
Atmospheric Dust.—Alexander McAdie	194
Some Botanical Queries.—Ligus	194
Primæval Man and Working-Men Students.—W. G. S.	194
Forestry. By John R. Jackson	194
Rainfall of New South Wales	196
Calcutta Botanic Garden	196
The Extinct Lakes of the Great Basin	197
Notes	198
Our Astronomical Column:—	
The Oxford University Observatory	200
Variable Stars	200
Missing Nebulæ	201
Geological Notes:—	
Triclinic Pyroxene	201
The Brussels Museum and its Work	201
Geological Survey of Belgium	201
Geology of Finmark	201
American Jurassic Dinosaurs	201
Geological Survey of New Zealand	202
The Austrian Geological Institute	202
On Northern Norway under the Glacial Age. By Karl Pettersen	202
A New Form of Spring for Electric and other Measuring Instruments. By Profs. W. E. Ayrtton, F.R.S., and John Perry, M.E. (Illustrated)	205
University and Educational Intelligence	209
Scientific Serials	209
Societies and Academies	210

THURSDAY, JULY 3, 1884

## CHOLERA AT TOULON

THE doubt which existed as to whether the outbreak in and about Toulon was true cholera or only the sporadic type of the disease must be regarded as set at rest; indeed, from the date when the details of the outbreak first became public, it is probable that those who declared the affection to be only of a local and sporadic character were mainly influenced by political motives. Dr. Fauvel apparently now stands alone in the determination not to admit that the epidemic is the same as that which is known as Asiatic in type, and the fact that the source of the infection cannot by any chance be attributed to England is almost enough of itself to mould the views of this able physician. The onset of the disease, the sudden outbursts during its subsequent course, its diffusion to other towns and places, and notably to Marseilles, and the fatality attending it, all prove that we have not to do with the disease which in this country goes by the name of English cholera, and which when occurring in hotter climates and under favouring conditions of filth is known as sporadic, but with true cholera, such as was imported into the south of France and into England from Alexandria in 1865 and 1866.

Of the future course of the epidemic it is at this stage almost impossible to speak with any authority, but it is very certain that occasional lulls in the number of attacks—occurrences which are immediately reported as indicating a subsidence in the outbreak—cannot be regarded as having much significance in this respect; for it is one of the essential characteristics of cholera, especially in the early stage of an epidemic, to exhibit periodic fluctuations both in the number and in the intensity of attacks. So, also, the hold which cholera acquires in any town or district is largely dependent on the sanitary circumstances of the locality, and it is well known that in Toulon the conditions of filth which so especially favour the spread of that disease are exceptional in point of general prevalence and intensity. Marseilles stands much higher in this respect, but French towns which are regarded as ranking among the most advanced in so far as their sanitary circumstances are concerned stand but low in the scale when compared with the healthy towns of England.

Another circumstance has rendered it well-nigh impossible to foretell events, and that is the flight of panic-stricken persons to all parts of the country. Instead of dealing with the outbreak in its early stage, the French authorities made a secret of the matter, and by the time that the Government which takes precedence of all others in extolling the virtues of *cordons sanitaires* were prepared to act, they found that their secret had oozed out, and that thousands had fled beyond all *cordons*; and so once again the fear of restrictive measures such as quarantine and its allied practices has defeated the very objects which the advocates of that system so unhesitatingly claim for them.

Bringing the lesson of the epidemic home to ourselves, it must be admitted that, with the constant communication

which exists between the various French and English ports, we are not free from the risk of having cholera imported. To prevent importation by imposing a lengthened quarantine on the almost numberless vessels arriving in England from the various French ports would be an impossibility; and our Government, fortified by the decision of the last European Conference held at Vienna, will unquestionably trust, as heretofore, to a combined system of inspection and isolation. For this purpose all the Orders and Regulations which were re-issued during the prevalence of cholera in Egypt last autumn remain in force, as also does the special provision that persons removed to the hospitals of the Metropolitan Asylums Board are not to be regarded as having become pauperised in consequence of such removal. At our various ports vessels arriving from infected places will be inspected, first by the Customs Officers, and then by the Sanitary Officers of the ports; all cases of cholera or choleraic diarrhoea will be at once removed to such hospitals as have been provided for the purpose; any doubtful cases will be detained to undergo a short supervision; the healthy will be allowed to land; and no detention of the ship or of persons on board will exceed forty-eight hours, a period regarded as ample in view of the short period of incubation in the case of cholera.

Last year, when the question of the importation of cholera from Egypt was so urgent, the Local Government Board issued a special Memorandum to port, urban, and rural sanitary authorities, urging them to observe the utmost cleanliness in relation to all sources whence any pollution of water drunk or of air breathed could possibly emanate, and a vast amount of valuable sanitary work was carried out with the object of preserving water-sources from contamination, of excluding sewer and drain air from dwellings, and procuring the rapid and regular removal of all sources of nuisance and offensiveness from premises. We shall this year profit from so much of that work as was of a permanent character; but since it is essentially on cleanliness of all our surroundings that we must rely, the work of 1883 should be continued and renewed this year. Such work is never wasted. Even should cholera die out in the south of France, and never come nearer to us than it has done already, progress in sanitary work will be amply remunerative in the prevention of those diseases which, in point of origin, so much resemble cholera, and it will, in addition, tend to the moral and social improvement of those who only cling to filthy surroundings because the means of cleanliness have never been provided for them.

We are glad to learn that Dr. Koch, the chief of the recent German Cholera Commission to Egypt and India, has left Berlin for Toulon. His journey is undertaken partly at the wish of the French Government, who are anxious to know more of the methods of investigating and suppressing cholera which that gentleman has pursued with such signal success. Dr. Koch is going to France alone, although he had full permission to take with him any of his recent colleagues in Egypt and India. Moreover, the German Imperial Cholera Commission has concluded its deliberations. The result has now been submitted to the Government, and will be immediately published. The Commission holds that the sanitary condition of Germany in general is not favourable

to the outbreak of the epidemic. Further to lessen the danger, every separate household is to be requested immediately to carry out scrupulously the precautions and orders in reference to disinfection which are to be issued by the Government.

#### THE EARTH AS A GLOBE

*Die Erde als Weltkörper, ihre Atmosphäre und Hydro-sphäre, Astronomische Geographie, Meteorologie und Oceanographie.* Von Dr. Julius Hann. Pp. 209. (Prag: F. Tempsky; Berlin: G. Freytag. 1884.)

IT sometimes happens that the leading words in the title of a book give a very inadequate impression of its contents. Such, to an English reader at least, might be the case as regards the work before us. We should have rather anticipated a discussion of the relation of our globe to the surrounding universe, or at any rate its position as a member of the great family dependent on the same central source of light and warmth. A compatriot of the writer, it is but fair to suppose, would have formed a juster anticipation of what the title-page expresses and the contents explain, that we have here a description of the earth as an isolated globe. The first section sets before us its form, dimensions, density, seasons, magnetism in its several aspects, and auroral illumination. The following one discusses the various conditions of our atmosphere with regard to temperature, pressure, humidity, rainfall, winds, cyclones, and all that English people express by the brief and usually not complimentary phrase, "the weather." The third section relates to the "hydrosphere," or fluid envelope, comprising its extent, colour, saltness, temperature, currents, waves, and tides. This programme is carried out not only with a great deal of industry, and care, and judgment, but with a clearness and facility of expression which are not always remarkable in scientific treatises. We are very favourably impressed by it as a whole, and look upon it as a very valuable addition to the branch of science which it undertakes to elucidate. At the same time there are a few respects in which improvement might be desirable. We should have preferred, for instance, some explanation of the comparative imperfection of the longitude-measures obtained from Jupiter's satellites, as well as from lunar distances; the aeronautic details might have borne expansion with advantage; and we are a little disappointed in the very scanty notice of atmospheric electricity. Of this it may indeed be said that its investigation is peculiarly difficult, and that many of its modifications hitherto defy explanation; but it would have been, we venture to think, a preferable course, especially as so much pains have been taken with magnetism, if more explicit reference had been made to an influence of so powerful, yet so occult and mysterious a nature.

We may add, though we are treading on uncertain ground, that our author's descriptions of the English climate, or rather of what he considers that it ought to be, with regard to dryness or the reverse, are not altogether in agreement with our own experience. The character of our month of February, as expressed in the very ancient and still surviving epithet, "fill-dyke" (or "fill-ditch"), or in an old rhyme of the seventeenth century—

"Foul weather is no news, hail, rain, and snow  
Are now expected and esteem'd no woe,"—

does not tally well with our author's estimate of January as the most rainy of months, at least in West England; and his description of October as having a full maximum of rain in East and a secondary maximum in West England matches as little with the traditional remark of half a century ago, that eighteen fine days always occur in that month. Nor again is the April of West England, as he asserts, characterised by dryness, which used to be predicated of March, together with, in our grandsires' remembrance, a degree of heat which caused the unyoking of the weary ox during the noontide hours; so that we find in these instances the anticipation or postponement of a month. Our ground however is, as we have said, somewhat insecure; and we are obliged to admit that our old-world remembrances are often as far out of keeping with our present experience as the theoretical deductions of Dr. Hann. The October of late years has certainly not maintained its reputation for fineness, and we miss the regularity as well as the intensity of the equinoctial gales. There is an element of uncertainty and instability not only in the daily or monthly condition of the weather but in its annual recurrence, at least as far as our own climate is concerned; and it has presumably a much wider extent: a similar remark is not unknown in Switzerland, and was confirmed as to North Italy by the disappointing experience of that most accurate astronomer, Baron Dembowski, who in his latter years had, as he informed the writer of these lines, to contend with an unwonted amount of unfavourable skies. Such variations may possibly be very slowly periodical, and, if so, their recurrence might well be the subject of a careful examination. The weather-lore of modern days is undoubtedly far in advance of the imperfect forecasts of a century ago, and the pages before us have done well in aid of its further progress; but experience shows that the science of meteorology requires to be set upon a deeper and stronger foundation. The neglect of one or more imperfectly appreciated factors is probably indicated by the uncertainty or inconsistency of the results. One such factor may readily be pointed out in electrical agency, latent on every side, but awakened from time to time in manifestations equally fearful and incomprehensible. How to take due account of this all-pervading influence is a problem for future generations.

In closing our brief notice of this valuable work we would especially allude to the especial clearness—with few exceptions—of the very satisfactory as well as numerous diagrams which illustrate it. So far as we have observed, the faults of the book are very few: the greatest, as far as English students are concerned, is one that may easily be rectified, and we trust soon will be—its appearance in a foreign tongue.

#### PRACTICAL BOTANY

*Das botanische Practicum.* Von Dr. Eduard Strasburger. (Jena: Gustav Fischer, 1884.)

THE production of a series of important works in rapid succession has pointed out Prof. Strasburger as one of the most prominent figures among botanists of the present century. It will be readily

seen from the character of his researches, which deal for the most part with questions of minute structure and development, that he combines unusual power of close observation with originality of treatment and wide knowledge of methods. These qualities, together with a clear style of exposition, are those most needful for the production of a handbook for the guidance of students in the botanical laboratory; and the result does not disappoint the expectations of those who have been awaiting the appearance of Prof. Strasburger's volume.

The 600 pages of which the book consists are printed partly in large, partly in small, type, the former being intended for the beginner, the latter for the use of more advanced students. The whole is divided into thirty-four lessons, corresponding to the number of practical demonstrations habitually given in the course of one semester in a German University. But, as the author freely admits in his preface, it is not assumed that a detailed study of the objects named in one lesson could be made in the time during which one demonstration lasts; it is, however, stated that the time would usually suffice to give the student a general idea of the most important points. With due deference to Prof. Strasburger, in this admission lies the weak point in the book; if such a system as this be adopted with students on their first entrance into the botanical laboratory, and if the work be so presented to them that it should appear to them desirable rather to hurry through the study of a number of objects than to pay closer attention to a few, the result would naturally be the encouragement of a superficial style of observation; this method is not at all consistent with that usually adopted by German professors, and our experience as teachers on this side of the Channel does not lead us to approve of it. If, however, the student be not limited in respect of time, he would by carefully and successfully working through the course, both of large and small type, laid down for him, find himself at the end of it an accomplished laboratory botanist, well fitted to strike out a line of research for himself.

After giving a short introductory description of the microscope itself, and a list of makers and prices, Prof. Strasburger leads the student on by gradual steps, from the observation of starch-grains and their reactions, to the more complete study of the cell, with its included bodies, special attention being paid to the plastids and their various modifications. Having thus become acquainted with the general morphology of the cell, he is introduced to the study of tissues, the epidermis with its appendages being taken first, and subsequently the vascular bundles and surrounding tissues, as seen successively in the axis, root, and leaf; the constituent elements of these several tissues in the mature condition are made the subject of detailed observation. It is to be remarked, however, that little attention is paid to the comparative study of the *course* of the vascular bundles in the shoot, and the methods of its investigation; it is true that on pp. 282-303 this subject is dealt with in small type, but even there the treatment is almost entirely confined to the modifications of arrangement at the point of transition from stem to root; thus the student who works through the large type only will gain a very complete knowledge of the details of structure of the vascular bundle in various

of the whole bundle-systems in those plants may be very limited.

This course of study of the tissues of the vascular plants in the mature condition having occupied eighteen chapters, the 19th and 20th are devoted to a comparative investigation of the structure of growing points of stems and roots, and the development of tissues, while later chapters deal successively with the structure of the vegetative organs of the Mosses and of various forms among the Thallophytes. In Chapters XXIV.-XXXII. Prof. Strasburger treads upon ground which is peculiarly his own, and brings before the student in succession various examples illustrating the reproductive processes in plants, starting from the lower forms, and proceeding to those of higher organisation. In the concluding chapter he illustrates the processes of nuclear- and cell-division by means of examples already familiar to those who have followed his brilliant researches in this quarter.

The whole book thus forms a compendious and, including the small type, a very complete course of instruction for the student in the botanical laboratory. Throughout the text ample information is given as to methods of treatment, and the use of reagents; and this information is drawn together and made accessible by means of a special index (No. III.). Of the other indices, which form a most valuable addition to the work, the first refers to the names of the plants investigated, and the second to the instruments used, while, finally, No. IV. is a general index to names, reagents, and apparatus.

Prof. Strasburger has treated the question as to the advisability of placing drawings of the objects under investigation before the student in the laboratory in a truly characteristic manner. He has illustrated his book by 182 woodcuts, all of which have been specially prepared for this work. Whatever may be our views as to the effect of the use of such figures on the student, these, being drawn in Prof. Strasburger's well-known style, constitute in themselves a most welcome addition to the figures hitherto published.

There can be no doubt that among senior students and teachers this book will be appreciated as its great merits deserve; and that it will henceforward be an indispensable item in the furniture of the botanical laboratory. But, as may be gathered from what has been said above, it is no book for the cramming student; time must be allowed, and even more time than its author seems to realise, if full advantage is to be reaped from the course laid down. For this reason it is to be feared that it will not be so popular among our junior students as with those who are in a position to judge better of its value. F. O. B.

#### LETTERS TO THE EDITOR

[The Editor does not hold himself responsible for opinions expressed by his correspondents. Neither can he undertake to return, or to correspond with the writers of, rejected manuscripts. No notice is taken of anonymous communications.]

[The Editor urgently requests correspondents to keep their letters as short as possible. The pressure on his space is so great that it is impossible otherwise to insure the appearance even of communications containing interesting and novel facts.]

#### Chalk and the "Origin and Distribution of Deep-Sea Deposits"

IN a letter of Mr. Starkie Gardner's in the last number of NATURE (p. 192), he stated that my opinion as to the Chalk



having been a shallow-water deposit was "based exclusively on the present habits of the very few genera of Mollusca that have survived from the Chalk period, and seems quite in contradiction to the far more important groups, the Sponges, Echinodermata, and the minute organisms of which the formation is so largely composed, while no opinion has yet found its way into the hands of geologists regarding the depth of water indicated by the Crustacea and the fishes of the Chalk." Mr. Gardner appears to have overlooked that passage in my Address to the Biological Section of the British Association (to which he refers in his letter), wherein I added, "Mr. Woodward tells me that the Chalk Crustacea are shallow-water forms." Dr. Woodward is certainly no mean authority on fossil Crustacea. As to the surviving genera of Chalk Mollusca being "very few" in number, I would refer him and my readers to the long list of genera given in my Address, which was furnished by our great paleontologist, Mr. Etheridge, and to the exclusively littoral habits of some of those genera. And with respect to the Sponges, Echinodermata, and minute organisms being "far more important groups" than the Mollusca, I must leave that question to naturalists in general. Sponges (silicious as well as horny or ceratose), and Echinoderms are notoriously not restricted to deep water. Quite the contrary. They live at every depth from the shore between tide-marks to the abyssal and benthic zones. The "minute organisms" which enter so largely into the composition of the Chalk, for the most part, if not entirely, inhabit the surface of the sea.

J. GWYN JEFFREYS

June 30

#### Protoplasmic Continuity in Plants

IN the very interesting article on "The Continuity of the Protoplasm through the walls of Vegetable Cells," which appeared in NATURE of June 19 (p. 182), reference is made to the doubt which still exists as to "whether the continuity is maintained from the earliest stages, or is established later." This point is so important in its physiological bearings, as the article goes on to show, that I may, perhaps, be allowed to state that, with regard to one group of plants, the question appears to be already settled. I allude to the Red Sea-weeds or the *Florideae*. The writer of the article makes no mention of these plants, but, as I have described elsewhere (see *British Association Report*, 1883, p. 547, and *Journal of Botany*, February and March 1884), many of them exhibit a very notable system of intercellular connections, which, extending over the whole thallus, renders the protoplasm practically continuous from the base of the frond to the extremities of its furthest ramifications. Now in these cases the continuity is certainly maintained from the first, and is due to the mode of cell division by which the thallus is built up. Into the details of this there is no need to enter further than to say that, when the protoplasmic body of a cell divides into two or more portions, these do not become completely separated from one another, but remain connected *inter se* by strands of protoplasmic material, which grow in thickness with the growth of the cells, and thus maintain the continuity from the earliest stages onward. So far, then, as concerns the *Florideae*, I venture to think the physiological import of the phenomena of continuity may be safely discussed on the assumption of its existence *ab initio*. What that import may be I do not propose to consider, my object being simply to point to the *Florideae* as throwing valuable light on the whole subject, and giving some support to the view that "the entire plant or organ is practically one whole—one mass of protoplasm cut up into chambers which communicate with one another, and bounded by a membrane on the exterior." THOMAS HICK

#### Aseismic Tables for Mitigating Earthquake Shocks

WITH respect to Mr. C. A. Stevenson's letter in your last issue (p. 193), I may state that my information was obtained from Mr. R. H. Brunton's paper on "The Japan Lights" in *Proc. Inst. Civ. Eng.*, vol. xlvii., pp. 6-8, 35, and from the communication by Messrs. Stevenson in the "Discussion" on that paper (pp. 26-29). The results referred to by Mr. Stevenson have, perhaps, been obtained since this paper was read (November 14, 1876).

W. TOPLEY

28, Jermyn Street, London, June 27

#### Black Rain

A REMARKABLE shower of black rain fell here and in the neighbourhood last Sunday, the 22nd inst. The forenoon had

been fine, though somewhat hazy, but about 3.30 p.m. heavy cumuli formed to north and north-west. Gradually a dense mass of cloud and haze came from the northward, presenting a lurid, threatening aspect, and it became so dark that one could not read a book indoors. At 4.30 rain began to fall, at first a few drops, and soon after a heavy downpour. When this commenced I noticed a number of black objects floating in the air, which I at first took to be flies or winged ants, but they rapidly increased in number, and on looking at them more closely I found them to be particles of soot, on an average about the size of the common fly. Their number was so great that, it appeared for ten minutes to be snowing black, the descent of the blacks being slow, like that of snowflakes. After it had rained heavily for fifteen minutes, these "blacks" ceased and the air became lighter, but the rain continued for another hour, and altogether I measured 30 inches in my gauge. I find on inquiry that this black rain was noticed in the whole neighbourhood—at least four miles to the north-east and two miles to westward, hence it cannot have been due to local chimneys. As far as I can ascertain, the shower was entirely local; it seems to have followed a narrow course from north to south only a few miles wide, and did not extend to either Eastbourne or Hastings.

Fletching, Sussex, June 24

W. J. TREUTLER

#### A Cannibal Snake

RATHER a strange occurrence came recently before my notice, and thinking perhaps you might care to insert it in your columns, I send you the facts of the circumstance. A few days since, towards evening, I killed a snake just close behind my house; it measured about a yard and a half in length, was one of the most deadly of the numerous kinds of snakes found in Java, and bears the name of "Oelar belang." On examining it later I found what I thought to be the tail of another small snake protruding from its mouth, but on pulling it out I was greatly surprised to discover that it was really a snake of the same species, and of almost the same length. There was certainly not more than three inches' difference in the length of the two snakes, and at the time I killed the outside snake only about an inch and a half or two inches of the tail of the one he had swallowed protruded from his mouth. The outside snake was of course considerably the thicker of the two, but this may be attributed to his having swollen after, or rather during, his tremendous meal. The natives here say that the two snakes must have been fighting, the victor afterwards swallowing his opponent. I should be pleased to know whether such an instance has ever before been brought before your notice, or whether it is really an uncommon case.

EDWIN H. EVANS

Soemedang, Java, May 20

#### Peronospora infestans

ON the 22nd inst. I observed that this fungus had appeared on the haulm of the potato crop in one or two places in my garden in this city. On examining to-day a potato crop in another garden a mile distant from mine, I perceived that that crop was likewise affected. Considering the dryness of the spring weather, the appearance of the disease is remarkable. According to my observation, the attack of the mould is a month earlier than usual. It may be added that hereabouts, this season, blight of all kinds is prevalent, while last year was blight free. Inclosed is a specimen of diseased haulm.

J. LL. BOZWARD

Worcester, June 24

#### KEPHIR

IN No. 10 of the *Journal of the Berlin Chemical Society* for June 23 is a communication on this substance by M. Struve of Tiflis, continued from a previous note in the same journal of February 25.

Kephir is a form of fermented milk which has been prepared and in use amongst the inhabitants of the Northern Caucasus for a great length of time, and occupies with them a similar position as an article of diet and medicine to that of kumis in the south-eastern steppes of Russia.

Kumis was first brought into notice in 1784, and has since then been pretty fully investigated and taken a definite position, but kephir has only been generally

known even in Russia for about two years, although several notices of its medicinal properties have been contributed to the Caucasian Medical Society. The knowledge and spreading use of this new drink in Russia dates apparently from an investigation and paper read on this new ferment product by E. Kern at the Moscow meeting of the Imperial Naturalists' Society in 1881.

Kephir is prepared by fermenting milk, either sheep's, goats', or cows' milk, with what are termed kephir-grains, the process taking place in leather bottles (*Burdinks*). These grains are the ferment proper, the leather bottle not being supposed to be absolutely necessary. During the fermentation the milk becomes very much changed, and at the same time there is a reproduction of the ferment substance or kephir-grains, which is removed after a certain stage of fermentation has been reached, and after drying in the sun may be preserved, and serves again to effect the fermentation process. Nothing is known of the origin of this peculiar ferment. An analysis of the grains dried at 100° C. gave:—

Water	...	...	...	...	11'21
Fats	...	...	...	...	3'99
Soluble peptone substances	...	...	...	...	10'98
Proteids soluble in ammonia	...	...	...	...	10'32
"	"	potash	...	...	30'39
Insoluble	...	...	...	...	33'11

The insoluble residue exhibited under the microscope an intimate mixture of yeast-cells, and the *Bacterium dispora caucasica* with a few *Leptothrix* and *Oidium lactis* possibly as accidental. This 33'11 per cent. of insoluble matter seems to be the only active part of the kephir grains. On preparing some kephir in bottles with this, the product became slightly effervescent after twenty-four hours, and contained a small amount of alcohol. After three days the amount of alcohol and carbonic acid was much increased. On making an examination of the fermented liquid after one, two, and three days respectively, the quantity of casein found was practically the same in each case. But on treating the casein so obtained with dilute ammonia and then dilute potash solution, in no case was there a complete solution. An amount of insoluble residue was obtained from the *third-day* experiment of '22 per cent. of the casein, and which consisted entirely of yeast-cells. From this is concluded that the fermentation of the milk is entirely due to *Saccharomyces mycoderma*, the *Bacterium dispora caucasica* not taking any part in the fermentation, and this seems to be further supported by the fact that the "finished" drinkable kephir will start fermentation in fresh milk in the same manner as the kephir-grains.

The *Bacterium "dispora"* which Kern noticed, and to the action of which he ascribed the peculiar properties of kephir, probably results, in quite a secondary manner, from the employment by the people in the Caucasus of the old leather of the bottles in which kephir has been fermented. In this process in leather bottles the yeast-cells are in contact with the leather, and to some extent possibly grow or extend into it, so that they become modified physically, and the rapidity of fermentation is much lessened. Any animal tissue which has become, as it were, saturated or penetrated by yeast-cells is capable of causing sugar solutions and also milk to ferment, and can therefore be used in place of these kephir-grains for the preparation of kephir.

#### HENRY WATTS, F.R.S.

WE regret to announce the death of Mr. Henry Watts, F.R.S., the well-known chemist; he died on June 30, of syncope from failure of the heart's action, after a very short illness.

Henry Watts was born in London on January 20, 1815. He was educated first at a private school in

London, and subsequently attended lectures at the University College, London. In 1841 he graduated as Bachelor of Arts in the University of London. In 1846 he entered the Birkbeck Laboratory of Chemistry, then recently established at University College, as assistant to his highly valued friend, the late Prof. Fownes, and in that capacity was engaged in directing the work of the students till the death of Prof. Fownes in 1849, and afterwards till 1857 under Prof. Williamson. In 1848 he was engaged by the Cavendish Society to prepare a translation, with additions, of the great "Handbuch der Chemie" of Leopold Gmelin, a work which extended to eighteen volumes, and occupied a large portion of his time for more than twenty years, the last volume and the index having been published in 1872.

In 1858 he began to prepare a new edition of "Ure's Dictionary of Chemistry and Mineralogy"; but finding that this book, the last edition of which appeared in 1831, had fallen too much behind the existing state of chemistry to be made the groundwork of a dictionary adapted to the requirements of the time, he undertook, with the consent of the publishers, and the assistance of a staff of contributors distinguished for their attainments in different branches of physics and chemistry, the compilation of a new "Dictionary of Chemistry and the Allied Branches of other Sciences." This work, in five large octavo volumes, was completed in 1868; but as additions were required to keep it abreast of the continual advances of science, a supplementary volume was published in 1872, a second supplement in 1875, and a third (in two parts) in 1879 and 1881.

Mr. Watts brought out three editions of "Fownes's Manual of Chemistry," viz. the tenth, published in 1868, the eleventh in 1872, and the twelfth in 1877, and also part 1 of a thirteenth, in 1883.

He held for many years the appointments of editor of the *Journal*, and librarian, to the Chemical Society, having been appointed to the former in 1850, and to the latter in 1861. He was elected a Fellow of the Chemical Society in 1847, a Fellow of the Royal Society in 1866, and a member of the Physical Society in 1879. He was also an Honorary Member of the Pharmaceutical Society, and a Life Governor of University College.

He was engaged at the time of his death in writing a new and abridged edition of the "Dictionary of Chemistry"; he was also editing, in conjunction with Mr. C. E. Groves, a re-issue of "Knapp's Technology," and the thirteenth edition of "Fownes's Manual of Chemistry," of which the second volume is left in manuscript.

#### GEOLOGY AT THE BRITISH ASSOCIATION

THE arrangements for the Geological Section of the British Association are now well advanced, and some idea may be formed of the amount of work likely to be done. Several meetings of the Organising Committee have been held in London, at some of which Principal Dawson has been present. From the list of members of the Association to whom vouchers for the meeting have been issued we learn that English geology will be represented at Montreal by six professors—those of Edinburgh; Trinity College, Dublin; University College, London; Victoria University, Manchester; and University College, Nottingham; and by Prof. T. R. Jones. The Geological Society sends sixty of its Fellows, including the President, Secretary, and six other Members of Council. Many of the leading geologists of Canada also are Fellows of that Society. The Geological Survey sends six of its members, and six or more who have at one time been on the staff.

The President of the Section is Mr. W. T. Blanford, Secretary of the Geological Society, who will afterwards represent that Society at the Philadelphia meeting of the American Association; the Vice-Presidents are Prof. T.

R. Jones and Mr. A. R. Selwyn; the Secretaries are Dr. G. M. Dawson, Messrs. F. Adams, W. Topley (Recorder), and W. Whitaker.

The International Geological Congress meets at Berlin in September, and this will prevent many Continental geologists from going to Montreal; Dr. Richthofen, however, will probably be present, and will communicate a paper on some comparisons between the geology of China and North America. It is hoped that others may also arrange to come.

Meeting in the typical Laurentian country, it is only to be expected that the Archæan rocks will receive much attention. Amongst the papers sent or promised are the following:—Prof. Bonney, on the Lithological Characters of the Archæan Rocks in Canada and Elsewhere; Mr. Frank Adams, on the Occurrence of the Norwegian "Apatitbringer" in Canada, with a few Notes on the Microscopic Characters of some Laurentian Amphibolites; Dr. T. Sterry Hunt, on the Eozoic Rocks of North America.

On Palæozoic Geology and Palæontology generally the following are expected:—L. W. Bailey, on the Acadian Basin in American Geology; E. W. Claypole, the Oldest Known Vertebrates—an Account of some Fossils recently discovered in the Silurian Rocks of Pennsylvania; Mr. J. H. Panton, of Winnipeg, Geological Gleanings from the Outcrops of Silurian Strata in the Red River Valley, Manitoba.

Principal Dawson will give a Comparison of the Palæozoic Floras of North America and Europe, whilst Mr. J. S. Gardner will deal with the same subject as regards the Cretaceous-Tertiary Floras.

Other papers are:—G. F. Matthews, on the Geological Age of the Acadian Fauna, and on the Primitive Conocorypcean; E. Wethered, the Structure of English and American Coals.

After the Azoic and Palæozoic rocks of Canada, the Drift Deposits are of great interest. The following papers bear on this subject:—Mr. A. R. Selwyn, on a Theory of Ice Action in the Formation of Lake Basins and in the Distribution of Boulders in Northern Latitudes; the Rev. E. Hill, on Theories of Glaciation; F. Drew, on the Thickness of Ice in the Himalayan Valleys during the Glacial Period.

Amongst other papers of interest are:—Prof. Hull, on the Geology of Palestine, giving an account of his recent explorations; Prof. T. R. Jones, on the Geology of South Africa; W. Whitaker, on the Economic Value of Geological Maps, with especial reference to water-supply, illustrated by the Survey Maps of the Chalk area in England.

Papers are also promised by Mr. Arch. Geikie, Dr. G. M. Dawson, Prof. V. Ball, Prof. W. Boyd Dawkins, Dr. C. Le Neve Foster, W. Carruthers, H. Bauerman, E. Gilpin of Halifax, N.S., and others.

Other papers will be sent by American and Canadian geologists, particulars of which have not yet been received. Prof. James D. Dana and Dr. James Hall, if not present in person, will probably send one or more communications.

Several Reports will be submitted by Committees, or by persons appointed for this purpose at the last meeting of the Association (the name mentioned is that of the Secretary to the Committee, or the Reporter):—Prof. J. Milne, Earthquakes in Japan; W. Cash, Fossil Plants of Halifax; G. R. Vine, British Fossil Polyzoa; Dr. H. W. Crosskey, Erratic Blocks of England, Wales, and Ireland; Prof. T. R. Jones, Fossil Phyllopora of the Palæozoic Rocks; C. E. De Rance, Underground Waters; J. W. Davis, Raygill Fissure, Yorkshire; C. E. De Rance and W. Topley, Erosion of Sea-Coasts of England and Wales; F. Drew and Prof. A. H. Green, the Present State of Knowledge respecting the Interior of the Earth; W. Whitaker, Geological Record; W. Topley, National Geo-

logical Surveys; and Progress of the International Geological Map of Europe.

With several sections of the Association the work is mainly confined to the meeting room. Geologists are more fortunate, their most pleasant memories of these meetings are with the hills, rocks, and streams of the district. At and near Montreal there is much to be seen. Mount Royal rises steeply behind the city, a mass of eruptive rock intruded through the Silurian beds. From the summit a grand view is obtained over the Laurentian Mountain on the north, and over the hills and rolling plains of Silurian rocks on the south and east. From amongst these latter rise the more sharply defined trap hills of Montarville, Beloil, and Rougemont. The excursions are of especial geological interest. Niagara is only a short run of 300 miles away; the Rocky Mountains will be reached by a special train over the Canadian and Pacific Railway.

The Local Committee at Montreal is preparing a guide-book to the city and neighbourhood, which will contain a geological map. A general Geological Guide to the Dominion will be prepared by the Geological Survey of Canada.

#### PRIMARY EDUCATION AT THE HEALTH EXHIBITION

THE recent opening of the City and Guilds of London Institute by the Prince of Wales, and the simultaneous issue of a special catalogue of the educational exhibits at the Health Exhibition, which are for the most part housed in that Institute, has been the means of drawing much public attention to this most interesting and valuable collection, and renders some account of it opportune. It is probably not too much to say that no such elaborate and extensive collection of educational appliances, methods, and results, has ever been brought together before, notwithstanding the fact that, the primary object of the whole Exhibition being to elucidate the conditions of health, it was considered expedient to attach to the principal display mainly such objects and appliances as had a special relation to healthful school life. This limitation, however, has been interpreted somewhat liberally, and the result is a collection in which can be studied and compared the educational systems in primary, general, and technical education as practised in the British Islands, France, and Belgium, and to a less extent in Germany, Sweden, Switzerland, the United States, and Canada. It is earnestly to be hoped that such an opportunity for comparing their own systems, practice, and results with those of others, whether English or foreign, will not be allowed to pass by our schoolmasters and schoolmistresses, as well as by members of School Boards, and indeed by all interested in this vast subject. We hear with pleasure that it is intended to organise visits there by parties of London masters and mistresses, and we hope that arrangements will be made enabling provincial educationalists to avail themselves of the advantages offered by this temporary display at South Kensington, which will not be prolonged beyond the middle of October.

Two foreign Governments, those of France and Belgium, have organised elaborate collective exhibitions, showing the methods and results both of primary and secondary education in those countries, and the catalogue of the French exhibit is prefaced by ten closely printed pages containing an admirable summary of the present position of education in France, which has of late made most rapid advances. The money which neither the Liberals of the Restoration, nor those of the Monarchy of July, nor the *Corps Legislatif* of the Second Empire, had been able or willing to find for popular education, the Parliament of the Third Republic, definitely consolidated in 1877, has not feared to demand of the State, notwithstanding the pressure of taxes resulting from the foreign

and civil war of 1870. In 1882-83 there were 5,432,151 pupils, and 129,657 public teachers (of whom only 21,781 were uncertificated) in the elementary primary schools of France, and the general outlay of the State for primary education amounted in the same year to 94,881, 942 francs, or about 3,825,000*l*.

While cordially recognising the very great trouble that the Ministers of Public Instruction in France and Belgium have taken to illustrate their respective systems, we must not forget that our Education Department occupies a different and wholly unique position, and hence that the English Government, as a Government, is unable to make a similar display. Our Education Department scrupulously abstains from enforcing particular methods and processes, simply requiring that by some local means, voluntary or otherwise, efficient schools shall be provided, and it then confines itself to the estimation of results and to the distribution of funds provided by Parliament in aid of the local efforts; in a word, its control is indirect rather than authoritative. The intelligent foreigner therefore has to search through the collective exhibits of the great voluntary societies which have so long and so largely influenced English primary education, and also of several of the municipal bodies called into existence by the Education Act of 1870, in order to become conversant with the methods and results of English schools. In the special catalogue for education, each of these bodies which exhibits has taken the opportunity to place on record an account of its aims and history, and of the scope and character of its present work. Such additions to this catalogue, occupying many closely printed pages, render it a very admirable hand-book to the whole subject of education, and add immensely to its value. Among the most interesting and valuable statements of this kind are those issued by (to use the shorter titles) the National Society, the British and Foreign School Society, the Wesleyan Education Committee, the Sunday School and the Ragged School Unions, and the School Boards of London, Birmingham, Glasgow, and Edinburgh.

There is one Society, however, which merits more than a passing notice, since its collective exhibit is not merely one of the most remarkable and interesting in the whole Educational Exhibition, but is also one from which a great deal is to be learnt. It is cosmopolitan in its aims, and exhibits the results of its schools in Belgium, France, England, the United States, Canada, Egypt, and India, although its head-quarters are in Paris. The Institute of the Brothers of the Christian Schools was founded in 1680 by the Venerable Dr. J. B. De La Salle, who was the first to establish primary education in France, and also training colleges for teachers. At present the Institute has nearly 12,000 Brothers, distributed over thirteen countries, directing 1200 schools, with an attendance of about 330,000 pupils, who, we regret to say, are all boys, the Brothers not concerning themselves in any way with the education of girls. The Brothers everywhere follow the same general methods of teaching, while they modify the details according to the custom of the country in which they are, varying their programmes also to meet local requirements and the wants of the times; for example, in their United States schools, where all the boys stay till about sixteen, every boy in the first class learns (1) shorthand writing, (2) the use of the type-writer, (3) the Morse alphabet, since without these acquirements the Brothers are unable to get situations for their pupils. The rooms in the Technical Institute, as well as the space in the Belgian and French Courts devoted to the results of their work, will well repay very careful examination, since only their most leading features can be here indicated. Foremost among these, and bearing distinctly upon a subject recently discussed both in this journal and in the *Spectator*, is their system of models, maps, and atlases for the scientific teaching of geography, which are exhibited by Brother Alexis. These maps were the first

hypsometrical maps published in French, and, we believe the first of the kind published anywhere for school use, and are intended to give, by a suitable arrangement of colours, clear notions of the real configuration of the earth's surface. An introduction to their study is afforded by a glass tank, with a very uneven bottom, upon which contour lines are marked; when this is filled to various depths with water, the effects of changes in the relative level of land and sea are clearly and effectively demonstrated. This demonstrative or objective method is the keynote to the system of instruction adopted by the Brothers, and its effect is seen in many instances, notably in the splendid school museums of Annecy (Savoy), Beauvais, Rome, and Marseilles, in which the specimens are all collected by the pupils, and classified by the masters; in the apparatus employed in scientific and handwork teaching; and in their system of teaching drawing, the results of which, as illustrated by an enormous series of designs, entirely the work of pupils, are almost incredible. The lithographed notes of science lessons distributed to the pupils, and the extensive series of science and other text-books, written in various languages by the Brothers, all deserve close inspection.

The Ministry of Public Instruction in Brussels illustrates most fully the Belgian educational methods, and here again one of the most prominent points is the teaching of geography, which is most completely systematised and thoroughly scientific; the minutely detailed maps of the War Department form the basis of much of this, dealing thoroughly with the physical and geological conditions of the country, which are gradually shown, one thing at a time, in a progressive series of maps. The technological and other school museums (notably that at Verniers) collected by the pupils, deserve special notice, as does the whole apparatus for handicraft teaching, such, for example, as the pasteboard models made by the pupils for the demonstration of problems in solid geometry, and of algebraical formulæ treated geometrically. The city of Antwerp furnishes a very interesting collective exhibit, further illustrating these points, and in this connection may also be mentioned the single exhibitors, D. Windels, whose zoological models of animals to scale are admirable, and J. B. Gochet, who shows a complete course of geography.

In the French Section the method and good gradation of all the school work and the way in which these points are illustrated in the exhibit are very remarkable. Here again we find great prominence given to the objective method of teaching in almost every subject; the results of the handicraft teaching of children from ten to thirteen in the Département du Nord are almost incredibly good, while the method of it in the Prevot Orphanage is excellent. The excellent choice of books for school libraries, the system of instruction in rhetoric and in the duties of citizenship, the results of the Ecole Normale de Travail Manuel, and the programme of instruction for 1882, are particularly noticeable.

Of the English system, as illustrated by the Societies and the School Boards, the exigencies of space allow us to say but little. The publications of several of those enumerated above are well known, as are also their school appliances. For the methods and results of school work, the exhibits of the School Boards must be consulted. Here we are at once struck with the comparative absence of the apparatus for, and the results of, that objective system of teaching which stands out so prominently in the Continental systems. A praiseworthy exception to this, however, is to be found in the room devoted to the Birmingham School Board, where Mr. Jerome Harrison exhibits the apparatus and results of the itinerant system of teaching science to every child above Standard IV. in the Board schools of that town. The systematic arrangement of every subject of instruction, and especially of the needle-work, is particularly notice-

able here. More space is occupied by the London School Board, whose lending libraries for schools and reference libraries for pupil teachers are well selected. The geographical teaching cannot, of course, be compared with that on the Continent, though some of the district maps are good. Fair provision is made for teaching science to pupil teachers, but there is a lamentable deficiency in the apparatus for this and for the whole system of object-lessons, when the needs of the scholars themselves are considered. The School Boards of Edinburgh and Glasgow show some excellent models, photographs, and plans of school buildings of the newest type, and some remarkable specimens of drawing. The Wesleyan Education Committee show some excellent results of the scientific and handicraft training of boys, and some very simple yet remarkably effective appliances for elementary geographical instruction.

Although these collective displays by public bodies are the most interesting feature of this portion of the Exhibition, there is much that will repay examination in the various objects shown by many single exhibitors of the great variety of school desks and furniture; some of the desks of G. M. Hammer, G. E. Hawes, and H. Simon and Co., deserve more than a passing notice, as do also the revolving partitions of Hodgkinson and Clarke. Among maps and charts the collection of Mr. E. Stanford stands out prominently, and is specially noticeable for the five series of physical and orographical maps, some of which in frames are on continuous sheets and rollers. Mr. Bacon's maps are singularly clear and good for school use, and his picture-lessons in geography are a step in the right direction. The apparatus for teaching music, exhibited by J. Curwen and Sons, is perhaps not approached by any similar exhibit. The science charts and diagrams produced by M. Emile Deyrolle are of an extremely high degree of excellence, and deserve to be made widely known. The educational publications of such firms as Messrs. Cassell and Co., Messrs. Gill and Sons, the Messrs. Johnston, Messrs. Griffith and Farran, Messrs. Bemrose and Sons, and Messrs. William Collins, Sons, and Co., who are all well represented, are too well known to need more than a reference.

In a second article we hope to deal in a similar way with the exhibits of apparatus and results of scientific and technical teaching carried to a higher degree than in mere primary schools, and also, briefly and by way of introduction, with that range of subjects which may be shortly described as comprising the technical education of children and girls. It may perhaps be permitted to the writer to say, as the result of a very close examination (extending over more than a week continuously) of the exhibits relating to primary education in various countries, that one important lesson to be learnt from the comparison of Continental methods with our own is the great advantage afforded by the objective system of teaching, and by the adoption of that systematic order and method in all subjects of instruction, literary or otherwise, to which the name scientific, in the highest and best sense of the term, is applicable.

WM. LANT CARPENTER

### WORK-MEASURING MACHINES<sup>1</sup>

UNDER this title a little *brochure* has recently appeared from the pen of the Rev. F. J. Smith, B.A., of Taunton, in which work-measuring dynamometers, or *ergometers*, as the author terms them, of various forms are described. Amongst these machines there are many devised by the author himself, and some of these are of considerable interest and much originality. The transmission ergometers of the type originally invented by General Morin deserve notice in particular. The follow-

ing is the general principle involved in transmission ergometers:—

Let it be supposed that a belt passes over from the driving wheel of a prime-mover such as a steam-engine to the pulley of a dynamo which is being driven. One half of the belt is subjected to a strong pull, the other is relatively slack. Then if we could introduce spring balances into the two parts of the belt, and if we could read the difference of the tensions  $T$  and  $T'$ , and if we multiplied this  $T - T'$ , expressed in pounds, by the velocity of the belt in feet per second, we should then have the "foot-pounds per second" spent in driving the dynamo. From this we can calculate the horse-power by dividing it by 550, since 550 foot-pounds per second is one horse-power. This we may write algebraically:—

$$\text{H.P.} = \frac{(T - T') v}{550}$$

where  $v$  denotes the velocity of the belt in feet per second.

Now since such an arrangement as this cannot be easily carried out, the usual method is to place between the engine and the dynamo some instrument capable of showing the tension of the belt in pounds, and the velocity of the belt, and in certain cases these instruments can even give a continuous record of the work done. The ergometer devised by Mr. Smith is an admirable instance of such a combination, and it undoubtedly possesses points of superiority over all transmission dynamometers hitherto invented. A view of the machine (see figure) shows how the ergometer is arranged. The central shaft, of Whitworth steel, which is tubular at each end and link-shaped between, carries two pulleys. One is keyed to the shaft and carries two bevel-wheels, these engage with another bevel-wheel which forms part of the second pulley, which is loose on the shaft.

To each of the two bevel-wheels, as shown in the diagram, there is fitted a cylindrical drum, on these either gut or steel tape is coiled over three-fourths of their faces, and the gut or tape is attached to a cross-head. The latter is in turn attached to a cylindrical steel spring placed within the link, and from the cross-head a rod of steel, passing through one end of the link, actuates the pointer of a dial, whereby the pull on the spring attached to the end of the link is shown. This instrument resembles therefore the earlier dynamometer of Morin having two pulleys; the angular advance of one of them being regulated by a spring. But in Morin's form the spring was simply an extended piece of steel. In the more recent modification by Profs. Ayrton and Perry, coiled steel springs are also used; but in that instrument the springs are liable to fly out by centrifugal force, and the arrangement for observing the angular advance is an optical one, requiring an observation of a silvered bead by a reading-telescope. In Mr. Smith's ergometer there is no such tendency of the spring to fly, and the tension is read direct on a dial. The speed indicator is shown just below. If a continuous record of work is required, the steel rod is either attached to a recording drum or to an integrating apparatus.

The instrument having been placed between a prime mover and a machine to be tested, the belt from the prime-mover drives the loose pulley, and another belt from the fixed pulley drives the machine to be tested. The tension on the driving side of the belt causes the spring to be extended by means of the bevel-wheels, and difference of the tensions is indicated by the pointer of the dial. The instrument is calibrated by hanging known weights from strong thin cords or catgut strings passing round the pulleys, and marking the dial in accordance with the weights.

The springs used by Mr. Smith are made by Messrs. Salter and Co., they are of four sizes, capable of being extended 2 inches by 50, 100, 150, and 200 lbs. respectively. They have been put to several tests, but have some-

<sup>1</sup> "Work-Measuring Machines." By Frederick J. Smith, B.A. 32 pp. 12mo. (London: E. and F. N. Spon, 1884.)

out of them quite unaltered. However, so as to leave no doubt as to the accuracy of the readings of the ergometer, the instrument is finally calibrated by another method, which is new; it is as follows:—

Let a prime-mover (a water-wheel appears to be the most steady) drive the transmission ergometer, and let the ergometer drive a pulley on a shaft embraced by a suitable friction ergometer, such as a Prony brake or an Appold's brake, and let the work done against friction be calculated. This should agree with the results of the transmission machine. If it does, we may conclude that it has been correctly calibrated. The advantage of this method is that the transmission machine is tested while

running in its usual condition. When testing a dynamo care should be taken that the speed indicator be well attached to the shaft the velocity of which it is measuring. A piece of coiled spring, such as is used in a dentist's lathe, answers well to connect it to the machine.

The leading feature of this instrument is the position of the spring in it. The axis of the spring and of the shaft coincide; the result of this is that it is hardly at all affected by centrifugal force. When springs of slight pull are used and the ergometer is driven at a great velocity, the deformation is considerable, and would introduce considerable error into the result.

The deformation of the spring has been fully appre-

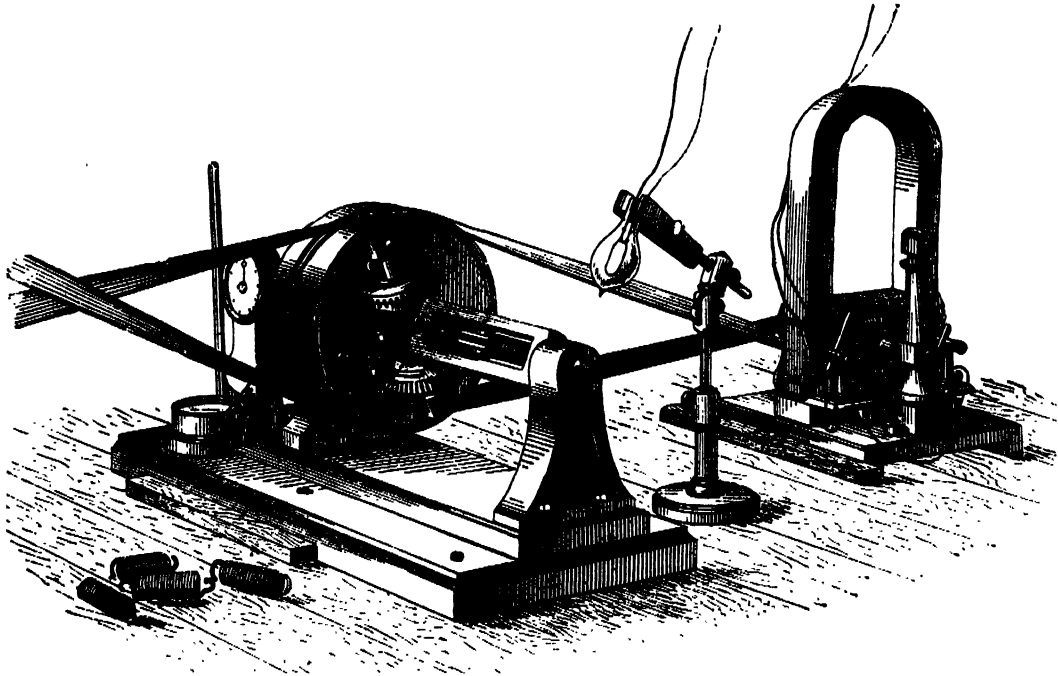

Smith's Transmission Ergometer.

ciated by Schuckert, and therefore he has placed the spiral springs of his ergometer in cylindrical cases.

When the spring is placed with its axis coincidental with that of the machine, no such error can be introduced, and the friction of a spring against a case is avoided.

When a continuous record of work is required, a cylinder, not shown in the figure, is placed at the dial end of the instrument, and is driven at a speed proportional to the speed of driving. It carries a band of paper which receives a continuous trace from three self-feeding inks: one pen is attached to the lever which is moved by the extension of the spring, and it writes ordinates directly

proportional to the amount of extension of the spring at any instant; the second pen, attached to the lever of an electro-magnet magnetised by a current controlled by a seconds pendulum, describes a V-shaped mark at each second; the third pen traces a datum line to which the ordinates are perpendicular. The area traced out is of course the product of the two variables, and is proportional to the total work transmitted. The recording drum may be made to revolve at any convenient ratio to the revolutions of the belt wheels. We are indebted to Mr. Smith for the loan of the figure which illustrates this notice.

### NOTES

WE are authorised to state that there is no truth in the rumour that Mr. Oscar Dickson intends to equip an Antarctic Expedition under the command of Baron Nordenskjöld.

THE Rev. Dr. Salmon, Regius Professor of Divinity in Trinity College, Dublin, has been selected by the Institute of France to fill its vacant foreign membership.

ACCORDING to the constant practice of the French Academy of Sciences, the seat occupied by M. Jamin in the Section of Physics is considered as vacant, and a new election will take place.

A MEETING was recently held in the Hall of the Institution of Civil Engineers, Great George Street, Westminster, to consider what steps should be taken to raise an Engineers' Memorial to the late Sir William Siemens. Sir Joseph Bazalgette, as President of the Institution, was asked to preside. The Chairman pointed out that a general desire had been expressed among engineers that some memorial should be raised as a recognition of the great merits and important services rendered to engineering by Sir William Siemens. It has been ascertained that it would be agreeable to the authorities of Westminster Abbey that a window should be placed in that building to the memory of the deceased. Possibly the cost of such a window might amount to

between 700*l.* and 800*l.* The meeting agreed "that it would be very desirable to commemorate the distinguished character and attainments of the late Sir William Siemens by erecting to his memory a window in Westminster Abbey." It was determined to limit the subscription in the first instance to one guinea. A committee was appointed to carry out the project.

THE ceremony of laying the foundation-stone of the building which is to be erected, under the name of Alexandra House, at the charge of Mr. Francis Cook, as a home for 100 of the female students attending classes at the Royal College of Music, the South Kensington Museum, and other art and science schools in the neighbourhood, was performed on Monday afternoon by the Princess of Wales in the presence of a large assemblage of gentlemen and ladies. Mr. Cook deserves all credit for his enlightened liberality, and we have no doubt the home which he has founded will be a valuable aid both to the South Kensington classes and the College of Music. At the same time we may remind our readers that a similar institution has been successfully at work for a considerable time in Byng Place for female students attending University College and other institutions for the higher education of women.

WE hope to be able in an early number to consider at length the report of the City Companies Commission. Meantime, among other suggestions of the Commission, we may note their recommendation to appoint by Act of Parliament a Commission to undertake (1) the application of a portion of the corporate incomes of the Companies respectively to objects of acknowledged public utility; (2) the better application of the trust incomes of the Companies; (3) should it prove practicable, the reorganisation of the Constitution of the Companies. The Commission moreover recommend that by the terms of such Act "objects of acknowledged public utility" be defined as scholastic and scientific objects, *i.e.* elementary education, secondary education, classical education, scientific research.

THE International Forestry Exhibition was opened on Tuesday afternoon at Edinburgh by the Marquess of Lothian, in the presence of a large company. Many foreign Governments were represented, and the Lord Provost and magistrates of Edinburgh attended in their official capacity. The Marquess of Lothian, in opening the Exhibition, said that a special object was the better forestry education of the country. The United Kingdom had more property in the world than any other nation; but in this particular it was behind other nations. We were the only country that had not a school of forestry, and we had to send our young men abroad to gain the necessary knowledge. That, surely, was not right, and he hoped that out of that Exhibition there would come a school for forestry which might possibly be located in Edinburgh. They had every possible advantage there; they had the Botanic Gardens, the Arboretum, the University, and the Highland Society. All these bodies took an interest in the matter, and it only required that opportunity should be given for the practical part of the work. It was not too much to hope that before long, if the money were got, they might see a school of forestry in Scotland. He appealed to the public to make the enterprise a success, and, amid hearty cheers, declared the Exhibition open.

THE Anniversary Meeting of the Sanitary Institute of Great Britain will be held in the Theatre of the Royal Institution, Albemarle Street, on Thursday, July 10, at 3 p.m. The chair will be taken by the Right Hon. Earl Fortescue, and an address will be delivered by H. C. Bartlett, Ph.D., F.C.S., entitled "Some of the Present Aspects of Practical Sanitation," and the Medals and Certificates awarded to the successful exhibitors at the Exhibition at Glasgow, in 1883, will be presented.

THE Society of Chemical Industry will hold its annual meeting at Newcastle-on-Tyne on July 9 and following days. The meeting at Newcastle is looked forward to with great interest by the members of the Society throughout the country, for Tyneside is associated more closely than any other district with the birth and development of the chief of our great chemical manufacturing industries, and the committee of the Newcastle section, under the chairmanship of Mr. J. C. Stevenson, M.P., are doing their utmost to render the visit of the members to Newcastle in every way a memorable one.

MR. SIDNEY LUPTON, Assistant Master at Harrow School, has recently compiled and published some numerical tables and constants in elementary science which we can fairly recommend to our readers. It is a little book of about 100 pages, which of course possesses no claim to originality, the whole skill of the compiler being shown in the selection of materials which he has made. The book deals with numbers and measures, heat, light, sound, electricity, chemistry, and physiography; the latter division being wide enough to include tables of logarithms.

WE have received from the Bureau des Longitudes their "Annuaire" for the present year, which seems thicker and more complete than any of its predecessors, well worth the money it costs (1*s.* 3*d.*) even to the English reader, on account of the very valuable tables which it contains touching astronomical and geographical subjects. We notice in the present edition a very complete table of the different comets, which alone would make it a necessity in any astronomical establishment. The semi-popular article published in the "Annuaire" for this year is entitled "Sur les Grands Fleaux de la Nature"; it is by M. Faye, and is well worth reading.

M. MONTIGNY has recently published a pamphlet on the influence of the atmosphere in the apparition of colours seen in the scintillation of stars. In it he draws attention to the possibility of there being some connection between these colours and the coming weather. He has previously noticed that there is a great predominance of blue in the scintillating colour when rain is approaching, and he is now so convinced of the accuracy of this forecast that it is included among others in the *Bulletin Météorologique* published by the Observatory of Brussels. He gives the following forecast for the coming years:—"We may hope that we are happily quit of the period of wet years which commenced in 1876, and that we have already entered a series of fine years, or rather of more regular years as far as rain is concerned." *Nous verrons ce que nous verrons.*

OUR botanical readers may be interested to know that Herr F. Soácha of the Bürgerschule, Deutschbrod, Bohemia, is preparing for publication a Flora of Austria-Hungary, which will contain specimens of the plants described. Those desiring to know the terms of subscription should communicate with Herr Soácha.

THE following are some of the special questions which have been arranged for discussion at the next Social Science Congress, which is to be held at Birmingham on September 17-24:—How far are the requirements of the country for well-trained teachers in elementary schools met by the pupil-teacher system and the existing training colleges? In testing the efficiency of schools should processes or "results" be chiefly regarded? Health—1. What is the best method of dealing with (a) town sewage, (b) the products of house and street scavenging, and (c) the products of combustion? 2. What are the best means, legislative or other, of securing those improvements in the dwellings of the poor which are essential to the welfare of the community? 3. How far may the average death-rate of a population be considered

an efficient test of its sanitary condition; and by what means can the high death-rate of children be reduced?

THE Pavlovsk Observatory has been, since 1882, in possession of two subterranean lines, each one kilometre long, and situated, one of them in the direction of the magnetic meridian, and the other perpendicular to it; and Dr. Wild communicates to the St. Petersburg Academy of Sciences (*Bulletin*, vol. xxix. No. 2) the following interesting results of his observations on terrestrial currents (the method of observation has already been described in the *Memoirs* of the Academy, vol. xxxi.):—The terrestrial current altogether does not manifest itself as a current which would flow for a time in one direction and then would slowly change it, but in the shape of more or less strong alternate currents, which rapidly change their direction. The east and west force is generally stronger than that of north and south. The observations on the regulation days do not show any diurnal periodicity, neither in the force of the current nor in the number of oscillations; but the average of the twenty-four regulation days of the year (September 1882 to September 1883) disclose such a periodicity, however feeble, namely, a maximum between 4 and 5 a.m. and a minimum at 8 p.m. for the meridional line, as also a maximum at 8 a.m. and a minimum at 1 p.m. for the other line. As soon as the force of the terrestrial current is on the increase, the magnetical instruments display perturbations which usually increase with the force of the terrestrial currents, without being, however, proportionate to them. If, according to Sir G. B. Airy, the north and south current be compared with the variations of declination, and the other current with horizontal intensity, both perturbations are often very equal, but those of the currents precede those of the terrestrial magnetism by at least five minutes. This retardation may explain the want of proportion between the variations of the current and those of the terrestrial magnetism, which proportion is the more wanting as the variations of the current are frequent and alternate. From these alternations Dr. Wild concludes that “terrestrial currents are always the primary cause of magnetic perturbations, but not of periodical variations of the magnetic elements.”

SOME forty years ago Dr. Joule raised the question whether a body that is magnetised undergoes any change in its temperature; but the question has not yet received a definite solution, the rise of temperature which accompanies magnetisation being ascribed by some to induction currents, and not directly to magnetism. While recognising the influence of the former, Mr. Borgman has tried to show that there is also a change of temperature due to magnetisation and demagnetisation, and that the amount of heat thus disengaged is proportionate to the squares of the temporary magnetism. M. Bachmetieff, having made, at the University of Zurich, an extensive series of experiments, the first part of which is now published in the *Journal of the Russian Chemical Society* (vol. xvi. fasc. 3), arrives at the conclusion that magnetism, *by itself*, produces variations of temperature in magnetised bodies, and that this “magnetic heat” is equal to the product of the magnetic moment by the magnetising force multiplied by a constant; it increases also, within a certain limit, with the frequency of the interruptions of the magnetising current, and increases still more when the direction of the current is alternately changed. Its amount is not equal throughout the length of an iron cylinder, reaching its maximum about its middle and decreasing towards its ends. Its cause must be searched for in purely mechanical forces, and it depends upon the speed of rotation of the molecular magnets.

ABOUT the middle of June the inhabitants of Moscow were puzzled to see immense masses of insects, taken at first for locusts, flying east in thick clouds over the city. It appears now that the insects were dragon-flies (*Libellula quadrimaculata*

and *L. rufa*) belonging to the rapacious species which live on other insects.

COUNT UVAROFF continues his archæological explorations in the Government of Smolensk, and recently he has found very interesting remains of rude pots containing ashes and bones which are supposed to be burial remains of the Krivitchi, who had the custom, according to the Nestorian annals, of thus burying their dead.

DR. CHAVANNE, who is travelling on the Congo for the Brussels National Institute of Geography, has established a meteorological observatory at Bona. Mr. Stanley has transferred the site of his station of Vivi to a table-land some 1500 metres to the north; and a railway from the new station to the Congo is in course of construction. A new station, called Sette-Cana, has also been established at the mouth of the small River Sette. Numerous small wooden houses are being made in Belgium to be transported to the new Vivi. A sanatorium has been constructed at Boma.

A TELEGRAM from Krasnovodsk gives the true history of the Uzboi, the ancient bed of the Amu Daria. For 250 versts, from Sarykamish to Bola Ishem, there is no stream, this locality presenting a series of desiccated marshes and lakes. At Akkal there is no channel. This part of the Uzboi, which evidently formed an estuary of the Caspian and partially fed the Sarykamish lake, has been silted up from the sea. The project for uniting the Amu Daria with the Caspian requires several hundred versts of canals.

M. JAUBERT has organised in the Great Tower of the Trocadero Palace a repetition of the experiments tried by Pascal in the Tour Saint Jacques, on the diminution of barometric pressure with increase of altitude. He is also arranging a Foucault pendulum which will oscillate in the same condition as in the Pantheon, with a contrivance for making its vibration perpetual.

THE additions to the Zoological Society's Gardens during the past week include an Indian Wild Dog (*Canis primævus*) from India, presented by Mr. T. A. Bulkeley; a Brush-tailed Kangaroo (*Petrogale penicillata* ♂) from New South Wales, presented by Mr. J. Abrahams; a White-collared Manganey (*Cercocebus collaris* ♂) from West Africa, presented by Mrs. Du Heaume; a Black-eared Marmoset (*Haple penicillata* ♀) from South-East Brazil, presented by Mrs. C. Spencer Stanhope; a Guianan Tree Porcupine (*Sphingurus insidiosus*), a Rough Fox (*Canis rufus*) from British Guiana, presented by Mr. G. H. Hawtayne, C.M.Z.S.; a Laughing Kingfisher (*Dacelo giganteus*) from Australia, presented by Mrs. W. Moir; two Chaplain Crows (*Corvus capellanus*) from Persia, presented by Mr. B. T. Finch; a European Pond Tortoise (*Emys europæa*), two Spotted Salamanders (*Salamandra maculosa*), European, presented by Mr. J. Satcherd; two Algerian Tropidosauruses (*Tropidosaurus algeria*), three Rapid Spine-foot Lizards (*Acanthodactylus vulgaris*) from North Africa, presented by Mr. W. C. Tait, C.M.Z.S.; an Adorned Ceratophrys (*Ceratophrys ornata*) from South America, presented by Capt. Hairby; an Orange-winged Amazon (*Chrysolis amazonica*) from South America, a St. Thomas's Conure (*Conurus xantholanus*) from St. Thomas, W.I., a Yellow Conure (*Conurus solstitialis*) from Guiana, two Passerine Parrots (*Psittacula passerina*) from British Guiana, deposited; a Bengal Vulture (*Cyps bengalensis*) from India, two Coscoroba Swans (*Cygnus co coroba*) from Chili, three Turquoise Parrakeets (*Euphema pulchella*) from New South Wales, purchased; two Black Guillemots (*Uria grylle*) from Ireland, received in exchange; a Hog Deer (*Cervus porcinus* ♀), four Himalayan Monauls (*Lophophorus impeyanus*), five Chilian Pintails (*Agallia spinicanda*), five Summer Ducks (*Ex sponsa*), bred in the Gardens.



## THE COMPOSITION OF CHLOROPHYLL

AMONG recent papers on chlorophyll those of Hansen, assistant to Prof. Sachs, are worthy of notice.<sup>1</sup>

Dr. Hansen has applied the saponification method, found so useful by Prof. Kühne<sup>2</sup> in his researches on the chromophanes, to the study of chlorophyll, and has been led to some very important conclusions. It may be remembered that Fremy tried to show that the green chlorophyll colouring matter consists of a blue and a yellow constituent. He mixed an ethereal chlorophyll solution with hydrochloric acid, when two layers formed—a lower blue layer and an upper yellow ethereal layer. The blue colouring matter was named by Fremy *phyllocyanin* and the yellow *phylloxanthin*.

Hansen shows that this is not due to a splitting up of the chlorophyll green into a blue and a yellow component, but only an incomplete separation of the chlorophyll green from the chlorophyll yellow, the former becoming changed to blue by the hydrochloric acid, and he further shows that an ethereal solution of pure chlorophyll green treated with hydrochloric acid does not furnish any yellow constituent, the ethereal layer remaining colourless. Fremy himself, however, abandoned the view that chlorophyll consists of two colouring matters.

The views of Kraus are so well known that it is hardly necessary to recapitulate them here, but I may be permitted to recall to mind that he supposed he had decomposed chlorophyll green into a blue green and a yellow component. He mixed an ordinary alcohol chlorophyll solution with benzol, and obtained two layers, an underlying yellow alcoholic layer and an upper blue-green layer. The blue-green Kraus named *cyanophyll*, the yellow *xanthophyll*.<sup>3</sup> Hansen shows, however, that Kraus is wrong in supposing that a decomposition of the green colouring matter into a blue-green and a yellow has taken place, as it is only an incomplete separation of the chlorophyll green from the chlorophyll yellow. Kraus's *cyanophyll* therefore is nothing more than an ordinary chlorophyll solution out of which a part of the yellow colouring matter has been removed. Both Fremy and Kraus were correct in assuming that a yellow and a green constituent were present, but incorrect in supposing they existed in combination; the correct view now is that they exist side by side. In other words, chlorophyll is merely a mixture of these colouring matters.<sup>4</sup> [I think it necessary here to give Conrad's view, viz. that Kraus had effected a decomposition of the chlorophyll by the use of water, as Kraus used weak alcohol. Conrad showed that by using strong alcohol no yellow pigment could be got into solution by means of benzol. Cf. Sachs' "Botany," 2nd English ed. p. 760.] In the preparation of pure chlorophyll Hansen used young plants of wheat at the time of their growth when the fourth leaf is formed. Then the plant contains only protoplasm, chlorophyll, and cellulose. The spectra of the solutions were observed as in the experiments of Kühne,<sup>5</sup> on the pigments of vertebrate eyes, and of Krukenberg<sup>6</sup> on those of various animals, by means of sunlight thrown into the slit by a heliostat, a large chemical spectroscope having been used.

The leaves of the plants are first boiled to remove extractives, the water poured off, and the material washed with water until the wash water is quite clear. It is then quickly dried at a low temperature, and afterwards extracted with alcohol. Hansen states that the boiling does not alter the chlorophyll, since the plant residue, after boiling, gives the same bands as the living leaf. For the alcoholic extraction 96 per cent. alcohol was used, and it was carried on in a dark room to avoid decomposition of the chlorophyll by light. A second extraction was also carried out, and the alcohol left in contact with the residue until the former assumed a dark green colour.

The united alcoholic solutions were then concentrated and saponified. Hansen had previously found that he could separate out, in the case of the colouring matter of blossoms, by means of saponification, the yellow colouring matters from the fats in combination with them, as Kühne had previously done in the case of the chromophanes and other pigments, and not only did he get the pigments fat-free, but also in a crystalline state.

<sup>1</sup> "Der Chlorophyllfarbstoff," von Dr. Adolph Hansen, *Arbeiten des botan. Instituts zu Würzburg*, Bd. iii. Heft 1; and *Sitzungsberichte der physikal.-medicin. Gesellschaft*, Würzburg, 1882. Also, *Die Farbstoffe der Blüthen und Früchte: Verhandlungen der physikalisch-medicinischen Gesellschaft zu Würzburg*, N.F. Band xviii. No. 7, 1884.

<sup>2</sup> Kühne, *Untersuch. u. d. physiologischen Institute der Univ. Heidelberg*, Band i. Heft 4, 1878, and Band iv. Heft 3, 1882.

<sup>3</sup> Zur Kenntniss der Chlorophyllfarbstoffe, &c., Stuttgart, 1872.

<sup>4</sup> *Ibid.*

<sup>5</sup> *Ibid.*

<sup>6</sup> Krukenberg, "Vergleichend physiol. Studien," 1880-82.

The saponifying was carried out as follows:—The leaf-extract (alcoholic), after concentration, was treated with caustic soda solution in not too great amount, but the amount to be added has to be determined by the quantity of chlorophyll present. As a general rule Hansen used 40-50 c.c. (of a 1NaHO to 5H<sub>2</sub>O solution) to 2½ c.c. chlorophyll solution obtained by concentration of 16-20 c.c. alcohol extract. When the alcoholic solution boils, the caustic soda is added drop by drop, the liquid being stirred. After the alcohol is driven off, water is poured in, and the heating continued. After the evaporation of a great part of the water, alcohol is added once more, and the saponification is ended. When the alcohol has evaporated, the soap lees is diluted with water and an excess of chloride of sodium added to separate the soap, which precipitates in a granular form. It is then shaken in a separating funnel with petroleum ether, which assumes a dark yellow colour, since it removes only the yellow constituent; this extraction is repeated as long as the petroleum ether is coloured. On evaporation of the latter, the yellow constituent is left.<sup>1</sup>

The soap is now treated with ether, which removes various impurities, and a little colouring matter, and then with ether containing alcohol, which removes the green constituent from the soap.

Hansen asserts, and gives his reasons for the assertion, that no change takes place in the pigments by the above treatment.

The yellow constituent crystallises in dark yellow needles out of the petroleum ether, and gives all the reactions of a lipochrome, both as regards spectrum and chemical characters.

The green constituent can be obtained out of the ether-alcohol solution after occasional filtering and evaporation of the ether, and any yellow colouring matter adhering to it can be removed with petroleum ether. For the usual reactions this pigment answers very well, but for further study it has to be purified from water, &c., which is done by further treatment with ether-alcohol solution. Finally the pigment crystallises out in spherical crystals, which show a beautifully-marked cross with crossed Nicols. Even a drop of the solution allowed to evaporate on a microscopic slide allows the crystals to be seen, thousands of small "sphaerocrystals" appearing on the evaporation of the ether. Hansen shows that the idea that plants contain but a small quantity of chlorophyll is erroneous, as he has obtained out of 450 grams dried wheat leaves as much as three to four grams solid colouring matter.

Chlorophyll green is opaque in the solid state, and appears of a black-green colour, and in that state possesses no fluorescence, but in solution possesses the usual red fluorescence. Its various chemical characters are given at length in the original paper, and it is shown that some of the changes with acids described by authors are not due to their action on pure chlorophyll green, but on other unknown bodies. It is free from sulphur and from iron. The elementary analyses agree very closely, and calculated for the ash-free substance are the following:—

I.		II.	
C.	67.26 per cent.	...	67.94 per cent.
H.	10.63 "	...	10.36 "
O.	16.97 "	...	16.12 "
N.	5.12 "	...	5.55 "
99.98		99.97	

The amount of carbon is 1 per cent. too low in both cases.

Chlorophyll yellow occurs in small quantity as compared with chlorophyll green, in the proportion of about 1 to 100. Its solutions show no fluorescence, and statements to the contrary have been based upon deductions drawn from imperfect methods of separation. It possesses the reactions of Krukenberg's lipochromes,<sup>2</sup> in the solid state, namely: a blue coloration with sulphuric acid, the same with nitric acid, and a green-blue with a mixture of iodine in potassium iodide. It shows three bands in the blue half of the spectrum, but no absorption of red, and agrees in spectrum with the yellow colouring matter of etiolated leaves (*etiolin*), which is incorrectly represented by some as possessing bands in the red part of the spectrum. Chlorophyll green possesses four bands in the red half of the spectrum; they agree with the four bands of the ordinary chlorophyll solutions.

With regard to Tschirsch's "pure chlorophyll," which, it may be remembered, was described in the *Journal of the Chemical Society*, February 1884, with the remark that the writer "reserved to"

<sup>1</sup> Compare Kühne, *loc. cit.*, Band iv. Heft 3, 1882.

<sup>2</sup> Krukenberg, *loc. cit.*, "Zur Kenntniss der Verbreitung der Lipochrome im Thierreiche," Zweite Reihe, 3te Abth. 1882.

himself "the right of examining it further," Hansen observes that "it possesses all the reactions of the usual chlorophyll sauce."<sup>1</sup>

In a second paper<sup>2</sup> Hansen figures the spectra of chlorophyll green and chlorophyll yellow. His researches will, no doubt, be found useful by students of vegetable chromatology.

C. A. MACMUNN

## RECENT MORPHOLOGICAL SPECULATIONS<sup>3</sup>

### II.—The Origin of Vertebrates

FIFTEEN or sixteen years ago Kowalevsky's researches on the development of Amphioxus and of Ascidians seemed to be solving the question of the origin of Vertebrates. The discovery of the larval notochord in Ascidians, and the recognition of the homology of their pharyngeal clefts with the gill-slits of Vertebrates, made it necessary to acknowledge the close relationship of the two, as had been already foreshadowed by Herbert Spencer; while the yet undisputed affinity of Ascidians to Mollusks brought Vertebrates and Invertebrates together in an unbroken line. But as new knowledge brought Ascidians closer to Vertebrates, it undermined their claims to molluscan affinities; and as the doctrine of degeneration grew up, in the hands of Dohrn and Lankester, it taught that Ascidians, and Amphioxus too for that matter, were not really *ancestors* of the higher Vertebrata, but only degenerate descendants of such ancestors, poor cousins, as it were, of the higher Vertebrates. The lines by which Vertebrates had sprung from Invertebrates, the common ancestor of Ascidians, Amphioxus, and the higher Vertebrates, had still to be sought for.

Two leading theories have been formulated, and are still under discussion. The first, identified with the names of Semper and Dohrn, maintains that the nearest allies of the Vertebrates must be looked for among the Chætopod worms, the dorsal surface and spinal cord of the former corresponding morphologically with the ventral surface of the latter, and its gangliated nerve-cord. On the second view, with which we may associate the names of Balfour and Hubrecht, we must take the ancestor of the Vertebrates to have been some segmented worm, descended from the same unsegmented types as the Chætopods, but in which the two nerve-cords, at first lateral like those of Nemertines, had coalesced dorsally instead of ventrally, to form a median nervous system.

Our discussion of the first of these theories may be made clearer if we use the words "neural" and "hæmal" instead of "dorsal" and "ventral," for the gist of the theory is that in the two groups *neural* and *hæmal* surfaces remain constant, but what is dorsal in the one is ventral in the other.

In the Chætopods, say the advocates of this theory, we have a group of regularly segmented animals, not so far specialised but that we might well conceive ancestors like them to have developed into Vertebrates; they point to the relations of the nervous, vascular, and alimentary systems, and to the development of the mesoblast, as being closely parallel in the two groups; and they try to find traces or representatives in Chætopods of such typically Vertebrate possessions as notochord, gill-clefts, and swimming-bladder.

At the very outset a difficulty arises which is perhaps the greatest the theory encounters. The mouth of Chætopods is neurally placed, and surrounded by a nerve-ring; in Vertebrates it is hæmal, and it does not pierce any part of the nervous axis. Dohrn has attempted to overcome this objection. The present mouth of Vertebrates, he says, is not identical with the Invertebrate mouth; it is a distinct and secondary structure; it arises late in development, whereas in other classes the "stomodæum" or primitive oral invagination appears very early. Moreover, in the majority of Vertebrates the mouth does not persist in the position it first appears in; it arises some way off from the anterior end of the body, and in Elasmobranchs, some Ganoids, and Myxinoids it remains there, but in all other Vertebrates it becomes terminal. If we assume, then, that the mouth in existing Vertebrates is secondary, there must have been a time when it did not exist, and when its functions were performed by another or primary mouth. It has been suggested that in the *hypophysis cerebri* or "pituitary body" we have, possibly, a remnant of this primary mouth. The *hypophysis cerebri* appears first as an ectodermic involution, usually arising from the stomodæum; but

in the lamprey, Götte, Scott, and Dohrn have shown that it arises from the ectoderm which lies anterior to the mouth. It is here, in fact, a little pit of ectoderm, placed between those other two ectodermic pits, which are to become the nose and the mouth.

If this involution ever pierced the brain and opened upon the neural surface, the fore-brain would then be evidently homologous with the supra-oesophageal ganglion of Invertebrates, or ganglion of the præ-oral lobe. A great deal may be said for this regarding the fore-brain as distinct from the remaining nervous system; it resembles the supra-oesophageal ganglion of the Invertebrata in its close connection with the optic and olfactory organs, and in supplying only organs of sense. There is evidence to show that the third nerve belongs to the cranio-spinal series of segmental nerves, and that the olfactory and optic nerves have a different nature. If this be so, the mid-brain, giving origin to the third nerve, would appear not to have part in the ganglion of the præ-oral lobe. The termination of the notochord directly behind the fore-brain is an additional argument in favour of the morphological distinctness of the latter structure.

Thus if we follow back the genealogical record of the Vertebrates, we find that at one period their ancestors had a mouth upon the neural surface; later, two openings into the alimentary canal appear, one on the neural and one on the hæmal surface; still later the latter gains the ascendancy, and alone remains to the present time. This secondary mouth must have arisen from some pre-existing structure; it could not have originated as a simple depression of the outer skin which deepened and ultimately fused with the alimentary canal; and the only pre-existing organs which could furnish such a passage from the exterior into the alimentary tract are the gill-slits. We must conceive this Vertebrate ancestor as an animal with an intestine which opened anteriorly by a median mouth on its neural surface, and laterally by a series of segmentally situated gill-slits. The mouth took in water, which flowed out over the gill-arches just as it does still in the lower Vertebrates. If from any reason, such as the animal lying like the modern Annelids on its neural surface, it obtained a purer supply of water by taking it in through some of the gill-slits, it is conceivable that a pair of these slits assumed that office, and that by the exercise of this power the gill-slits became gradually larger, and ultimately fused in the middle line. The suctorial power thus acquired to take in water for the purposes of respiration was also of use in obtaining food, and thus a median hæmal suctorial mouth arose, such as the Myxinoids now possess. There is much evidence to show that the ancestral Vertebrate possessed a suctorial mouth which subsequently became modified for biting, and was carried forward to the front of the head. Embryology supplies the following arguments in favour of regarding the mouth as formed from the coalescence of a pair of gill-slits. It lies close against the gill-slits, it is separated from them by a gill-arch, it arises about the same time in the embryo, it opens into the alimentary canal; finally, in some Teleosteans, *Belone*, *Hippocampus*, and *Gobius*, the mouth first appears as two lateral openings, which afterwards fuse in the middle line.

Admitting that the mouth is formed of two gill-slits, we have to see from what structures in an Annelid such gill-slits could be derived. In many Chætopods no part of the body is set apart to perform the function of respiration. Where there are no gills the blood is commonly aerated in the walls of the alimentary canal, water being taken in at either end, and when charged with the waste products of respiration, it is expelled through the same opening. In some cases, as in *Hesion*, the surface with which the water comes in contact is increased by a pair of lateral sacs or diverticula. It is obvious that with such a respiratory apparatus it would be advantageous if there was an exit for the respired water distinct from its entrance, so that the blood should always be in contact with pure water. Such an exit would be formed by fusion of the respiratory diverticula with the body-wall and subsequent rupture of the latter at the points of fusion. And the apertures in the tentacles of Actinias and the perforated liver-diverticula of Eolis are adduced as analogous instances of such perforation.

Another suggestion which has been made to account for the origin of gill-slits is that the inner ends of some of the segmental organs gained an entrance into the alimentary tract, and, changing their function, gave rise to gill-slits.

By these steps a Vertebrate has been reduced to an Annelid structure, but certain questions which have arisen in the development of this theory remain to be answered. One is whether the

<sup>1</sup> Tschirsch only obtained his chlorophyll in the form of "blackish-green drops."

<sup>2</sup> *Loc. cit.*

<sup>3</sup> Continued from p. 69.

mouth is formed from the most anterior pair of gill-slits. If the trabeculae cranii are gill-arches, the mouth is not the first. Some authorities consider the nasal sacs as modified gill-slits; they are primitively double, and where we find them single, as in Amphioxus and Cyclostomes, it is due to secondary processes.

In his "Monograph on the Development of the Elasmobranch Fishes," Balfour has pointed out that the histological structure of the spinal cord in Vertebrates is exactly what would be found if, by mechanical folding, the two lateral halves of the nerve-cord of an Annelid became bent toward one another, whilst the external skin was pushed into the groove between them. If this folding were completed, so that the external epithelium formed a canal surrounded by nervous tissues, the white and gray matter would assume the same relative position that they possess in the spinal cord of Vertebrates. The nerves would then arise not laterally, but from the extreme ventral summit, and would thus correspond with the posterior roots of the Vertebrate spinal cord, which, as Balfour has shown, grow out from the extreme dorsal summit of the neural canal, a position comparable with the ventral summit of the Annelid nervous system. In Amphibia the primitive medullary plate (or modified area of dorsal epiblast which is to fold in and form the medullary groove), although elsewhere single, shows signs of being formed of two symmetrical halves, and in both embryo and adult the neural tube has a structure which points to its origin from the coalescence of two lateral cords.

The direction of the blood current, which flows from behind forwards on the hæmal, and from before backwards on the neural, surface, agrees in Chætopods and Vertebrates if the surfaces be reversed, and the hypothesis of reversal presents no great difficulties in the case of a cylindrical animal swimming in the sea.

In connection with this theory it is interesting to note that Eisig has instituted a comparison between the lateral sense-organs in the Capitellidæ (a family of Chætopods) and the lateral line of fishes, and he further compares the "siphon" of the same Chætopods with that obscure rod of tissue split off from the alimentary tract of fishes and Amphibia, the sub-notochordal rod.

The notochord is one of the most characteristic Vertebrate structures, and if the theory propounded above be true, we should expect to find very distinct rudiments of such a structure amongst the Chætopods, but although numerous organs have been interpreted as such, Balfour states that none of these interpretations will bear examination. Quite recently Nussbaum has found in the cockroach a longitudinal string of cells lying upon the nerve-chain, which in its development bears a striking resemblance to the notochord of Vertebrates, and Vejdovsky has described a similar structure in Oligochaeta, developed, however, from the mesoderm, under the name of neurochord.

The supporters of the second theory, which we have connected with the names of Balfour and Hubrecht, claim that they have found an organ in one class of the Invertebrata which is comparable to the notochord of Vertebrata.

Balfour in the "Elasmobranch Fishes," whilst combating the Chætopod origin of Vertebrates, suggested that Vertebrates have descended from the same unsegmented stock as the Chætopods, but through some other line which has entirely disappeared. They have thus acquired similar segmental and other organs. In this line of ancestors he imagines that the primitive lateral nerve cords have tended to coalesce dorsally instead of ventrally. In his "Comparative Embryology" he repeats these views, and adds that their probability has been increased by the researches of Hubrecht, who has shown that in some Nemertines the nerve-cords approach each other very closely in the median dorsal line. Hubrecht has quite recently amplified these views by suggesting that "the proboscis of Nemertines, which arises as an invaginable structure, and which passes through a part of the cerebral ganglion, is homologous with that rudimentary organ which is found in the whole series of Vertebrates without exception—the hypophysis cerebri. The proboscidian sheath of the Nemertines is comparable in situation (and development?) with the notochord of Vertebrates."

The first of these two positions is supported by the facts of development. Although the details of the ontogenetic origin of the Nemertine proboscis are still wanting, the broad fact that it arises, like the hypophysis cerebri, as an invagination of the epiblast, has been established.

These organs further resemble each other in the shifting of their external opening, which is in some cases on the outer surface, in others on the dorsal wall of the alimentary canal just within the mouth.

In this comparison between the proboscis of Nemertines and the hypophysis cerebri, the connection of the latter with the brain and its relation to the anterior end of the notochord, must be especially borne in mind. The proboscis passes backward, between the anterior thickenings which form the brain, the two lateral halves of which are connected by a thick nerve commissure ventral to the proboscis, and by a thin strand dorsal to it. Thus the proboscis pierces a ring of nervous tissue, and the proboscis sheath reaches forward to the level of this nervous commissure. This region, then, would correspond to that part of the vertebrate brain to which the hypophysis cerebri is attached and close behind which the notochord terminates, and would thus separate off the fore-brain from the remaining nervous system. In connection with this it is a very significant fact that the superior lobes of the Nemertine brain give rise to the nerves which supply the sense organs, while the strong nerve which supplies the anterior region of the œsophagus originates in the inferior lobes. The one pair of these lobes may thus have been perpetuated as the fore-brain, and the other as the rest of the nervous system.

The sheath of the proboscis corresponds very accurately in its position to the notochord, but unfortunately the knowledge we possess of its development is not great. Barrois and Salensky have attributed a mesoblastic origin to it, the latter, however, noting a connection between the first origin of the œsophagus and proboscis. Hoffman has stated that part of the proboscis is split off the dorsal surface of the alimentary canal, whilst the muscular proboscis sheath is mesoblastic in origin. Hubrecht suggests that possibly the formation of the inner part of the proboscis sheath has been mistaken for the proboscis. If this suggestion prove true, then the proboscis sheath agrees both in position and origin with the notochord of Vertebrates.

The fully-developed notochord is a solid rod, whereas the proboscis sheath is a hollow tube. This, however, is no very serious objection to their homology; and recently Lieberkühn and Braun have shown that the notochord arises at first as a hollow tubiform structure, whilst in old specimens of *Cerebratulus* (a Nemertine) the posterior end of the proboscis sheath is nearly or quite filled up with continuous cellular tissue.

We have unfortunately too little knowledge at present to institute a comparison between the other organs of Nemertines and Vertebrates. Attention should, however, be called to the ciliated lateral pits upon the head. These arise from the most anterior part of the œsophagus in front of the mouth. They bud out from the walls of the œsophagus, and are in this stage directly comparable to similar diverticula which arise in the same region in the larva of *Balanoglossus*, and which there give rise to the first pair of branchial slits. These diverticula become finally cut off from the œsophagus, but enter into connection with epiblastic invaginations, and are thus placed in communication with the sea-water. In Schizonemertines their inner end is in connection with the brain; the latter contains hæmoglobin, and so they subserve respiration. In Hoplonemertines, however, although their development is similar, they apparently are modified for a sensory, possibly an olfactory, function. In connection with these structures, Hubrecht calls attention to some of the results of Hatschek's recent researches on the development of Amphioxus. In this animal there are two lateral hypoblastic diverticula growing out from the anterior part of the œsophagus in front of the mouth. These differ both in their nature and development from the archenteric diverticula, or from the branchial outgrowths. They are at first symmetrical, but have a different fate. They are both constricted off from the hypoblast: the left one communicates with the exterior by a ciliated opening which appears in the epiblast; the right one forms an epithelial lining to the præoral body region. The left one has been looked upon as a special sense organ of the larva.

Finally it is impossible to overlook the bearing of *Balanoglossus* on our subject, although we are not yet in possession of all the facts that Mr. Bateson's (*Q. J. M. S.* No. xciv. April 1884) recent researches seem to have elicited. The pharyngeal slits of *Balanoglossus* have long been recognised as wonderfully like the gill-slits of Vertebrates, and on the other hand as totally unlike any structures possessed by animals outside the Chordata. But Bateson's researches have already shown that the developmental features of the nervous system and of the mesoblast are not less suggestive of the same kinship. For the mesoblast is developed from an anterior archenteric pouch with two posterior horns (exactly comparable with that described in the last paragraph as existing in Amphioxus) and two pairs of posterior pouches instead of the large number that Amphioxus possesses. And the fate

of the anterior pouch is almost identical in the two forms, for in *Balanoglossus* its left-hand division becomes lined by cilia and opens to the exterior, whereas its right-hand half degenerates into connective tissue. And as regards the nervous system (which in *Balanoglossus* contains no mesenteric canal as that of *Amphioxus* does) "it is only necessary to imagine the invagination of the dorsal nerve-cord to have been extended along the back (instead of being confined to the region of the collar) in order to reproduce the condition which is found in *Amphioxus*." But however much we may be struck by these relations of *Balanoglossus*, its own isolated position and the extreme difficulty of allaying it to any other Invertebrate groups prevent it from throwing much light upon the Vertebrate pedigree. The claims of the two theories discussed above may be unaffected, however close the correspondence between *Amphioxus* and *Balanoglossus* may be shown to be; and as yet *Balanoglossus* seems to do little more than remind us of how remote a relative of the Vertebrates *Amphioxus* itself is. *Amphioxus* occupies such an outlying branch, so far from the main stem of the genealogical tree of Vertebrates, that the demonstration of its likeness to an isolated Invertebrate like *Balanoglossus* may, like its obvious relationship with the Tunicates, be of little use to us.

It is perhaps premature to judge between these two theories detailed above, or to accept either of them definitely as an indication of the origin of Vertebrates. But we must point out that the Chatopod theory lies under the great disadvantage of assuming as far distant ancestor of Vertebrates a class of animals that seem rarely to occupy an apical position in a certain line of development. The Chatopods seem to be so highly specialised, that we must be suspicious of taking them to be the origin of another great group, but rather consider them as the ultimate result of evolution in a particular direction. In general it must always, *a priori*, be unsafe to attempt to make the apex of one group the base of the next; and in all cases it must be better, and more consonant with the principles of evolution, to search for the closest relations of one group among the simpler and less specialised members of another. A. E. S.

#### THE ROYAL SOCIETY OF CANADA

THE annual meeting of this Society was held at Ottawa, May 21-24, under the presidency of the Hon. P. J. O. Chauveau, LL.D., D.-ès-L.

The following papers were read in Section III. (Mathematical, Physical, and Chemical Sciences):—Electrical induction in underground and aerial metallic conductors, by F. N. Gisborne, C.E. The author proposed, in order to get rid of induction phenomena in telephone circuits, to connect sending and receiving telephones by means of pairs of twisted and insulated wires. He described experiments made with a section of cable about 3000 feet in length and laid underground between two of the Departmental Buildings at Ottawa. The cable contained twenty indifferently insulated wires, which were divided into pairs, two wires being twisted together in each case, each pair constituting a metallic circuit, and one wire of each pair being used as a "return" instead of the earth plates usually employed. The experiments showed that if one of these pairs was used as a telephonic circuit, no induction effects could be observed in the others. The absence of induction effect he attributed to the equidistance of the two wires of a pair from any third wire and the equality and opposition of the currents flowing in them.—A particular case of the hydraulic ram or water hammer, by C. Baillargé, C.E.—On the form of the contracted liquid vein affecting the present theory of the science of hydraulics, by R. Steckel. Communicated by C. Baillargé, C.E.—The origin of crystalline rocks, by T. Sterry Hunt, LL.D., F.R.S. The author began by remarking that the problem of the origin of those rocks, both stratified and unstratified, which are made up chiefly of crystalline silicates, is essentially a chemical one. He then proceeded to review the history of the once famous dispute between the vulcanist and the neptunist schools in geology as to whether granite and other crystalline rocks were formed by igneous or by aqueous agencies, and showed from recent writers that the controversy is not yet settled. He noticed of the igneous school both the plutonic and the volcanic hypotheses of the origin of these rocks, and then considered the so-called metamorphic and metasomatic hypotheses, which would derive them by supposed chemical changes from materials either of igneous or of aqueous origin. The hypothesis of Werner was next discussed. This conceives all such rocks to have been successively deposited

in a crystalline form from a chaotic watery liquid, which surrounded the primitive earth, and at an early time held in solution the whole of the materials of these rocks. The inadequacy of all of these hypotheses was pointed out, though it would appear that Werner's was the one nearest the truth. The author conceives that the crystalline rocks were formed by deposition from waters which successively dissolved and brought from subterranean sources the mineral elements. Their formation is illustrated by that of granitic veins, and that of zeolites—processes regarded as survivals of that which produced the earlier rocks. The true zeolites are but hydrated feldspars, while the minerals of the pectolitic group correspond to the protoxyd-silicates of the ancient rocks. The source of the elements in these rocks, according to the new hypothesis here proposed, was in the superficial layer which was the last-congealed portion of an igneous globe consolidating from the centre. In this primitive stratum, porous from contraction and impregnated with water, resting upon a heated anhydrous nucleus, and cooled by radiation, an aqueous circulation would be set up, giving rise to mineral springs. The waters of these dissolved and brought to the surface, there to be deposited, the quartz, the feldspars, and other mineral silicates, which, through successive ages, built up the great groups of crystalline stratified rocks, often so markedly concretionary in aspect. Exposed portions of the primitive silicated material would be subject to atmospheric decay and disintegration, giving rise to sediments of superficial origin, which would become intercalated with the deposits from subterranean sources. The reactions between the mineral solutions from below and the superficial materials were important in this connection, probably giving rise to certain common micaceous minerals; while dissolved silicates allied to pectolite, by their reaction with the magnesian salts, which then passed into the ocean waters, generated species like serpentine and pyroxene. This process of continued upward lixiviation of the primitive chaotic stratum would result in the production of a great overlying body of stratified acidic rocks, leaving below a basic residual and much diminished portion, the natural contraction of which would cause corrugations of the superincumbent stratified mass, such as are everywhere seen in these ancient rocks. The source of volcanic rocks is partly in this lower and more or less exhausted stratum of comparatively insoluble and basic ferrous silicates, whence come melaphyres and basalts; partly in the secondary or acidic mass, which, softened by the combined agency of water and heat, may give rise to granitic and trachytic rocks; and partly also, it is conceived, in later aqueous deposits of superficial origin, which also may be brought within the influence of the central heat. This attempt to explain the genesis of crystalline rocks by the continued solvent action of subterranean waters on a primitive stratum of igneous origin the author designates the crentic hypothesis, from the Greek *κρητιν*, *foam*. A preliminary statement of it was made by him to the National Academy of Sciences at Washington, April 15, 1884, and appears in the *American Naturalist* for June.—On the density and thermal expansion of aqueous solutions of copper sulphate, by Prof. J. G. MacGregor, D.Sc. The author gave the results of extended observations of the density of solutions of different concentration and at different temperatures. They show that the rate of variation of density with temperature increases with the temperature and with the percentage of salt in solution; that the density of any solution at low temperatures (below 20° C.) diminishes, as the temperature increases at a greater rate than that of water; that the ratio of the density of a solution to the density of water at the same temperature diminishes as the temperature increases; and certainly for many solutions, probably for all, attains a constant value within the temperature limits of the experiments (below 35°-50°); that, therefore, at about 40° C. the thermal expansion of solutions is the same as that of water at the same temperature. The experiments also substantiated a result formerly reached by Prof. Ewing and the author that very weak solutions of this salt have a smaller volume than the water used in making them. If then these solutions are made by the addition of anhydrous salt to water contraction must occur. The experiments show that the greatest contraction occurs in the case of a solution containing 1.34 per cent. of anhydrous salt, in which case the contraction is 0.0048. The solution containing 5.95 per cent. of anhydrous salt has the same volume as the water required to make it.—Blowpipe reactions in plaster of Paris tablets, by Prof. E. Haanel, Ph.D. This paper was a continuation of that presented to the Society last year. The author described the result of the treatment of copper with hydrobromic acid, and of iron and

selenide of mercury with hydriodic acid. He held the range of coatings *per se* for those tablets to be greater than for any other support used in blowpipe analysis, and described these coatings for selenium, tiemannite, arsenic, silver, alloys of bismuth, antimony, and lead with silver, galena, orpiment, realgar, mercury, tellurium, carbon, cadmium, and gold.—Description of an apparatus for distinguishing flame-colouring constituents when occurring together in an assay, by Prof. E. Haanel, Ph.D. The apparatus consists of a spectacle frame furnished for the left eye with plain colourless glass, and for the right eye with four glasses—red, green, violet, and blue. These glasses revolve on an axis, and can be brought either separately or in any combination before the eye of the operator.—“Essai sur la Constitution atomique de la Matière,” by the Very Rev. T. E. Hamel, D.D.—The algebraical development of certain functions, by Prof. N. F. Dupuis, M.A.—Contributions to our knowledge of the iron ores of Ontario, by Prof. E. J. Chapman, Ph.D., LL.D. The paper contained a series of analyses of magnetic and other iron ores from samples obtained personally by the author from various parts of Ontario. The geological conditions of the deposits are also briefly given.—“Note sur une fait météorologique particulier à Québec,” by Rev. Prof. J. C. K. Lafamme, D.D.

Section. IV. (Geological and Biological Sciences).—The following papers were read:—Note of observations in 1883 on the geology of a part of the north shore of Lake Superior, by A. R. C. Selwyn, LL.D., F.R.S. In these observations the author considered he was able to show that the great masses of columnar trap which form the summit of Thunder Cape, Pic Island, and McKay's Mountain were not part of a “crowning overflow,” as they have been described to be, and newer than the Keweenaw series, but that they are contemporaneous with the black slaty shales of the Animikie series, which immediately and conformably underlie them.—Revision of the Canadian Ranunculaceæ, by Prof. George Lawson, Ph.D., LL.D. (Halifax, N.S.). The author referred to his “Monograph of Ranunculaceæ,” published in 1870, to the extensive collections that had been subsequently made, and to works published upon the North American flora, all of which enabled a fuller and more accurate description of Canadian ranunculaceous plants to be given now than was possible when the previous paper was prepared. The greater precision given to recent observation had also enabled the geographical range of these plants to be stated more fully. The striking diversity of modification in the form, number, and arrangement of the several parts of the flower and of the fruit in the several genera was pointed out. The number of Canadian species is 78 and of varieties 18: viz. Clematis 4, Anemone 14, Thalictrum 6, Ranunculus 29, Myosurus 2, Pæonia 1, Caltha 3, Trollius 1, Coptis 2, Aquilegia 2, Delphinium 5, Aconitum 2, Hydrastis 1, Actæa 2, Cimicifuga 1, Trautvetteria 1.—Geology and geological work in the Old World in their relation to Canada, by Principal Dawson, C.M.G., LL.D., F.R.S.—The Taconic question in geology, part 2, by T. Sterry Hunt, LL.D., F.R.S. The writer having given in the *Transactions* of the Royal Society of Canada for 1883 the first part of this paper, it remains in the second and last part to show, in the first place, more fully than has yet been done, the relations of the Taconian or Lower Taconic series of stratified rocks to the succeeding Cambrian or Upper Taconic, which some geologists have confounded with the Taconian. In this connection is given a critical discussion of the studies of Perry, Marcou, and others, and the opinions of Dana as regards the Cambrian of the Appalachian region of North America. In the second place is considered the probable equivalence of the Taconian to the Itacolomite series of Brazil and to similar rocks elsewhere in South America and the West Indian Islands, as well as in Hindostan and Southern Europe. All of these comparative studies, it is said, tend to establish the distinctness of the Taconian as a great and widely-spread series of crystalline stratified rocks occupying a horizon between the Cambrian and Montalban or younger gneiss series of Europe and North America.—Note on the occurrence of certain butterflies in Canada, by W. Saunders, London, Ontario. *Papilio cresphontes*, once a rare butterfly in Ontario, is now widely disseminated throughout that province. In the Southern United States its larvae feed on the leaves of the orange and lemon, but in Canada they appear to thrive upon the foliage of such members of the *Rutaceæ* as *Xanthoxylon*, *Ptelea*, *Ruta*, and *Dictamnus*. *Papilio philenor* is also extremely rare in Canada, but a large flock of this species was observed by the Rev. C. J. S. Bethune near Woodstock, Ontario,

in 1858. The writer also recorded the capture of *Terias mexicana* and *Thecla smilacis* at Point Pelée, Ontario, in 1882, and concluded by remarking that twenty-three years ago he had taken two specimens of a new species of *Thecla* at London, Ontario, which has since been described by Mr. W. H. Edwards as *T. lata*.—On some deposits of titaniferous iron ore in the counties of Haliburton and Hastings, Ontario, by Prof. E. J. Chapman, Ph.D. This paper, after referring to the occurrence of numerous deposits of magnetic iron ore in certain zones or belts of country in the counties of Victoria, Haliburton, Peterborough, and Hastings, describes their conditions of occurrence as those of large isolated masses or “stocks,” forming in some cases “sheathed stocks,” or *Stockscheidungers* and *Skölers* of German and Swedish miners, as in the great iron ore zone of Arendal in Norway. Whilst these stock-masses of iron ore are for the greater part quite free from titanium, one of vast size in the township of Glamorgan, and another equally large mass in Tudor, are shown to contain a considerable amount of titanium. Detailed descriptions of these are given, with analysis of the ore by the writer.—On mimetism in inorganic nature, by Prof. E. J. Chapman, Ph.D. Mimetism—as recognised in organic nature—has been regarded on the one hand as the direct result of a protecting Providence, and, on the other, as originating in minute approaches towards the imitated object, these becoming intensified in successive generations until the imitation becomes complete or reaches its extreme limit. In this paper the writer attempts to show that neither hypothesis may be absolutely correct, but that the peculiarity may be due to some occult law of “localism” by which associated forms often become impressed with mutual resemblances. In support of this view he refers to several curious cases in which certain minerals, normally and generally of very dissimilar aspect, become closely mimetic under certain local conditions, as seen in examples of quartz and zircon, pyroxene and apatite, &c., in the phosphate deposits of the Ottawa region.—A monograph of Canadian ferns, by Dr. T. J. W. Burgess and Prof. J. Macconn, M.A., F.L.S. Prof. Macconn stated that twenty years ago the total number of ferns known to occur in Canada was forty-six, while at the present time it had increased to sixty-three. In illustrating the range of the more interesting species, he particularly noticed the occurrence of *Phegopteris calcarea* in Anticosti, where he had found it in 1882, and remarked that the same plant has recently been collected by Dr. G. M. Dawson and R. Bell in the country around and to the east of the Lake of the Woods.—On geological contacts and ancient erosion in the province of New Brunswick, by Prof. L. W. Bailey, M.A., Ph.D. This paper summarises the more important and well-established lines of physical contact between the geological formations of New Brunswick, as bearing upon the relative age of the latter and the disturbances to which they have been subjected. Three well-marked breaks separating groups of widely diverse character were recognised among pre-Cambrian strata,—the supposed equivalents of Laurentian, Huronian, and possibly Montalban horizons,—a very marked one at the base of the Cambrian, and others successively between later formations to the base of the Trias. The evidence of such breaks was shown to be of various character, including discordance of dip and strike, overlap, igneous extravasations, and intermediate erosion, and the bearing of the facts determined on the physical and geological history of North-Eastern America, was briefly discussed. The granites, which constitute so marked a feature in the geology of the Acadian Provinces, were described as intrusive, and as the cause of the extensive alteration exhibited by the formation, which they have invaded. The erosion which accompanied or followed upon the disturbances described was shown to have been enormous.—Illustrations of the fauna of the St. John group. Part III. Conocoryphidæ, with notes on the Paradoxidæ, by G. F. Matthew. The species of *Conocoryphe* referred to and illustrated are *C. matthewi*, Hartt, with three varieties; *C. elegans*, Hartt; *C. baileyi*, Hartt, with two varieties, and a new form which the author describes as *C. walcolti*. Critical remarks are also made upon *Paradoxides lamellatus*, Hartt, and *P. acadicus*.—The Glacial deposits in the neighbourhood of the Bow and Belly Rivers, by Dr. G. M. Dawson, A.R.S.M.—On the geology and economic minerals of Hudson's Bay and Northern Canada, by Robert Bell, M.D., LL.D., Assistant Director of the Geological Survey of Canada. By Northern Canada the author meant the whole of the Dominion northward of the organised Provinces and Districts, as far as known. His information was derived from his own observations around Hudson's Bay and in

the North-West Territories, and from the reports and maps of the scientific men who had accompanied the various Arctic expeditions by sea and land. Specimens and interesting notes on the geology of Great Slave Lake had been received from Capt. H. P. Dawson, R.A., who had spent last year there in charge of the Canadian Station of the Circumpolar Commission. The distribution of the various formations from the oldest to the newest was illustrated by a large geologically-coloured map of the whole Dominion. Referring first to the Laurentian system, Prof. Bell showed that it forms the surface-rock over an enormous area of circular form on the main continent, and that the central part is occupied by the waters of Hudson's Bay, which are surrounded by a border of Palæozoic rocks. If we included the Laurentian rocks of Greenland and the Atlantic coast from Newfoundland to Georgia, it would be observed that their general outline corresponds with that of the continent, which has been built up around this ancient nucleus. The Huronian strata, which constitute the principal metalliferous series in Canada, were closely associated with the Laurentian, and appeared to be always conformable with them. The largest and best-known areas were between Lake Huron and James's Bay, but Dr. Bell had found four belts of them on the east coast of Hudson's Bay, and others had been recognised in the primitive region to the west of it. Indeed wherever the older crystalline rocks had been explored in Canada, belts having the character of the Huronian series had been met with. Limestones, slates, and quartzites, interstratified with amygdaloids, basalts, &c., corresponding with the Nipigon formation of Lakes Superior and Nipigon were largely developed on the Eastmain coast and adjacent islands of Hudson's Bay, and apparently also on the Coppermine River and to the westward of it. But a set of hard red siliceous conglomerates and sandstones were seen to come between the Huronian and the Nipigon series at Richmond Gulf on the Eastmain coast, which appeared to be unconformable to both. Mr. Cochrane and Dr. Bell had found similar rocks on Athabasca Lake, Capt. Dawson, R.A., on Great Slave Lake, and Sir John Richardson to the north-east of Great Bear Lake. The conglomerates, slates, and gray argillaceous quartzites of Churchill and the white fine-grained quartzite of Marble Island were probably of this horizon. Silurian rocks were well known to be widely spread on some of the largest of the Arctic islands, and along the most northern channels of the Polar Sea. They formed an irregular and interrupted border on the western side of Hudson's and James's Bays. A large basin of Devonian strata, containing gypsum and clay-ironstone, extended southward from James's Bay. West of the great Laurentian area, Devonian rocks could be traced here and there all the way from Minnesota to the mouth of the Mackenzie River. They were not, however, so widely distributed as had been supposed by the older travellers, who had passed rapidly through the country in the early part of the century, when the whole subject of American geology was in its infancy. The so-called bituminous shale of Sir John Richardson and others, so prevalent along the Athabasca and Mackenzie Rivers, was found by Prof. Bell to consist of soft Cretaceous strata, saturated and blackened by the petroleum rising out of the underlying Devonian rocks, which here, as in Ontario, Ohio, and Pennsylvania, are rich in this substance. The principal features and the geographical distribution of the Carboniferous, Liassic, Cretaceous, and Tertiary rocks of the northern regions were next described. Among other points of interest in reference to the post-Tertiary period, Dr. Bell mentioned that the remains of both the mastodon and mammoth had been found on Hudson's Bay, and that there were reports of the occurrence of elephants' tusks on an island in its northern part. Isolated discoveries of elephantine remains had been made in the North-West Territories and several on the Rat River, a tributary of the Youkon, near the borders of Alaska. In referring to the economic minerals, Prof. Bell said that even the coarser ones, such as granite, limestone, cement-stone, slate, flagstones, gypsum, clays, marls, ochres, sand for glass-making, moulding, &c., would yet have their value in different parts of the great region under consideration. Soapstone, mica, plumbago, asbestos, chromic iron, phosphate of lime, salt, pyrites, &c., had been noted in different localities. Among ornamental stones known to occur, might be mentioned the rare and beautiful mineral lazulite discovered by Dr. Bell at Churchill, also malachite, jade, agate, cornelian, chrysoprase, &c. Lignites of various qualities, some being very good, were found in many places throughout the great tract occupied by the Cretaceous and Tertiary rocks of the Athabasca-Mackenzie Valley and on the

coasts and islands of the Arctic Sea; also in Tertiary strata at Cumberland Bay and in Greenland, on the opposite side of Davis' Strait. The lignites found by Dr. Bell on the Albany and Moore Rivers were of post-Tertiary age. Anthracite of fine quality had been found on Long Island in Hudson's Bay. True bituminous coal had been reported to occur on Banks' Land, Melville, and Bathurst Islands. Petroleum, which proceeded from Devonian strata as elsewhere in North America, was very abundant along the Athabasca and Mackenzie Rivers, and vast quantities of asphalt resulting from the drying up of the exuding petroleum were found on the Athabasca, around Great Slave Lake, and at various places in the interior. In reference to the metals, the ores of iron were abundant. Inexhaustible quantities of rich manganese carbonate of iron existed on the islands of the Manitounik chain. It lay in beds upon the surface over hundreds of square miles, and was broken up by the frost into pieces of convenient sizes for shipping. Valuable deposits of magnetic iron had been found on Athabasca and Knee Lakes, and a great bed of pure clay-ironstone on the Mattogomi River. Capt. Dawson had found a vein of specular iron on Great Slave Lake. Copper ore had been met with on Hudson's Bay and near Lake Mistassini, and large quantities of the native metal were known to occur on the Coppermine River. A band of limestone, running from Little Whale River to Richmond Gulf, was rich in galena. Zinc, molybdenum, and manganese had been found on Hudson's Bay, and antimony in the north. Both gold and silver had been detected in veins on the Eastmain coast, and alluvial gold had been washed out of the gravel and sand of the streams among the mountains in the tract to the west of the lower part of the Mackenzie River, which Dr. Bell thought might yet become the great gold and silver region of the north, corresponding with Colorado and Nevada to the south. The fine gold-dust found in the drift in one section of the North Saskatchewan may have been derived, during the Glacial period, from the upper valleys of the Liard, on one of which the famous Cassiar gold district is situated; although Dr. Bell had some years ago originated the theory that this gold might have come from Huronian rocks in the district to the north-eastward of Edmonton.—"Note sur certains dépôts aurifères de la Beauce," by the Rev. Prof. Lafamme, D.D.—"Découverte de l'émeraude au Saguenay," by the same.—Description of a supposed new Ammonite from the Upper Cretaceous rocks of Fort St. John on the Peace River, by Prof. J. F. Whiteaves, F.G.S., &c.; On a new Decapod Crustacean from the Pierre Shales of Hightwood River, N.W.T., by the same. The Ammonite referred to in the first of these communications appears to be a previously undescribed species of *Prionocyclus*, closely allied to the type of that genus, the *Ammonites woolgari* of Sowerby, but with much more closely coiled volutions. It occurs in flattened nodules, in shales which are believed to be the equivalents of the Fort Benton group of the Upper Missouri section. The Decapod Crustacean from Hightwood River, a tributary of the Bow, is doubtfully referred to the genus *Hoploparva* of McCoy.—Notes on the manganese ores of Nova Scotia, by E. Gilpin, M.A., F.G.S.—A revision of the geology of Antigonish County, Nova Scotia, by the Rev. D. Honeyman, D.C.L.—"Notes sur la constitution géologique de l'Apatite Canadienne," by S. Obalski.

#### THE RAINS AND THE RECENT VOLCANIC ERUPTIONS<sup>1</sup>

THE rains this year have been more persistent than usual. At Perpignan they have been extraordinary. Is it necessary to see any relation between this circumstance and the recent volcanic eruptions? The beautiful opalescent colorations of the past autumn and winter have been attributed to these eruptions; ought we also to attribute to them the extraordinary spring rains? I should be inclined to believe it. It is acknowledged that the presence in the atmosphere of solid particles facilitates the condensation of vapour. This would be in conformity with the position maintained by Mr. Aitken in his paper on Dust, Fog, and Clouds (volume for 1880-81, *Trans. R.S.E.*). He concludes thus:—"In an atmosphere saturated with vapour, but free from dust, there is formed neither cloud nor fog; whenever the vapour of water is condensed in the atmosphere, it is owing to the presence of those solid particles, each of which becomes, so to speak, a centre of condensation, or the nucleus of a small crystal of ice."

<sup>1</sup> Paper read at the Paris Academy of Sciences by M. Gay, June 23.

Very often direct observation has shown the existence of these dusts in drops of rain, and this is what has happened in all parts of the world since the crepuscular colorations of 1883-84. The dusts collected have a composition which usually indicates a volcanic origin. It has been shown that other volcanic eruptions have been followed by red glows in the sky; it appears to me that it may also be shown that they have been followed by abundant rains. The eruptions which have been referred to are those of the Skaptar Joekull, in Iceland, in the beginning of May 1783; of a new volcano, since disappeared, in the Sicilian Sea early in July 1831; Cotopaxi, in America, in 1856; Vesuvius in 1862. These eruptions were followed by colorations; I add that they were followed by rains which exceeded the mean. The following, in millimetres, are the monthly heights of rain collected on the terrace of the Paris Observatory; the second line is the monthly mean of from twenty to thirty years:—

	May	June	July	Aug.	Sept.	
1783 ... ..	62	86	43	75	51	
Means ... ..	47	49	86	47	42	
	Oct.	Nov.	Dec.	Jan. 1832		
1831 ... ..	52	76	36	35		
Means ... ..	41	47	34	34		
	April	May	June	July	Aug.	Sept.
1856 ... ..	51	117	49	54	54	60
Means ... ..	37	53	54	55	45	48
	Aug.	Sept.	Oct.	Nov.	Dec.	
1862 ... ..	52	51	73	17	42	
Means ... ..	45	48	51	36	35	

### EXPERIMENTS ON THE PASSAGE OF ELECTRICITY THROUGH GASES—SKETCH OF A THEORY<sup>1</sup>

THE passage of electricity through gases has of late years become a very favourite subject for experimental investigation. A large number of facts have thus been accumulated, and it becomes of importance to see whether these facts throw any light on the theoretical notions which we have based on other branches of electrical inquiry.

If we have two bodies at a different electrical potential separated by a layer of air, we might imagine the air in contact with the bodies to become electrified, then move on, impelled by the electric forces, and re-establish equilibrium by giving up their charges. The passage of electricity through gases would then be similar to the diffusion of heat. But, however natural such a view would be, it is impossible to maintain it in the face of experimental facts. The experiments which I shall bring before you to-day seem to me to support, on the contrary, the idea that the passage of electricity through a gas resembles the phenomenon studied by Helmholtz under the name of electrolytic convection.

I shall avoid as much as possible all suppositions and hypotheses which cannot be put to the test of experiment; but it seems necessary to start with some assumption in order to avoid too great a vagueness in the subsequent explanations. The assumption which I shall make is this: In a gas the passage of electricity from one molecule to another is always accompanied by an interchange of the atoms composing the molecule. I shall also try to prove that many facts are easily explained by the assumption that the molecules are broken up at the negative pole.

If, in a vacuum-tube of the ordinary form, the discharge is passed at a pressure of about one millimetre, a luminosity is seen round the negative pole which is called the negative glow. A luminous tongue projects from the end of the positive pole, which I shall call the positive part of the discharge, without meaning to imply that it is charged with positive electricity. The positive part of the discharge and the negative glow are separated by a non-luminous space, which I shall call "the dark interval." The glow itself is divided into three layers, the thickness of which increases with decreasing density. Closely surrounding the electrode itself, we have in the first place a luminous layer, which on new electrodes is of a golden colour. The spectroscopist shows the presence of sodium and hydrogen; the sodium is due to foreign matter deposited on the electrode, and the hydrogen is expelled by the action of the heat out of the

electrode by which it had been absorbed. When the electrodes have been in use for some time, the golden colour disappears, and the spectrum belonging to the gas used is seen. The second layer is known by the name of the dark space. The third layer is the glow proper.

The theory which I shall endeavour to establish is this: That within the first layer the gaseous molecules are decomposed, that their negative parts are projected with great velocity through the dark space, that this velocity is gradually reduced by impacts within the glow, and that in the positive part of discharge the discharge takes place by diffusion except when stratifications appear.

According to the kinetic theory of gases, the molecule of mercury vapour consists of a single atom, which is incapable of vibration. Mercury has a very brilliant spectrum, which proves that the theory is incomplete in some important point. It is well known, on the other hand, that the theoretical conclusion receives support from the fact that the vapour-density of mercury vapour is anomalous. If, as is generally supposed, the molecule of the majority of gases contains two atoms, that of mercury can only contain one. If an essential part of the glow discharge is due to the breaking up of the molecules, we might expect mercury vapour to present other and much simpler phenomena than the gases with which we are generally accustomed to work. *This, indeed, is the case; for I find that, if the mercury vapour is sufficiently free from air, the discharge through it shows no negative glow, no dark spaces, and no stratifications.* At the ordinary temperature the spark does not pass through mercury vapour; but if a tube free of air, but containing mercury vapour, is heated, the discharge passes always in a continuous stream of light. It is not always quite symmetrical with respect to the two poles; and a very curious tendency of the spark is noticed, to pass at the negative pole rather from the glass out of which the electrode protrudes than from the metallic electrode itself. A brilliant sodium spectrum then appears at the point from which the spark sets out. Whenever small traces of air remain, stratifications are very apt to appear, as a mixture of air and mercury gives fine stratifications, but I have never noticed them after sufficient removal of the air.

I now pass to the description of an experiment which seems to me to be only capable of explanation by the views brought forward in this paper, and I should like therefore to consider them as crucial experiments, which have to be explained by any true theory of the discharge. As negative electrode, I use an aluminium cylinder of 5.5 cm. internal diameter and 8 cm. long. A long aluminium wire running parallel to the axis of the cylinder at a distance of about an inch formed the positive electrode. On exhaustion, the discharge at first passes as a spark in the ordinary way, but as the pressure decreases the glow gradually surrounds the whole cylinder, with the exception of a dark strip about 2 or 3 cm. in width, directly opposite the positive wire. The positive electrode seems, therefore, to repel the negative glow.

The following seems to me a plausible explanation of the phenomenon which I have just described. The rapid fall of potential which is observed on crossing the negative electrode suggests at once, independently of any theory that we have to deal with, the action of a condenser, for we know that no static charge can produce a finite difference of potential at the electrode, while a double layer will produce a discontinuity. Although it may not be proved that an absolute discontinuity of potential exists at the cathode, it is yet certain that a very rapid fall occurs at that place. This is all that is necessary for the argument.

We recognise such a double layer in the case of electrolytes, but there is an essential difference in the thickness of the layer within which we must imagine that condenser action to take place. In the liquids that thickness must be very small, as is shown by the intensity of the observed polarisation currents. The positively electrified matter in every case is kept against the negative surface by a joint action of electrical and chemical forces, for it has been shown by Helmholtz that only thus can we explain a difference of potential between two bodies. It is the chemical forces which keep the electricities asunder. The gaseous molecules or atoms, however subject to their mutual encounters, and always having certain velocities, will tend to leave the surface. They are kept near the surface, however, by the electrical forces.

Suppose, now, that a positive electrode is placed near such a condenser. The resistance of the gas is so much greater than that of the metal electrode that we shall assume the whole elec-

<sup>1</sup> Abstract of the Bakerian Lecture. Read before the Royal Society, June 19, 1884, by Arthur Schuster, Ph.D., F.R.S.

trode to be of the same potential. The lines of force will then cut the surface at right angles, and could we assume the condenser to be infinitely thin, there would only be a normal force acting on its particles; but as the lines of force are curved, the particles not in immediate contact with the surface are acted on by a tangential force which will tend to drive them away from the positive electrode. As a steady state will only be possible when the total force is normal throughout the condenser, we arrive at the condition for the steady state that within the condenser the fall of potential must be the same for equal distances measured along the normal to the surface.

Experimental evidence speaks strongly in favour of such a conclusion. If, for instance, a thin wire is used as electrode, it is well known that the tension at the end of the wire before discharge is very much larger than anywhere else. At high pressures the discharge passes indeed from the end of the wire, but as the exhaustion proceeds, the glow gradually covers the whole wire, and the same amount of electricity flows out of equal areas situated anywhere on the wire, for the dark space which alters its width with the intensity of current is everywhere the same; this implies that the fall of potential per unit distance is the same all over the wire.

Hitherto we have only assumed a certain number of particles positively electrified in the immediate neighbourhood of the negative electrode, and we have left it altogether undecided what these particles are. But if we consider now the fact that the glow does not appear opposite the positive electrode, that is to say, that while the fall of potential is the same all over the surface the flow is stronger at some places than at others, we are driven to the conclusion that the flow does not altogether depend on the fall of potential, and we must again look for an explanation in the chemical as well as the electric forces. Wherever the fall of potential is chiefly produced by the presence of the positively electrified particles, which I now assume to be the decomposed molecules of the gas, these will help by their chemical action to decompose other molecules. Opposite the positive pole the fall of potential is principally due to nearness of that electrode; chemical forces are absent, and the molecules will not be decomposed. This is, I believe, the explanation of the dark area. And it brings with it the explanation of a large quantity of other facts, as, for instance, the one which has been so long observed and well established, that once a current is set up in the gas it requires a much smaller electromotive force to keep it going. For the discharge, according to us, will generally be introduced by a spark which must give the first supply of decomposed molecules before the continuous glow discharge can establish itself.

I may for the sake of clearness once more mention shortly the principal points of the argument.

The rapid fall of potential in the neighbourhood of the negative electrode renders the presence of positively electrified particles in its neighbourhood necessary.

If the distance through which the condenser action takes place is sensible, the positively electrified particles will be acted upon by a neighbouring positive electrode.

A steady state will be established in which the fall of potential along the normal from the surface will be everywhere the same.

As however the flow is stronger away from the positive electrode, we must conclude that other forces besides electrical forces determine the flow.

It is natural to assume that these are chemical forces: that, in other words, the positively electrified particles are the decomposed molecules, which by their presence assist the decomposition of others, and therefore the formation of the current.

Unless a flaw is detected in this line of argument, I think that the conclusion must be granted, namely, that the decomposition of the molecules at the negative electrode is essential to the formation of the glow discharge. This is really all that I endeavour to support in this paper. The rest can only be settled by further experiments. And amongst the rest I count also the primary cause which originally produces the decomposition of molecules at one pole rather than at another. It is possibly due to an electromotive force of contact between the gas and the electrodes which tends to make the gas electro-negative.

The gaseous molecules, then, according to our theory, are decomposed at the negative pole. Their negative constituents can follow the electric action, and as the fall of potential in the im-

mediate neighbourhood of the pole is very rapid, the atoms will leave the pole with considerable velocity. That the region of the dark space is filled with matter projected from the negative pole follows almost conclusively from the experiments of Goldstein and Crookes, and is also shown in a most striking way by an experiment due to Hittorf. If a tube contains two parallel wire electrodes at a distance of say a quarter of an inch, the discharge will at high pressure pass in the usual way from electrode to electrode, but at very low pressures the discharge from the positive pole goes away from the negative. The results can be shortly expressed by saying that, as far as the positive pole is concerned, the inner boundary of the dark space forms the negative electrode. If the dark space is small and does not reach to the positive pole, the discharge passes from the latter towards the negative pole, but as soon as the dark space extends beyond the positive pole, the positive part of the discharge goes towards the nearest point of the dark space that is straight away from the negative pole.

We have then two closely adjoining, almost overlapping parts, in which the discharge is in opposite directions, and this could not be unless electricity is carried by matter which can, owing to its inertia and high velocity, move against the electric forces. To my mind this experiment proves conclusively that the negative electricity is bound to matter projected with high velocity away from the negative pole.

Goldstein has shown that when a thin pencil of the negative glow belonging to one electrode passes close to another the pencil is deflected. According to our view, such a pencil would be formed by a succession of negatively charged particles projected in nearly the same direction away from the negative electrode; as these particles pass by another kathode, they are naturally deflected out of their path by the electric forces. Goldstein has shown that if the current is equally divided between the two kathodes, the deflection is independent of the intensity of the current, the pressure, and the nature of the gas. This is exactly what ought to happen according to our theory, for strengthening the current at one kathode means, as will presently appear, increasing the velocity of the particles. The square of the velocity will increase in the same ratio as the total fall of potential in the neighbourhood of the negative pole; as the particles pass the other kathode, the forces from it are increased in the same ratio as the square of the velocity with which they are moving, and consequently the path will remain the same. Similarly all the other experimental facts established by Goldstein can be easily explained.

The most conclusive proof of the view adopted in this paper would be found in the demonstration that the amount of electricity carried by each particle was always the same, whatever the current. I propose to test this fact in the following way:—It was found by Hittorf that the particles proceeding from the negative electrode, and projected at right angles to the lines of force in a magnetic field are bent round in a circle. This is as it should be, and I calculate that the radius of the circle ought to vary as  $\sqrt{F}/e$ , where  $F$  is the total fall of potential within the region in which the particles acquire their velocity, and  $e$  is the amount of electricity carried by each particle. As the current increases, it is shown by Hittorf that  $F$  increases; and I find that at the same time the diameter of the ring in the magnetic field increases. If this diameter varies as the square root of  $F$ , it would be proved that  $e$  must be constant as it is in electrolysis. At present we can only say that the average amount of electricity carried by the particles must increase less rapidly than the fall of potential. If  $e$  varies at all, we should expect it to vary proportionally to the fall of potential in the neighbourhood of the negative electrode, and in that case the diameter of the ring would be independent of the current, which it is not.

The theory which I advocate involves the existence of a polarisation, and it might be considered a difficulty that no polarisation currents have with certainty been observed in gases. I believe the difficulty only to be apparent, for the experiments prove that the fall of potential near the negative pole, though rapid, is not sudden, so that the layer within which the condenser action takes place is very much thicker in gases than in liquids. The capacity of the condenser is therefore smaller, and though the total fall of potential in the gas may even be stronger than in the liquid, the polarisation currents might escape observation.

With regard to the positive part of the discharge it will be sufficient here to mention that stratifications are principally observed in mixtures of gases or in compound gases, and that in



the intervals between two stratifications the discharge is very likely carried as through the dark space at the negative electrode, while in the stratifications recombination of the decomposed atoms takes place.

An interesting law has been proved by Hittorf and E. Wiedemann in the case of the unstratified discharge. Hittorf shows that the fall of potential is the same in the positive part for the same tube whatever the current. This means that the energy dissipated is proportional to the current, and not to the square of the current as in a liquid. In the latter form the proposition had previously been proved by E. Wiedemann, who has shown that the total quantity of heat generated is proportional to the total quantity of electricity which has passed through the tube, whether in a few strong sparks or many weaker ones.

These experiments seem to point to the fact that once the original velocity of the particles at the regular pole has been reduced the velocity becomes independent of the strength of the current, that is to say, that in the positive part of the current greater intensity only means a greater number of particles taking place in the discharge.

The paper also contains spectroscopic evidence as to the state of dissociation in a vacuum tube, especially in the negative glow.

The question as to how the electricity passes from the electrode to the gas is not discussed, nor is it possible at present to decide, should the theory prove true, whether the polarity of the atoms in the molecule depends on the way in which these are combined, or whether that atom takes positive polarity which happens to be nearest the negative electrode as the molecule approaches it.

In conclusion some novel influence of the magnet on the negative glow is described, and it is shown that two different effects have to be clearly distinguished. The first is an effect of the magnet on the discharge when that discharge is established, and has been sufficiently well investigated. But the second effect depends on the question from what part of the negative electrode the discharge sets out. With respect to this question we meet with many contradictory and inaccurate statements. If at any place the magnet tends to throw the glow together the temperature will be raised, and owing to this fact the current will be strengthened, which again raises the temperature. It may thus happen that a slight cause can induce the current to pass almost exclusively from one part of the negative electrode. For a detailed description the reader is referred to the paper itself and the illustrations accompanying it.

### UNIVERSITY AND EDUCATIONAL INTELLIGENCE

MR. ANDREW GRAY, M.A., assistant to Sir William Thomson in the Natural Philosophy department of the University of Glasgow, has been appointed to the Chair of Physics in North Wales University College. Dr. J. J. Dobbie, M.A., formerly "Clark" Fellow in Natural Science, has been elected to the Chair of Chemistry and Geology.

THE following is a list of prizes, scholarships, associateships, &c., awarded at the Normal School of Science and Royal School of Mines, South Kensington, June 1884:—First Year Scholarships: Albert G. Hadcock; Fred. Carrodus; William C. Rowden; Thomas Rose. Second Year Scholarships:—George Gibbens; Isaac T. Walls. "Edward Forbes" Medal and prize of books for biology, Thomas Johnson; "Murchison" Medal and prize of books for geology, Martin F. Woodward; "Tyndall" prize of books for physics, course 1, Isaac T. Walls; "De la Beche" Medal for mining, Herbert W. Hughes; "Bessmer" Medal, with prize of books from Prof. Chandler Roberts for metallurgy, (1) Percy Bosworth-Smith, (2) William F. Grace; "Hodgkinson" prizes for chemistry, (1st, books, &c.) George T. Holloway; (2nd) Stephen J. Elliott and William P. Wynne. Associateships in Normal School of Science: chemistry, 1st class, George T. Holloway, William P. Wynne, and Elizabeth Healey; physics, 1st class, Benjamin Illingworth and Alfred Howard; biology, 2nd class, and geology 2nd class, Joseph Lomas. Associateships in Royal School of Mines: mining, 1st class, Herbert W. Hughes; mining, 2nd class, and metallurgy, 1st class, George H. Schröder; metallurgy, 1st class, Percy Bosworth-Smith, Alfred Sutton, Henry G. Graves, and Harry J. Chaney; metallurgy, 2nd class, William F. Fremersdorf and Erskine H. B. Stephenson.

### SCIENTIFIC SERIALS

*American Journal of Science*, June.—On the tendency of rivers flowing to the north or to the south to encroach on their east or west banks respectively, by G. K. Gilbert. The author, after further study, here finally adopts the view that this tendency is sufficiently accounted for by terrestrial rotation.—Examination of Mr. Alfred R. Wallace's "Modification of the Physical Theory of Secular Changes of Climate," part II., geological and palæontological facts in relation to Mr. Wallace's modification of the theory, by Dr. James Coll.—Description of a new fossil marsupial from the Miocene deposits of Chalk Bluffs, Colorado, by W. B. Scott. This opossum, which the author names *Didelphys pygmaea*, is intermediate in size between the *D. murina* and *D. elegans* of South America. It establishes the fact that the small insectivorous opossums now characteristic of South America existed in Miocene times in North America, and is additional evidence that the latter continent is the source from which the former received the greater part of its fauna.—On a method of obtaining autographic records of the free vibrations of a tuning-fork, and on the autographic recording of beats (five illustrations), by Alfred G. Compton.—Notes on the volcanic rocks of the Great Basin, stretching for over 400 miles from the Sierra Nevada eastwards to the western base of the Wahsatch Range, by Arnold Hague and Joseph P. Iddings. In this region the association of andesites and trachytes, or trachytes and rhyolites, is unknown, and the authors infer that trachytes occupy a far more restricted position among volcanic rocks than has hitherto been generally supposed. They also consider that the geological independence of rhyolite and trachyte is now clearly established.—Transition from the copper-bearing series to the Potsdam in the St. Croix River Basin, Wisconsin, by L. C. Wooster.—On the expression of electrical resistance in terms of a velocity, by Francis E. Nipher.—Lateral astronomical refraction, by J. M. Schaeberle. The author proposes a simple remedy for the errors in astronomical observations arising from the assumption that all atmospheric layers of the same density over any given locality are parallel to the horizon.—Description of a remarkable variety of kaolinite from the National Belle Mine, Red Mountain, Ouray County, Colorado (three illustrations), by Richard C. Hills.—The influence of convection on glaciation, by Geo. F. Becker.—Description of a new Dinichthys (*D. minor*) from the Portage Group of Western New York (two illustrations), by Eugene K. S. Ringueberg. This specimen differs in several important respects from the two Ohio species *D. Herseri* and *D. Terrelli*, Newb.—Mineralogical notes on allanite, apatite, and tysonite (two illustrations), by Edward S. Dana.

*Revue d'Anthropologie*, tome vii. fasc. 2, Paris, 1884.—On the weight of the cerebellum and the hemispheres according to Broca's mode of registration, by Dr. Philippe Rey, who has been commissioned by M. Topinard to continue the comparative tables and determinations which had already served as the basis of the memoir drawn up by the latter on the weight of the brain. Bicêtre, Saint-Antoine, La Pitié, and La Salpêtrière are the sources whence Dr. Rey has derived the requisite data for his work, and his conclusions must therefore be regarded as having more of a special than a general interest, since they are exclusively based on observations of the particular classes of persons confined in these institutions.—Study of primitive peoples, as the Kaffirs, and more especially the Zulus, by Elie Reclus. This paper presents little interest or novelty for English readers, as it consists almost entirely of extracts from English travellers and missionaries, and neither opens up new sources of information nor throws any novel light on the ethnography of the nations of whom it principally treats.—On the Kalmuks, by M. Deniker. In this second part of his memoir the author, after completing his description of the anatomical and physiological characters of the Kalmuk race, which he shows to be generally brachycephalic, supplies much important information regarding their present social and political condition under the influence of Russian domination. It would appear that the people have considerable mental capacity, various young Kalmuks having taken good places in the examinations of the University of Astrakan, and officiating creditably as medical practitioners, and as directors of the hospitals which the Russians are establishing for the benefit of the tribes. The change from a nomadic to a stationary life seems, however, to have been productive of decided injury, the census of 1869 showing a diminution of 22 per cent. in the population since 1862. According to the author, this diminution principally affects females, while this census presents, moreover, the singular

feature that male births are in excess of those of the opposite sex in the proportion of 139 to 100. It is conjectured, however, that this estimate may be incorrect, and due to the fact that women and female children are regarded as of little importance, on which account their numbers may not always be taken with exactitude. There would, on the other hand, appear to be no doubt of the fatal influences on the Mogul of the change from an easy, inactive, nomad life to that followed in a settled community, in which the struggle for existence has to be carried on under the pressure of continuous if not hard labour and fixed regulations.—On the so-called "xyphoid" angle, by M. Charpy. By this term the author designates the angle comprised between the edges of the xyphoid depression of the thorax, while his paper is devoted to the consideration of the extent to which its general inferiority in women may be due to the pressure exerted by corsets, and how far it depends on physiological causes and pathological conditions.

*Bulletins de la Société d'Anthropologie de Paris*, tome vii. fasc. 1, 1884.—This number, as is usual with the first of the series for the year, gives the various rules and reports of the Society, with a list of its members and associates, and the presentations made to it in the preceding year, together with the opening address of the president, M. Hamy. The remaining contents are:—A report, by M. de Mortillet, of the finds at Marcilly-sur-Eure, between Dreux and Evreux, where, in a red argillaceous loam, laid bare by a railway cutting, a cranium has been discovered of the Neanderthal type. Near the spot are deposits containing elephant, rhinoceros, and other bones, intermingled with numerous flint splinters.—On the Celtic cemetery of the island of Thinié at Portivy, Saint-Pierre-Quileron, by M. Gaillard. In 14 of the 27 stone cists of various sizes which have escaped the destructive encroachments of the sea numerous remains have been found, some containing four bodies laid one above the other, and generally in inverse directions, and much bent. Some of the lower skeletons are admirably preserved, and all are remarkable for an extraordinary development of the occipital region and great flatness of the tibia. Flints and potsherds of the Dolmen age occur in large numbers.—On the Quaternary Equidae, by M. André Sanson, who bases his observations on the large collection of bones found by M. Chauvet in the Charente and Dordogne.—On the supposed flint atelier of Moulin-de-Vent, Charente-Inférieure, by M. Léon Rejou. According to M. Rejou, we have here not only the site of a prehistoric factory of ordinary flint implements, but the spot at which was manufactured a special form of these instruments, found here in considerable numbers, which he compares to our modern gimlet, and of which he has failed to discover any specimens either in the neighbouring Robenhausian deposits, or at any of the other French flint stations.—On the prehistoric flint beds at Chelles, by M. D'Acy. The most recent finds include a molar of *Elephas primigenius*, which thus confirm the hitherto contested view that this mammoth form must be included in the fauna of the Chelles beds, from which M. Gaudry had moreover already obtained three similar teeth.—On the so-called "Viens-Viens" of St. Domingo, by Dr. Dehoux, who believes that these, and other wild tribes of the Antilles, are the degraded representatives of mixed breeds, and not the descendants of primitive Indians.—On a placental anomaly, by Dr. E. Verrier, with illustrations of several other analogous abnormalities suggestive of the influence of atavism in the human subject.—On the races of the Philippine Islands, by Dr. Montano, with anthropometric tables. The author discovered traces both in ancient and recent skulls of the artificial cutting away of parts of the teeth practised in the archipelago, but he has not met in the living subject with evidence of the maxillary and other lesions, believed, according to various authorities, to result from this practice.—On a case of scaphocephalus observed in the living subject, by Dr. Delisle, with comparative tables.—On the Toltecs and their migrations, by M. Charnay.—On the Botocudos and Purys of the forests of Rio Janeiro, by Dr. P. Rey, with a vocabulary of their commonest words.—Contributions towards the ethnography of the Fuegians, by Dr. Hyades, member of the French Mission to Cape Horn. This paper is supplemented by a vocabulary and grammar drawn up by Mr. Bridges of the South American Missionary Society, whose papers on the manners and customs of the Fuegians from "A Voice for South America," vol. xiii. 1866, is also given *in extenso* by the author.—On the use of iron in Egypt, by M. Soldi; and on the antiquity of the knowledge and use of this metal by the Egyptians, by M. Beauregard. In

the former of these papers the author attempts to show that stone implements were generally used in the preliminary labour of cutting blocks for statuary, and iron tools only for completing the final processes of sculpture. M. Beauregard, in his paper, deals, on the other hand, with the chronological bearings of the question, and considers at length the precise meaning of the various hieroglyphics supposed to indicate this metal.—On the rational and methodic process of deducing proportional means, more especially in reference to the general mortality of France, by Dr. Arthur Chervin. The author explains the methods employed by him for the categorical grouping of diseases as shown in his "Géographie médicale de la France."

*Sitzungsberichte der Naturforschenden Gesellschaft, Leipzig*, 1883.—In a paper on the "Petrographic composition and structural relations of the Leipzig Graywacke," Dr. Saur confirmed the previous conclusion of Geinitz, that the rocks cropping out in the diluvial of the Leipzig district belong to the North Saxon Graywacke system, which appears to be partly Cambrian, partly Lower Silurian.—A comprehensive memoir on the German slugs was read by Dr. Simroth, who divided this family into two groups: ARION, with three species (*hortensis*, *subfuscus*, and *empiricorum*); and LIMAX, with four subdivisions (*Limax* proper, *L. levis*, *L. agestis*, and *Amalia*). In a second memoir the author dealt specially with the question of hermaphroditism and differentiation of sex in *Limax levis*.—A paper on the development of the tissues and histological system of the mammalians, by Prof. Rauber, recognises two fundamental types with possible transitional forms: (1) the type characterised by invagination of the embryoplastic pole of the germ cell (mouse, rat, guinea-pig); (2) the more general type marked by absence of invagination.—In an essay on the northern Silurian erratic boulders of the Leipzig district, Dr. Felix traces these rocks ultimately to South Sweden, Bornholm, Gotland, and especially Schonen.—A recent visit to the Brunswick Anatomical Museum suggests some interesting remarks to Dr. Hennig on the subject of malformations of the female pelvis in early life.—A paper by Dr. Rauber, on the influence of temperature, atmospheric temperature, and various elementary substances on the development of the animal ovum, aims especially at a more exact knowledge of the inner properties of the embryo. The subject is treated under two heads: (1) the power possessed by germs in various stages of resisting outward influences; (2) their plastic capacity, or power of adapting themselves by changes and modifications of all sorts to changed outward conditions. In a second paper the author reports the results of researches on the influence of increased or diminished proportions of saline solutions on Mollusks, Crustacea, Hydrea, and other aquatic fauna. His experiments point at the conclusion that the primæval oceanic waters must have always been saline.—In a memoir on the tin ores of the Eibenstock granitic system and their origin, Dr. Schröder infers that the tin ores resting on the tourmaline granites of Eibenstock have been exposed by the weathering of the associated rocks. The same conclusion is arrived at by Dr. F. Schalch respecting a new variety of strontianite discovered at Wildenan, near Schwarzenberg, in the Erzgebirge.—Some remarks on the traces of glacial action on the porphyry rocks of Wildschütz near Eilenburg, Saxony, were submitted by Dr. Dalmer, who pointed out that the striae ran in two different directions, the older and normal from north-west to south-east, the more recent exceptionally between 60° N. and 80° E.—Dr. A. Sauer presented an exhaustive analysis of some specimens of the ashes from the Krakatoa eruption of last year. The material appeared to be a lava evidently of the augite-andesite family, closely related in structure to that of Turrialba in Costa Rica.—Dr. R. Sachsse reported on a new chlorophyll dye of a yellowish-brown colour, easily soluble in alcohol. The formula of this dye, which he names  $\beta$ -phæochlorophyll, is  $C_{24}H_{23}N_3O_4$ . In another paper he gave a chemical analysis of the feldspar present in the gabbro rocks of Rosswein, Saxony, which appeared to be closely allied in structure to true labradorite.

*La Belgique horticole* for October–December 1883 devotes a large portion of its space to a list of ornamental plants described or figured in Belgian or foreign journals, or in gardeners' catalogues, or exhibited in London, in 1882. The list comprises the large number of 251 species, of which 163 are Monocotyledons, and 105 belong to the single order of Orchidæ. The names are followed by very short descriptions.—There are also in the magazine a number of short notes of interest to floriculturists, the conclusion of an article.

on the botanical discoveries of M. Roehl in America, and two fine coloured plates of *Cypridium Spicerianum*, and *Aphelandra Margarita*.

SOCIETIES AND ACADEMIES

LONDON

Royal Society, June 19.—“The Influence of Stress and Strain on the Physical Properties of Matter.”<sup>1</sup> Part I. Moduli of Elasticity—continued. Relations between Moduli of Elasticity, Thermal Capacity, and other Physical Constants. By Herbert Tomlinson, B.A. Communicated by Prof. W. Grylls Adams, M.A., F.R.S.

The thermal capacity of each of the wires already used for the experiments on moduli of elasticity and electrical conductivity described in Parts I. and II. of this paper<sup>2</sup> was determined.

Every precaution was taken both with regard to the instruments themselves and the mode of using them to avoid error, and the formulæ given below may be received with great confidence.

Metal	Density at 20°C., density of water at 4°C. = 1	Formulæ for the number of thermal units required to raise the temperature of unit mass from 0° C. to t° C. Thermal capacity of water at 0° C. = 1.	Thermal capacity per unit mass at t° C.
Aluminium ...	2.731	.20700t + .0001152t <sup>2</sup>	.20700 + .002704t
Iron ...	7.759	.10611t + .0000791t <sup>2</sup>	.10611 + .001402t
German-silver.	8.622	.09411t + .000053t <sup>2</sup>	.09411 + .00106t
Zinc ...	7.138	.09009t + .0000374t <sup>2</sup>	.09009 + .001748t
Copper ...	8.851	.09008t + .000034t <sup>2</sup>	.09008 + .001648t
Silver ...	10.464	.05466t + .000018t <sup>2</sup>	.05466 + .00036t
Tin ...	7.264	.05211t + .0000361t <sup>2</sup>	.05231 + .001222t
Platinum-silver	12.616	.04726t + .0000138t <sup>2</sup>	.04726 + .00276t
Platinum ...	21.309	.03108t + .0000069t <sup>2</sup>	.03108 + .0125t
Lead ...	11.3193	.02995t + .0000153t <sup>2</sup>	.02995 + .00406t

It will be seen that the thermal capacity of all the metals examined increased with the temperature, a result which we find confirmed by the observations of other investigators.

The thermal capacities of the alloys platinum-silver and German-silver are, within the limits of error, exactly the same as those calculated from the proportions of their components. Thermal capacity is, therefore, a physical property which is not likely to be altered to any appreciable extent by small impurities, so that the results obtained by different experimenters agree very closely with each other.

It has been proved<sup>3</sup> that if  $\epsilon$  be taken to denote “Young’s Modulus,” and  $\alpha$  the mean distance between the centres of two adjacent molecules,  $\epsilon \times \alpha^2$  is in the case of most metals approximately a constant. From this it would follow that the law of force proved by Maxwell in his experiments on the viscosity of gases<sup>4</sup> to exist between the molecules of a gas is approximately true for solids, accordingly the force between any two adjacent molecules of a solid is approximately as the fifth power of the distance between their centres. Now if we denote the atomic mass by A, the density by  $\Delta$ , the thermal capacity per unit mass by  $C_m$ , and the thermal capacity per unit volume by  $C_v$ , we have the following relations:—

$$C_m \times A = \text{a constant};$$

$$C_v = \Delta \times C_m;$$

$$\epsilon \times \alpha^2 = \text{a constant};$$

$$\alpha \propto \left(\frac{A}{\Delta}\right)^{\frac{1}{3}}$$

From these relations we obtain—

$$\frac{\epsilon}{C_v^{\frac{1}{3}}} = \text{a constant};$$

or that the cube of “Young’s Modulus” varies as the seventh power of the thermal capacity per unit volume. This relation was found to hold approximately not merely for the metals here

examined, but also in the case of a great many substances for which the values of  $C_v$  and  $\epsilon$  have been determined by other investigators.

Still more approximately it is believed that this relation would hold good if for “Young’s Modulus” the bulk-modulus of elasticity were substituted. Denoting the bulk-modulus by  $\epsilon_v$ , it was found that, within the wide limits of error to which determinations of the value of the bulk-modulus are liable to be affected—

$$\frac{\epsilon_v}{C_v^{\frac{1}{3}}} = \text{a constant.}$$

Neither of the above relations can be true for all temperatures, inasmuch as, whilst the value of  $\epsilon_v$  diminishes with rise of temperature, that of  $C_v$  increases, but at ordinary temperatures it seems that the bulk-modulus of elasticity can be calculated from the thermal capacity per unit volume by the formula—

$$\epsilon_v = 2071 \times 10^6 C_v^{\frac{1}{3}}.$$

The thermal capacity per unit volume increases with the temperature, and the researches of Matthiessen, Fizeau, and others on the one hand, and of Kohlrausch on the other, have shown that there is a like increment in the thermal expansibility and torsionability<sup>5</sup> of metals. A careful comparison was made of the various increments above mentioned, and it is shown in the paper that whilst the ratio of increase per unit of expansibility with rise of temperature to corresponding value in the case of torsionability<sup>5</sup> is, within the limits of error of observation, unity, that in which thermal expansibility and thermal capacity are concerned is about two, so that the rate at which thermal expansibility increases with the temperature is about twice the rate at which thermal capacity increases. The rate of increase of both thermal expansibility and thermal capacity varies with the nature of the metal, being greatest for iron and least for platinum.

The so-called “real thermal capacity” of a solid may be found by dividing the thermal capacity of hydrogen per unit mass at constant volume, namely, 2.417, by the atomic mass; and this part of the capacity will be independent of the temperature. If the “real capacity” be subtracted from the total thermal capacity we obtain that part of the capacity which does vary with the temperature, and which has therefore in this paper been designated the “variable thermal capacity.” The following table shows that the rate of increase per unit of thermal expansibility is at 0° C., and therefore at any temperature, equal to the increase per unit of the “variable capacity”:—

Metal	Rate of increase per unit at 0° C. of “variable thermal capacity” = C	Rate of increase per unit at 0° C. of thermal expansibility = E	E/C
Iron ...	.00230	.00309	1.34
Tin ...	.00216	.00250	1.16
Aluminium ...	.00197	.00215	1.09
Lead ...	.00192	.00174	0.91
Copper ...	.00127	.00196	1.54
Zinc ...	.00157	.00170	1.09
Silver ...	.00135	.00155	1.13
Platinum ...	.00064	.00067	0.95

It is shown in the paper that the thermal capacity per unit mass is nearly two and a half times the “real capacity,” so that only two-fifths of the whole thermal energy which we may impart to a mass of metal goes towards raising the temperature, the remaining three-fifths being expended in internal and external work. The external work is practically insensible in ordinary cases. Of the internal work, that expended against bulk-elasticity amounts in the limiting cases from 1/1,000th to 1/10,000th of the whole, and, though greater than the external work, is almost insensible; moreover, there seems to be no relationship whatever between the whole thermal capacity per unit volume and the work done against bulk-elasticity.

Raoul Pictet has concluded<sup>6</sup> that the amplitude of the oscillation of molecules around their positions of equilibrium may be taken as corresponding to temperature, and in the case of several metals has shown that

$$T \times \rho \times \alpha = \text{a constant,}$$

<sup>1</sup> The inverse of “simple rigidity.”

<sup>2</sup> Iron and copper are the only two metals for which the increase of torsion ability with rise of temperature has been examined.

<sup>3</sup> NATURE, 1870, p. 356.

<sup>4</sup> The original title of the paper has been altered to the above, as being more exact in expression  
<sup>5</sup> *Phil. Trans.* part i., 1883, p. 1.  
<sup>6</sup> *Loc. cit.* p. 39. <sup>7</sup> *Phil. Trans.* 1866, vol. ccxvi. part i.

where  $T$  is the melting-point temperature reckoned from absolute zero,  $\beta$  the coefficient of linear expansion, and  $a$  proportional to the distance between the centres of adjacent molecules. From the above relation, combined with those already mentioned, we deduce

$$\frac{T \times \beta}{C_p \cdot a} = a \text{ constant};$$

and

$$\frac{T \times \beta}{e \cdot a} = a \text{ constant.}$$

The first of these two relations was found to hold good for ten out of twelve metals examined, but for the metals bismuth and antimony the ratio  $T\beta : C_p \cdot a$  is almost exactly *one-half* of the ratio obtained for the other metals. It was concluded that for most metals the melting-point temperature may be approximately calculated from the formula—

$$T = 0.2253 \times \frac{C_p \cdot a}{\beta}.$$

Where  $C_p$  and  $\beta$  represent the mean thermal capacity per unit volume, and coefficient of expansion respectively between  $0^\circ \text{C}$ . and  $100^\circ \text{C}$ .

The second of the two relations was found also to approximately hold good.

In the paper will be found a full discussion of the experiments of Joule<sup>1</sup> and Edlund<sup>2</sup> on the thermal effects produced by mechanical stress in metals.

According to the researches of the latter the *observed* thermal effects of longitudinal stress on a wire is to be found by dividing the *theoretical* thermal effects by 1.61, since part of the work expended on a wire which is stressed longitudinally finds its equivalent in molecular effects which are not thermal. This view seems to be partly supported by some experiments made by the author on the viscosity of metals.

**Zoological Society, June 17.**—Prof. W. H. Flower, President, in the chair.—Mr. H. Seebohm exhibited and made remarks on some specimens of rare Asiatic and European birds, and called special attention to examples of a newly-discovered Russian species, *Bonasa griseiventris* (Menzies).—Mr. Selater exhibited the knob of the culmen of the beak of a Rough-billed Pelican (*Pelecanus*), which had been shed by the bird in the Society's Gardens last autumn; and called attention to the fact that on coming into breeding plumage again this summer the bird had grown another knob.—Mr. Selater also called the attention of the meeting to a very singular habit of a Vasa Parrot (*Coracopsis vasa*), as observed in the Society's Gardens.—Mr. F. Holmwood gave an account of his observations on the employment of the *Remora* by native fishermen of Zanzibar for the purpose of catching turtle and large fishes.—Mr. R. Bowdler Sharpe read some further notes on the new Corsican Nuthatch (*Sitta whiteheadi*), in continuation of former communications on the same subject.—A communication was read from Dr. G. Hartlaub, in which he gave the description of a new species of Creeper of the genus *Salpormis*, discovered in Eastern Equatorial Africa by Dr. Emin Bey. The author proposed to name it (after its discoverer) *Salpormis emini*.—Prof. Flower, F.R.S., read a note on the names of two genera of Delphinidæ, which he found it necessary to change.—A communication was read from Dr. Camerano, giving a summary of the distribution of the native Batrachians in Italy.—Mr. G. A. Boulenger gave the description of a new variety of lizard of the genus *Lacerta* from South Portugal, which he proposed to describe as *Lacerta viridis*, var. *gadovii*.—A communication was read from Mr. H. O. Forbes, containing remarks on a paper by Dr. A. B. Meyer on a collection of birds from the East-Indian Archipelago, with special reference to those described by him from the Timor-Laut group of islands.—Lieut.-Col. C. Swinhoe read a paper on some new and little-known species of butterflies of the genus *Teracolus*. The author referred to and described twenty-two species, sixteen of which were new to science, and the others very rare.—A communication was read from Mr. Francis Day, F.Z.S., on the occurrence of *Lumpenus lumpetrijformis* off the east coast of Scotland.—Mr. Oldfield Thomas read a paper upon the Muridæ collected by M. Constantin Jelski, near Junin, in Central Peru, during the years 1870-73. The collection consisted of ninety-two specimens, representing twelve species, mostly belonging to the genus *Hesperomys*, the nine sub-genera of which were now

arranged and re-defined. One species and two varieties were described as new under the names of *Rheithrodon pictus*, *Hesperomys laticeps* var. *nitidus*, and *H. bimaculatus* var. *lepidus*.—A communication was read from Mr. W. E. Distant describing the Rynchota collected by the late Mr. W. A. Forbes on the Lower Niger. The collection contained examples of twelve species, eleven of which belonged to the Hemiptera and one to the Homoptera. Two species appeared to be undescribed.—Prof. Mivart, F.R.S., read a paper on the development of the individual and of the species as forms of instinctive action.—This meeting closes the present Session. The next Session (1884-1885) will commence in November next.

**Geological Society, June 11.**—Prof. T. G. Bonney, F.R.S., President, in the chair.—Charles Edward Bainbridge, John J. Evans, William Frederick Fremersdorff, and Henry de Morgan Snell, were elected Fellows of the Society.—The following communications were read:—The range of the Palæozoic rocks beneath Northampton, by Henry John Euston, F.G.S.—On some Zaphrentoid corals from British Devonian beds, by A. Champernowne, M.A., F.G.S.—On the internal structure of *Micrabacia coronula*, Goldf., sp., and its classificatory position, by Prof. P. Martin Duncan, M.B. (Lond.), F.R.S., F.G.S.

**Anthropological Institute, June 10.**—Prof. Flower, F.R.S., president, in the chair.—A paper was read on the deme and the horde by A. W. Howitt, F.G.S., and the Rev. Lorimer Fison, M.A., in which the authors traced a close resemblance between the social structure of the Attic tribes and that of the Australian aborigines. The word horde is used to indicate a certain geographical section of an Australian community which occupies certain definite hunting-grounds. Its members are of different totems; in fact all the totems of the community may be represented in any given horde. Descent being through the mother as the general rule, the child is of its mother's totem, not of its father's, but it belongs to the horde in which it was born. So, too, the children of aliens are admitted into the exclusive organisation by virtue of a right derived from their mothers. In Attica there were also two great organisations—one based originally on locality, and another whose sole qualification was that of birth—the demotic and phratric. Both included the free-born citizens, and therefore coincided in the aggregate, but no deme coincided with any phratra, or with any subdivision of a phratra. The naturalised alien was enrolled in one of the demes, but there could be no admission for him into a phratra; if, however, he married a free-born woman his children by her were not excluded, they were enrolled in her father's phratra, the relationship between a child and its maternal grandfather being looked upon as a very near tie of blood. Thus, making all necessary allowance for difference of culture in the two peoples, it appears that the phratric is analogous to the social organisation in Australia, while the demotic divisions correspond to the Australian hordes.—A paper by the Rev. C. A. Gollmer, on African symbolic language, was read, in which the author described the method by which the natives of the Yoruba country send messages to one another, and communicate their wishes by a variety of tangible objects, such as shells, feathers, pepper, stones, coal, sticks, &c.

#### EDINBURGH

**Royal Society, June 16.**—Dr. Saug, Vice-President, in the chair.—The Astronomer-Royal for Scotland communicated a paper on micrometrical measures of gaseous spectra, which was accompanied by several elaborate maps of the spectra examined. The instrument used gave a dispersion of 1200 degrees. Among several curious results indicated was the fact that the spectrum of nitrogen indicates it to be a compound, while oxygen and hydrogen act as if simple substances. Prof. Smyth also gives the spectra of carbon-oxygen and carbon-hydrogen compounds.—Dr. Saug read a paper on the computation of recurring functions, by the aid of chain-fractions.—Prof. Tait communicated a note by A. H. Auglin on an extension of Euclid I. 47. Mr. Auglin showed how, by regarding equiangular and equilateral polygons described on the sides of a right-angled triangle as being composed of equal isocles triangles the methods of Euclid's First Book might be used to prove the 47th Proposition as extended to equiangular and equilateral polygons.—W. E. Hoyle gave a paper on the Ophiuroidea of the Faroe Channel.

#### PARIS

**Academy of Sciences, June 23.**—M. Rolland, President, in the chair.—Researches on the origin and transformations of the

<sup>1</sup> *Phil. Trans.* 1859, vol. cxlix, p. 91.

<sup>2</sup> *Ann. der Phys. und Chemie*, Band cxxvi, p. 539.

nitrate universally present in the vegetable kingdom, by M. Berthelot. From his experiments the author infers that the nitrates, derived partly from the soil, partly from the atmosphere, are found chiefly in the stems of plants, varying from almost infinitesimal quantities to 15 thousandths in the potato, 28 thousandths in wheat, and even 150 thousandths in certain species of *Amaranthus*.—Report on the documents, published by the Minister of Public Works, connected with the mission undertaken by Lieut.-Col. Flatters to the region south of Algeria, by M. Daubrée. The object of this mission, carried out in the winter of 1880-81, was to ascertain the possibility of constructing a railway across the Sahara, between the French possessions on the Mediterranean and the Atlantic. As far as the Asiatic wells, the extreme point so far reached, no serious obstacle was met, and for over 350 miles to the south of Wargla, the ground was found to be so easy that a line might be constructed to this point at an outlay of about 4000*l.* per mile.—Arithmetical commentary on a formula of Gauss (continued), by M. de Jonquières.—Report of the Suez Canal International Committee, meetings of June 16 and 19, communicated by M. de Lesseps. The Committee pronounces in favour of simply widening the Canal in preference to constructing another.—Election of Dr. Salmon as Corresponding Member for the Section of Geometry in place of the late Mr. Spottiswoode.—Report on two cases of secondary suture of the central nerve attended by rapid restoration of the functions of the nerve in the paralysed parts, by M. Tillaux.—Remarks on some phenomena of chemical occlusion: occlusion of one gas by another, by M. P. Schutzenberger.—On a new method of synthesis of nitrous organic compounds; complete synthesis of xanthine and methylxanthine, by M. Arm. Gautier.—Researches on the formation and structure of the gray embryonic substance in the spinal marrow of the higher vertebrate animals, by M. W. Vignal.—Description of the *Calocoris*, an insect of the genus *Phycoris*, which infests the vine and young grape, by M. G. Patrigeon.—Note on a generalisation of the theory of reduced quantities, by M. Em. Barbier.—Remarks on the height and annular form of the mountains on the planet Venus, by M. P. Lamey. From a careful study of a series of designs of the planet executed at Grignon during the present year, the author infers that a perfectly circular protuberance in the southern hemisphere, presumably a volcano, has an elevation of probably not less than seventy miles. He argues that this enormous height is in no way incompatible with the volcanic nature of the planet.—Description of a new mercurial electro-dynamometer, by M. G. Lippmann.—A study of the spheroidal state of fluids and their freezing-point under pressure, by M. J. Luvini.—Note on the glyoxalbisulphites of potassa and baryta, by M. de Forcrand.—Researches on ferricopotassic tartrate, ferric arseniate, arsenite of iron, and other colloidal sulphates of iron, by M. E. Grimaux.—A comparative study of the alcohols derived from the xylic carburets, by M. A. Colson.—Remarks on the natural salt-petres of Chili and Peru, in connection with rubidium, caesium, lithium, and boric acid; practical application to the beet-growing districts in the North of France, by M. Dieulaufait.—Distribution of the saline substances of the grist in the various products of the corn-mill, by M. Balland.—Note on the poison of the Hymenoptera, and anatomical description of their secreting organs, by M. G. Carlet. The author concludes that the poison of these insects is always acid; that it is composed of two distinct liquids, one extremely acid, the other slightly alkaline; and that these two liquids are secreted by two special glands, the *acid* and the *alkaline* glands, which discharge their contents at the base of the gorgonet, or sheath of the sting.—On a new type of elastic fibre observed in the larva of *Eristalis*, by M. H. Viallanes.—On the development of the digestive tube of the *Limacæ*, by M. S. Jourdain.—Note on the Geological Map of France, scale 1 : 500,000, prepared by MM. G. Vasseur and L. Carez. This map, the first executed since 1842, will be completed in forty-eight sheets early next year. Several of the sheets have already gone to press.

## BERLIN

**Physiological Society**, May 30.—Dr. Falk has, in the course of an investigation of the phenomena of death by drowning, determined experimentally certain relations of the cutaneous nerves to respiration for which he claims a manifold practical importance. When rabbits are suddenly plunged into cold water of about 5°-7° C. a cramp of the expiratory muscles occurs, and respiration ceases in the position of expiration. This effect of

cutaneous stimulation occurs even when the superior laryngeal nerves have been cut through. The recognised relation of the trigeminus to expiration, which manifests itself in the occurrence of sneezing upon stimulation of the nasal mucous membrane, was also confirmed in these experiments; when the face only was dipped into the cold water the expiratory cramp was very violent, whereas the sudden immersion of the hinder extremities and of the lower part of the body was inoperative, the effect not being produced till the breast and the neck were stimulated. The respiratory track of the larynx was the only part of it that was affected, when the face was not immersed, but the glottis closed completely when the trigeminus was stimulated. When the cutaneous nerves were more powerfully stimulated so that pain occurred, a violent inspiration set in. The methods of restoring persons apparently dead and still-born children to life have, according to Dr. Falk, no relation to the effect of cutaneous stimulation upon respiration; the dashing of cold water upon the chest acts upon the heart alone, and the pouring of water on the nape of the neck and back of the head acts upon the medulla oblongata.—Dr. A. Baginski, who had previously discovered the occurrence of xanthine bodies in the urine of children who were affected with nephritis, has followed up the occurrence of these substances, and has determined, by comparative examination of healthy and sick children, that xanthine occurs only in nephritis; and that the quantity of it present increases proportionately with the malignity of the attack. The circumstance that methyl xanthine resembles theobromine in its chemical composition suggested an examination of the tea, in which considerable quantities of guanine, xanthine, and hypoxanthine were detected. In the pancreas when putrefying the amount of xanthine substances were diminished, and of these guanine was the one of which, proportionally, most was destroyed by putrefaction. Next came xanthine, and hypoxanthine had the greatest powers of resisting putrefaction. The presumption that hypoxanthine would not even be destroyed by digestion was not borne out. After exhibition of hypoxanthine the quantity that occurred in the urine was not above the normal but rather a little below it. Its effect upon the heart was a very remarkable one, it occasioned much more active and energetic contractions, so that hypoxanthine may be regarded as a body which has the power of increasing the cardiac activity, and perhaps it is to this that the beneficial effect of tea-drinking may be attributed. Dr. Baginski intends to follow up the investigation of these interesting substances further.

## CONTENTS

PAGE

Cholera at Toulon . . . . .	213
The Earth as a Globe . . . . .	214
Practical Botany . . . . .	214
Letters to the Editor:—	
Chalk and the "Origin and Distribution of Deep-Sea Deposits."—Dr. J. Gwyn Jeffreys, F.R.S. . . . .	215
Protoplasmic Continuity in Plants.—Thomas Hick . . . . .	216
Aseismic Tables for Mitigating Earthquake Shocks.—W. Topley . . . . .	216
Black Rain.—Dr. W. J. Treutler . . . . .	216
A Cannibal Snake.—Edwin H. Evans . . . . .	216
Peronospora infestans.—J. L. Bozward . . . . .	216
Kephir . . . . .	216
Henry Watts, F.R.S. . . . .	217
Geology at the British Association . . . . .	217
Primary Education at the Health Exhibition. By Wm. Lant Carpenter . . . . .	218
Work-Measuring Machines. ( <i>Illustrated</i> ) . . . . .	220
Notes . . . . .	221
The Composition of Chlorophyll. By C. A. Mac-Munn . . . . .	224
Recent Morphological Speculations, II. . . . .	225
The Royal Society of Canada . . . . .	227
The Rains and the Recent Volcanic Eruptions. By M. Gay . . . . .	229
Experiments on the Passage of Electricity through Gases—Sketch of a Theory. By Arthur Schuster, Ph.D., F.R.S. . . . .	230
University and Educational Intelligence . . . . .	232
Scientific Serials . . . . .	232
Societies and Academies . . . . .	234

THURSDAY, JULY 10, 1884

## THE CHOLERA GERM

AT the present moment when the Continent has again become the battle-field between cholera and the human race, all questions concerning the cause, diffusion, and prevention of the cholera virus must take a prominent place in the deliberations on the best sanitary measures to be adopted in combating this insidious foe. Almost all practical preventive measures in this country and on the Continent as regards cholera and other infectious maladies are based on the assumption—supported by a good deal of evidence both theoretical and practical—that the virus is particulate, and, as indicated by its self-multiplication within the affected person, is a living organism. But the nature of this supposed organism of cholera has, until quite recently, been altogether mysterious. As is well known, Prof. Koch and colleagues, sent out last year by the German Government to investigate the cholera in Egypt and India, have ascertained that in the rice-water stools voided by patients suffering from the disease there are present, besides micrococci and bacilli common to the evacuations of other than cholera patients, peculiar curved bacteria, so-called “comma-shaped” bacilli, which Koch has not been able to discover in any cases of diarrhoea. These “comma-shaped” bacilli Koch has succeeded in isolating by artificial culture. Unfortunately cholera has hitherto not been found transmissible to the lower animals, and therefore the function of these “comma-shaped” bacilli must at present remain unknown. All we can therefore say is that Koch has shown that in cholera evacuations there exist, besides micrococci and straight bacilli, other organisms also characterised by this—that they are curved or comma-shaped. Whatever else has been said by Koch, his followers, and critics, scientific and daily papers, as to these “comma shaped” bacilli being the cause of cholera, is simply and purely a supposition, which, as we shall presently show, is wanting in the most essential elements.

First and foremost, Koch has been unable to find anything of this “comma-shaped” bacillus in the blood or tissues in any stage of cholera. Now all experience on cholera teaches that, whatever its cause may be, the alimentary canal is not the only passage through which the cholera-poison enters the system, but that its entrance through the respiratory organs is also an established fact. For this reason it is necessary to assume that, as in other infectious diseases, it passes in the stage of incubation of the disease through the blood and system. The symptoms of cholera, the whole nature of the disease, shows that it is not a local distemper of the alimentary canal, but that the latter is merely a symptom of the malady, as much as in typhoid fever the distemper of the ileum and spleen, or in scarlatina that of the skin, throat, and kidney. Had Koch found the “comma-shaped” bacillus in the blood or the tissues, *e.g.* the blood-vessels of the alimentary canal, mesenteric glands and spleen, the nature of this “comma-shaped” bacillus would have been as obscure as ever, but still there would have been some sure element in the chain

VOL. XXX.—NO. 767

of surmises. Of course it might be argued, and as a matter of fact it is argued by Koch in the reports to his Government, that the bacillus, having found entrance into the cavity of the intestines, there multiplies, and produces some ferment, which, absorbed into the system, sets up the whole chain of appearances constituting the symptoms of cholera. This is quite possible, and to a certain limited extent is borne out by experience, notably in the case of putrid or pyæmic poisoning, where, owing to the presence of putrefaction in a wound, the products of putrefaction—the sepsin—absorbed in sufficient quantities into the system, create the above disease, often terminating fatally. In this case no specific organisms are detected in the blood or tissues; their presence is limited to the wound only, and their effect is merely this, that some ferment—ptomaine or some other substance—produced by them is absorbed into the system.

That this should also be the case in cholera is, as we just said, possible, but it is not probable, for the simple reason that the cholera virus in a large percentage of cases enters the system by the respiratory organs, and therefore it must be assumed in these instances to pass into the general circulation, and consequently, if it is to be identified, must be identified in the blood or tissues.

The practical consequences of an assumption that the cholera-virus passes into the system exclusively by the alimentary canal, and that it has its breeding-ground in the latter only, are so great, that before acting on such an assumption the basis for it ought to be established, which it certainly is not.

Secondly, is it a well-established fact that this “comma-shaped” bacillus is present only in cholera evacuations? If it should be found that this bacillus is absent from the alimentary canal in all other diseases, then we could at best recognise it as pathognomonic, but it by no means follows that it is also pathogenetic.

I have lately had the opportunity of inspecting this “comma-shaped” bacillus in specimens prepared by Koch, from the rice-water evacuations, and also in artificial cultures, and I have fully convinced myself of its reality. But I possess prepared specimens of evacuations of patients suffering from severe diarrhoea (in an epidemic outbreak of diarrhoea in adults in Cornwall in the autumn of 1883, and investigated by Dr. Ballard, Inspector to the Local Government Board), in which specimens, besides micrococci and straight bacilli, there are undoubtedly present bacteria which, in shape and size and mode of staining, so closely resemble the “comma-shaped” bacilli of cholera that I am unable to discover a difference between them. I have, however, not made any artificial cultivation of them, and therefore cannot say whether there exist any differences between the two, notably as regards their mode of growth.

Here is one other point to which we wish to draw attention: as Cohn (*Beiträge zur Biologie der Pflanzen*, Heft ii.) has shown, and as is now generally accepted, a rod bacterium which is characterised by being curved is regarded not as a bacillus but as a vibrio; and it is not quite clear why, unless for the sake of novelty, Koch, generally accepting Cohn's terminology, should in the case of the cholera bacterium have deviated from it, and should not rather have spoken of it as a

M

vibrio, because a vibrio, and particularly a *Vibrio rugula* (sp. Cohn), is the organism which he describes as a "comma-shaped" bacillus.

E. K.

SULLY'S "OUTLINES OF PSYCHOLOGY"

*Outlines of Psychology, with Special Reference to the Theory of Education.* By James Sully, M.A. (London: Longmans, Green, and Co., 1884.)

AT the present time no one is so well qualified as Mr. Sully to write in the English language a text-book of psychology. Himself not committed to any of the systems of philosophy, he is unsurpassed in his knowledge of all, while we do not think it is too much to add that there is no one in this country who can be said to equal him in his acquaintance with the literature of pure psychology. Moreover, the weight of his information is ably balanced by that of his judgment, and therefore we were prepared to expect that in the often difficult task of drawing the lines between philosophy and psychology, he would furnish in this text-book and in this particular a brilliant example of scientific discrimination. After having carefully read his work with this consideration before our mind, we are glad to allow that our expectation has been fully realised, so that in no case can we say that we have found a philosophical theory doing duty for a psychological fact, or a psychological doctrine unduly coloured by the use of any philosophical spectacles. And this carefulness of method is the more creditable to the author, inasmuch as he nowhere avoids pointing out the relations in which this and that truth of psychology stands to this and that system of philosophy.

The work, which runs to about 700 pages, is conveniently arranged in large and small print paragraphs, with headings in large type, while copious foot-notes give references to all the more important literature on each point as it arises. "Outlines of Psychology" is thus a treatise well adapted to fulfil one of the most important functions of a text-book, viz. that of reference. But the main object which Mr. Sully has in view is that of supplying a text-book for educational purposes, and in order to further its usefulness in this respect he systematically travels beyond the "outlines of psychology" in seeking, as he says in the preface, "to give a practical turn to the exposition by bringing out the bearings of the subject on the conduct and cultivation of the mind. With this object I have ventured here and there to encroach on the territory of logic, æsthetics, and ethics, that is to say, the practical sciences which aim at the regulation of mental processes. Further, I have added special sections in a separate type dealing with the bearing of the science on education."

It will thus be seen that the work is designed to meet the wants of divers classes of readers—teachers as well as students, and professed psychologists as well as beginners. But, owing to the arrangement of the subject-matter and to the employment of different kinds of type, confusion between the several objects which the writer has in view is avoided, while each class of reader can immediately find what it is intended that he should read. For our own part we have found profit in not skipping anything; there is advantage to be gained by reviewing even the elementary truths of psychology when these are so clearly marshalled in logical order.

If we were asked to indicate in what one respect more than another the present text-book of psychology differs from its predecessors, we should say that it does so in giving prominence to the principles of development. Without expressly espousing the theory of evolution, Mr. Sully carries through his exposition a latent reference to it, and clearly shows that he considers one of the most important duties of the present-day psychologist to be that of tracing on the one hand the probable influences of heredity upon mental constitution, and on the other the historical order of events in the psychogenesis of the individual. This leads him to assign a prominent place to the literature which of late years has joined the philosopher to the sect of baby-worshippers; and it is evident, from the number of original observations which are scattered through the book, that Mr. Sully must himself have spent no small amount of time and devotion at the shrine. Here is one of his experiences, in which "a little girl of 4½ years once drove her mother to one of the most difficult problems of philosophy." On asking why a wasp could not hurt a window-pane with its sting, and on being told in answer, "Because the window-pane has no nerves and so is not able to feel," the child perplexed the learning of the household by asking—"Why do nerves feel?" We quote this little incident in order to cap it with one of a still more embarrassing kind, which we were told a short time ago. Another little girl of the same age was silently watching her father write his sermon, and after protracted observation put to him the somewhat difficult question—"Papa, does God tell you what to write in a sermon?" With some little hesitation our clerical friend replied in the affirmative, whereupon he was ignominiously nonplused by the further question—"Then, papa, why do you scratch it out again?"

Where so much work has been so well done, the function of criticism would be an ungracious one. Nor, indeed, is it an easy thing to pick, and still less to find, a hole in Mr. Sully's armour. The most important of the doctrines which we are disposed to question is the one which says, "In later life we rarely if ever judge without making a verbal statement or proposition externally or internally" (p. 392). This doctrine is no doubt one that is very generally accepted, but it appears to us, with as little doubt, absolutely untrue. Unless we limit the term Judgment to the very act of Predication (in which case the term is divested of all its distinctive meaning), it appears to us as obvious as anything can be that in order to form a judgment there is no need to frame a proposition. Thus, for instance, to adopt Mr. Sully's illustrations, whether by an immediate act of observation I judge "This rose is blighted," or conclude from certain signs in the sky that it is going to rain, in neither case is it necessary for me to clothe the judgment in words, "externally or internally" spoken. The *judgment* (as distinguished from the statement of it) is in both cases formed quite independently of speech, in the same manner as are the so-called "practical judgments" of infants and animals. But not only so. Even with respect to the more elaborated judgments which belong to what Lewes called "the logic of signs," we do not believe that, when once the needful structure of conception has been erected by the scaffolding of verbal signs, it is then always necessary to revert to this scaffolding every time that the conceptions are required for the

purposes of a judgment. The finished conceptions are known to be standing, as it were, already built, and do not require to be mentally named, or newly reconstructed, in every act of thought. And similarly with respect to propositions, although we cannot doubt, from inquiries which we have made, that some eminent thinkers habitually employ the "*verbum mentale*" in the mechanism of their thinking much more than others equally eminent, yet we do not believe that any man who ever thought was in any large measure really dependent upon this *verbum*. Indeed it appears evident that in all cases that mental seizure of perceived relations, in which an act of judgment as such consists, must be prior to the statement of the act, whether internally or externally. No doubt the statement may serve in many cases to give clearness and precision to the judgment after it has been formed; but even here we are convinced that some thinkers are much less dependent upon this artificial assistance than others. In some minds whole trains of conscious reasoning upon matters of the most abstruse kind may pass without a single act of predication being performed, until the necessity arises for considering how these trains of reasoning may be expressed to other minds.

We have dwelt upon this point, because it is one to which we should like to see the attention of our psychological readers directed. But we may now conclude by saying that every one who desires to have his information on psychological matters brought up to date ought to procure this excellent text-book. It must have involved immense labour on the part of its author, and the result is one which deserves the substantial gratitude of the public.

GEORGE J. ROMANES

#### OUR BOOK SHELF

*Numerical Exercises in Chemistry.* By T. Hands, M.A., Science Master in Carlisle Grammar School. (London: Sampson Low and Co., 1884.)

THERE are now several of these small books of questions in chemical arithmetic before the public, and although serving a very useful purpose, the tendency to run into purely arithmetical exercises with a flavour of chemical connection or application is apparent to a greater or lesser degree in all of them. This is to be regretted, as there is plenty of room for purely chemico-arithmetical problems and questions. And then again it is not desirable that more time than necessary should be taken up by the chemical student in solving arithmetical problems, seeing the immense amount of work to be done by the chemical student before he attains to a very moderate knowledge of the subject. We have an ever-increasing number of students who pass elementary and advanced examinations but who are completely fixed by problems in practical or theoretic chemistry whose solution demands only a knowledge of the fundamental properties of the elements and the effects of mass or temperature. The questions in this little book are varied and not too numerous in any one section, and should be useful as leading up to chemical thinking.

*Chimie Elementara. Partea I. Metaloide.* By Prof. Licherdopol. (Bucharest, 1884.)

THIS is a text-book in use in the technical school in Bucharest, and for an elementary work contains a very large amount of matter, and with the usual exception of having theoretical considerations in the early part of the book it is well arranged. The present part deals with the so-called non-metallic elements, which are arranged and

treated in order of valency. At the end of each section are questions and problems. The appendix contains some good tables for the qualitative testing for acids and non-metallic substances and on rational formulæ, both for mineral and organic substances. The work has a decidedly practical stamp, and should be well adapted for a technical school of a general character.

*Voyages of Discovery in the Arctic and Antarctic Seas and Round the World.* By Deputy Inspector-General R. McCormick, R.N., F.R.C.S. Two vols. (London: Sampson Low and Co., 1884.)

IT seems rather late in the day for Dr. McCormick to tell the story of the various voyages in which he took part, in two handsome and richly illustrated volumes. He is certainly extremely diffuse, and has evidently no idea of perspective and proportion. However, we can pardon much in a venerable officer who has done good service to his country and to science in his day, especially since his volumes contain much that is really valuable. Dr. McCormick was with Sir Edward Parry in 1827 in the attempt of the latter to reach the Pole from Spitzbergen. But the greater portion of the first volume is occupied with the journal he kept when serving as surgeon in Koss's Antarctic Expedition of 1839-43; curiously he mentions only once or twice the name of Sir Joseph Hooker, whose classical Antarctic and other Floras were the result of his exertions during the same expedition. The second volume is occupied with the account of a boat voyage by Dr. McCormick in search of Sir John Franklin, and with his own exceedingly minute autobiography. The student of science will find much to interest him in these volumes; the very large-scale illustrations of the forms of ice seen during the Antarctic voyage are of special value.

#### LETTERS TO THE EDITOR

[The Editor does not hold himself responsible for opinions expressed by his correspondents. Neither can he undertake to return, or to correspond with the writers of, rejected manuscripts. No notice is taken of anonymous communications.]

[The Editor urgently requests correspondents to keep their letters as short as possible. The pressure on his space is so great that it is impossible otherwise to insure the appearance even of communications containing interesting and novel facts.]

#### Science and the Sandhurst and Woolwich Examinations

AS one of a class of private tutors who, because they possess the secret of successfully preparing lads of moderate ability for the above examinations, are invidiously or ignorantly termed "crammers," I should like to say a few words on the subject of your excellent leader in NATURE of June 26 (p. 189).

With the opinions and suggestions therein propounded, I most cordially agree, and I believe they would be indorsed by every true friend of real education throughout the country. One or two of the facts connected with the table of percentages admit of an explanation founded on considerations besides those adduced by the writer, the exposition of which will, I think, tend to confirm still more the truth of the general conclusions arrived at. Thus the high percentage of success in French, both for Sandhurst and Woolwich, depends a good deal on the fact that it is compulsory for the preliminary examination in each case, a candidate naturally pursuing for his "further" examination, a subject which he has already partially acquired. It is, besides, notorious that this subject is highly marked.

Again, the percentage in the geography and geology for Sandhurst would not be so high were it not that a non-classical Sandhurst candidate generally pitches upon it as offering the easiest choice in the way of a fourth subject, because six questions in the paper are pure geography, a subject which is again obligatory for his "preliminary," while the geology, as the writer remarks, may perhaps be more readily crammed than any other scientific subject.

In the case of a Woolwich candidate who relies mainly on his mathematics, the necessity of a fourth subject is not so much



felt, and, besides, his mathematical tastes would naturally incline him, of the two, to take up electricity rather than geology.

It is lamentable to think that this radical change, by which science is virtually shelved, is solely due, as the Duke of Cambridge said, to a desire on the part of the authorities to eliminate the "crammers," and get boys passed into Sandhurst and Woolwich direct from the public schools.

Now, however desirable the approximation to such an ideal may be to the authorities, or even the public schools, it is very questionable whether it will prove equally desirable for the service, unless indeed means are taken to insure that the schools will do their work more efficiently than heretofore. This is scarcely likely to be accomplished by cutting science or even English literature out of the scheme, under the pretence that such subjects admit of being "crammed." The truth is that in these points the authorities have simply pandered to the present inability of the schools to teach these subjects successfully. Nor is it likely that the schools will be any more successful in the teaching of French and German up to the new standard, than they have been up to the old. In this, as in everything else, the tutors by the new scheme are really left masters of the situation.

Why do not the authorities accept what the Marquess of Salisbury maintained was inevitable so long as competitive examinations existed, and instead of attempting the impossible task of uprooting the tutor, place him on a recognised official footing, give him in place of the prestige which efficiently insures the maintenance of discipline at the large public schools, the protecting ægis of a few simple rules which every tutor would be obliged to enforce, and the breach of which would render the offender liable to be denied entrance into the service? This would correct the evils which are prevalent at some of our larger army "coaching" establishments, and then there need be no reason for the pretence under which a candidate is supposed to be better fitted for life by a total ignorance of science and the literature of his own country, in lieu of which, like a parrot, he has been taught to chatter one or two foreign languages.

Tunbridge Wells, July 1

E. DOUGLAS ARCHIBALD

#### Animal Intelligence

HAVING noticed some time ago a number of letters in NATURE on the above subject, I venture to publish an instance, which came under my own observation last month, of extraordinary intelligence in a rat. I was standing in the doorway of a large shed, the further end of which had been partitioned off with bars to form a fowl-house, when I was attracted by a gnawing and scraping noise; turning round I saw a rat run from a large dog-biscuit which was lying on the floor, and pass through the bars. Being curious to watch if he would return, I kept quiet, and presently saw a well-grown specimen of the "common brown rat" (*Mus decumanus*) come cautiously forward, and after nibbling for a short time at the biscuit, drag it toward the bars, which are only two inches apart, and would not allow the biscuit to pass. After several unsuccessful attempts he left it, and in about five minutes returned with another rat, rather smaller than himself. He then came through the bars, and, pushing his nose under the biscuit, gradually tipped it on edge, rat number two pulling vigorously from the other side; by this means they finally succeeded in getting a four-inch biscuit through a two-inch aperture. Not feeling pleased that my dog's biscuits should be used as food for rats, I threw a hammer at them and picked up the biscuit.

I think the conduct of these animals showed a wonderful amount of intelligence; it was evident that the first rat saw that to get the biscuit through the bars it was necessary that it should be on its edge, and, not being able to tip it and pull at the same time, he gained the assistance of a friend.

The short space of time during which he was absent, and the concerted action, show also that they must have some wonderfully facile means of communicating ideas.

T. W. KIRK

Colonial Museum, Wellington, New Zealand, May

ABOUT twenty miles from this, in the town of Larne, there resides a gentleman in the possession of a cat, which is so great a favourite that every day a plate and chair are placed for her beside her master, whose repast she shares with supreme content.

One day for some reason the dinner was postponed, but the cat came in at the usual hour. She was evidently much discon-

certed at seeing nothing going on, walked once or twice disconsolately round the table, then disappeared. Shortly afterwards she returned with a mouse, which she laid on her master's plate, then going away, she came back a second time with a mouse, which she put on her own plate. She postponed further proceedings until her master returned, when she immediately began to purr and rub herself against his legs, as much as to say, "See how nicely I have provided for you."

Between this town and the village of Hollywood there is a country house which happened to take fire last week. The cat of the house, which had access to the servant-maid's apartments, ran up and pawed the young woman's face. Being very drowsy, the girl turned to sleep afresh. The cat, however, after some interval returned, and proceeded to scratch the girl's face to such purpose that she rose, and, smelling the fire, wakened the other members of the household, and the flames were extinguished.

A nephew of mine who is fond of cats generally keeps three or four, and by dint of pains and kindness teaches them a variety of tricks. I saw one of them sipping cream from a teaspoon, which it held between its two forepaws. I might relate quite a number of other particulars about cats, but do not like to trespass further on your space. The foregoing, along with the other details which I have already furnished, are perhaps not unworthy to be placed beside the interesting particulars narrated by the younger Cuvier and Mr. Romanes in reference to the intelligence of animals.

HENRY MACCORMAC

Belfast

#### Butterflies as Botanists

THE caterpillars of *Mechanitis*, *Dircenna*, *Ceratinia*, and *Ithonia* feed on different species of Solanaceæ (*Solanum*, *Cyphomandra*, *Bassovia*, *Cestrum*), tho' e of the allied genus *Thyridia* on *Brunfelsia*. Now this latter genus of plants had been placed unanimously among the Scrophularinæ, till quite recently it was transferred by Bentham and Hooker to the Solanaceæ. Thus it appears that butterflies had recognised the true affinity of *Brunfelsia* long before botanists did so.

There is yet another and more curious instance of our butterflies confirming the arrangement of plants in Bentham and Hooker's "Genera Plantarum." *Ageronia* and *Didonis* were formerly widely separated by lepidopterists, being even considered as constituting distinct families, but now they are to be found beside one another among the Nymphalines, and the structure of their caterpillars leaves no doubt about their close affinity. The caterpillars of *Ageronia* feed on *Dalechampia*, those of *Didonis* on *Tragia*. Now these two Euphorbiaceous genera were widely separated by Endlicher, who placed the former among the Euphorbiæ; the latter among the Acalyphæ; Bentham and Hooker, on the contrary, place them close together in the same sub-tribe of Plukenetiæ, and thus their close affinity, which had been duly appreciated by butterflies, has finally been recognised by botanists also.

FRITZ MÜLLER

Blumenau, Santa Catharina, Brazil, June 1

#### Christian Conrad Sprengel

WILL you allow me a short reply to Prof. Hagen's letter published in NATURE (vol. xxix. p. 572)? It is evident that Prof. Hagen's statements are very far from proving what he asserted in his former letter, viz. that between 1830 and 1840 Sprengel's discoveries were known to every student in Prussia, and I think it would be easy to any one resident in Germany to prove the contrary by simply confronting what the manuals of botany published at that time say about the fertilisation of flowers. Thus, as I learn from Delpino's "Ulteriori Osservazioni" (p. 88), Link ("Elem. Philos. Bot.," ii. 1837, p. 222) and Treviranus ("Physiol. der Gew.," ii. 1838, p. 343), both of whom, according to Hagen, were entirely acquainted with Sprengel's discoveries, adopt Cassini's erroneous view of the fertilisation of *Campanula* being effected through the collecting-hairs of the style instead of through the stigmatic papillæ; and this must have been almost impossible for any one acquainted with Sprengel's excellent account of *Campanula rotundifolia* ("Entdeckte Geheimniss," p. 109). What Prof. Kunth, in his lectures at the Berlin University, taught about the fertilisation of flowers may be seen in his "Lehrbuch der Botanik" (1847, p. 422). Almost every line contains errors splendidly and convincingly refuted by Sprengel. Thus he considers as contrivances serving

to aid the self-fertilisation of the flowers the collecting-hairs on the style of Campanulacæ and Compositæ (see Sprengel, pp. 109 and 370), the pollen-masses of Orchidæ and Asclepiadææ being fixed near the stigma (Sprengel, pp. 401 and 139), the movements of the stamens of Parnassia, Ruta, and Saxifraga (Sprengel, pp. 166, 236, and 242), as well as the movements of the stigmas of Nigella, Passiflora, and Epilobium (Sprengel, p. 280, 160, and 224). I do not know how to reconcile these errors with Prof. Hagen's statement that Kunth was "beyond doubt acquainted with the facts" discovered by Sprengel. He "beyond doubt" never read Sprengel's book, and I can explain those numerous and crass errors of one of the most celebrated botanists only by the assumption that at that time Sprengel had fallen into almost complete oblivion among German botanists, and remained so till, as Prof. Möbius justly remarks (NATURE, vol. xxix. p. 406), "the value of his treatise in its bearing on the theory of selection was first recognised by Charles Darwin."

FRITZ MÜLLER

Blumenau, Santa Catharina, Brazil, May 25

### Voracity of the Drosera

I AM not aware that the Drosera has been noticed to capture so large an insect as the dragon-fly, *Pyrrosoma nimum*. Passing a pond-side on a bright June morning, where this insect was flying plentifully, and near which *Drosera rotundifolia* was growing in abundance, I saw that many of these insects had fallen victims to the carnivorous propensities of the plant. On one spot about a foot square I counted six plants which had captured specimens of the dragon-fly, besides smaller insects. One plant had possessed itself of two of the dragon-flies, one being partially digested and the other freshly caught. The Drosera plants, being young, were in many instances less in expanse than the dragon-flies caught upon them, which measure about two inches across the wings, with a body about one inch and a half long. The dragon-flies appeared to be attracted to the plants by the reflected sunlight glistening upon the beads of fluid secreted from the leaves, and from which the plant receives its common name of "sun-dew." Those dragon-flies which I saw caught hovered over the plants about a second, at a distance of three or four feet, and then darted upon the plant, when they were instantly caught.

A. BALDING

Wisbech, July 3

### Lightning

AT this time of the year one commonly reads of persons being struck dead, blind, or senseless by lightning; some of the phenomena are very puzzling, especially in cases where persons are but slightly injured.

On June 6, 1881, I was in the open country near the sea between Gosport and Southampton, in a place where there was no shelter. Here I was suddenly overtaken by a violent storm of thunder, lightning, and rain. Before I had time to think of escape, the air became darkened by the pouring rain, and, to save myself from a drenching, I perhaps foolishly put up my umbrella; at the same instant I saw a blaze of fire on the right-hand side of my face; the thunder burst at the same moment, and a violent wrenching pain seized the fingers of my right hand (which held the umbrella), the pain instantly travelling to my elbow and shoulder, where it ceased. With the exception of a strong pain in the arm like rheumatism for the rest of the day, I felt no further ill effects.

There is a blind beggar sometimes seen about here who carries a label stating that his eyes were destroyed by lightning; there is no iris to either eye; both are quite white. One day lately I asked him how he lost his sight. He said that he was leaving a country public-house during a thunder-storm, and he received the blow from the lightning at the street-door, as he stood on the top of a short flight of stone steps. He could only remember seeing the blaze of the lightning, and being hurled to the ground down the steps into the street. On his senses returning, he was blind. He states that he had a little glimmering sight at the time of recovery, but first one eye and then the other soon became totally blind.

A few years ago several letters appeared in NATURE regarding the descent of balls of fire in thunder-storms. On July 5, 1881, whilst watching a storm from my windows at 11.30 p.m. I distinctly saw in the south a ball of fire drop from the clouds to the earth. The descent was rapid, but not comparable with

lightning, and with an inclination to the east. The ball appeared large, and about one-half or one-third the apparent size of the moon. A carpenter who was working for me at the time, Mr. George Hebb, on calling upon me a few days after the storm, told me (I had not previously mentioned the matter to him) that he had seen the descent of the same ball of fire from Mildmay Park whilst he was walking towards the south. It is the only example I have seen.

WORTHINGTON G. SMITH

### Solar Halo

ON Friday, June 27, about 5 p.m. my attention was drawn to a solar halo which lasted for about two hours from that time; the circular part of the halo was white, and about the size of an ice halo, the sun apparently about four times its proper size and of badly-defined outline; all within the halo was darker than the rest of the sky, and vertically over the sun there was about an octant of another circle (?) touching the first one, but prismatically though not brilliantly coloured. On Saturday night there was a strong pink glow from 9 to 9.30 in the north-north-west, with a greener sky near the moon, which was itself also somewhat green.

W. W. TAYLOR

### INSECT PESTS IN THE UNITED STATES<sup>1</sup>

THIS volume is issued under the auspices of the Department of Agriculture, and relates entirely to five insect pests. The book is full of matter of general as well as of purely scientific interest, and abounds in suggestions for checking and exterminating the pests of which it treats.

One rises from its perusal with a sense of thankfulness for our temperate climate, insularity, and moderate dimensions. These conditions are unfavourable to excessive multiplication of insect life; and hence we escape the locust, the canker-worm, and the palmer-worm, in their full devastating energy. The connection between solar activity and swarms of insects forms a special section; and the relation between sunspots and locust flights is drawn out in tabular form, showing a striking coincidence between special locust visitations and the minimum of sunspots. This is of course merely a scientific way of showing that hot summers breed insects. The Report deals with the Rocky Mountain Locust, the Western Cricket, the Army-Worm, Canker-Worm, and Hessian Fly, and the treatment of the subject is a full justification of the existence of such a Commission.

An Entomological Section of an Agricultural Department appears to be an absolute necessity in those vast regions, and the facts and phenomena are so startling as to be worthy of constant watchfulness, and this can only be secured by a special and permanent Commission. On the other hand, the powerlessness of man in dealing with the actual invading forces of the winged or creeping armies of Hexapoda is constantly exemplified. It is truly observed that the only effective method of dealing with insects is to study their habits, their structure, their weaknesses, their devolution. It is here that the entomologist shakes hands with the agriculturist. The cultivator is paralysed by the magnitude of the devastation, and the best he can do is to take such self-evident means as are at once available, such as burning, rolling, roping, or the like. The entomologist works less precipitately, but more surely, in studying the sexual and maternal habits of the *imago*, the conditions favourable to incubation, the hatching and development of the *larva*, the transformations to the *pupal* and perfect forms, and lastly, the food and habits of the mature insect.

All these and other matters are searched into by the State entomologist much upon the same principle as a Government section collects information as to the habits and resources of some nation with which it may at some time find itself at war. Thus the Entomological Commission

<sup>1</sup> "Third Report of the United States Entomological Commission. (Washington Government Printing Office, 1883.)"

of the United States collects information which may serve a purpose in a war of extermination against the objects of its studies. The volume contains a vast amount of practical information, an extensive series of microscopic sections, chiefly relating to the embryology of insects, zoographical maps of North America, and appendixes bearing upon the subject-matter of the volume. Each destructive insect is very fully treated of with regard to its biological relations, its distribution, ravages, and methods of prevention, all of which are of great interest. A middle section of the volume is occupied with matter which may be described as pure embryology, and deals with the deepest questions which await the microscopist or the biologist. Thus the formation of the blastoderm, endoderm, mesoderm, and inner germinal cells, the phenomena of invagination, the evolution of the brain and ganglionic chain, the philosophy of metamorphosis, and the origin of wings. These matters appear scarcely germane to an Agricultural Department, and it is by no means easy to see how the discussion of such problems can throw the least little ray of light upon economic entomology. Viewed as a pursuit after pure knowledge, and a deep diving after the great mystery of life, these chapters may be considered as a contribution to our speculative knowledge. As a part of an agricultural report they are as relevant as would be a disquisition upon a fourth dimension or molecular movements in solids. At p. 295 is a Genealogy of Insects (Hexapoda), tracing from the Thysanura, followed by a detailed but highly speculative theory of the origin of the Coleoptera and other insect types. "The primitive form of beetle was probably a Staphylinus-like form, with a long narrow body, and rudimentary elytra, and carnivorous in habit." Such speculations probably are useful to their originator chiefly. We do not in fact deny their biological interest, but they are misleading in such a report as that before us. It is no doubt difficult to draw the line between what is useful and what is not, but in loading an economic report with such matter a door is opened which could scarcely be shut against any biological problem whatever. And yet some sop must be thrown to the scientific inquirer enlisted in the service of a Commission. He perchance would mope and pine if too rigidly confined to the economic side without being allowed to express his views upon deeper and wider problems. There is abundance of matter congenial to the agriculturist in these pages. It would not be just in the limits of one short article to attempt to review all the subjects of interest brought within the covers of this volume. We select as an example of the work done by the Commission that familiar enemy of our race, the locust; and we trust room will be found in these columns for a second notice of this work. "If you avoid the destruction of locusts, you will have to forget the welfare of the people: which do you think ought to be thought of first? Was not therefore Tao-choon wise and good when he said 'in killing insects one saves men?' Good Tao-choon flourished in the reign of Tai-tzoon (dynasty Tan, from 627 ante till 649 post Christum), and he is still quoted in the Far West as an authority on locust destruction. So far back in point of time and so wide in point of distance do the Commission ransack for information, bringing all to bear upon this war. The Emperor Shen-tzoon's orders would not perhaps commend themselves entirely to the independent voters of the free States. Thus, "whenever locusts leave desert places to go to populated ones, the local chiefs are obliged to hire poor people and have the eggs destroyed. If all of them should not be destroyed, and the locust therefrom reappear the next year, those commanders will be punished with 100 bamboo-rod blows." Again, "Once the locust appears there is no writing to be done for excuses of absence of chiefs, &c.—paper won't help—the commander-in-chief must be present." Evidently high position in the reign of Shen-tzoon had its duties and responsibilities as well

as its privileges. The practical and relentless measures recommended are thus described in the same document. "For the purpose of burning the locusts one digs a ditch 5 feet deep and 5 feet wide and twice as long. One empties the bags into the fire. As soon as the locust is in, it won't jump out. That's what the poetry means by 'delivering them over to the flames.' Even in old times they knew that if you bury a locust he will creep out again. Therefore the destruction of locusts by fire, as they did in ancient times, is the best."

The Rocky Mountain locust (*Caloptenus spretus*) is one out of about 200 species of this prolific family represented in North America. If we run our eyes over the map of North America and set aside all that portion contained between meridians 103° and 117° W. of Greenwich, and from the parallels of latitude 40° to 53°, we have the "permanent home" of this insect well before us. It is all considerably elevated, treeless, and arid, thus agreeing to some extent with the locust areas of Eastern Europe, Northern Africa, Asia, Australia, and Central and South America. It includes the greater part of Kansas, Nebraska, Colorado, Wyoming, Utah, Dakota, Montana, Oregon, Nevada, and extends far southward into Mexico. It is bounded on the north by the tree-bearing regions of British America, on the east by the great wheat-bearing regions of the Eastern States, and on the west by the higher ranges of the Rocky Mountains. This gigantic area comprises 300,000 square miles, and the annual rainfall is under twenty inches. It is all elevated, dry, and bracing, and is known physically as the arid region. It is not a wheat-growing area. Here the locust finds a permanent home, free from diseases, and suitable for breeding, and it is from these regions that, about once in eleven years, or at the minimum period of sun-spots, excursions are made and devastation is wrought. Still, while the whole of the permanent region is favourable to the locust, there are in reality but few portions of it that are adapted to its greatest increase. The largest and by far the most important of these specially favourable areas is that of Central Montana and portions of the British Possessions immediately to the north. The next in importance is that of which the Snake River Valley is the centre, while a third locality is that of Southern Utah and parts of adjoining States. We must not pause to consider the prodigious and terrible armies with their devastating effects, "darkening the sun," and "piled up in 'windrows' for miles in length." Such narrations are highly entertaining, but may be "taken as read" by most of the readers of NATURE. With reference to the treatment of this evil, it is hoped that cultivation will restrict the breeding area gradually but surely, and that the changes of climate which follow the husbandman and timber planter may also act advantageously. The active methods consist in digging trenches, sweeping the locusts into them, and burning them. This is best done when the creatures are in a torpid condition at or before sunrise. Harrowing the ground and processes of cultivation are useful in destroying eggs and larva. The noise of musketry and artillery prevents swarms from alighting, and is frequently employed for this purpose, as are also fires with clump weeds thrown upon them so as to cause dense clouds of smoke. Marching locusts may be arrested by strips of tin resting against posts or nailed to walls, as they cannot climb over such smooth surfaces. Other methods are referred to as having been published in previous reports of the Commission, but on the whole the means proposed and adopted are of that simple sort which would be suggested rather by common sense than by any profound knowledge of the creatures' habits.

In this respect the Commissioners have been more fortunate in their study of some of the other insect pests. One correspondent writes with regard to locusts:—"They marched uninterruptedly through the village of Colberg (Cape Colony), over walls and houses, and

destroyed every green thing. The plague lasted for weeks, and until the insects obtained wings, when the winds soon after wafted them away to devastate the lower country, and the ocean received them. Any opposition seemed so hopeless that none was attempted."

Among the most terrible of the insect scourges which affect the vast territories of the Western World, is the army-worm. The name arouses old associations, and one involuntarily recalls "the canker-worm, and the caterpillar, and the palmer-worm, my great army which I send among you." The army-worm well deserves his name, although like most familiar vernacular appellations it may have been wrongly employed. The cotton-worm (*Aletia xyliana*), for example, has been so designated; but the true army-worm is *Leucania unipuncta*, known in the earlier chronicle as the "black worm," and is the larva of a Noctuid moth, named as above by Haworth. It is difficult to give an idea of the fearful character of this plague when in obedience to solar influence it begins its march. "Almost with a shudder (p. 145) one remembers that terrible invasion of Monmouth, when the potato fields were ruined as if by fire, and the waggon wheels reeked with green dripping gore as they entered our villages. . . . That beautiful lawn of Hollywood at Long Branch was invaded by them. The emerald sward was swept as if burnt. When any of the worms came against a tree they went up it, passed over the crotch, then descended at the other side. There is no 'turn back' to this singular worm, and when their path is intercepted by a stream, on they come, until, crowded forward, a compacted mass is urged into the water to serve as a living pontoon, over which the army passes to take possession of pastures new."

Another account states that the army-worm when travelling will scarcely turn aside for anything but water, and even shallow water-courses will not always change its progress. They avoid the rays of the sun, hence during the day they crawl under stones and sticks as closely as they can crowd themselves together, like the cut-worm. They come out towards sunset and continue their mighty march. If they come to a field of grass or young grain they devour the whole of it, down to the very roots; but if it is grown up to stalks they eat the leaves only, and then usually crawl to the top of the stalk and cut off the head and drop it to the ground.

They all keep together like an army of soldiers, and usually advance in a straight line, not swerving from their course to avoid hills, hollows, buildings, or any other obstacle. On coming to a brook, they crowd into it; millions of them are drowned, their dead bodies clogging and damming up the stream in places below, producing by their decay a stench in the atmosphere of the whole vicinity most noisome and intolerable.

Monmouth County was invaded in 1880, and the following graphic sentences from the *New York Sun* will help us to obtain an idea of this calamity:—

"Trenches were seen extending for miles along the roads close to the edges of the fields, but the crops for the most part were withered and lifeless, and it was evident that the precautions had been taken too late. Very often a trench ran across a wheat-field, showing where the farmer had abandoned one portion of his crops and tried to save the remainder. Occasionally a field was seen intersected by numerous trenches, indicating that the proprietor had fought manfully against his persecutors, and disputed the ground with them foot by foot. In many places the road was literally covered with the worms, all in motion, and all moving towards the fields on either side. Thousands and tens of thousands were crushed beneath the waggon wheels and under the horses' feet, but the rest passed on. And at intervals spots were passed where an imaginary line seemed to be drawn across the road beyond which the army-worms could not pass. For a certain space beyond, sometimes for a distance of two or three miles, not only the roads, but the adjoining

country was free from the pest. Not a worm was to be seen until, the clear space passed, the waggon was again rolling over millions of them." The remedies suggested partake of the general character of the means proposed by entomologists, and are probably mostly learnt by the entomologists from the farmers and peasants. They consist in rolling, fencing, ditching, burning, coal-tarring, poisoning, "drawing the rope," which is done by two men drawing the rope in a direction at right angles to its own length.

Another pest of different habits and less widespread destructiveness is the Canker-worm (*Anisopteryx pomataria* and *ascularia*), an insect which feeds on the leaves of apple-trees, and completely ruins orchards. Entomological science has conferred a boon by suggesting methods of getting rid of this creature by taking advantage of its peculiarities. The female, like our glow-worm, is wingless, and therefore cannot rapidly spread beyond the locality where it exists. She hibernates in the earth near the roots of trees, and on the first return of spring she ascends the trunk, depositing her eggs between the leaflets of the expanding buds, sometimes even close to the ground, but oftener under loose scales of bark. It is this peculiarity of the female which enables the fruit-grower to grapple with the difficulty. One of the best means is what is known as "hanging the band." This contrivance consists essentially of a band or ring of tin a few inches outside the trunk of the tree, and held there by a circle of muslin attached to the tin at its edge, and drawn with a cord at the top, so as to fit the tree closely and prevent the insects from going over the tin, which is coated with a mixture of castor-oil and kerosene: as soon as they touch this they drop to the ground. Troughs of oil arranged closely around the tree, or the complete isolation of the tree by fitted boarding lined on the outside by smooth tin and also fitted with shallow troughs for oil are also used. Another ingenious plan is to use a cylinder of sheet tin upon a band of line or cord. The cord forms a firm boss around the tree, and the hollow cylinder surrounds it and extends them at four inches above and below it. The female finds this an effective barrier, and it is said if she even succeeds in passing upwards to the top of the cylinder she will never descend in the inside so as to again reach the tree.

A good deal of interesting evidence is adduced upon the effects of "jarring and burning," or the jarring of the affected trees, after spreading a light coating of dry straw on the ground below, which is then fired without injury to the trees. A table-spoonful of Paris-green in twelve quarts of water applied to the tree with a large syringe, when, as nearly as can be judged, the worms are all hatched, is a second method. "Fall-ploughing" is a third plan, which appears to have been very successful; and, lastly, attention has been very properly drawn to the balance of power in nature by encouraging birds and parasitic insects that live upon the canker-worm. A valuable distinction has also been pointed out by the Commission between the "fall" canker-worm, and the spring species, from which it differs in many important respects, as may be gathered from its name. There are many other interesting chapters in the volume which we should have liked to at least have mentioned, but it is not our object to do more than give a good general idea as to the work of the Commission and the manner in which it is prosecuted. We therefore leave the consideration of the Hessian fly and the Rocky Mountain cricket, with a hearty recommendation to those who are interested in economic entomology to obtain this Report. J. W.

#### THE FORESTRY EXHIBITION

IN last week's NATURE (p. 222) we briefly noticed the remarks of the Marquess of Lothian in declaring the International Forestry Exhibition at Edinburgh open. For

several reasons it has not been in the power of some foreign Governments to be represented at the Exhibition. And in more than one case, notably that of Chili, an unforeseen accident occurred to prevent others who intended to be present. Where direct participation, in so far as exhibits are concerned, has been impossible, official maps and publications bearing on the forest service or literature of the country have been forwarded, or a representative has been commissioned officially to attend, or the efforts of private individuals have been exerted to supply the omission. The Exhibition has thus been inaugurated by the co-operation of many of the foreign and colonial Governments, and by the good wishes of all.

In the arrangement of the articles exhibited the geographical principle has been adopted, the goods of each country being together.

A scientific arrangement was very desirable, and the "classification" issued by the Executive Committee was prepared with that intention, but it was found impossible to arrange the Catalogue in accordance with it, from the imperfect details given in many of the schedules of exhibitors, and the tardy arrival of the consignments. Great latitude has been allowed to the admission of goods, which have been largely received during the week since the opening, and we believe that the very large and interesting collection from Japan will be in its place in a few days.

The Catalogue contains much valuable information, especially the portion relating to India and the Scottish Arboricultural Society, which together cover eighty pages; but it is not yet complete with respect to several colonies and foreign Governments, notably Japan. A new edition is promised, more easy of reference, where the theoretical classification of the articles on paper will agree with the actual distribution in the building.

The ground on which the buildings are erected is 5 acres in extent. The main building is 650 feet long by 55 feet broad, with three annexes, each 150 feet long by 55 feet broad, with a high central dome in each annexe.

The design of the buildings is similar to the main galleries in the Health Exhibition, Kensington. Additional annexes, 500 feet long and 25 feet broad, similar in design to the main buildings, were erected at a later stage in consequence of the large demands for space by the Japanese Government, &c.; the exhibiting area thus became one-third larger than its original extent. It is a handsome light building which produces a very agreeable effect on entrance.

The Electric Railway runs along two sides of the building, and is about 650 yards in length. On the west side of Donaldson's Hospital grounds a field 7 acres in extent was inclosed for the purpose of exhibiting wood-working machinery in motion, nurserymen's exhibits, greenhouses, iron houses, wire fencing, gates, &c. Here will be found various huts and chalets, including one from Balmoral; also the Manitoba Settler's Farm, and many varieties of models of gates, fencing materials, &c., exhibited by the Commissioner of Her Majesty's Woods and Forests, all having a connection with the wide subject of forestry.

The Indian collection occupies the south central transept, and several bays on each side; it is very large and interesting; the catalogue has a historical preface by Sir George Birdwood. The arrangement is admirable, Col Michael and his assistant having had experience in the Paris, Vienna, and Amsterdam Exhibitions.

The Index Collection of Timbers sent by the Government of India, comprises 800 specimens, with their commercial uses and habitats, and illustrates arboreal vegetation from Thibet to Cape Comorin; each specimen is carefully labelled.

In the Indian Court may be specially noticed the very valuable series of maps and diagrams executed by the Forest Survey Department under Major Bailey, R.E., who

has himself arranged them in an instructive manner. The excellence of these topographical surveys can scarcely be overrated in connection with the demarcation and management of the reserved forests divided into blocks or compartments, and in the case of boundary disputes their value is undeniable. For students of forestry this is a most important feature of the Exhibition, and shows the silent progress of the great work which has been carried on by Dr. Brandon and his assistants during the past twenty-five years.

The only other country which exhibits maps showing in detail the general distribution of forests is Denmark. There are three sheets displaying the occurrence of the forests of conifers and of broad-leaved trees, also the extent of newly-planted areas and the geological formations on which they grow. There are also maps of the forest district of Kronborg which resemble those made in Germany, and are very neatly executed.

It would have been very desirable that sets of these illustrative maps had been furnished as far as possible by various Governments to assist in determining the rates of growth of indigenous trees in different countries. For instance these diagrams give the mean height from 20 to 120 years, and show that in Germany the height of beech and spruce is greater than in Denmark; but the average diameter of the latter exceeds that of the former.

In the Indian collection an interesting contribution from Col. Yule has found a temporary resting place. Marco Polo, who tells us of the existence of the roc, a bird of wonderful dimensions, further tells how the feather or quill of the roc was brought back by envoys to Madagascar or East Africa, and presented to the Great Khan. Col. Yule and Sir John Kirk seem now to have brought to light the true roc's quill in the frond of the leaf of the *Raphia* palm, which is largely used on the coast near Zanzibar for making stages, ladders, rafters, and doors. The hard ligneous frond, stripped of its leaflets, somewhat resembles a stripped feather; the largest is twenty-five feet four inches long, and twelve inches in girth at the base.

#### TECHNICAL SCHOOL EDUCATION AT THE HEALTH EXHIBITION<sup>1</sup>

IN last week's issue some account was given of the appliances, methods, and results of primary school education to be seen at the Health Exhibition, and we ventured to express the hope that this remarkable and probably unprecedented collection would be carefully inspected by as many as possible of our schoolmasters and mistresses, as well as by school managers and others. In the present article it is proposed to deal similarly with technical handicrafts and science teaching as practised not merely in England, but in those foreign countries and organisations which, as previously stated, have brought together such excellent collective exhibits.

The increased attention now being devoted to the whole subject of infant training, and the enlarged sympathy and interest with which the best modern teachers are studying the methods of Fröbel (some of the developments of which are at the basis of all so-called technical training), have justified the appropriation of a considerable space to illustrations of the Kindergarten system. The British and Foreign School Society have devoted the whole of the room at their disposal to this purpose, in order to make the display as complete as possible, and here will be found a practical answer to those who allege that "Kindergarten work is all play," for the manner in which it leads up to various trades is distinctly shown. In the Belgian Court there is also a very complete and effective Kindergarten exhibit, though it contains nothing specially new, and the

<sup>1</sup> Continued from p. 220

same remark applies to that of the city of Antwerp. In the gallery of the Albert Hall (No. 1374) is an admirable exhibit, in which all Fröbel's occupations are grouped round a given object in nature, illustrating the Pestalozzian system of Kindergarten teaching, as carried out in Berlin.

The subject of domestic economy, and other forms of technical and industrial occupation for girls, is illustrated in a very thorough manner by the Minister of Public Instruction in Belgium, and to a less extent by the corresponding official in France. A notice appended to the Belgian Illustrative Museum states that mere oral lessons have been found to produce no good results, and hence that this subject is taught in a "decided, intuitive, and demonstrative" manner, which has necessitated the formation of illustrative collections in each school. These will be found to be most complete, every stage in the manufacture of clothing and food, from the raw material to the finished product, being illustrated, as well as the more important points in house sanitation. No similar exhibit is to be found in the English section. The embroidery and other work of the "École professionnelle de jeunes filles" will repay careful inspection. With regard to needlework generally, we are informed that some lady experts in this matter have a very high opinion of what is shown in the Belgian and French Courts, as well as of that sent by the Birmingham School Board, which appears to be the best English needlework. In this connection also a word may be said in support of the efforts now being made by the Scientific Dress-cutting Association, who show interesting demonstrations of their methods.

Turning now to the more general question of scientific and technical instruction as illustrated at the Health Exhibition, it will be remembered that one of the results of a comparison of English and foreign primary school methods was stated to be, that elementary scientific instruction formed a much more prominent feature in French and Belgian primary schools than in English. We notice with great pleasure that, in opening a higher-grade school at Manchester on Monday last, Mr. Mundella pointed out that one objection to English education was its too exclusively literary character. The practice of the Liverpool and Birmingham School Boards, and to a less extent of the London School Board (which in its exhibit endeavours to illustrate its whole system, and not merely certain features of it, as is done by the Birmingham authorities), is however a pleasing exception to this general statement. It cannot be denied, however, that a very much better foundation is laid in primary schools abroad than at home for that technical education the importance of which is now becoming so generally recognised, as evidenced by the extraordinary demand for copies of the recently published Report of the Royal Commission on the subject, and by the noble building in which the chief educational exhibits are temporarily housed.

It may be convenient, as in the former case, to notice first the foreign appliances for, and results of, technical education, the collection of which in point of interest and size is not so large, when compared with the corresponding English exhibits, as is the case with the primary schools. In the Belgian Court the collections of the Ministry of Public Instruction and of the Carlsbourg School are specially noticeable; the technological collections to illustrate the various industries are most complete, and are arranged under such heads as vegetable fibre, minerals, the animal kingdom, &c., while under the head of botany is an admirable series of specimens illustrative not merely of agriculture but of arboriculture, the various methods of grafting, for example, being clearly shown. There is also an interesting collective exhibit "des écoles industrielles et professionnelles," and there are no less than three societies whose sole object is the technical and professional training of women in various trades, such as artificial flower-making, dress-making, embroidery,

&c. This appears to be a new departure, which might be advantageously followed in our own country.

In reviewing the recent progress of educational legislation in France, we find that in March 1882 laws were passed which rendered obligatory (1) the teaching of the elementary physical sciences in primary schools, and (2) the performance therein of a certain amount of manual work. Accordingly, under the first of these heads we find exhibited by the Minister of Public Instruction the authorised collections of objects and apparatus used in this teaching, as well as models of simple and cheap instruments such as could be fabricated by the pupils themselves. The second law alluded to has called into existence the "École normale de travail manuel," a school probably unique of its kind, whose whole course of instruction is well illustrated by a series of photographs and specimens, and by a detailed programme. It comprises the systematic teaching of carpentry, the use of the lathe, the chemical and physical laboratory, the smith's forge, and the "fitting" shop. The whole instruction is gratuitous, and admission is obtained after a competitive examination in the lower grade schools. Fuller details about this school, as well as about the present system of education in France as a whole, will be found in the ten pages of the special educational catalogue devoted to an introduction to the French exhibits. Closely associated with this is a capital collection of work from the École des Arts et Métiers of Aix (Bouches-du-Rhône), which, together with the results of various apprenticeship and art schools, is exhibited by the Ministry of Commerce, Paris. The handicraft work of the primary schools of Vierzon and of Voiron (Isère), as well as of the technical schools at Evreux and Nantes, deserves careful examination, while in the department of agricultural industry, the work of a school at Lille is much to be commended and worthy of imitation. Among the private exhibits in the French section the most noticeable features are:—the admirable collection of objects of natural history and of science diagrams, all for school use, shown by M. Émile Deyrolle, and the wonderful collection of botanical and physiological models shown by Mme. Veuve Auzoux and M. Montaudon. Part of this is a series of anatomical models (probably the best of their kind) composed of solid pieces, which can be easily adjusted or separated, and removed piece by piece as in actual dissection. Somewhat similar models are shown by Mme. Lemercier. It is greatly to be regretted that the very high price of these excellent models is an effectual bar to anything beyond a very limited use of them.

The collection of educational appliances as used in Norway, and shown by Mr. Mallings in the gallery of the Albert Hall, deserves warm commendation. It is characterised by the same importance as attached to objective and practical teaching (as distinguished from book-information) which we noticed in the French and Belgian schools. This publishing house is one of the sights of Christiania.

Prominent among the illustrations of technical education in England, the preparations for which, as we have before stated, have not yet reached down to our primary schools to any appreciable extent, are the three rooms devoted to illustrations of the work at the Finsbury Technical School. These are specially remarkable as showing the admirable methods which characterise the whole of the work there, and which, we venture to think, deserve careful study. A room is devoted to the mechanical laboratory and appliances, and a large amount of space to the department of electrical engineering, while a special feature in the display is the printed explanatory paper of notes attached to each piece of apparatus. Another good example of English technical education is the collection of drawings and models relating to coach and carriage building, to which three organisations contribute, illustrating the alterations that occur in the conditions of locomotion. There is a very good collec-

tion of excellent specimens of school work done in the Allan Glen's Institution of Glasgow, in which the object of a two years' technical course is to prepare boys to learn trades whose mastery implies a considerable amount of scientific knowledge. University College, Nottingham, exhibits some work done in the recently established technical school attached to it, and the Engineering Department of University College, London, illustrates its work mainly by photographs and plans. The nearest approach to the handicraft school teaching as practised on the Continent, is to be found in the admirable technical work of the Central Higher School of the Sheffield School Board, in which an attempt is made to provide the proper connection between the theoretical instruction in the class-room and the practical instruction in the workshop. The Manchester Technical School, the Oldham School of Science and Art, the Clerkenwell Technical Drawing School, and the School of Art Wood carving all show praiseworthy results of technical training. Attention may here be called too to the admirable specimens of work done in the four trades-departments of the National Industrial Home for Crippled Boys; the pupils vary in age from twelve to eighteen, and having chosen a trade on entering the school, follow it for three years.

Among the results of the work of individual exhibitors, the exhibit of Mr. Robins calls for special notice, consisting as it does of a series of drawings illustrative of the general arrangements and fittings required for applied science educational buildings; these are so placed that comparisons are readily made between the arrangements adopted in various noted colleges, &c. Mr. Millis shows some excellent results of instruction in trades classes, specially models in wood and metal-plate work. Mr. James Rigg exhibits more than a hundred mechanical models specially arranged for instruction in four or five of the subjects in which the Science and Art Department examines pupils, and a smaller collection of the same kind is shown by Messrs. Gilkes and Co. Lathes of different patterns, and other mechanical tools and apparatus, are exhibited by Messrs. Holtzapffel and Co., Messrs. Melhuish and Sons, Mr. Syer, Mr. Evans, and others.

In neither of these articles has any reference been made to the appliances for elementary art instruction, nor to the special methods and apparatus used in educating the blind, and the deaf and dumb, all of which, however, are very fully illustrated. The seven classes of exhibits which come under "Group IV.—The School" (to quote the official phraseology) are also unnoticed. These comprise such important subjects as everything relating to the structural arrangements of school buildings, school kitchens, sanatoria, and infirmaries, and lastly, though by no means least in importance, the gymnastic and other apparatus for physical training in schools. Enough however has, we hope, been said to give some idea of the vast scope of this exhibition of educational appliances, and to justify the assertion made at the beginning of the first article, that probably no such extensive and valuable a collection of school appliances, methods, and results has ever been brought together before. Such an opportunity for study is not likely to occur again for some years, and we conclude by reiterating an earnest hope that it will not be lost by those most vitally interested in it.

WM. LANT CARPENTER

#### CHEMICAL RESEARCH IN ENGLAND

THE address of Dr. Perkin, F.R.S., to the Chemical Society at its anniversary meeting contains some sadly true statements respecting the state or rather the absolute want of state of research in chemical science in this country. After drawing attention to some interesting points in the work done during the past year, Dr. Perkin goes on in the first place to refer to the very small number of original papers contributed to the Society

during the past year (a point to which attention was called in these columns a few months ago), and then compares foreign sources of research work and the probable causes of this disparity. But this portion of the address will speak better for itself than in a mere abstract, and the facts therein stated demand the most serious attention of the authorities at our seats of learning.

Last year, Dr. Perkin went on to say, my predecessor, in his address, referred to the increasing number of chemical laboratories in the United Kingdom and the greater facilities which are now afforded for the prosecution of research. After considering the number of papers which have been read before this Society during the past few years, it appeared to me that it might be useful to make some remarks as to the influence these greater facilities have had on the development of chemical science.

The first thing that attracts attention is the startling and anomalous fact that the number of papers read before the Society (and I think this may be taken as a good criterion, especially as but few have been brought before the Royal Society) is declining year by year. The largest number we ever had was in the session 1880-81, when there were 113 communications brought before us; but in 1881-82 they declined to 87, in 1882-83 to 70, and this last session to the lamentably low number of 67, or about the number we had nine years ago. And this, not only with increased laboratory accommodation, but also with the assistance offered to investigators by our Research Fund and the Government Grant. This state of things causes us to look around and see where research *is* and where it *is not* being carried on in the United Kingdom.

If we look to the laboratories of our Universities, from many of these we never hear of a research emanating, and from the rest, taken as a whole, we get but dribbles at intervals. How different from the German Universities, from which there is such an incessant flow of work!

If we turn to the other laboratories connected with our colleges, hospitals, &c., with how few exceptions do we find any appreciable amount of work being carried on for the extension of the boundaries of our science; in fact, speaking in a general way, the work of our laboratories consists mainly in the students carrying out the ordinary course of qualitative and quantitative analysis, and attending one or two courses of lectures.

It is scarcely necessary to say that this is not sufficient, however well taught, to make a student a chemist; it is but a preliminary part of the training, which, being carried on as it usually is, by tables, and carefully laid down directions, gives but little scope for independent thought and action. The subsequent prosecution of scientific research, under proper supervision, however, is quite another thing, and calls out all the faculties of the student, requiring, as it does, independent thought and independent methods of working, and, moreover, gives him an insight and vivid interest in his science that nothing else will do. The preparation of chemical products, before the commencement of research, is no doubt also a very useful training if sufficiently diversified; but research is the most important of all.

The degree of Doctor of Philosophy has undoubtedly done a good deal to further chemistry in Germany, necessitating, as it does, the prosecution of original work, and now that degrees are so much thought of in this country (though why a chemist with one of our ordinary University degrees should be preferred to one who has fully given his mind to his science, and therefore has not got such a degree, it is difficult to understand), it is believed that if something analogous to the Ph.D. could be inaugurated in this country, it would help to further chemical science here also. A step in this direction has been taken at the Owens College, Manchester, but hitherto the degree has not found favour with students. It is not surprising, however, while there are so many different degrees not requiring original work as a *sine qua non*, that such a degree should not be sought after. This difficulty, however, might be overcome by modifying the requirements for the present degrees, and requiring that original research should be substituted for book knowledge. At the London University original work is recognised, but not required.

The past neglect of research will, it is to be feared, have a more lasting influence on the progress of chemistry in this country than may appear at first sight, and in this way. Those who have been students in laboratories where the importance of

this kind of work is not recognised, advance in their positions, becoming assistant demonstrators, &c., and eventually professors, and as they have not learnt to practically realise the value of research by being in the habit of conducting it themselves, or of seeing others do so, when they become professors they will naturally not encourage students to undertake it in their laboratories, and it is to be feared that we are already suffering in this way, and that this is one of the causes why the new laboratories which have been opened are doing so little to add to our store of fresh knowledge.

It is said that students cannot be induced to stay longer than is necessary to go through the ordinary course of qualitative and quantitative analysis, and can this be wondered at when they do not see anything else going on of sufficient interest to make them feel it would be a great advantage for them to do so? Would it be the case if higher work were being enthusiastically carried on? The fact that many of our students are found to leave this country and go to Germany, where research is carried on with so much zeal, I think gives an answer to this question.

In all chemical laboratories there are without doubt different classes of students: some who have no right to be there, having no care for science; those who have not sufficient capacity to proceed with its study beyond an elementary stage; and those who are capable of becoming efficient chemists. Of course it would be but waste of time to attempt to make the first two classes remain and engage in research. It is to be feared, however, that some are not unfrequently thought to belong to the second class who really, if sufficiently interested in their science by the example of others, would be found to be possessed of no mean ability. When a young man is made to realise that he may be the discoverer of new facts, or does discover new facts, he gets a new impulse, which alters the whole current of his thoughts and actions.

There can be no doubt that when a professor, his assistants, and advanced pupils are enthusiastically engaged with research, their influence is found to act even on beginners, who, if they possess any scientific spirit at all, will realise that the ordinary course of analysis is but a preliminary thing, and will thus be induced to use their best energies to master it that they also may try their hand at original work.

That this condition of things is calculated to fill laboratories with students is seen from the fact that on the Continent, where the greatest scientific activity prevails, the laboratories are the most crowded, and this is the kind of activity we want in this country, where our students pre-eminently possess all the faculties for original work, but as they are not cultivated these are not developed.

There is also another class of students who study chemistry, but the fruit of their study is so extremely small, that it is difficult to realise that it possesses any practical value. I refer to medical students; yet there are good teachers and good laboratories employed in the work, in fact a very large amount of valuable power is used for it; but it seems almost like the employment of a large amount of power to raise a weight to a certain distance and then let it fall again, and year after year to continue the same thing, never raising it sufficiently high that it may be placed in a useful position. The present condition of things cannot but be disheartening both to students and to teachers. Medical students have so much to learn that it is sad they should have to waste their time in studying chemistry in the way they do. If there is any value in chemical products as curative agents, if there is any value in physiological chemistry, or any importance in toxicology, surely medical students should have a sound knowledge of chemical science, and not simply learn to detect an acid and a base in a mixture, an operation which is of no value except as an intermediate exercise, to be followed by more advanced work.

The only cure for the evil appears to be either that their term of study should be lengthened, or that other subjects which are of less importance should be withdrawn from the curriculum, so as to enable them to work at this science sufficiently. Unfortunately medical men have as a rule acquired so imperfect a knowledge of chemistry themselves that they have found it to be of little value, and therefore do not sufficiently see how important its proper study would be to students. It is evidently high time that some steps were taken to economise the present waste of time and power, and that we should hear of some good work proceeding from the numerous, and in many cases well-appointed, chemical laboratories connected with our hospitals.

Of late years much attention has been given to the subject of

technical or applied chemistry, and it is to be hoped that this movement will be so judiciously carried on that much will be done for perfecting and developing the chemical manufactures in this country; but it appears that there is an idea in the public mind that there are two kinds of chemistry in existence, one suitable for the manufacturer, and the other suitable for the scientific man; and unless this idea can be successfully eradicated, it is to be feared that much of the value of this movement will be lost, and we shall be left in the position of followers instead of leaders; copyists of what others are doing, instead of being originators of new processes and industries.

In the present state of things students who are to be manufacturers are supposed to know enough chemistry when they have acquired a knowledge of ordinary analytical methods, and the result is that we have but very few efficient chemists in our works. On the Continent, however, we find a very different state of things: first of all, in their chemical works they usually have a much larger staff of chemists than we do, and secondly, their chemists are efficient men.

The chemists preferred in Germany are those who have had a thorough training, and taken their degree of Doctor of Philosophy, and shown their power as chemists by conducting original research, and in many cases have been for some time assistants to the professors in their research laboratories. Those from the Polytechnics are not so much valued, except in relation to their knowledge of engineering, mechanics, &c.

What do we see as the result of the employment of high-class chemists in Germany? First, we notice that chemical industries are developing and increasing there more than in any other country; and secondly, that the manufacturers are able to make their products in a very economical manner, and as a consequence supply them at a low price. Men who have studied chemistry sufficiently to do analysis and look after existing processes which are well known are certainly useful in their way; but we want more than this; we want men who have had their minds so trained by carrying on research that they may be imbued with a spirit of investigation, and be able to improve or entirely change processes in use, and to keep up their knowledge of chemical science, so as to be able to grasp the importance of new scientific facts, and make them subservient to the industries they are engaged in.

The chemists from the German Universities, when entering chemical works, naturally have but little knowledge of technical processes. This they have to acquire, but unfortunately they then only are likely to see those operations which are carried on in the particular industry with which they become connected. Those who study in the Polytechnics have a certain advantage in this particular, inasmuch as they can become acquainted with processes carried on in a variety of manufactures; and what is wanted nowadays is something like what would result from a fusion of the work of the Universities and the Polytechnics, *i.e.* scientific training similar to that in the former, with a general knowledge of engineering, mechanics, &c., and the methods adopted in carrying on processes on the large scale, this latter not being confined to one industry only, but also to industries in general, so that great breadth of knowledge may be acquired. With men so trained we might expect to see our chemical industries flourish, and keep at least abreast of those on the Continent.

It is to be hoped that some such standard of training will be undertaken at the Central Institute of the City and Guilds of London. It would be a sad thing to find the munificence of the City Companies resulting only in perpetuating the present kind of imperfectly trained chemists, who are incapable of advancing the chemical industries of this country, so that our manufacturers not unfrequently find it necessary to send to the Continent for more competent men.

In this retrospect of the work which is being carried on in relation to chemistry, it may be thought by some that an undue weight has been given to that which is going on in Germany, and too little to that which is being carried on in this country; but I think if any one will impartially compare one with the other, this will not be found to be the case. Science, however, has no nationality, and as chemists we cannot but be thankful that it is being actively studied, whether abroad or in our own country; but we must feel that it is our duty to do our part, especially when we see, from the work which has been and is being done in this country, that nationally we have the characteristics which qualify us to take a prominent position in work of this nature.



But from the point of view of our national progress we are bound to be active workers in this field of science. There is no doubt we do not hold the position we did as chemical manufacturers, and unless our chemical industries keep pace with chemical discovery fully as well as they do on the Continent, our position must further decline, and moreover, unless we make chemical discoveries ourselves, we must wait until we hear of the discoveries of others, which will mean, in cases where they are susceptible of practical application, that we are placed at a great disadvantage.

The bearing which the progress of chemistry in this country has upon this the oldest Chemical Society in existence is so obvious that it is superfluous to make any observation on the subject, except to express the hope that it will continue to be active, and found doing its part for the advancement of our science, and as a consequence be an important factor in the welfare of our country.

### ON THE EVOLUTION OF FORMS OF ORNAMENT<sup>1</sup>

THE statement that modern culture can be understood only through a study of all its stages of development is equally true of its several branches.

Let us assume that decorative art is one of these. It contains in itself, like language and writing, elements of ancient and even of prehistoric forms, but it must, like these other expressions of culture, which are for ever undergoing changes, adapt itself to the new demands which are made upon it, not excepting the very arbitrary ones of fashion; and it is owing to this cause that, sometimes even in the early stages of its development, little or nothing of its original form is recognisable.

Investigations the object of which is to clear up this process of development as far as possible are likely to be of some service: a person is more likely to recognise the beauties in the details of ornamental works of art if he has an acquaintance with the leading styles, and the artist who is freed from the bondage of absolute tradition will be put into a better position to discriminate between accidental and arbitrary and organic and legitimate forms, and will thus have his work in the creation of new ones made more easy for him.

Hence I venture to claim some measure of indulgence in communicating the results of the following somewhat theoretical investigations, as they are not altogether without a practical importance. I must ask the reader to follow me into a modern drawing-room, not into one that will dazzle us with its cold elegance, but into one whose comfort invites us to remain in it.

The simple stucco ceiling presents a central rosette, which passes over by light conventional floral forms into the general pattern of the ceiling. The frieze also, which is made of the same material, presents a similar but somewhat more compact floral pattern as its chief motive. Neither of these, though they belong to an old and never extinct species, has as yet attained the dignity of a special name.

The walls are covered with a paper the ornamentation of which is based upon the designs of the splendid textile fabrics of the Middle Ages, and represents a floral pattern of spirals and climbing plants, and bears evident traces of the influence of Eastern culture. It is called a pomegranate or pine-apple pattern, although in this case neither pomegranates nor pine-apples are recognisable.

Similarly with respect to the pattern of the coverings of the chairs and sofas and of the stove-tiles; these, however, show the influence of Eastern culture more distinctly.

The carpet also, which is not a true Oriental one, fails to rivet the attention, but gives a quiet satisfaction to the eye which, as it were, casually glances over it, by its simple pattern, which is derived from Persian-Indian

archetypes (Cashmere pattern, Indian palmettas), and which is ever rhythmically repeating itself (see Fig. 1).

The floral pattern on the dressing-gown of the master of the house, as well as on the light woollen shawl that is thrown round the shoulders of his wife, and even the brightly coloured glass knickknacks on the mantel-piece, manufactured in Silesia after the Indian patterns of the Reuleaux collection, again show the same motive; in the one case, in the more geometrical linear arrangement, in the other, in the more freely entwined spirals.

Now you will perhaps permit me to denominate these three groups of patterns that occur in our new home fabrics as modern patterns. Whether we shall in the next season be able, in the widest sense of the word, to call these patterns modern naturally depends on the ruling fashion of the day, which of course cannot be calculated upon (Fig. 2).

I beg to be allowed to postpone the nearer definition of the forms that occur in the three groups, which, however,



FIG.

on a closer examination all present a good deal that they have in common. Taking them in a general way, they all show a leaf-form inclosing an inflorescence in the form of an ear, or thistle; or at other times a fruit or a fruit-form. In the same way with the stucco ornaments and the wall-paper pattern.

The Cashmere pattern also essentially consists of a leaf with its apex laterally expanded: it incloses an ear-shaped flower-stem, set with small florets, which in exceptional cases protrude beyond the outline of the leaf; the whole is treated rigorously as an absolute flat ornament, and hence its recognition is rendered somewhat more difficult. The blank expansion of the leaf is not quite unrelieved by ornament, but is set off with small points, spots, and blossoms. This will be thought less strange if we reflect on the Eastern representations of animals, in the portrayal of which the flat expanses produced by the muscle-layers are often treated from a purely decorative point of view, which strikes us as an exaggeration of convention.

<sup>1</sup> From a paper by Prof. Jacobsthal in the *Transactions* of the Archaeological Society of Berlin.

One cannot go wrong in taking for granted that plant-forms were the archetypes of all these patterns. Now we know that it holds good, as a general principle in the history of civilisation, that the tiller of the ground supplants the shepherd, as the shepherd supplants the hunter: and the like holds also in the history of the branch of art we are discussing,—representations of animals are the first to make their appearance, and they are at this period remarkable for a wonderful sharpness of characterisation. At a later stage man first begins to exhibit a preference for plant-forms as subjects for representation, and above all for such as can in any way be useful or hurtful to him. We, however, meet such plant-forms used in

a higher vitality. These latter forms depart, even at the time when they originate, very considerably from the natural objects. The successors of the originators soon still further modify them by adapting them to particular purposes, combining and fusing them with other forms so as to produce particular individual forms which have each their own history (e.g. the Acanthus ornament, which, in its developed form, differs very greatly from the Acanthus plant itself); and in a wider sense we may here enumerate all such forms as have been raised by art to the dignity of perfectly viable beings, e.g. griffins, sphinxes, dragons, and angels.

The deciphering and derivation of such forms as these is naturally enough more difficult; in the case of most of

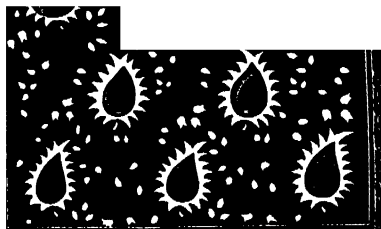

FIG. 2.



FIG. 5.

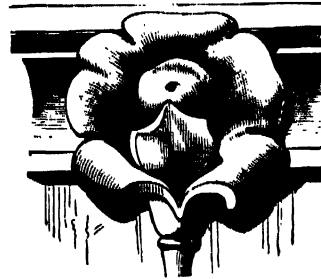

FIG. 6.

ornament in the oldest extant monuments of art in Egypt, side by side with representations of animals; but the previous history of this very developed culture is unknown. In such cases as afford us an opportunity of studying more primitive though not equally ancient stages of culture, as for instance among the Greeks, we find the above dictum confirmed, at any rate in cases where we have to deal with the representation of the indigenous flora as contradistinguished from such representations of plants as were imported from foreign civilisations. In the case that is now to occupy us we have not to go back so very far in the history of the world.

The ornamental representations of plants are of two

them we are not even in possession of the most necessary preliminaries to the investigation, and in the case of others there are very important links missing (e.g. for the well-known Greek palmettas). In proportion as the representation of the plant was a secondary object, the travesty has been more and more complete. As in the case of language, where the root is hardly recognisable in the later word, so in decorative art the original form is indistinguishable in the ornament. The migration of races and the early commercial intercourse between distant lands have done much to bring about the fusion of types; but again in contrast to this we find, in the case of extensive tracts of country, notably in the Asiatic continent, a fixity, throughout centuries, of forms that have once been



FIG. 3.

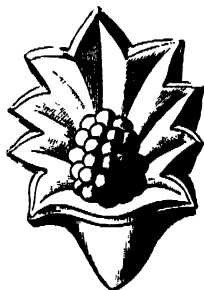

FIG. 4.

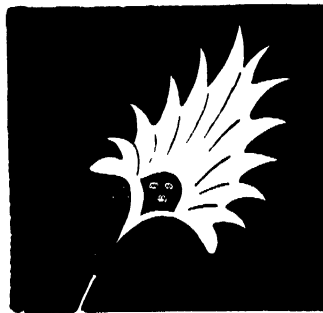

FIG. 7.



FIG. 8.

kinds. Where we have to deal with a simple pictorial reproduction of plants as symbols (laurel branches, boughs of olive and fir, and branches of ivy), *i.e.* with a mere characteristic decoration of a technical structure, stress is laid upon the most faithful reproduction of the object possible,—the artist is again and again referred to the study of Nature in order to imitate her. Hence, as a general rule, there is less difficulty in the explanation of these forms, because even the minute details of the natural object now and then offer points that one can fasten upon. It is quite another thing when we have to deal with actual decoration which does not aim at anything further than at employing the structural laws of organisms in order to organise the unwieldy substance, to endow the stone with

introduced, which occasions a confusion between ancient and modern works of art, and renders investigations much more difficult. An old French traveller writes:—“J’ai vu dans le trésor d’Ispahan les vêtements de Tamerlan; ils ne diffèrent en rien de ceux d’aujourd’hui.” Ethnology, the natural sciences, and last, but not least, the history of technical art are here set face to face with great problems.

In the case in point, the study of the first group of artistic forms that have been elaborated by Western art leads to definite results, because the execution of the forms in stone can be followed on monuments that are relatively not very old, that are dated, and of which the remains are still extant. In order to follow the develop-

ment, I ask your permission to go back at once to the very oldest of the known forms. They come down to us from the golden era of Greek decorative art—from the fourth or fifth century B.C.,—when the older simple styles of architecture were supplanted by styles characterised by a greater richness of structure and more developed ornament. A number of flowers from capitals in Priene, Miletus, Eleusis, Athens (monument of Lysicrates), and Pergamon; also flowers from the calathos of a Greek caryatid in the Villa Albani near Rome, upon many Greek sepulchral wreaths, upon the magnificent gold helmet of a Grecian warrior (in the Museum of St. Petersburg),—these show us the simplest type of the pattern in question, a folded leaf, that has been bulged out, inclosing a knob or a little blossom (see Figs. 3 and 4). This is an example from the Temple of Apollo at Miletus, one that was constructed about ten years ago, for educational purposes. Here is the specimen of the flower of the monument to Lysicrates at Athens, of which the central part consists of a small flower or fruits (Figs. 5 and 6).

The form passes over into Roman art. The larger scale of the buildings, and the pretensions to a greater richness in details, lead to a further splitting up of the leaf into Acanthus-like forms. Instead of a fruit-form a fir-cone appears, or a pine-apple or other fruit in an almost naturalistic form.

In a still larger scale we have the club shaped knob developing into a plant-stem branching off something after the fashion of a candelabra, and the lower part of

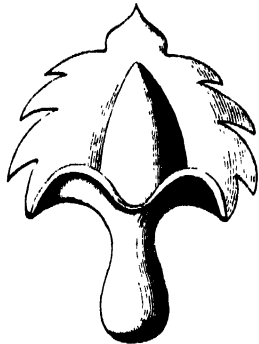

FIG. 9.

the leaf, where it is folded together in a somewhat bell-shaped fashion, becomes in the true sense of the word a campanulum, out of which an absolute vessel-shaped form, as *e.g.* is to be seen in the fricze of the Basilica Ulpia in Rome, becomes developed.

Such remains of pictorial representation as are still extant present us with an equally perfect series of developments. The splendid Græco-Italian vessels, the richly ornamented Apulian vases, show flowers in the spirals of the ornaments, and even in the foreground of the pictorial representations, which correspond exactly to the above-mentioned Greek relief representations. [The lecturer sent round, among other illustrations, a small photograph of a celebrated vase in Naples (representing the funeral rites of Patroclus), in which the flower in question appears in the foreground, and is perhaps also employed as ornament (Figs. 7 and 8).]

The Pompeian paintings and mosaics, and the Roman paintings, of which unfortunately very few specimens have come down to us, show that the further developments of this form were most manifold, and indeed they form in conjunction with the Roman achievements in plastic art the highest point that this form reached in its development, a point that the Renaissance, which followed hard upon it, did not get beyond.

Thus the work of Raphael from the loggias follows in unbroken succession upon the forms from the Thermæ of

Titus. It is only afterwards that a freer handling of the traditional pattern arose, characterised by the substitution of, for instance, maple, or whitethorn, for the Acanthus-like forms. Often even the central part falls away completely, or is replaced by overlapping leaves. In the forms of this century we have the same process repeated. Schinkel and Bötticher began with the Greek form, and have put it to various uses; Stüler, Strack, Gropius, and others followed in their wake until the more close resemblance to the forms of the period of the Renaissance in regard to Roman art which characterises the present day was attained (Fig. 9).

Now what plant suggested this almost indispensable form of ornament, which ranks along with the Acanthus and Palmetta, and which has also become so important by a certain fusion with the structural laws of both?

We meet with the organism of the form in the family of the Araceæ or Aroid plants. An enveloping leaf (bract), called the spathe, which is often brilliantly coloured, surrounds the florets, or fruits, that are disposed upon a spadix. Even the older writers—Theophrastus, Dioscorides, Galen, and Pliny—devote a considerable amount of attention to several species of this interesting family,



FIG. 10.



FIG. 11.

especially to the value of their swollen stems as a food-stuff, to their uses in medicine, &c. Some species of Arum were eaten, and even nowadays the value of the swollen stems of some species of the family causes them to be cultivated, as, for instance, in Egypt and India, &c. (the so-called Portland sago, Portland Island arrowroot, is prepared from the swollen stems of *Arum maculatum*). In contrast with the smooth or softly undulating outlines of the spathe of Mediterranean Araceæ, one species stands out in relief, in which the sharply-marked fold of the spathe almost corresponds to the forms of the ornaments which we are discussing. It is *Dracunculus vulgaris*, and derives its name from its stem, which is spotted like a snake. This plant, which is pretty widely distributed in olive-woods and in the river-valleys of the countries bordering on the Mediterranean, was employed to a considerable extent in medicine by the ancients (and is so still nowadays, according to von Heldreich, in Greece). It was, besides, the object of particular regard, because it was said not only to heal snake-bite, but the mere fact of having it about one was supposed to keep away snakes, who were said altogether to avoid the places where it grew. But, apart from this, the striking appear-

ance of this plant, which often grows to an enormous size, would be sufficient to suggest its employment in art. According to measurements of Dr. Julius Schmidt, who is not long since dead, and was the director of the Observatory at Athens, a number of these plants grow in the Valley of Cephissus, and attain a height of as much as two metres, the spathe alone measuring nearly one metre. [The lecturer here exhibited a drawing (natural size) of this species, drawn to the measurements above referred to.]

Dr. Sintenis, the botanist, who last year travelled through Asia Minor and Greece, tells me that he saw beautiful specimens of the plant in many places, e.g. in Assos, in the neighbourhood of the Dardanelles, under the cypresses of the Turkish cemeteries.

The inflorescence corresponds almost exactly to the ornament, but the multipartite leaf has also had a particular influence upon its development and upon that of several collateral forms which I cannot now discuss. The shape of the leaf accounts for several as yet unexplained extraordinary forms in the ancient plane-ornament, and in the Renaissance forms that have been thence developed. It first suggested the idea to me of studying the plant attentively after having had the opportunity five years ago of seeing the leaves in the Botanic Gardens at Pisa. It was only afterwards that I succeeded in growing some flowers which fully confirmed the expectations that I had of them (Figs. 10 and 11).

(To be continued.)

#### NOTES

THE International Conference on Education in connection with the International Health Exhibition will be opened on Monday, August 4, at 11 a.m., and will continue throughout the week. The arrangements as yet are not quite complete, but it is announced that the following papers, among others, will be read:—(1) Conditions of Healthy Education:—On the structure, fitting, and equipments of a school, by the Rev. Canon Holland, Canterbury, and Rev. E. F. M. MacCarthy, King Edward's School, Birmingham; on gymnastics and other physical exercises, by Captain Burney, R.N., Royal Hospital School, Greenwich, and H. J. Wilson, J.P., Sheffield; on the right apportionment of time to different subjects of instruction in schools of various classes, by H. W. Eve, University College School, London. (2) Infant Training and Teaching:—What Fröbel did for young children, by Miss Manning; on the relations of the Kindergarten to the various industries of a country, by Fräulein E. Heerwart; on the main work to be accomplished by Kindergartens for the people, and on the methods of training teachers in such institutions, by Madame Schrader, Berlin. (3) Technical Teaching—(a) Science, (b) Art, (c) Handicrafts, (d) Agriculture, (e) Domestic Economy:—On the methods of teaching the different branches of physical and of natural science, by Henry E. Armstrong, Ph.D., F.R.S.; the teaching of science in public elementary schools, by W. J. Harrison, Birmingham; science teaching in training colleges, by H. A. Reatchlous, Westminster Training College; on the teaching of drawing and colouring as a preparation for designing and decorative work, by John Sparkes, Science and Art Department, A. F. Brophy, Finsbury Technical College, and T. R. Ablett, London School Board; on technical teaching, by Prof. Garnett, University College, Nottingham, and E. M. Dixon, Allen Glen Institute, Glasgow; on technical teaching in Board schools, by J. F. Moss, Sheffield School Board; on manual training schools, by Prof. Woodward, St. Louis, U.S.; (d) the teaching of agricultural science in elementary, in intermediate, and higher schools, in evening science classes, in special colleges, and in the Universities, methods of teaching, &c., by the Rev. J. M'Clellan, Royal Agricultural College, Cirencester, J. Wrightson, Wiltshire Agri-

cultural College, and others; on school farms and farm schools, by H. M. Jenkins, Royal Agricultural Society; on methods of teaching cookery in schools, by Miss Fanny Calder, Hon. Sec. Northern Union of Schools of Cookery. (4) Teaching of Music in Schools. (5) Museums, Libraries, and other Subsidiary Aids to Instruction in Connection with Schools:—On school museums, by Dr. Jex Blake, Rugby. (6) Training of Teachers:—By G. B. Davis, Birmingham, and C. Mansford, Wesleyan Training College, Westminster; on some of the differences which exist between the training, position, and duties of elementary teachers in Great Britain and on the Continent, by the Rev. Canon Cromwell, St. Mark's College, Chelsea; Universities and their relations to the training of teachers, by the Rev. R. H. Quick, Sedbergh; professorships and lectureships on education, by Prof. S. Laurie, University of Edinburgh, and Prof. J. M. D. Meiklejohn, St. Andrew's University; on diplomas and certificates and the registration of teachers, by F. Storr; on training colleges in Scotland, by the Rev. J. Morrison, D.D., Glasgow. (7) Inspection and Examination of Schools:—(a) By the State, by W. Kennedy, Glasgow; (b) by the Universities—on the University local examinations, by the Rev. G. F. Browne, B.D.; on the University extension movement, by Albert J. Grey, M.P., and E. T. Cook; by other public bodies, by the Rev. H. L. Thompson, Iron Acton. (8) Organisation of Elementary Education:—By Sir U. Kay Shuttleworth, Bart., and T. E. Heiler; on the English system of elementary education—its growth and present condition, by the Rev. H. F. Roe, Sherborne. (9) Organisation of Intermediate and Higher Education:—On the requirements of a truly national system of higher education and the proper relation of the old Universities to such a system, by R. D. Roberts, Clare College, Cambridge; on the comparative advantages and disadvantages of arranging the course of study in the various school classes on lines of subjects appointed for local University or other general examinations, by the Rev. R. B. Poole, Belford Modern School; on the advantages and disadvantages of providing for intermediate and higher education by means of a rate, as is done in the case of elementary education, by the Rev. Canon Daniel, and Hon. E. Lyulph Stanley, M.P.; on the organisation of higher education for girls, by Miss Beale, Cheltenham; on the curriculum of a girls' high school, by Mrs. Bryant, B.Sc. (10) Organisation of University Education:—On the proper relation between the teaching and examining bodies in a University, by Sir George Young, Bart.; on scientific teaching in a University, by Prof. Fleeming Jenkin; on the University education of women, by Mrs. H. Sidgwick; on the relation of a University to the colleges, by G. W. Hemming; on the relation of provincial colleges to a University, by E. Johnson, Nottingham; on the duties of the Universities to our Indian Empire, by Prof. Monier Williams.

HER MAJESTY has been pleased to confer a baronetcy upon Mr. Bernhard Samuelson, M.P., and a knighthood upon Prof. Roscoe, in consideration of the services rendered by them in connection with the Technical Education Commission. Sir Bernhard Samuelson well deserves the honour which has been conferred upon him; the services which he has rendered to science and to scientific education both in and out of Parliament, by his insisting for so many years on the importance of science to our national industries, is well known to all our readers.

"A NATURALIST," in a letter to the *Times* of yesterday, again draws attention to the scheme for a Marine Biological Laboratory, showing the practical utility of such an institution by quoting the report of Prof. Brooks on the researches on oysters carried out in the Marine Biological Laboratory founded by the Johns Hopkins University. In a leading article the *Times* very heartily supports the appeal of "A Naturalist" for subscriptions to the Marine Biological Association, an appeal which we hope will be liberally responded to.

IN a communication to us dated Helsingfors, June 23, Prof. Selim Lemström states that, having seen in NATURE that Dr. Sophus Tromholt has entirely failed in producing the artificial aurora borealis in Iceland with one of the "utströmmings" apparatus invented by the Professor, he ascribes this chiefly to the unusually adverse winter, heavy snowfall, and great moisture having frustrated nearly every attempt to produce the aurora in Sodankylä. It is remarkable, the Professor adds, that these circumstances have in no way affected the terrestrial currents, the measurements of which have been highly satisfactory.

THE second number of *La Nuova Scienza* fully maintains the promise of the first, lately noticed in NATURE. The editor, Prof. Enrico Caporali, who contributes most of the papers, continues to deal chiefly with the borderland between physics and metaphysics. His avowed object is to establish a new philosophy based on the reconciliation of idealism and the material order. Hence he revives the speculative doctrines of Campanella, Giordano, Bruno, and Vico, proclaims himself a follower of Kant, in so far as he accepts the Absolute as lying behind the relative, and denounces not only the French materialists but even the modern English Agnostic-school. Thought, life, liberty, *la cernita*, that is, "selection" in the Darwinian sense, pervade all nature, the so-called material or inorganic as well as the organic world. Even crystals are "living beings, possessing not the turbulent fiery life of organised species, but a calm and stable life, feeling its harmony and unity, and ever seeking to adapt itself to the environment." And again: "Free selection has done everything in nature. The harmony of beings is the outcome of a long, persistent, unflagging work of fruitful selections inspired by Unity," that is, by the Absolute. In the present number the leading papers are:—"Modern Italian Thought," "The Pythagorean Formula of Cosmic Evolution," and "The German compared with the Italian Anti-clerical Movement."

DR. GLASENAP continues to give in the *Novoye Vremya* further details concerning Russian private observatories. Dr. Endrzejewitsch's observatory at Plonsk is provided with two equatorials, the objectives of which have respectively 162 and 140 mm. diameter; an equatorial telescope, the objective of which is 108 mm.; a transit instrument, three spectroscopes, a Secchi solar eye-piece, and a rich collection of meteorological and physical instruments. Although engaged in the medical profession, Dr. Endrzejewitsch displays a rare energy in the observations of comets, minor planets, Jupiter's satellites, and double stars. His observations of double stars are considered by astronomers as most accurate. General Mayevsky's observatory at Pervino, close to Torjok, is provided with a 6-inch refractor with parallactic motion, and with a transit instrument. Although M. Mayevsky makes observations only during the summer months, his measurements of some double stars and of stars situated in that part of the sky where the moon will be during the next total eclipse of October 4, are worthy of notice. His scientific work is usually described in the Annual Reports of the Pulkowa Observatory.

A DISEASED coffee leaf from Natal has been transmitted to Kew by Prof. Macowan, Director of the Botanic Garden, Cape Town. It has been examined by Mr. H. Marshall Ward, lately employed by the Government in the investigation of the coffee disease in Ceylon, and he finds it attacked with a typical form of the fungus *Hemileia vastatrix*, to which the well-known leaf-disease of that colony is due. This is the farthest westward extension of the disease at present. Eastward it has long maintained a position in Fiji.

PROF. BONNEY asks us to state that the paper which he has promised to the Montreal meeting of the British Association is not, as inadvertently stated in NATURE (p. 218), "On the Archæan Rocks of Canada, &c.," but "On the Archæan Rocks

of Britain." Prof. Bonney has not yet visited Canada or examined many of its rocks.

ACCORDING to the *Times* Paris Correspondent, M. Pasteur's experiments with the virus of hydrophobia are going on with unbroken success. He has thus far experimented on 57 dogs, 19 of them mad and 38 bitten by them under uniform conditions. Out of these 38 half had been previously inoculated, the other half not. The latter, without a single exception, died with unmistakable signs of hydrophobia, whereas the 19 others are about as well as ever. They will be watched for a year by veterinary doctors to see whether the inoculation holds good permanently or only temporarily.

AS to chemical research in England we print Dr. Perkin's address in another column. As to chemistry as a trade we are requested to state that a petition, signed by Prof. Odling, M.A., F.R.S., &c., Professor of Chemistry in the University of Oxford, and others, has been presented to Her Majesty in Council praying for the grant of a charter of incorporation, under the title of the Institute of Chemistry of Great Britain and Ireland. The petition has been referred to a Committee of the Privy Council. The trade seems distinctly to have the best of it!

MR. STANLEY is reported at St. Paul de Loanda to have sailed for England on June 8.

THE city of Rouen has organised in connection with the Concours Regional an exhibition of electricity for the whole of France, and a special exhibition of Algerian products. The number of electrical lamps, regulator and incandescent, is very large, about 400 Swan, some Maxim, 30 Breguet regulators, about 30 Jablokhoff, and 5 or 6 sun lamps. One of the most interesting features is the special exhibit by the Association des Propriétaires of steam-engines of Normandy, who have collected a large number of boilers which have exploded, with labels indicating the causes of explosion.

DR. GULDBERG writes to us with reference to his recent article on the North Cape Whale (vol. xxx. p. 148), that he stated that one of these species of whale was taken at Pampeluna (an inland town); what he meant to have stated was that it was taken at San Sebastian, and brought to Pampeluna. He also finds that Taranto was given as Toronto. Dr. Guldberg informs us that one specimen more of the North Cape Whale has been captured, viz. at Guetaria, not far from San Sebastian, on February 11, 1878; the omission was due to the fact that his article was written during his stay at Liège, where all his books of reference were wanting.

THE additions to the Zoological Society's Gardens during the past week include two Diana Monkeys (*Cercopithecus diana* ♂ & ♀) from West Africa, presented by Mr. J. H. Cheetham, F.Z.S.; a Bonnet Monkey (*M. macacus sinicus* ♂) from India, presented by Mrs. Norman Yonge; a Razorbill (*Alca torda*), British, presented by Lady Hayter; four Snow Birds (*Junco hyemalis*), an American Coot (*Fuica americana*) from North America, presented by Mr. F. J. Thompson; a Hutchins's Goose (*Bernicla hutchinsi*) from Arctic America, a King Vulture (*Gypagus papa*) from South America, presented by Mr. W. A. Conklin, C.M.Z.S.; a Barn Owl (*Strix flammea*), British, presented by Mr. M. B. Windus; two Angulated Tortoises (*Chersina angulata*), two Areolated Tortoises (*Homopus areolatus*) from South Africa, two Geometric Tortoises (*Testudo geometrica*) from Little Namaqualand, presented by the Rev. G. H. R. Fisk, C.M.Z.S.; two Ceylonese Terrapins (*Clemmys trijuga*) from the Island of Diego, Garcia, presented by Commander the Hon. Foley C. P. Vereker, R.N.; a Pale-headed Tree Boa (*Epicrates angulifer*), an Antillean Snake (*Dromicus antillensis*), two Maculated Snakes (*Urogalia maculata*) from the Island of New Providence, Bahamas, presented by Mrs. Blake; a Tuatera Lizard (*Sphero-don punctatus*) from New Zealand, presented by Surgeon-Major

G. Henderson; a Spotted Cavy (*Calogenys paca*), a Blue and Yellow Macaw (*Ara ararauna*) from South America, deposited; a Blue Crested Tanager (*Stephanophorus leucocephalus* ♂) from Brazil, two Cape Doves (*Cena capensis*) from South Africa three Hardwicke's Spur Fowl (*Galliperdix lunulata* ♂ ♀ ♀), two Rufous Spur Fowl (*Galloperdix spadicea*), two Rain Quails (*Coturnix coromandelica*) from India, three Blackish Sternotheres (*Sternotherus subniger*) from West Africa, purchased; a Heloderma (*Heloderma suspectum*) from Mexico, received in exchange; a Burrhel Wild Sheep (*Ovis burrhel* ♂), a Red Deer (*Cervus elaphus*), six Upland Geese (*Bernicla magellanica*), five Long-fronted Gerbilles (*Gerbillus longifrons*), bred in the Gardens.

OUR ASTRONOMICAL COLUMN

MINIMA OF ALGOL.—In the calculation of the following Greenwich times of geocentric minima of Algol, the later observations of Schmidt have been brought to bear:—

	h.	m.		h.	m.
August 12	14	35	September 24	14	43
15	11	23	27	11	31
18	8	12	30	8	20
September 1	16	14	October 14	16	23
4	13	3	17	13	12
7	9	51	20	10	0
12	17	54	23	6	49

It is much to be desired that the observation of this star should be taken up in a systematic manner by one or more observers. We have been indebted to the late indefatigable astronomer at Athens for nearly all the published determinations of minima during the last ten years.

THE COMET 1858 III.—Herr Spitaler, of the Observatory at Vienna, who has been searching for some time past for this comet with the 27-inch refractor along the track defined by the calculations of M. Schulhof, remarked on May 26 three small, faint, uncatalogued nebulae, of which, owing to rapidly-advancing clouds, he was only able to secure the following approximate places:—

	h.	m.	s.	Declination	...	+	°	'	3"
1. Right Ascension	17	40	50	...	+	35	33		
2. "	17	42	0	...	+	35	33		
3. "	17	42	10	...	+	35	33		

A period of almost unexampled bad weather followed, and it was not till June 17 that observations could be repeated; the first of the three nebulae was then missing, and its disappearance from the position where it had been observed on May 26 was confirmed with the same instrument on the night of June 20. Its place is close upon that given in M. Schulhof's ephemeris if the comet's mean anomaly is assumed to have been 8° 33' at midnight on May 26.

It is not clear from what elements the positions assigned in the sweeping-ephemeris have been derived. In M. Schulhof's most probable orbit the period of revolution is 6.61 years. If we assume four revolutions to have taken place between 1858 and 1884, we find a period of 6.478 years, and reducing by the factors for  $d\mu$  in *Astron. Nach.* No. 2592, in the most probable ellipse, and bringing up the longitudes to May 26, 1884, we have the following constants for the comet's equatorial coordinates:—

$$x = r \cdot [9.99985] \cdot \sin(\nu + 291 27' 5)$$

$$y = r \cdot [9.99890] \cdot \sin(\nu + 201 33' 8)$$

$$z = r \cdot [8.87720] \cdot \sin(\nu + 181 14' 6)$$

If the true anomaly, May 26.5 G.M.T., be assumed to be 49° 36' 6", we find that the calculated right ascension agrees with that observed, but the calculated declination is 3° 34' too small. And M. Schulhof's definitive orbit for 1858 shows a similar discordance in declination, when the computed and observed right ascensions are made to agree. A comparison (made as a check) with the observed longitude and latitude leads to the same inference. It will be of interest to learn upon what elements M. Schulhof has founded his predictions.

If the comet's mean period between 1858 and 1884 were about 6.478 years, it might have approached the planet Jupiter in the middle of September 1880, within 0.97 of the earth's mean distance from the sun, a sufficiently near approach to cause a sensible, though not very important effect upon the elements defining the position of the plane of the orbit.

The intervention of unfavourable weather at Vienna after May 26 was particularly unfortunate, as the comet in the observed position would be receding from both earth and sun, and consequently the intensity of light would be rapidly diminishing, thus rendering a further observation after June 17 almost hopeless. It will remain for M. Schulhof to decide whether the object observed and missed at Vienna was really the comet the return of which he had led astronomers to expect, or another body. Possibly the discordance noticed above may be explained by error in the orbit as printed.

THE PHYSIOLOGICAL BEARING OF ELECTRICITY ON HEALTH

THE reader of the paper commenced by stating that electricity as at present used is at once a source of danger, a possible cause of sickness, and a remedy.

In all these cases it has been insufficiently studied, and continues to be ill understood. This condition of affairs is probably due to the fact that from the great subdivision of modern science, a competent knowledge of physics as well as of physiology is rarely acquired by the same person, whereas, for accurate work it is essential that so powerful an agent should be measured by accepted units. What little has been done by the physiologists is marred by considerable errors as to the force actually in use. Indeed much of it requires total revision in the light of modern discoveries.

1. Dangers to sight were very briefly considered. It was noted that the incandescent and the arc light subjected the eyes to two totally different risks, the former from heat rays at the less refrangible, and the latter from actinic and chemical action at the more refrangible, end of the spectrum. To obtain a sufficient protection in both cases, a pair of eye-protectors, made for the speaker by Mr. Baker of High Holborn, was shown, in which the front glass was blue, and the side "blinker" deep red. The former could be used alone for incandescent lamps, to remove glare, and lessen irritation; while the side glass could be turned down over the blue when powerful arc lights had to be gazed at. If the two tints were well selected and combined by means of the spectroscope, a very handy and simple appliance was obtained, clearly conducive to health. 2. Dangers to life and health were more minutely adverted to. Causes of death may be:—(1) By catalytic action; (2) by thrombosis of the larger vessels; (3) by shock and syncope, due to action on the cardiac nervous system. It was admitted that, considering the enormously increased power of our modern sources of electricity, accidents had been singularly few; and indeed it was abundantly proved that a large steady current, even of considerable magnitude, was comparatively harmless to the human economy. Rapid fluctuations, especially at the starting or breaking of the circuit, were much more dangerous; and still more so if by accident, or by the impregnation of the skin with conducting saline solutions, the resistance of the body was reduced to a minimum. In reviewing the recorded accidents, at the Birmingham Music Hall, in Paris, at Hatfield, and on board the Russian yacht, it was obvious that they were not all to be classified under the third heading given; inasmuch as life in some cases had been prolonged for three-quarters of an hour after the accident. Probably thrombosis in some form would account for them; but more precise information was much needed. Dr. Stone then proceeded to consider certain remedial and physiological points. 1. Several common errors were corrected, especially that of imperfect contact. 2. Any approximate determination of the electrical resistance of the human body to low and high tension currents respectively was described. 3. Use of the telephone and meter-bridge for measuring this resistance demonstrated; and 4. Measurements of E.M.F. of high tension alternating currents by dynamometer and quadrant electrometer were given. Much of this had already appeared in the pages of NATURE on June 14 and September 13, 1883, and on April 3 of the present year. The great need for an electrical testing establishment open to observers at large, like that at Kew, was insisted on, and might well be undertaken by the Society. Lastly, a few suggestions were thrown out as to the therapeutical uses to which electricity, administered, not as now, haphazard, but quantitatively and scientifically, might be put. These were classified as (1) muscular, (2) sensory, (3) neurotic, (4) eliminative, (5) vaso-motorial.

1 Abstract of a paper by W. H. Stone, M.A., M.B. Oxon, F.R.C.P., Member, at the Conference of the Society of Telegraph Engineers at the Health Exhibition, July 4.

THE MOVEMENTS OF THE EARTH<sup>1</sup>

V.

WE last appealed to those branches of physical science which are connected with the determination of the velocity of light, in order to see whether we could get any help in that direction on a most interesting question, a question which, like another to which attention has been drawn, might have been considered as an open one, unless one had gone beyond the range of ordinary astronomical observation with regard to it. It has now been seen that by investigating the facts connected with the velocity of light, first, that we could determine that velocity by two different methods with a wonderful agreement between them; and secondly, that, by taking the velocity of light and dealing with it in the way we then did, a perfect demonstration was obtained of the fact that the earth revolves in an orbit round the sun. It was further seen that using this velocity of light, and also this fact of the earth's revolution which it enabled us to demonstrate, we were able to say that the distance of the earth from the sun was, roughly speaking, 92½ millions of miles.

We will now go more into detail with regard to the precise form of the earth's orbit, and consider some of the conditions under which the earth's movement in that orbit takes place. In proceeding to do this let us first suppose the orbit of the earth to be in the form of a circle with the sun in its centre, then it is perfectly clear that the earth will always be at exactly the same distance from the sun, and that consequently the sun as seen from the earth will always appear of the same size; but on the other hand if the earth does not move in a truly circular orbit round the sun, then, unless she moves with great irregularity—and we shall see subsequently that she does not, the only other possible course for her to take is an elliptical one, because if she took an orbit of any other form—that of a parabola or an hyperbola for instance—she would not revolve about the sun at all, she would not have a succession of years each of 365½ days' duration, but one year, a year of infinite length; she would in fact go off at a tangent into infinite space.

Let us then consider what will happen if the earth instead of moving in a circular, travelled in an elliptical, orbit, with the sun in one of its foci, and not in the centre of figure; then it is perfectly clear that the distance of the earth from the sun will vary, that she is nearer the sun at some points of her orbit than at others. So much for supposition. Let us consider the facts. We know that it is the duty of the astronomers at Greenwich to make daily observations, when possible, of the transit of the sun, by means of one of those transit instruments to which reference has been made. Now if the sun, as seen from the earth, had always the same apparent diameter, it is obvious it would always take exactly the same time to cross the central wire of the transit instrument; but when we turn to the record of the observations made at Greenwich we find this:—Take the year 1878. On January 9 in that year the apparent diameter of the sun was 33' 33" 50 of arc, whereas on July 13 of the same year it was 31' 30" 24; the apparent diameter was less, so that if these observations are to be depended on—and I know of none better—we were nearer the sun in January 1878 than we were in July. If that be so, then there should be two intermediate points when the diameter of the sun was the same, with an interval of six months between them. This is what was observed on two such dates in this same year, on April 5 an apparent diameter of 31' 58" 16, and on October 5 an apparent diameter of 32' 5" 17. In this latter case we have a difference only of 7" 01; in the former case a difference of over 2', so that the Greenwich observations quite justify the supposition that the earth moves, not in a circle, but in an ellipse; because, the greater the distance of the sun from the earth, the smaller it must appear. While we are on this subject of the ellipticity of the earth's orbit, I am anxious to draw your attention to the two diagrams, so that the matter may be as clear as possible. Let us consider the diagram, Fig. 43. We have drawn there an ellipse, and the earth is assumed to move in the direction of the arrow round the sun placed in one of its foci, s.

Now by the construction of an ellipse we know that s b, which represents the mean distance between the earth and the sun, is exactly the same as the distance A O or P O, which represents what is known as the semi-axis major of the ellipse; further, the eccentricity of any ellipse is defined by the ratio of O s to O A; when the distance O s is very large as compared with O A, then the ellipse is a very flattened one, and the shorter the distance O s

as compared with O A the less flattened will be the ellipse and the more nearly will it approach a circle. It will now be clear why the two points are marked A and P, for if s be taken to represent the focus of the ellipse actually occupied by the sun, the point P will represent the place occupied by the earth when it is nearest the sun, which is called by a Greek word, "perihelion," whilst this other point A will mark that point in the orbit of the earth when it is farthest removed from the sun, this being called by another Greek word, "aphelion." This aphelion distance represents the semi-axis major plus the eccentricity, and the perihelion distance of the earth from the sun is obtained by a subtraction of the value of the eccentricity from that of the semi-axis major. These statements are general with regard to ellipses, and in order to make the point quite clear, we have shown them on the very flattened ellipse of Fig. 43, but the true form of the earth's orbit very nearly approaches a circle. If we want to find the greatest distance and the least distance of the earth from the sun at the opposite points of the orbit, we take the best value we can get of the mean distance s B, or O A, which is the same thing, and it is found that the eccentricity comes out about 1½ millions of miles, so that the greatest distance of the earth is less than 94½ millions, whilst its distance at perihelion is a little more than 91½. So much then for the facts with regard to the varying distances at which the earth is found from the sun at different periods of the year.

The next point is this: if the earth moves in this elliptic path round the sun, does she always move with the same velocity, does she go more quickly at some times than at others, or does she travel always with a steady, constant pace? Now here again the question can easily be answered by an appeal to the

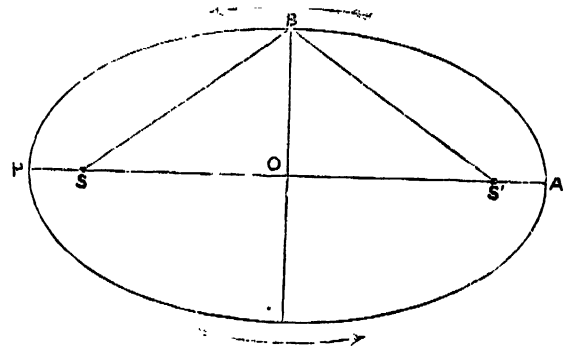

Fig. 43.

useful transit instrument. Our sidereal clock gives us a method, of determining the interval, true to the hundredth part of a second, between one transit of the sun over the central wire of the instrument and another, and so enables us to determine the number of degrees, minutes, seconds, tenths of seconds, and hundredths of seconds of arc passed over by the sun in that time. If the earth, therefore, in her revolution round the sun moves with an equal unchanging motion then it is clear that the number of degrees, minutes, and seconds of arc passed over in any given time will be always the same. Let us again consider the facts according to the Greenwich record. On December 27, 1877, the transit of the sun's centre occurred at 18h. 25m. 44' 9s. sidereal time, but on the day before it took place at 18h. 21m. 18' 5s. If this second quantity be subtracted from the first, the difference comes out as 4m. 26' 4s., that being the amount of arc passed over by the earth in that interval. Now on June 29 of the same year we get oh. 33m. 51' 7s., whereas on the 28th the time was oh. 29m. 43' 3s., a difference of 4m. 8' 4s. It is thus obvious that the motion of the earth is not uniform, and that being so, the question arises, Is this want of uniformity constant, or is it irregular? Is there, in short, any law governing it? It will be seen that there is a most perfect law about it; that when the sun looks biggest, that is to say, when we are nearest the sun, the earth moves most quickly, and that when the sun looks smallest from the earth, when the earth is at its greatest distance from the sun, it moves with its least velocity. This fact brings us face to face with a most fundamental law of astronomy—that law which is known as the second law of Kepler. This can be gathered from Fig. 44. Here s represents the sun in one focus of the ellipse

<sup>1</sup> Continued from p. 113.

representing the orbit of the earth, and we have P, P<sup>1</sup>, P<sup>2</sup>, P<sup>3</sup>, P<sup>4</sup>, and P<sup>5</sup> representing different positions of the earth at different times of the year, the distance between these points P and P<sup>1</sup>, P<sup>1</sup> and P<sup>2</sup>, and P<sup>2</sup> and P<sup>3</sup>, and P<sup>3</sup> and P<sup>4</sup>, and P<sup>4</sup> and P<sup>5</sup> representing the portions of the orbit passed over by the earth in equal intervals of time. This law is known as the Law of Areas. It states that in equal intervals of time the radius vector or line joining the earth and sun passes over equal areas in its revolution. Thus the area of the triangle S P P<sup>1</sup> is equal to the area of the triangle S P<sup>2</sup> P<sup>3</sup>, and is also equal to the area of the triangle S P<sup>4</sup> P<sup>5</sup>, and these areas of the orbit are passed over by the radius vector in equal intervals of time. When the earth is nearest to the sun she travels most quickly; when she is at her greatest distance from the sun she

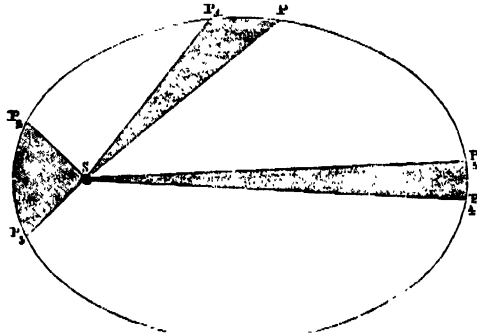

FIG. 44.—Explanation of Kepler's second law.

travels most slowly; and thus she keeps the figures inclosed by the radii vectores always of equal area during equal times. Let us be quite clear on this point: the law is not that the earth moves through equal distances in equal times, but that the areas of the spaces swept over by the radius vector are the same for equal intervals of time.

We come then to this: that the earth moves round the sun; that she moves in an ellipse; that she moves unequally, that is to say, with different velocities at different times, but that these different velocities are bound together by a well-defined and well-recognised law.

Now comes another question connected with this movement of the earth round the sun. When the movement of the earth on its axis was being discussed, it was pointed out that observations made by the transit instrument gave ample evidence that the movement was a perfectly equable one, and of such a nature that the axis of movement remained always practically parallel to itself. Attention must now again be turned to this axis of rotation. Let us take the earth in any part of its orbit, then the question is this: Is the plane of the earth's motion round the sun, or, as it must now be called, the plane of the ecliptic, identical with the plane of the earth's motion of rotation? That is to say, if the earth were half immersed in an ocean of infinite extent, whilst it was performing its orbital motion, would its axis of rotation be at right angles to the surface of the ocean in which it swam. Suppose we had a globe to represent the earth, and on it a model of a transit instrument were placed in the direction it is pointed at Greenwich when the sun is being observed. Then if the axis of the earth were really vertical the instrument would always be at right angles to it, or practically so, for sun observations. Further, if the model were turned round to represent one rotation of the earth, then if the axis on which it turned were really perpendicular, the sun's declination would remain unchanged, and its polar distance would always be 90°. Now let us refer to the Greenwich observations of the north polar distance of the sun.

On March 16	N.P.D. was	91° 34'
"    22	"    "	89° 12'
June 22	"    "	66°

That is to say, the observers at Greenwich in going from March to June had to alter the inclination of their instrument, in consequence of this variation in the N.P.D. of the sun, to the extent of the difference between 90° and 66°. On September 21 of the same year the N.P.D. was 90°, but on December 17 instead of being 90°, or 66°, it was 113° 24'. How can these facts be explained? Suppose we had a lighted lantern to represent the sun, and round it four globes were placed with their axes verti-

cal to represent the earth in four different positions in its orbit. It will be obvious that if we bring the light of the lamp in succession upon the four globes with the axes in each thus vertical, then the zenith distance of the sun, represented by the lamp, would be the same in each case. In this position of the globes we get the boundary of light and darkness at the poles, and the line joining the centres of earth and sun



FIG. 45.—Diagram showing the equality of the sun's zenith distance at the two equinoxes. N, north pole of the earth; S, south pole; Z, zenith of Greenwich.

will give us the zenith distance of the latter. Now assume that the axis of the earth is not vertical but is inclined 23½° to the plane of the ecliptic. In that case its spin of course would not be at right angles to this plane. If the four globes were then illuminated in succession, it would be found that the presentation of Greenwich to the sun would be vastly different at the four

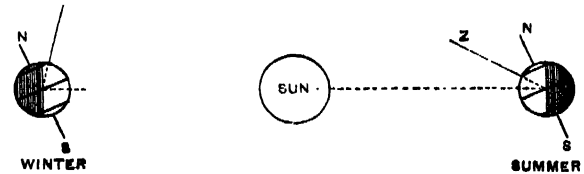

FIG. 46.—Diagram showing the variation of the sun's zenith distance from solstices to solstices. N, north pole of the earth; S, south pole; Z, zenith of Greenwich.

different positions. In the first, if it were placed in the proper part of the orbit, we should get Greenwich, not turned fully to the sun, but still well in his rays. In the second one we should find the vertical at Greenwich pointing very much more to the sun than before, when the axis was vertical. In the third globe the conditions would be about the same as in the first, while in



FIG. 47.—The earth, as seen from the sun at the summer solstice (noon at London).

the fourth the line which points towards the zenith at Greenwich, instead of being turned almost directly to the sun, would be turned most away from it. This fourth position is that in which the zenith distance, and therefore the N.P.D., was greatest, *i.e.* when it was 113°. The second represents the position of the earth when it was the least possible, whilst the first and third positions would



occur when the N.P.D. of the sun was neither great nor small, but midway between the two extremes. These facts will be made clearer by the accompanying woodcuts, in which the globes are shown in four different positions. Fig. 45 represents cases 1 and 3, and Fig. 46 cases 2 and 4. In Figs. 47 and 48 these facts are shown in different ways: Fig. 47 represents the aspect of the earth as seen from the sun at the summer solstice, when it will be seen that England is seen to lie near to the centre of the hemisphere; while in Fig. 48, representing the conditions at the winter solstice, England is so near the edge that it cannot be properly represented. This experiment then will enable us to go further, and to say that the plane of the earth's equator, and therefore of the earth's spin, is not parallel to the plane of the ecliptic, but is inclined to it at an angle represented by the difference between  $90^\circ$  and  $66^\circ$ , or  $90^\circ$  and  $113^\circ$ ; that is to say, the angle between these two planes, that of the earth's rotation and that of its revolution, is something like  $23^\circ$ .

In the non-coincidence of these two planes we have one of the most fundamental points in astronomy, for the reason that what Greenwich is to earth measurement the point of intersection of these two planes is to heaven measurement. The result of this inclination of these two planes is that at one particular point in its course round the sun the equatorial plane of the earth seems to plunge below the plane of the ecliptic, whilst at another and an opposite point it seems to come up from below that plane.

These two points are known as the nodes of the orbit, the



FIG. 48.—The earth, as seen from the sun at the winter solstice (noon at London).

ascending node at that point where the earth comes up from below, the descending node when it is plunging down from above. It will be remembered that when the question of terrestrial longitude was occupying our attention it was pointed out that it might begin anywhere: we begin at Greenwich, the French prefer Paris, the Americans Washington, and so on. With regard to celestial longitude, although it also might begin anywhere, yet there is a general agreement among astronomers that the right ascension of stars shall be counted from this ascending node, or, as it is otherwise called, the first point of Aries, where we get the intersection of the earth's plane of rotation with the ecliptic plane of revolution. That is the start-point not only of right ascension for the stars, but of celestial longitude, because it is necessary that we should have a means of determining the positions of stars, not only with reference to the plane of the earth's rotation, but with reference to the plane of the ecliptic itself, and the number of degrees which a heavenly body is observed above or below that plane (such degrees being called degrees of celestial latitude) require to be known in order to determine absolutely the position of any star. With the transit instrument and the sidereal clock the precise angle of intersection of these planes is determined, but it is necessary to know also the precise point in the orbit at which the intersection takes place, before we can use either our transit instrument or our clock for the determination of the precise position of a heavenly body. And

now that so much has been said, we can go further with regard to our sidereal clock, and say that it shows oh. om. os. when the first point of Aries is exactly on the central wire of the transit instrument, and that it will come back to that time, oh. om. os., after an interval of twenty-four hours. In that way, by discussing the point of the intersection of the planes, we come to the conclusion not only that the earth's axis is inclined  $23\frac{1}{2}^\circ$  to the ecliptic plane, but that we have at that point the most convenient starting point both for the right ascension of stars as determined by a sidereal clock, and the longitude of stars, if we choose to define their positions with reference to the ecliptic plane, instead of with reference to the plane of the earth's rotation. It is curious how in dealing with these matters we find that phenomena apparently the most diverse are really bound up in a most intimate connection with each other. In further considering the subject it will be seen that not only do we get these precious start-points from these considerations, but that they bring before us questions of the greatest interest and value to all earth-dwellers, questions that enable us accurately to study not only time as applied to the dealing out of our days and nights, as applied to those changes which take place during the year, as applied to those changes which effect the years themselves, but as applied to those yet greater changes which have probably been going on in this planet of ours for very many millions of years.

J. NORMAN LOCKYER

(To be continued.)

### ZOOLOGICAL NOMENCLATURE

ON Tuesday last week a meeting was held in the Lecture Room of the Natural History Museum, where a number of leading British zoologists assembled to meet Dr. Elliott Coues, who is now on a visit to this country, and to hear from him an exposition of the views advocated by himself and the leading American zoologists with regard to the adoption of Trinomial Nomenclature.

Among those present were representatives of many branches of science, and we noticed the following British naturalists:—Lord Walsingham, Prof. Flower, F.R.S., Dr. Günther, F.R.S., P. L. Sclater, F.R.S., Dr. H. B. Woodward, F.R.S., Prof. Traquair, F.R.S., W. T. Blanford, F.R.S., Henry Seebohm, F.L.S., Howard Saunders, F.L.S., Prof. F. Jeffrey Bell, J. F. Harting, F.L.S., G. A. Boulenger, H. T. Wharton, F.L.S., S. O. Ridley, F.L.S., W. F. Kirby, Sec. Ent. Soc., Herbert Druce, F.L.S., W. R. Ogilvie Grant, and R. Bowdler Sharpe, F.L.S.

The chair was taken at 3 p.m. by Prof. Flower, F.R.S., the Director of the Natural History Museum, who briefly opened the proceedings by reading a letter from Prof. Huxley, P.R.S., expressing his great regret at not being able to be present, being prevented by pressure of official business.

The Chairman said:—The subject we have met to discuss is one of extreme importance as well as difficulty to zoologists, for though in so many respects the name attached to any natural object is the most trivial and artificial of any of its attributes, and may hardly be thought worthy of scientific consideration, laxity in the use of names causes endless perplexities and hindrances to the progress of knowledge. I must confess that I feel some sympathy with the young lady, lately quoted in a speech by Sir John Lubbock at the University of London as an instance of hopeless stupidity, who, after listening to a lecture on astronomy, said she had no difficulty in understanding how the distances, motions, and even chemical composition of the stars were discovered, but what puzzled her was how their names were found out. Now, I have often had little difficulty in making out the characters and structure of an animal, and even the functions of some of its organs, but when I have to decide by what name to call it, I am often landed in a sea of perplexity. Yet those of us who work in museums are constantly engaged in cataloguing and labelling, and we are supposed to be able at once to give the correct name to every creature in the collection. I hope that this discussion will help to clear up our ideas upon the subject. With the impartiality due from the chair, I shall not give any opinion upon the merits of the rival schemes to be proposed, at all events not until after hearing the arguments to be brought forward for or against them, and I cannot say that I am very sanguine of being able to do so then. I now call upon Mr. R. Bowdler Sharpe to read a paper "On the expediency, or otherwise, of adopting Trinomial Nomenclature in Zoology."

Mr. Sharpe then read his paper:—I approach the discussion of this subject without the least prejudice either for or against the adoption of trinomial nomenclature. It has been for some time recognised and allowed by zoologists on the other side of the Atlantic, and to a certain extent the principle has been admitted by more than one worker in the Old World, but the presence in this country of one of the most able advocates of the system in the person of that distinguished American zoologist, Dr. Elliott Coues, has recently stimulated the thoughts of many of us as to the wisdom of its adoption for the zoology of the Old World, and it occurred to me that a friendly meeting to discuss the matter with Dr. Coues and some of our leading British zoologists could certainly do no harm, and might be productive of a considerable amount of good. Understanding from Dr. Coues that he would not object to attend a small conference of zoologists on this subject if we desired to talk over the matter, I appealed to many of the latter to appear to-day, and I think that this gathering of British naturalists, under the presidency of our esteemed director, Prof. Flower, is sufficient to show that there is a considerable amount of keen interest felt in the solution of the question.

It is now more than ten years ago that Dr. Coues, in his "Key to the North American Birds," first began to adopt the trinomial nomenclature which is now so generally accepted by American ornithologists. But until quite recently both he and his coadjutors have been in the habit of inserting the word *var.* before the sub-specific name. At present, however, the system which he adopts is trinomialism pure and simple, and this is shown in the second edition of his "Key," which has just appeared.

Now I can only speak as an ornithologist, and my views must be regarded as purely personal; but I do think that it is good for zoologists in general to learn from the lips of Dr. Coues exactly what the system is which he proposes to adopt for ornithology, and to what lengths it would lead us. I shall listen with attention and respect to the remarks with which any of my colleagues learned in other branches of zoology may favour us this afternoon.

It seems to me that there are certain facts in nature which we all of us recognise as facts, but about the expression of which many of us entertain different views. I propose merely to place before you certain difficult aspects of the question as they present themselves to me, and I shall be glad to have an expression of opinion upon the facts which I bring forward. I would therefore crave permission for a few moments to run over some of the published volumes of the "Catalogue of Birds," and to discuss some changes of nomenclature that might be involved if the trinomial system were to be adopted in a second edition of that work. It will be noticed that in 1874 I recognised the existence of "sub-species" among the *Accipitres*, and I now lay on the table one of the most interesting examples of what I conceive to be a series of sub-species, or representative races, of one dominant form. In Southern Africa we have a small Goshawk called *Astur polyzonooides*, which inhabits the whole of the South African sub-region, but does not, so far as my knowledge goes, extend beyond the Zambesi. In Senegambia and North-East Africa it is replaced by a race called *Astur sphenurus*, in which the colour of the under-surface is much more delicate than in *Astur polyzonooides*. From Central Russia, throughout Turkey, Asia Minor, Persia, and Syria, a large race called *Astur brevipes* replaces the two foregoing sub-species, and forms a third. From Baluchistan, throughout India, and Ceylon, a somewhat smaller form, *Astur badius*, takes up the running, and throughout the Burmese countries, extending to Formosa and Hainan, we have yet another race, *Astur poliopsis*, which is a purer and more elegantly coloured edition of *Astur badius*. This little group of Goshawks has been well worked out, and we may fairly presume that we have the facts before us. Now I should like to know if this is a case where we might adopt the trinomial system, and call these birds

*Astur badius*,  
*Astur badius poliopsis*,  
*Astur badius brevipes*,  
*Astur badius sphenurus*,  
*Astur badius polyzonooides*.

At present, were I writing about the South African bird or the Abyssinian bird, I should never speak of them as *Astur badius*, which is the name belonging to the Indian bird exclusively, and I am not quite sure that we gain in this case anything whatever by adopting trinomial nomenclature. The same parallel may be

drawn with some of the species of *Scops* among the Owls, as may be seen by the series now exhibited, and here trinomial nomenclature might perhaps be employed. Thus the representative races of *Scops* *gju* would be *S. gju capensis* in Africa, *S. gju pennatus* from the Himalayas, *S. gju minutus* from Ceylon, *S. gju stictonotus* from China, *S. gju japonicus* from Japan, *S. gju malayanus* from Malacca, *S. gju rufipennis* from Madras, and *S. gju brucei* from North-Western India.

In the third volume of the "Catalogue" I have again freely admitted "sub-species," as, for instance, with some Crows, e.g. *Corone macrorhyncha* from the Sunda Islands, replaced in India and China by *C. leucillanti*, which extends to Eastern Siberia, but is further replaced in Japan by a large race—*C. japonensis*. In this instance I believe that the trinomial nomenclature could be employed with advantage, for if we spoke of *C. macrorhyncha japonensis* or *C. macrorhyncha leucillanti*, it would convey to us an absolutely definite idea, viz. that these were merely forms of the typical *C. macrorhyncha* with a distinct geographical area assigned to each.

To take another case of a different kind. I place on the table several species of *Chibia* from the Malay Archipelago, and the difficulty which anybody would find at first sight in the separation of these Moluccan Drongos can be explained off-hand by the fact that they are nothing more nor less than representative insular forms of one dominant species. If, therefore, you speak of these birds as *Chibia carbonaria* from the Papuan group of islands, represented by *C. carbonaria assimilis* in the Aru Islands, by *C. carbonaria amboinensis* in Ceram and Amboina, and again by *C. carbonaria atrocerulea* in Batchian and Gilolo, I contend that these names, although long, convey an exact impression of the value of these forms, which are so closely allied as to be almost indistinguishable. A more difficult question arises when we come to treat of the Yellow Wagtails, concerning which, curiously enough, there has been quite a consensus of opinion among some of the German ornithologists that they ought to be treated trinomially. Thus in the "Vögel Ost-Afrikas," by Drs. Finsch and Hartlaub, we find these birds spoken of as *Motacilla flava melanocephala*, &c., and the same phraseology is adopted by Baron von Heuglin in the "Ornithologie Nord-ost Afrikas." Having recently studied these birds, I can only say that I think the employment of trinomial nomenclature by these authors was somewhat premature, inasmuch as, from the showing of the writers themselves, these birds to which they gave trinomial names are not only migratory, but have well-defined geographical areas of distribution. I myself consider that the intermediate forms which undoubtedly exist are due to another and totally different cause, viz. to hybridisation, inasmuch as many of these birds occupy nearly the same winter areas in Africa, and doubtless many of them pair with birds of an allied form on their return to Europe. Thus *Motacilla kaleniczenkii*, which is *M. melanocephala* with a white eyebrow, is probably (although there is no proof of the fact) the latter species with a strain of the white-eyebrowed *M. flava* admixed, as both *M. kaleniczenkii* and *M. melanocephala* occur together.

There is one advantage which we must all admit that the American zoologists possess over ourselves, and that is, that they have a clear idea of the natural geographical divisions of their continent, and their zoology has been studied from many distinct points of view, such as the presence or absence of rainfall, &c., and it only requires a glance at Mr. Hume's essay on the distribution of Indian birds with respect to the distribution of rainfall throughout the Indian peninsula to see how very important is this aspect of the subject. Even in the British Islands there are variations in the size and coloration of some of our resident birds, as any one may learn from Mr. F. Bond, who has devoted sixty years of his life to the study of British ornithology, and who now has one of the most interesting collections in this country. But when we come to study the birds of Europe and the Palearctic region generally, how small is our real knowledge, and what vast areas are there concerning the ornithology of which we know next to nothing! Great praise is, therefore, due to men like Dr. Menzies, who has just written the first part of an elaborate treatise on the geographical distribution of birds in Russia; but it will be a long time before we can have in any museum such a series of birds as is possessed by the Smithsonian Institution for any one wishing to study the geographical distribution of the birds of North America. The British Museum is fully alive to the importance of the question, but I find that there is nothing more difficult than to procure from my colleagues in the other countries of Europe a representative set of

the common resident birds of their respective countries. The value of such collections as that which Mr. Seebohm is making cannot be over-estimated.

I have exhibited to-day three distinct illustrations of birds from the Old World where trinomial nomenclature might be employed. In the case of the Goshawks, the Scops Owls, and the Crows, I am not yet certain that my way of treating them in the "Catalogue" as sub-species is not as advantageous as the employment of trinomials. But in the case of the Long-tailed Titmice the circumstances seem to me different, and the adoption of trinomial nomenclature would be a positive advantage, because *Acredula caudata* undoubtedly mixes with *A. rosea* in the Rhine provinces and other parts of Europe; therefore in England, where the *rosea* strain is apparently pure and unmixed, it is advantageous to speak of the bird as *Acredula caudata rosea*, because such a name clearly conveys the idea that *A. rosea* is a form of *A. caudata*, with which it is connected by intermediate forms elsewhere. *A. caudata irbis* would also express the relationship of the South European bird, and *A. caudata trivirgata* the Japanese form.

The case of the Wagtails is not so clear, because we do not yet seem to have sufficient material to work upon. Even here some of the races might be fairly expressed by the employment of trinomials, as *Motacilla flava dubia* for the Siberian and Indian race of *M. flava*. *M. viridis* being a form without an eyebrow, would have a Mediterranean race, *M. viridis cinereo-capilla*, while *M. melanocapilla* has at least one race, *M. melanocapilla kalenitzensis*, unless the last-named ultimately proves to be a hybrid.

I may say in conclusion that the great difficulty which I perceive in the adoption of trinomial nomenclature, both at home and abroad, lies in the fact that it will open the door to a multiplication of species, or races, founded on insufficient materials, and bestowed by authors who have not sufficient experience of the difficulties of the subject; but I cannot conceal from myself that the code of nomenclature proposed by the British Association and followed by most of us scarcely accounts for the treatment of facts as they have been developed in zoological science since the promulgation of that code, and that before long it will be the duty of British zoologists to attempt its modification.

Mr. Henry Seebohm read the following paper:—The question of a binomial or trinomial nomenclature is not a very simple one. So long as ornithologists were under the delusion that all species were separated from each other by a hard and fast line, the binomial system of nomenclature was sufficient. Now that we know that many forms which have been regarded as species are connected by intermediate links with each other, and that many species present important local variations which cannot be ignored, we are obliged to admit the existence of sub-species as well as species. There can be no doubt that the tardy recognition by European ornithologists of what might not unreasonably be regarded as the most important fact in ornithology discovered during the present century has been very largely due to a pedantic adherence to a binomial system of nomenclature. Now that we have emancipated ourselves from the fetters with which our predecessors, with the best intentions in the world, cramped our ideas, the question arises, how shall we recognise in our nomenclature the existence of sub-specific forms; by a word, or by a sentence? The ornithologists of America think that a system of trinomial nomenclature will answer the purpose. They have come to the conclusion that the insertion of a third link in the chain which binds us will give our ideas scope enough. Their theory is that the judicious ornithologist will be able to select from the infinite number of steps which form the series of intermediate races which lie between two intergrading species, one, two, three, or even in some cases more local or climatic races which are worthy of being dignified by a name. This theory is on the face of it somewhat illogical. It credits ornithologists with an amount of discretion which their past history does not justify, and totally ignores the inordinate desire to introduce new names which is unfortunately too conspicuous in most if not in all ornithological writers, culminating in the absurdities of a Brehm. That ornithology should be preserved from being Brehmised must be the devout prayer of every well-wisher of the science. On the other hand, the recognition of sub-species by a sentence would be to revert to the customs of the præ-Linnean dark ages of nomenclature, a retrograde step from which all zoologists would instinctively shrink. Members of the British Ornithologists' Union are

probably all prepared to admit that a medium course is safest at least for an Ibis (*madia tutissimus ibis*), and, with a very slight modification, I for one am prepared to adopt the American system in spite of its dangers. If no paths are to be trodden in which the indiscreet may err, there is an end at once of all progress.

To point out the modifications which I propose to introduce into the American system of nomenclature to change it from an empirical system to a logical or scientific system, I will take as an example the Common Nuthatch (*Sitta europæa*) and show how the nomenclature of its various races may be made exhaustive, so that the temptation to introduce new names, which appears to be irresistible to the indiscreet ornithologist, may be minimised.

*Sitta uralensis*, with white under parts, is found in Siberia; *Sitta casia*, with chestnut under parts, is found in England; intermediate forms connecting these species together are found in the Baltic provinces. What can be more simple than to call the intermediate forms by both names, *Sitta casia-uralensis*? But there is a third species which turns up in China, *Sitta sinensis*, and which is also connected with *Sitta uralensis* by intermediate forms. Never mind; they too can be called by both names, and our series of Nuthatches runs geographically in an unbroken series:—

*Sitta casia*,  
*Sitta casia-uralensis*,  
*Sitta uralensis*,  
*Sitta uralensis-sinensis*,  
*Sitta sinensis*.

So far so good; but, unfortunately, two more complications arise. Besides the series running south-west into *S. casia*, and that running south-east into *S. sinensis*, two other series run from the central form *S. uralensis*, one running due west and then round by the Baltic into the Scandinavian *S. europæa* (a larger bird, and somewhat darker on the under parts), and a second running due east and then round the Sea of Okotsk into the Kamchatkan *S. albifrons* (a bird much paler on the head, which shades into white on the forehead), so that it is necessary to add four more names to the list, which will stand as under:—

*Sitta casia* is found in Britain, South-West and South Europe, and Asia Minor. It is medium in size, but extreme in the darkness of the chestnut of the under parts.

*Sitta casia-uralensis* (with a hyphen between the two specific names) represents all the forms intermediate between South European and Siberian examples, which occur in Denmark, Pomerania, the Baltic provinces of Russia, Poland, and the Crimea.

*Sitta europæa* is the Scandinavian form, and represents the extreme of size, whilst in colour it is intermediate between the forms found in the Baltic provinces of Russia and Central Siberia.

*Sitta europæa-uralensis* comprises all the intermediate forms in Russia which connect the Scandinavian with the Central Siberian forms.

*Sitta uralensis* is found in the valleys of the Ob, the Yenesei, and the Lena, and combines the small size characteristic of the various Asiatic sub-species of Nuthatch with the dark upper parts of the sub-tropical forms, whilst the under parts are nearly as white as in the Kamchatkan form.

*Sitta uralensis-albifrons* may be applied to all those intermediate forms found in East Siberia and the north islands of Japan which are not quite so pale on the upper parts as the Kamchatkan form.

*Sitta albifrons* is found in Kamchatka, and represents the extreme form so far as whiteness of the forehead and under parts is concerned.

*Sitta uralensis-sinensis* may be applied to the series of forms found in the valley of the Amoor, the island of Askold, and the main island of Japan. They are intermediate in colour between the Central Siberian and Chinese forms, and are scarcely to be distinguished from the Baltic province forms.

*Sitta sinensis* is found in China, and only differs from the British form in being slightly smaller and in not having quite so much dark chestnut on the flanks.

I have purposely chosen a complicated case in order to show the capabilities of the system, which, if the specific name of *europæa* is always repeated after the generic name of *Sitta*, becomes a compromise between that adopted by the Americans and that which I imperfectly carried out in the fifth volume of the "Catalogue of Birds in the British Museum," and which was originally suggested to me by a conversation with Mr. Salvin. It has at

least the merit of being exhaustive, and differs so slightly from that in common use in America that its adoption does not involve a change in, but only an addition to, the system which in some form or other is destined to supersede the binomial system now rendered inadequate by the acceptance of the theory of evolution.

As an example of the compromise I propose, I add a list of the local races of the Dipper, with their geographical ranges:—

*Cinclus aquaticus melanogaster* (Scandinavia).

*Cinclus aquaticus melanogaster-albicollis* sive *Cinclus aquaticus* (West Europe, as far north as the Carpathian and as far south as the Pyrenees).

*Cinclus aquaticus albicollis* (South Spain, Algiers, Italy, Greece).

*Cinclus aquaticus albicollis-cashmiriensis* (Asia Minor, Caucasus, Persia).

*Cinclus aquaticus leucogaster* (East Siberia).

*Cinclus aquaticus leucogaster-cashmiriensis* (Central Siberia).

*Cinclus aquaticus cashmiriensis* (Cashmere, South Siberia, and Mongolia).

*Cinclus aquaticus cashmiriensis-sordidus* (Altai Mountains).

*Cinclus aquaticus sordidus* (Thibet).

In this system it must be observed that wherever there is a fourth name it is always connected by a hyphen to the third name, and comprises all the intermediate forms between the two. It is somewhat cumbersome, but it provides for the contingency of any intermediate links that may occur. To express it algebraically, it provides not only for A B and B C, but also for A C. It is perhaps the only system which is theoretically perfect, but the question whether its voluminousness renders it impracticable or undesirable is one requiring careful consideration.

(To be continued.)

### UNIVERSITY AND EDUCATIONAL INTELLIGENCE

UNIVERSITY COLLEGE, BRISTOL.—A correspondent writes:—This session has been most successful, the numbers of students in attendance being considerably larger than in the two preceding years. Funds are wanted more seriously than ever to complete the building and provide additional accommodation. Nothing has yet been done towards an endowment fund. Mr. E. Buck, M.A., Lecturer in Mathematics, has resigned his position on the staff. The Demonstrator in Physics, Mr. Colman C. Starling, has also resigned his post in consequence of internal rearrangements. The Chair of Geology and Physiology, left vacant by the resignation of Prof. Sollas, has been filled by the appointment of Mr. Lloyd Morgan.

### SOCIETIES AND ACADEMIES

#### SYDNEY

Linnean Society of New South Wales, April 30.—Dr. James C. Cox, F.L.S., vice-president, in the chair.—The Hydromedusæ of Australia, part 2, by R. von Lendenfeld, Ph.D. According to the principles set forth in part 1 of this paper, the Hydromedusæ are classified in a new manner, and the Australian representatives of the first four families in this system are described or referred to. The paper contains descriptions of several new and interesting forms, and in every case an abstract of everything known on the histology of every species is given with references. The most interesting of the new forms is *Eudendrium generale*, the male polypastyles of which show a great similarity to Medusæ. They possess four aboral tentacles in the principal radii, and on these the spermatozoa reach maturity. These tentacular appendages are therefore homologous to the radial canals of the Craspedote Medusæ. Some deductions are drawn herefrom, and the homology of the parts in Medusæ and Polypes described differently to the views expressed by Allman and others. The Umbrella is not homologous to a web between the tentacles of the mouth, but between the generative tentacular processes at the aboral pole.—Revision of the recent Rhipidoglossate and Docoglossate Mollusca of New Zealand, by Prof. F. W. Hutton, F.G.S. The synonymy of all the species is fully given, with, in many instances, revised descriptions and notes on the dentition where known.—Notes on hybridism in the genus *Brachychiton*, by Baron Ferd. von Mueller, K.C.M.G., M.D., Ph.D., F.R.S., &c. The plant which is the subject of this paper is a beautiful tree of forty feet

in height and a stem diameter of one foot, grown at Fern Hill, near Penrith, New South Wales, and is an undoubted hybrid between *Brachychiton populneum* and *Brachychiton acerifolium*. Like most hybrids, the flowers never perfect their seed.—Mr. Macleay read a letter from the Rev. J. E. Tenison-Woods, vice-president of the Society, dated from Perak, February 27 last, giving a long and interesting account of his proceedings and experiences in the Malacca Peninsula. He had examined and reported on the rich tin mines of the settlement, and the geological features of the whole territory; and he had spent some time in the investigation of its zoological and botanical productions.

Royal Society of New South Wales, May 7.—Annual Meeting.—Hon. Prof. Smith, C.M.G., president, in the chair.—The Report of the Council stated that thirty new members had been elected during the year, and the total number on the roll, April 30, was 494. M. Louis Pasteur, M.D., of the French Academy of Sciences, had been elected an honorary member in the place of the late Dr. Charles Darwin, and Ottokar Feistmantel, M.D., Palæontologist to the Geological Survey of India, had been elected a corresponding member.—The Clarke Medal for the year 1884 had been awarded to Alfred R. C. Selwyn, LL.D., F.R.S., in recognition of his scientific labours in Great Britain and as Director of the Geological Surveys of Canada and of Victoria.—During the year the Society held nine meetings, at which the following papers were read, viz.:—Presidential Address by Chr. Rolleston, C.M.G.—On the aborigines inhabiting the great lacustrine and riverine depression of the Lower Murray, Lower Murrumbidgee, Lower Lachlan, and Lower Darling, by P. Beveridge.—On the Waranamatta shales, by the Rev. J. E. Tenison-Woods, F.G.S., F.L.S.—Further remarks on Australian Strophalosia, and description of a new species of Aucella from the Cretaceous rocks of North-East Australia, by R. Etheridge, jun., F.G.S.—On plants used by the natives of North Queensland, Flinders, and Mitchell Rivers, for food, medicine, &c., by E. Palmer (M.L.A. Queensland).—Notes on the genus *Macrozamia*, with descriptions of some new species, by Charles Moore, F.L.S., V.P.—A list of double-stars, by H. C. Russell, B.A., F.R.A.S.—Some facts connected with irrigation, by the same.—On the discoloration of white bricks made from certain clays in the neighbourhood of Sydney, by E. H. Rennie, M.A.—On the roots of the sugar-cane, by Henry Ling Roth, F.M.S.—On irrigation in Upper India, by H. G. McKinney, A.M.I.C.E.—On tanks and wells of New South Wales; water-supply and irrigation, by A. Poppys Wood.—Additions to the census of the genera of plants hitherto known as indigenous to Australia, by Baron F. von Mueller, K.C.M.G., F.R.S., &c.—The Medical and Microscopical Sections held regular monthly meetings. At the preliminary meeting of the Medical Section this year, the Chairman stated that never during the history of the Section had its meetings been so numerously attended, and that the value of the papers read before it was attested by the fact that so many of them had been reprinted in the Home journals.—The Council has issued the following list of subjects, with the offer of the Society's bronze medal and a prize of 25*l.* for each of the best researches, if of sufficient merit:—Series III. To be sent in not later than September 30, 1884. No. 9. Origin and mode of occurrence of gold-bearing veins and of the associated minerals. No. 10. Influence of the Australian climate in producing modifications of diseases. No. 11. On the *Infusoria* peculiar to Australia. No. 12. On water-supply in the interior of New South Wales. Series IV. To be sent in not later than May 1, 1885. No. 13. Anatomy and life history of the *Echidna* and *Platypus*. No. 14. Anatomy and life-history of *Mollusca* peculiar to Australia. No. 15. The chemical composition of the products from the so-called kerosene shale of New South Wales. Series V. To be sent in not later than May 1, 1886. No. 16. On the chemistry of the Australian gums and resins.—The Chairman read the Presidential Address, and the officers and Council were elected for the ensuing year.

#### PARIS

Academy of Sciences, June 30.—M. Rolland, President, in the chair.—Remarks on the hygrometric reports from nearly a hundred French stations, yearly published by M. Mascart in the *Annales du Bureau météorologique de France*, by M. J. Jamin.—On the use of formene in the production of very low temperatures, by M. L. Calletet. The author finds that, when slightly condensed and cooled in boiling ethylene under atmospheric

pressure, this gas is resolved into an extremely volatile colourless fluid, which, in again passing to the gaseous state, yields a degree of cold sufficient immediately to liquefy oxygen. Under these conditions the liquefaction of oxygen becomes one of the simplest operations of the laboratory.—Remarks on the project of creating a so-called inland sea in Algeria and Tunisia, by M. E. Cosson. The author regards as chimerical Dr. Rouire's scheme for converting the Shott Melghir into a marine basin by means of a canal, 145 miles long, communicating with the Mediterranean.—Note on the development of the graphic method of representation by means of photography, by M. Marey.—On a new species of Sirenian discovered in the Paris basin, by M. Albert Gaudry.—Observations on the new planet, 237 Palisa, made at the Paris Observatory (equatorial of the west tower), by M. G. Bigourdan.—On the effects of mutual forces: determination of a function represented by a simple curve involving most of the laws of general physics (one illustration), by M. P. Berthot.—Researches on the laws of diffraction of light in the shadow of an opaque screen with rectangular edge, by M. Gouy. In this paper the author's remarks are restricted to rays diffracted in the geometrical shadow, the edge of the screen being normal to the plane of diffraction containing the incident ray and the diffracted rays.—On certain chemical compounds obtained by means of a gas pile, and of appliances for subjecting the gases to electric effluvia, with tabulated results, by M. A. Figuier.—A method of transforming liquid to dry electric piles, by M. Onimus.—Further researches on the coagulation of colloidal substances, by M. F. Grimauz. Here the author deals first with substances whose coagulation is checked by dilution, secondly with those whose dilution stimulates coagulation.—Researches on the preparation of hydrated chromic acid, and on some new properties of anhydrous chromic acid, by M. H. Moissan.—On the production of the neutral orthophosphate of aluminium in the anhydrous and crystallised state, by M. A. de Schulten.—On a new alcohol derived from the birdlime prepared from the inner bark of the *Ilex a. uifolium*; note on a process of the late J. Personne, by M. J. Personne, jun.—Complementary observations on colchicine and colchicine, by M. S. Zeisel.—On the various processes employed for determining the phosphoric acid in the superphosphates of commerce, by M. E. Aubin.—On the efficacy of vinous yeast artificially prepared, by M. Alph. Rommier.—On the theoretical figures of certain simple substances (lithium, sodium, potassium, rubidium, cesium) forming a series, by M. L. Iugo.—On a new type of the leech family infesting crocodiles in the Senegambian rivers, by MM. Poirier and A. T. de Rochebrune.—On the fossil cones of the genus *Sigillaria* in the Carboniferous flora, by M. R. Zeiller.—Note on the assimilation of maltose in the animal system, by MM. A. Dastre and E. Bourquelot.—On the dyspepsia of liquids, by M. V. Audouin.—Note on a meteorite observed at Concarneau on June 28, 1884, by M. G. Pouchet.—On a meteorite observed at the Trocadero Observatory on the same night, by M. I. Jaubert.

## BERLIN

**Physiological Society, June 20.**—Prof. du Bois Reymond showed a rabbit with highly-deformed incisors, which had been reared in the Institute. The two lower incisors were several times their natural length, projecting deeply as they did into the nostrils, and were gladiate above and crooked behind. In the upper jaw only one incisor was of about the same size as either of the two under ones. Interiorly it was curved in the form of a semicircle, and rested in a furrow of the under jaw. Mastication, which was rendered difficult by the deformation of the incisors, was effected by lateral movements of the jaws.—Prof. Christiani spoke on the physiology of the brain, connecting his remarks with his former experiments, by which he had demonstrated the existence of two respiratory centres above the medulla oblongata, one of which, situate at the base of the third ventricle, was a centre for inspiration, the other located in the fossa sylvii for expiration. These two centres exercised an influence also on the heart, the one under moderate stimulation producing cessation in systole and retardation of pulsation, the other cessation in diastole and acceleration of pulsation. By the side of the inspiratory centre, and in association with it, Prof. Christiani found a co-ordinatory centre for collective combined movements of the body. On the excision of the brain of a rabbit, if these three centres were left uninjured, and if all considerable bleeding that might prejudicially affect the pre-

served parts of the brain were avoided, the animal acted entirely as in a normal state: it was able to walk, to run, to spring, to avoid objects in its way, to respond to impressions of seeing and hearing. If, on the other hand, the co-ordinatory centres were injured, these movements all failed: the animal lay on its side, and occasionally showed epileptiform convulsions. Prof. Christiani, having further communicated a series of detailed observations gathered from his experiments with disbrained rabbits, developed the hypothesis he had conceived for himself respecting the function of the brain. According to this hypothesis a large number of energies acted on the brain, in part directly, in part by the medium of the nerves, which, in the ganglia at the base of the brain, were transformed into reflex movements. To this primary circuit the cerebrum formed a kind of secondary circuit into which were derived a large number of the advancing energies, and there hoarded up. If the cerebrum were removed, then all energy was transposed into reflex movement, and consequently disbrained and decapitated animals manifested much stronger reflex movements than did such animals as possessed this secondary derivation. In the higher animals the energy distributed into the cerebrum formed ideas and consciousness, the quality of which might vary, even when the operative sensuous stimulations were completely equal, according to the relative activity of the particular parts of the cerebrum which were stimulated, and according to their configuration. With this conception of the function of the cerebrum Prof. Christiani could not accept the doctrine, advocated quite recently by Hitzig, Ferrier, and Munk, regarding the localisation of the activity of the cerebrum, and in support of his conception he adduced the highly contradictory data that had been accumulated on the sphere of vision. As was known, one portion of the observers, after removal of the sphere of vision, had found blindness to be the result, while another portion, after such an operation, had found that the animals operated on were yet able to see. These contradictions Prof. Christiani sought to reconcile by the assumption that the removal of the sphere of vision produced a stimulation which interfered with those derived from the sensuous organ, and so presented the appearance of the failure of the function.

## CONTENTS

	PAGE
The Cholera Germ . . . . .	237
Sully's "Outlines of Psychology." By Dr. George J. Romanes, F.R.S. . . . .	238
Our Book Shelf:—	
Hands' "Numerical Exercises in Chemistry" . . . . .	239
Licherdopol's "Chimie Elementara" . . . . .	239
McCormick's "Voyages of Discovery in the Arctic and Antarctic Seas and Round the World" . . . . .	239
Letters to the Editor:—	
Science and the Sandhurst and Woolwich Examinations.—E. Douglas Archibald . . . . .	239
Animal Intelligence.—T. W. Kirk; Dr. Henry MacCormac . . . . .	240
Butterflies as Botanists.—Dr. Fritz Müller . . . . .	240
Christian Conrad Sprengel.—Dr. Fritz Müller . . . . .	241
Voracity of the Drosera.—A. Balding . . . . .	241
Lightning.—Worthington G. Smith . . . . .	241
Solar Halo.—W. W. Taylor . . . . .	241
Insect Pests in the United States . . . . .	241
The Forestry Exhibition . . . . .	243
Technical School Education at the Health Exhibition. By Wm. Lant Carpenter . . . . .	244
Chemical Research in England . . . . .	246
On the Evolution of Forms of Ornament. By Prof. Jacobsthal. (Illustrated) . . . . .	248
Notes . . . . .	251
Our Astronomical Column:—	
Minima of Algol . . . . .	253
The Comet 1858 III. . . . .	253
The Physiological Bearing of Electricity on Health. By Dr. W. H. Stone, F.R.C.P. . . . .	253
The Movements of the Earth, V. By J. Norman Lockyer, F.R.S. (Illustrated) . . . . .	254
Zoological Nomenclature . . . . .	256
University and Educational Intelligence . . . . .	259
Societies and Academies . . . . .	259

THURSDAY, JULY 17, 1884

## PROFESSOR TAIT'S "LIGHT"

*Light.* By P. G. Tait, M.A., Sec.R.S.E., formerly Fellow of St. Peter's College, Cambridge, Professor of Natural Philosophy in the University of Edinburgh. (Edinburgh: Adam and Charles Black, 1884.)

THE issue of Prof. Tait's book on "Heat," recently reviewed in these pages, has been quickly followed by that of his book on "Light."

The book we are told is "not designed for those who intend to make a special study either of theoretical or of experimental optics, but for ordinary students who wish to acquire familiarity with the elements of the subject;" and its author has, as was to be expected, made it most interesting and suggestive.

The first three chapters are introductory and explanatory; we wish more space could have been found for the subject dealt with in Chapter II.—the theory of vision and colour perceptions; students' notions in general are so hazy on these points, and they are not well treated of in most of the books we are acquainted with. They fall between two stools; the physiologist considers them to belong to physics, the physicist to physiology.

In Chapter IV. the usual division of the subject into geometrical and physical optics is made. "For the explanation of the ordinary phenomena of light," says Prof. Tait, "even with accuracy sufficient for the construction of the very finest telescopes and microscopes, it suffices that geometrical optics based on laws *nearly* verified by experiment be followed out to its consequences. The residual phenomena then come in to be treated by the undulatory theory." Geometrical optics then is in the main the subject of the next 140 pages of the book, the remaining 106 pages being chiefly devoted to physical optics.

The geometrical part is excellent, and it, along with the whole book, has been rendered much more interesting by the frequent quotation, when describing some of the most important steps in the subject, of the actual words of the authors, or at all events of a close paraphrase of them. Thus Newton's celebrated discovery of the dispersion of white light is given as a quotation from his letter to Oldenburg. We in the present day gain much by reading the very words of the heroes of science, and learning with what feeble instrumental means they made their great discoveries; there is a tendency, which it is well to check, to think that nothing can be done in the way of scientific observation and discovery without the most elaborate instruments. Fresnel's apparatus in his country-house at Matthieu was the work of the village blacksmith, and Newton needed only his prisms, a measuring tape, and some screens to prove that "light is not similar or homogeneous, but consists of difform rays, some of which are more refrangible than others."

The whole chapter on refraction—Chapter IX.—and specially that part of it which deals with refraction through a prism (§ 129) and the relation between the deviation of a ray and the angle of incidence (§§ 125, 132, &c.) is particularly clear and good. The proof of the law that the

deviation of a ray passing through a prism in a principal plane is a minimum when the angles of incidence and emergence are equal (§ 134) is much more elegant than any we have seen before.

But for all this we confess to a strong feeling of regret when we read the statement of the author, quoted already, as to the sufficiency of geometrical optics, a feeling which was greatly intensified when we found how little use was to be made of the all-important law of least time stated for reflection in § 85, or in the more general form in § 82, viz. "If  $l$  be the length of the part of a ray which lies within a medium whose refractive index is  $\mu$ , the sum  $\Sigma \mu l$  is the same for each ray of the group between any two wave surfaces;" that is, according to the undulatory theory at least, the time is the same along all rays from one wave surface to another of the same system.

For the fundamental formulæ for mirrors and lenses can be deduced by a simple geometrical method from this law; this Prof. Tait points out, while the method has the great advantage that it can be extended readily to include problems in which spherical aberration is considered. Lord Rayleigh's investigations in optics, published recently in the *Philosophical Magazine*, are a distinguished example of its powers. The full treatment of spherical aberration is of course outside the limits of Prof. Tait's work, but still it would have added to its completeness had the book contained some elementary examples of the use of the method in question. Besides the law is the real link between geometrical and physical optics. That *one* ray of light can exist only when accompanied by other contiguous rays is a fact on which the teacher can scarcely too often insist, and the solution of problems in geometrical optics by the method of least time forms the best introduction to the important principle of interference required in physical optics. Prof. Tait's method is admirable for a book on "Geometrical Optics"; in a book on "Light," however, we look for something more than he gives us on the connection between geometrical and physical optics; and the development of some of the elementary consequences of this law of minimum time seems to us to afford the most suitable opening for considering that connection.

Chapter XII. on absorption and fluorescence, is made specially interesting by the quotation of an account of an experiment of Fox Talbot on anomalous dispersion, made about 1840, but not published till 1870. The method he adopted to obtain prisms of a substance showing anomalous dispersion is very beautiful and ingenious. The account is too long for quotation; we must refer the reader to Prof. Tait's book, p. 156.

The fundamental difficulty of the undulatory theory—the rectilinear propagation of light—is assailed in Chapter XIII., and in dealing with this subject we think that Prof. Tait gives too much credit to that great physicist, Huyghens. He was of course the first to give the undulatory theory definite form, and *if we allow him to make one great assumption*, he explained perfectly correctly the rectilinear propagation, the reflection, and the refraction of light. But in Huyghens' work there is an assumption the importance of which it is impossible to overlook.

"What Huyghens did not see sufficiently clearly," says Verdet (*Optique Physique*, tome i. pp. 33, 34), "was why each of the elementary waves is only effective at the

point in which it touches the envelope. He contented himself with saying that the movement which exists over each of the elementary waves must be infinitely feeble compared with that which exists over the envelope," while he remarks that "this must not be examined with too much care or nicety"—"recherché avec trop de soin ni de subtilité" are his words. Nor was Huyghens in a position to give the necessary demonstration, for, to quote again from Verdet, "He never supposed that there was any general relation between the movements of these successive waves, he never combined their effects, and in particular the notion of the constant interference of two sets of vibrations bringing to one and the same point movements of opposite phase is absolutely foreign to him."

Now it is this notion of interference, which is entirely due to Thomas Young, combined with the excessive smallness of the wave-length of light that renders Huyghens' assumption correct.

"It is to Young," says Verdet, "that the honour belongs of having first applied to optical phenomena the principle of interference," and Prof. Tait recognises to the full Young's claims to this distinction; the point on which we would insist is that this principle is needed for the elementary explanation of the rectilinear propagation, the reflection, and the refraction of light, as well as of diffraction and the colours of thin plates; the principle is due to Young, and Huyghens' explanation rests on an assumption which he did not prove.

Prof. Tait regrets in his preface that his book was all in type before Prof. Stokes's "Burnett Lectures" appeared. We will quote a few lines from them bearing on the point. After referring to Huyghens' principle, he says (p. 19):—"This principle does not by itself suffice for the explanation of rays. It proves, or at least appears to prove, too much. It is as applicable to sound as, on the supposition that light consists in undulations, it is to light; and if Huyghens' explanation of rays were complete, there ought equally to be rays of sound, and sound ought to present the same sharp shadows as light."

As Young received in his own day the most unjust treatment at the hands of the leaders of scientific opinion, it is but fair that the full importance of his work should be made clear, and that he should be given all the credit he so richly deserves. In Chapter XIV. Prof. Tait brings out and illustrates with his usual force and vigour the value of Young's principle in explaining the phenomena of the colours of striated surfaces and of thin plates, Young's own attempt to account for the diffraction effects produced by a wire or straight edge was incorrect; it was left for Fresnel in his great memoir on diffraction to show that they too followed as a direct consequence of interference.

It is of course impossible to give without the aid of analysis a full explanation of the phenomena of double refraction, and so Prof. Tait contents himself with showing how Huyghens' construction, combined with the fact that light-vibrations lie in the wave front, enables us to account for many of the observed facts.

When considering the subject of polarisation by reflection (§ 268, &c.), we miss any reference to the experiments of Jamin and others, besides Brewster, on the reflection of light from transparent media. Jamin has shown that

Brewster's law requires some modification, for in general there is no angle at which light is *completely* plane-polarised by reflection from a transparent surface. For substances in which the refractive index is about 1.4, an angle of complete polarisation exists, but only for these.

A short chapter on Radiation and Spectrum Analysis concludes the book.  
R. T. GLAZEBROOK

### OUR BOOK SHELF

*A Pocket-Book of Electrical Rules and Tables.* By John Munro, C.E., and Andrew Jamieson, A.M.I.C.E., F.R.S.E. (London: Charles Griffin and Co., 1884.)

COLLECTIONS of rules and tables adapted to the wants of civil and mechanical engineers have existed for a considerable time, and now that practical applications of electricity are becoming so many and important, a want has been felt of a useful hand-book for those engaged in this comparatively new branch of engineering. The "Pocket-Book" before us is intended to supply this want, and in many respects it does so very well indeed. It is neat in appearance, handy in shape, and contains much information in the form of tables of practical data, useful rules and recipes, and specifications and directions as to the performance of many different kinds of work.

But although doing good service to electrical engineers by collecting together so much that is useful in the form of practical results, the compilers have, in their endeavour (a mistaken one we think) to render their manual a guide also in points of theory, fallen into many errors which render the book an unsafe one to put into the hands of any one who is capable of being misled in such matters. In the first place there are many—we cannot call them typographical—mistakes in equations given in different parts of the work. As the process by which these equations are obtained is not given, and the formulæ are intended for reference and to be used in computation, there is nothing to warn an inexperienced user of the work of possible danger. The errors might, however, be excused in a first edition if it were not that the formulæ in question are simply inaccurate copies of results given in other works. For example, at pp. 123 and 125, a single glance at "dimensions" is enough to show that several of the formulæ for the localisation of faults in aerial telegraph lines are erroneous, and the same remark applies to the formula given at p. 174 for the calculation of the distance of a fault in a submarine cable from the testing station.

As to the more theoretical portions of the work, we have first a chapter headed "Definitions of Units." This is in great part taken *verbatim* from Prof. Blyth's new edition of Ferguson's "Electricity." An alteration on Prof. Blyth's statement is made on p. 10, and confounds the well-known and perfectly definite velocity  $v$  with the velocity which is the proper expression of any given resistance in electro-magnetic measure. Again, at p. 13,  $v$  is said to be the ratio of the *electro-static* to the *electro-magnetic unit* of quantity. The "derivation" of the practical units—volt, ohm, ampere—given in the table at p. 13 is a perfect maze of vicious circles, and in the same table the "joule" is given as alternatively "volt  $\times$  coulomb" and "ampere<sup>2</sup>  $\times$  ohm,"—the confusion, which would seem inveterate, between work and activity or rate of working. The velocity of light, we may remark, is given at p. 11 as  $3 \times 10^{10}$  cm. per second, and at p. 382 this is given as the "French value" of 192,000 miles per second! Here, as elsewhere in a few cases (the values of  $g$  given at p. 42 for example, where, besides,  $g$  is expressed as a *velocity*), numbers evidently culled from different sources and supposed to express the same quantity in different units are given without verification of their equivalence. In p. 43 the venerable pendulum formula is terribly misprinted

and  $g$ , without its being so stated, is taken in *inches* per second per second.

A chapter headed "Testing of Electric Light Dynamos, Accumulators, and Transmission of Power," given at pp. 176-86, is not at all satisfactory. The tests for the efficiency of a secondary battery are neither clearly nor fully given, and the score of lines devoted to this important subject close with a most remarkable sentence, which we quote:—"The total work done in charging and discharging may also be measured by a suitable voltameter joined up as a shunt to the secondary battery, so as to pass a known fraction of a current through it."

At p. 373 there are two or three misprinted formulas, but in the first line of p. 374 we have perhaps the most extraordinary equation ever given in a work on electro-dynamics. The difference of potential at the terminals of a dynamo (a shunt-dynamo we presume is meant) is there stated to be equal alternatively to the product of the current in the field magnets multiplied into their resistance, to the current in the external circuit multiplied into the resistance of the external circuit, and to the current in the armature multiplied into the resistance of the armature.

The calculation (p. 345) relative to the electrolytic decomposition of copper sulphate involves also serious theoretical errors. Mr. Jamieson, multiplying together the electro-chemical equivalent of copper and the heat of combination of copper and oxygen, makes the "electromotive force required to deposit copper from a solution of sulphate of copper" to be 836 volt. In the particular case, not however referred to, of a cell having a platinum anode and copper kathode, this would be the approximate electromotive force required on the cell to produce electrolysis. But the author actually goes on to use this result as the electromotive force required on an ordinary electro-plating bath to effect the electrolysis, and bases on it some conclusions as to the efficiency of a Siemens machine depositing copper in commercial work, or in the stereotyping of ordinary printed matter. In these cases of course both anode and kathode are copper plates, and the calculated electromotive force has no application whatever.

A single remark on another subject we would make before taking leave of this work. In many places where the compilers are under obligations to other authors due acknowledgment is wanting. For examples we may refer to several parts of the chapter on submarine telegraphy, to pp. 369-76 on dynamos and transmission of power, and to part of p. 403, where, by the way, the very serious errors inherent in the method of determining (?) the intensity of a magnetic field by counting the oscillations of a magnetic needle are not alluded to.

In conclusion we have no hesitation in saying that with a careful weeding of the tables, minute verification and correction of the algebraical work, deletion of a good deal of the "theory" given, and lastly, copious references to original sources, both as a matter of convenience to the user and of literary justice, this "Pocket-Book" will be made a very valuable *vade mecum* for electrical engineers. As it is, it will no doubt be found of service, but, as we have indicated, its statements must on several subjects be received with caution.

A. GRAY

*The Non-Bacillar Nature of Abrus Poison.* By C. J. H. Warden, Surgeon I.M.S., and L. A. Waddell, Surgeon I.M.S. (Calcutta, 1884.)

THIS pamphlet is an exhaustive treatise on the nature, physiological and chemical properties of the seeds of *Abrus precatorius*, called Jequirity by the South Americans, and used to cure granular lids. As is now well known through de Wecker of Paris and Prof. Sattler, this popular remedy of the South Americans produces, when used as an infusion and applied to the conjunctiva, severe ophthalmia, in the course of which granular lid (trachoma) is brought to cure. In India it is used by the

natives for subcutaneous injection into cattle, wherewith to produce a kind of septicæmia and death. The nature of the poison has been thought by de Wecker and Sattler, and later by MM. Cornil and Berlioz, to be due to a bacillus (the Jequirity bacillus), the spores of which are derived from the air; and, although harmless at first, assume pathogenic properties when grown in an infusion of the *Abrus* seeds. It has been conclusively proved, however, that this is not the case, that the active principle of the *Abrus* seeds is present before any contamination with the bacillus could have taken place, and further, that the Jequirity bacillus, when freed from the infusion, possesses no power of producing ophthalmia.

Messrs. Warden and Waddell have carefully examined the chemical nature of the seeds, and they find that the active principle, abrin, is a proteid, closely allied to native albumen, and obtainable not only from the seeds, but also from the root and stem.

E. K.

*A Text-Book of Pathological Anatomy and Pathogenesis.* By Ernst Ziegler. Translated and edited for English students by Donald Macalister, M.A., M.B., &c. Part II. Special Pathological Anatomy, Sections I.-VIII. (London: Macmillan and Co., 1884.)

THE enormous success that has attended the first part of this work will, we feel sure, in no way abate with the present volume. Like its predecessor it is a masterly exposition of all that is known concerning the pathological anatomy of the parts treated. In this last volume the special pathological anatomy of the blood and lymph, the vascular mechanism, the spleen and lymphatic glands, the serous membranes, the skin, the mucous membranes, the alimentary tract, the liver and pancreas, are described with great clearness and thoroughness. The subjects are treated in a detailed and systematic way, without incumbrance with self-understood details. The illustrations are very admirable, and while not profuse, are nevertheless thoroughly representative. The bibliography, particularly of the more recent works, is, in the English edition, thanks to Dr. Macalister, a most valuable improvement on that in the German edition. While a help to the learner, it will no doubt prove also a valuable companion to the teacher.

E. K.

#### LETTERS TO THE EDITOR

[The Editor does not hold himself responsible for opinions expressed by his correspondents. Neither can he undertake to return, or to correspond with the writers of, rejected manuscripts. No notice is taken of anonymous communications.]

[The Editor urgently requests correspondents to keep their letters as short as possible. The pressure on his space is so great that it is impossible otherwise to insure the appearance even of communications containing interesting and novel facts.]

#### The Late M. Dumas

I HAVE received from M. Pasteur, President of the Committee, a letter informing me that it is proposed to erect a statue to the memory of Dumas at Alais, his native town. The name of Dumas is so prominent in the history of our science that no words of mine are needed in support of such a proposition, and I merely express the hope that many English chemists will be willing to contribute to this memorial. Subscriptions will be received by the secretaries of the Chemical Society, Burlington House, Piccadilly.

W. H. PERKIN, P.C.S.

#### The Cholera Germ

THE latest enunciations of Prof. Koch from Toulon and Marseilles concerning the relation of his "comma-shaped" bacillus to cholera are so contradictory, that it is worth while to take notice of them.

Koch, as was mentioned in your last issue (p. 237), maintains that the "comma-shaped" bacillus is the cause of cholera; and



finding it in the alimentary canal only, but not in the blood and tissues, of persons affected with cholera, he is necessarily forced to assume that the alimentary canal is the exclusive organ into which the cholera poison enters and in which it has its breeding ground. On the other hand, Koch has ascertained that the "comma-shaped" bacillus is fatally affected by acid. This result, having been established by direct experiment, is naturally perfectly trustworthy, and is, besides, in complete harmony with what is known of other bacilli, both pathogenic and non-pathogenic, which, as is well established, succumb to the influence of acid.

Now, these three propositions, (1) that the "comma-shaped" bacillus is the cause of the cholera, (2) that the alimentary canal is the exclusive organ of entrance of the cholera virus, and (3) that the "comma-shaped" bacillus is neutralised and killed by acid, appear to me to be in hopeless contradiction.

The first two propositions are assumptions, the third is based on direct experiment, and is, as just stated, perfectly in harmony with other observations. If, then, this third proposition be true, the other two cannot be true, that is to say, if it is true—and there can be no doubt about it—that the "comma-shaped" bacillus succumbs to the action of acid, then it cannot be true that the "comma-shaped" bacillus is the cholera virus, nor that the alimentary canal is the sole entrance of the cholera virus. How, we may ask, can the "comma-shaped" bacillus pass unscathed the acid contents and the acid secretion of the stomach? To maintain, as Koch is reported to have done, that in all persons attacked by cholera the stomach must have been previously so deranged that its contents and secretions are not acid must appear to every one who has had any experience during a cholera epidemic an untenable proposition. On the one hand, it is known that such a serious disorder of the gastric mucous membrane as the total absence of acidity is of comparatively rare occurrence, while, on the other, in every cholera epidemic numbers of persons become affected with the disease in whom such a gastric condition, antecedent to the infection, can with certainty be excluded.

E. K.

#### The Mountain System of the Malayan Peninsula

SOME new facts with regard to the mountain system of the Malayan peninsula may be of interest to many of your readers. In exploring through the native State of Perak I find that, in addition to the main range, which occupies about the centre of the territory and runs in a north and south direction, there are two other ranges belonging to quite different systems, and, as I think, of different geological age. The first is close to the coast. It is a series of ridges parallel to each other, but detached, having a north-north-east or south-south-west trend. These ridges are of granite, and rise to a considerable height, such as Gunong (Malay for mountain) Inas, over 5000 feet; Titi Wangsu, nearly 7000 feet; Gunong Hijau, 4400 feet, and Gunong Bubu, or Buhor, 5600 feet. The two latter I have ascended. Though they are detached from each other, they form a watershed between the coast and the inland drainage, and thus the River Perak has to drain an immense valley in a north and south direction until it finds an outlet to the south of the Dindings.

To the east of the Perak there is a small range about twenty-five miles long, perfectly detached from the other systems, and having generally a north and south direction, but sending off spurs a little west of south. This also is granite, but on its lower shoulders has thick deposits of stratified limestone, above and below which tin is worked. To the north this range is bounded by the valley of the River Plus, which here joins the Perak, and to the south by the mouth of the Kiuta. The latter river runs in a valley to the east of this range, and where it ceases joins the Perak. To the east of the Kiuta again comes the main range with many peaks over 7000 feet high; Gunong Riam probably reaching over 8000 feet.

The first series of ranges have their origin in the State of Keddah, just where the Malayan peninsula begins to widen out. This widening out is entirely due to this mountain system. The

island of Penang is a part of it, and so are the islands called the Dinding Group. Were the coast to subside about 300 feet, we should have a narrow peninsula fronted by a series of large and very elevated granite islands having their longest diameter north-north-east and south-south-west. The second mountain chain has a different direction, and nowhere rises above 3000 feet; but both ranges are rich in tin. The first series has at its base Palæozoic schists, slates, and clays. The second has limestone. The Palæozoic rocks are rich in tin at the junction with the granite. The tin in the second range lies above and below the limestone, and has been derived from the older formation. The Palæozoic clays resemble very closely the gold-bearing slates and schists of Australia. To the south they are nearly denuded away, but in Lower Siam, from specimens I have seen, they are full of auriferous quartz reefs.

It is singular that in this mountain system we have the closest resemblance to the tin-bearing districts of north-eastern Australia. When exploring geologically the Wilde River district in 1881 and the Daintree River in 1879, I found that the sources of the tin were in detached granite mountains or groups of mountains—granite islands, so to speak, much higher than the present watershed of the country, but, being detached from each other, allowed the rivers to pass round and between them. I have referred to the same thing in Tasmania in my account of the physical geology of that country. Geologists in England can say if there is any resemblance to this state of things in the tin-bearing granites of Cornwall. I am inclined to think that we have in these rocks the remains of a former and very ancient mountain system.

I may add that it is a pity that we still find in recent books of high authority the statement reiterated that the highest mountain on the Malayan peninsula is Mount Ophir, near Malacca (4360 feet). Here are the heights of a few in Perak:—Slim Mountains, 6000 or 7000 feet; Titi Wangsu, 6900 feet; Riam, 8000 feet at least; Hijau, 4400 feet; Buhor, 5630 feet; Gunong Rampip, 7800 feet; Gunong Rajah, 6500 feet; besides many others in Keman and Pahang which have not been explored.

Arang Para, Perak, June 2

J. E. TENISON-WOODS

#### Chalk and the "Origin and Distribution of Deep-Sea Deposits"

IN consequence of Dr. Gwyn Jeffreys' letter, I feel it incumbent, in the interests of geology, to restate the position with regard to the question of the depth of the ocean in which the White Chalk of England was deposited. The cause that led to its deposition over a former land surface was indubitably a great though gradual depression of that area. The process commenced with the Neocomian age, when two seas encroached from north and south, until they were probably only separated by some relatively unimportant ridges or islands to the north of London. The depression seems to have been checked for a long period, but recommenced in the Gault age in a more serious manner. Now, according to Renard and Murray, the *Blue Mud*, with which I assume the Gault is to be identified, if with anything, is formed around shores and in partially inclosed seas, passing into a true deep-sea deposit at a distance from land. The limits of depth at which *Blue Mud* is formed are not stated, but the Mollusca of the Gault, if not indicating a very great depth, are quite against its being a very shallow-water formation. There are several deep-water genera, such as *Newra*, *Leda*, *Limopsis*, *Cadulus*, *Dentalium*, *Eulima*, in it, and I believe that when the smaller Mollusca from it have been reinvestigated by the light of our present knowledge, a far greater similarity between them and deep-water forms will be apparent. The Gault also contains a very large number of Foraminifera and several Encrinites and other Echinoderms, which are not, I believe, characteristic of long-shore deposits; while there is a remarkable absence in it of the more distinctly shallow-water shells that abound in the Neocomian, and it has none of the coarser fragments of rock, 2 cm. in diameter, which are stated in Renard and Murray's paper to occur in the near-shore muds. We must assume a considerable depth of water for the Lower Gault—what depth I would be well pleased to leave to Dr. Gwyn Jeffreys to say. Now, if there is one fact more apparent than another, it is that the Upper Gault represents a deeper sea than the Lower, and therefore that the depression was maintained. The *Blue Mud* is replaced in neighbouring areas by *Green Mud*s and *Sands* with Glauconitic grains which apparently are deposited in similar depths or situations; but the limit of depth at

which either the one or the other is dredged is not stated. A still continued depression takes us through *Green Mud* to the Chalk Marl, which apparently is a true *Globigerina* ooze<sup>1</sup>; and this passes into a true White Chalk. The White Chalk is the result of still farther depression, for it overlaps the other deposits, and as the great change in the character of the sediment cannot have been due to the shallowing of the sea, and yet must have had a cause, we must conclude it was due to deepening. Its enormous extent and thickness and great purity proclaim it in fact to be an oceanic deposit, and there does not appear to be anything with which it can be compared except *Globigerina* ooze.<sup>2</sup> The White Chalk of England could therefore only have been deposited under the conditions of depth, or remoteness from land under which the deposit of *Globigerina* ooze is possible. If *Globigerina* ooze is not a "terrigenous" deposit, Chalk is not, and it does seem singular that it should be classed as such by Renard and Murray, unless indeed they are prepared to point to an area in which a similar terrigenous formation is taking place at the present day. If genera now confined to shallow-water are present in it, it only proves that there must have been deep-water representatives of those genera in the Cretaceous ocean. This is in fact probable from at least two considerations, the one that the examination of the abyssal fauna is still relatively "extremely slight and cursory," as Dr. Gwyn Jeffreys has so amply admitted in the address he refers me to. It is probable that thousands of casts of the dredge have been made in the littoral zone for one in the abyssal zone, and we are, therefore, not in a position yet to say that any genus may not have representatives in the latter. The second consideration is far more important. Dr. Gwyn Jeffreys states that "all of them (the Cretaceous Mollusca) are evidently tropical forms." Now there is strong evidence from the present distribution, and the deposition of the Chalk, that the sea did not communicate with Arctic seas. Prof. Prestwich, in his anniversary address to the Geological Society, pointed this out in 1871. But even if it had, the Arctic climate during the Cretaceous period was a warm one, and for these two reasons, or either of them, the abyssal depths of the Chalk ocean were probably higher in temperature than they are now, while the temperature of the more littoral zones may have been almost tropical. Heat and cold seem greater factors in the distribution of Mollusca than depth of water. Relatively cold-loving genera or species of genera that could only have found the necessary temperatures then at great depths, may now find suitable habitats in shallow water. The "tropical Mollusca" of the Chalk might for this reason have been able to live at much greater depths when such were warmer, but are of necessity now restricted to those in which suitable temperatures are to be met with; and since these are now all relatively shallow, Dr. Gwyn Jeffreys may be quite right in saying that these extinct species have a shallow-water facies, without our being obliged to accept his inference that the Chalk sea was a shallow one. But if we accept the Mollusca pure and simple as a test of depth, their evidence as adduced is untrustworthy owing to the association together of those of the Gray Chalk and the Irish Chalk band of Kilcorrig. Eliminating these, we have no patelloid shell left but *Hipponyx*, and the Chalk species was completely different in habit to anything living. I do not know the Chalk *Chama* (if the Irish form, this is a limpet) or *Pinna*, and these must be very rare and even possibly drifted shells. The unextinct characteristic genera are in fact reduced to *Terebratula*, *Lima*, *Pecten*, *Armusium*, and *Spondylus*, and of these all but the latter are stated, in the address I am referred to, to have been met with in water 1450 fathoms deep.<sup>3</sup>

It would be impossible to dispose of a question of such importance in a mere letter. My object in writing is to elicit, if possible, the exact grounds on which Messrs. Murray and Renard base their statement that the Chalk was a shore deposit; and it would also be exceedingly useful if Dr. Woodward, Dr. Duncan, Mr. Davidson, and Mr. Carpenter would give their opinions, and the grounds on which they are based, on the probable depth required by each of the Cretaceous groups,

<sup>1</sup> *Globigerina* ooze is mainly composed, according to Murray, of 40 to 95 per cent. of carbonate of lime, oxides of iron and manganese, and argillaceous matter.

<sup>2</sup> Of reef-building corals there is not a trace either in it or in any contemporaneous formation, and nothing can be more opposed to all evidence than the supposition advocated, it will be remembered, by Wallace in "Island Life."

<sup>3</sup> There are few traces in the English Chalk of any Mollusca except those that possessed calcite shells, and what the rest were like as a group no one can say.

respecting which they are the chief authorities. Dr. Gwyn Jeffreys is the only one who has contributed anything definite towards a solution of this most important geological problem, and for this, while believing other conclusions may be deduced than those he has arrived at, I and many other geologists heartily thank him.

J. STARKIE GARDNER

### Animal Intelligence

THE following notes of facts observed in New Zealand may be thought of interest; in some way they may serve to illustrate Mr. Romanes' work on "Animal Intelligence": they are submitted without making an attempt to distinguish where they may overlap the fine line between instinct and intelligence. Cases which may show apparent intelligence or the reverse are recorded, that we may arrive at a clearer view of the truth in animal life.

The dog cannot be passed over without mention; he is always to the fore where intelligence is required. Here, where sheep occupy so large a share in the employment of country people, the colly may be seen daily exhibiting its wonderful talents in controlling the movements of its simple charge. Its achievements are too numerous for recital.

Amongst birds we found the quail-hawk (*F. nove-selandie*), quickly learnt to avail itself of the property of the new settlers; it attacked both poultry and pigeons with the greatest determination directly these foreign birds appeared at the stations and outlying farms. The harrier (*Circus approximans*), more stealthy than the falcon in its depredations on the poultry, perhaps not less destructive, is careful if possible to convey its prey to a quiet spot free from interruption, where its meal can be finished at leisure in security. It found out the use of cornricks and haystacks as mouse-preserves; in some places several harriers might be seen at one time perched on the thatch carefully watching for vermin. It killed the rabbit; the swift-footed hare it found out could be hunted to best advantage in company; several of them would join in the pursuit, wheeling softly with every double of the distressed animal, till, quite exhausted, it lay stretched out in death. The harrier, the gull, the tern, all used to put in their appearance after the large grass fires of former days had swept miles of country; lizards, as they crept from under the stones laid bare by fire, seemed the attraction for all these birds. One autumn, when laid up with rheumatism, lights were brought into the room rather early. I often heard the sound of scratching on the window-glass, and found it proceeded from the efforts of an owl (*Athene, N.Z.*) to scure moths from the lighted-up window-panes; this was repeated for many evenings during parts of the months of April and May, so that I always expected my evening visitor. As a mouser this same species learnt the value of stations near barns and stacks; frequently, many scores of times, have I seen it keeping its solemn watch on a post or rail of the barnyard (see *Zoologist*, 1873, p. 3621). The kakapo or night-parrot (*Stringops*) shows intelligence in its nesting arrangements: the chamber at the end of a long tunnel is covered at the bottom with a great accumulation of excreta; each of these is an inch or more in diameter—the bird is a vegetable feeder—the warmth derived from this mass is secured by the young, reversing the proverb, "It is an ill bird that befouls its own nest."

The kea (*Nestor notabilis*) (see NATURE, vol. iv. p. 489). Its rapid development of a change of habit that led it to destroy sheep has proved very disastrous to many mountain sheep-farmers. It is remarkable that the discovery of the excellence of kidney fat should become known almost simultaneously through a long tract of country; how were beginners instructed to dig their beaks into the wool just above the sheep's kidneys? Horses have been wounded by them in the same part; all this shows a ready means of spreading information. One of the writer's sons snared a few fine specimens, but they very soon became aware of the snare and promptly avoided it. When thrown at, they learn to dodge the stone, just ducking or moving aside. One, imprisoned under an inverted bucket, after a time thrust its strong beak between the rim of the bucket and the floor, turned over the bucket and escaped.

The two cuckoos *Eudynamis* and *Chrysococcyx* offer a problem of peculiar interest as regards migration. The journeys they undertake and accomplish across wide expanses of ocean are amongst the most courageous and trying physical feats in bird history: "as bold as a hawk," "as brave as a game-cock," are proverbs that are befitting; but these birds deserve as much recognition for their adventurous daring.

When either of these species is observed flying, it will be

noticed that the wings are kept constantly in rapid motion; there is no sailing or soaring, gliding through the air on still expanded pinions, but the bird is sustained by determined work. Here in the South Island they are to be seen from the end of the first week in October (further to the north earlier) till March, or even April; and the remainder of the year they are not seen in this country. Every part of the islands is known to the Maories; there is no district where they could winter without the fact becoming known. The whistler, or shining cuckoo (*Chrysococcyx*) has been observed in the month of October at Te Wakaru, Chatham Isles, on the beach and in trees exhausted, wet as though from spray; looking at the period of its arrival, and remembering that Te Wakaru is the north-east corner of the large island, it points to the probability that some birds arrive there direct from the warm and distant north, and not from New Zealand, from which the Chatham Island group lies easterly from Cook's Straits about 500 miles. From my own observation I am inclined to believe that with this species the first emigration sets in from the west coast of the South Island of New Zealand about the end of December, as I have observed adult birds in numbers on the sand dunes close to the sea, probably preparing for departure. They make use of the warmest domed nest of our native insect-eating birds, the very rare exceptions afford but two or at most three exceptions in thirty years' observation; in one of these cases an egg found in a nest of the blight-bird (*Zosterops*) approximated in colour those of the dupe; because it was dropped in an open nest? A good example of approximate coloration came under notice in the case of a wounded bittern which was secured and placed under a coop on a piece of grass; she laid an egg of a pale green colour; under ordinary conditions a buff egg would have very well matched the flags of dead sanpo (*Typha*) and faded water grasses, of which its nest is composed. The kingfisher (*Halcyon*) gives a good instance of cleanliness, most necessary in a close nest, containing from five to seven young birds, which remain at home until they can fly well; the entrance of the tunnel to the nest chamber is an upward slope, whilst the eggs are saved from rolling out by a ridge on the edge of the nesting place. In another species the flycatchers (*Rhipidura*) cleanliness is attended to thus: the young back themselves to the edge of the nest to void excrement, which is taken away by the old birds. In the slight nest of the wood-pigeon (*Carpophagus*) cleanliness is provided for by the open work of the structure, so that the dried excreta of the young pass through the spaces of the concave platform. The tui (*Prosthemadera*) enjoys the faculty possessed by the keas, gulls, terns, and many other species, of quickly making known events of interest, as, for instance, in a gorge of one of the great rivers, some cherry-trees rewarded the care of a settler with a fine crop of fruit; a wandering tui found this out, immediately the fruit was attacked by numbers of these beautiful birds, and the crop cleared off. The tuis had to travel some miles from a wood to the cherry-trees. Another instance of the possession of this quality could be witnessed here at the present moment (April 23); from the midst of the massive armed leaves of a variegated aloe has arisen a stately and erect column of blossom reaching upwards to a height of twenty-four feet; its bracts, between thirty and forty in number, laden with rich golden-coloured flowers spread out in formal array. A bell-bird (*Arthornis*) first discovered the richness of the nectaries of this foreign plant. Soon bell-birds and tuis assembled there, a most pleasing sight; their ever-varying motions and postures could be distinctly seen as they flitted about, darted between or hung suspended from the blossoms whilst probing for the honeyed sweets. It has become a floral play-place, a stage enlivened throughout the day with songs and aerial movements; even when the sun has retired behind the western hills, when bees have winged away to distant hives, a bell-bird or two will yet linger, as if to the last minute they would extract some luscious drops.

Since its arrival here in 1856 the blight-bird (*Zosterops*) has shown some notable changes in habit that are in accord with the different conditions under which it now lives in this country: for some years after its arrival it built a suspended, somewhat hammock-shaped nest, in which it laid three eggs; finding from experience that its nest was unmolested by snakes or other egg-robbers, it saved itself much pains and labour by commencing to fix its home in a spray. It, like the goldfinch (*F. carduelis*), freely availed itself of the sheep paddocks, and collected wool as an excellent fabric for nests very readily obtainable; I have seen nests of this species almost entirely constructed of it. One of its familiar names was conferred because it helped to clear

fruit-trees of blight and other insect pests; it soon found out the excellent food that a variety of fruits afforded; when trees were netted to secure them from its attacks, it learnt to find out where the meshes of the nets were stretched to their full extent, and there made its ingress and egress to the fruit beneath. The robin (*P. albifrons*) visits conservatories for the sake of insects; we have known them make daily tours round a glass-house, waiting till flower-pots have been removed, when they have eagerly picked up the lurking insects that hid beneath, thus easily earning a hearty meal. The lark or pipit (*Anthus, N.Z.*) for a similar reason will leave uncultivated tussock land to follow the trench made by the gardener's spade, and thus get an abundant supply of the larvæ of the brown chaffer-beetle. I wish to say I do not think this a general habit of the pipit, but I have seen several of the species thus well employed.

The yellow-breasted robin (*P. macrocephala*) and the wren (*Acanthisitta*) will at times use man's buildings for their homes. Nesting material offered to this robin and to the flycatcher have been readily accepted; the latter species made use of some red cotton wool thus put in its way, but worked it up so that it was not seen from the outside. In some cases I have known the last-named neat architect to add a rim to the nest when the young required more room. The chaffinch (*F. castels*) here follows the traditions of its native land, tricks out the exterior of its beautiful nest with lichens, and in many cases supplements this material with fragments of newspaper, for lichen is scarce here; singularly enough this hereditary habit outweighs its sense of concealment, as it places its nest thus adorned on trees without lichen on their bark.

The sparrow (*F. domestica*) is remarkable for the ease and readiness with which it modifies its nesting habits to suit circumstances; in the very heavily topped ti palms (*Cordyline*), where the divergence of the branches is hidden by a massive thatch of long ensiform leaves, sometimes a common roof shelters many compartments; the gregarious instincts of the species are thus carried out at breeding-time; from one of these communities we have taken thirty-one eggs and fourteen young birds at once. On the shelterless "plains" it has been known to modify its old habits by building on the ground, or in heavy road cuttings its nest may be seen in a crevice of the bank, or it builds in some fissure in the cliffs over the sea, just below man's reach; it has taken possession of intricate passages in a heap of coils of fencing-wire; in this last-named instance poultry feathers for lining had to be brought from a mile distance; but then the situation promised security.

The weka (*Ocydromus*), as curious as a magpie, knows the value of a fruit-garden, and that a poultry-yard furnishes eggs. I have seen it pecking at the skin of a dead lamb with heavy blows, and the insects being driven out, it has tugged away at the decaying skin till it has been able to pick up the insects that lay underneath. The dotterel (*C. bicinctus*), red-bill (*Hematopus*), paradise duck (*Casarca*), all simulate lameness or distress to lead wayfarers from their young and afford them opportunity for escape or concealment.

The Australian magpie (*Gymnorhina*) has given us some noteworthy instances of its intelligence and resource under difficulties: a pair bred here for some years; one season the young were taken, the wings cut very close. Some impatient creature who could not endure constant and sudden attacks shot the male bird; the young were given away except one poor one, which turned out to be a male. In the following season the old hen was seen building very high, as usual, in a blue gum (*Eucalyptus*); there she was observed feeding young; at length a young one flew from the nest, and when sufficiently strong on the wing, together with the old hen left the district. Now the poor male with the wings cut was never able to rise from the ground further than by jumping; he had never flown at all, as the stumps of the quills remained in the wings. This was the only male to which the hen could have had access. Whilst the hen was intent on new family cares, the crippled male died. Another pair on the plains, where sticks were scarce, availed themselves of a supply of binding-wire from a patent reaper and binder; the wire cut in lengths furnished an ample supply of lasting material for the nest.

The big gull (*Larus dominicanus*) instantly finds out a dead beast, and makes the fact known; it attacks sickly lambs or sheep that are cast by pecking out the eyes, thus securing its prey by rendering it helpless. I have seen it ascend with a shell-

<sup>1</sup> See *Mittheilungen des Ornithologischen Vereins in Wien*, No. 3, März 1884, p. 35.

fish to a considerable height, and drop it on to a shallow in one of the bays, recover its prize, and drop it again and again to obtain the fish within. Many weeks before nesting time these birds visit the old breeding-stations, as if to estimate the repairs that will be necessary to render the old nests available; this visit is carried on with great clamour. A cormorant (*Graculus*) was shot at and wounded at a tench-pond at Rockwood; it kept in the pond; it could not fly. A dog was sent in to fetch it out; it faced the dog resolutely, which turned tail; this part of the animal was immediately seized by the cormorant, who was in this singular manner towed ashore; but its odd feat did not serve to save its life. The fantail flycatcher (*Rhipidura*) enters houses in pursuit of flies glancing from room to room; it soon clears them of these insects. Dr. Otto Finsch in his "Ornithological Letters from the Pacific" mentions this habit as witnessed by him here.

Amongst hymenopterous insects the Sphegidae offer instances of intelligence. A species of Spheg with orange-coloured body deposits the benumbed or torpid bodies of spiders in some crevice for future use. An individual of this species had its hole in a dry corner beneath the plate of a long veranda. One day I observed it dragging a victim along a gravelled walk that was parallel to the veranda; the small stones and grit made its progress very difficult. After very trying struggles with these impediments it displayed a remarkable degree of intelligence, by which it gained its ends. It altered its course and made for the veranda, ascending the smooth, painted board that adjoined the gravelled walk. After slowly traversing seven inches of perpendicular it came to a rounded beading which projected outwards. Now came its supreme moment of physical exertion. The body of the spider apparently was too heavy to render the aid of wings available. After several pauses in its progress it slowly yet surely surmounted the difficulty presented by the projecting beading, gained the level boards of the veranda, along which it travelled rapidly with its burden, which it sometimes dragged, sometimes pushed before it. By the expenditure of great exertion in surmounting the beading it gained a smooth and level run to its home of thirty-nine feet. A species of Mantis remains so still on a leaf of its own colour that it is difficult of detection; it takes its prey by surprise, darting forward its armed fore-limbs with a sudden spring.

I have had in the shrubbery a colony of Phasmæ for the last nine or ten years. In all that time they have remained almost entirely on one tree (*Oleurea Fosteri*). Yet, accustomed as I am to them, they place themselves so much in a line with the sprays of the tree that they are difficult to discern; in drizzling north-east weather some dark markings appear along their bodies, which match the wet sprays wonderfully. It should be noted that the Australian magpie, the halcyon, and many insect-eaters have for years bred and lived in the trees or banks near them; yet they still survive, notwithstanding the proximity of these enemies to insect life.

T. H. POTTS

Ohinitahi

THE following extract from a letter which I have just received from Mr. J. H. Wheelwright appears to me of sufficient interest to publish in your columns, as it serves to give, among other things, a good deal of new and first-hand information on one of the most important branches of comparative psychology, viz. that relating to feral and partly wild domesticated animals.

GEORGE J. ROMANES

Cattle very easily relapse from domestication. They become distinctly nocturnal in their habits; their sense of smell is very strong. Wild cattle degenerate rapidly in size, owing, I think, to the persecution of the young heifers by the yearling bulls. In three or four generations in Queensland wild cattle revert to one uniform colour, a dun colour or dirty brown with a yellowish stripe along the spine, and a yellow nose. Wild cattle will remain all day long concealed in the depths of thick, inaccessible jungle—"bungalow scrub" or "mallee" we call it in Australia—issuing forth at night to graze and drink, and it requires much care and very hard riding to entangle a few of them among a lot of quiet cattle and secure them. Australian cattle have many habits their domesticated progenitors have lost. For instance, in summer-time grass becomes very scarce near the rivers, and the cattle walk in from their feeding-grounds as much as ten or fifteen miles to water, marching in long strings and feeding back again. Young calves of course could not do this. I have frequently noticed two or three cows far out on the plain, who, when they saw me, would lift their heads and watch me. Presently I would

come across a kind of *crèche*, a mob of perhaps thirty little calves all lying snugly in some small, sheltered dip of the ground, left there in charge of the sentinel cows by their mothers who had gone in to water. Now as soon as these calves saw me they would try to hide—do it very well too, under any little bush there might be handy, and lie close until I got off my horse and touched one; then he would jump up, and, no matter how young, make a staggering charge at my legs. He would give a peculiar cry at the same time, which would bring the guardian cows in at a full gallop and give me reason to mount at once. Cattle have extraordinary *homing* power; so have horses. Cattle recognise *individuals* in a very extraordinary way. I have had considerable experience in droving large herds, say 1000 or 1200 head, long journeys extending over many months. I have been struck with the fact that, a week after that herd has been travelling, every beast in it seems personally acquainted with every other: that is, if a strange cow or bullock were to join the herd, that cow or bullock would be immediately expelled. When a herd is travelling thus, each beast in a very few days takes up his position in the mob, and may always be found in the van, the rear, or on the right or left wing, the strongest cattle leading. That cattle and horses can *smell* water is a delusion. Cattle and horses always have their particular friends; at night when cattle are *camping* on a journey, there is always much bellowing and fuss until certain *esteries* of friends get together and lie down comfortably. A beast blind of, say the *left* eye, always travels at the outside of the *right* wing of the drove. A beast that has been scratched sufficiently to draw blood will be hunted and pursued by all the rest. Cattle have a habit of appointing certain *camps* or *rendezvous*, where, on any alarm, they congregate. Half-wild cattle are sometimes very difficult to drive off these camps. Wild cattle are singularly clever in concealing themselves, as are all wild beasts, and will hide in half a dozen little bushes no one would suppose would hold a calf.

Wild "dingo" puppies, taken away from their mothers, are easily reared, but never lose their inborn savagery: they are not to be trusted near poultry, sheep, or cats. The chief difference between them and their civilised brethren is, if, say a collie pup misbehaves himself and is kicked, he yelps, sticks his tail between his legs, and runs away; whereas his wild brother, with his tail erect as that of a Dandie Dimont terrier, snaps viciously at the foot which kicks him. I have owned a pure-bred dingo ("warrigal" we call them) which ran with our kangaroo dogs, and the dog would worry one of his own kind with as savage a zest as would any of the great powerful hounds with which he had associated himself. As to feigning death, I think the Australian "dingo," or "warrigal," a good case in point. We once ran a wild dog with three powerful kangaroo dogs, noted for their killing powers; they caught him, worried him, and he lay for dead; at any rate the hounds thought he was done for; they lay down quite contentedly to regain their wind. We cut off the warrigal's brush, and he gave no sign. Just as I was getting on to my horse, I saw the supposed corpse open one eye. Of course we put the thing beyond a doubt. A kangaroo dog has been known to run down a dingo bitch at heat, line her, and then kill her. The worst and most dangerous wild dogs in the Australian pastoral districts are *half-bred ones*. Kangaroo dogs should be, I think, about three-quarters greyhound—the rest either mastiff or bull-dog; such a dog should be able to catch and kill almost anything.

A doe kangaroo, when hunted and hard pressed, will throw the young one out of the pouch into any handy clump of scrub or tussock of grass. The "Joey" accepts the situation, and makes himself as small as ever he can; in fact, in looking for him, all you ever can see are his bright eyes. Young kangaroos seem to possess exactly the same instinct as the calves of wild or semi-wild cattle, that of concealing themselves. Young kangaroos soon adapt themselves to circumstances, and make themselves comfortable at the bottom of the pocket of a jacket.

I remember that once upon a time, about 1856, we caught a brood of wild ducklings, which we took home and put under a hen. These ducklings, not one of them fledged, walked a mile and a half along a very dusty road to the place whence we had taken them, and rejoined, as I hope, their progenitors. Our black boys tracked them.

#### Diffusion of Scientific Memoirs

IN some of the numbers of NATURE which have recently reached me I find that Prof. Tait has broached a subject of

extreme importance to societies interested in the distribution of their publications, and in the receipt of publications from kindred bodies. Although I am connected with a small society which has hitherto only enjoyed an ephemeral existence, I trust that a brief account of my experience in the distribution of publications may have a little value. Early in 1883 more than 250 copies of our publications were distributed amongst the leading societies and libraries throughout the world. On my exchange list I now have 271 names; I also send to about 100 members of the Society. A few copies of our publications have been sent to persons who have made seismology a speciality. With each volume there was inclosed a printed form to be filled up and returned, both as a receipt and as a statement of other volumes which might be required. The institutions to which volumes were sent were as far as possible selected as having an interest in scientific investigations. Especial care was taken to forward volumes to institutions established in earthquake-shaken or volcanic regions, as for instance to many parts of South America, New Zealand, Central Siberia, Iceland, &c.

In many cases our receipts were returned. In others societies returned their own special forms. A few societies sent us their publications in return. One society very kindly made a collection of earthquake literature for us. Several others made special applications for particular volumes to complete the series of our publications. *In about half the cases, however, I find that no notice whatever was taken of our gift.*

For example—

For 34 volumes sent to institutions in England	17 receipts were received.
" 40 " " " Germany	22 " "
" 49 " " " the United States	31 " "
	&c., &c., &c.

One result has been that our distribution list has been reduced. In one or two instances, where I know that earthquake literature cannot fail to be acceptable, the omission to send acknowledgment has been overlooked, and I continue to post our publications.

No doubt many societies publish lists of presents. These may be useful to the members of such societies; but they are valueless to donors who are not favoured with such publications.

The fact which is most to be regretted is that these omissions have resulted in many libraries not being *au courant* with the latest information.

Now supposing that the publications in question have any value whatever, it is natural to seek a cause for this state of affairs.

In many instances the omissions may be due to negligence, whilst in others they may be due to institutions having failed to establish a system for their correspondence.

From my own communications with various societies it is evident that many of them neither possess forms for routine correspondence nor have they the means for facilitating reference to ordinary or extraordinary correspondence. Sheets of plain notepaper, envelopes, pens, ink, and a few postcards constitute the business equipment.

Those societies which possess forms for the acknowledgement of presents, &c., often sacrifice fivepence for the postage of an elaborate document where a wrapper or a three-halfpenny postcard, although wanting in formality, would attain the same result. Although learned societies are not institutions where business is a speciality, many of them might possibly derive benefit by the adoption of more business-like methods. At present it would appear that there are many institutions which are as equally indifferent to the circulation of their own publications as they are to receive those of others.

JOHN MILNE,

Hon. Sec. of the Seismological Society of Japan  
Tokio, June 7

### Suicide of Snakes

THE letter of Edward F. Hardman in NATURE (vol. xxix. p. 452), with reference to the suicide of black snakes, recalls an incident which I once witnessed; I was quite small, but my memory of the strange occurrence is very clear and distinct. It was in the State of Illinois, when at that early day a short, thick variety of rattlesnake was very numerous, so much so that the State acquired an unenviable reputation in the older parts of the Union. Farmers in "breaking prairie," as the first ploughing of the prairie sod was called, would kill them by dozens in the course of a single summer. They were very venomous, but owing to their sluggish nature and their rattle, which was always

sounded before an attack, but few persons were bitten by them. Moreover, there was little danger of death if proper remedies were applied at once.

I was one day following one of the large breaking ploughs common at that time. It was drawn by five or six yoke of oxen, and there were two men to manage the plough and the team. As we were going along, one of the men discovered a rattlesnake, as I remember about twelve or fourteen inches in length. They rarely exceeded eighteen or twenty inches, so that this one was probably about two-thirds grown. The man who first saw it was about to kill it, when the other proposed to see if it could be made to bite itself, which it was commonly reported the rattlesnake would do if angered and prevented from escaping. Accordingly they poked the snake over into the ploughed ground, and then began teasing it with their long whips. Escape was impossible, and the snake soon became frantic at its ineffectual attempts either to injure its assailants or to get away from them. At last it turned upon itself and struck its fangs into its own body, about the middle.

The poison seemed to take effect instantly. The fangs were not withdrawn at all, and if not perfectly dead within less than five minutes, it at least showed no signs of life. That it should die so quickly will not seem strange if it is borne in mind that the same bite would have killed a full-grown man in a few hours' time.

The men watched it long enough to be sure that it would not be likely to move away, and then went on with their work. I trudged around with them for an hour or more, and every time we came where the snake was I stopped and looked at it, but it never moved again. In this case I do not remember that the snake had been injured at all. I have often heard of rattlesnakes biting themselves under such circumstances, but this was the only case that ever came under my observation.

Ongole, India, June 17

W. R. MANLEY

### Sky Glows

As we appear to be having a return of the gorgeous sunset phenomena with which we were favoured towards the end of last year, a brief mention of two of the most brilliant displays that I have recently had the good fortune to observe may be of sufficient interest to place upon record in the pages of NATURE. The "after-glow," though very brilliant, has not of course attracted the attention it would have done, on account of the twilight; if it had not been for that circumstance, I think the recent displays of the phenomena would have been quite as gorgeous as those of last year. It would certainly have been so in the case of the "after-glow" on June 22; the "glow" on that evening at nine o'clock reached an altitude of 45°, and extended from the north to the west-north-west point of the horizon. For an altitude of about 20° the glow was of a beautiful crimson tint; above that altitude it was of a pale pink fading away gradually towards the edge to a pale orange. On that evening the reddish glow was not confined to that part of the horizon where the sun had gone down, but extended over the entire sky from the west to the east, the whole celestial vault, which was quite free from clouds, appearing to be slightly tinged with red. So conspicuous was this redness of the sky that a lady friend remarked—before her attention had been called to it—"How red all the sky is."

On the 7th inst. the "glow" equalled in brilliancy, though not in extent, the display above described. At 8h. 45m. p.m. it reached an altitude of about 30°, and extended from the west-south-west to the north-north-west point of the horizon. The redness of the whole sky, which was so noticeable on the former occasion, was wanting on this. On both occasions the "glow" was not visible for more than an hour and a quarter after sunset.

Dalston, E., July 12

B. J. HOPKINS

MANY of your correspondents have referred to the "remarkable appearances of the sky" at sunrise and sunset last year, but I have not observed any reference to the following:—On the morning of November 30 I was on my way from Basle to Calais by the St. Gothard mail train, and observed the whole eastern sky become lit up as though there were a splendid sunrise; the larger print of a newspaper was easily readable at the carriage window. On referring to our watches we found it was 5 o'clock by Basle time. During the next half-hour every trace of the phenomenon gradually vanished.

July 11

FRANK PETRIE

### Fireball

READING W. G. Smith's remarks on lightning in last week's NATURE (p. 241), recalls to my mind a ball I saw during a storm in the autumn of 1881. The storm had lasted some time, and I sat reading a little back from an open window but facing it. Suddenly it became so dark that I could no longer see. I dropped my book and looked out. A ball of fire was passing through the window into the room. It moved very slowly onwards and downwards towards me, and became almost stationary over my book. At first I thought it rested upon it, but I soon saw it was moving slowly across. Having passed over the book, it turned in the direction of my hand, paused just beneath it, and then sank towards the carpet. At this instant a peal of thunder crashed over the house—it was the very loudest I have ever heard.

ANNIE E. COCKING  
The Elms, Bedford Park, Chiswick, W., July 14

### Butterflies as Botanists

THERE can be no doubt, as pointed out by Fritz Müller in your last issue (p. 240), that the habits of insects often indicate affinities in plants. There is doubtless a strong affinity between the Solanaceæ and Scrophularineæ; the small oval pollen is almost identical in both. The habits of fungus parasites sometimes disclose similar relationships, often more real than is at first apparent; we have an example of this in the fungus of the potato disease, *Peronospora infestans*. This parasite is almost peculiar to the Solanaceæ, being especially destructive to Solanum, Lycopersicum, and Petunia, but at times it invades the Scrophularineæ and grows on Anthocersis and Schizanthus. It is not common to find one parasitic fungus attacking the members of two natural orders of plants, but other examples could be given.

W. G. S.

### A Cannibal Snake

ABOUT eighteen months ago, just previous to my leaving India, at Devalah in the Wynaad, the horsekeepers chased and killed a large cobra, 5 feet 4 inches; previous to death it was thrown down in front of the door of our house, when, after a good deal of twisting and wavy contortion of the body, it disgorged a small rock snake over 4 feet in length. I had heard of the same thing before in India, so that I do not think cannibalism in snakes is so uncommon as Mr. Evans thinks.

JOHN FOTHERINGHAM

96, Netherwood Road, West Kensington Park, W., July 12

### FOURTH NOTE ON THE ELECTRICAL RESISTANCE OF THE HUMAN BODY

IN my communication to NATURE (vol. xxix. p. 528) I described the use of alternating currents and the telephone for the above purpose, and promised to endeavour to obtain at least an approximate measurement of the E.M.F. developed in the secondary coil of an induction apparatus. This promise I now propose to fulfil. But before proceeding to the special subject of the present note, I should wish to draw attention to a paper which appeared on the 15th of the same month in the *Asclepiad*, by that able experimentalist Dr. B. W. Richardson. He therein describes not only experiments made with the large induction coil of the Polytechnic, but also others made as early as 1868 in conjunction with the late Mr. Becker, the object of which was to obtain a measure of the resistance of animal structures.

"The results," says Dr. Richardson, "were not fully satisfactory. They were variable even when the conditions under which the experiments were made were entirely the same. This variability we found to be due to decomposition of the animal substance, a decomposition which, however feeble the battery, was sufficient to destroy the precision we desired to obtain." Putting the more recently coined word "polarisation" for decomposition, this expresses exactly the difficulty described by me in my first note. "It was, however, possible," says the doctor, "to make out that blood conducted better than any other structure of the body, and better than water."

I can now fully corroborate this excellent observation, and perhaps extend its application.

Physiological and even pathological fluids, such as the serum of dropsy, conduct far better than muscle, bone, and nerve. One instance out of many may serve. In the very first case recorded in my communication to NATURE (vol. xxviii. p. 151) the lowest resistance obtained from foot to foot was 2300 ohms. The patient was then very emaciated, but quite free from dropsy. Towards the end of the case, which after death proved to be one of ulcerative endocarditis, as I had considered it to be during life, slight but distinct dropsical effusion in the lower extremities set in; the resistance sank at once to 700 ohms, and I had to discontinue my observations from the evident change of electrical conditions. I have since verified the same fact many times, and on it I partly found the belief, already several times stated, that "the human body, in spite of its large amount of liquid constituents, follows a similar thermal law of resistance to that influencing solid conductors, though in a very much higher ratio" (NATURE, vol. xxviii. p. 152).

Dr. Richardson does not seem to have attempted to determine the resistance of the living body, which Du Moncel, in 1877, did, and with fairly accurate, if unpleasant, results (NATURE, vol. xxix. p. 528). On the discovery, however, in 1879, of Prof. Hughes's electric balance, he resumed his observations, this time with an alternating induction current, though he does not himself notice the important change. His results are unfortunately taken in arbitrary units on the graduated scale of 200 parts originally applied to Prof. Hughes's instrument. If there is any way of reducing these fictitious to absolute values, my work will be both lightened and assisted by a proved observer. Blood-clot and serum, white and gray nervous substance, muscle, bone, coagulated albumen, gelatine, and pus were all tested. Some of the results were excellent. For instance, fat, which by one experimenter has been stated to increase the conductivity of the body, is found by Dr. Richardson, as I also have found it, to be an absolute non-conductor. It is almost unnecessary to say that, with so skilled a chemist and physiologist, all proper temperature corrections and other similar precautions were most strictly observed.

I can now proceed to the main topic of my present note. On receipt of the Wurzburg dynamometer it was put in adjustment, and a strenuous effort made to compare the indications given with a constant and an alternating current, to both of which it is sensitive. But the movable suspended coil made of an ivory core, with a double weight of silk-covered copper wire, hung by a platinum hook, and dipping by its other termination into a vessel of strong sulphuric acid by means of a platinised platinum plate, is very heavy; takes a long time to get to its full deflection, thus allowing the battery to run down sensibly, and, what is worst of all, has a tendency to "integrate." By this I mean to sum up, by its mechanical inertia, a large number of small, intermittent pulls as given by the reversed current, into an almost identical deflection (less, of course, losses) with that given by the one steady pull of a continuous current. In spite of its beautiful workmanship, it had to be discarded for the present research. Somewhat in despair, I fell back on a similar instrument, shown by me at the Oxford meeting of the Physical Society in June 1882, and there heavily abused. The moving coil in this is made of silk-covered aluminium wire to insure lightness, and the bifilar suspension is made of the silver-gilt wire used for military epaulettes and facings. It is the work of my own poor hands.

Herr Obach then stated, and the statement was repeated in your columns, that this material had already been used by Messrs. Siemens for their "dust-recorders," but had failed by difficulty of making contact. On testing my little toy, I found its resistance had not

altered in twenty-five months one fraction of an ohm, and that it moved briskly up to its maximum, standing there quite long enough for a good observation. Indeed, in spite of its condemnation by a jury of experts over two years ago, it was still so lively that I thought it better to check extra swing by a small platinum paddle 1 cm. square moving in sulphuric acid.

On a metre scale, at one metre distance, the reflected image in a telescope gave '365 mm. deflection<sup>1</sup> with the whole induction current from Prof. Kohlrausch's metre-bridge, as described in my last note.

The object now was obviously to obtain an independent measure of the actual E.M.F. to which this deflection was due. The quadrant electrometer, or some other delicate potential measurer, of course suggested itself. A trapdoor portable, kindly lent me by Prof. McLeod, refused to take notice of my wretched little currents, limited as they are by human susceptibility. I do not possess a quadrant, nor will the Royal Society, though twice asked, lend me one. Here again my friends at Cooper's Hill came to my rescue, and I have to express my thanks, not only to Prof. McLeod, but also to Prof. Stocker and his excellent demonstrator Mr. Gregory, for their assistance. With my Kohlrausch induction bridge in a big bag I journeyed to Egham, and thence on foot to Cooper's Hill.

The formula to be made use of was obvious. It is given in Prof. Adams's Cantor lectures, and has been kindly verified for me by Prof. Hopkinson. In it the needle is connected with one pair of quadrants, so that  $V_3 = V_1$ . In this case—

$$\text{Deflexion} = \frac{k}{2} (V_1 - V_2)^2.$$

Prof. Adams has since shown me a different, and perhaps better, way of working, which I intend to make use of in the future. It was found that the two fine quadrant electrometers at Cooper's Hill College were unavailable; the one given by Lord Salisbury not admitting of the needle being placed in connection with either pair of quadrants, the other being disabled by some casual contact. We therefore with heavy hearts made a last struggle with the old Elliott pattern and single quadrants. This succeeded admirably, and on a mean of the four best out of six observations, we obtained a deflection of 107 with the intermittent current. "In order to be quite sure," Mr. Gregory wrote to me next day, "of the true value of the mean deflection we obtained, I have executed measurements with different numbers of cells. In these, the negative pole was to earth, the positive being connected at will to either pair of quadrants, and the needle also at will to either pair, giving four readings for each observation. I give only means, which agree well.

E.M.F.	Defl.	k
21 volts	32.75	149
29 "	63.75	151
47 "	161.75	146
Mean	...	1486

k was calculated from the formula

$$k = \frac{2}{\delta} (V_1 - V_2)^2.$$

By calculation, using the mean value of k, the E.M.F. to give a deflection of 107 came out 38. By observation, using an E.M.F. of 38 volts, the deflection was 107.25. This agrees so well with the calculated value that it will be easy to evaluate the E.M.F. corresponding to any deflection by the above formula."

The effect of rapid alternations seems to be to lessen the deflection, though Mr. Glazebrook stated, in a paper read before the Physical Society, that with between 10 and 120 contacts per second the result, in charging a condenser, was not perceptible.

<sup>1</sup> The bridge arrangement being entirely disconnected.

On the whole therefore, though I agree with Mr. Gregory that we have not obtained a measure of the maximum E.M.F., but only an integration, disregarding sign, the approximation is, I hope, superior to any made before, and affords a good general basis for farther work.

W. H. STONE

### GAS-BURNERS<sup>1</sup>

THE economist who wished to point the moral of a healthy competition in industrial commerce could scarcely find a better instance to his hand than the progress made by gas illumination under the impetus given in the last few years by the rise of electric lighting. It is not overstating the case to say that greater improvement in the use of gas has been made since Jablochhoff introduced his electric candle than in the previous sixty years' history of gas lighting. Compared with the recent development of invention, the long period of non-competition appears almost stagnant. With the introduction of electricity arose a popular demand for "more light." With a new illuminant competing for favour, consumers growled more openly at "bad gas" and high gas bills. Each advance of the electric light was greeted with acclamations by the popular voice, shareholders began to tremble, and gas shares came down with a rush. It was time for gas managers and manufacturers to bestir themselves. The happy days of a monopoly in light seemed over. The consumers have reaped the benefit. Under the stimulus of competition the price of gas has been lowered, impurities have been cut down. Some half a dozen years ago the great London Companies were endeavouring to prove before a Parliamentary Committee that coal-gas could not be purified from bisulphide of carbon without creating such a nuisance as to be intolerable. Their object was to do away with the lime purifiers, made necessary by the regulations of the Gas Referees, and to use only oxide of iron. Since the advent of the electric light not a word has been heard about the impossibility of purifying coal-gas by lime. On the contrary, every effort is now made to supply gas as free from sulphur as possible. But while the gas has thus been improved in quality and lowered in price, a still greater improvement has been effected in the methods of burning it. By the application of the regenerative principle to gas-burners, the illuminative value of coal-gas has been doubled.

But in spite of the great advances made in gas-burners, the public have by no means yet reaped the full benefit. Owing to the carelessness of gas-fitters and the ignorance of consumers, the great majority of those who light their houses by gas waste at least 20 per cent. of their gas as an illuminating agent. If the flame smokes, or flickers, or gives a poor light, most people put it down to "bad gas," when in reality the burner is unsuitable, or worn out, or the supply pipes (nearly always too small) are choked. To all who burn coal-gas in their houses, and are troubled with "bad gas," we can heartily recommend "Gas-Burners, Old and New" by Owen Merriman.

This little book, published at a price which places it within the reach of a large public, describes very plainly in popular language the evolution of the best modern burners of Sugg, of Bray, and of Siemens, from the original "cock-spur burner" of Murdock, and Accum's "tube with a simple orifice, at which the gas issues in a stream, and if once lighted will continue to burn with the most steady and regular light imaginable, as long as the gas is supplied." The illustrations are all that can be desired.

Owen Merriman has taken pains to insist on the two great desiderata of gas-burners—high temperature and low temperature, but we think he has gone too far in attempting to give a popular "theory of luminous combus-

<sup>1</sup> "Gas-Burners, Old and New." By Owen Merriman. (London: Walter King, 1884.)

tion." We are told that "the various gases which constitute ordinary coal-gas do not all burn together in the flame; . . . thus hydrogen is the first to burn, taking fire readily as soon as it issues from the burner, while the combustion of heavy hydrocarbons does not commence until they enter the hotter portions of the flame." Again Owen Merriman says: "the amount of light developed by any coal-gas flame is *directly proportional* to the degree of intensity to which the temperature of the carbon particles is raised." The italics are ours. In a note on page 23 there is some confusion as to the effect of the admission of air into a Bunsen burner. "A continuous wind blowing upon the flame destroys its luminosity altogether, because the heat intensity of the flame is *lowered below the temperature necessary to decompose the hydrocarbons*: consequently these latter burn without the preliminary separation of carbon, and a non-luminous flame is produced—exactly as in the Bunsen burner." The reader would gather from this that the flame of a Bunsen was colder than an ordinary flame, and by the same argument the blast of a blow-pipe would render a gas-flame colder instead of hotter. And again on page 43 a similar mistake is made when we are told that a too long flame is bad because the gas is "brought too early into intimate contact with air, and so oxidised, or fully consumed, *before its carbon has been raised to the temperature necessary to enable it to give out light.*" We point out these few blemishes in the hope that the author may correct them in a future edition of the work, to which we wish a hearty success.

#### BIRDS'-NEST SOUP

IT is scarcely probable that the famous birds'-nest soup which Chinese cooks at the Health Exhibition offer to favoured visitors will ever become a popular dish in England. The tasteless, gelatinous compound is not suited to our palates. Perhaps this is not to be regretted, as the supply of material for this mysterious compound is far from being inexhaustible. There appears to be only one place in the world where it can be obtained in any quantity, and this has recently been visited by Mr. Pryer, a naturalist of Yokohama, who communicates his observations to the *Japan Gazette*, an English journal published in that settlement. Leaving Elopura, the infant capital of the infant colony of British North Borneo, in March last, Mr. Pryer ascended for some thirty miles the Sapugaya River, which flows into Sandakan Bay, on which the town is built. Passing through the mangrove and nipa swamps which line the banks, he arrived at noon on the second day at his destination—the celebrated birds'-nest caves of Gomanton. These caves, which are two in number, called by the natives the Black and the White Caves, are situated in a limestone cliff 900 feet in height, which the traveller came on quite suddenly in the centre of the forest. The porch, Mr. Pryer writes, is rather over 100 feet wide by 250 high, and the roof slopes up for 110 feet more, so that the height of this magnificent natural cathedral is 360 feet. The interior of the Black Cave is well lighted, as there is a large circular hole in the roof on the right, and a smaller one on the left, forming two aisles. The walls and roof are rugged, and beautifully coloured, shading from black to brown, gray, dark yellow, red, and green. The nests of the bats and swifts were seen hanging in clusters from the sides and roof, and here and there in seemingly the most inaccessible places were the rattan stages, ladders, and ropes of the nest-gatherers. These latter reached their perilous heights by means of many smaller caves in the cliff above. The White Cave is 400 feet higher up than the Black Cave, and at the entrance to this the nest-gatherers live under a guard of the North Borneo Company's soldiers. After some examination Mr. Pryer was able to discover the material which forms these mysterious

nests, and from which they derive the qualities which render them so highly prized in China. They are made from a soft fungoid growth that incrusts the limestone in all damp situations; it grows about an inch thick, outside dark brown, but inside white. The birds make the black nests from the outside layer, and the best quality of white nests are, of course, from the inside. It is taken by the bird in its mouth, and drawn out in a filament backwards and forwards like a caterpillar weaving its cocoon. At nightfall takes place what the natives style with much justice the most wonderful sight in all Borneo, and it might be added, one of the most wonderful sights in the world—viz. the return of the swifts to their nests, and the departure of the bats for the night. About that time a rushing sound was heard, and peering over the abyss into the Black Cave Mr. Pryer saw columns of bats wheeling round and round the sides in regular order; soon they began to circle up, rising into the air in a corkscrew flight. Having reached a certain height, a detachment would break off and fly away rapidly. He counted nineteen flocks go off like this, each flock consisting of many thousands, and then they commenced to pour away in a continuous stream until it was too dark to see them any longer. Soon after the bats emerged from their cave, the swifts began to return to theirs, first in tens, then in hundreds, and at last they too streamed in continuously, and when the traveller went to sleep at midnight they were still flying in in undiminished numbers. Rising before daylight the following morning, Mr. Pryer witnessed a reversal of the proceedings of the previous night, the swifts going out and the bats coming home. The latter, he says, literally rained into their chasm for two hours after sunrise; looking up to the bright sky, numbers of small specks appear, flash down perpendicularly with great rapidity, and disappear into the darkness. From specimens of the bat which were secured, they were found to be all of one species, the caudal membrane extending only half down the tail, which is free for an inch and a half, giving the animal, when the wings are folded up, very much the appearance of a mouse. The wings are very long and narrow, and it flies with great speed. Two species of birds of prey—one a kite, the other a hawk—the *Haliastur indus* and the *Machceramphus alcinus*, prey on the bats and swifts when swarming into and out of the caves. A detailed examination of the latter was rendered disagreeable by enormous quantities of guano, the deposit of centuries. Its depth is not known, but a long spear does not touch the bottom when thrust in to the hilt. All the roof of the dark parts of the cave was occupied by birds who keep up an intermittent twittering, sounding, from the immense number of them, like the surf beating on a rocky shore. Near the centre of the largest cave the explorer was shown a small beam of light from a funnel at the top of the rock, exactly 696 feet above his head. The nests are gathered from these enormous elevations by means of flexible rattan ladders and stages. On these two men take their station; one carries a light four-pronged spear about 15 feet long, and just below the prongs a lighted candle is fixed. Holding on to the ladder with one hand, the spear is managed with the other, and the nest transfixed, a slight push detaching it from the rock. The spear is then withdrawn until the head is within reach of the second man, who takes the nest off the prongs and puts it in a pouch carried at the waist. According to statements made by the headman of the place, the annual value of the nests taken varies from five to six thousand pounds sterling. This, it is to be presumed, means the value on the spot; their value on reaching China must be far higher. The caves have been worked for seven generations without any apparent diminution, although three crops are gathered in the year. Notwithstanding the dangerous nature of their occupation—for even samphire-gatherers work in the open—accidents are very rare amongst the natives employed in



collecting the nests. There is an almost inexhaustible supply of guano in the caves, and the number of bats and swifts in them is so enormous that if they are undisturbed a regular quantity may be taken out yearly. Should the visitor to the Health Exhibition who obtains some of this far-famed and mysterious soup have little relish for it, as is not unlikely, he will at any rate have the satisfaction of knowing that he has before him a dish the principal ingredient of which was formed by the little swifts and bats which inhabit the Gomanton Caves in the centre of the magnificent tropical forests of North Borneo. There is probably no other article of food in the Health Exhibition, or in all Europe, more extraordinary in the mode of production, or in the method and circumstances under which it is obtained.

### ON THE EVOLUTION OF FORMS OF ORNAMENT<sup>1</sup>

#### II.

THE leaf in *Dracunculus* has a very peculiar shape: it consists of a number of lobes which are disposed upon a stalk which is more or less forked (tends more or less to dichotomise). If you call to your minds some of the Pompeian wall decorations, you will perceive that similar forms occur there in all possible variations. Stems



FIG. 12.

are regularly seen in decorations that run perpendicularly, surrounded by leaves of this description. Before this, these suggested the idea of a misunderstood (or very conventional) perspective representation of a circular flower. Now the form also occurs in this fashion, and thus negatives the idea of a perspective representation of a closed flower. It is out of this form in combination with the flower-form that the series of patterns was developed which we have become acquainted with in Roman art, especially in the ornament of Titus's *Thermae* and in the Renaissance period in Raphael's work. [The lecturer here explained a series of illustrations of the ornaments referred to (Figs. 12, 13, 14).]

<sup>1</sup> From a paper by Prof. Jacobsthal in the *Transactions* of the Archaeological Society of Berlin. Continued from p. 251.

The attempt to determine the course of the first group of forms has been to a certain extent successful, but we meet greater difficulties in the study of the second.

It is difficult to obtain a firm basis on which to conduct our investigations from the historical or geographical point of view into this form of art, which was introduced into the West by Arabico-Moorish culture, and which has since been further developed here. There is only one method open to us in the determination of the form, which is to pass gradually from the richly developed and strongly differentiated forms to the smaller and simpler



FIG. 13.

ones, even if these latter should have appeared contemporaneously or even later than the former. Here we have again to refer to the fact that has already been mentioned, to wit, that Oriental art remained stationary throughout long periods of time. In point of fact, the simpler forms are invariably characterised by a nearer and nearer approach to the more ancient patterns and also to the natural flower-forms of the *Araceæ*. We find the spathe, again, sometimes drawn like an *Acanthus* leaf, more often, however, bulged out, coming to be more and more of a mere outline figure, and becoming converted into a sort of background; then the spadix, generally conical in



FIG. 14.

shape, sometimes, however, altogether replaced by a perfect thistle, at other times again by a pomegranate. Anberville in his magnificent work "*L'Ornement des Tissus*," is astonished to find the term pomegranate-pattern almost confined to these forms, since their central part is generally formed of a thistle-form. As far as I can discover in the literature that is at my disposal, this question has not had any particular attention devoted to it except in the large work upon Ottoman architecture, published in Constantinople under the patronage of Edhem Pasha. The pomegranate that has served as the original of the pattern in question is in this work surrounded with leaves

gives some sort of an approach to the pattern. (The following are important suggestions in the book as to the employment of melon-forms.) Whoever has picked the fruit from the tender twigs of the pomegranate-tree, which are close set with small altered leaves, will never dream of attributing the derivation of the thorny leaves that



FIG. 15.

appear in the pattern to pomegranate-leaves at any stage of their development.

It does not require much penetration to see that the outline of the whole form corresponds to the spathe of the Araceæ, even although in later times the jagged contour is all that has remained of it, and it appears to have been provided with ornamental forms quite independently of



FIG. 16.

the rest of the pattern. The inner thistle-form cannot be derived from the common thistle, because the surrounding leaves negative any such idea. The artichoke theory also has not enough in its favour, although the artichoke, as well as the thistle, was probably at a later time directly pressed into service. Prof. Ascherson first called my attention to the extremely anciently cultivated plant, the

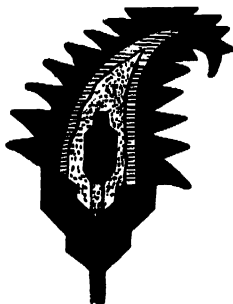

FIG. 17.



FIG. 18.



FIG. 19.

Safflor (*Carthamus tinctorius*, Fig. 15), a thistle plant whose flowers were employed by the ancients as a dye. Some drawings and dried specimens, as well as the literature of the subject, first gave me a hope to find that this plant was the archetype of this ornament, a hope that was borne out by the study of the actual plant, although I was unable to grow it to any great perfection.

In the days of the Egyptian King Sargo (according to Ascherson and Schweinfurth) this plant was already well known as a plant of cultivation; in a wild state it is not known (De Candolle, "Originel des Plantes cultivées"). In Asia its cultivation stretches to Japan. Semper cites a passage from an Indian drama to the effect that over the doorway there was stretched an arch of ivory, and about it were bannerets on which wild saffron (*Saffor*) was painted.

The importance of the plant as a dye began steadily to decrease, and it has now ceased to have any value as such in the face of the introduction of newer colouring matters (a question that was treated of in a paper read a short time ago by Dr. Reimann before this Society). Perhaps its only use nowadays is in the preparation of rouge (*rouge végétale*).

But at a time when dyeing, spinning, and weaving

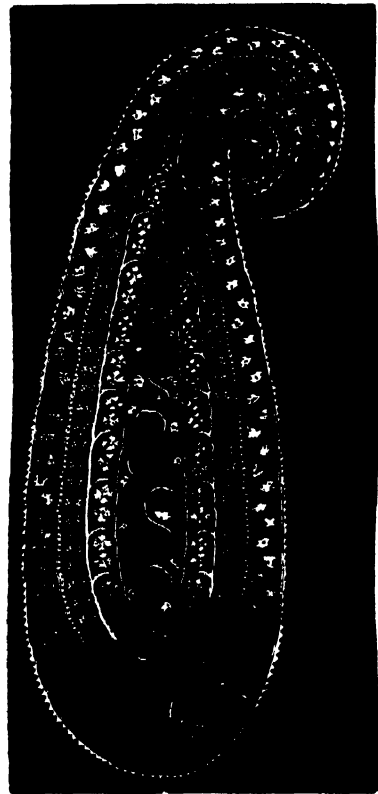

FIG. 20.

were, if not in the one hand, yet at any rate intimately connected with one another in the narrow circle of a home industry, the appearance of this beautiful gold-yellow plant, heaped up in large masses, would be very likely to suggest its immortalisation in textile art, because the drawing is very faithful to nature in regard to the thorny involucre. Drawings from nature of the plant in the old botanical works of the sixteenth and seventeenth centuries look very like ornamental patterns. Now after the general form had been introduced, pomegranates or other fruits—for instance, pine-apples—were introduced within the nest of leaves.

Into the detailed study of the intricacies of this subject I cannot here enter; the East-Asian influences are not to be neglected, which had probably even in early times an effect upon the form that was assumed, and have fused the correct style of compound flowers for flat ornament with the above-mentioned forms, so as to produce peculiar

patterns; we meet them often in the so-called Persian textures and flat ornaments (Fig. 16).

We now come to the third group of forms—the so-called Cashmere pattern, or Indian palmetta. The developed forms which, when they have attained their highest development, often show us outlines that are merely fanciful, and represent quite a bouquet of flowers leaning over to one side, and springing from a vessel (the whole corresponding to the Roman form with the vessel), must be thrown to one side, while we follow up the simpler forms, because in this case also we have no information as to either the where or the when the forms originated. (Figs. 17, 18, 19.)

Here again we are struck by resemblances to the forms that were the subjects of our previous study, we even come across direct transitional forms, which differ from the others only by the lateral curve of the apex of the leaf; sometimes it is the central part, the spadix, that is bent outwards, and the very details show a striking agreement with the structure of the Aroid inflorescence, so much so that one might regard them as actually copied from them.

This form of ornament has been introduced into Europe since the French expedition to Egypt, owing to the importation of genuine Cashmere shawls. (When it cropped up in isolated forms, as in Venice in the fifteenth century, it appears not to have exerted any influence; its introduction is perhaps rather to be attributed to calico-printing.) Soon afterwards the European shawl-manufacture, which is still in a flourishing state, was introduced. Falcot informs us that designs of a celebrated French artist, Couder, for shawl-patterns, a subject that he studied in India itself, were exported back to that country and used there (Fig. 20).

In these shawl-patterns the original simple form meets us in a highly developed, magnificent, and splendidly coloured differentiation and elaboration. This we can have no scruples in ranking along with the mediæval plane-patterns, which we have referred to above, among the highest achievements of decorative art.

It is evident that it, at any rate in this high stage of development, resisted fusion with Western forms of art. It is all the more incumbent upon us to investigate the laws of its existence, in order to make it less alien to us, or perhaps to assimilate it to ourselves by attaining to an understanding of those laws. A great step has been made when criticism has, by a more painstaking study, put itself into a position to characterise as worthless, ignorantly imitated, or even original, miscreations such as are eternally cropping up. If we look at our modern manufactures immediately after studying patterns which enchant us with their classical repose, or after it such others as captivate the eye by their beautiful colouring, or the elaborative working out of their details, we recognise that the beautifully-balanced form is often cut up, choked over with others, or mangled (the flower springing upside down from the leaves), the whole being traversed at random by spirals, which are utterly foreign to the spirit of such a style, and all this at the caprice of uncultured boorish designers. Once we see that the original of the form was a plant, we shall ever in the developed artistic form cling, in a general way at least, to the laws of its organisation, and we shall at any rate be in a position to avoid violent incongruities.

I had resort, a few years ago, to the young botanist Ruhmer, assistant at the Botanical Museum at Schöneberg, who has unfortunately since died of some chest-disease, in order to get some sort of a groundwork for direct investigations. I asked him to look up the literature of the subject, with respect to the employment of the Indian Araceæ for domestic uses or in medicine. A detailed work on the subject was produced, and establishes that, quite irrespective of species of *Alocasia* and *Colocasia* that have been referred to, a large number of Araceæ were

employed for all sorts of domestic purposes. *Scindapsus*, which was used as a medicine, has actually retained a Sanscrit name, "vustiva." I cannot here go further into the details of this investigation, but must remark that even the incomplete and imperfect drawings of these plants, which, owing to the difficulty of preserving them, are so difficult to collect through travellers, exhibit such a wealth of shape, that it is quite natural that Indian and Persian flower-loving artists should be quite taken with them and employ them enthusiastically in decorative art. Let me also mention that Haeckel, in his "Letters of an Indian Traveller," very often bears witness to the effect of the Araceæ upon the general appearance of the vegetation, both in the full and enormous development of species of *Caladia* and in the species of *Pothos* which form such impenetrable mazes of interlooping stems.

In conclusion, allow me to remark that the results of my investigation, of which but a succinct account has been given here, negative certain derivations, which have been believed in, though they have never been proved; such as that of the form I have last discussed from the Assyrian palmetta, or from a cypress bent down by the wind. To say the least the laws of formation here laid down have a more intimate connection with the forms, as they have come down to us, and give us a better handle for future use and development. The object of the investigation was, in general words, to prepare for an explanation of the questions raised, and even if the results had turned out other than they have, it would have sufficed me to have given an impulse to labours which will testify to the truth of the dead master's words:—

"Was Du ererbt von deinen Vätern hast,  
Erwirb es, um es zu besitzen."

#### NOTES

THE death is announced, at the age of seventy-four years, of Prof. Lepsius, the celebrated Egyptologist.

THE conference and jury work at the Health Exhibition is now in full swing, and we are glad to note that, with regard to the Conference, all the societies and organisations that have to deal with subjects akin to health or education are taking up the matter very warmly, so that the executive of the Exhibition has the advice and opinion of many experts. The recent opening of the Educational Section by the Prince of Wales, to which we have already referred, has recently drawn more attention to the *mens sana, the corpus sanum* having up to the present moment been alone regarded. From the first we consider that the matter of education has been placed altogether in far too secondary a position, and if a little more trouble had been taken by those who are responsible for the Exhibition, the educational exhibits might have been as extensive and as important as those regarding health. That is the more to be regretted because so much is being said about education nowadays, especially technical education, by those who know very often very little of what is really wanted, and of what true technical education really means. The members of the various juries are working with a will, and from what we learn we do not think it probable that the objections made to some of the awards last year will be renewed this. The opportunity which has been afforded to the exhibitors of practically nominating a considerable number of jurymen is a measure well adapted to allow the thing to work smoothly. One of the great difficulties encountered by the jurymen has been the hurried way in which the Exhibition itself has been put together and catalogued. We have for too great an extent a succession of shops containing various articles, instead of a complete separation of the various articles among their several classes. This of course gives great trouble to all concerned, and is an administrative blunder which should not be allowed to be repeated.

WE are glad to be able to announce that H.R.H. the Prince of Wales has become Patron of the Marine Biological Association, and has contributed a handsome donation to its funds. The following is now the full list of Officers and Council as definitely elected by the Association, at its meeting on June 17:—Patron, H.R.H. the Prince of Wales, K.G. President, Prof. Huxley (President of the Royal Society). Vice-Presidents: The Duke of Argyll, K.G., the Duke of Sutherland, K.G., the Marquis of Hamilton, the Earl of Dalhousie, K.T., Lord Walsingham (Trustee of the British Museum of Natural History), Edward Birkbeck, M.P. (Chairman of the Executive Committee of the International Fisheries Exhibition), George Busk, F.R.S., W. B. Carpenter, C.B., M.D., F.R.S., W. H. Flower (Director of the British Museum of Natural History), J. Gwyn Jeffreys, F.R.S., Sir John Lubbock, Bart., M.P. (President of the Linnean Society). Council: Prof. Moseley, F.R.S. (Oxford), Chairman, Prof. Jeffrey Bell, F.Z.S. (British Museum), W. S. Caine, M.P., W. T. Thiselton Dyer, C.M.G. F.R.S. (Royal Gardens, Kew), John Evans, D.C.L. (Treasurer Royal Society), A. C. L. G. Günther, F.R.S. (British Museum), Prof. Herdman (Liverpool), E. W. H. Holdsworth, Prof. McIntosh (St. Andrew's), Prof. Milnes Marshall (Manchester), Sir Philip Cunliffe Owen, K.C.M.G., C.B., G. J. Romanes, F.R.S. (Sec. Linn. Soc.), P. L. Sclater, F.R.S. (Sec. Zool. Soc.), Adam Sedgwick (Cambridge). Hon. Treasurer, Frank Crisp, (V.P. and Treas. Linn. Soc.), 6, Old Jewry, E.C. Hon. Secretary, Prof. E. Ray Lankester, F.R.S., 11, Wellington Mansions, North Bank, N.W.

WE regret to learn of the death of the venerable Abbé Moigno at the age of eighty-one years. The name of the Abbé has been long known in connection with French science, and more especially as the founder, and till quite recently the editor, of *Les Mondes*.

IT is proposed to hold a special American Exhibition in London in May 1886, at which the products, manufactures, and varied phases of life in the United States will be represented.

By a decree dated Ems, July 4, the Emperor conveys his thanks to Dr. Auwers, the celebrated astronomer who so successfully superintended the German preparations for observing the transits of Venus in 1874 and 1882. The Emperor further expresses his thanks for the assistance so hospitably rendered to the German scientific expeditions, not only by Germans living abroad, but also by many persons belonging to other nationalities.

BIOLOGISTS attending the Montreal meeting of the British Association will be pleased to hear that Prof. Asa Gray has promised to be present and to read a paper in Section D "On some characteristic features of the Botany of North America," with the special view of aiding botanists and members of the Section generally in their appreciation of the flora.

IT is announced from Montreal that a large number of the members of the British Association visiting Canada next month have already been "placed" in private houses in the city. The matter continues to be very heartily taken up in the towns of the Dominion, and there is every probability of a warm welcome being extended to the members. Considerable amusement has been caused in Montreal by some of the letters received by the Montreal Committee of the British Association from those members on this side of the Atlantic desiring information regarding Canada. The climate of the country is evidently a subject upon which there is much misconception among members. The queries on this point are most exacting, while a quite unwarranted dread of mosquitoes is held by not a few members. It is satisfactory to learn that a circular is now in course of preparation that will answer most of the queries received by letter, and that on the completion of the labours of the Private Hospitality Committee a directory of the visitors will be published.

PROF. R. S. BALL has accepted an invitation from the Lowell Institute, Boston, United States, to give a course of six lectures on "Chapters in Modern Astronomy" next October.

THE Society of Chemical Industry held their annual meeting in Newcastle last week. Dr. Perkin, F.R.S., was elected President for the next year.

UNDER the auspices of the Royal Geographical Society, Mr. E. C. Rye has done a most useful service to students by compiling a New Guinea Bibliography. It will be appended to Mr. C. R. Markham's paper on New Guinea, to be issued in No. 2, vol. i. of the Society's Supplementary Papers. Mr. Rye's Bibliography covers over fifty pages, and contains considerably over a thousand entries. It is evidently the result of immense labour and research, and is practically exhaustive. It includes not merely geography proper, but every aspect of the country; the references to natural history are specially copious, and include not only books but papers and notes in periodical publications of all kinds. The references are of the most precise character, and the whole is worthy of the editor of the *Zoological Record*.

IT may interest many of our readers—especially those who would like to add to the pleasure of a tour by a little photography—to know that the London Stereoscopic Company give gratuitous private lessons to amateurs who purchase their apparatus from the Company. We have no doubt this will solve a prime difficulty in the case of many who are ambitious to be able to photograph on their own account, but who do not know how to take the first step.

NOTWITHSTANDING the troubles that have surrounded Madagascar for the last year or two, the scientific activity of the missionaries of the London Missionary Society has not abated, and the native printing press has not been idle. We have just received from Antananarivo two numbers of the *Antananarivo Annual and Madagascar Magazine*, edited by the Rev. R. Baron, containing numerous papers of varied scientific interest. The following are those of most importance:—The Sakalava (No. 2), by the Rev. A. Walin; Notes on four species of Lemur and on the Aye-Aye, by Mr. G. A. Shaw; Customs connected with death and burial in Malagasy, by the Rev. S. E. Jørgensen; Resemblance between Malagasy words and customs and those of Western Polynesia, by the Rev. R. S. Codrington. In No. 7 for 1883 we have—The race elements of the Malagasy, by the Rev. L. Dahle; the Sakalava (No. 3), by the Rev. A. Walin; Volcanoes in Eastern Imerina, by the Editor; Malagasy "Fady" (Tabu), by Mr. H. E. Standing; Genera of Malagasy plants, by the Editor; Relics of sign and gesture language among the Malagasy, by the Rev. J. Sibree; and various natural history and meteorological notes.

DR. REGEL, the Russian traveller, who recently arrived in Merv, intends proceeding along the northern mountain slopes of Afghanistan and the Amu Daria to Pamir. This journey will conclude the doctor's explorations in Central Asia.

THE Milan Society for the Commercial Exploration of Africa has organised a circumnavigation of Africa, with a view of affording the pupils of the High School of Commerce, and others, an opportunity of becoming acquainted with likely markets for Italian products. The steamer will leave Genoa on September 1, and the whole voyage will occupy four months. A professor is to lecture during the voyage on the commercial geography of Africa.

THE first mail from Kadiak Island received this season, *Science* states, has arrived at San Francisco, bringing dates to May 2. According to the correspondent of the *Bulletin*, the account of the eruption of the volcano on Augustine Island, Cook's Inlet, sent by the last advices of 1883, was much exaggerated. The island "was not split in two, and no new island was formed

but the west side of the summit has fallen in, forming a new crater, while the whole island has risen to such an extent as to fill up the only bay or boat harbour, and to extend the reefs, or sea-otter rocks, running out from the island in various directions." The hunting-party feared to be lost has arrived safely in Kadiak. No tidal waves were observed on the west shore of Cook's Inlet or on Kadiak Island. The winter had been very mild, the mercury not having fallen below 10° F.; and spring began in March, wild flowers being in bloom in the latter part of April.

THE educational statistics of Japan for the past year show that the number of common schools throughout the country is 29,081, being an increase of 339 as compared with the preceding year, while the number of scholars is 3,004,137, an increase of 396,960, and the number of teachers is 84,765, being an increase of 8147.

THE Swedish Government have granted a sum of 850*l.* for the establishment of five additional so-called "chemical" stations, in order to benefit the agriculturist with scientific advice as to the crops, their diseases, &c.

THE sixth Davis Lecture of the Zoological Society of London was given in the Lecture-Room in their Gardens in Regent's Park, on Thursday, the 10th inst., by Mr. Henry Seebohm. The subject was that of "Birds' Nests," and consisted of an account of the breeding of birds on the Fern Islands off the coast of Northumberland, on the Derbyshire Moors, and in the valley of the Lower Danube. The lecturer pointed out that, so far as regards the means which birds take for the protection of their eggs, they may be classified in five groups—(1) those which rely upon the concealed position of the nest, such as the kingfishers, bee-eaters, pigeons, &c.; (2) those which rely upon the inaccessible position of the nest, such as guillemots, herons, &c.; (3) those which rely upon the protective colour of the eggs, such as sandpipers, terns, &c.; (4) those which rely upon the protective colour of the sitting hen, such as the blackbird, game birds, &c.; (5) those which rely upon their own ability, either singly, in pairs, or in colonies, to defend their eggs, such as cormorants, birds of prey, &c. Mr. Seebohm laid great stress upon the much greater interest to be found in the study of the life and habits of birds than in the investigation of the form and colour of their feathers or the peculiarities of their anatomy.

UNDER the auspices of the East India Association, a meeting of naturalists, planters, sportsmen, and others interested in the affairs of India, was held on Friday, July 11, at the rooms of the Zoological Society, under the presidency of Prof. Flower, LL.D., F.R.S. (Director of the British Museum Natural History Department, and President of the Zoological Society), for the purpose of urging the necessity of Government measures for the preservation of wild birds in India. The principal address was delivered by Mr. Robt. H. Elliot, sometime planter of Mysore, and a well-known writer upon Indian topics. He pointed out that every civilised Government with the exception of that of India has recognised the value of birds as insect-eaters, and has adopted measures for their preservation; and that the absence of legislation forebodes, where it has not yet presented, serious results to planters and agriculturists. As the most convenient season for the destruction of birds is during the fine weather that succeeds the heavy rains of the monsoons, and as this season is also the breeding time, the destruction of insect-eating birds proceeds at such a rate as must soon lead to almost absolute extermination unless preservative measures are speedily adopted. There was a general agreement at the meeting that legislation on the subject is imperatively required; and it was resolved that a representation to that effect should be addressed to the Government of India.

MR. J. H. ANGAS, who has already founded an engineering scholarship of the annual value of 200*l.* in the Adelaide Uni-

versity, has signified his intention of endowing a Chair of Chemistry. For this purpose Mr. Angas is prepared to give the sum of 6000*l.*, and to pay an annual sum of 350*l.* until he pays over the capital sum. A letter to this effect from Mr. J.H. Angas was recently read by the Chancellor at a special meeting of the Council. The Council resolved to accept the gift, and authorised the Chancellor to write and thank Mr. Angas for his continued munificence to the University.

PROF. MILNE of Tokio, Japan, writes to us:—"A short time ago I described a pair of conical pendulum seismographs. Each seismograph consisted of a heavy mass suspended by a string, &c. A local paper describing this innocently gave to the world an account of a pair of 'comical pendulums.' Each 'comical' pendulum consisted of a heavy 'man' suspended at the end of a string, &c. These errors, which were repeated throughout the article, did so much to popularise the instrument that their correction was neglected."

A RECENT number of *L'Exploration* contains an article by the Chanceller of the French Consulate at Hanoi, M. Aumoitte, which possesses special interest at the present time. It is the record of a journey from Hanoi through Bacninh to Langson on the Chinese frontier, thus following the same route as the French troops have done in their recent operations in Tonquin. From Hanoi to the meeting of the provinces of Bacninh and Langson, the country is described as populous and fertile, but on entering the latter district it becomes mountainous, with bad roads, and almost depopulated by the brigand hordes which have infested this borderland. Almost everywhere the water is bad, and fever rife even amongst the natives. Nowhere is this the case more than at Bacle, where the French forces are now hurrying up to retrieve the recent reverse at Langson. The country around Langson is described as healthy, it is rich in rice and cotton, but the trade here, as all along the valley of the Red River, is in the hands of the Chinese. When the French occupy this region, and when the recent treaty is carried out, we may expect a vast addition to our scanty knowledge of the geography of this little visited region.

FROM a paper contributed by the veteran scholar, Dr. Edkins, to a recent number of the *Chinese Recorder*, it appears that about B.C. 2200 the Chinese possessed a knowledge of the art of writing, a year of 366 days with an intercalary month, the astrolabe, the zodiac, the cycle of sixty, of twelve musical reeds forming a gamut, which also constituted the basis of a denary metrology for measures of length, weight, and capacity, divination, and a feudal system. In B.C. 1130 they were acquainted with the clepsydra and with the gamut of five musical notes. "Human knowledge was systematised in a scheme of numerical categories in which the five elements played a special part." About B.C. 550 the silk trade sprang into existence, the stars were classified, foreign names of unknown origin were introduced for the purpose of applying the cycle of sixty-two years. About B.C. 140 Chinese travellers visited Afghanistan, India, Bactria, &c. The cycle of Calippus was introduced into Chinese astronomy, and geographical knowledge concerning western nations was acquired. In the first two centuries of our era trade became more extended by sea; paper-making and the manufacture of ink were introduced from Europe, the Babylonian cosmogony became the main element of the Taoist cosmogony, and the gamut of five was increased to seven notes.

THE last volume (ii.) of the *Revue d'Ethnographie* contains, among others, articles by M. Bertrand on the Troglodytes, the introduction of metals into the West, and the great routes of migration and commerce in the earliest historical period; by M. Charnay, on the ruins in Yucatan; by M. Deniker, on the Giliaks; by Dr. Martin, on the cranial malformation of the

Chinese; by M. Ujfalvy, on the Aryans north and south of the Hindoo Koosh; and by Baron Vaux, on the Kanakas of New Caledonia.

THE additions to the Zoological Society's Gardens during the past week include two Quebec Marmots (*Arctomys monax* ♂ ♀) from North America, presented by Mr. N. Stainfield; a Prairie Wolf (*Canis latrans* ♂) from North America, presented by Mr. R. Payze; three Suricates (*Suricata tetradactyla*) from South Africa, presented by Mr. W. R. Dobbin; two Red-beaked Weaver Birds (*Quelea sanguinirostris* ♂ ♀) from West Africa, presented by Mrs. Nettleship; two Swift Parrakeets (*Lathamus discolor* ♂ ♀) from Tasmania, presented by Mr. J. Abrahams; four Common Vipers (*Vipera berus*), British, presented by Mr. Walter E. Blaker; two Smooth Snakes (*Coronella levis*), British, presented by the Rev. Charles Harris; two Red Kangaroos (*Macropus rufus* ♂ ♀), a Greater Sulphur-crested Cockatoo (*Cacatua galerita*) from Australia, deposited; four Beautiful Finches (*Estrela bella* ♂ ♂ ♀ ♀) from Australia, a Lanner Falcon (*Falco lanarius*), captured at sea, purchased; a Hybrid Lühdorf's Deer (between *Cervus luehdorfi* ♂ and *C. canadensis* ♀), a Hybrid Mesopotamian Deer (between *Dama mesopotamica* ♂ and *D. vulgaris* ♀), a Red Deer (*Cervus elaphus* ♀), four Australian Wild Ducks (*Anas streperullosa*), a Mandarin Duck (*Aix galericulata*), bred in the Gardens.

## ZOOLOGICAL NOMENCLATURE<sup>1</sup>

### II.

DR. COUES said that he was much gratified at the interest shown in the subject of zoological nomenclature, and indorsed the words of the Chairman that names were of the greatest possible consequence. Nomenclature was a necessary evil, and the point was always to employ that method of naming objects which should most clearly reflect not only the characters of the objects themselves, but our ideas respecting those characters and the view we take of them. As to what constitutes a species, there had been an absolute revolution in the definition of a species since the time of Linnæus, the opinion having been long held that every species was a distinct and individual creation. But that idea had passed out of existence in the minds of most natural historians of the present day, who accepted a general theory of the evolution of species by a gradual modification. That being the case, it was idle to inquire "What is a species?" no such thing existing any more than a genus; and so intimately related were all forms of animal and vegetable life that, if they were all before us, no naming would be possible, for each would be found to be connected completely with another; therefore the possibility of naming any species was, as it were, the gauge and test of our ignorance. Having thus touched very briefly upon the subject of missing links, which alone enable us to name objects which still exist, Dr. Coues proceeded to inquire, "What of so-called species the connecting links between which are still before our eyes?" In illustration of this he would cite some instances of connecting links which exist between certain forms. He then referred to the case of one of the best-known Woodpeckers in North America (*Picus villosus*), and discussed its climatal and geographical variation. He was of opinion that all these geographical races were indistinctly separable forms, and he would indicate them by trinomial names, proceeding upon the definite principle of geographical variation according to conditions of environment, meaning by this all the external influences which modify the plastic organism. Moisture, the humidity of the atmosphere, appeared to have the greatest effect, particularly in regard to colour. Latitude, with its varying degrees of heat, determined size more than any other influence. As a matter of fact this condition of things was found to occur, and the question was, How should we recognise it in our language? Specification had ceased to be of use, and the question was whether the system in favour in America was sufficient or insufficient to meet the case. On these points he would be glad to hear opinions; and in concluding he would read a paragraph from the new edition of the "Key to North American Birds," giving formally the rule for the employment of trinomials as now

<sup>1</sup> Continued from p. 259.

in use by American ornithologists and many other zoologists of the United States. This rule is as follows:—

"No infallible rule can be laid down for determining what shall be held to be a species, what a con-species, sub-species, or variety. It is a matter of tact and experience, like the appreciation of the value of any other group in zoology. There is, however, a convention upon the subject, which the present workers in ornithology in this country (America) find available—at any rate, we have no better rule to go by. We treat as 'specific' any form, however little different from the next, that we do not know or believe to intergrade with that next one;—between which and the next one no intermediate equivocal specimens are forthcoming, and none, consequently, are supposed to exist. This is to imply that the differentiation is accomplished, the links are lost, and the characters actually become 'specific.' We treat as varietal of each other any forms, however different in their extreme manifestation, which we know to intergrade, having the intermediate specimens before us, or which we believe with any good reason do intergrade. If the links still exist, the differentiation is still incomplete, and the characters are not specific, but only varietal, in the literal sense of these terms. In the latter case, the oldest name is retained as the specific one, and to it is appended the varietal designation."

Dr. Günther, F.R.S., said that during the whole of this discussion it appeared to him that this new movement was in fact a reaction. It had always appeared to him that ornithologists went too far in attaching to the slightest modification of colour the rank of a species; and when he looked over the list of species of a genus well known to him, he found there a number of different forms distinguished for very different reasons, and could not help being struck by the great diversity of value which was attached to the distinctive characters of these various forms. There was nothing to show that there was any system in distinguishing and naming the species of birds. He looked with favour on the method proposed by Dr. Coues and his compatriots. It was a system he had himself employed occasionally in his systematic writings since 1866, and Dr. Coues would find that in some cases he had adopted it pure and simple. He (Dr. Günther) had been disappointed in looking over the new edition of Dr. Coues' "Key to North American Birds," for he found there that Dr. Coues adopted trinomials in some cases and binomials in others. He maintained that logically one ought to adopt the trinomial nomenclature for all other forms, and keep the binomial only for that category in which these varieties may be contained. If Dr. Coues and those who were with him adopted that system, he for one would gladly employ it in all those cases in which the geographical range of certain forms is clearly ascertained.

Dr. Sclater, F.R.S., would remind Dr. Coues that this mode of designating the forms of animal life was by no means a new one, as might be seen on reference to Schlegel's "Revue Critique," published in 1844. He thought the only difficulty lay in the extent to which it was likely to be carried out. Dr. Coues, in his preface to the new "Key to the Birds of America" had hinted at this difficulty. If too much stress were laid upon the value of trinomialism we should open the flood-gates to an avalanche of new names by naturalists who have not taken enough trouble to investigate the matter under consideration. The time had now come when it would be advisable to a certain extent to use trinomials. He could not at all agree with Dr. Coues when he said that no such thing as species exists, for forms were known which had all the characters of well-marked species. It was only in cases where faunæ had been fully worked out that trinomial names would come into use, and for such forms he was quite prepared to adopt the system.

Mr. Blanford, F.R.S., said that he would add one word to the discussion, as nobody else had taken up the one or two points which might be advanced in opposition to the proposed system. He thought the movement an unfortunate one, for the reason that it would certainly have the effect of rendering nomenclature in general less certain than it was before. An equation containing three variables was much more complicated than one in which there were only two, and when one had three names any one of which was liable to be changed to suit personal views the fixture of nomenclature would be even further off than it is now. Then the case of ornithology was not nearly, in point of fact, so complicated as some other classes, as, for instance, in the Mollusca. Trinomial nomenclature had been proposed to,

<sup>2</sup> A more formal and elaborate presentation of Dr. Coues' views may be found in the *Zoologist* for July, 1884, p. 247, being the verbatim report of the address delivered before the National Academy of Sciences at Washington U.S.A., in April last.—Ed.

but almost universally rejected by a meeting of geologists. He did not consider that the time had arrived for any innovation, and thought it desirable first to agree upon strict rules of zoological nomenclature.

Prof. Bell agreed with Mr. Blanford that the method would not be universally applicable. How could it be applied for instance to cases where varieties were found living with one another, as was often the case with littoral forms with free-swimming embryos?

Mr. W. F. Kirby said that it was necessary to distinguish sub-species and varieties at times, and there seemed to be only two courses open to us, either to retain the binomial nomenclature, and to treat sub-species, so far as nomenclature was concerned, as equivalent to species, or to retain varietal names. Still it was difficult to lay down hard and fast rules, applicable to all cases; and he feared that the system of naming varieties was liable to great abuse, especially in entomology, where the number of species is already so great. Thus we have 100,000 species of *Coleoptera* on our lists; and one of the most variable families is that of the *Coccinellida*, in which some entomologists have lately begun to name mere colour varieties of single species by twenty and thirty at a time. Mr. Kirby thought, too, that, whenever a named form previously regarded as a variety was held by a later author to be worthy of specific rank, the varietal name should, wherever practicable, always be retained for the species, instead of a new one being imposed. He knew that this was not always adhered to, but in his own work he made it an invariable rule.

Lord Walsingham said that, as Dr. Coues suggested that the trinomial system should be used only in distinguishing gradations, he would instance two species very common in England, small species of the genus *Teras* (*Teras hastiana* and *Teras cristata*). These exhibited a very extensive series of individual variations, but some varieties, although perhaps reared from the same brood of larvae, showed marked differences not distinctly connected by intermediate gradations with other forms of colouring. He asked how the method was to be applied to these if indeed it was intended to be applied at all to such cases. He himself knew several cases in North America in which variation, according to latitude, is very marked. You get a form in Vancouver Island gradually merging into the form in California, and in Mexico something apparently distinct if taken by itself, and probably only an extreme variety in colour and markings, but you have no form for the South of California. Would it be proposed to treat this Mexican form as a proper subject for the trinomial system or to give it only two names as at present? The principle appears to be right provided it facilitates the recognition of the forms we are naming. He hoped there was no danger of drifting into the inconvenient multiplication of names too commonly known in the catalogues of professional horticulturalists.

Dr. Sharp said that whatever names we gave to morphological forms of less than specific value, whether we called them varieties, or sub-species, or morphological forms, we could not define or limit them; and if we attempted to name them, as no line could be drawn, we must go on till we gave a separate name to every individual that had passed through the hands of zoologists. He considered Dr. Coues' system of a third name unnecessary, because all the purposes it sought to attain could be accomplished without it by the old-fashioned system of "var. *a*," "var. *b*," and so on. The adoption of a system of names for forms lower than species he thought would lead to complete chaos.

Dr. Woodward, F.R.S., said he might mention two cases which occurred to him in which perhaps the system would be convenient. It was considered desirable by many palaeontologists that the group of Ammonites should be broken up into a number of genera, and he thought the present plan of erecting specific names into generic ones was inconvenient. The student was already hampered with too many names, and we ought to remember that students were harder worked now than they were twenty-five years ago. The system of cramming he considered deteriorating to the stamina of the future naturalist. Every time a group was broken up into genera, sub-genera, species, and sub-species, the labour of the student was increased. Therefore it appeared to him that the use of a third term following the generic and specific one, as proposed, was very convenient if not insisted on as a matter of instruction.

Mr. H. T. Wharton would prefer not to see other names introduced unless they were absolutely necessary. But when all-marked intermediate forms had to be dealt with he ad-

mitted the value of the trinomial system, but of course Dr. Coues knew that the method advocated by him was not new to naturalists, for trinomial names were to be found in botanical catalogues. He should be glad to know how it was proposed to deal with such a form as *Corvus cornix*, for example, which in the new edition of Yarrell's "British Birds" had been united with *Corvus corone*.

Mr. H. Saunders said he would like to direct attention to a practical point of the question. Most of those present were aware that there was an unpretending annual called the *Zoological Record*, which consisted now of about 800 pages, and that if trinomialism were adopted, it would make the volume of too great a size. He would also remind those present that Mr. Sharpe was the recorder of Aves, and he did not know how that gentleman would relish the additional labour which would be thrown upon him if this system were generally adopted.

Dr. Traquair said:—I think I quite understand the scope and limits of the system so ably advocated by Dr. Coues, but I feel convinced that were any such system to receive the authoritative sanction of naturalists, these limits would not be observed by the ordinary crowd of name manufacturers. My own studies in recent zoology have been more especially of an anatomical and morphological character, but in the subject of fossil ichthyology I have been brought face to face with the question of the definition and naming of species. Here I conceive that the "species" must include all those forms which can be indubitably shown to graduate into each other. For such species, the only idea of a species which seems to me practicable, one generic and one specific name are quite enough, and I would leave each author to deal with "sub-species" and varieties as he pleased, but without permitting him to apply any *authoritative* name to such. So great, in many cases, is the amount of variation observed in fossil fishes and fish remains, and so difficult is it also to arrive at safe conclusions as to specific identity or distinction with the material before us, that, were the proposed system of trinomial nomenclature to receive the authoritative sanction of naturalists, I am convinced that in this department the flood-gates would simply be opened for a deluge of new names, from people whose sole function in life seems to be to invent such on the most trifling pretext. If the binomial system is at present often abused by such people for the creation of "species" which have no existence, save in their own imaginations, what might we not expect them to do if the adoption of a trinomial system afforded them further scope for their faculties!

Mr. J. F. Harting said if he could be satisfied that the introduction of a system of trinomial nomenclature, as proposed, would be of any real benefit to science, he should have no hesitation in adopting it. But, so far from any advantage resulting from it, he feared that a positive disadvantage would accrue from its adoption in a way which had not been sufficiently considered. The tendency to describe as new species mere individual variations had already (with certain specialists at least) become very prevalent, and had led to an expression of regret and dissatisfaction amongst those who were content to take a broader view of things, and who regarded such a process of refining as tending to perplex, while in no way advancing science. All workers in zoology found themselves sooner or later in one of two classes, which had been named, expressively, if not elegantly, "lumpers" and "splitters." Now, if the proposed system of trinomial nomenclature were to be adopted, the former class would have either to surrender at discretion to the latter, or a wider gap than ever would be created between them, a result which would surely lead to great inconvenience; while the latter, who had already gone to great lengths in what he had termed the process of refining, would receive fresh encouragement to go to still greater lengths in that direction, to the disadvantage, as he conceived, of those who were to come after them. We had been told by the advocates of the trinomial system that it was impossible not to recognise climatic variations in any given species when they were found to be constant and well marked. In this he agreed: he only dissented from them in regard to the mode by which such recognition was to be effected. To say that the only mode of recognising such variations was to add a third name to the generic and specific names was begging the question. If any such variation as that alluded to was sufficiently well marked to distinguish it at once from the species of which it was said to be a variety, he would prefer to regard it as an allied species, and bestow on it a specific name, retaining a binomial nomenclature. The binomial system had been found to work well enough in practice, from its simplicity; and it was

surely simpler to write *Turdus propinquus* than *Turdus migratorius propinquus*. After all, nomenclature was not science, and even if we had the most perfect system of nomenclature which could be devised, he did not see how science would be thereby advanced. It is true we could not get on without nomenclature, but the simpler it was the better; and the less time we spent in discussing it the more we should have to devote to real study.

Dr Coues, replying to previous speakers, said that the system of trinomial nomenclature had nothing whatever to do with individual variations of specimens from one locality. It was not a question of naming varieties or hybrids, but there was a definite principle to proceed upon, namely, that of geographical and climatal variation. He was well aware that the use of three names to designate objects in zoology was no new thing; but he believed that the restricted application of trinomialism to the particular class of cases he had discussed was virtually novel, and that his system would prove to be one of great practical utility. He thought that the application of the principle was a question which, after this discussion, and after further private discussions, might well be left to the discretion of authors.

The Chairman concluded the meeting by saying:—I hope that Dr. Elliott Coues is satisfied with the manner with which his views have been received. Although there are some unpromising binomialists present, many have pronounced themselves as what may be termed limited trinomialists, and some appear to go as far as Dr. Coues himself. Distinctly defined species undoubtedly exist in great numbers, owing to extinction of intermediate forms; for these the binomial system offers all that is needed in defining them. But on the other hand there are numbers of cases in the actual state of the earth, and far more are being constantly revealed by the discoveries of palaeontology, and nowhere so rapidly as in Dr. Coues' own country, where the infinite gradations defy the discrimination either of a binomial or a trinomial system. Zoologists engaged in the question of nomenclature are being gradually brought face to face with an enormous difficulty in consequence of the discovery of these intermediate forms, and some far more radical change than that now proposed will have to be considered. In conclusion I must express the thanks of the meeting to Dr. Coues for having brought his views and those of his countrymen, of whom he is such a worthy representative, before us, and also to Mr. Bowdler Sharpe, to whose zeal and energy the organisation of the meeting is entirely due.

A unanimous vote of thanks was given to Prof. Flower for presiding.

### KRAKATOA

AT the meeting of the Meteorological Society of Mauritius on May 22 some interesting communications were made relating to the Krakatoa eruption. Among others was a letter from M. Lecomte regarding detonations heard at Diego Garcia on August 27. In his letter, which was written at Diego Garcia on April 24, M. Lecomte says:—"Le lundi 27 août entre 10 et 11 heures du matin, pendant le déjeuner, nous avons entendu des détonations sourdes mais violentes. Nous avons cru tellement à l'appel d'un navire en détresse que nous avons couru et que j'ai envoyé plusieurs hommes vers le rivage extérieur de l'île sur plusieurs points différents, en observation. Le Capitaine Florentin de l'*Eva Joshua* et son second, M. Daniel Sauvage, venaient de quitter Pointe de l'Est pour aller mouiller à Pointe Marianne, lorsqu'ils ont entendu les mêmes détonations. Ils ont aussitôt envoyé des hommes en observation à l'extrémité des mâts. Mais comme les miens ils n'ont rien vu.

"Ce jour là et les jours suivants le soleil était comme obscurci, probablement par la formidable quantité de vapeurs et de cendres qui ont du s'élever dans l'atmosphère."

The information obligingly furnished by M. Lecomte was valuable, inasmuch as, taken in conjunction with the reports which had been received from Rodrigues, it confirmed verbal information which had been previously obtained. There could now be no doubt that the explosions which took place at Krakatoa were distinctly heard both at Diego Garcia and Rodrigues, and there was probably no other recorded instance of sound having travelled over so great a distance. The fact, also, that at Diego Garcia the sun was partially obscured on August 27 and on several subsequent days, as well as at the Seychelles and Rodrigues, was an additional proof of the great quantity of

matter which must have been ejected from Krakatoa, and of the rapidity with which it was conveyed from its source. There could be no reasonable doubt that the presence of that matter in the atmosphere was the cause of at least the lurid sunsets and sunrises which were observed over the Indian Ocean on the last days of August and in the first week of September.

The Secretary, Dr. Meldrum, stated that the Royal Society of London had appointed a Committee to collect information regarding the phenomena which had been observed during and after the volcanic eruptions that took place at Krakatoa in August, and requests had been received from that and other quarters for information from Mauritius. To these requests the Secretary had replied that he was preparing for his Excellency the Governor a detailed account of what had been observed at Mauritius and several of its dependencies, but that owing to the almost daily reception of additional details his report was not yet ready. All he did, therefore, was to give the general results as far as they had been determined.

Several remarkable phenomena had to be described. In the first place, there were disturbances of the sea water, or, as they had been called by some, tidal disturbances, and these had been observed all over the Indian Ocean.

There were also barometric disturbances, to which attention had first of all been called in Mauritius early in September, and which at the time were ascribed to the explosions at Krakatoa. Some time afterwards it was ascertained in England that these disturbances had extended over the whole globe and that they were recorded by all self-registering barometers in both hemispheres. At Mauritius there were at least seven well-marked disturbances of which the epochs of *maximum intensity* were as follows:—

	h.	m.	
(1) August 27,	0.6		p.m. local time.
(2) " 28,	2.20		p.m. " "
(3) " 28,	10.40		p.m. " "
(4) " 30,	1.35		a.m. " "
(5) " 30,	9.17		a.m. " "
(6) " 31,	1.48		p.m. " "
(7) " 31,	8.00		p.m. " "

At first these disturbances were supposed in Mauritius to have been due to successive eruptions, but General Strachey, who examined a number of barographs received from different parts of the world, had recently adduced evidence to show that they were produced by an air-wave proceeding outwards from Krakatoa in all directions round the earth, expanding till it was half round, then contracting till it reached the antipodes of its origin, and afterwards returning, the wave thus travelling round the globe two or three times. Assuming that view, the first disturbance at Mauritius (which was at its maximum at oh. 6m. p.m. on the 27th) would be caused by the passage over the Observatory of the wave travelling from east to west; and the third, fifth, and seventh disturbances would be returns of the wave to Mauritius after having gone round the earth. Similarly the second disturbance would be the first passage of the wave travelling from Krakatoa eastward, and the fourth and sixth would be its returns to Mauritius. Now, the mean interval in time between the returns of the wave to Mauritius, in its passage from east to west, was 24h. 38m., and in its passage from west to east 35h. 44m. It would thus appear that the rate of progression had been greater from east to west than from west to east, which may have been partly or wholly due to the great circle passing through Krakatoa and Mauritius being within the tropics, where the prevailing wind was from the eastward. The rate of progression from east to west was very nearly 709 miles an hour, and from west to east 697 miles. By taking as nearly as possible the times half way between the commencements and endings of the disturbances similar results were obtained. There was also an *eighth* (but small) disturbance between 7 and 9 a.m. on September 2, which may have been the fourth return of the wave from east to west, the interval in time between that disturbance and the seventh having been nearly thirty-six hours. The sixth disturbance was the last indication of the wave in its passage from west to east.

Another effect of the Krakatoa eruptions was the spread of ashes and pumice over considerable portions of the Indian Ocean, and a good deal of information on that point also had been collected in Mauritius. The first intimation of the probability of volcanic action in the direction of the Straits of Sunda was contained in a letter published by Capt. Walker, of the *Acta* in the *Mercantile Record* of June 16, 1883. At noon on



May 20 the *Actæa* was in  $6^{\circ} 50' S.$  and  $104^{\circ} 2' E.$ , and on the morning of that day a "peculiar light green colour" was observed in the sky to the east-south-east, while "from east to east-north-east there was a dark blue cloud, which reached from the horizon to the zenith." "About 2 p.m. it was quite dark. What appeared to be a rain squall rose up from the east, but, instead of rain, a kind of very fine dust commenced to fall, and very soon everything was covered; ships, sails, rigging and men were all dust colour; nothing could be seen 100 yards off. The fall continued steadily all night, and stopped about 9 a.m. on Monday the 21st. When we saw the sun it looked like dull silver. At noon we were in lat.  $8^{\circ} 15' S.$  and long.  $102^{\circ} 28' E.$ , distant from Java Heads about 170 miles. The sky all round remained a dusty hue, and small quantities of dust again fell during the night. The sky did not assume a natural appearance till the 23rd." At a meeting of this Society held on July 12, the Secretary called attention to Capt. Walker's letter, and said there was little doubt that the dust in question had come from Krakatoa, as, according to a note in NATURE of June 7, a volcano in that island was in full eruption. From that time accounts of pumice and ashes observed in the Indian Ocean had been extracted from log-books, and they showed that on several occasions vessels had passed through fields of pumice long before the great eruptions of August 26 and 27. After that month the reports became more frequent, and they still continued, the latest being from the vicinity and shores of Mauritius, where, since the middle of February, large quantities of pumice had been seen. It would appear, however, that fields of pumice had passed Mauritius long before February, for "a large quantity of pumice-stone and lava was washed up on the beach at Durban (Natal) on October 23." According to the reports received, fields or lanes of pumice had been observed in different parts of the Ocean from  $105^{\circ}$  to  $48^{\circ} E.$  and  $6^{\circ}$  to  $12^{\circ} S.$  Farther south the extent in longitude had been apparently less.

That the remarkable sunrises and sunsets which had been observed over a great part of the world after August 27 were due to matter ejected from Krakatoa seemed to be generally admitted. The few who objected to the volcanic dust theory had not proposed any other theory that so completely accounted for the facts. The presence of vapours and finely-divided dust at certain elevations would, as a consequence of known physical laws, produce all the chromatic effects that had been seen and described, and it was known that immense quantities of matter had been shot up from Krakatoa. Similar phenomena had been witnessed by observers between whom and the sun volcanic dust passed, as on the occasion of an eruption of Cotopaxi a few years ago. But it was not necessary to go so far back. From May 20 to 22 last, after an eruption of Krakatoa, Captain Walker, as already stated, observed that to the east-south-east the sky was of a light green colour, that on the 21st the sun looked like dull silver, that the sky all round was of a dusty hue, and that it did not assume its natural appearance till the 23rd. That was perhaps the earliest instance of the chromatic effects of the Krakatoa dust and vapours. Immediately after the eruptions of August 27 they were more intense and on a greater scale. At the Seychelles on the 27th the sky, according to Mr. Estridge, was hazy all day. The sunset on that day was gorgeous; the sky was lurid all over, and beams of red light stretched from over St. Anne's to nearly the horizon. At sunset on the 28th the sun looked as it did through a fog on a frosty day in England. On the morning of the 29th the sun at 7 a.m. was more like a full moon than anything else. According to other letters from the Seychelles the sun for a whole week appeared dim. At Rodrigues, according to Mr. Wallis, whose report was written on August 31, the sky at north-west on every evening since the 27th had a very threatening and strange appearance of a deep purplish red colour, which lasted till 7.15 p.m., and which, with the disturbances of the sea water, caused much fear and excitement. Similar phenomena were observed on the same evenings at Diego Garcia and St. Brandon, and for several days the sun looked as if partially obscured. At Mauritius the sky was overcast throughout the whole of the 27th, and it was observed and noted at the time that there was an unusual dimness. On the evening of the 28th there was a gorgeous sunset, the first of a long series of remarkable colorations and glows, which had already been described. Observations of these optical phenomena had been taken daily during nearly the last nine months whenever the weather permitted. Knowing what had been observed on board of the *Actæa*, and that Krakatoa had been in eruption,

these extraordinary sunsets and sunrises were attributed to the presence in the upper strata of the air of finely-divided matter, and probably gases and vapours, from Krakatoa, and subsequent events confirmed that opinion. It was difficult to explain phenomena which had been identical under all conditions of weather, and in many distant places, by any purely meteorological causes. To the meteoric dust theory it might be objected that it was purely an hypothesis almost, if not wholly, unsupported by facts. No unusual number of meteors had been seen. No extraordinary glows had been observed at or near the times of the great meteoric showers of November 1866, and November 1872. Moreover one would suppose that if the earth had for months been passing through volumes of meteoric dust the chromatic effects would have appeared simultaneously wherever the sun rose and set. But such had not been the case. Upon the whole there seemed to be a preponderance of evidence in favour of the volcanic dust theory. The objection that the quantity of matter was insufficient was not a formidable one, for the effects did not depend merely upon the quantity of matter that had reached the higher regions, but also upon its form and degree of tenuity. A few pounds of matter might be spread over thousands of square miles. As to the objection that it was difficult to conceive how even finely-divided matter could remain so long in suspension, it might be remarked that, independently of the possibility of the particles being electrified, the lower strata of the atmosphere might be denser than the foreign matter in the upper strata. The extraordinary sunsets and sunrises which were observed in 1783-84, and which Arago and others ascribed to volcanic dust, were said to have lasted eleven months. Those of 1883-84 would probably last fully as long. Within the last few weeks there had been at Mauritius a considerable increase in the intensity and duration of the glows.

#### EVIDENCES OF THE EXISTENCE OF LIGHT AT GREAT DEPTHS IN THE SEA<sup>1</sup>

THE evidences of the presence of light and its quality and source at great depths are of much interest. At present very little experimental knowledge in regard to these questions is available. That light of some kind, and in considerable amount, actually exists at depths below 2000 fathoms, may be regarded as certain. This is shown by the presence of well-developed eyes in most of the fishes, all of the cephalopods, most of the decapod Crustacea, and in some species of other groups. In many of these animals, living in 2000 to 3000 fathoms, and even deeper than that, the eyes are relatively larger than in the allied shallow-water species; in others the eyes differ little, if any, in size and appearance, from the eyes of corresponding shallow-water forms; in certain other cases, especially among the lower tribes, the eyes are either rudimentary or wanting in groups of which the shallow-water representatives have eyes of some sort. This last condition is notable among the deep-water gastropods, which are mostly blind; but many of these are probably burrowing species; and it may be that the prevalent extreme softness of the ooze of the bottom, and the general burrowing habits, are connected directly with the habits or rudimentary condition of the eyes in many species belonging to different classes, including Crustacea and fishes. Such blind species usually have highly developed tactile organs to compensate for lack of vision.

Other important facts bearing directly, not only on the existence, but on the quality, of the light, are those connected with the coloration of the deep-sea species. In general, it may be said that a large proportion of the deep-sea animals are highly coloured, and that their colours are certainly protective. Certain species, belonging to different groups, have pale colours, or are translucent, while many agree in colour with the mud and ooze of the bottom; but some, especially among the fishes, are very dark, or even almost black; most of these are probably instances of adaptations for protection from enemies, or concealment from prey. But more striking instances are to be found among the numerous brightly-coloured species belonging to the echinoderms, decapod Crustacea, cephalopods, annelids, and Anthozoa. In all these groups, species occur which are as highly coloured as their shallow-water allies, or even more so. But it is remarkable that in the deep-sea animals the bright colours are almost always shades of orange and orange-red, occasionally brownish red,

<sup>1</sup> From a paper in *Science*, July 4, on "Results of Dredgings in the Gulf Stream Region by the U. S. Fish Commission."

purple, and purplish red. Clear yellow, and all shades of green and blue colours, are rarely, if ever, met with. These facts indicate that the deep sea is illuminated only by the sea-green sunlight that has passed through a vast stratum of water, and therefore lost all the red and orange rays by absorption. The transmitted rays of light could not be reflected by the animals referred to, and therefore they would be rendered invisible. Their bright colours can only become visible when they are brought up into the white sunlight. These bright colours are therefore just as much protective as the dull and black colours of other species.

The deep-sea star-fishes are nearly all orange, orange-red, or scarlet, even down to three thousand fathoms. The larger ophiurans are generally orange, orange-yellow, or yellowish white, the burrowing forms being usually whitish or mud-coloured, while the numerous species that live clinging to the branches of gorgonians and to the stems of Pennatulacea are generally orange, scarlet, or red, like the corals to which they cling. Among such species are *Astrochele lymani*, abundant on the bushy orange gorgonian coral, *Acanella normani*, often in company with several other orange ophiurans belonging to *Ophiacantha*, &c. *Astronyx loveni* and other species are common on Pennatulacea, and agree very perfectly in colour with them. These, and numerous others that might be named, are instances of the special adaptations of colours and habits of commensals for the benefit of one or both. Many of the large and very abundant Actiniae, or sea-anemones, are bright orange, red, scarlet, or rosy in their colours, and are often elegantly varied and striped, quite as brilliantly as the shallow-water forms; and the same is true of the large and elegant cup-corals, *Flabellum godesi*, *F. angulare*, and *Caryophyllia communis*,—all of which are strictly deep-sea species, and have bright orange and red animals when living. The gorgonian corals of many species, and the numerous sea-pens and sea-feathers (Pennatulacea), which are large and abundant in the deep sea, are nearly all bright coloured when living, and either orange or red. All these Anthozoa are furnished with powerful stinging organs for offence and defence; so that their colours cannot well be for mere protection against enemies, for even the most ravenous fishes seldom disturb them. It is probable, therefore, that their invisible colours may be of use by concealing them from their prey, which must actually come in contact with these nearly stationary animals in order to be caught. But there is a large species of scale-covered annelid (*Polynoe aurantiaca*, Verr.) which lives habitually as a commensal on *Bolocera tuedia*, a very large orange or red actinian, with unusually powerful stinging organs. Doubtless the worm finds, on this account, perfect protection against fishes and other enemies. This annelid is of the same intense orange colour as its actinian host. Such a colour is very unusual among annelids of this group, and in this case we must regard it as evidently protective and adaptive in a very complex manner.

It has been urged by several writers, that the light in the deep sea is derived from the phosphorescence of the animals themselves. It is true that many of the deep-sea Anthozoa, hydroïds, ophiurans, and fishes are phosphorescent; and very likely this property is possessed by members of other groups in which it has not been observed. But, so far as known, phosphorescence is chiefly developed in consequence of nervous excitement or irritation, and is evidently chiefly of use as a means of defence against enemies. It is possessed by so many Anthozoa and acalephs which have, at the same time, stinging organs, that it would seem as if fishes had learned to instinctively avoid all phosphorescent animals. Consequently it has become possible for animals otherwise defenceless to obtain protection by acquiring this property. It is well known to fishermen that fishes avoid nets, and cannot be caught in them, if phosphorescent jelly-fishes become entangled in the meshes; therefore it can hardly be possible that there can be an amount of phosphorescent light, regularly and constantly evolved by the few deep-sea animals having this power, sufficient to cause any general illumination, or powerful enough to have influenced, over the whole ocean, the evolution of complex eyes, brilliant and complex protective colours, and complex commensal adaptations.

It seems to me probable that more or less sunlight does actually penetrate to the greatest depths of the ocean in the form of a soft sea-green light, perhaps at two thousand to three thousand fathoms equal in intensity to our partially moonlight nights, and possibly at the greatest depths equal only to starlight. It must be remembered that in the deep sea, far from land, the water is far more transparent than near the coast.

A. E. VERRILL

## ARTIFICIAL LIGHTING<sup>1</sup>

IN early times but a small fraction of our forefathers' lives was spent under artificial light. They rose with the sun and lay down to rest shortly after sunset. During the long winter evenings they sat round the fire telling stories and singing songs of love and war; the fire-light was sufficient for them, except occasionally during grand feasts and carousals, when their halls were lighted by pine-wood torches or blazing cressets. But, as a rule, after sunset they lived in semi-darkness.

From that early period, as man has advanced in civilisation, in the thirst for knowledge derived from books, and in following the gentler pursuits which demand an indoor life, there has been a steady increase in that fraction of our lives which is spent under light other than that of the sun. But the improvement in the quality of the artificial light has been very slow. The ruddy lights and picturesque shadows so faithfully handed on to us by Rembrandt's pictures show us very graphically what our poets have called "the dim glimmer of the taper" of those days. A few years before the introduction of gas, Argand, by his improvements in the burners of oil lamps, enabled our fathers to see for the first time a comparatively white light, but as far as the matter we to-day propose to discuss is concerned, viz. the effect of artificial lighting, and more particularly electric lighting, on our health, we need only consider the reign of artificial light as it commenced with the general use of gas and petroleum, for then and only then could it be said to affect our health.

Prior to the introduction of the electric light we have been accustomed to consider every hour spent under artificial light as an hour during which all conditions are less favourable to perfect health than they would be during daylight. Can we now hope to ameliorate this condition of things through the agency of electricity? Before we can discuss this question I must point out to you the chief differences which exist between hours of work or recreation spent in daylight and under artificial light. In the former case we live in abundance of light. The sunlight itself exercises a subtle influence on our bodies; that mixture of heating and chemical rays which when analysed form the solar spectrum, and combined form the pure white light of daylight, is needed to enable all animal and vegetable organisms to flourish in the fullest conditions of healthful life.

In nearly all cases when the sun is up, the functions of life are in the state of fullest activity, and when it sets they sink into comparative repose. In daylight life wakes, in darkness life sleeps. In addition to the abundance of pure white light, the heat attending is only that necessary for health. The air remains unvitiated, except by our own breathing. On the other hand, when working under artificial light, we have these conditions all altered in degree:

1. We have an insufficient light; a scale of lighting by gas or by electricity which would be pronounced excessive at night-time is still far inferior to average daylight.

2. All artificial lights, whether produced by combustion, as in the case of candles, oil, gas, and petroleum, or by the incandescence of a conductor by the means of electricity, produce heat; this heat, in proportion with the light afforded, is enormously in excess of the heat given by sunlight. Electricity, as you will see hereafter, is far the best in this respect, but even it is inferior to sunlight.

3. All these same illuminants, excepting electricity, contaminate the air and load it with carbonic acid, sulphur, and other compounds—all injurious to the health and to the general comfort of the body. It will be convenient to consider the effects—first, on our health generally; second, on our eyesight in particular. I have already called your attention to the fact that that proportion of coloured rays which, when combined, form white sunlight, is that best suited to healthy life. It is necessary too to that sufficient and proper stimulus to the organic changes which go on in our bodies, and which we call a state of good health. The various artificial lights differ very widely from sunlight in this respect, that they are all more or less deficient in the rays at the violet end of the spectrum, commonly called the actinic rays, and which most probably exercise a very powerful effect on the system. It is the want of a due portion of these violet rays which makes all artificial light so yellow. Even the light of the electric arc, which is richer in these rays than any other, is still on the yellow side of sunlight. The incandescent electric light is next best in this respect; next in order come gas, petroleum, and the various oil lamps. No doubt some of you will

<sup>1</sup> Lecture delivered at the Health Exhibition by Mr. R. E. B. Crompton

challenge my statement that the electric arc is yellow. It has always been called a cold blue light. It is not so; it is only by comparison with the yellower light of gas or with the incandescent lamps that it appears blue; when compared with the sunlight reflected from a white cloud it will be seen to be distinctly yellow in tinge; but still both classes of electric light are far superior to all others in nearest approaching the white light of daylight, and thus satisfying the actinic action which our bodies demand.

Turning now to the comparative heating and air-vitiating properties of artificial lights which we shall find it convenient to take together, I have here a table (Table A) prepared by Dr.

TABLE A.—Showing the Oxygen consumed, the Carbonic Acid produced, and the Air vitiated, by the Combustion of certain Bodies burnt so as to give the Light of 12 Standard Sperm Candles, each Candle burning at the rate of 120 grains per hour

Burnt to give light of 12 candles, equal to 120 grains per hour	Cubic feet of oxygen consumed	Cubic feet of air consumed	Cubic feet of carbonic acid produced	Cubic feet of air	Heat produced in lbs. of water raised to F.
Cannel Gas ....	3'30	16'50	2'01	217'50	195'0
Common Gas..	5'45	17'25	3'21	348'25	278'6
Sperm Oil.....	4'75	23'75	3'33	356'75	233'5
Benzole .....	4'46	22'30	3'54	376'30	232'6
Paraffin .....	6'81	34'05	4'50	484'05	361'9
Camphine .....	6'65	33'25	4'77	510'25	325'1
Sperm Candles	7'57	37'85	5'77	614'85	351'7
Wax.	8'41	42'05	5'90	632'25	383'1
Stearic.....	8'82	44'10	6'25	669'10	374'7
Tallow.....	12'00	60'00	8'73	933'00	505'4
Electric Light.			none	none	13'8

Meymott Tidy, which shows the oxygen consumed, the carbonic acid produced, the air vitiated, and the heat produced by the combustion of certain bodies burned so as to give the light of twelve standard candles, to which Mr. R. Hammond has added the heat produced by a 12-candle incandescent electric lamp. From these figures you will see that the air of a room lighted by gas is heated twenty times as much as if it were lighted to an equal extent by incandescent electric lamps. When arc lamps are used, the comparison is still more in favour of electricity. You will be surprised to see from the table that our old friend the tallow candle, and even the wax candle, is far worse than gas in the proportion of air vitiated and heat produced, and you will be disposed to disbelieve it; but the fact is, that so long as candles were used light was so expensive that we were obliged to be content with little of it; in fact we lived in a state of semi-darkness, and in this way we evaded the trouble. It is only since the general introduction of gas and petroleum that we have found what an evil it is.

It is not unusual, in fact it is almost invariable, for us to find the upper stratum of air of the rooms in which we live heated to 120° after the gas has been lighted for a few hours. We have grown accustomed to this state of things, and are not surprised that when we take the library ladder to get a book from the upper shelf we find our head and shoulders plunged into a temperature like that of a furnace, producing giddiness and general malaise. If you look again at the table you will see that each gas burner that we use consumes more oxygen and gives off more carbonic acid, and otherwise unfits more air for breathing, than one human being, and it is this excessive heating and air vitiation combined which are the main causes of the injury to the health from working long hours in artificial light. I could go on for a long time giving instances of the fearful state of the atmosphere of our large public buildings as well as of our private homes after the gas has been lighted for a few hours, but this paper is not intended as an onslaught on gas; moreover these ills are so well known to nearly all of you that I need not bring them more prominently before you. I will only take one instance, viz. that of the Birmingham Town Hall, which has been lighted alternately by gas and electricity.

During the grand Birmingham Musical Festival, which was held in that hall two years ago, some careful experiments were

made to show how the orchestra and audience in the hall were affected by the two kinds of lighting. The gas lighting was in the form of several huge pendants suspended down the centre of the hall. The electric lighting was in the form of clusters of lights placed on large brackets projecting from the side walls with two central pendants placed between the gas pendants. The candle-power given by the electric light was about 50 per cent. in excess of that given by the gas light; the degree of illumination by electricity was consequently very brilliant.

It was found that when the gas was used the temperature near the ceiling rose from 60° to 100° after three hours' lighting. The heating effect of the gas was, therefore, the same as if 4230 persons had been added to the full audience and orchestra of 3100. Similarly the vitiation of the air by carbonic acid was equal to that given off by the breathing of 3600 additional persons added to the above audience of 3100. But on evenings when the electric light was used the temperature only rose 1½° during a seven hours' trial, and the air, of course, was only vitiated by the breathing of the audience. The further experiment was tried of giving to every member composing the large orchestra a printed paper of questions asking how the new mode of lighting affected him or her personally, and I have here 265 replies to those questions. They are very interesting. I will read a very few of them out to you. From this you will learn that without exception the comfort and general well-being of this large orchestra was increased enormously by the use of the new illuminant, yet it is reasonable to suppose that the comfort of the audience was increased in an equal degree. Now we all of us know that the times when we suffer most from the effect of artificial light is in crowded places of public amusement, which are at the same time brilliantly lighted. Many of us are unable to go to the theatre or to attend evening performances of any kind, as the intense headache which invariably attends through staying a single hour in such places entirely prevents them. This headache we commonly say is inseparable from the heat and glare of the gas. Now this phrase is not strictly correct. It is no doubt due to the heat of the gas and its air-vitiating properties, but when we use the word glare I believe we refer to the effect the gaslight has upon our heads, and which effect is not due to excess of light. On the contrary, I believe if a far greater amount of light be given by the electric light without the heating and air vitiation being present such headache is never produced, although some of the more tender-headed amongst us will at first complain of the glare because they are habituated to associate plenty of light with great heat, great air vitiation, and other evils.

Indeed, so long have we been accustomed to closely associate brilliant artificial light with headache and glare, that we who are introducing electric light are most cautious not to give the full quantity of light which we could afford to give, and which would afford the greatest rest to the eye and greatest bodily comfort. I now come to the effect that light has upon the temperament. If we try the experiment in an assemblage of people of gently decreasing the lighting of the room, it will be found that the spirits of every one will be depressed just as the light is depressed, and, *vice versa*, their spirits will be raised just as the light is raised. I have many times, when conducting experiments of electric lighting on a large scale, noticed this fact, and I have been led to the conclusion that during hours of waking every person is benefited by increase of light up to the extent of full sunlight, providing that this high degree of lighting is not attended by heat and by air vitiation; and I must add that the source of light must not be from one or two brilliant points only, but it must be well regulated and not such as to cause dark, deep shadows.

This leads me on to the subject of the effects on the eyesight of the electric light as compared with other lights. *Healthy eyesight demands a plentiful supply of light. It is the greatest mistake to suppose that a state of semi-darkness is good for our eyes, unless they are defective, or recovering from the effects of past injury or disease.* Whoever saw a painter, engraver, printer, watchmaker, or indeed any one the quality of whose work depends on the excellence of his eyesight, who did not desire a flood of pure white light thrown on to his work. I think I have the authority of oculists when I say that 10-20ths of the diseases of the eyes arise from working the eyesight long hours with insufficient light. Again, another great cause of injury to eyesight is the unsteadiness of most artificial lights. Much improvement has been made in the light of gas during the

last few years by the introduction of argand burners, and globes for the flat gas burners having much larger lower openings, so that the dancing and flickering batwing burner of five years ago is not so common in a good house. Even the steadiest of the modern gas burners is extremely unsteady as compared with the light of the incandescent electric lamp. Those of you who have been to the Savoy Theatre will have noticed the effects of the lights behind the scenes on the scenery itself. The light is so absolutely steady that it is comparable to sunlight. Hitherto I have said nothing as to the comparative excellence of the two forms of electric light, viz. the electric arc and the incandescent lamp. Both have their proper places. The arc light, which is the whitest in colour and most economical to produce, is not so steady as the incandescent lamp. It is therefore unsuitable for indoor use or for reading by, or for such occupations as require the maximum of steadiness. But it is well suited for the lighting of large buildings and public places. I am unaware if any experiments have been made as to the effects of brilliant arc lighting on the eyesight of men who have to work night shifts, as although the opinion of the workmen who have to work under it is unanimous in its favour, yet that opinion is more based on their personal comfort, due to their being able to carry on their work with facility almost equal to that given by daylight. The large sorting rooms at the General Post Office at Glasgow have been for a long time lighted by the arc light, and with a most beneficial result to the health and eyesight of the letter-sorters and telegraph clerks. The former occupation is one which tries the eyesight very severely. The public generally does not know how the habit of writing the addresses on envelopes with pale ink and blotting it off rapidly before it has time to darken tries the eyesight of the Post Office letter-sorters. So long as gas is used, a powerful burner has to be brought very close to the head of the sorter, and under such conditions the eyesight fails at an early age. At Glasgow Post Office I am able to boast that by the introduction of the electric light I enabled many of the more aged sorters who were commencing to use spectacles to do without them—and even I put back the clock of time in enabling several who had used them for some years to disclaim them. I am aware that it has been alleged by the opponents of the electric light, whether interested or otherwise, that in many cases the intensity of the light has injured eyesight. I do not think any such cases can be substantiated. Many of us who are in the habit of experimenting with powerful arc lamps have had our eyelids temporarily affected by incautious exposure at too short a distance. Again, over and over I meet with the complaint that if I stare at an arc lamp for a long time it will make my eyes ache; the obvious retort being, Why should you stare at the light? If you do the same with the sun, you will be equally inconvenienced. Before such an audience as this, which is of course familiar with the beautiful electric lighting in the Health Exhibition itself, it is useless for me to enlarge on the many conditions of the electric light as it indirectly affects health. I may only name the many additional pleasures of the eye we get from its use. Our flowers in our rooms do not fade away, and are seen in their true colours. Our pictures or all coloured objects are seen to better advantage. I may mention one thing which would not generally occur to you, that in London certainly an electric-lighted house can be cleaned properly in winter. You may smile at this, but I assure you that the advantage of being able to turn a flood of light into your drawing-rooms and dining-rooms at six o'clock on a winter's morning, so that the whole of the cleaning can be finished as thoroughly as if done by daylight, before the family comes down to breakfast, is one that must be experienced before it can be thoroughly appreciated. Again, the advantage to the health of our children is simply inestimable. No night-lights, matches left about, or gas turned down low are required. A child six years old can be trusted to press a button and so turn the light off or on; the lamps being high and out of reach are not easily broken or over-turned, and the air of the children's nursery, even if the light be kept burning the night through, remains pure throughout. Another indirect advantage due to the absence of heat is that it is comparatively easy to thoroughly ventilate and cool during the hot weather a room lighted by the electric light. The heat of gas placed high in the room causes such intense draughts when the windows are open that the discomforts and dangers of the draughts are almost worse than the discomfort from the heat and vitiated air, whereas in an electric-lighted room there is no difficulty in opening wide all the windows, the draughts produced being so gentle as to be hardly felt.

## SOCIETIES AND ACADEMIES

LONDON

**Physical Society, June 28.**—Prof. Guthrie, President, in the chair.—New Member, Mr. W. H. Hensley.—Lord Rayleigh made a communication on the practical use of the silver voltmeter for the measurement of an electric current. On a former meeting of the Society the method was explained by the author, but on the present occasion the apparatus was exhibited. The author considers this the best method of determining the strength of current in absolute measure. One ampere deposits 4 grammes of silver in an hour; therefore a quarter to half an hour is sufficient to give 1 or 2 grammes, quantities which can be measured with accuracy. Any current from 1/10 to 4 or 5 amperes can be measured successfully in this way. With very weak currents there is a difficulty in weighing the deposits; with very dense currents the deposit is apt to be irregular. The author deprecates the use of acetate of silver, pure nitrate or pure chlorate of silver giving the best results. The cathode of his apparatus is a platinum bowl, the anode a silver sheet wrapped with clean filter paper sealed over it to keep any loose silver from dropping on the cathode. The anode is immersed in the solution of silver salt; and at the end of several hours (if great accuracy is required) a measurement of the weight of silver deposited is made by weighing the bowl cathode in a chemical balance. Dr. Fleming inquired whether it was not better to weigh the loss of weight suffered by the anode, as is sometimes done. Lord Rayleigh had not found this plan so good, the anode being apt to disintegrate and lose weight, not by true electrolytic action. Prof. Guthrie remarked that with small electrodes peroxide of silver is formed, and that the inferiority of acetate of silver might be due to formation of subacetate.—Lord Rayleigh then made a communication on a colour-mixing apparatus founded on refraction. This apparatus had been described at a former meeting of the British Association, and consists of a double-refracting prism, a lens, dispersing prism, and screen, by which an overlapping of spectra can be obtained, and thus a mixture of colours. In comparing different eyesights with it Lord Rayleigh finds that the majority of persons are more sensitive to red than he himself. In answer to Mr. W. Baily he had not observed any difference between the two eyes of the same person, except what might be due to fatigue and freshness. Dr. Guthrie inquired if the author had discovered any racial characteristics of colour-blindness. Lord Rayleigh had not observed any so far. Dr. Guthrie stated that, though colour-blind to red, he believed he was more than usually sensitive to blue. Dr. Stone and Mr. Stanley referred to known cases of blindness to green, as well as red. Dr. Lodge asked if persons abnormally sensitive to red could see further down the spectrum. Lord Rayleigh believed they could see the spectrum brighter near its limits at all events. Mr. Glazebrook briefly described a modification of Lord Rayleigh's apparatus by which the distance on the spectrum which any one can see could be measured.—Mr. C. V. Boys read a paper on a phenomenon of electromagnetic induction. Between the poles of an electro-magnet a small disk of copper is hung by a bifilar suspension. If the magnetic field is uniform, and the disk at an angle to the lines of force, then on making the magnet it is jerked parallel with the lines of force. If it is a changing field, and the disk perpendicular to the lines of force, it is repelled on making the magnet and attracted on breaking by the nearest pole. This phenomenon, which was observed by Faraday, was shown by Mr. Boys to be useful for determining the intensity of a magnetic field by measuring the throw of the disk on magnetising and demagnetising. It might also be employed to measure the resistance of bodies in the form of plates, from their diameter, moment of inertia, and observed throw. Any structural difference of resistance in different directions in the body might be determined by its means. Mr. Boys illustrated his remarks with curves of results obtained by experiment. Lord Rayleigh considered that the effect of self-induction on the results was not likely to be serious.—Mr. J. Hopps read a paper on the alteration of electrical resistance in metal wires produced by coiling and uncoiling. His experiments were made with an inclined plane, the angle of which could be varied, and a car, carrying bobbins, which was drawn up or let down the plane by the wires experimented on. It appeared that coiling and uncoiling tends to produce hardness in a wire. Coiling produces an increase of resistance, and uncoiling a decrease in the resistance of a wire.—Mr. R. T. Glazebrook, M.A., F.R.S., read a paper on the determination

in absolute measure of the electrical capacity of a condenser, and on a method of finding by electrical observations the period of a tuning-fork. The paper described experiments conducted according to a method given in "Maxwell," vol. ii. § 776, for measuring the capacity of a condenser. Mr. J. J. Thomson showed (*Philosophical Transactions*, 1883, part iii.) that Maxwell's formula is only approximate, and gave the correct formula, which was used in the author's experiments. In these tuning-forks were used of frequencies approximately 16, 32, 64, and 128 to a second, the frequencies being determined by careful comparison with the clock by Lord Rayleigh's method, and the corresponding values found for the capacity were '3336 m.f., '3340 m.f., '3335 m.f., '3337 m.f. The mean is '3337 m.f., and the experiments do not show any variation in the capacity, as the time of changing varies from 1/16 to 1/128 of a second. The condenser was furnished by Messrs. Latimer Clark, Muirhead, and Co. The method also gives a ready and accurate means of determining the pitch of a tuning-fork, for if the capacity of the condenser used is known the frequency ( $n$ ) can be determined. The author has used the method successfully for this purpose. Lord Rayleigh objected to mercury contacts in such experiments; and Dr. Stone said he had found iron and mercury contacts good.—Prof. Herbert Macleod exhibited a sunshine recorder made by placing a water lens in front of a camera box and lens. Sensitised paper is placed in the bottom of the box so that the focused ray strikes on it, and as the sun moves traces a curved line or band on the paper. Several of these records were shown to the meeting.

**Royal Microscopical Society, June 11.**—Rev. W. H. Dallinger, F.R.S., President, in the chair.—Prof. Zenger's method of constructing endomersion objectives by using a mixture of ethereal and fatty oils for correcting chromatic aberration was explained and an objective exhibited.—Dr. Wallich exhibited a new condenser which he had devised.—Mr. J. Mayall, jun., exhibited and described his method of applying amplifiers to a microscope, by which a considerable range of magnifying power and working distance was obtained.—Mr. C. Beck exhibited and described a new form of microscope lamp for use in various pathological and physiological investigations.—Notes were read on human spermatozoa with two tails (Mr. Hazlewood), on the potato-blight insect (Mr. Brennan), and on a *Spirochete* of unusual form (Mr. Cheshire).—Dr. Anthony read a paper on drawing prisms, on which a long and interesting discussion took place.—Mr. Dowdswell read a paper on some appearances in the blood of vertebrate animals with reference to the occurrence of bacteria therein; Mr. Oxley, on *Protospongia pedicellata*, a new compound infusorian; and Mr. C. D. Ahrens on some new polarising prisms which he had devised.

## PARIS

**Academy of Sciences, July 7.**—M. Rolland, President, in the chair.—Remarks in connection with a note of M. Berthot on the mutual attraction and repulsion of the molecules of bodies, by M. de Saint-Venant.—Note on the absorption of chlorine by carbon, and on its combination with hydrogen, by MM. Berthelot and Guntz.—Remarks on the projected inland sea in North Africa, by M. de Lesseps. The author, who supports the scheme, replies to the objections raised by M. Cosson, and denies that its execution would involve the ruin of the Belad-al-Jerid and Sâf districts.—On the cholera epidemic, by M. E. Cosson. While admitting that the present epidemic in the south of France is of the Asiatic type, the author points out that it is of a much less virulent character than previous visitations. The germs of the malady seem to lose their intensity and power of transmission in proportion to the distance of the places whence they have been imported. They may thus be compared to the attenuated virus artificially cultivated by M. Pasteur. The efficacy of military cordons and measures of isolation and disinfection is insisted upon, and illustrated by reference to the results obtained by these precautions during the prevalence of cholera in Algeria in the year 1867.—On the so-called algebraic monothetic equations, in which all the coefficients are functions of a single matrix  $m$ , by Prof. Sylvester.—Memoir on the chemical composition and alimentary value of the various constituents of wheat, by M. Aimé. Contrary to the generally received opinion, the author concludes, from experiments made on himself, that whole meal or household bread, containing all the ingredients of the grain, is less wholesome and more indigestible than pure white bread made of the flour alone.—New researches on the structure of the brain and on the func-

tions of the white fibres of the cerebral substance, by M. J. Luyt.—On the developments bearing on the distance of two points, and on some properties of the spherical functions, by M. O. Callandreau.—Note on the holomorphic functions of any genus (mathematical analysis), by M. E. Cesaro.—On the determination of longitudes in the region of the Caucasus, letter addressed to M. Faye by General Stebnitski.—Note on the electric conductivity of highly diluted aqueous solutions of organic substances, such as ethylic alcohol, glycerine, phenol, glucose, urea, acetone, albumen, ordinary ether, and ethylic aldehyde, by M. E. Bouty. Researches on anhydrous phosphoric acid, by MM. P. Hautefeuille and A. Perrey.—On some new boronates, by M. D. Klein.—On the dishydrating action of salts, by M. D. Tommasi. According to the researches of M. Grimaux, salts would appear to favour the coagulation of colloidal substances by acting as dishydratants. But the author shows that in some cases certain salts produce the opposite result.—On perseite, a saccharine substance extracted from the berry of *Laurus perser*, and analogous to mannite, by MM. A. Muntz and V. Marciano.—On the bibromide of metaxylene, metaxylenic glycol, and other derivatives of metaxylene, by M. A. Colson.—Polarimetric researches on the regenerated cellulose of pyroxylenes and on the cellulose subjected to the action of sulphuric acid, by M. A. Levallois.—Experiments on the artificial fabrication of farmyard manure, by M. P. P. Dchérain.—Contribution to the comparative anatomy of the races of mankind: dissection of a Bosjesman, by M. L. Testut. These studies, made on a subject from twelve to fourteen years old, have revealed a muscular system in a more or less rudimentary state, which exists in a normal condition in various anthropoid and other apes, and in some instances even in mammals of other orders. In his remarks on the paper M. de Quatrefages points out that it supplies no fresh argument in favour of man's descent from a simian prototype.—On the submaxillary of *Oligotoma saundersii*, *Edipoda cinerascens*, *Gryllus domesticus*, and some other members of the locust family, by M. J. Chatin.—Researches on the transpiration of vegetables under the tropics, by M. V. Marciano.—On a new genus of fossil grain (*Gnetopsis elliptica*, *G. trigona*, and *G. hexagona*) from the Upper Carboniferous Measures, by MM. B. Renault and R. Zeiller.

## CONTENTS

	PAGE
Professor Tait's "Light." By R. T. Glazebrook . . . . .	261
Our Book Shelf:—	
Munro and Jamieson's "Pocket-Book of Electrical Rules and Tables."—A. Gray . . . . .	262
Warden and Waddell's "Non-Bacillar Nature of Abrus Poison" . . . . .	263
Zeigler's "Text-Book of Pathological Anatomy and Pathogenesis" . . . . .	263
Letters to the Editor:—	
The Late M. Dumas.—Dr. W. H. Perkin, P.C.S. . . . .	263
The Cholera Germ.—E. K. . . . .	263
The Mountain System of the Malayan Peninsula.—Rev. J. E. Tenison-Woods . . . . .	264
Chalk and the "Origin and Distribution of Deep-Sea Deposits."—J. Starkie Gardner . . . . .	264
Animal Intelligence.—T. H. Potts; Dr. George J. Romanes, F.R.S. . . . .	265
Diffusion of Scientific Memoirs.—Prof. John Milne . . . . .	267
Suicide of Snakes.—Rev. W. R. Manley . . . . .	268
Sky-Glows.—B. J. Hopkins; Capt. Frank Petrie . . . . .	268
Fireball.—Annie E. Cocking . . . . .	269
Butterflies as Botanists.—W. G. S. . . . .	269
A Cannibal Snake.—John Fotheringham . . . . .	269
Fourth Note on the Electrical Resistance of the Human Body. By Dr. W. H. Stone . . . . .	269
Gas-Burners . . . . .	270
Birds'-Nest Soup . . . . .	271
On the Evolution of Forms of Ornament, II. By Prof. Jacobsthal. (Illustrated) . . . . .	272
Notes . . . . .	274
Zoological Nomenclature, II. . . . .	277
Krakatoa . . . . .	279
Evidences of the Existence of Light at Great Depths in the Sea. By A. E. Verrill . . . . .	280
Artificial Lighting. By R. E. B. Crompton . . . . .	281
Societies and Academies . . . . .	283

THURSDAY, JULY 24, 1884

## THE CONSTRUCTION OF ORDNANCE

*A Treatise on the Application of Wire to the Construction of Ordnance.* By James Ackman Longridge, M.I.C.E. (London: Spon, 1884.)

ABOUT thirty years ago, during the raging of the Crimean war, special attention began to be directed towards the improvement of our artillery. The old Board of Ordnance was abolished. The manufacturing departments at Woolwich were put under the control of a newly created Minister of War. That able and high-minded officer, Colonel F. M. Eardley-Wilmot, R.A., was appointed Superintendent of the Gun Factories, July 1855. He commenced his work in a thoroughly sensible and practical manner, and pursued his inquiries for suitable materials for guns both at home and abroad. He was ready to adopt anything, new or old, provided it was of the right sort. Sir H. Bessemer has remarked: "My early progress was known to only a few scientific men, among whom was Colonel Eardley-Wilmot, R.A., who took great interest in the invention." But in the summer of 1859 it was decided to adopt the Armstrong breech-loading system, and in November 1859 Colonel Eardley-Wilmot was requested to resign his post at the Gun Factories, to make room for Mr. (now Sir W.) Armstrong.

The 12-pounder Armstrong breech-loading field-guns appear to have given satisfaction, and the authorities at once proceeded to manufacture 110-pounders on the same system without exercising due caution, as explained by General Peel in his letters to the *Times* about September 1868. For, he says, the following sums were voted "for the purchase and manufacture of warlike and miscellaneous stores:—

In 1860-61	... ..	£2,830,625 ; and
In 1861-62	... ..	£3,006,049

a great portion of which was for the 110-pounder Armstrong guns, which had been adopted into the service without any sufficient trial of them." Among other things, the vent-pieces failed, no matter of what material they were constructed. All the while the nation had to abide strictly by the terms of its bargain—it had adopted the gun, and it must take the consequences. We have never heard that any variation in the principle of the invention was tried with a view to relieve the gun of the excessive pressure at the breech. It was said that there was a contraction of the bore just before the seat of the shot, so that there could be little doubt that the whole of the quick-burning powder then in use would be converted into gas before the projectile moved forward any appreciable distance. Something must therefore yield, and that was generally the vent-piece. Before abandoning the system it would not have cost much to take some disabled gun and remove the chief part of the obstruction to the initial motion of the shot. But the 110-pounders had failed, and there was end of the system—according to the decision of its own friends. But it will be seen that at least one system employing lead-coated projectiles of about 300 lbs. in weight was made to succeed.

The authorities then turned their attention to muzzle-

loaders, with which they were more successful. Although they now used studded shot, they were careful to avoid all needless obstruction to the initial motion of the shot by the use of an increasing twist in the rifling. Also the high initial tension of the powder gas would in this case find some relief from windage.

About the year 1869 the Prussian Government instituted a comparative trial between the English 9-inch muzzle-loading gun and the 9½-inch breech-loading gun of Krupp. Different opinions have been expressed respecting the fairness with which this competition was conducted. But this much must be said in favour of the decision arrived at, that the Prussians seem to have abided by it, and that they have not come to England to purchase muzzle-loaders constructed on the iron coil system. The striking fact was that Krupp could construct breech-loading guns to fire 200 to 300 lb. lead-coated projectiles from a 9½-inch breech-loading gun with safety, whereas the Woolwich breech-loading guns failed with similar shot of 110 lbs. with a bore of about 7 inches.

Since that time breech-loading has ceased to be looked upon as an impossibility. We even learn incidentally that we have ships armed with guns constructed on that system.

About 1865 the Committee on Explosives was appointed, who continued their labours throughout many years. We are not aware that details of their observations, made with the chronoscope and crusher gauges, were ever published *in extenso*. So long as this remains the case, the conclusions of the Committee can never be completely accepted. But so many contradictory observations have been published that we are compelled either to doubt the results given by the crusher gauge or to suppose that the forces developed by fired gunpowder are liable to great variation, even where the initial velocity of the shot is the same. Observations with the chronoscope we put aside as of no value in obtaining an accurate measure of the forces, which vary rapidly, and, acting upon a body at rest, generate a high velocity in a space of 10 or 20 feet. Observations of that kind are only valuable when the force affecting the motion changes by slow degrees.

Throughout all these changes the Woolwich system has been in the main the Armstrong system of coils of wrought iron for both breech- and muzzle-loading guns, while the recommendations of steel by Krupp and Whitworth have been set aside partly on the score of expense. But now there are indications that the Woolwich system of coiling is not considered to be quite satisfactory.

Mr. Longridge says:—"Since 1862 millions upon millions have been spent, and we are now told that we are on the eve of a new epoch of expenditure, that the great array of weapons which we have provided are no longer up to the mark, and millions upon millions must again be disbursed before the nation is properly armed" (p. 2).

This seems therefore to be a favourable opportunity for the official consideration of Mr. Longridge's system of applying wire to the construction of heavy ordnance. No other system allows of the tension being so nicely and so readily adjusted. Mr. Longridge appears to have been the first to advocate this system of constructing guns, for so early as 1860 he presented a paper on the subject to the Institution of Civil Engineers. When he first applied

to the Government, the objection to his proposals was their extreme novelty, but later on he was told that there was no novelty in the principle of his designs!

Mr. Longridge states the problem to be solved in the following satisfactory terms:—

“Suppose a coil of wire situated near to the inner tube of the gun. It is laid on under a certain tension, but its state is altered by each successive coil which comes over it, and when the gun is completed it is no longer in tension but in compression.

“There is in a finished gun a certain distance from the centre of the bore at which the wire is in a neutral state; it is neither in tension nor in compression. All the wires proceeding outwards from this point are in a state of tension varying, according to a definite law, according to the distance from the centre of the gun. All those proceeding inwards are in a state of compression, as is also the inner tube on which they are coiled.

“In a gun thus constructed the aggregate of all the tensions is exactly equal to that of the compressions whilst the gun is at rest, but when the strain of the explosion is brought into action the state of each wire is altered, all the compressions are reduced and eventually changed to tensions, and all the tensions increased; and, in a gun properly constructed, if the pressure inside were increased to the bursting point, every wire would be strained to its maximum tensile force, and would give way at the same time” (p. 15).

Afterwards Mr. Longridge gives elaborate calculations of the tension proper for each coil of wire.

The system of “chambering” large guns is now in use at Woolwich, Elswick, and Essen, but it appears most objectionable. We quite agree with Mr. Longridge, that “chambering is a poor and inefficient expedient for lengthening a gun at the cost of its durability.” He found “that in the case of the 38-ton 12-inch gun the result of chambering out to 14 inches was to reduce the length of the charge from 27 to 20 inches . . . and that this would *ceteris paribus* increase the velocity of the shot about 7 or 8 feet per second” (p. 17). In such a case the mere chambering would give an increased longitudinal strain of nearly 820 tons in the chamber, allowing a pressure of 20 tons per square inch to the powder gas, while the tendency to burst the coil would be increased in the proportion 6 : 7, or nearly 17 per cent. The Committee on Explosives profess to have discovered a so-called “wave action” which may or may not exist in guns fired under the same conditions. And it is claimed for “chambering” that it (1) gives a higher initial velocity, and (2) prevents the abnormal very high local pressures induced by long cartridges. In the case mentioned by Mr. Longridge 7 inches was the gain in the space through which the powder gas propelled the shot. But the charge being in a more compact form, only 20 inches long, would probably explode more rapidly than it would in the bore 27 inches long, and consequently the powder gas propelling the shot at corresponding points in the bore would be greater with the chambering, and consequently in that case the initial velocity of the shot might be expected to be greater, especially with the increment of 7 inches in the useful length of the bore. But it is difficult to imagine in what way chambering could reduce the stress upon the gun. We have found by calculation what would be the

lengths of the following guns, in order to allow the same internal volume:—

	ft.	in.
71-ton Krupp gun, chambered ..	32	10 long.
“    “    unchambered ..	33	11
80-ton Woolwich, chambered ..	26	9
“    “    unchambered ..	28	1
100-ton Armstrong, chambered ..	32	8
“    “    unchambered ..	33	10

From this it appears that the saving in total length of gun due to chambering is not great.

The process seems to have been this. After much trouble guns were manufactured which with a uniform bore and slow-burning powder stood tolerably well. In order to obtain an increased initial velocity the gun was chambered and therefore weakened. Sir W. Armstrong says that the calculated strength of his 100-ton chambered gun, which failed, was “far in excess of what a normal pressure would demand.” And then he goes on to state, March 1880, that “Nothing, in fact, wants investigation so much as this powder question” (*Proceedings of the R.A. Institution, Woolwich, vol. xi. p. 197*). If chambering is to be profitably used it appears that it will be necessary to adopt steel and abandon coiling—both wire and wrought iron.

As a uniform bore gives the strongest form of gun, it appears to be very desirable to obtain a slow-burning powder less bulky than that now in use. But if that be not possible, we would either slightly lengthen the gun or use a powder a very little more energetic than that now in use, and just sufficient to compensate for a want of chambering.

Mr. Longridge quotes the following remark of Messrs. Noble and Abel on air-spacing:—“In cases where there is a considerable air-space between the charge and the projectile, it has been found that the energy developed in the projectile is materially higher than that due to the expansion of the powder gases through the space traversed by the projectile, and the cause of this appears to us clear.

“When the charge is ignited at one end of the bore, and the ignited products have to travel a considerable distance before striking the projectile, these ignited products possess considerable energy, and a portion of this energy will be communicated to the projectile by direct impact” (p. 110).

Well may Mr. Longridge exclaim: “With all respect to these gentlemen, we are quite unable to accept this explanation.” The explanation we have to offer is that when a moderate air-space is left there will be a delay in the initial motion of the shot, and consequently the explosion of the charge for every position of the shot will have proceeded further than if there had been no air-space, and consequently the pressure of the powder gas will on the whole be increased. But, on the other hand, there will be a slight loss of velocity, since the powder gas acts on the projectile through a slightly reduced length of bore corresponding to the air-space.

We have never made experiments on the pressure and action of fired gunpowder. But we hold that with “chambering” and “air-spacing,” using the same powder, the gun must be distressed, if by these means any sensible addition of initial velocity of the shot is obtained.

Mr. Longridge appears with reason to recommend the

adoption of a uniform twist of rifling, now slow-burning powder is used. The increasing twist of rifling was very probably effective in saving the gun when quickly-exploding powder was employed. But the importance of an increasing twist of rifling decreases as the action of the powder gas is rendered more nearly uniform. If the pressure driving the projectile throughout could be made perfectly uniform, then a uniform twist would exert a constant force to produce rotation.

Mr. Longridge says:—"So long ago as 17th March, 1860, the then Secretary of State for War, in his speech on the Army Estimates, said that 'these experiments proved that they had been wrong in using powder of so quick a detonating nature for artillery practice, and especially for rifled cannon, which required a weaker and slower powder than in the other cases' (p. 113). And twenty-four years later, March 20, 1884, the Secretary to the Admiralty said: "The old breech-loader had been found to be of no more use than a muzzle-loader, and the Government had adopted a gun twice as long as the old form of breech-loader." It is not very clear what all this means, but it is plain that vast sums of money will be required to provide long guns. Twenty years ago it might have been determined what effect every additional foot in length of a gun had in imparting increased initial velocity and increased steadiness to projectiles; but something more than the "rule of thumb" would be required to accomplish this.

England has of late come to acknowledge the value of technical training, and has shown a readiness to take a lesson from Continental nations. Is it not natural to suppose that some training of this kind might be found useful in settling the proportions of our guns, and in other matters of the same kind?

We think that Mr. Longridge has made out his case, and that his system deserves a fair trial in comparison with other promising systems. It has already been deemed worthy of a partial trial at Elswick, in France, and America. Experimental guns on different promising systems might in the first case be constructed of small calibre, and adapted to fire the service projectiles. If these proved satisfactory, then proceed to construct larger guns, and finally let that system survive which was found best fitted for its purpose.

F. B.

#### OUR BOOK SHELF

*A History of British Birds.* By the late William Yarrell, V.P.L.S., F.Z.S. Fourth Edition. Revised to the end of the second volume by Alfred Newton, M.A., F.R.S., continued by Howard Saunders, F.L.S., F.Z.S. Parts XXI.-XXIV., January to July, 1884. (London: Van Voorst.)

ALTHOUGH, as we have said in a former notice of this work, it was a great pity that Prof. Newton could not be induced to complete his revised edition of Yarrell's well-known "History of British Birds,"—a subject in which he is before all other living naturalists at home, there can be no doubt that the task has fallen into good hands. Mr. Howard Saunders has not only completed a volume in about the same space of time that the former editor took to issue a single number, but has performed his work in a style to which, we think, little exception will be taken. The aim of Yarrell's "History of British Birds," we suppose, is to be sufficiently popular to be understood by all

well-educated people, and at the same time to be thoroughly correct in scientific matters, so far as they are involved. As to Mr. Saunders' numerous remarks upon points of synonymy and distribution being entirely free from error, we should be very sorry to guarantee anything of the sort. But as we turn over the pages of his recent numbers, very few exceptional statements seem to present themselves, and most of these relate to what are to a certain extent matters of opinion.

Having finished his *Limicola* in Part XXI., Mr. Howard Saunders naturally proceeds to the Gaviæ, a part of his subject with which he is, as we all know, very familiar. An author who has worked out the Laridæ of the whole world in a thoroughly conscientious manner, and made this group his special study, is above all others qualified to prepare a special account of the "British" species. Of these Mr. Saunders recognises thirty as admissible into the list, though it is more than probable that this already large number will be still increased by the arrival in future years of stray individuals belonging to other species of this essentially wandering tribe of birds.

Congratulating our author on the accomplishment of the first volume of his portion of this excellent work, we may venture to express a hope that he will bring the long-delayed fourth edition of "Yarrell's Birds" to a speedy and satisfactory conclusion.

*Bulletin of the United States National Museum.* No. 19. "Nomenclator Zoologicus." By Samuel H. Scudder. 8vo. (Washington, 1882-1884.)

MR. SCUDDER'S "Nomenclator Zoologicus," which has been issued as No. 19 of the *Bulletins* of the United States National Museum, is not of a generally attractive nature, but will be of great use to working zoologists. It consists of two parts: the first of these, or "Supplemental List," contains the names of genera in zoology established previous to 1884, which are either not recorded or erroneously given in the previously issued Nomenclators of Agassiz and Marschall. To each generic name is added a reference to the work in which it is to be found. The second portion of Mr. Scudder's volume, or "Universal Index," contains an alphabetical index of all the names included in the "Supplemental List," together with those given in the Nomenclators of Agassiz and Marschall, and in the Indices of the Zoological Records. This second, most important part, contains about 80,000 entries, and, if correctly drawn up, as we have no reason to doubt is the case, will enable a naturalist who has recourse to it to determine at a glance whether any particular name has been already employed in zoology or not. All working naturalists will at once acknowledge the value of such an index as this, and will join us in thanking Mr. Scudder for having produced it. Could Mr. Scudder's index be magnified into a "Lexicon Zoologicum," giving the references to all the 80,000 terms in a single volume, a still more meritorious and useful work would be the result. Until this shall have been accomplished, it will still be necessary for a naturalist to refer to half a dozen or more different works in order to ascertain where any particular generic term has been employed in zoology.

#### LETTERS TO THE EDITOR

[The Editor does not hold himself responsible for opinions expressed by his correspondents. Neither can he undertake to return, or to correspond with the writers of, rejected manuscripts. No notice is taken of anonymous communications.]

[The Editor urgently requests correspondents to keep their letters as short as possible. The pressure on his space is so great that it is impossible otherwise to insure the appearance even of communications containing interesting and novel facts.]

Krakatō

I FORWARD a letter recently received from a former pupil, Dr. Stanley M. Randall, which gives so graphic a description of the



sea of pumice which resulted from the eruption of Krakatoa, that you may perhaps not be indisposed to print it in NATURE.

University of Edinburgh, July 17 WM. TURNER

71, Rue de Genève, Aix-les-Bains, June 24, 1884

DEAR PROFESSOR TURNER,—I have been so occupied since meeting you in Edinburgh that it has been impossible to send sooner notes of my trip to Java. The first intimation that I had of anything unusual having occurred was on our way out to Australia. Making our way north again after having done our "easting" in about 45° S., we were all much struck by the splendidly vivid sunsets, and by the distinct interval of time between the actual disappearance of the sun below the horizon and the appearance of the deep red or crimson glow. This phenomenon was more striking as we sailed north. On reaching Queensland we heard of the volcanic eruption in the Sunda Straits and received the explanation of the so-called "Krakatoa Sunsets." I left Newcastle, N.S.W., for Batavia in a steamer about November 10, 1883, *via* Cape Leeuwin, sailing up the west coast of Australia. We first came across distinct evidences of the eruption about 200 miles before we entered the Straits of Sunda, in small isolated pieces of pumice-stone, which became much more numerous and finally took the form of yellow patches constituted by morsels of pumice varying in size from a pea or even smaller up to a cocoa-nut, rarely larger. As we neared Krakatoa itself, these patches were certainly more numerous and larger in size, but still the actual amount of debris was small, much smaller than I had expected to find after the account I had heard from persons who had previously traversed the Straits. The yellow patches were few and far between, and composed chiefly of a coarse dust with here and there larger lumps amongst it. Krakatoa, formerly the most fertile of all the lovely isles which one passes, rose like a vast cinder, still smoking. Not a blade of grass or a leaf was to be seen, just a grayish seared-looking mass. A large portion of the island had disappeared, and I was told that over the sunken part 300-fathom soundings had been taken. Between the island and Batavia we passed a few more floating patches of pumice as above described. After about eight days at Batavia we steamed down the coast to different ports, Cheribon, Tegal, and Samarang, being on the whole about three weeks away from the time we left Batavia to our return there, which took place, so far as I can remember, on January 1. On nearing Batavia again we passed through large patches of pumice-stone, patches of several acres in extent, some of the lumps forming them being of large size, roughly speaking about as big as a cwt. sack of coals, and all sizes below that down to coarse dust. We anchored for the night just outside the port in clear water. Early in the morning one of the officers called me to look at an immense floc of pumice-stone that was bearing down upon the ship, and very soon we were entirely surrounded, and formed the centre of about, I should think, a square mile. Though covering a large surface, there was evidently no great depth of matter. One could pick it up by throwing a bucket or heavy pail into the mass, and a small steam launch easily made her way through it to our side. We left Batavia early in the morning, and passed through two or three such collections, all making their way in the same direction by the action of a current, as there was no wind, the sea being perfectly calm. When about thirty miles from Batavia, we met coming towards us an immense field, similar, except for its greater extent, to those already described. I could not tell you by any means exactly how large a surface it covered, but at one time could only just make out the edge we had entered it at with the naked eye, and could not see its termination in the opposite direction with the ship's glass, so that it was at least several miles in extent. Also the depth of the pumice-stone bed was very great, offering considerable resistance to the ship's progress, as shown by its diminished speed. An iron fire-bar thrown over the side rested on the surface of the mass, instead of sinking. Large trunks of trees were not floating in the water, but resting on the surface of the pumice. The passage of our vessel left a wake of only a few feet, which speedily closed in again, so that to see it all I had to lean over the stern and look under it as it were. It seemed exactly as if we were steaming through dry land, the ship acting as a plough, turning up on each side of her a large mound of pumice, especially noticeable on looking over the bows. Our passage through this made no great noise—just a soft sort of crushing sound. The effect was very striking and queer. I only regret that I did not time our passage through this, the largest mass we met. We passed through one more but smaller field in the Straits of Sunda, and after that do not remember again

meeting with any even small patches of pumice-stone. I thought it curious meeting such immense quantities of the debris in the same place where, a month or five weeks earlier, only a few scanty, isolated patches existed. It was not due to a new eruption, so must be accounted for by the currents massing together a large number of scattered patches; or perhaps a certain amount had first sunk, and then, later on, had risen to the surface. I hope these short notes may be what you want; if I can give you any more information, I shall be delighted to do so.

With kindest regards,

Believe me yours sincerely,

STANLEY M. RENDALL

#### The Laws of Volume and Specific Heat

THE former, known as the "law of Avogadro," implies that any given volume at the same temperature and pressure must contain the same number of molecules. It includes the law of Charles, viz. equal expansibility for equal increments of heat; and the law of Boyle or Mariotte, that the volume of any gas must vary inversely as the pressure.

The other is that of Dulong and Petit; and as the former necessitated equal volumes, so this latter implies constant heats for parallel conditions. But, finding that few elements approximated this law, it was an early device to double, treble, or quadruple the old atomic weights to secure a supposed uniformity; and thus the law found this expression, viz. that the specific heat of any solid element would prove to be a measure of its atomic quantity.

This, put in plausible fashion, will be the stock instruction of the superficial books for some time to come; but in the higher circles of chemical life it is being admitted more and more that a great change has come over the spirit of this dream. Departures from the normal 6.4 are no longer attributed to errors of observation, and that constant is replaced by a range of 5.5 to 6.9; while, to keep within this, M. Weber has proved that the doubled carbon equivalent must be tested at a range of temperature exceeding 1000° C. He has found that within the limits of -50° and 600° its heat value increases sevenfold! Well indeed may he say, "The idea that temperature can be overlooked must no longer be entertained;" also, "That the specific heats are not generally expressed by constant numbers; the physical condition of the elements influence their specific heats as much as their chemical nature."

These be great admissions from one of the highest authority, but they are as nothing compared with the new demands of physical chemistry. Mr. J. T. Sprague, an able and determined new chemist, has been the first in England to challenge attention to the recent researches of M. Berthelot, L. Troost, and others of the very highest chemical authority.

In a recent paper he admits that the new results "strike at the root of the most favourite chemical doctrines of the day, doctrines which are the foundation of the modern atomic weight and molecular theory, and consequently of the doctrines of atomicity, and the complicated molecular theories which have been based upon the supposed atomicity and specific bonds of different atoms."

The laws of Avogadro and Dulong and Petit are offshoots of one principle, and one really implies the other. If true, it would follow that the atomic heat must be the same for all substances, or, if otherwise, the same quantity of heat would not produce equal expansions; also that the specific heats must be equal at all temperatures, or equal quantities of heat would act differently at different temperatures, or else it must vary equally for all gases, or they would expand unequally for equal quantities of heat.

Now it is a misfortune for these laws that none of these conditions subsist over wide areas. As a consequence of the two laws, an air thermometer should measure all temperatures by equal rates of expansion, and a given expansion should correspond to a fixed quantity of heat; such a thermometer should also read equally if filled with any other perfect gas.

In other words, these laws can only be true if the relation between the weight and volume of different gases be constant, and if the heat absorbed in producing a given change of volume is equal at all temperatures; that is, if the specific heat is constant.

These conditions are practically fulfilled by air, O, N, and H, between 0° and 200° C., so that the scale of temperature derived from the change of volume is the same as the scale derived from quantities of heat; but between 200° and 4500° there is a gradual growth of changed conditions which proves fatal to both laws,

and there is apparently an absorption of energy which does not appear either in the form of expansion or of sensible heat as temperature. At this high stage the specific heat of some of the simple gases has increased threefold, while some gases have a greater rate of expansion than others.

The same thing occurs with other simple gases, but at a much lower temperature, as, even within 0° and 200°, where dissociation cannot be entertained, chlorine and other halogens differ considerably from N or H, and at 1600°, if an air thermometer indicated 1600° for a given expansion, a chlorine one would register by expansion 2400° for an equal temperature, though with a much greater absorption of heat by the chlorine.

This difference is dependent on the fact that at 1600° the comparative density of chlorine has diminished one-third; or, in other words, that its volume, as compared with H, instead of being 1, has become 1.5; or, to put it in another way, that under these conditions, the specific heat of Cl is threefold that of H.

Quite apart from these extreme cases the specific heat is never a constant value; it takes more heat to raise a given weight of substance 1° at one temperature than another.

The specific heat increases with temperature, but differently for different substances:—

		0° to 100°	0° to 300°
Iron ... ..	=	.1098	.1218
Platinum ... ..	=	.0335	.0343
Mercury ... ..	=	.0330	.0350

The differences here are both distinct and small, but Be (glucinium) increases twofold within a moderate range, and we have seen that between - 50° and 600° carbon increases its specific heat sevenfold, or, as Mr. Sprague expresses it: "The heat relation of each substance is described by a particular curve; and the small differences observed in some cases are not errors, but actual differences of the several curves, and where there is approach to identity it is accidental, due to the temperature of observation being within a limit at which the curves are near their commencement, and have barely begun to separate."

However tempting or fashionable it may be to rush into hypothetical explanations of half-digested truths, yet I have taken some pains to keep within facts, which are in some respects incipient and but little understood.

If the causal differences in the production of light and sound had been fairly or patiently entertained, the "luminiferous ether" would never have been invented, which now crosses our path, as an "opaque fact, stopping the progress of further knowledge."

If a little more humility and patience had been evinced in respect of the expanding facts connected with gaseous volumes and specific heats, the old equivalents would never have been doubled, trebled, or quadrupled, to mar the symmetry of a beautiful science.

I quite agree with M. Troost, who, in repudiating the hasty references to dissociation, &c., observes: "The only consequences which necessarily flow from the experiments at high temperatures, or at low pressures, are that the coefficient of expansion is variable with the temperature, or that the coefficient of compressibility varies with the pressure." Also with the final conclusion of M. Berthelot: "The only law absolutely and universally applicable to the elements is the invariability of the relations of weight according to which they combine. This notion, and that of the energy brought into play in their reactions, are the sole and only firm foundations of chemical science."

SAMUEL E. PHILLIPS

### A Carnivorous Plant

WITH reference to Prof. Moseley's letter in your issue of May 22 (p. 81) on "A Carnivorous Plant preying on Vertebrata," I may mention that in 1881, when surveying at the Paracel Islands in the South China Sea, I saw a somewhat similar occurrence. The tide was low on the reef on which I was strolling and admiring the lovely forms of coral existence. As I neared a pool cut off by the tide from the sea, I noticed amongst other submarine verdure a very ordinary-looking flesh-coloured weed about one foot high and of similar girth. My appearance alarmed numbers of tiny fish, which darted to the cover of overhanging ledges, but I noticed about half a dozen apparently seeking cover in the weed. Bending down closer, I saw that they were lying helpless about the fronds, with very little life left in them. Putting my hand down to pick up one of the half-dead fish, I found my fingers sucked by the weed, the fronds of which

closed slightly on them. The fish were not caught by the head especially, but held anywhere round the body. The death seemed to be slow and lingering, and where the fish had been held its skin was macerated. These captives may have been caught some time, and were in different stages of exhaustion. I regret being unable to name the plant, or the young fish. They were from an inch to an inch and a half long. The plant had a dirty and rather slimy look about it. ALFRED CARPENTER

H.M.S. *Myrmidon*, Suakim, Red Sea, June 24

### Phosphorescence of the Jelly-Fish

THE conclusions arrived at by Mr. Verrill (NATURE, July 17, p. 281) cannot fail to be of interest to all who have ever speculated on the significance of the luminosity displayed by so many *Acalepha*, *Meduse*, and other marine organisms. When in the tropics, in 1875, very similar ideas occurred to me, and in an address on the phenomena of cyclical propagation delivered to the Essex Field Club on January 28, 1882, I ventured to put forward the following views, which, as the address is still in manuscript, I will beg permission to quote:—"It was in the Bay of Bengal, when on the Eclipse Expedition of 1875, that I first saw shoals of *Meduse* in their full splendour. Speculating on the meaning of the vivid colours and brilliant phosphorescence of these creatures, I came to the conclusion that both these characters might be protective danger-signals of the same nature and fulfilling the same function as the bright colours of distasteful caterpillars according to Wallace's well-known theory, or the phosphorescence of the *Lampyridae* according to Thomas Belt ('Naturalist in Nicaragua,' p. 320). The 'urticating' powers of the jelly-fish would certainly make them unpleasant, if not absolutely dangerous, to predatory fish, and their bright colours and luminosity at night may thus be true warning characters."

R. MELDOLA

London, July 21

### Fireball

RECORDED personal observations, such as that of Miss Annie E. Cocking (NATURE, p. 269) last week, must needs be so rare that every detail of them—especially where the description is clear and simple—is of weight and value. What strikes my own mind as of much interest in this one is that, as the strange and fateful visitant sank towards the carpet, "at this instant a peal of thunder crashed over the house—it was the very loudest the writer had ever heard." This would seem to show that, whatever the nature of the insulator which envelopes these floating Leyden jars, their connection is maintained unbroken with the cloud of origin until the moment of discharge; and that, whatever causes the "crash," a peal of thunder takes effect rather in the cloud than at the point of contact. This agrees also with the descent of a fireball in the sea at Margate, mentioned in to-day's papers, where the crash of thunder occurred while the ball was yet in sight. But it is still another question whether these floating globes, which only discharge themselves on contact, do not in some important respect differ in their nature from the commoner "fireball" discharged with the directness, if not all the speed, of a lightning flash out of a thundercloud. It is a question towards the solution of which only observations such as that for which we are indebted to Miss Cocking can materially help us.

HENRY CECIL

Bregner, Bournemouth, July 21

### Animal Intelligence

THE following instance of animal intelligence may interest some of your readers. While walking through the forest here the other day, I found a young jay upon the ground scarcely able to fly. As I stooped down to examine it I was somewhat startled by a swoop made at my head by the old birds, their wings actually touching my hat. Determined not to be driven away, I remained by the young bird, whereupon a succession of like swoops were made at my head; these I easily succeeded in parrying with my stick, although the old birds frequently came in different directions. After about a couple of minutes the old birds seem to have come to the conclusion that nothing could be achieved in this fashion, and one of them, flying to some little distance, kept calling to the younger one, who half hopped, half flew after her. I of course followed; and now occurred what seems to me a striking instance of animal sagacity. The pines here are covered with lichen and a long, hairy kind of moss,

which easily crumbles into dust. The cock bird perched himself on the tree over my head, and began pecking with wonderful rapidity at this lichen and moss, so that, the moment I looked up, a shower of fine dust fell on my face. As I followed the young bird, the old one followed me, got on a branch as close to my head as he could, and sent a shower of dust down upon me. I can scarcely doubt that the dust, like the previous swoops, was intended rather to blind me than to distract my attention. Have instances of like sagacity—i.e. the apparent knowledge of the organ of vision and the means of injuring it—been noticed in jays before?

KARL PEARSON

Saig, Schwarzwald, July 14

#### Munro and Jamieson's Electrical Pocket-Book

As Mr. A. Gray's criticism of our "Pocket-Book" is chiefly confined to literal errors practically unavoidable in a work of the kind, we take the opportunity of stating that we have lately been correcting these for the second edition, which, we are happy to say, has already been called for.

J. MUNRO AND A. JAMIESON

I OBSERVE that in my article in the last number of NATURE the third sentence of the third paragraph of p. 263, beginning "In the particular case, &c.," should have the words "corrected for the heat of combination of copper oxide and sulphuric acid" inserted after the word "this."

A. GRAY

Glasgow, July 21

#### THE GREELY EXPEDITION

SUCCESS has at last attended the efforts to rescue the expedition to Lady Franklin Bay under Lieut. Greely; but, alas, out of the twenty-five men who started three years ago nineteen have perished. The party had left their station, Fort Conger, in August last, but did not succeed in getting further south than Cape Sabine, in Ellesmere Land, at the entrance to Smith Sound, about 150 miles from Lady Franklin Bay, and some 300 or 400 miles from Upernivik, the nearest Danish station. It is easy now to say that it would have been much better for the expedition to have stayed on in their comparatively comfortable quarters at Discovery Bay; the chances are that they would all have survived, and probably all have been rescued this summer by the relief party in the *Bear* and the *Thetis*.

We may remind our readers that the Greely expedition was sent out by the Government of the United States as one of the series of International Arctic expeditions, the main purpose of which was to take regular observations, according to a preconcerted plan, on the meteorological and other physical conditions of the Polar area. As the Greely expedition had to go much further north than any of the others, it started a year earlier in order to be sure to reach its post in time and be able to begin observations not later than August 1882. It was thoroughly equipped, both with scientific apparatus and with the material for a comfortable life under unusually trying conditions. The provisions supplied could have easily been made to last until the present summer, and we know from letters from Lieut. Greely, written shortly after his arrival, that the region around Lady Franklin Bay, 81° 44' N. lat., abounded in musk oxen. In the summer of 1882 strenuous efforts were made to reach the station, but with no success. Last year two vessels were sent out, but the state of the ice was such that one was completely crushed and the other was glad to escape southwards almost as soon as it had entered the threshold of the intricate channel that led to Fort Conger.

The expedition which has been so fortunate as to rescue the six survivors consisted of the United States ships *Bear* and *Thetis* and Her Majesty's ship *Alert*, which was presented to the United States Government for the purpose. The condition in which the few survivors were found is almost too harrowing to record; how very nearly too late the rescue party were is impressively shown by the fact

that Lieut. Greely, surrounded by his prostrate companions, was reading the service for the dying. "The red syenite rock forming Cape Sabine," Sir George Nares tells us, "and the islands in the neighbourhood of Payer Harbour is sterile and barren to the last degree. During the three days we were detained there, although parties from the ships explored the whole of the immediate neighbourhood, very little animal life was seen." The end of the cape or peninsula is cut into by a bay in which are several islands—Brevoort, Payer, Stalknecht, &c. Here Sir George Nares in 1875 left 250 rations, which do not seem to have been discovered by the Greely party; and of the 50,000 lbs. of food buried for them by the rescuing parties Lieut. Greely succeeded in finding only 250 lbs.

For full details as to the work accomplished by the unfortunate expedition during its almost three years' stay in so high a latitude we must await the publication of the records. Happily all the records have been saved, and thus the gain to science is likely to be of unusual value. What are the hardships to be met with, and the aspects of nature to be witnessed in this remote latitude, we know something of already from the records of our own expedition ten years ago under Sir George Nares. But the present expedition, profiting by the experience of its predecessors, and working on a carefully prearranged plan, is likely enough to tell us much that we never dreamt of. While the main work of the party was to make regular observations in physical science, it is evident that they have taken advantage of their exceptional position to push back the limits of our ignorance of Arctic geography. The lowest temperature experienced is stated to have been 61° below zero F. We all remember the exciting narrative of the painful scramble of Commander Markham and his brave men over the "palæocrystic ice" in order to make the attempt at least to reach the Pole. After about sixty miles they had to return baffled, glad to escape with their lives. Markham and Parr and their men had, however, the satisfaction of having attained the highest latitude ever reached—83° 20' 26". Lieut. Lockwood, however, succeeded in getting some four or five miles (83° 24') beyond Markham's farthest, and 19° to the east of the English route.

Lieut. Lockwood, unhappily among the dead, seems to have been one of the most active and enterprising members of the expedition. He followed Lady Franklin Bay in its continuation, Archer Fjord, ninety miles beyond Beatrix Bay, Nares's furthest, quite to the other side of Grinnell Land, which he found to be an island, separated by Archer Fjord from the land to the south, now named Arthur Land. This was confirmed by the view obtained from Mount Arthur, 5000 feet high, west of the Conger Mountains, which may possibly be the range named after the United States by Sir George Nares. This Grinnell Land seems in many ways to be an interesting region; there are evidently several peaks or mountain ranges reaching a height of 5000 feet. A considerable area both on the north and south shores is covered by an ice-cap 150 feet thick, while, so far as we can judge from the report, there is a belt of comparatively open country in the interior some sixty miles wide. Even so late as March last, when the members of the expedition were dying one by one on Cape Sabine, exploration was not neglected. From Mount Carey to the north-west of the cape Sergeant Long obtained an extensive observation in the direction of Hayes Sound, which showed him that the Sound extends twenty miles further to the west than is shown on Sir George Nares's chart.

On his journey northwards Lieut. Lockwood succeeded in reaching 7° further east than Lieut. Beaumont's furthest in 1875. From a height of 2000 feet he saw no land to the north or north-west of Greenland, but away to the north-east, in lat. 83° 35', and long. 38° 82',

he saw a cape which he named Robert Lincoln. These observations are interesting. They seem to show that to the north of the American coast the sea is comparatively landless; while to the north-east the archipelago which borders the north coast of Greenland probably extends for a long distance, perhaps to meet the north-west extension of Franz-Josef Land. Lieut. Greely himself passed the summer of 1882 in the interior of Grinnell Land, in the east of which his station was located. Here he discovered a lake, sixty miles by ten, which he named after General Hazen, the Chief of the Signal Service of the United States.

From all this it is evident that, besides carrying out their strictly scientific work, the geographical explorations of the Greely expedition have been very extensive. From Fort Conger they extended east and west over some 40° of longitude and northward over 3° of latitude. They have enabled us to give more precision on our maps to the north coast of Greenland, and to extend it to the east and north-east. Grinnell Land they have found is an island largely covered by a thick ice-cap with a great lake in the interior, and separated by a narrow channel or fjord from the newly-named Arthur Land to the south. The "palæocrystic ice" of the Nares expedition is a myth, and it is evident that the ice of any part of the Arctic area is for no two successive seasons the same. It must necessarily be continually on the move, piled up in some parts to "palæocrystic" dimensions, while in other parts the sea may be comparatively open. One point seems to us conclusively settled. It is evident from what we know of the present expedition, and of the attempts to rescue it, added to the experience of previous expeditions, that there is no way to the Pole by the Smith Sound route for either ships or sledges. What Lieut. Lockwood saw from his vantage-ground to the north-eastwards seems to us to show that the route by Franz-Josef Land is more hopeful than ever, and that, if another attempt is made to reach the Pole, the choice of a starting-point will probably lie between that land and the New Siberian Islands.

#### L'ABBÉ MOIGNO

FRANÇOIS NAPOLÉON MARIE MOIGNO, mathematician, physicist, linguist, and ecclesiastic, was born at Guéméné (Morbihan) on April 20, 1804; as he died on Sunday, the 13th instant, he is worthy of a place among the English mathematicians whose names figure in Prof. Sylvester's British Association Address (Exeter, 1869). He was descended from a good old Breton family. Moigno first studied at the Collège de Pontivy, then proceeded to the Jesuit seminary of St. Anne d'Auray. In 1822 he went to another house of the fathers at Montrouge, where he passed his novitiate. In addition to theology he studied with great enthusiasm both the physical and mathematical sciences; in these he made rapid progress, and in 1828 arrived at a new mode of getting the equation to the tangent plane to a surface. Leaving Paris in 1830 on account of the Revolution, he spent some time in Switzerland, and here turned his wonderful powers of memory to the acquisition of some eight new languages, at the same time perfecting his knowledge of Latin and Greek. In 1836 the Jesuits appointed him to the Mathematical Chair in their house in the rue des Postes, Paris. Here he published the first volume of his great work, "Leçons de Calcul différentiel et intégral," following the methods used by, and utilising published and unpublished papers of, Cauchy. As his Superior was opposed to his scientific work, Moigno broke with the order, and gave himself up to his favourite pursuits. Having in 1845 become scientific editor of *L'Époque*, he was sent on account of that journal on a visit to England, Germany, Belgium, and Holland, and furnished to its

columns his observations on these countries. About 1850 he filled a similar post on the staffs of *La Presse* and *Le Pays*. In 1852 he became editor-in-chief of *Cosmos*, a weekly scientific review. His connection with this journal closed in 1862, and in 1863 he founded a new journal called *Les Mondes*.

From the above hasty sketch it will be seen how active Moigno was as a journalist. In 1864 he was made a Chevalier of the Legion of Honour. Moigno wrote a number of works bearing on the relation of science and religion. Of his other works we give a few titles:—The continuation of the "Leçons," noted above, the fourth volume containing a part on the Calculus of Variations (written in conjunction with M. Lindelof, 1861). "Leçons de Mécanique analytique, redigées principalement d'après les Méthodes d'A. Cauchy et étendues aux Travaux les plus récents—Statique." To Liouville he contributed a "Note sur la Détermination du Nombre des Racines réelles ou imaginaires d'une Equation numérique comprises entre des Limites données: Théorèmes de Rolle, de Budan, ou de Fourier, de Descartes, de Sturm, et de Cauchy" (v. 1840), and on a like subject ("Caractère analytique simple et sûr auquel on reconnaît que la Méthode de Newton est applicable") to the *Nouvelles Annales de Mathématiques* (x. 1851). But the great part of his writings, by which he is generally known, is physical. The Royal Society's Scientific Catalogue gives the titles of some twenty-five papers, which are concerned mostly with light, electricity, heat, and the solar spectrum; one title only we copy, "Navigation aérienne avec ou sans Ballon," from *Les Mondes*. The "Répertoire d'Optique moderne ou Analyse complète des Travaux modernes relatifs aux Phénomènes de la Lumière" (1847-1850) took him some years to write, and is a work of considerable importance. Another useful summary of results is the "Physique moléculaire, ses Conquêtes, ses Phénomènes, et ses Applications, résumés des travaux accomplis dans les vingt dernières années" (1868).

From his *actualités scientifiques* we single out here "Science Anglaise, son Bilan au mois d'Août, 1868:" this gives from the Norwich meeting of the British Association (Moigno was a Foreign Associate, but was not able to be present at the gathering) the Presidential and seven Vice-Presidential Addresses, and the evening discourses by Huxley and Odling. Dr. Hooker's address was not at all acceptable to Moigno, and he prefaces his translation ("pour effacer quelque peu le fâcheux vernis du positivisme de M. Hooker") with an article of his own, contravening the address of a Positivist Professor, Signor Govi, delivered at Turin.

It is in this last character of a translator of English scientific works (he translated also Père Secchi's work on the Sun) that Moigno did us Englishmen a great service: the following titles will prove this:—"Sur la Radiation" (Tyndall's Rede Lecture); "La Calorescence—Influence des Couleurs et de la Condition mécanique sur la Chaleur rayonnante" (Tyndall); "La Force et la Matière," and "La Force (Tyndall), avec une Appendice sur la Nature et la Constitution intime de la Matière" (by Moigno); "Analyse spectrale des Corps célestes" (Huggins); "Sur la Force de Combinaison des Atomes (Hoffmann), avec addition d'un Aperçu rapide de Philosophie chimique" (by Moigno); "Le Son" (Tyndall); "Six Leçons sur le Chaud et le Froid" (Tyndall). In 1852 appeared a second edition of the "Traité de Télégraphie électrique . . . précédée d'un Exposé de la Télégraphie ancienne de Jour et de Nuit," with an atlas; in 1850 he had published his "Proclamation patriotique. Belle Invention française." This is a pamphlet on the invention of tubular bridges by M. J. Guyot. In 1861 he wrote another pamphlet entitled "Cotonisation du Lin," which treats of a practical substitute for cotton. From the titles of these last pamphlets, as well as from those of many of the preceding works,

it will be seen that Moigno's mind was of a very practical cast, and that he was not immersed in the consideration of theories to the neglect of what is more useful.

### THE COMPOSITION OF OCEAN WATER<sup>1</sup>

#### I.

ALTHOUGH ostensibly a report on the composition of ocean water, this memoir includes in its 250 large quarto pages the record of a far more extensive research than the title implies. It contains a detailed account of seventy-seven complete analyses of sea water, largely accomplished by the use of new and specially invented methods, the record of several independent researches into purely theoretical matters, and a number of exhaustive experimental criticisms of methods employed in similar work by other chemists. Taken altogether, the Report reads like the account of a life-work, and it is wonderful how the immense amount of work described in it could possibly be accomplished in the six years which have elapsed since the return of the Expedition. The rapid completion of the work is in great measure due to Prof. Dittmar's custom of having all the routine determinations made by assistants under his immediate supervision, while he devoted himself specially to the invention and trial of new methods and the repetition of doubtful experiments. The gentlemen who assisted in the research, and whose services Prof. Dittmar is scrupulously careful in acknowledging, are Messrs. John M'Arthur, Robert Lennox, Thomas Barbour, W. G. Johnston, James M. Bowie, James B. M'Arthur, G. A. Darling, and Moses T. Buchanan.

What first strikes a chemical reader on looking through the volume is the essentially mathematical treatment of the whole subject. The value of the statistical method in discussing experimental results has been gradually realised by chemists, but it is questionable if it has ever been applied more fully or with more satisfactory effect than here. The first care in every case, after taking all possible precautions to insure the utmost attainable accuracy, was to ascertain the limiting values of the probable error of the analytical method, and for this purpose there were never less than two and frequently more than four determinations made of each constituent. The utmost pains has been taken to represent the numerical results in as many aspects as possible, in tables, in mathematical formulæ, and by means of curves.

It is only possible here to indicate the principal contents of the six chapters into which the memoir is divided. The consideration of Chapter II. "On the Salinity of Ocean Water," may be conveniently reserved for a subsequent article, where it will be taken up along with Mr. Buchanan's report on the specific gravity of ocean water, which forms Part II. of the volume.

Although sea water had been subjected to many analyses in the earlier part of the present century, the only research of permanent importance until very recently was that of Forchhammer, who analysed a great number of surface waters from all parts of the ocean in 1864. Prof. Dittmar avowedly took this research as a guide, and intended his work to be merely supplementary to it; but from the circumstances of the two chemists the later work tends rather to supersede than to supplement the earlier. Forchhammer dealt with surface water only, collected and brought home in corked bottles by seafaring men who, however willing to do their best, could not be altogether trusted to observe requisite precautions, while Dittmar was supplied with water from all depths of the ocean collected at exactly known positions under the

constant supervision of Mr. Buchanan, who secured each sample as it was drawn in a carefully stoppered bottle. We must take into account also the greater delicacy of the balances, and the more perfect analytical methods which are now available. The following table quoted from p. 203 of the Report, shows the most recent numbers assigned to the components of ocean-water salts compared with those given by Forchhammer:—

	Per 100 parts	Per 100 parts of halogen	
	of total salts, Dittmar	calculated as chlorine, Dittmar	Forchhammer
Chlorine ... ..	55.292 ...	99.848	not determined
Bromine ... ..	0.1884 ...	0.3402	"
Sulphuric acid (SO <sub>3</sub> )	6.410	11.576	11.88
Carbonic acid (CO <sub>2</sub> )	0.152	0.2742	not determined
Lime (CaO)	1.676	3.026	2.93
Magnesia (MgO)	6.209	11.212	11.03
Potash (K <sub>2</sub> O) ...	1.332	2.405	1.93
Soda (Na <sub>2</sub> O)	41.234	74.462	not determined
(Basic oxygen equivalent to the halogens)	-12.493		
Total salts ...	100.000 ...	180.584 ...	181.1

More than thirty elements are known to exist in solution in the ocean, but most of these are present in such minute quantity that it was hopeless to attempt to determine them in a number of small samples. Attention was accordingly confined to the chlorine, sulphuric acid, soda, potash, lime, and magnesia, which were estimated with very great accuracy and always by the same method, so that if more exact processes should be discovered at any future time the error of the method used may be calculated once for all, and applied as a correction to each analysis.

This rule of rigid adherence to one system was broken through in one case, that of the potash, where the ordinary process, which was first adopted, proved so unsatisfactory that it was worse than useless to continue to employ it, and the later analyses were conducted by a modification of Finkener's method that gave better results, through a curious balancing of the errors.

For the particular methods employed in each case it is necessary to refer to the memoir itself, where they are described with the utmost detail; but reference must be made to the great improvement which Prof. Dittmar has introduced in what was formerly called volumetric analysis, but which he now prefers to name *titrimetric*. It may be defined, somewhat paradoxically perhaps, as volumetric analysis by weight. The standard solutions are made up as usual by weighing the salt and measuring the water, but the whole solution is afterwards weighed, and its strength is thus determined with great accuracy. A balance combining strength and delicacy to an unusual degree is of course necessary for this purpose. By performing the titration in a weighed phial containing a weighed amount of liquid, and weighing it again after the reagent has been added to the proper amount, the burette error is obviated, except in those cases where the method of zig-zag titration is adopted, and then it only affects the measurements of the few drops of each reagent that are added in turn to produce and destroy the coloration which marks the end-point. All the chlorine determinations were made in this way by Volhard's method of precipitating the halogen by excess of silver nitrate, and estimating this excess by means of a standard solution of ammonium sulphocyanate in presence of iron alum.

The result of the seventy-seven complete analyses of ocean water, the description and discussion of which forms Chapter I., confirms Forchhammer's discovery that the percentage composition of the salts of sea water is the same in all parts of the ocean, and extends it to water from all depths. The application of the principle of constant composition to depth is subject to a slight but very important exception. The proportion of lime was found by Dittmar to be greater in very deep water than in that near the surface. Although the difference found exceeded

<sup>1</sup> "The Physics and Chemistry of the Voyage of H.M.S. *Challenger*, Vol. i. Part i. Report on the Composition of Ocean Water." By Prof. W. Dittmar, F.R.S.S.L. and E.

the sum of all the probable errors of analysis, it was considered necessary to apply a more stringent test in order to make sure that the increase in lime was really in relation to the depth. For this purpose three mixtures were made, each of about seventy samples of water from all parts of the ocean, but the first consisting entirely of surface waters, the second of samples from between 300 and 1000 fathoms, and the third of waters from a greater depth. The exact analysis of these proved beyond question that the proportion of lime increases with the depth. The same bathymetrical mixtures were used for determining the bromine, as it, of all the minor components, is the one which might be supposed to vary most with the depth, owing to the fact of its being so largely absorbed by marine vegetation; but the proportion was found to be invariable within the limits of error. The details of this very difficult and interesting series of experiments occupy Chapter III.

The question of the amount of carbonic acid in sea water is one which cannot even yet be said to be definitely settled. The simple and elegant adaptation of Tornøe's modification of Berchert's and Classen's apparatus, which Prof. Dittmar made, and which is figured in the memoir, gets over the difficulty of determining the total carbonic acid in sea water; but unfortunately it had not been invented when the *Challenger* sailed. The daily determinations of carbonic acid in sea water which Mr. Buchanan made were performed by a method that only took account of what must be called, for lack of a better expression, the loosely-combined carbonic acid; that is, the portion of the gas existing in a state of absorption in the water, and the part combined with the normal carbonates to form bicarbonates. The immense number of determinations, made in the same way under exceptionally favourable conditions, form a valuable series for purposes of comparison, and Prof. Dittmar has not failed to utilise it. His critical experiments on Mr. Buchanan's method made with the view of ascertaining its limits of uncertainty were, he acknowledges, insufficient for the purpose. This is to be regretted, for an exhaustive series of carbonic acid determinations performed on the same water by the two forms of apparatus under favourable conditions might be expected to produce valuable results. Prof. Dittmar saw that it was useless to employ samples of *Challenger* water which had been kept for several years in order to estimate the total carbonic acid. But instead of giving up the research on this account he proceeded by an ingenious use of synthetic sea waters to study the behaviour of bicarbonates in solution. He says (p. 212):—

"I am aware that this part of my work lacks the degree of precision which would be desirable for my present train of reasoning. But I had not the time to embark in the far more elaborate investigation which would have been desirable. I have, however, quite lately resumed the matter on a new basis, and hope before long to be able to formulate the exact conditions of stability in sea-water bicarbonates as they exist when dissolved in real sea water, and amongst others to decide the question whether in this process they quite directly tend to become normal, and do not perhaps more directly gravitate towards the state of sesquicarbonate. In the meantime we must reason on what data we have."

And reasoning on these data he produces a most interesting theoretical disquisition on the dissociation-tension of dissolved bicarbonates at various temperatures, and shows how the ocean acts as the great regulator of atmospheric carbonic acid. The three main results of the *Challenger* observations on this subject are given (p. 220) as:—

"1. Free carbonic acid in sea waters is the exception. As a rule the carbonic acid is less than the proportion corresponding to bicarbonate.

"2. In surface waters the proportion of carbonic acid increases when the temperature falls, and *vice versa*.

"3. Within equal ranges of temperature it seems to be lower in the surface water of the Pacific than it is in the surface water of the Atlantic Ocean."

In relation to Mr. Murray's theory of coral-reef formation and of oceanic deposits generally, it would appear probable that bottom waters contained more carbonic acid than those near the surface, and that this carbonic acid was the agent which dissolved the calcium carbonate of shells at great depths. Prof. Dittmar thinks otherwise. In his opinion Mr. Buchanan's numbers prove bottom water to contain no more carbonic acid than surface waters, and he supposes that the solution is effected by prolonged contact with the sea water itself, for by experiment he found that it was capable of dissolving calcium carbonate, though very slowly. It is not quite plain that Mr. Buchanan's numbers do warrant this conclusion, and there seems to be room for further research in this direction.

Chapter V. treats of the alkalinity of ocean water. The seventy-seven complete analyses showed that in sea-water salts there is a distinct preponderance of base over fixed acid, the difference being presumably due to carbonates; and the direct determination of the extra base by standard hydrochloric acid at the boiling point, after the method devised by the chemists of the Norwegian North Atlantic Expedition, brought out precisely the same result. The alkalinity of bottom waters was found to be distinctly greater than that of those from the surface, and this increase was exactly proportional to the larger quantity of lime present in the former. The alkalinity determinations give the only satisfactory measure of the carbonate of lime which exists as such dissolved in sea water.

The last and longest chapter is by no means the least important. It deals in a very exhaustive manner with the whole question of the absorption of oxygen and nitrogen by pure water, as well as by sea water. Finding that all previous determinations of the coefficients of absorption of these gases were more or less unsatisfactory, Prof. Dittmar entered on an elaborate series of experiments, which is fully detailed in the memoir, having as an aim the determination of the desired coefficients at different temperatures for both pure water and the water of the ocean. The second part of the research consisted of the exact analysis of the samples of air which had been extracted from sea water on the cruise by Mr. Buchanan, using Jacobsen's ingenious apparatus, which he has since simplified and improved.

There is an element of uncertainty about the extraction of gases which Prof. Dittmar scarcely seems to emphasise sufficiently. The water in every case was collected in one vessel and then transferred to another in which the gases were boiled out. The danger of atmospheric gases being absorbed was obviated in great measure by the precautions used; but if highly aerated water were brought up from a great depth some of the absorbed gases would be certain to escape during transference. The only remedy would appear to be the collection of the water in the gas-extraction flask itself, and there is no method as yet by which this can be done.

Prof. Dittmar and Mr. Lennox constructed a modification of Doyère's apparatus for the analysis of gases, which was found to work well. It is described and figured in the memoir. The results of the analyses are discussed in the light of the coefficients of absorption found in the earlier part of the research. The amount of air which ought theoretically to be absorbed by sea water of the temperature and at the pressure at which each sample was collected was first calculated, and then, from the actual amount of nitrogen found, the quantity of oxygen which should be associated with it was arrived at. The quantities of air found in solution were usually in defect of calculation, as might be expected when it is recollected that the water of the ocean is always in motion, the temperature and pressure to which it is exposed being very

different at different places; and the fact that absorptio-metric exchange had not gone far enough to reproduce equilibrium would account for the few cases in which the dissolved gases exceeded the amount calculated. The interpretation of his results seemed unsatisfactory to Prof. Dittmar. He says (p. 182):—

"I am sorry to have to confess that I have not been as successful as I should have wished in drawing general conclusions from my numbers, and if I here reproduce my endeavours in this direction, I do so chiefly in the hope that some other person, having more experience than I in dealing with statistics, may take up the problem after me, and perhaps be able to extract the latent propositions which are therein concealed. In the tables which I propose to give, he will find all the data arranged in the most convenient form, so that all he needs is at hand."

The problem of the dissolved gases is very difficult when deep waters are considered. The method pursued by Dittmar was to find the amount of nitrogen absorbed, and to calculate the temperature at which that quantity would be taken up by water at the surface; then to find the corresponding amount of oxygen, and compare that with what was found by experiment. It is evident that if the ocean were stagnant in any part the processes of oxidation always going on would tend to reduce the amount of absorbed oxygen finally to nothing, while the amount of dissolved nitrogen would be unaltered, unless it were slightly increased by the decomposition of animal matter. In many cases the oxygen deficit was found to assume very large dimensions, though oxygen was never wholly absent from the dissolved gases.

Part I. of the volume closes with a summary of the chemical work, a note by Mr. Buchanan on the determination of carbonic acid, and an appendix describing some analytical methods. The summary contains a number of valuable suggestions for future work. These are divided under two heads, the first comprising such observations of water density and rough volumetric determinations of the alkalinity as can be carried on by any intelligent seafaring man after a little instruction. The second head includes work requiring the services of a skilled chemist for its accomplishment. It embraces further researches on the composition of ocean salts by determining with the utmost precision the amounts of the principal constituents for one particular station in the ocean, water from which could be collected in large quantity at various seasons; then it could be compared with water taken at various seasons from a widely distant station, and thus the interesting question as to whether there is *any* difference in the proportion of the salts in different oceans could be settled. The minor constituents should also be estimated if possible, and very particular attention ought to be paid to alkalinity and carbonic acid determinations in freshly drawn samples. Prof. Dittmar concludes with this significant suggestion:—

"Meanwhile the best thing that could be done in regard to all the analytical problems referred to would be to work many times on samples of the same kind of water, with a view of improving on the methods and ascertaining the extent to which that one water fluctuates in its composition."

The only way in which this can be done properly is in a laboratory on shore situated within easy reach of an abundant supply of sea water, and the support of such laboratories ought to be a leading feature in the marine stations several of which, it is to be hoped, will soon be in working order on our coasts. A beginning has already been made at the Scottish Marine Station at Granton, where the special chemical problem under investigation is estuary water. The *Challenger* results may be regarded as final, for the present at least, for ocean water proper, and the results of the German and Norwegian North Atlantic Expeditions have put the waters of partially enclosed seas on a permanent basis; but the study of

estuary water has been almost neglected. This is the more regrettable because of the practical importance of a correct knowledge of the conditions of the water of an estuary, on account of its bearing on the migration of fishes into firths and up tidal rivers.

There could be no better field than the estuaries of the British coast for carrying out Prof. Dittmar's suggestion of continuous work on one kind of sea water with a view to the perfecting of analytical methods; and the perfecting of analytical methods, important though it be, may safely be predicted to be one of the least valuable results of such researches.

HUGH ROBERT MILL

#### ORNITHOLOGICAL NOTES

SEVERAL new magazines have made their appearance during the present year, the most important of them being undoubtedly the *Auk*, which is the name proposed for the journal of the American Ornithologists' Union, and which is to represent in America our old friend the *Ibis* of this country. The *Auk* is in fact a continuation of the *Bulletin* of the Nuttall Ornithological Club, and the general style of the work is the same. The papers seem to be interesting enough, but what strikes us as being decidedly above the average is the quality of the reviewing, which is developing into an art with our American brethren. Mr. Cory describes some new species of birds from Santo Domingo, the plate which accompanies his paper being scarcely up to the level of American illustration. Mr. Barrows continues his useful papers on the birds of Uruguay, and Prof. Merriam criticises Dr. Coues' "Check List," calling forth a sharp rejoinder from the last-named author in an article called "Ornithophilologicalities." In No. 2 many of the above-named papers are further continued along with others by Dr. Stejneger, who advocates some startling changes in ornithological nomenclature, and who also writes a useful paper on the genus *Acanthis*. Altogether, although the American ornithologists have elected to name their quarterly journal after a bird whose powers of flight were small, the excellence of the two numbers which have appeared reminds us of the perfection of that bird's powers of swimming and diving, so that they have taken as their symbol a species of lusty prowess which argues well for a continuation of the life and enterprise which is visible in the new magazine. We do not forget also that the *Auk* was a species common to Great Britain and North America, and therefore the very title is suggestive of a bond of union between British and American ornithologists which is certain to be strengthened with each succeeding year.

We have also received No. 1 of the *Bulletin* of the Ridgway Ornithological Club, which has been started in Chicago, and is named after Mr. Robert Ridgway, the well-known Curator of the Ornithological Department in the United States National Museum. The secretary of the new club is Mr. H. K. Coale, who is well known as a zealous and painstaking ornithologist, and under whose auspices there is doubtless a useful future before the infant society which he represents. The first number of the *Bulletin* contains only a single paper by Messrs. W. W. Cook and Otto Widmann, entitled "Bird Migration in the Mississippi Valley."

Mr. J. H. Gurney has just issued a "List of the Diurnal Birds of Prey, with References and Annotations; also a Record of Specimens preserved in the Norfolk and Norwich Museum," consisting of 187 pages. The *raison d'être* of this most useful work consisted in the publication of the first volume of the "Catalogue of Birds in the British Museum," by Mr. R. Bowdler Sharpe. The Norwich Museum, as is well known, contains one of the finest series of birds of prey in the world, and it will always be an imperishable monument to that true and self-sacrificing naturalist, Mr. J. H.

Gurney, through whose instrumentality this splendid collection has been brought together. The author commenced in 1875 an elaborate review of Mr. Sharpe's volume, giving a vast amount of additional information, principally founded upon the series of *Raptors* contained in the Norwich Museum. The complete list of the birds of prey which Mr. Gurney has now published contains an exact reference to these numerous critical papers in Mr. Sharpe's volume, but adds some of the principal synonyms, and gives the number of specimens contained in the Norwich Museum. The publication of this volume is certain to have one effect, which will take the form with all ornithologists of a hope that Mr. Gurney may feel able to continue his "Catalogue of the Raptorial Birds in the Norwich Museum," of which one part appeared some years ago; as it is certain that everything that emanates from his pen will be received with the greatest respect by his brother ornithologists, who have so long looked up to him as the greatest authority on the birds of prey.

### UTRICULARIA VULGARIS

IT was proved many years ago that several of the aquatic and terrestrial plants distributed over various quarters of the globe preyed upon flies, larvae, worms, crustaceans, and other species of small invertebrates.

For the greater part of the knowledge we have already received on this head we are indebted to the researches and experiments of Mr. Darwin, and I would refer any of my readers who may feel interested in the subject to his "Insectivorous Plants."

But until a few weeks since, when it was discovered by myself, and noted in NATURE by Prof. Moseley, that the bladder traps of the *Utricularia vulgaris* (Fig. 1) caught and destroyed newly-hatched fish, it was unknown that any of the recognised carnivorous plants possessed the power of also entrapping vertebrate animals, no single instance of the kind having been recorded by previous observers; yet it might at once have been naturally inferred, that, provided the experiment was made with creatures of a strength and size proportionate to the capacity of the organs of capture belonging to the plant, their action in every case would be precisely the same on either vertebrates or invertebrates. The *Utricularia vulgaris*, together with several other members of the same family bearing the generic name of *Utricularia*, and the specific, *neglecta*, *major*, *minor*, and *clandestina*, are very local in their habitat, growing in isolated patches in ponds and sluggish ditches, the type of place invariably selected by coarse fish to deposit their ova. This at once constitutes it as great an enemy to the small fry as the water-fowl and otters are to the larger fish in the streams, because for a considerable period after they emerge from the egg the young fish remain in the shallow water, and during this time innumerable quantities must be killed by the vesicles of the *Utricularia*.

Since I have been acquainted with the plant, I have noticed several peculiar circumstances in connection with it, which appear to have been entirely overlooked by all the botanical writers whose works I have consulted.

In the first place I have never seen it growing, unless displaced by the action of the wind, except on the darkest and shadiest side of the pond from whence I obtain my specimens, and then it is almost invariably hidden beneath other aquatic vegetation, as if its deeds caused it to shun the light. It also exhibits the same tendency to avoid particular spots which frequently is evinced by snakes in selecting only one side of a field or part of a hedge to the entire exclusion of the remainder, and by fish in choosing the dirtiest and most unlikely ditches as a spawning bed in preference to those which are cleaner and apparently in every respect better suited to the purpose.

I am of opinion that an excess of light is prejudicial to

the plant, because, if when kept in an aquarium it is exposed to the full glare of the daylight, the valves appear to lose their elasticity, and the vesicles become detached from the stem, and drop off.

Another predominating cause for this strange habit of growing in only one or two spots may perhaps be ascribed to this, that wherever I find the *Utricularia* there is always a luxuriant mass of *Confervæ* around it which harbours numberless insects, and, having no roots at any time of its life, is entirely dependent upon its vesicles for its sustenance; hence it only flourishes where prey is plentiful.

In confinement it is impossible to keep it in a healthy state unless the glass is darkened; and as nearly as possible its artificial condition is assimilated to its natural one. Where young fish are kept, it is anything but a desirable inmate of the vessel in which they are confined. One eminent piscicultural authority states that he had several

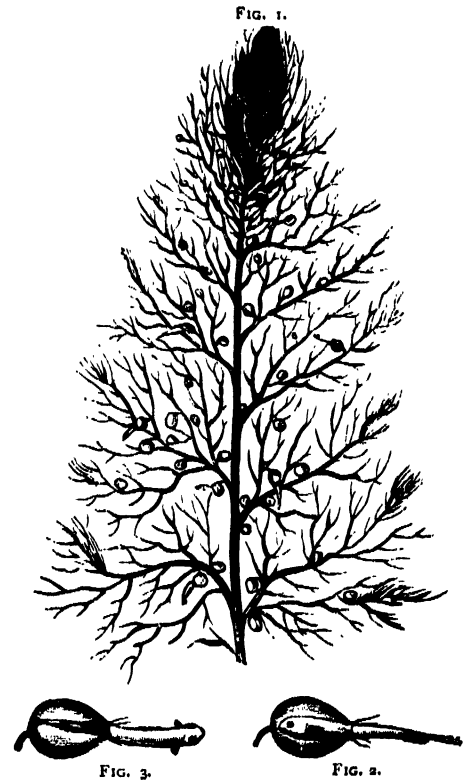

plants in his aquarium with some young axolotls, and he noticed that the small salamanders gradually disappeared; now he can give a very good guess where they went to.

My friend Mr. Kelson, who has recently had charge of my aquariums during my absence from home, agrees with me that the foliage possesses some poisonous properties detrimental to fish. Whether it does so or not I hesitate to assert, but all I know is that out of a batch of young roach placed with some freshly-gathered *Utricularia*, many of them in a little while lay dead on the branches.

With regard to its method of catching insects or anything upon which it preys, I believe that the processes are armed with tiny spines similar to the recurved teeth of a pike, or the serrations of an awn of barley, and these utilise the struggles of the creature caught to push it further on but prevent its return.

When a fish once touches one of the processes, whether



by the head (Fig. 2) or by the tail (Fig. 3), the result is precisely the same, it can never escape; and so tenacious is the grip with which it is held, that I have only once observed an insect get away after being caught. Otherwise I cannot conceive how, without some such arrangement, if the processes were perfectly smooth, they could retain anything so delicate even as the body of a young fish, much less would they be able to hold the larger creatures. I am the more inclined to this view because, when a fish emerges from the egg it is nothing but a transparent line of light, a substance without a substance, into which the most microscopically minute projection would enter without difficulty; and when it is borne in mind how easily the hair-like sting of the common nettle can penetrate the human cutis, taking into consideration the relative thicknesses of the two, I am satisfied that my argument, though open to contradiction, has at least the beauty of possessing some slight amount of probability.

I was hoping that before this I should have been in possession of several more facts concerning the *Utricularia* and its power of killing fish in a state of nature, but, unfortunately, at the time I was preparing for my observations I suffered from a severe attack of illness, which for this season at least has incapacitated me from carrying out my intentions; but I hope in the ensuing one to lay bare a few more facts concerning this new and novel enemy of the pisciculturist. G. E. SIMMS, JUN.

### KANSAS

THE authorities that govern the individual States and Territories of America show themselves well-advised when they set to work to investigate the natural history and resources of their respective possessions in a healthy and unbiased spirit, and nothing is more calculated to give confidence in the future of the State than the knowledge that the truth, the whole truth, and nothing but the truth has been presented to all who are interested, with the indorsement of well-known scientific experts. The State of Kansas, which not many years back was so exercised and torn to pieces with internecine quarrels and fillibustering forays, as to obtain the dolorous name of "bleeding Kansas," now appears before the world in very different guise—no longer bleeding, but with its wounds staunch; not restless, but peaceful, and bent on carrying out to the utmost the programme of wealth and prosperity which a careful examination of its capabilities shows us to be not only possible but assured.

The Third Biennial Report of the State Board of Agriculture is a portly volume of great value in many ways, although those points that deal with the geology and natural history will of course offer the most interest to the readers of NATURE.

From the geological sketch given by Mr. O. St. John we learn that Kansas, a parallelogram in shape, and containing no less than 80,000 square miles or 52,531,200 acres, lies wholly within the prairie region that intervenes between the Rocky Mountains and the Missouri; and although, to the ordinary observer, it appears to be an exceedingly flat region (Kansas City has only an elevation of 751 feet above the sea), there is, in reality, a gradual and regular ascent of the surface to the north-west corner, where the land assumes a maximum height of 4000 feet. What configurative irregularities there are, are principally due to erosion, as there is a remarkable absence of any geological displacement sufficient to produce mountainous folds, and thus give origin to local drainage systems. The most salient features of the landscape are bluffs (seldom above 500 feet in altitude), though in the larger valleys they are sometimes precipitous and intersected by ravines. The prevailing characteristic, however, is that of grassy uplands in billowy stretches, the drainage being provided for by numberless narrow channels called

"draws." The general drainage system is easterly, and pretty well divided between the Missouri and Arkansas basins. The northernmost half of the State is watered and drained by the Kansas River, with its tributaries, the Delaware or Grasshopper, Blue, Solomon, Republican, and Saline on the north, and the Smoky Hill on the south; and these, with a small area drained by the head waters of the Osage River, all form part of the Missouri system. The basin of the Arkansas is met with a little to the south of the Smoky Hill, the river itself having a general south-east course into the Indian territory. The volume of the Arkansas from its distant source in the Rocky Mountains far exceeds that of the Kansas, though its valley is very little deeper, nor has it such important tributaries as the latter river. About the centre of the State, the Arkansas makes a considerable bend, receiving previously the Walnut and Pawnee Rivers, while east of the bend are the upper valleys of the Neosho, Verdigris, White-water, Little Arkansas, and Cimarron, though, as a matter of fact, nearly all these streams effect their junction with the Arkansas outside Kansas, and in the Indian Territory. The Neosho is locally famous for its valuable water power and its rich agricultural valley, and the Cimarron for its deeply eroded bed and the variegated sculptured strata of its cañon walls. The two typical rivers of Kansas State are therefore the Kansas, its valley consisting of a wide belt of low-terraced alluvial land, of great fertility, bounded by beautiful slopes terminating in frequent rocky bluffs, and the Arkansas with its magnificent reaches of level bottom land, whose depth of soil is composed of travelled sediments brought from the mountains and plains lying to the westward. Here and there the border uplands encroach upon the valley, showing shelly limestone strata, and deep, iron-dyed sandstone ledges.

The geology of Kansas is of a simple nature, and almost entirely composed of three principal formations, the Carboniferous, Cretaceous, and Tertiary. The Palæozoic rocks, as represented by the Carboniferous, appear at the surface over an area of about one-third of the entire extent of the State, entering it from the south-east, and eventually passing beneath the Dakota sandstone, which is the line of demarcation between the Palæozoic and Mesozoic series. After the disappearance of the Carboniferous rocks underneath this sandstone, they are not seen again until the Rocky Mountains, where their upraised edges have been bared by denudation at the foot of the ranges. The lowest member of the Carboniferous (Lower), as seen in Kansas, is the Keokuk limestone, which occupies a small area of about forty square miles in the extreme south-east corner, and consists of bluish-gray siliceous limestone, interbedded with cherty layers above, and often associated with brecciated siliceous matter. Limited as the Keokuk area is, it is of exceeding value to the State, for it includes the ore district of lead and zinc, and has already brought a considerable population to the newly-founded towns of Empire and Galena, on the banks of the Short Creek, a tributary of the Arkansas. Not only has a busy mining district been here established, but, owing to the excellence and accessibility of the Cherokee Coal-measures, a little to the west, the ores are enabled to be speedily and cheaply reduced at the furnaces of Weir and Pittsburgh, a few miles to the north. Galena, the ordinary sulphuret of lead, furnishes almost all the ore of that metal, together with its derivatives, cerussite or carbonate of lead (the "dry bone" of the miners), and pyromorphite or phosphate of lead. As is usually the case, the lead carries a small percentage of silver, from one to one and a half ounces to the ton of ore. The zinc ores consist of the common blende or sulphuret, "black jack," calamine (hydrous silicate), smithsonite (carbonate), and zinc bloom, many of the ores being of great beauty, from their amber and garnet tints. Associated with the ores are chalcopyrite or copper pyrites, green carbonate of copper,

bisulphuret of iron or mundic, calcite or "glass-tiff," dolomite, quartz, and bitumen. The base rocks of the district consist of a deposit of limestone 100 feet in thickness, charged with characteristic Keokuk fossils, which, however, are much comminuted and splintered, and bear evidence of the pressure and tension to which the strata have been subjected. The Kansas ores are similar in almost all parts to those of the Missouri district, and it is considered quite possible that time will reveal the existence of other ore-bearing strata.

The large area of Upper Carboniferous series may be roughly divided into Upper and Lower Coal-measures, the latter occupying between 4000 or 5000 square miles, and passing, in the west, conformably beneath the Upper Measures. The series is largely made up of shales and sandstones, with occasional thin beds of limestone and iron ores, but its chief economic value consists in possessing workable beds of coal. These are mostly distributed in the lower 400 feet of strata, and are somewhat irregular and variable in thickness. Some of the coals indeed are found in little isolated basins or pockets, filling trough-like depressions surrounded by ledges of the older formation; but as a rule, the thinner coal-beds are remarkable for their persistence over a large extent of ground. The Cherokee coals are of a very superior quality, and they (together with most of the Kansas lower beds) contain less sulphur than the coals of either Illinois or Iowa. Naturally there is a great demand for coking purposes and local consumption, while pretty heavy shipments are made to the towns and cities on the Missouri River. These Lower Coal-measures also contain excellent building-stone and hydraulic limestone, which is extensively utilised for making cement. The general inclination of the strata is north of west, with a dip that seldom exceeds 10°. The estimate of the Lower Coals, from an aggregate thickness of four feet, is 20,000,000 tons, and if the area be extended to that occupied by the overlying Upper Measures, so as to reach the Lower Coals accessible from 500 to 1000 feet, the product may be fairly estimated at double.

The Upper Coal-measures have an aggregate vertical thickness of at least 2200 feet, the exposed area extending for 24,000 square miles; but in the character of the component strata they present a marked contrast to the Lower series, on account of the limestone ledges which form such striking features in the landscape. The lower beds are characterised by frequent and thick deposits of gray limestone, succeeded in the middle portion by darker, rusty, weathered ledges, and in the upper by light, buff-gray rock. The sandstones occur in some half-dozen well-developed horizons along the line of the Kansas valley, usually in the condition of arenaceous shales, and affording local supplies of building and flagging stones. In Osage County these have an additional interest, as being marked with casts and tracks of gigantic Batrachians. The limestone beds are somewhat deteriorated for building purposes by cherty deposits, but, on the other hand, they contain ironstone nodules of hæmatite and carbonate ores, with crystals of sulphate of lime and beds of massive gypsum, varying in thickness from five to fifteen feet. These gypsum deposits are capable of affording inexhaustible supplies, which are used most beneficially as manure for the soil. Where the cherty concretions are not met with, the limestone beds yield magnificent building-stone, the texture and colouring of which can be seen to great advantage in the State House of Topeka and many other public buildings. The Upper Coals are distinguished from the Lower by their more brittle texture and a larger percentage of ash and impurities. Though there are several valuable and persistent seams, such as the Blue Mound and Osage coals, thinness is a decided characteristic of the Upper Measures, few, if any, being above thirty inches, and the greater number not exceeding ten inches. But, although the Upper Measures are clearly

of not so much economic importance as the Lower, it is quite possible to reach the Lower by tolerably deep borings through the Upper, and indeed this has been already successfully demonstrated.

The Mesozoic age in Kansas is represented solely by Cretaceous formations, which, however, occupy the largest area of any in the State, being no less than 40,000 square miles. The series is composed of three divisions, viz. the Dakota, Benton, and Niobrara, all belonging to well-recognised lower members of the Cretaceous rocks of the Upper Missouri region. The Dakota beds consist of sandstone interbedded with variegated shales, with occasional layers and pockets of impure coal. The sandstones are permeated and deeply stained with ferruginous matter, the iron being often concentrated around nuclei, forming singularly-shaped concretions. The proximity to the ancient land area is denoted by the rather extensive fossil flora usually found in these concretions, but the fauna is more limited in variety, comprising, so far, a few fishes, a large Saurian, and several species of Mollusks. The sandstones vary lithologically, but are usually compact and often intensely hard, forming highland ridges marked by rugged and picturesque features. Less is known of the Benton beds than of the other members of the series. They consist of argillaceous and calcareous shales, with thin layers of limestone, overlaid by dark-coloured shales, but good exposures of these rocks are rarely found. They have, however, yielded to the palæontologist several Saurians, while the limestones are frequently charged with fine ammonites, the shells of *Invoceramus*, the gigantic *Haploscapta*, and myriads of the little *Ostrea congesta*. The Niobrara beds are the most important of the Kansas Cretaceous formations, and offer much better-marked horizons. The lower portion shows alternations of fragmentary limestone and shales, which above pass into shelly limestone, and, in some localities, into chalky limestone. All these layers are charged with a wonderfully numerous and varied Vertebrate fauna, allied to forms which are common in the Colorado shales of the Rocky Mountain region, and consist of remains of Teliosts or common bony fishes, sharks, Saurians, and an extraordinary species of bird, whose jaws are armed with teeth. The mineralogist will also be interested in these beds, as furnishing beautiful examples of selenite crystal. From a landscape point of view, also, the Niobrara beds are instructive, as they are frequently intersected by miniature cañon labyrinths, and exhibit varieties of monumental forms detached by the erosion of the valleys, some of these, composed of a coping of limestone and a shaft of chalk and compact shale, rising from 20 to 70 feet in height. In an economic sense the Cretaceous series is of considerable value. The Dakota deposits contain three beds of lignite, the Benton shales yield quantities of septaria, used for making the finer qualities of cement, together with excellent chalk applicable for whitening, while the Niobrara beds furnish vast supplies of pure lime. All the divisions yield excellent building-stone, and throughout the formation a productive supply of salt occurs, from the brines of which there is already a brisk annual trade of 35,000 bushels.

The most recent formation of Kansas is principally in the north-west of the State, where there is a Kainozoic area of Pliocene beds of about 11,500 square miles, extending thence from Colorado and Nebraska, where a vast stretch of country is occupied by the White River formation. Its typical features are loosely-aggregated sands, more or less calcareous, forming irregular strata of brown and gray sandstone, while in some places siliceous beds occur, associated with several varieties of chalcedony, and containing fragments of the tusks of a very large mammal. The fauna is most interesting in this respect,—beaver, rhinoceros, camel, deer, wolf, and turtle being all represented. The district is noted for its eroded mounds and columns, the most striking being the Sheridan *Buttes*, which rise in perfect

isolation to 200 feet above the Smoky Hill River, the summit capped by a heavy ledge of light gray, very hard siliceous rock, which has been weathered into miniature grottoes in the higher of the two cones. Underlying the Pliocene beds is a thick deposit of chocolate-coloured shales, with concretionary masses of limestone and septaria, and splendid crystals of selenite. Among Post-Tertiary deposits, examples are to be found, in the eastern portion of the State, of the Drift and Loess, the latter being strikingly displayed in the bluffs that bound the Missouri River valley for so many hundreds of miles in the States of Iowa, Nebraska, Kansas, and Missouri.

An appendix to the foregoing geological account is added on the botany of Kansas, by Prof. J. H. Carruth, but it is very short, for the reason that the catalogue of Kansas plants was made in 1880, and the present notice is merely to record certain additions (about 36) to the 1430 plants already found, of which only 30 are non-flowering. Considering that New York, with its varied surface and qualities of soil, can only show 1450, it is most interesting to note that Kansas, with its comparatively uniform soil and surface, produces almost as many.

A valuable report on the Kansas entomology is given by Prof. Popenoe, who furnishes detailed accounts of certain insects that commit ravages upon the crops. Among these figure prominently the large poplar-borer (*Plectrodera scalator*), which is a great tree-destroyer, making innumerable holes in the trunks of the willow and cottonwood. A singular fact is recorded of the buck moth (*Hemileuca maia*), viz. that as a larva it possesses a peculiar means of defence. The coarse, black prickles with which the body is covered are very sharp, and when they penetrate the skin on the back of the hand or elsewhere, they produce little pustules and a sharp nettle-like sting, though not of any duration. The red-lined tree-bug (*Lygaeus trivittatus*) is a relative of the well-known squash-bug, and does infinite damage to the elder-tree, besides evincing a strong partiality for the interiors of greenhouses, where it destroys geraniums, ipomceas, abutilons, and other horticulturists' pets. The chequered snout-beetle (*Aranigus tessellatus*) has usually been known to infest leguminous plants, and more especially the silver-leaved prairie pea (*Psoralea argophylla*). Latterly, however, it has been noticed to pay great attention to the sweet potato, and has inflicted considerable havoc on that crop. The harlequin cabbage-bug (*Strachia histrionica*) attacks the Cruciferae, and especially the wild cress (*Lepidium*), mustard, radish, turnip, and cabbage. The abundant little beetle known as the corn-root worm (*Diabrotica longicornis*) has only recently been discovered to be a corn-pest of the first magnitude, attacking the roots about the period of "earring," and causing a partial development of the grains.

Though only the points that bear most on Kansas natural history have been noticed here, it should be stated that the volume gives an exhaustive account of the resources and statistics, commercial, social, and educational, of each county in the State, and that the whole is illustrated by an admirable series of maps.

G. PHILLIPS BEVAN

### NOTES

THE death is announced of Ferdinand von Hochstetter, the German mineralogist and geologist, whose name is intimately associated with the geology of New Zealand. Hochstetter was born in Würtemberg in 1829. In 1857 he joined the *Novara* expedition, but quitted it at New Zealand, the geology of which he spent a considerable time in investigating. In 1860 he was appointed Professor of Mineralogy and Geology in the Polytechnic Institute of Vienna, and in 1867 was made President of the Vienna Geographical Society. Among his published works are: the "Topographico-Geological Atlas of New Zealand";

"Geology of New Zealand"; "Palaeontology of New Zealand"; "The Geology of the *Novara* Expedition"; "Rotomahana and the Boiling Springs of New Zealand"; besides works on the geology of Eastern Turkey, the Ural, and various popular publications.

IN the name of fair criticism, in the interests of true science, and in defence of a man who has grown gray in the public service, and who has recently retired full of years and honour to the rest he so well merited, a protest should be made against the language in which the *Mining Journal* last week permits itself to speak of Mr. Robert Hunt, F.R.S. We do not choose to discuss the relative merits of the new "Mineral Statistics" and those with which his name is so familiarly conjoined. But by all who know how entirely Mr. Hunt's heart and soul were in his work at the Mining Record Office and how unwearied were his labours on its behalf, an emphatic and indignant repudiation will be made of the charge brought by the anonymous critic that he failed to do his duty and set a bad example to his subordinates. Mr. Hunt needs no defence from such an odious charge. We cannot but express our regret that it should have been made in the columns of a respectable journal and under cover of an anonymous review.

WE are still a long way from admitting that a little elementary physiological knowledge is a desirable element in general education. But it is not often that such a glaring example of the want of it is met with as is revealed by the following extract from a despatch of the Acting Consul at Panama recently presented to Parliament. It would not be easy to find its parallel among the worst answers in the May examinations of the Science and Art Department:—"Many essays have been written on this appalling scourge [yellow fever], its origin, and its existence, but nothing seems more probable, more reasonable to me, than comparing the human blood to milk, which under influence of temperature and circumstances becomes curdled. In the like manner, the human blood, the human frame and organism, under certain abnormal, adverse, and unfavourable circumstances, become curdled, and enter into a state of dissolution, more or less rapid; the blood, owing to its component parts, coagulates, being impregnated with bile, phosphate, and albumen, through the stagnation of the liver and kidneys. This my theory is the one I certainly believe in. *Savants* assert that the disease is generated by spores of the marine mushroom (*Mycenium Jungi maris*), which multiply in thousands per minute. Others profess it to be animalculæ termed 'microbes.'"

MR. JOSEPH THOMSON, the leader of the Geographical Society's expedition to East Africa, has arrived in this country. Mr. Thomson has suffered greatly from the hardships which he had to endure, and it will be several weeks before he regains his usual vigour. Mr. Thomson's expedition has been completely successful, and he himself estimates the results as of far greater scientific importance than those of his first expedition. The region traversed by him, from Mombassa to the north of Victoria Nyanza, is entirely volcanic, and his observations therein will be of great geological interest. There is still one volcano, west of Kilimanjaro, which shows signs of activity. Mount Kenia, though covered with trees, stands amidst a desert. The Masai, the leading people of the region explored, are of special interest. Their features, customs, dwellings, religion, language, differ markedly from those of any other African people with whom Mr. Thomson is acquainted. Fortunately besides his copious notes he has brought home many photographs, so that his forthcoming narrative is sure to be of unusual interest and value.

THE Conference on Water Supply by the Society of Arts will be held at the Health Exhibition to-day and to-morrow. The Conference will meet each day at 11 a.m., and will sit till 1.30, then adjourn till 2, and sit again till 5 p.m. The papers and

discussions will be arranged under the following heads:—1. Sources of Supply. 2. Quality of Water; Filtration and Softening. 3. Methods of Distribution; modes of giving pressure, house fittings, discovery and prevention of waste, &c., &c. The proceedings will be continued on Friday, and if necessary on Saturday. The readers of papers will be restricted to twenty-five minutes. Speakers will be restricted to ten minutes. The papers to be read will, in most instances, be printed and distributed in the room.

LORD REAY has received additional names of foreign delegates to the International Conference on Education from Austria, Baden, Belgium, France, Netherlands, and Switzerland. Prussia and Denmark contribute reports on the state of education in those countries. Lord Carlingford will preside at the opening meeting on August 4, at 11 a.m.

AT the request of the Council of the British Association for the Advancement of Science, Admiral Sir Erasmus Ommanney, C.B., F.R.S., has consented to act as Treasurer during the meeting at Montreal, Canada. We learn that Prof. W. G. Adams of King's College will be unable to give the Friday evening lecture at Montreal, and that Prof. O. J. Lodge will take his place. The subject of Prof. Lodge's lecture will be "Dust." Prof. Bonney sails for Montreal to-day.

THE death is announced of the Swedish chemist, Prof. Sten Stenberg, born in 1825.

ACCORDING to a note contributed to a recent number of the *China Review* by M. A. Fauvel of Hankow, the Foreign Office and the authorities at Kew are anxious to know the name of the tree from which the well-known tea-chests are manufactured. The Chinese name is of little use for classification, as it applies to the *Acer*, *Liquidambar*, and perhaps to other species. A branch of the tree and some old leaves and fruits were submitted to M. Fauvel, but the fruits had lost their seeds, and the leaves were too old and decayed to be considered as good specimens for identification. But at first sight he recognised the fruits as those of a *Liquidambar*; the leaves were all trifid, palmately nerved, some slightly serrated, some with a smooth edge. But they were too old to show any signs of gland in the serration. They differ from those given to the *Liquidambars* in general, and from the *L. Orientale* and *L. Chinensis* varieties. M. Fauvel thinks the wood may belong to the *L. Formosana*, but must defer any definite opinion until the leaves and flowers are out. It is somewhat curious that there should be any mystery at this time of the day about so common a substance as the wood of a Chinese tea-chest.

THE last number (16) of the *Excursions et Reconnaissances*, the official publication of the Colonial Government of Cochin China, contains as usual several papers of scientific interest on that region. The first is a report by two engineers, MM. Viénot and Schröder, of a survey undertaken for railway purposes of the country from Haiphong to Hanoi. The first part of the line from Haiphong to Haidong is about 45 km. in length, and the writers of this report describe the physical features of the district, the courses of the rivers, the villages, towns, and cities, the various productions—in short, everything bearing on the question of the construction of a line through the place. This is followed by a translation of a Chinese work on the mines of Cochin China, from which it appears that useful and precious metals are to be found there, and were at one time worked with success, although owing to the defective native methods the work had to be given up. M. Aymonier also contributes some interesting notes on the customs and superstitious beliefs of the Cambodians.

ACCORDING to the *Japan Weekly Mail*, the meteorological system of Japan now comprises twenty-three observatories in the

most important places throughout the country. Reports are sent from each district to the central observatory in Tokio three times a day, and are there thrown into suitable form for publication by the leading journals in the capital and the open ports. To a German, Dr. E. Knipping, belongs the credit of elaborating and perfecting the whole system. In China, the Shanghai Chamber of Commerce has also assisted Père Dechevrens in his meteorological work by making him an annual grant of about 300*l*.

A RECENT writer in the *North China Herald* discusses the part played by mercury in the alchemy and *materia medica* of the Chinese. Cinnabar was known to them in the seventh century before the Christian era, and its occurrence on the surface of the earth was said to indicate gold beneath. Their views on the transformation of metals into ores and ores into metals by heat and other means took the form of a chemical doctrine about a century before Christ, and there is now no reasonable doubt that the Arabian Geber and others (as stated by Dr. Gladstone in his inaugural address to the Chemical Society) derived their ideas on the transmutation of metals into gold and the belief in immunity from death by the use of the philosopher's stone from China. Among all the metals with which the alchemist worked, mercury was pre-eminent, and this is stated to be really the philosopher's stone, of which Geber, Kalid, and others spoke in the times of the early Caliphs. In China it was employed excessively as a medicine. On nights when dew was falling, a sufficient amount was collected to mix with the powder of cinnabar, and this was taken habitually till it led to serious disturbance of the bodily functions. In the ninth century an Emperor, and in the tenth a Prime Minister, died from overdoses of mercury. Chinese medical books say it takes two hundred years to produce cinnabar; in three hundred years it becomes lead; in two hundred years more it becomes silver, and then by obtaining a transforming substance called "vapour of harmony" it becomes gold. This doctrine of the transformation of mercury into other metals is 2000 years old in China. The Chinese hold that it not only prolongs life, but expels bad vapours, poison, and the gloom of an uneasy mind.

THE Peabody Institute of the City of Baltimore is an educational institution founded in his native city by the rich philanthropist, and worked for the advantage of a rather higher class of students than those of the ordinary free library. It combines under one government, as we have before urged the advantage of combining, the library, the lecture-room, music, and art, besides an annual expenditure in prizes for certain schools in Baltimore; and each department is managed by a sub-committee so small as to make every member of it probably feel himself greatly responsible for its success. The lecture committee provided six lectures each upon "The Sun and Stars," and "The Yosemite Valley," &c., and four lectures each upon "The Crusades," "The Minds of Animals," and "Shakespeare's Plays," all except the last assisted by illustrations. These formed a series of two lectures weekly during the four winter months, and season tickets were sold at a price not much exceeding threepence a lecture, the expense to the Institute being about 100*l*. The Conservatory of Music sets itself a high ideal, and claims considerable success. It employs five professors of music, who have had 160 pupils under them, but no pupil reached the level of earning their diploma. A series of fifty-one lectures, concerts, and rehearsals were given, to all of which annual subscribers are free at a small cost similar to that of the lectures, with a charge upon the Institute of about one-seventh of the entire amount spent in the cultivation of music. Upon a Gallery of Art open for eight months during the year, and helped by a loan of pictures, the Trustees were unable to spend any capital sum, and the expenses were limited to the care-takers. Over 1200 dollars were spent according to

Mr. Peabody's will in premiums and medals given to four schools in Baltimore. The library, however, is the object of largest expenditure, and aims at being a high-class one in every respect, 12,000 dollars, or one-quarter of the entire expenditure, having been laid out in the purchase of books. Important and uncommon works are added, supplying the demands of scholars for minute information. Such students are its most numerous users, and there were but few works of fiction among the 2700 volumes added during the past year. The library now reaches a total of 82,000 volumes. A catalogue of these is being compiled, the first volume of which, heartily recommended by many scholars and bibliographers, and already leading to greater use of the library periodicals, contains 868 pages and 61,184 references, yet only takes in A-C. We are told that it is offered under cost price at seven dollars to subscribers, but the Provost's remark which follows, that, besides being very expensive, "it is not desirable to sell many copies," shows how little the Institute aims at popularity. And in no department, truly, can this be boasted of! The lectures seem to have been the most successful. The Report observes that the annual members of the Conservatory of Music ought to rise to 400 or 500 instead of 87; and 70 visitors a day is not many, out of a population of nearly 400,000, to the Gallery of Art. Less than 60,000 issues have been made out of the great library, and the Provost thinks that the public will be surprised to hear that a total of 100,000 persons have visited the buildings for its various purposes during the year! These numbers show how, in America as well as in England, a small rise in requirements brings one into a much rarer, less crowded stratum of society. However, in all departments increased interest and "remarkable progress" are reported, which we trust may increase tenfold.

At a meeting of the Vaccination Officers' Association held on Saturday last, a cordial vote of thanks was given to the National Health Society for issuing their pamphlet entitled "Facts concerning Vaccination," and the Association expressed their appreciation of "the thoughtful kindness which prompted the Society to assist the vaccination officers of the metropolis in the discharge of their often difficult duties." We are informed that the pamphlet in question has now been distributed from house to house in most of the districts in the metropolis where small-pox is epidemic, and that the demand for it still continues. Something like 150,000 copies have already been issued since the present epidemic began.

As a supplement to our note of a meteor seen on the west coast of Norway on May 27 (p. 200), it will be interesting to read the following particulars supplied by Mr. Gjestland, residing at Tysnas, in the province of Bergenhus. This gentleman states that he too saw the fire-ball a little after eight o'clock, and subsequently heard a report as of distant rolling thunder. A couple of days after he happened to be on a farm, Midtvaage, in Onarheims parish, where a woman told him that she had seen the "ball" fall a few feet from the house. On learning this Mr. Gjestland, in connection with the parish engineer, began a search in the direction indicated, and discovered, in a spot where the turf covers the mountain ridge to a depth of about 20 cm., a hole where the turf and mould had been as it were blasted away from the rock, and in it a handful of pulverised stone, which, however, in every respect seemed to resemble the mica schist of the mountain. Two days after he learnt that a girl on the same farm had found a very peculiar stone near the same spot, which was thought to be the one searched for. Mr. Gjestland at once proceeded to the farm, and has succeeded in obtaining the valuable specimen. He states that in shape and size it is like the fourth part of a large Stilton cheese, cut vertically from the centre to the side. The height as well as the diameter is 20 cm. A fresh fracture on the surface shows that a bit has been broken

off, probably by striking the rock, while the other side shows an uneven, undulating surface partly polished. The exterior is sooty and dark in colour, indicating that it had been exposed to great heat, whilst the interior is grayish brown and interspersed with bits of metal having the appearance of iron, some of which are 1 mm. in length. The block has a considerable specific weight, resembling that of iron-stone, is brittle, and may be cut with a knife. The weight is 19.5 kilos.

ON July 3, at 9.32 p.m., a brilliant meteor was seen in Stockholm, crossing the sky from south-east to north-west, about 25° from the zenith. The colour was first red, then yellow and green, and became finally white as the meteor parted into halves about 45° above the horizon. It afterwards burst into fragments. When at its point of culmination, the meteor had the appearance of a kernel about a third of the moon's disk in size, with a trail of about the same width and ten times the diameter in length. The whole lasted about four seconds.

THE French Northern Railway Company have begun experiments on motive power generated by electricity at the Chapelle Station. The Company have established an electric lift with two Siemens electro-magnetic machines, one for elevating the weight, and the other for moving the machinery alongside the railway.

DURING the night of July 19 an earthquake was felt at Agram. It lasted four seconds, and was accompanied by subterranean rumblings. No damage was done.

AN unknown benefactor recently offered to give 100,000 marks to the University of Heidelberg, on condition that ladies should be permitted to study there. The University has declined the offer.

THE additions to the Zoological Society's Gardens during the past week include a Rhesus Monkey (*Macacus rhesus* ♂) from India, presented by Mrs. A. Edwards; a Gray Ichneumon (*Herpestes griseus*) from India, presented by Lieut. A. H. Oliver, R.N.; a Short-toed Eagle (*Circæus gallicus*), South European, presented by Mr. W. R. Taylor; a Bronze-winged Pigeon (*Phaps chalcoptera*) from Australia, presented by Mr. J. Latham; five Natterjack Toads (*Bufo calamita*), British, presented by Mr. W. Stanley; three Striolated Buntings (*Emberiza striolata*) from Africa, deposited; a Four-horned Antelope (*Tetracerus quadricornis*) from India, a Maccarthy's Ichneumon (*Herpestes maccarthii*) from Ceylon, three Common Squirrels (*Sciurus vulgaris*), British, six Aldrovandi's Lizards (*Plestiodon auratus*) from North-West Africa, purchased; two Virginian Deer (*Cariacus virginianus*), an Argus Pheasant (*Argus giganteus*), bred in the Gardens.

#### OUR ASTRONOMICAL COLUMN

BRORSEN'S COMET OF SHORT PERIOD.—We are now within about two months of the probable time of the next perihelion passage of this comet, and after the middle of August, when the moon draws away from the morning sky, it may be within reach. So far, however, no ephemeris for this return has been published. The perturbations since its last appearance in 1879 will not have been very material, and the mean motion in that year would fix the approaching perihelion passage to about September 14.5 G.M.T. If the longitudes in Dr. Schulze's orbit for 1879 are brought up to 1884.75, the following expressions for the comet's heliocentric co-ordinates result:—

$$\begin{aligned}x &= r \cdot [9.94286] \cdot \sin(\nu + 207.56.7) \\y &= r \cdot [9.98506] \cdot \sin(\nu + 126.22.0) \\z &= r \cdot [9.73705] \cdot \sin(\nu + 60.33.4)\end{aligned}$$

Taking September 14.5 for the epoch of perihelion passage, the comet's approximate positions are:—

12h. G.M.T.	R.A. h. m.	Decl.	Distance from Earth Sun
August 16 ... 7 7 <sup>7</sup>		+ 8 8 ...	1 <sup>282</sup> ... 0 <sup>815</sup>
18 ... 7 20 <sup>0</sup>		8 46	
20 ... 7 32 <sup>5</sup>		9 25 ...	1 <sup>280</sup> ... 0 <sup>766</sup>
22 ... 7 45 <sup>2</sup>		10 2	
24 ... 7 58 <sup>0</sup>		10 37 ...	1 <sup>284</sup> ... 0 <sup>720</sup>
26 ... 8 11 <sup>0</sup>		11 10	
28 ... 8 24 <sup>2</sup>		11 40 ...	1 <sup>295</sup> ... 0 <sup>679</sup>
30 ... 8 37 <sup>5</sup>		12 8	
September 1 ... 8 51 <sup>0</sup>		+ 12 33 ...	1 <sup>312</sup> ... 0 <sup>644</sup>

If we suppose an acceleration of four days in the time of perihelion passage, the effect on the geocentric position is—

	R.A.	Decl.
On August 16, in R.A.	+ 15 <sup>1</sup> .	in declination + 2 <sup>1</sup>
On " 28, " "	+ 16 <sup>7</sup> ,	" + 1 <sup>41</sup>

The theoretical intensity of light expressed in the usual manner would be 0<sup>92</sup> on August 16, and 1<sup>40</sup> on September 1.

During the above period; with the places assigned, the comet would rise at Greenwich from 2h. 10m. to 2h. 20m. before the sun. In 1873, when the circumstances approached nearest to those of the return in the present year, the comet was detected at Marseilles on the morning of September 2, the distance from the earth being 1<sup>02</sup>, and that from the sun 0<sup>94</sup>, the intensity of light 1<sup>08</sup>. At its last appearance in 1879 it was seen by Tempel at Arcetri, on January 14, when the intensity of light was only 0<sup>13</sup>, an exceptional case, since at no previous appearance had it been observed under a less value than 0<sup>33</sup>.

From the first discovery of the comet in 1846 by Brorsen, an astronomical amateur at Kiel, the period of revolution has gradually diminished from the effect of the planetary perturbations; subjoined are the times of perihelion passage in those years when the comet has been observed, and the sidereal periods corresponding to those times:—

Year	Month	Time	G.M.T.	Days
1846	February	25 <sup>37</sup>		2034 <sup>1</sup>
1857	March	29 <sup>25</sup>	"	2022 <sup>7</sup>
1868	April	17 <sup>41</sup>	"	2002 <sup>4</sup>
1873	October	10 <sup>48</sup>	"	1999 <sup>4</sup>
1879	March	30 <sup>54</sup>	"	1994 <sup>9</sup>

From its unfavourable position the comet was missed at its returns in 1851 and 1862. It is well known that the present orbit is due to the action of the planet Jupiter in 1842: at the perihelion passage at 6 p.m. on May 27 in that year the comet's distance from Jupiter was 0<sup>0547</sup> of the earth's mean distance from the sun; consequent upon this near approach, the inclination of the orbit in which it previously moved was diminished nearly 15° according to the calculations of Dr. Harzer, who has very fully investigated the circumstances. It is probable that there had been a great perturbation of the elements from the same cause in 1759-60, and that in 1937 (according to D'Arrest) this may again occur.

THE BINARY-STAR  $\beta$  DELPHINI.—Dr. Dubjago, of the Observatory at Pulkowa, has published a first orbit of this star, the duplicity of which was discovered by Mr. Burnham in 1873; more than 180° of the orbit have been described since that year. The period found is 26<sup>07</sup> years, the periastron passage at 1882<sup>19</sup>. After that most rapid of all the known revolving double-stars  $\delta$  Equulei, to which Mr. Burnham attributes a period of only 10<sup>8</sup> years, there is only one,  $\alpha 2$  Comæ Berenicensis, that has a shorter revolution attached to it, and  $\beta$  Delphini may be eventually proved to have the less period. In 1873 Mr. Burnham estimated the distance of the components 0<sup>7</sup>; they have since closed until the star has been beyond the powers of any but the largest telescopes. Dr. Dubjago's elements assign for 1884<sup>6</sup> position 219<sup>4</sup>, distance 0<sup>28</sup>.

RED SUNSETS<sup>1</sup>

THE equatorial diameter of the earth is 7901 miles and the circumference is 24,825, and as she revolves once on her axis in twenty-four hours, a place on the equator moves through 1034 miles in an hour: but at any depth beneath the surface the velocity is less in proportion to that depth; in like manner, if we look on the atmosphere as part and parcel of the earth, at a certain height the velocity is greater in proportion to that height.

<sup>1</sup> Paper read by Alexander Ringwood at an ordinary meeting of the Canterbury Philosophical Institute, New Zealand, on May 2, 1884.

seven or eight months with the beautiful phenomena of coloured suns and brilliant sunsets; and the liveliest interest has been exhibited as to their origin. Lockyer was the first, I believe, to point out the fact of the phenomenon of coloured suns appearing first in the east and then gradually shifting to the west. He traces them to Panama, and speaks of them as having been seen on a north-south line; but it strikes me that after leaving Panama the phenomenon passed still further westward, was seen on September 3, 4000 miles west of Panama, and at Honolulu on September 5, and struck India and Ceylon on the 8th, thus performing more than a complete circuit of the globe; moreover, I am of opinion that it may be traced still further westward, where it was seen in lat. 24° 6' N., long. 140° 29' W., by Capt. Penhallow of the barque *Hope*, on September 25, having then performed 2½ revolutions of the globe.

All the information that I have collected, and from which I have compiled the following tables, has been obtained from NATURE. The time column has been deduced from the time and date of the phenomenon appearing at the different stations, reduced to Krakatoa time; in some instances great difficulty has been experienced, especially in reference to the time at Maranh in Brazil, and at Trinidad, and it has been concluded that at those stations the times are late, because it was seen at Panama before the time given at them, which we suppose to be an error. Likewise in the case of the Gold Coast, in one place the date given is August 30, and in another September 1, but from the general result it would appear to have reached that locality about midnight August 30-31.

The tables, I trust, are sufficiently clear; the first column of miles represents the mean diurnal velocity that the cloud travelled at between Krakatoa and the different localities en route; and in the subsequent columns are given the same from each station in rotation. Of course it will be understood that a small error of an hour or two in the time at the stations comparatively close to the eruption would make a large difference where we show the diurnal velocity; and as I have had only a week's notice to prepare this paper, I trust that any errors that may be hereafter found will be treated with that consideration.

TABLE I.—Showing the Mean Diurnal Velocity in English Miles of the Phenomena of Coloured Suns and Brilliant Sunsets in the Northern Hemisphere

	Java	Seychel	E. Coast of Afr.	Gold Coast	Maranh	Trinidad
Seychelles ... ..	45	1802				
E. Coast of Africa ...	58	1817	1873			
Gold Coast	4	1846	1960	1932		
Maranh	5	2020	1950	1896	1904	
Trinidad ...	54	1968	2080	2040	1940	2176
Panama ...	64	2059	2040	2176	2324	1930
4000 miles W. of Panama	84	2061	2424	2210	2493	2370
Honolulu ...	94	1900	2084	2080	2036	1909
India ...	124	2162	2278	2192	2328	2212
Lat. 24° N., long. 140° 30' W. ...	293	2132	2246	2206	2268	2165
Arithmetical means...		1976	2105	2091	2185	2127
True mean... ..		2095				

Arithmetical mean for Northern Hemisphere 2105 miles per day.

The true mean of the first column, viz. that under the head of Java, is obtained by adding the distance between Krakatoa and each separate station together, and dividing the aggregate by the gross total number of days. The way by which the distance between any two stations is derived is by multiplying the difference in degrees of longitude by the value of a degree in English miles for the mean latitude of the two places. It must be remembered that between India and the last-named locality on the list the dust cloud is supposed to have performed over a revolution and a half of the earth.

I place great confidence in the result obtained from the observations deduced from India, because there there are scores of trained meteorological observers whose duty it is to immediately report any phenomena that may take place, and such as that concerning which I speak could not have escaped their immediate

notice; so we may conclude that the hour of its arrival there is very accurately determined, which gives a mean daily velocity of 2162 miles; and taking the velocity from its journey and a half round the world, from India to lat.  $24^{\circ}$  N., long.  $140\frac{1}{2}^{\circ}$  W., we find it to be 2192 miles per day, or 30 miles only in excess of the other computation. But if we take the whole journey from Krakatoa to that locality, about  $2\frac{1}{2}$  revolutions round the globe, we find the mean to be 30 miles less than the first, or 2132 miles, and that will be accounted for through the diminished value of the degree in longitude at the mean latitude between Java and lat.  $24^{\circ}$  N., long.  $140\frac{1}{2}^{\circ}$  W.

The mean diurnal velocities obtained from the intermediate stations, between Java and India, agree very closely; when we consider that at those several places the phenomenon was wholly unexpected, and thus in most instances the dates and times given appear to be somewhat late, it is quite possible and natural that it escaped notice at least once; in India, however, we may conclude that they were on the alert, and consequently the mean velocity deduced from that place ought to bear great weight. There is another thing that ought not to be lost sight of, viz. that without this list of stations, more than encircling the globe, one might suppose that the cloud after leaving Krakatoa stretched away westward, and as I gather from Lockyer's paper by his north-south line, to have extended to the north and south, forming a letter V with the apex at the Straits of Sunda. Now Lockyer tracks it to Panama, to which place we see it to have had a diurnal velocity of 2059 miles, and from Panama to India I made it 2200 miles per day, which makes me believe that the cloud was performing a spiral path northward round the globe.

Before proceeding I will now turn to the observations in the Southern Hemisphere, in order to see whether the same has taken place there. This table has been prepared in like manner to the former, viz. the dates and times are reduced to that of Krakatoa, and the distances in English miles obtained from the difference in degrees of longitude reduced to the value of the mean latitude of the two places.

TABLE II.—Showing the Mean Diurnal Velocity in English Miles of the Phenomena of Coloured Suns and Brilliant Sunsets in the Southern Hemisphere

	Time from Java to	Java	Mauritius	Adelaide	Cape of Good Hope
	hours				
Mauritius ... ..	44 days	1680			
Adelaide ... ..	$21\frac{1}{2}$	2041	1980		
Cape of Good Hope	24	2082	2047	2010	
Christchurch ... ..	$29\frac{1}{2}$		1990	2120	2070
Arithmetical means		1984	2005	2065	2070
True mean		2100			

Arithmetical mean for Southern Hemisphere 2031 miles per day.

The marked similarity between these two tables is most striking, and, as in the first table, the greatest discrepancy is found between Krakatoa and Mauritius, where the data are reckoned in so many hours, in which case an hour or two makes a material difference in the diurnal velocity. At present I cannot find any station reporting the phenomenon between Mauritius and Adelaide, but we may conclude that after it passed Mauritius it crossed Africa, the South Atlantic, and South America, whence we may expect to hear of it, as there are many competent observers in that part of the world; it then traversed the great South Pacific Ocean and North Australia, and after performing another such journey round the world, but in a higher latitude, was seen at Adelaide in South Australia about September 17.

Good Hope on September 20. It again crossed the South Atlantic and South America about the latitude of Buenos Ayres, and a third time traversed the South Pacific, striking the coast of New Zealand on September 25, the date of my first seeing it; on which occasion the western sky at sunset presented all the colours seen in the pearl-shell. Since then the western and eastern skies have presented those beautiful crimson tints that have delighted the world, and on many occasions I have seen it almost in the zenith two hours after sunset. During some

evenings it has quite illuminated the western face of buildings with a bright glare as from a fire, whilst on others it has been very faint and sometimes not discernible: giving to my mind the idea of its not being a continuous band but a series of dust clouds with clear spaces between.

From an investigation of the two tables it will be seen that the mean diurnal velocity in the Northern Hemisphere was, during the first revolution, about 2162 miles, and during the second it increased to 2192, or 30 miles per diem extra. And the same increased velocity is observed in the Southern Hemisphere, where we find the approximate velocity during the first two revolutions, viz. on its reaching Adelaide, to be 2041, whereas during the next revolution from Adelaide round to New Zealand it was 2120 miles, or an increase of 80 miles per day. It will be further noticed that in the Northern Hemisphere the time occupied in its first revolution was about eleven days, and the same rate is observed during the next revolution and three-quarters, or, in other words, within the tropics it encircled the world in eleven days. It is the same within the southern tropics, where it took  $21\frac{1}{2}$  days to reach Adelaide in its second revolution, but it performed the next revolution in about  $9\frac{1}{2}$  days, reaching New Zealand in  $29\frac{1}{2}$  days after the eruption. Thus it performed  $2\frac{1}{2}$  revolutions in the Northern Hemisphere in  $29\frac{1}{2}$  days, and in the Southern Hemisphere it performed  $2\frac{1}{2}$  revolutions in  $29\frac{1}{2}$  days, showing that the initial velocity at starting has only very slightly fallen off in even latitude  $45^{\circ}$  S. So in the following discussion I will adopt a mean diurnal velocity for the dust cloud of 2083 miles, or 87 miles per hour to the westward.

As I showed at the beginning that, if the atmosphere be considered as part and parcel of the earth, a particle of it at a certain height will cover a greater distance in a certain time than that part of the earth immediately beneath would, so if we know the rate per hour that a certain thing *apparently* moves to the westward, or seems to lag behind the diurnal revolution, we can ascertain the height. We know that it lags behind at the rate of 2083 miles per day, which, added to the circumference of the world, gives a circle of 26,908 miles, and this divided by  $3\cdot1416$  gives a diameter of 8565 miles, or 664 miles greater than that of the earth, or a height of 332 miles above the surface. Or, putting it this way, we may assume that at the latitude of Krakatoa the earth has an hourly velocity of 1034 miles, and that any matter ejected thence into the upper regions of the atmosphere, would retain the same rotary velocity as it had before, viz. 1034 per hour to the eastward; but we have material under our observation which cannot keep its zenithal position at starting, by 87 miles per hour, showing it to be at an elevation of 332 miles.

Now the spectroscope tells us that the red colour is produced through dust of almost ultra microscopic fineness, and in some specimens of this dust that have already fallen the microscope shows the existence of *salt* crystals, which fact in itself almost proves it to be of volcanic origin, and not meteoric or cosmic dust. Now Prof. Helmholtz states that "the reflecting medium, whatever it was, over Berlin on the last three nights of November, was about 40 miles above the earth;" and if we work on this data we have a circle whose diameter is 80 miles greater than that of the earth, or a circle of 7981 miles, which, multiplied by  $3\cdot1416$  gives a circumference of 25,073, or 248 miles more than that of the earth, which, divided by 24, shows an excess of about  $10\frac{1}{2}$  miles per hour above the surface velocity of rotation. But we want to account for an excess of 87 miles per hour; so if we accept Prof. Helmholtz's statement we must only suppose that at the altitude of 40 miles there is an easterly current, or one moving to the westward, of 77 miles per hour; for, assuming as we do from the foregoing tables and calculations that the earth rolls from under the cloud at the rate of 87 miles per hour, unless we admit of an easterly current we cannot stop short of that enormous height of 332 miles unless we suppose that the power of gravitation has only a feeble hold on those most minute dust particles at the altitude of 40 miles, where the atmosphere has not the many thousandth part of the density it has on the surface of the globe.

Mr. W. H. Preece writes stating his opinion that the mass of matter ejected retained the same electric sign as that of the earth, and as long as that was the case the repulsion force would be sufficient to keep the matter afloat; and in reference to that theory Mr. Crookes writes to state that with a rarefaction of one-millionth of the atmosphere, two pieces of electrified gold leaf repelled each other at a considerable angle for thirteen months, and goes on to state that that rarefaction is attained at

an altitude of 62 miles, and that the air there is a perfect non-conductor of statical electricity, without interfering with the mutual repulsion of similarly electrified particles; and when we bear in mind that the particles of minute dust are many thousands of times smaller and lighter than the gold leaves operated upon, there is every reason to believe that electrified dust, once projected 50 or 60 miles high, might remain there many years.

Before proceeding further I must draw your attention to the fact that at the time of the great eruption, and during September, the mean temperature at Batavia, and throughout Java generally, is at its maximum; consequently we may conclude that the equatorial belt of calms and uprushing air that encircle the globe was lying over that district at the time. This uprush is caused through the heated atmosphere rising, and the two trade winds, the north-east and south-east, feed it. When this heated air has attained its proper altitude, it flows off to the north and south, but the rotation of the earth causes it to flow towards the north-east in the Northern Hemisphere, and to the south-east in the Southern Hemisphere, and these winds are called by some the return trades, and by others the south-west and north-west upper currents respectively, and are of great altitude, probably ranging up to 50,000 feet.

Well, the most bulky masses cast upwards by the eruption of Krakatoa would immediately fall, and the less bulky would fall later according to their size, but the great portion of the dust and ash would be caught, on its downward course, in those upper currents just alluded to, and be carried by them to the north-east and south-east. Such we find to be the fact, for the ship *Alcedo*, when to the westward of Cape North-West, Australia, or about 1050 miles south-east of Krakatoa, experienced a fall of dust like fuller's earth, which covered the vessel, on the night of August 30-31, and Capt. Tierney, of the brig *Hazard*, on September 1, near New Ireland, a distance of 3850 miles due east of Krakatoa, saw the coloured suns, which was no doubt due to the presence of dust in the atmosphere, drifted eastward with the upper current.

Now, turning to the north-east quarter, or the direction in which the south-west upper current of the Northern Hemisphere proceeds, we find that in Japan during August 29, 30, and 31, the sun was of a copper colour, and had no brightness in it; at Yokohama, Mr. Hamilton states that on the 29th and 30th the sun was of a blood-red colour, and appeared to be obscured. This is at a distance of about 3000 miles from Krakatoa, which gives a velocity of the upper current, or return trade wind, of about 62 miles per hour; this is not excessive, as I have often measured the velocity of the north-west upper current at Adelaide as over 80 miles per hour.

You may remember that I did not continue the tracking of the dust cloud, from that position assigned to it by Capt. Penhallow, in lat. 24° N., long. 140½° W., on September 25, because the European and American reports are so peculiar. It was apparently seen in England before the rest of Europe, viz. on November 4 and 9, in California on the 20th, San Francisco on the 23rd, Italy on the 25th, New York on the 27th, and at Berlin on the 28th; so you see that the geographical arrangement is rather mixed in reference to the order of dates. This may be accounted for by the fact that there was a very severe volcanic eruption in the Alaska Group and Peninsula in October, I think; it was very intense, and quite capable of ejecting a dust cloud that would envelope the Polar and temperate regions of the Northern Hemisphere; of course it was not nearly so terrific as that of Krakatoa. So you will see that we must be careful before we assert that the brilliant sunsets of Europe are of Krakatoan origin.

The phenomena of coloured suns and brilliant sunsets, I may tell you, have been seen before, both in Europe and America, in connection with Vesuvian and Iceland outbursts; Mr. Somerville, the famous geographer, gives an instance of it which had been seen in Norway, and traced its origin to a severe eruption in Iceland. And H. C. Russell, B.A., F.R.A.S., F.R.Met.S., Government Astronomer, Sydney, in his book on the climate of New South Wales, pages 187, 188, gives some most interesting instances of historical accounts of darkened and coloured suns. I will quote them in their chronological order:—

“At certain times the sun appears to be not of his wonted brightness, as it happened to be for a whole year when Cæsar was murdered, when it was so darkened that it could not ripen the fruits of the earth.” — Virgil, *Georg.*, lib. i., &c.

“In 1090 there was a darkening of the sun for three hours.

“In 1106, beginning of February, there was obscuration of the sun.

“In 1208 there was a darkening of the sun for six hours.

“In 1547, August 24 to 28, the sun was reddish, and so dark that several stars were visible at noonday.

“In 1706, May 12, about ten o'clock in the morning, it became so dark that bats commenced flying, and persons were obliged to light candles.

“In 1777, June 17, about noon, Messier states that he perceived an immense number of black globules pass over the sun's disk.

“In 1783 there was a *dry fog*, and many attributed it to volcanic action; and it is well known that in February that year fearful earthquakes in Calabria took place, followed by a long list of volcanic eruptions in other parts of the world.

“In 1831 was an extraordinary *dry fog*, which excited public attention throughout the world. It appeared on the

Coast of Africa ... ..	August 3
At Odessa ... ..	„ 9
In South France ... ..	„ 10
Paris ... ..	„ 10
New York ... ..	„ 15
Canton, China ... ..	„ end of.

This fog was so thick that it was possible to observe the sun all day with the naked eye, and without a dark glass, and in some places the sun could not be seen till it was 15° or 20° high. At Algiers, United States, and Canton the sun's disk appeared of an azure blue or of a greenish colour. Where the fog was dense, the smallest print could be read even at midnight.

“In 1873, of the *dry fog* which came on suddenly in June, it is recorded that it extended from the northern coasts of Africa, over France to Sweden, and over great part of North America, and lasted more than a month. Travelers found it on the summit of the Alps. Abundant rains in June and July and most violent winds did not dissipate it; and in some places it was so dense that the sun could not be seen until it had attained an altitude of 12°, and throughout the daytime it was red, and so dull that it might be looked at with the naked eye. The fog diffused a disagreeable odour, and the humidity ranged from 57 to 68, while in ordinary fog it is 100. It had a phosphorescent appearance, and the light at midnight was compared to that of full moon.”

Here was exhibited a diagram, drawn correctly to a scale of fifty miles to one inch, showing the arc (15°) of a circle whose radius was 6 feet 7 inches, or a diameter of 13 feet 2 inches. The Himalayas were shown in their correct proportion, so was the smoke from Cotopaxi, estimated by Whymper while on Chimborazo at 40,000 feet; he saw at 5.45 a.m. of July 30, 1880, a dense column of smoke shot up straight into the atmosphere with prodigious velocity, which in less than one minute had risen 20,000 feet above the crater, giving the total height of 40,000 feet above sea-level. The dust, he goes on to state, fell on Chimborazo after six hours, and he estimated that each particle did not weigh 1/25000 part of a grain, and the finest were still lighter.

Some people (and very rightly too) express wonder and unbelief at the possibility of dust being capable of having been shot up to such a height as that ascribed to it, as to cause the red sunsets,—but here I have quoted the fact of such, as seen by a man of known repute; the dust and ashes were shot up to that great height, and not only that, but as the dust cloud came between Mr. Whymper and the sun, he saw the phenomenon of the coloured suns. The same may be seen during any very heavy dust storm anywhere, when the cloud is between the observer and the sun.

In this description given by Whymper, we have a good illustration of the tremendous force Nature uses in these convulsions; a force that could throw the finest dust to a height of 20,000 feet is almost inconceivable to the human mind, and in that phenomenon we have, I may say, only an everyday occurrence when compared with that giant eruption of Krakatoa. Let us draw a comparison. At the destruction of Pompeii, situated at the foot of Vesuvius, the city was enveloped with darkness from the density of the dust and ash cloud that enshrouded it, and that ultimately buried it; but now contemplate the tremendous power that ejected from a mountain a sufficiency of dust and ash



envelop a city in total darkness for thirty-six hours, *eighty miles distant*. On that diagram I have sketched an imaginary picture of the eruption, and eighty miles distant is represented by a little over an inch and a half, where you see the letter B, showing to your mind the relative distance of Batavia from Krakatoa. You can form in your imagination some idea of the great height that the dust cloud ascended: to my mind twice forty would not be too great. Then again we have the ship *Charles Bal*, when *thirty miles distant*, was enveloped at noon-day in pitch darkness through the mud-fall. Furthermore, as Lockyer says, the sound, the least part of the affair, was heard over an area of 4000 miles in diameter, viz. in Ceylon to the north-west, at Saigon to the north, and throughout North Australia to the south-east. In the last quarter the reports were at intervals of fifteen minutes, and sounded like ship-guns, but as the hearers were from 150 to 200 miles from the coast, such cause could not be assigned. All that can be said is that it is beyond the human mind to conceive of such gigantic forces, and therefore absurd to throw doubt on the result; by which I mean that if the laws of refraction show that the substance, whatever it may be, that causes the red glow, is at an altitude of forty or sixty miles, it is ridiculous to doubt that result, when we cannot conceive the magnitude of the power that operated.

It was not only one eruption that took place, but several, during the 26th, the following night, and up to 11.15 a.m. of the 27th, about which time the grand finale is supposed to have taken place. These eruptions followed each other in rapid succession, and are thought to have been caused by the rapid conversion into steam of vast quantities of water that found admittance into the bowels of the earth. Later on the influx of water was too much, and the result was that a tremendous power was generated, so much so as to cause the north part of the island to be blown away, and fall eight miles to the north, forming what is now called Steers Island. This was followed by a still greater eruption, when it is thought that the north-east portion was blown clean away, passing over Long Island, and fell at a distance of seven miles, forming what is now known as Calmeyer Island. These suppositions are almost proved to be facts, from the Marine Survey of the Straits just concluded, from which it will be seen that the bottom surrounding these new islands has not risen, which would most naturally have been the case had they been caused by upheaval, but if anything the bottom shows a slightly increased depth in the direction of the great pit that now occupies the position that the peak of Krakatoa did the day before. These incidents are cited to show you the awful nature and magnitude of the forces brought into play, as you can the more readily satisfy your minds as to the great height the dust and ash were thrown to.

As I said before, this dust cloud may probably be denser in some places than others, owing that fact to the relative period of time that elapsed between each eruption; where it is dense we may assume that they followed each other rapidly, and where it is less dense the interval of time was greater. For you must remember that it was shown to you that the cloud apparently moves to the westward, or that the earth moves from beneath the cloud, at the rate of 87 miles per hour, so that during each hour of the eruption there was a long streak of smoke and dust being formed. These densest parts were no doubt the cause of the coloured suns, and as some observers state, "the sun appeared to shine with diminished strength," others "that it was rayless and giving no heat," so we may look upon that dust cloud as playing the part of a great screen, shutting off some of the heat of the sun from us. In these southern latitudes we have experienced those brilliant sunsets for over seven months, and I have no hesitation in expressing my opinion that the remarkably cool and wet summer just passed in New Zealand was due to that dust cloud shutting off the sun's heat in a great degree. And I see from the Adelaide report that the mean temperature there during January was over  $4\frac{1}{2}$  degrees cooler than the average of the previous twenty-five years, and on only one occasion during that period was it so low, viz. in 1869. At Melbourne also the weather was more like winter than summer, whereas in North and Central Australia, or I may say down to lat.  $30^\circ$  on that continent, the weather was fine, clear, and hot, without rain, giving me the idea that the sun had less power than usual; consequently the north-west monsoon was very feeble, not penetrating far inland, the result being that the interior of Australia has undergone one of the most disastrous droughts on record. But now that, as we may suppose, the equatorial regions of the atmosphere have parted with the

greater part of their dust, if not all, the sun has regained his usual power, and the north-west monsoon its usual strength, penetrating the heart of Australia with refreshing rains and thunderstorms. So we have here an instance of a most terrific phenomenon that not only brought death and destruction to thousands at the time, but that indirectly caused the death of thousands and thousands of cattle and sheep through drought, and it would be most interesting and instructive to learn whether or not such consequences were experienced in other parts of the Southern Hemisphere at least.

It would be beyond the province of this paper, and in fact too late to-night, to enter on a history of the tidal and atmospheric waves that resulted from this eruption, but I will state two facts to finally clinch your mind of its magnitude. When the earth opened her mouth and swallowed that vast quantity of water, the down-rush that accompanied the closing-in of the surrounding crust was so much as to produce a tidal wave that passed and repassed twice, I believe, round the globe. The other fact is, that the tremendous explosion that accompanied the final eruption produced such a vacuum as to cause atmospheric waves to start, and which traversed and retraversed the earth to the antipodes of Krakatoa no less than four times.

Some astronomers have thought that the whole phenomenon may be accounted for by supposing the earth to be passing through a dense meteoric track. To my mind, however, the greatest difficulties brought to bear against the volcanic theory are child's play when compared with the possibility of about 10,000,000,000 to one of a meteoric track so formed as to have its path, either at aphelion or perihelion, so remarkably coincident with that of the earth as to keep company with her for seven or eight months. Besides, were it either meteoric or cosmic dust, it would be seen all over the earth at the same time, and would be visible all night.

No; the only extra-terrestrial argument that would bear any investigation is that of its belonging to the phenomenon of the zodiacal light, which argument, I believe, was adopted at first by my friend Charles Todd of Adelaide; but, as time goes on and more information is gathered, the volcanic theory, I believe, will be finally adopted.

### THE THEORY OF THE WINTER RAINS OF NORTHERN INDIA<sup>1</sup>

AT first sight, the occurrence of rain in Northern India at the season when the north-east or winter monsoon is at its height seems to present a meteorological paradox. The well-known theory of the winter monsoon is that at that season the barometer stands highest in North-Western India where the air is cold and dry, and lowest in the neighbourhood of the equator where it is warm and moist; and therefore, in accordance with elementary mechanical laws, the wind blows from the former to the latter. But the precipitation of rain requires that the air should have an ascending movement, and this can take place only over a region of low barometer, towards which, therefore, the winds are pouring in. Hitherto no one has attempted the reconciliation of these apparently discrepant conditions.

Since the establishment of a Meteorological Department under the Government of India has rendered it possible to study the weather of India as a whole from day to day, it has been my practice to investigate every case of cold weather rainfall in Northern India, amounting generally to three or four in each year, and although many important points still remain for elucidation, it is now at least possible to clear up many of the difficulties of the problem, and to reconcile the apparent inconsistencies.

The charts which accompany the paper show the distribution of atmospheric pressure and the prevalent winds in the four months of the cold weather. They exhibit many features in common. The region of highest barometer is in the Punjab and the Indus Valley, and from this an axis or ridge of high pressure extends across Rajputana and Central India, having a trough of slightly lower pressure in the Gangetic plain and the Northern Punjab on the one hand, and a much lower pressure in the peninsula on the other. The winter monsoon blows around this region of high pressure in an anticyclonic curve, i.e. in the direction of the watch-hands, but in the Punjab and the Gangetic plain there is but little movement of the air, the average rate

<sup>1</sup> Abstract of a paper read before the Asiatic Society of Bengal on March 5, 1884, by H. F. Blanford, F.R.S., President of the Society.

being less than two miles an hour, and calms constitute about one-third of the observations. Also it is shown, by the barometric registers of the Himalayan hill-stations, that that distribution of pressure which, on the plains, causes the north-east monsoon, does not exist and is even slightly reversed at an elevation of 7000 feet.

Hence, in Northern India, the state of things which produces the winter monsoon is restricted to a small height, and is then only an average and not a permanent condition; and that which chiefly characterises the atmosphere is its stillness, a condition in which any local action, small and feeble as it may be at first, may eventually set up a disturbance such as to revolutionise the existing conditions.

The cold weather rainfall is always the result of a local fall of the barometer, the formation of a barometric depression, which generally appears first in the Punjab or Western Rajputana, and then moves eastwards. Towards and around this depression the winds blow cyclonically (*i.e.* against the direction of the clock-hands), and the winds from the south, coming up charged with vapour which they have collected from the warmer land surface of the peninsula and sometimes from the sea, discharge this as rain chiefly to the east and north of the barometric minimum, where they form an ascending current.

Thus in the cold weather, rain generally begins in the Punjab and later on extends to the North-Western Provinces, Behar, and sometimes to Bengal. As the disturbance travels eastwards, it is followed up by a wave of high barometric pressure, and cool north-west winds, which usually last for a few days after the rain has cleared off.

The crucial point of the problem of the cold weather rains is, then, how to account for the formation of these occasional barometric depressions in a region where the barometer is generally high at this season. It has been suggested by one writer that they travel to us from the west across Afghanistan. This, however, can be only a guess in the dark, for, at the time it was made, there were no observatories to the west of India nearer than Bushire, at the top of the Persian Gulf. There is one now at Quetta, and I have examined the registers of this observatory to see if they give any support to the idea, and find that, with the exception of two doubtful instances, they do not. I conclude therefore that in most cases, if not in all, these disturbances originate in India, and their cause is to be sought for in the meteorological conditions of Northern India itself. In some instances they make their first appearance in Rajputana or Central India, and there can then be no question whatever of their purely local origin.

Now the region over which the winter rains are more or less regularly recurrent coincides with that in which the relative humidity of the air at this season, instead of diminishing towards the interior of the country, increases with the increasing distance from the coast. In any month between March and December, as we proceed from the coast of Bengal towards the Upper Provinces, the air becomes drier and drier, not only as containing an absolutely smaller quantity of water vapour, but also, in most months, in virtue of its increased capacity for taking up vapour, owing to its higher temperature. But from December to March the dryness increases inland only as far as Behar. Beyond this, although the quantity of vapour in the air remains very nearly the same or even undergoes a slight diminution, in virtue of the increasing cold there is an approach to that temperature at which this small quantity of vapour would begin to condense, forming cloud or fog; and it is in the Punjab that, in this sense, the air is most damp. The result is that which our registers show to be the case, *viz.* that from December to March it is also the most cloudy province. This seems to depend very much on the stillness of the air. The vapour that is always being given off from the earth's surface diffuses gradually upwards in the still atmosphere, and soon reaches such an elevation that it begins to condense as cloud. When once a moderately thick bank of cloud is thus formed, the equilibrium of the atmosphere is speedily disturbed. It is well known as a fact from Glaisher's balloon observations, and is also a consequence of the dynamic theory of heat, that the vertical decrease of temperature in a cloud-laden atmosphere is much slower (about one-third) than that in a clear atmosphere. This initial disturbance will suffice then to cause an indraught of air from around, an ascending current is set up, the barometer falls; warm, vapour-laden winds pour in from the south, and we have all the conditions of the winter rains.

If this view be just, the stillness of the atmosphere combined

with the presence of a moderate evaporation must be accepted as the condition which primarily determines the formation of barometric minima and the winter rains of Northern India. And this stillness is obviously due to the existence of the lofty mountain ranges which surround Northern India, leaving free access to the plains open only to the south.

Were the Himalayan chain absent and replaced by an unbroken plain stretching up to the Gobi Desert, it is probable that the winter rains of Northern India would cease; any local evaporation in the Punjab and Gangetic valley would be swept away by strong, dry, north-east winds blowing from the seat of high pressure, which, in the winter months, lies in Central Asia, and instead of the mild weather and gentle breezes which now prevail at that season on the Arabian Sea, it would be the theatre of a boisterous and even stormy monsoon, such as is its local equivalent of the China Seas.

### SCIENTIFIC SERIALS

*Bulletin de l'Académie des Sciences de St. Pétersbourg*, vol. xxix. No. 2.—On a new comet, by O. Struve. Its elements, calculated by Herr Seyboth, are:— $T = 1884$ , January 23<sup>h</sup> 22<sup>m</sup> 5<sup>s</sup> average time of Pulkowa;  $\pi = 92^{\circ} 19' 39''$ ;  $\Omega = 253^{\circ} 22' 52''$ ;  $i = 74^{\circ} 21' 56''$ ;  $\omega = 198^{\circ} 56' 47''$ ;  $q = 0.87922$ . Dr. Struve considers it as identical with the comet of 1812, calculated by Encke, and adds a note, by Herm. Struve, about the sudden increase of its light on September 19 to 22.—A report on M. Backlund's memoir on the motion of the comet of Encke from 1871 to 1881, by O. Struve.—On petrified wood from Ryazan, by Prof. Mercklin; it is like *Cupressinoxylon erraticum*.—Observations on some propositions relative to the numerical function  $E(x)$ , by V. Bouniakovsky (third paper).—Remarks on Ginkgokirt's "Kampakakathanakaka," translated by A. Weber, by Otto Böhlingk.—On the contact of inverse figures with the polar reciprocals of the directing figures, by J. S. and M. N. Vaneeck.—Note on wollastonite, by N. Kokscharow.—Telephonic phenomena in the heart produced by the irritation of *nervus vagus*, by N. Wedenski.—On the use of the telephone for the measurement of temperature, by R. Lenz.—On terrestrial currents compared with magnetic variations, by H. Wild.—On the variability of the light of Y Cygni, by Ed. Lindemann. The observations were made in 1881 to 1883, and the magnitude varied from 6.8 to 10.4, showing an annual periodicity. The star changed its colour, as also its shape, becoming sometimes more nebulous, and the changes could scarcely be explained by mere conditions of observations.—Determination of the parallax of a Tauri, by Otto Struve. Its value, deduced from observations made in 1850 to 1857, is 0".516, with a probable error of 0".057.—On some arithmetical consequences of the formulæ for the theory of elliptical functions, by Ch. Hermite.—Note on the discovery of kalait in Russia, by N. Kokscharow.—Studies on milk (second and third papers), by Heinrich Struve; being a series of analyses of cows' and human milk, which bring the author to the conclusion that there are two kinds of caseine, the  $\alpha$ -caseine and the  $\beta$ -caseine.—On the atmospheric waves produced by the Krakatoa eruption, by M. Rykatcheff.

*Verhandlungen des Naturhistorischen Vereins der preussischen Rheinlande und Westfalens*, fortieth year, 1883.—Contributions to the knowledge of the igneous rocks in the Carboniferous hills and New Red Conglomerates between the Saar and the Rhine, by H. Laspeyres.—On the trachyte of Hohenburg near Bonn, by the same author.—A study of the Devonian formations between the Roer and Vicht Rivers, by E. Holzappel.—Remarks on the loess of the Lahn Valley, by F. F. von Dücker.—Tertiary shingles of marine origin on the slate hills of Nassau and Ems, by the same author.—An account of some living American reptiles, spiders, and insects found at Uerdingen amongst the dye-woods imported for the Crefeld silk dyeworks, by F. Stollwerck.—Report on the prehistoric remains of the Sieg Valley, by Dr. M. Schenck.—On the development of the mining and smelting industries in the Sieg district, by H. Gerlach.—Remarks on some monstrosities and aberrations in the colour of the mammals of Westphalia, by Dr. H. Landois.—On the greenstone of the Upper Ruhr Valley and its association with the slates of the Lenne district, by A. Schenck, jun.—A description of some archaeological remains from the Vlotho district, Weser Valley, by H. D'Oench.—A contribution to the study of the flora of the Rhenish Province, by M. Melsheimer.—A survey of the geological relations in the French Ardennes, by Prof. von

Lasaulx.—On the granites of the Watawa district, Bohemia, by Dr. J. Lehmann.—On the progress of electrical appliances, by H. Coerper.—Memoir on Anoplophora (*Uniona p. hlig*), by Prof. von Koenen.—Obituary notice of Dr. Hermann Müller of Lippstadt, by Ernst Krause.—On the crystals of oxalate of lime present in the foliage and stem of *Iris florentina* (four illustrations), by Prof. von Lasaulx.—Remarks on a human skull and other human remains recently discovered in the loess of the Mosel near Metternich, by Prof. Schaffhausen.—Report of a geological excursion to the island of Corsica, by Prof. von Rath.—On the bacillus of tuberculosis and its presence in the human tissues, by Dr. H. Menche.—Remarks on some small crystals of leucite of unusual formation, by Prof. von Rath.—On ten small mammoth teeth from the Schipka Cave, Moravia (one illustration), by Prof. Schaffhausen.—On the action of bromide of aluminium on the dibromide of acetyl and on benzene, by Dr. Anschütz.—On a new synthesis of anthracene, by the same author.—Note on pyrites from the Gommern and Ploetzky sandstone, near Magdeburg, by Prof. von Lasaulx.—On the treatment of bites by venomous snakes, by Prof. Binz.—On a manganese and copper alloy, by H. Heusler.—Report of a scientific excursion in the island of Sardinia, by Prof. von Rath.—On the Tertiary formations of the Bonn district, by Dr. Pohlig.—On the naphtha and petroleum regions of Caucasia, by Dr. O. Schneider.—On the fossiliferous diluvium of the North German lowlands, by Dr. A. Remelé.—Microscopic examination of a series of Norwegian rocks from the Tromsøe district and the Lofoten Islands, by A. Philippon.—Effects of heat on the optical bearing of crystals, by W. Klein.—On the properties of racemic acid and of the inactive pyrotartaric acid of calcium, by Dr. Anschütz.—Geological and palæontological researches in the Bonn district, by Dr. Pohlig.—Microscopic examination of some specimens of volcanic matter from Krakatoa, by Prof. von Lasaulx.—Remarks on a new variety of glaukoppan from the island of Groix, on the west coast of Brittany, by the same author.

*Rendiconti del R. Istituto Lombardo*, May 29 and June 5.—Etruscan notes, by Prof. M. Lattes.—Remarks on the laws affecting contract labour, by U. Gobbi.—On the colouring substances of putrefaction, and on some methods of discharging colours, by Dr. Paolo Pellacani.—On the supposed disposition to cretinism in patients operated on for affections of the parotid glands, by Dr. G. Fiorani.—A new determination of the latitude of the Brera Observatory, Milan, effected in the months of February and March of the present year, by L. Struve.—On a problem connected with the theory of stationary electric currents, by Prof. E. Beltrami.—On the nature of the colouring substance found in the urn of St. Ambrose, dating from the ninth century, by Prof. G. Carnellutti.—On the relation between the elasticity of some metallic wires and their electric conductivity, by Dr. G. Poloni.

## SOCIETIES AND ACADEMIES

### LONDON

**Geological Society**, June 25.—Prof. T. G. Bonney, D.Sc., F.R.S., President, in the chair.—James Campbell Christie was elected a Fellow, and Baron C. von Ettingshausen, of Graz, a Foreign Correspondent of the Society.—The following communications were read:—Additional notes on the Jurassic rocks which underlie London, by Prof. John W. Judd, F.R.S. Since the reading of the former paper on the subject (February 6, 1884) the well-boring at Richmond has been carried to a depth of more than 1360 feet. The point reached is, reckoning from Ordnance-datum line, 220 feet lower than that attained by any other boring in the London basin. A temporary cessation of the work has permitted Mr. Collett Homersham to make a more exact determination of the underground temperature at Richmond. At a depth of 1337 feet from the surface this was found to be 75½° F., corresponding to a rise of temperature of 1° F. for every 52·43 feet of descent. The boring is still being carried on in the same red sandstones and "marls," exhibiting much false-bedding, which were described in the previous communication. The Rev. H. H. Winwood, of Bath, has had the good fortune to find the original fossils obtained by the late Mr. C. Moore from the oolitic limestone in the boring at Meux's Brewery in 1878. A careful study of these proves that, though less numerous and in a far less perfect state of preservation than the fossils from the Richmond well, they in many cases belong to the same species, and demonstrate the Great Oolite age of the strata in

which they occur.—On some fossil Calcsponges from the well-boring at Richmond, Surrey, by Dr. G. J. Hinde, F.G.S.—On the Foraminifera and Ostracoda from the deep boring at Richmond, by Prof. T. Rupert Jones, F.R.S.—Polyzoa (Bryozoa) found in the boring at Richmond, Surrey, referred to by Prof. J. W. Judd, F.R.S., by G. R. Vine, communicated by Prof. Judd, F.R.S.—On a new species of *Conoceras* from the Llanvirn beds, Aberiddy, Pembrokeshire, by T. Roberts, B.A. Only five species of *Conoceras* have as yet been described; the author compared the Llanvirn species with these, and also with a fossil from the Devonian of Nassau, which Kayser referred to *Gomphoceras*, but which possesses several characters in common with *Conoceras*. The horizon from which this new species was obtained is that of the Llanvirn beds, some typical Llanvirn fossils having been found with it. The author named the species *Conoceras llanvirnensis*.—Fossil Cyclostomatous Bryozoa from Australia, by A. W. Waters, F.G.S. In the present paper the Cyclostomata from Curdies Creek, Mount Gambier, Bairnsdale, Muddy Creek, &c., Aldinga and River Murray Cliffs were described, bringing the total number of fossil Bryozoa from Australia, dealt with in this series of papers, up to 195, of which 85 are known living. Of the 32 Cyclostomata now dealt with, 12 at least are known living, and one cannot be distinguished from a Palæozoic form; 9 are apparently identical with European Cretaceous fossils. Although so many remind us of European Chalk and Miocene species, great stress was laid upon the imperfect data available for such comparisons, the Cyclostomata furnishing but few characters which are available for classification, which, so far, has, almost entirely been based upon the mode of growth, which, in the Chilostomata, has been shown to be of secondary value. In consequence of the few available characters, the Cyclostomata do not seem likely to be ever as useful palæontologically as the Chilostomata, and as they are less highly differentiated, it is not surprising to find that they are more persistent through various periods. In order to see how far other characters might be available, the author has examined Cyclostomata, both recent and fossil, from many localities and strata, and pointed out that the size of the zoecia should always be noticed, as also the position of the closure of this tube. The arrangement of the interzoecial pores may frequently give great assistance, and these are considered the equivalents of the rosette-plates; but the most useful character of all is no doubt the ovicell, which varies specifically in position and structure; but this unfortunately occurs on but few specimens, and has rarely been described fossil, although greater attention to this will no doubt lead to its being frequently found and noticed.—Observations on certain Tertiary formations at the south base of the Alps, in North Italy, by Lieut.-Col. H. H. Godwin-Austen, F.R.S.—On the geological position of the Weka-Pass stone, by Capt. F. W. Hutton, F.G.S. The beds described in this paper are of older Tertiary and newer Secondary age, and occur in the northern part of Ashley county, in the province of Canterbury, between the Hurinui and Waipara Rivers. All of the beds are met with at Weka Pass, on the railway and road between Christchurch and Nelson, and the following is the section in descending order:—(1) Mount-Brown beds; pale yellowish sandstone with bands of shells and coral limestone, considered by all New Zealand geologists upper Eocene or Oligocene; (2) gray sandy marl; (3) Weka-Pass stone, yellowish with arenaceous limestone, usually with small green grains; (4) Amori limestone, white, flaggy, and argillaceous; (5) green sandstone with remains of marine Saurians. The last rests conformably on beds of coal and shale, with leaves of dicotyledonous Angiosperms, forming the base of the Waipara system. To this system Nos. 4 and 5 of the above section have also been referred by Dr. von Haast and the writer. The upper beds are the Oamara system of the same authors. The question to be decided is the limit between the two. The green sandstone (No. 5) and the coal shales are generally admitted to be Cretaceous. The geographical distribution of the beds enumerated was briefly described, the gray sandy marl (No. 1), the Amori limestone (No. 4), and the green sandstone having a northerly extension to Cook's Straits, whilst the other beds have been traced to the south only. An examination of the stratigraphical evidence shows that at Weka Pass, and also on the Waipara, the Weka-Pass stone rests on a water-worn surface of the Amori limestone, and near the Pass the former overlaps the latter. The gray marl (No. 2) is evidently unconformable to the lower beds of the Waipara system, whilst at Waipara and Weka Pass it passes down conformably into the Weka-Pass stone. The gray marl also passes up conform-

ably into the Mount-Brown beds. The author concludes that the break in succession is between the Weka-Pass stone and the Amori limestone. The geological evidence is in accordance with the palæontological data. The fossils hitherto found in the Weka-Pass stone (*Voluta elongata*, *Scalardia rotunda*, *Struthiolaria senex*, *Pecten hoistetteri*, *Miomis crawfordi*, *Schizaster rotundatus*, and *Flabellum circulare*) are found in other parts of New Zealand in Upper Eocene beds. None of them are known from the Cretaceous Waipara system. The fossils from the gray marl are also in some cases identical with those found in the Mount-Brown beds. The author concluded by giving reasons for not agreeing with Dr. Hector, who classes all the beds mentioned as belonging to one system of Cretaceous-Tertiary age.—On the chemical and microscopical characters of the Whin Sill, by J. J. H. Teall, F.G.S.—A critical and descriptive list of the Oolitic Madreporaria of the Boulonnais, by R. F. Tomes, F.G.S.—On the structure and affinities of the family Receptaculitidæ, including therein the genera *Ischadites*, Murch., (= *Tetragonis*, Eichw.), *Sphaerospongia*, Pengelly, *Acanthochonia*, g.n., and *Receptaculites*, Defr., by Dr. G. J. Hinde, F.G.S.—On the Pliocene mammalian fauna of the Val d'Arno, by Dr. C. J. Forsyth Major, communicated by Prof. W. Boyd Dawkins, F.R.S., F.G.S.—Notes on the geology and mineralogy of Madagascar, by Dr. G. W. Parker, communicated by F. W. Rudler, F.G.S. This paper commenced with a sketch of the physical geography of the island of Madagascar. A central plateau from 4000 to 5000 feet high occupies about half the island, rising above the lowlands that skirt the coast, and from this plateau rise a number of volcanic cones, the highest, Ankaratra, being 8050 feet above the sea. With the exception of certain legends, there is no record of a period when the volcanoes were active: two such legends were given. The known volcanic cones were enumerated. They extend from the northern extremity of the island to the 20th parallel of south latitude. Beyond this, granitic and other primitive rocks occur as far as lat. 22°, south of which the central parts of Madagascar are practically unknown to Europeans. Some crater-lakes and numerous hot and mineral springs occur. Earthquakes are occasionally felt in the island, most frequently in the months of September and October. The shocks are generally slight. Only a single trap-dyke is known near Antananarivo. The hills around this city are of varieties of granite (? granitoid gneiss). The general direction of the strata is parallel to the long axis of the island. Marine fossils have been found by Rev. J. Richardson and Mons. Grandidier in the south-west part of the central plateau. These fossils are referred by the last-named traveller to the Jurassic system. Remains of *Hippopotami*, gigantic tortoises, and an extinct ostrich-like bird have also been recorded. North and north-west of the fossiliferous rocks, between them and the volcanic district of Ankaratra, sandstone and slate occur. North of this volcanic district again is a tract of country in which silver-lead (mixed with zinc) and copper are found. Near the north-western edge of the central plateau are granitic escarpments facing northwards and about 500 feet high. Some details were also given of valleys through the central plateau, and of lagoons within the coral-reefs on the coasts. To these remarks succeeded some details of the physical features exhibited by the province of Imerina as seen from Antananarivo.—Notes on some Cretaceous Lichenoporidae, by G. R. Vine, communicated by Prof. P. Martin Duncan, F.R.S.

EDINBURGH

**Royal Society, July 7.**—Robert Gray, Vice-President, in the chair.—Prof. James Thomson gave a geometrical solution of the problem: Given a number of points moving Galilei-wise, from their relative positions to determine a reference-frame such that the motions relatively to it may satisfy the condition.—Prof. Tait gave a quaternion solution of the same problem.—Prof. Geikie read a paper on the occurrence of drifted trees in beds of sand and gravel at Musselburgh.—Prof. Tait gave a solution of the problem: To determine the number of different ways in which a given number may be divided, no part being less than 2 or greater than one-half the given number.—Prof. C. Michie Smith gave a communication on the green sun and associated phenomena.—Mr. P. Geddes read the 5th part (psychological) of his paper on analysis of the principles of economics.

SYDNEY

**Linnean Society of New South Wales, May 28.**—Prof. W. J. Stephens, M.A., F.G.S., in the chair.—The following papers were read:—New Australian fishes in the Queensland

Museum, by Charles W. De Vis, M.A. This, the first of a series of papers descriptive of rare and new fishes in the Queensland Museum, is confined to the *Percida* only. Twenty-three species are described and four new genera, viz. *Herops*, allied to *Priacanthus*; *Homodemus*, a fresh-water fish approaching *Dales*; *Auristhes*, of doubtful affinity; and *Hephestus*, a fresh-dwelling vegetable-feeding fish resembling *Lobotes*.—The Hydromedusa of Australia, part iii., by R. von Lendenfeld, Ph.D. The Australian Hydromedusæ are here described which belong to the author's family *Blastopolypida*. To the species described by former authors, which are enumerated with references, several new ones are added, some of which are of greater morphological interest, particularly *Diphosia symmetrica*, nov. sp., which produces perfectly bilateral symmetrical female Gonangia. The number of species is exceedingly great. As far as some of the sub-families of this group are concerned, no other shore is inhabited by anything like such a number and diversity of forms as ours.—On the geographical distribution of the Australian Medusæ, by R. von Lendenfeld, Ph.D. The distribution of the Medusæ, or at all events of the large Rhizostomes, is shown in this paper to be entirely controlled by the ocean currents. Consequently, where the currents are permanent the range of a species can only extend in one direction.—The digestion of sponges, ectodermal or endodermal?, by R. von Lendenfeld, Ph.D. The earlier experiments, which were made to ascertain where the digestive organ of the sponge is situated, showed such different results, that the author made a series of experiments on the subject two years ago in Melbourne, and was by the help of these enabled not only to show with a large degree of probability where and how the digestion was effected in the sponge which he experimented on, but he was also enabled by these experiments to find out the cause of the great difference in the results attained by former observers. The experiments were carried on with carmine powder mixed with the water of the aquarium in which the sponge was kept. The results the author arrived at were taken up by the recent authors on sponges at home; and the second part of the question, viz. to which embryonic layer the epithelia belonged which, according to the author's researches, absorbed the food, was extensively discussed. The present paper gives an abstract of this interesting discussion, and there are also a few additions to the author's former statements.—Remarks on the coincidence of the eruption in the Straits Settlements and the red sunsets, by R. von Lendenfeld, Ph.D.

PARIS

**Academy of Sciences, July 15.**—M. Rolland, President, in the chair.—On Newton's rule for finding the number of imaginary roots in numerical algebraic equations, by M. de Jonquières.—On the equation in matrices  $px = xq$ , by Prof. Sylvester.—Second memoir on the treatment of wheaten flour, by M. Balland.—Observations of the solar protuberances made at the Royal Observatory of the Collegio Romano during the year 1883, by M. P. Tacchini.—On a lunar halo observed at Rome on the night of July 4, by M. P. Tacchini.—On a theorem in mathematical analysis of M. Fuchs, by M. H. Poincaré.—On the electrical conductivity of distilled water and of ice, by M. G. Fousereau. The author infers that under certain conditions the observation of electric resistance may supply a delicate means of testing the purity of water, and determining the slow chemical phenomena produced in liquids.—On the purification of methylic alcohol, by MM. J. Regnaud and Villejean.—Account of a deposit of saltpetre in the neighbourhood of Cochabamba, Bolivia, by M. Sacc. An analysis of this vast deposit, which is large enough to supply the whole of the world with nitrate of potash, yields the following results:—

Nitrate of potash ... ..	60.70
Borax, with traces of salt and water ... ..	30.70
Organic substances ... ..	8.60
	100.00

The author concludes that the saltpetre is the result of the decomposition of an enormous deposit of fossil animal remains.—On the action of coffee on the composition of the blood and the digestive functions, by MM. Cauty, Guimaraes, and Niobey. From their experiments the authors conclude that coffee acts beneficially in stimulating the consumption and digestion of the nitrogenous elements in the food.—Note on the perception of the successive chromatic differences on luminous surfaces, by M. Aug. Charpentier.—Note on the topographic distribution of the secondary

processes of decay following on destructive lesions of the cerebral hemispheres in man and some other animals, by M. A. Pitres.—Report on the chief results of the Finnish Polar Expedition of 1883-84, by M. Selim Lemström.

## BERLIN

**Physical Society, June 13.**—Prof. Lampe spoke on the subject of a hypothesis respecting the formation of the solar system set up by M. Faye in place of Laplace's hypothesis. According to M. Faye's theory, in the original uniform nebular mass, vortices were formed which gave rise to the existence, first of the middle planets, and then, ultimately, of the outer planets. This hypothesis was advanced as an explanation of the fact that the moons of Uranus and Neptune revolved in a direction opposite to that of the sun, the planets, and the other moons, a fact which was not accounted for by Laplace's theory. Only a brief communication, however, had yet been published of M. Faye's hypothesis, which, too, appeared to betray a number of lacunæ.—Dr. König called attention to the investigations that had hitherto been prosecuted on the subject of complementary colours, that is of those pairs of homogeneous spectral colours which, being blended together, produced a white appearance. Regarding the number of such pairs contained in the spectrum there had in all been three distinct experiments made—one by Herr von Helmholtz about the beginning of the '50's, another by Herr Schelske, and a third by Herr von Kries and von Frey. Having described the methods which had been followed in these different experiments, Dr. König proceeded to the results that had been severally arrived at, dismissing, however, without further consideration those attained by Herr Schelske as being all too defective in precision. Herr von Helmholtz had found in the spectrum seven pairs of complementary colours for his eye, Herr von Kries thirteen, and Herr von Frey, who had made use of the same apparatus as that adopted by Herr von Kries, likewise thirteen. The results represented in an arbitrary scale by the two last observers Herr König had converted into undulatory lengths, and, as in the case also of the results attained by Herr von Helmholtz, had exhibited them graphically. By drawing up the undulatory lengths of one spectrum as abscissæ, and those of the other as ordinates, he obtained for the complementary colours of the three observers certain points which, being connected together, yielded a curve of the complementary colours. While now the complementary colours were peculiar for each eye, the three curves of the complementary colours were, on the other hand, very approximate and similar to each other. Herr König then brought forward a few more considerations on complementary colours for monochromatic, bichromatic, trichromatic, and tetrachromatic eyes, demonstrating how, in the case of monochromatic eyes, there could be no question whatever of complementary colours. In the case of bichromatic eyes, on the other hand—eyes, that is, distinguishing only two ground colours, "colour-blind" eyes, as they were usually denominated—the complementary colours on their graphic representation formed quadratic surfaces lying outwardly from the neutral point. In the case of trichromatic eyes, again, they formed two curves, as was deduced from the observations, while, finally, in the case of the tetrachromatic eye, the complementary colours likewise formed curves, the curves marking the perception of the separate ground colours ranging over the whole spectrum. If, however, this last phenomenon was wanting, then complementary colours appeared only when the sectional point of the first and second curve corresponded with a shorter undulatory length than the region of the fourth curve, and the sectional point of the third and fourth curve corresponded with a longer undulation than the end of the first curve. If this condition were not fulfilled, complementary colours could not appear, a fact which would seem to militate against the possibility of a tetrachromism, that is of the existence of four ground colours.

**Physiological Society, July 4.**—Prof. Munk spoke on the extirpation of the cerebrum in rabbits. After a short historical survey of Prof. Christiani's and his own publications on the functions of the cerebrum, the speaker summed up the difference between his results and those of Prof. Christiani in the statement that in his most successful experiments, after removing the cerebrum, he observed in rabbits, just as in other vertebrates, birds and frogs, a state of depression lasting for a longer or shorter period, to as long as several hours, a state in which they lay apathetically, taking and keeping whatever position might be imposed on them. From this state they recovered to go through.

first of all, interrupted and apparently spontaneous movements, which yet, however, on closer inspection proved to be reflex movements. These, again, were followed by a quickened reflex excitability, which finally was succeeded by compulsory movements, a kind of running stage, which, twenty-four to fifty hours after the operation, issued in the death of the animal. Prof. Christiani, on the other hand, after removing the cerebrum, in no case observed a state of depression such as that above referred to, but his excerebrated rabbits all acted like normal ones: they moved about, sprang, ran, &c., during the first twelve hours at least after the operation, which he exclusively observed. Prof. Munk then scrutinised the methods of the operation, pointing out certain minute differences between them, which he subsequently turned to account in explaining how the results deviated so widely from each other. These differences in the execution of the same operation consisted in the fact that he (Prof. Munk) made the section at a somewhat further distance (from about 1 to 2 mm.) from the optic thalami than did Prof. Christiani, and that he had made use of a knife while Prof. Christiani used the handle of a knife to separate the crus cerebri. In explanation of the phenomena observed, Prof. Munk, by means of sections and searching examinations of the brains operated on, established that the depression which at first ensued was the direct effect of the removal of the cerebrum, and that the succeeding reflex irritability and compulsory movements, the later of which lasted till death, were due to an inflammation which extended from the surface of the incision to the cerebral ganglia, and, quite in accordance with the occurrence of the running stage, appeared sooner or later, progressed with more or less rapidity, and ultimately caused death. Prof. Christiani in his experiments did not observe the first stage, that of the exhaustion of the animal, which resulted from the extirpation of the cerebrum, but only the second or running stage following immediately on the operation, because in his procedure the severer irritation of the surface of the incision, together with the bleeding, led at once to inflammation of the cerebral ganglia, that in the case of Prof. Christiani's experiments lay so much nearer the surface of the incision.—Prof. Christiani in replying to Prof. Munk's address, rebutted the latter's interpretation, maintained in all points the validity of the results he had arrived at, and referred to a more complete publication, which was shortly to appear, in which he would prove his assertions, as well as refute the objections that had been raised.

## CONTENTS

PAGE

The Construction of Ordnance . . . . .	285
Our Book Shelf:—	
Yarrell's "History of British Birds" . . . . .	287
Scudder's "Nomenclator Zoologicus" . . . . .	287
Letters to the Editor:—	
Krakatob.—Prof. Wm. Turner; Dr. Stanley M. Rendall . . . . .	287
The Laws of Volume and Specific Heat.—Samuel E. Phillips . . . . .	288
A Carnivorous Plant.—Commander Alfred Carpenter, R.N. . . . .	289
Phosphorescence of the Jelly-Fish.—R. Meldola . . . . .	289
Fireball.—Henry Cecil . . . . .	289
Animal Intelligence.—Karl Pearson . . . . .	289
Munro and Jamieson's Electrical Pocket-Book.—J. Munro and A. Jamieson; Prof. A. Gray . . . . .	290
The Greely Expedition . . . . .	290
L'Abbé Moigno . . . . .	291
The Composition of Ocean Water, I. By Hugh Robert Mill . . . . .	292
Ornithological Notes . . . . .	294
Utricularia vulgaris. By G. E. Simms, Jun. ( <i>Illustrated</i> ) . . . . .	295
Kansas. By G. Phillips Bevan . . . . .	296
Notes . . . . .	298
Our Astronomical Column:—	
Brosen's Comet of Short Period . . . . .	300
The Binary-Star $\beta$ Delphini . . . . .	301
Red Sunsets. By Alexander Ringwood . . . . .	301
The Theory of the Winter Rains of Northern India. By H. F. Blanford, F.R.S. . . . .	304
Scientific Serials . . . . .	305
Societies and Academies . . . . .	306

THURSDAY, JULY 31, 1884

## FORESTRY

*Introduction to the Study of Modern Forest Economy, and Forestry in Norway, with Notices of the Physical Geography of the Country.* By John Croumbie Brown, LL.D. (Edinburgh: Oliver and Boyd, 1884.)

EVERYTHING connected with forestry is especially attractive just now when so much attention is being drawn to the subject in its very varied aspects by the Exhibition at Edinburgh. Dr. J. C. Brown is one of the most voluminous writers we have on forest matters; his pen indeed is scarcely ever at rest, for he has told us about forests and forest management in various parts of the world, both in ancient and modern times, and now he publishes just at an opportune moment two little books the titles of which are given above. The first of these he tells us is issued in accordance with, and in discharge of, obligations imposed by a resolution passed on March 28 last year by a "scientific, practical, and professional" assemblage presided over by the Marquess of Lothian for the purpose of furthering "the establishment of a national School of Forestry in Scotland," and the promotion of "an International Forestry Exhibition in Edinburgh in 1884," the last of which is now being realised, but the former has yet to be accomplished, we hope, however, at no distant date.

Dr. Brown's first book commences by defining what a forest is, and he then goes on to point out that "in the conservation, culture, and exploitation, or profitable disposal, of forest products considerable differences of practice exists," as, for instance, the preservation of game in this country, while on the Continent the wood is the primary object. "In Britain," he says, "we hear much of arboriculture; on the Continent we hear much of sylviculture; the former refers to woods and plantations, the other term speaks of woods and forests; in the one case the unit is the tree, and the wood is considered as the collection of trees; in the other the wood is the unit, and the trees are considered only as the constituent parts. In the former attention is given primarily to the sowing and planting, and pruning it may be, and general culture of the tree; nowhere perhaps has this arboriculture been carried nearer to perfection than it has been in Britain, and the effects produced by the resulting woods are wonderful. In the latter, attention is given primarily to the wood or forest as a whole, capable of yielding products which can be profitably utilised; and the result generally is to produce a much greater proportion of fine trees than does even the arboriculture which has been referred to. And not less different is the exploitation of woods in Britain and on the Continent. In Britain the pecuniary return obtained from woods is considered a secondary matter in comparison with the amenity and shelter which they afford; but on the Continent the materials or pecuniary product, or other economic good, is made the object of primary importance."

This opens the subject of forestry in its widest aspect, and Dr. Brown naturally draws from it a moral on the necessity of forming the much talked of British School of Forestry. The book is divided into three parts, in the first of which the successive chapters treat of the following sub-

jects: Ancient Forests of Europe, the disappearance of European Forests, the evils which have followed their destruction, scarcity of timber and firewood, droughts, floods, landslips, and sand drifts. The second part is devoted to the consideration of "Elements of Modern Forest Economy," under which head we find chapters on Forest Conservation, Replanting or Reboisement, as Dr. Brown prefers to call it after the French usage; Exploitation or Management, Sartage and Jardinage, or Clearance and Selection, &c., concluding this part with a chapter on the study of Pathology. The third part is simply a short notice of modern forest conservancy in general. All these points are of extreme importance in a well-organised system of forest teaching, and under each head Dr. Brown brings together a quantity of matter which, besides being of a practical character, and consequently valuable, is also interesting reading. He possesses the power in an eminent degree of weaving into one uniform fabric what has been said by various writers on the subject that he has so much at heart, for Dr. Brown's books contain long and numerous quotations, through which it will not be necessary to follow him. On the study of pathology, however, as one of the branches in the curriculum of a forest officer's education, we entirely agree with him as to its great importance. It should indeed be equally imperative that a young forester should know something of the nature of the diseases with which the trees under his care are liable to be attacked, as that he should be acquainted with the structure, constitution, and habits of those trees, so that he may be enabled, if occasion requires, to cope with their diseases, and if possible save the victims from premature decay. For this reason a pathological museum should be attached to every forest school, and specimens might be continually added to it by preserving those that might be brought into the school for determination. Such a museum indeed is referred to by Dr. Brown in the following paragraph:—"In the Museum of the Prussian Forest Institute at Eberwalde the impression produced upon the mind of the visitor is that there are there specimens representative of every disease to which trees are heir; specimens exhibiting the progress of the disease from the attack to the consumption; and, hard by, the bark, the wood, the insect, or the parasitic herb or fungus by which it has been induced, the insect and the fungus being exhibited under all the transformations through which they pass; while specimens of the effects of lightning and other physical causes of the decay or destruction of trees are not lacking. And similar collections sufficient to afford facilities for the study of the diseases of trees and of means of preventing or of remedying the evils done are to be found in many other similar institutions." Dr. Brown concludes his first book with a sketch of the curriculum of the Spanish School of Forestry, which includes a wide range of subjects in mechanics, physics, acoustics, heat, optics, electricity, meteorology, chemistry, natural history, including botany and zoology. "The instruction is given (1) by oral lectures and lessons in drawing by the professors; (2) by written exercises, calculations, and analyses on the subjects embraced by these lectures; (3) by the detailed study of the animals, rocks, plants, and forest products which constitute the collections and adjuncts of the establishment; (4) by the practice of topography, land-surveying, the

study of natural history, and of mountains in the field ; (5) by excursions to the plantations and mountains."

With regard to the status of forest officers in different parts of Europe they are described as taking rank with military men and other Government officers of recognised social position, and having in many instances an official uniform and a higher salary than is accorded to military officers, by way of compensation for the monotonous life they are called upon to lead in the forests, which often has a depressing influence—"day after day, month after month—trees, trees, trees everywhere, trees and shade, trees and shade—shade that reminds one of the expression 'the valley of the shadow of death.'"

"Forestry in Norway" is a book of a different character from the preceding. It treats of the general features of the country in its various aspects, with especial regard of course to its arboreal vegetation, and the effects of temperature, rainfall, rivers, lakes, mountains, valleys, &c. The book is for the most part very pleasant reading.

In Chapter IV., under the head of Geographical Distribution of Trees in Norway, Dr. Brown shows that he has made himself acquainted with the modern literature of the subject, especially with the well-known report and maps prepared by Dr. F. C. Schubeler, Professor of Botany in the University of Christiania. From this and from the numerous other works cited the conclusion is drawn that the true forests of Norway are composed almost entirely of the Norway spruce fir (*Picea excelsa*, Link.) and the Scotch fir (*Pinus sylvestris*, L.), though some other trees, as the elder, beech, and oak, are found forming little woods. We must here point out that nearly the whole of this chapter requires careful editing. There is no excuse for the retention of old and exploded names, still less perhaps for absolute mistakes. On p. 39, for instance, it is stated that the Norway spruce is generally known as *Abies communis*, a name under which very few indeed would know it except those well versed in the synonymy of the plant. On the same page *Millaw* is printed for Miller, *Lank* for Link; and a page or two further on, the Norwegian birch is referred to *Betula odorata*, Bechet, when it should be *B. alba*, L. Again on p. 45 we are told that two species of oak "are found growing wild in Norway, the sessile-fruited oak, *Quercus robur*, W., and the common oak, *Q. pedunculata*, W." The fact is that the sessile-fruited oak is *Q. sessiliflora*, Sm., and the pedunculated oak, *Q. pedunculata*, Ehr., both of which are now placed by most modern authorities under the one name of *Quercus robur*, L. Similar instances occur further on, as well as misspellings, all of which could be easily rectified, and the book made more trustworthy.

The general readable nature of the bulk of the book will no doubt cause it to be read by those into whose hands it may fall, whether they are specially interested in forestry or not, and will thus form one means of promoting the extended use of the volume.

#### LENSES

*Lenses and Systems of Lenses.* By Chas. Pendlebury, M.A., F.R.A.S., Senior Mathematical Master of St. Paul's. (Cambridge: Deighton, Bell, and Co., 1884.)

WE are glad to welcome at last an English book on this subject, on which up to the present but little has been written in our language. An abstract of

Gauss's paper in Taylor's *Scientific Memoirs*, and a paper by Maxwell in the second volume of the *Quarterly Journal of Mathematics* form, so far as we are aware, the main English literature of the subject. Of course since the time of Gauss foreign writers have used it freely: Listing, Helmholtz, and Carl Neumann in Germany, Verdet and others in France, have introduced it with more or less modification into their works. We would suggest that a list of books and memoirs on the subject would form a valuable addition to Mr. Pendlebury's book. The author gives frequent references in footnotes to books or papers from which he has drawn information, but a complete list would be a great help to others studying the subject. The method itself is very elegant and attractive, though somewhat barren of results; perhaps this is the reason why it has been neglected in England. It enables us to obtain a beautiful solution of the problem to a first approximation when all the rays make but small angles with the axis, but refuses to help us further.

The book before us is clear and well written, though perhaps unnecessarily long. Mr. Pendlebury has three chapters successively on refraction at a single surface, at two surfaces, and at any number of surfaces. This would be very well for a student who was supposed to begin the study of optics with this book, but such a student is hardly likely to exist; and one who has read the ordinary text-books on the subject could easily follow at once the reasoning of the most complicated case, and might be left to deduce the others so far as they differ from it as corollaries.

Referring, however, to some points in the book, we think that in Fig. 4 it would have been better to take as the standard case one in which the points X and X' both lie to the same side of A, the case usually considered in text-books on optics. This would have obviated the necessity of having to put a negative sign to the symbol *u* in the algebraical work. Attention also might with advantage be called to the point that one of the two focal distances is negative.

Again, a difficulty occurs when we compare the results of Sections 67 and 74; in the one we have

$$\frac{1}{v} - \frac{1}{u} = \frac{1}{f},$$

while, using the same notation, the results of the other may be written

$$\frac{1}{v} + \frac{1}{u} = \frac{1}{f}.$$

The explanation, of course, is that Fig. 18, from which the last result is deduced, is not drawn for the standard case of a lens forming a virtual image of an object. There is another small point of arrangement which it seems to us might be slightly modified with advantage; we would draw a rather more definite line between the analytical and geometrical methods of treating the subject.

If we assume that a pencil of rays diverging from a point will, after refraction, pass through a point, we can prove geometrically the existence of the principal points, the focal points, and the nodal points. We cannot, however, without analysis, find the position of these points in terms of the curvatures and distances between the various refracting surfaces.

Again, if we assume the position of the focal and

principal points, we can find geometrically the position of the image of any point after refraction through the surface. This we may describe as the geometrical treatment of the subject.

By the aid of analysis we can show that there is, to the degree of approximation to which we go, a point image of any point, and we can find in terms of known quantities the positions of the cardinal points of the system and the relation between a point and its conjugate focus. Mr. Pendlebury adopts both methods indiscriminately; it seems to us that it would have been better to have kept the two somewhat more distinct.

A short account of the paper of Maxwell to which reference has been made, "On the General Laws of Optical Instruments," would form a valuable addition to the book, and may, perhaps, be included when the author extends it, as he hopes to do, so as to cover a wider area in the field of geometrical optics. At present the field is open to him, and a book on the whole subject as good and interesting as "Lenses and Systems of Lenses" is greatly needed.

R. T. G.

#### OUR BOOK SHELF

*Fuel and Water.* Translated from the German of Franz Schwachhöfer, by Walter R. Browne, M.A. (London: Charles Griffin and Co., 1884.)

MR. WALTER R. BROWNE has made a very good translation of a book written for the German students of agriculture in Vienna. He has added a clever sketch of the mechanical theory of heat as an introduction. The English of the translation is remarkably good and clear, and the original treatise has been written by a competent man. The translator in his preface appeals to manufacturers and users of steam on a large scale; but the work is much too scientific for them, dealing not with the various forms of boiler now in the market, but rather with the general principles on which boilers should be constructed. On the other hand I fear that the information given is in many parts not full enough for the engineer, and we frequently find data given such as will be of more value to the German than to the English reader. The chief physical formulæ relating to heat and applicable to practical questions connected with engineering are clearly stated, but the comparison of results deduced from these formulæ with the results derived from actual experience is rather sparingly made. The third chapter, which is headed "Heating Apparatus," treats of the furnace and its management. The author gives the results of some actual experiments as to the loss of heat in the chimney, in the ash-pits, in priming water, and by conduction and radiation. He also gives an experiment with what is called an economiser. This chapter seems to me one of the best in the book. Altogether, I think the work is one which may in many parts be profitably consulted by those engineers who desire to compare theory with practice.

FLEEMING JENKIN

*The Elements of Euclid.* Books I. to VI. With Deductions, Appendices, and Historical Notes. By J. S. Mackay, M.A. (London: W. and R. Chambers, 1884.)

THIS text-book has been compiled at the request of the publishers, and the event shows that it was by a "happy thought" their choice of an editor fell upon Mr. Mackay, the Mathematical Master of the Edinburgh Academy. Of it we have nothing to say but what is good. This praise is not so much for the text, for others have done well in this direction. Still even here Mr. Mackay has shown great judgment and skill in his selection of proofs. The text is in the main that of R. Simson's well-known

editions, and no change has been made in Euclid's sequence of propositions, and no violent change in his modes of proof.

But what we particularly like are the carefully prepared historical notes, which take the form of footnotes or of fuller paragraphs in the six appendices. Mr. Mackay remarks, "It would perhaps be well if such notes were more frequently to be found in mathematical text-books: the names of those who have extended the boundaries, or successfully cultivated any part of the domain, of science, should not be unknown to those who inherit the results of their labour."

We regret that though authors have before expressed themselves to similar effect, yet few have had the inclination or leisure to act as our present author. He has had to curtail his material, but what he gives us shows that he is well qualified by the extent of his reading to satisfy this want.

We note here that recent French mathematicians are in the habit of attributing the first use of the word "orthocentre" (which Mr. Mackay ascribes to Dr. W. H. Besant) to Dr. Booth; in so doing they are certainly in error, as Dr. Booth himself, in the second volume of his "New Geometrical Methods" (p. 261), says "the point has been called by some geometers the *orthocentre*." What he may lay claim to is his calling what is now often called the *pedal triangle* the *orthocentric triangle*.

The figures are admirably drawn and are quite a feature of the book; they deserve the editor's commendation when he thanks Mr. Pairman for the "excellence of the diagrams."

This edition is well suited for the geometrical student, and, at the same time, its cheapness puts it within the reach of all who wish to study "Euclid."

*Traité Pratique d'Analyses chimiques et d'Essais industriels.* Par Raoul Jagnaux. (Paris: Octave Doin, 1884.)

THE purpose and character of this little book is best indicated by the saying of Berzelius which heads the author's preface: "Le meilleur mode d'analyse est celui qui exige le moins d'habitude chez l'opérateur." The book is mainly intended for the use of the chemical engineer and the metallurgist, and the methods of analysis described are essentially "works-methods," in which rapidity of execution is a very important consideration. Many of these methods are new, and have been devised partly by M. Hautefeuille, and partly by the author. We would especially note those depending upon the precipitation of such metals as zinc, copper, nickel, and bismuth as oxalates, whereby the formation of gelatinous precipitates, difficult to wash, is avoided. The book contains a large number of analytical results as evidence of the validity of the methods employed; many of these analyses, such as those of aventurine glass, garnierite, sylvérite, are valuable as illustrating the composition of substances which are not frequently examined.

T.

#### LETTERS TO THE EDITOR

[The Editor does not hold himself responsible for opinions expressed by his correspondents. Neither can he undertake to return, or to correspond with the writers of, rejected manuscripts. No notice is taken of anonymous communications.]

[The Editor urgently requests correspondents to keep their letters as short as possible. The pressure on his space is so great that it is impossible otherwise to insure the appearance even of communications containing interesting and novel facts.]

The Relation between the B.A. Unit and the Legal Ohm of the Paris Congress

AT a meeting of the Electrical Standards Committee of the British Association held on Saturday, June 28, the following resolution was carried:—

"That for the purpose of issuing practical standards of elec-



trical resistance, the number of B.A. units adopted as representing the resistance of a column of mercury 100 centimetres in length, one square millimetre in section, at a temperature of 0° C. be '9540."

It follows from this that the legal ohm of the Paris Congress, which is defined as the resistance of such a column 106 cm. in length, contains 1'0112 B.A.U., while the B.A.U. contains '9889 legal ohm. Thus resistances which are expressed in terms of B.A. units may be reduced to legal ohms by multiplying by '9889, while makers and others who have a standard B.A. unit can construct a legal ohm by making a coil equal to 1'0112 times that unit.

A resolution of the nature of the above was rendered necessary by the fact that the legal ohm is defined in terms of the resistance of a column of mercury, while the resistances in use in England are B.A. units. The relation between the two has been determined by different observers with slightly different results. The Committee hope to secure uniformity in the resistances sold to the public as legal ohms, by stating the number they intend to adopt for the purpose of issuing standards.

R. T. GLAZEBROOK,  
Secretary Electrical Standards Committee  
of the British Association

**The Yard, the Metre, and the Old French Foot**

THE ratio of the metre to the yard can scarcely be said to be known with certainty at the present day. The latest and most exhaustive investigation of this question is due to Prof. W. A. Rogers of Cambridge, Mass. The value which he assigns to it (pending a final and authoritative comparison of the "Mètre des Archives" with its chief representative, by the International Commission of Weights and Measures) is—

$$39'37027 : 36.$$

This ratio is very nearly identical with the much simpler one—  
35 : 32,

the error of which is less than 1 in 8000. If we disregard this error, the conversion of yards into metres can be effected with the greatest ease by the following arithmetical process. Thus—

Given	...	...	35 yards or	39'37027 yards
Subtract	1/10th	-	3'5	- 3'937027
Add	1/7th	+	5	+ '5624324

Results 32'0 metres 35'9956754 metres  
Error - '0043246

By a singular piece of good luck, this error, small as it is, may be entirely removed by one more easy approximation: for dividing the last quotient by 130 gives + '0043263—where the outstanding disagreement is less than a unit in the last given figure. Hence, if we wish for a closer conversion than will be given by the terms 1, - 1/10, + 1/7 (of the last), we have only to add further, + 1/130 (of the last) to obtain the utmost accuracy at present possible.

The converse operation—to convert metres into yards—is not quite so short and easy in the closer approximation. The following shows the approximate and the more exact conversion:—

		Ex. 1	Ex. 2
Given	...	32 metres	36 metres
Add	1/10th	+ 3'2	+ 3'6
Subtract	1/16th	- 0'2	- 0'225
"	2/100ths	-	- '0045
"	1/20th	-	- '000225

Results 35'0 yards 39'370275 yards

The fact is, almost any conversion may be performed in some such way, in three or four operations; and it was not for the sake of the rigorous ones that this note was written, so much as to bring into notice the very close and useful approximation represented by the ratio 32 : 35.

By way of applying the rules usefully, we may take as examples:—To find the equivalent of a kilometre in yards, and of a mile in metres. Thus—

1000 metres	1760 yards
100	- 176
6'25	+ 25'14286
'125	+ '19341
00625	...

Answers 1093'61875 yards ... 1609'3363 metres

Here we see that the approximate ratio 32 : 35 entails an error of only 0'131 yard (or less than 5 inches) in one kilometre; or of 0'193 (or less than 2) decim. in one mile, so converted.

The old French foot, the sixth part of the toise—the famous "Toise of Peru"—survives now practically only in the Prussian toise, so far as that is not superseded by the metre. Whatever may be its present range, the ratio of the old French foot to the present English foot is curious. I believe it may be expressed, within the limits of error of the relation so far as can now be known, by the fraction 389/365. That is to say, the excess of the former is 24/365 × the latter, the two components of which fraction are such as may easily be remembered when once the coincidence has been noted.

J. HERSCHEL

Collingwood, July 25

**Fireballs**

IN reference to the phenomena of fireballs the following notes may be of interest. Last year, in July, I was residing on Naphill Common, Buckinghamshire. About midday, during my absence at Oxford, a violent thunderstorm broke over the district, and appeared to extend from Oxford to London. On returning I found that the house had been struck by lightning, apparently in two places. One chimney was knocked in through the roof, the debris partly filling up my room. The kitchen chimney had also been visited, the lightning breaking some of the brickwork of the hearth, and passing a person cooking at the fire; two or three others were in the house at the time, but no one was hurt. On carefully examining the marks left, I found that a door in a room adjoining the one above-mentioned had been split, and some iron knobs knocked off and broken, the screw nails being removed out of the wood, and a large hole several feet square made in the side of the house. From examination of the outside of the wall at the foot of the kitchen chimney, the bricks showed displacement opposite the marks inside at the hearth. I believe a tree was struck, and a water-trap or cess-pool shifted out of position. Some men using a reaping machine in a neighbouring field stated that they knew the storm was coming by the fire playing about the blades of the machine. A boy who had been near at the time said that he saw a large ball of fire fall on the house, which it seemed to enter; it then reappeared, and passed into the meadow. I therefore think it likely that the damage done to the rooms and side of house was due to the electric development called a fireball.

Glasgow

W. J. MILLAR

**The Swallowing of one Snake by another**

AS the author of the article "A Cannibal Snake" (NATURE, July 3, p. 216) wishes to know whether an instance similar to that recorded by him has ever before been brought to notice, I feel bound to publish an occurrence which I witnessed many years ago, and of which I have often told, without ever putting it into writing. During the summer of 1857 I lived in the environs of Washington; as an amusement, snakes were kept in cages. Sometimes, in the evening twilight, when toads and frogs appeared on the garden paths we used to feed the snakes with them. The usual habit of the snakes was to seize the toad wherever the jaws happened to strike, and to move them afterwards along the body of the victim, so as to begin the process of swallowing from the head. Once I threw a toad into a cage containing two of the common water-snakes of that region (*Nerodia sipedon*, if I recollect right, is the scientific name of the species). Both seized the toad at the same time; the one near the head began at once to swallow: the other put its jaws in motion as usual, in order to get at the head, but in doing this it reached the head of its comrade, and began to swallow that, as well as the toad. This went on for some time, until about three-quarters of the one snake were engulfed within the other. Then the snakes separated again, the swallowed one coming out covered with slime, but apparently unharmed and as lively as ever. It lived a long time afterwards. The snakes were of about equal size, and, as far as I remember, from 2½ to 3 feet long. I suppose that it was the swallowing snake, and not the swallowed one, that kept the frog, but I do not think I ascertained the fact at the time. The whole performance lasted a few minutes only.

Heidelberg, Germany, July 27

C. R. OSTEN SACKEN

**The Red Sunsets**

I NOTE in NATURE of July 3 (p. 229) an abstract of a communication of M. Gay to the Paris Academy of Sciences, made

on June 23, in which he suggests a connection between the red sunsets and the frequent rains. During the latter half of the past winter the rains were incessant in the Atlantic States of America, and the writer suggested that they were due to the volcanic dust in the atmosphere, in a letter published in the *Philadelphia Public Ledger* of February 23. In a subsequent issue, March 8, he called attention to Dr. Aitken's researches. Subsequently Prof. Heilprin, of the Philadelphia Academy of Natural Sciences, offered a similar suggestion.

Philadelphia, July 16

CHAS. MORRIS

### THE SALTNESS AND THE TEMPERATURE OF THE SEA<sup>1</sup>

PROFESSOR DITTMAR'S researches, an account of which forms Part I. of this volume, have finally proved that, so far as the most refined analysis can go, the mixture of salts dissolved in ocean water has attained a state of chemical equilibrium. But, although there is constancy of proportion between the various salts, the ratio of the total salts to the water varies considerably in different parts of the ocean.

The great evaporation in the dry tropical areas and the removal of water by freezing in the Polar seas tends to increase the salinity in these places, while in the tropical zones of continual rain and in the Polar fringes where the icebergs melt, there is constant dilution going on. The determination of the salinity at different places and depths is of great oceanographic importance, and the problem of finding the salinity has been attacked in various ways. The most simple and straightforward is to evaporate a weighed portion of the water to dryness and weigh the residue, but this cannot be done without chemical change taking place. The magnesium chloride present decomposes with the water into magnesia and hydrochloric acid, and all the carbonic acid of the carbonates is driven off. Gay-Lussac showed long ago how to avoid the error due to the dissociation of magnesium chloride, but no means have yet been suggested for taking account of the carbonates in a total salt determination. Direct weighing being thus found inexpedient, the next best method would appear to be to find the exact amount of any one element present, and by means of a table of complete analysis, taking advantage of the constancy of composition of ocean salts, to convert that into the salinity by multiplication with a constant factor. This is the method which Prof. Dittmar prefers, and for the purpose he estimates the chlorine or rather the total halogen by means of his refinement of Volhard's process. When the salinity of water has to be determined at sea, this delicate method cannot be conveniently employed, and it has been customary hitherto to measure the specific gravity of the water very carefully and afterwards to reduce the results to salinities. An attempt has been made with considerable success in the United States to substitute the determination of the refractive index of water for that of the density, and thence to deduce the salinity by a formula. This method is pre-eminently adapted for use at sea, but it appears not to possess the necessary delicacy.

The only method by which the specific gravity of a fluid can be ascertained on board ship is by means of hydrometers, and as the extreme values for sea-water are, according to Mr. Buchanan, 1'02780 and 1'02400, apparatus of great delicacy must be employed. A very delicate glass hydrometer was used on the *Challenger*, yet in spite of its fragility and the thousands of observations that Mr. Buchanan made with it in all weathers, he succeeded in carrying the one instrument which he had used during the entire voyage back to this country unbroken. His description of the hydrometer is as follows:—

<sup>1</sup> "The Physics and Chemistry of the Voyage of H.M.S. *Challenger*," Vol. i. Part ii. "Report on the Specific Gravity of Ocean Water." By J. Y. Buchanan, M.A., F.R.S.E. Part iii. "Report on the Deep-Sea Temperature Observations obtained by the Officers of H.M.S. *Challenger* during the Years 1873-76." (London: Longmans and Co., 1884.) See NATURE, July 24, p. 292.

"Preliminary calculations showed that convenient dimensions would be about 3 mm. for the diameter of the stem and about 150 c.c. for the volume of the body, and from 10 to 12 cm. for the length of the stem. The tube for the stem was selected with great care from a large assortment, and no want of uniformity in its outward shape could be detected with the callipers. The tube for the body of the instrument was also selected from a number, in order to secure such a diameter as would give the instrument a suitable length. In order to provide against accidents, I had four instruments made from the two lengths of tubing. The glass work of the instrument being finished—except that the top of the stem, instead of being sealed up, was slightly widened out into a funnel—the instrument was loaded with mercury, until the lower end of the stem was just immersed in distilled water of 16° C. A millimetre scale on paper was then fixed in the stem, and the calibration carried on by placing decigramme weights on the funnel-shaped top, and noting the consequent depression on the scale. The whole length of the scale was 10 cm., and this portion of the stem proved to be of perfectly uniform calibre. Several series of observations were made in order to determine accurately the volume of any length of the stem. . . . When this operation of calibration was finished, the end of the stem was carefully closed before the blowpipe."

The constants necessary for making a specific gravity observation were all determined with the utmost care. They included the exact weight *in vacuo* of the instrument, the volume of the body, the volume of each division of the stem, and the expansion of the whole instrument for a degree Centigrade. These data were fully tabulated, and in addition tables were made of the total weight when each of a set of brass weights was placed on a small table that could be slipped over the top of the stem. These weights were necessary, as, without them, the stem would require to be of great length in order to serve for waters of different density.

In making an observation Mr. Buchanan always kept the water sample in the laboratory for a night in order that it might have time to attain the temperature of the surrounding air. He then placed about 800 c.c. in a glass jar supported on a swinging table, and immersed the hydrometer in it after ascertaining its temperature exactly. To insure the greatest possible accuracy two readings were frequently made with different weights on the table, the results separately reduced, and the mean taken as the density. The density was calculated in every case by ascertaining the weight of the loaded hydrometer and dividing it by the immersed volume, which is calculated from the temperature and stem-reading.

Prof. Dittmar examined very particularly into the probable error in reading Buchanan's hydrometer, and after a long series of experiments, described in the chapter on Salinity in Part I., he came to the conclusion that the difference between the salinity as calculated by it and by his direct chlorine determinations (*i.e.*  $\chi_1 - \chi$  where  $\chi$  stands for the permilleage of chlorine) amounted to  $-.042 \pm \delta$ ,  $\delta$  being a variable the chances of which being greater or less than '06 are equal, and are 4 to 1 in favour of its being less than '12. The value of  $\chi$  is usually between 19 and 20.

At first Mr. Buchanan reduced his specific gravities to the temperature of 15°·56 C. by Hubbard's tables, but Prof. Dittmar, in the course of his investigation of "The specific gravity of water as a function of salinity, temperature, and pressure," succeeded in constructing a much better table in which the variation of the coefficient of expansion with the salinity of the water is taken account of, and all Mr. Buchanan's results published in this volume have been calculated by it. A very ingenious graphic method of comparing Hubbard's results with Dittmar's and converting one into the other is given in Plate I. of Part II.

In the course of his work Prof. Dittmar hit upon an elegant method of determining densities, which was found to be very satisfactory. He filled a water-bath with a particular sea-water that had been selected as a standard, and kept it at a constant temperature. A specific-gravity bottle was filled with the same water, stoppered, hung in the bath to the balance-pan, and weighed accurately. To compare any number of samples of water it was sufficient to fill up the bottle with the water in question, and again weigh it immersed in the standard. Prof. Dittmar confined himself to making out the relation between salinity, specific gravity, and temperature, leaving the relation of specific gravity and pressure for subsequent treatment by Prof. Tait, whose great chain of experiments on the compressibility of sea-water is now drawing to a close, and the results of which will shortly be published in the *Challenger* Reports. The conclusion Prof. Dittmar comes to is summed up in the formula—

$$\chi = \frac{4S_t - 4W_t}{a + bt + ct^2}$$

where  $\chi$  is the "salinity" or permillage of halogen;  $4S_t$  the specific gravity of sea-water at  $t^\circ$  relatively to pure water at  $4^\circ$  C.;  $4W_t$  is the specific gravity of pure water in the same way;  $a$ ,  $b$ , and  $c$  are constants which have been determined once for all.

In the chapter on Salinity in Part I. Prof. Dittmar gives a table dealing with 300 samples, collected in all parts of the ocean and from all depths. These tables show the position, the depth of the ocean at the station, the depth from which the sample was drawn, the permillage of chlorine ( $\chi$ ), the mean deviation of the mean  $\chi$  from the individual results, and the difference between the amount of chlorine as calculated from Buchanan's observations of specific gravity, and as found directly by Dittmar.

Mr. Buchanan gives in his report all his observations classified according to geographical position and depth, and arranged in eighteen large tables. These record the specific gravity of water from all depths in the North and South Atlantic, the Southern Indian Ocean, the North and South Pacific, and the interesting inclosed seas of the Malayan Archipelago. The numbers are simply given as they were observed, only corrected for temperature by Dittmar's table, and all discussion of their oceanographic significance has been deferred until a subsequent occasion.

A series of coloured charts illustrating the bathymetrical and geographical distribution of specific gravity over the whole world and in the individual oceans accompanies the memoir. These are extremely interesting, and in many cases they tell their own story without explanation, though when the full descriptions are published, the value and interest of the plates will be greatly increased. The track-chart of the *Challenger* coloured to show the surface salinity of the ocean, is especially worthy of notice; its details have been filled in, and the whole rendered more complete, by the incorporation of the results of other exploring expeditions.

The great importance of Mr. Buchanan's specific gravity observations will be more readily recognised by the general reader when they are elucidated by the work of Prof. Tait and Mr. Buchan, and treated more generally than is possible in a mere statement of observed figures.

The third part of the volume is devoted to the temperature observations made during the cruise. The nature of the information contained in the curves which make up this part of the work is very concisely put in the editor's introduction:—

"It has been deemed advisable to publish, for the convenience of scientific men, the whole of the deep-sea observations of temperature made during the voyage of the *Challenger*. These are given in detail in the accompanying series of 263 plates, which show the latitude and

longitude of the station; the depth in fathoms of the bottom; the depth at which each temperature was taken; the number of the thermometer; the temperature actually observed read to quarter degrees; the error of the thermometer; and the temperature corrected for instrumental error only."

The temperatures have been plotted by Staff-Commander Tizard, and a free-hand curve drawn through the points. From this the "temperature by curve" which is employed in drawing the diagrammatic sections of the ocean showing the bathymetrical arrangement of the isothermals is taken. These sections will be published in vol. i. of the *Challenger* narrative, and to the general reader they will present a much more intelligible idea of the distribution of oceanic temperature than can be given by the study of tables of figures or curves for separate stations. The separate station curves are, however, of the utmost value to any one who wishes to make a detailed study of ocean temperatures. With a direct view to such a purpose the curves have been drawn with rigid adherence to the numbers in the observation books, even the most obvious cases of observational error being left uncorrected; for the specialist can easily discover and correct them himself, and no one else will notice them.

The temperature observations, like the specific gravity observations, form a rich mine of material with which good work may be done. It is shown by a glance at the charts that there are areas in the ocean of great salinity and areas of great dilution; it is shown that the pressure increases uniformly with the depth; it is known that the surface temperature of the water varies greatly in different latitudes, and that, as the depth increases, the temperature decreases, at first very rapidly, but after the first few hundred fathoms with increasing slowness, until at the bottom the temperature of the open ocean is everywhere the same, between  $34^\circ$  and  $35^\circ$  F.; it is known also that in inclosed seas, or in those where there are submarine barriers cutting them off from the rest of the ocean, the temperature assumes a constant value in its descent, and sometimes the bottom is nearly  $20^\circ$  F. warmer than that of the ocean at the same depth a few miles distant; but this is all that is known. It is evident that there must be an ocean circulation on a magnificent scale going on, a gradual onward sweep of the whole mass of the water, but the direction of this mass motion can only as yet be guessed at, and its rate is utterly unknown. The material for solving this, the great oceanographic problem, is rapidly accumulating, and when the physical and chemical reports of the *Challenger* Expedition have all been made public, it will be strange indeed if a large generalisation cannot be based upon them, and the discovery of the secret of ocean circulation be added to the many discoveries which have been made by the scientific men of the cruise.

The nature of this volume, both on account of the subjects with which it deals and the number of formulæ and long tables of numbers it contains, must have made the task of editing it no light one; and the accuracy of every part, the almost entire absence of typographical errors, and the beauty of the lithographed charts show that authors, editor, engravers, and printers have alike exerted themselves to produce a volume worthy of being the first to record the physical and chemical work of the *Challenger* Expedition.

HUGH ROBERT MILL

#### SPECIALISATION IN SCIENTIFIC STUDY<sup>1</sup>

THERE once was a science called "natural philosophy," which, like some old synthetic types of animals, held in itself all the learning that applied to physical facts. By the beginning of this century this science of natural things had become divided into physics and natural history. These divisions have since spread,

<sup>1</sup> From *Science*.

like the divisions of a polyp community, until now natural history has more than a dozen named branches; and in physics the divisions are almost as numerous. There are now at least thirty named and bounded sciences; each name designating a particularly limited field, in which there are able men who work their days out in labour that does not consider the rest of nature as having any relation to their work.

This progressive division of labour follows a natural law: and it is perhaps fit that science should itself give a capital illustration of the application of this law to forms of thought, as well as to the more concrete things of the world; but it is an open question whether or no it is advantageous to the best interests of learning. There can be no question that the search for truth of a certain quality is very greatly helped by this principle of divided labour. If a man wish to get the most measurable yield out of the earth in any way, the best thing for him is to stake off a very small claim, tie himself down to it, fertilise it highly, till it incessantly, and forget that there are blossoms or fruit beyond his particular patch; for any moment of consciousness of such impracticable things as grow beyond his field is sure to find expression when he comes to dig his crop, whether his crop in the intellectual field be elements or animals, stars or animalcula. The harvest of things unknown is most easily won in this kitchen-gardening way of work.

The world needs, or fancies that it needs, this kind of work; and it is now of a mind to pay more of its various rewards for the least bit of special and peculiar knowledge than for the widest command of varied learning. In a thousand ways it says to its students, not only as of old, "Study what you most affect," but, "*Effect that study altogether*, know the least thing that can be known as no one else knows it, and leave the universe to look after itself."

This is the prescription of our time. We are now proceeding on the unexpressed theory that, because no man can command the details of all science, therefore he shall know only that which he can know in the utmost detail. We seem to be assuming, that, if many separate men each know some bit of the knowable, man in general will in a way know it all; that when, in another hundred years of this specialisation, we have science divided into a thousand little hermit-cells, each tenanted by an intellectual recluse, we shall have completed our system of scientific culture. No one can be so blind to the true purposes of learning as to accept this condition of things as the ideal of scientific labour. It may be the order of conquest, the shape in which the battle against the unknown has to be fought; but beyond it must lie some broader disposition of scientific life,—some order in which the treasures of science, won by grim struggle in the wilderness of things unknown, may yield their profit to man.

The questions may fairly be asked, whether we have not already won enough knowledge from nature for us to return, in part, to the older and broader ideal of learning; whether we may not profitably turn away a part of the talent and genius which go to the work of discovery to the wider task of comprehension; whether we may not again set the life of a Humboldt along with the life of a Pasteur, as equally fit goals for the student of nature.

Until we set about the system of general culture in science, it will be nearly impossible to have any proper use of its resources in education. A sound theory of general culture in science must be preceded by a careful discussion of the mind-widening power of its several lines of thought. This determination cannot be made by men versed only in their own specialties; it must be made by many efforts to determine by comparison what part of the sciences have the most important power of mind-developing. At present there are few men whose opinion on such a subject is worth anything, and the number constantly grows less.

The greatest difficulty partly expresses itself in, and partly rises from, the multiplication of societies which include specialists as members, and specialties as the subjects of their discussions. We no longer have much life in the old academies, where men of diverse learning once sought to give and receive the most varied teaching. The geologists herd apart from the zoologists: and in zoology the entomologists have a kingdom to themselves; so have the ornithologists, the ichthyologists, and other students. "That is not my department," is an excuse for almost entire ignorance of any but one narrow field. If naturalists would recognise this "pigeon-holing," not only of their work, but of their interests, as an evil, we might hope to see a betterment. Until they come to see how much is denied them in this shutting-out of the broad view of nature, there is no hope of any change. Special societies will multiply; men of this sort of learning will understand their problems less and less well; until all science will be "*caviare* to the general," even when the general includes nearly all others beyond the dozen experts in the particular line of research.

The best remedy for this narrowing of the scientific motive would be for each man of science deliberately to devote himself, not to one, but to two ideals, *i.e.* thorough individual work in some one field, and sound comprehension of the work of his fellows in the wide domain of learning—not all learning, of course, for life and labour have limits, but of selected fields. In such a system there will be one society-life meant for the promotion of special research, and another meant for the broader and equally commendable work of general comprehension.

It is in a certain way unfortunate that investigation is to a great extent passing out of the hands of teachers. This, too, is a part of the subdivision work; but it is in its general effects the most unhappy part of it. As long as the investigator is a teacher, he is sure to be kept on a wider field than when he becomes a solitary special worker in one department.

The efforts now being made for the endowment of research will, if successful, lead to a still further tendency to limit the fields of scientific labour. A better project would be to keep that connection between inquiry and exposition from which science has had so much profit in bygone times.

#### TWO GREEK GEOMETERS

DR. ALLMAN in his article "On Greek Geometry from Thales to Euclid," in the current volume of *Hermathena* (vol. v. No. 10), discusses in Chapter IV. the discoveries of Archytas of Tarentum, and in Chapter V. those of the Greek geometer Eudoxus of Cnidus.

Archytas was a contemporary of Plato (428–347 B.C.), probably senior to him, and saved his life when Plato was in danger of being put to death by the younger Dionysius. These particulars and others of interest are skilfully arrayed by the author; one only of these we recall, *viz.* Horace's reference to the death of Archytas by shipwreck in an ode (Book I. 28), in which he recognises his eminence as an arithmetician, geometer, and astronomer. Unfortunately no undoubted works of his have come down to us; the authenticity of some that have been attributed to him is here discussed, but these do not treat of geometry. In former chapters his contributions to the doctrine of proportion and his demonstrations of theorems as well as solutions of problems have been noticed. Here the question of his identity with the Archytas of Boethius' *Ars Geometria* is discussed, and a strong case made out for the same. The connection of Archytas with the Delian Problem (already touched upon in *Hermathena*, vol. iv.) next comes under consideration, and the passage in Eutocius is translated at length and accompanied by a figure. An enumeration of the theorems which occur in this passage is made,

whence we see that this geometer "was familiar with the generation of cylinders and cones, and had also clear ideas on the interpretation of surfaces; he had, moreover, a correct conception of geometrical loci and of their application to the determination of a point by means of their intersection." Dr. Allman further maintains that in this solution "the same conceptions are made use of, and the same course of reasoning is pursued, which, in the hands of his successor and contemporary Menoëchmus, led to the discovery of the three conic sections. Such knowledge and inventive power surely outweigh in importance many special theorems." In arriving at these views he has to combat (which he does in some detail and apparently with success) the reasoning of Cantor, which is "based on a misconception of the passage in which the word *τόπος* occurs." Dr. Allman insists that *τόπος* means *place* and not *locus* (as used by mathematicians). The whole discussion is well worthy of the careful attention of all interested in the history of geometry: we must forbear to enter into the matter further.

Eudoxus (born about 407 B.C.), a pupil of Archytas, was an astronomer, geometer, physician, and lawgiver, and hence a noteworthy man in more ways than one. Here again Dr. Allman, one of whose great merits is his independence and his thorough examination of the original authorities, differs from Boeckh and Grote, but we cannot give details. A full discussion of the additions to geometry made by Eudoxus follows, and from it we learn how great he was as a geometer; his contributions to astronomy must be sought for elsewhere, though they too come under notice. "This eminent thinker—one of the most illustrious men of his age, an age so fruitful in great men, the precursor, too, of Archimedes and of Hipparchus—after having been highly estimated in antiquity, was for centuries unduly depreciated; and it is only within recent years that, owing to the labours of some conscientious and learned men, justice has been done to his memory, and his reputation restored to its original lustre." The article under notice will considerably conduce to this right placing of Eudoxus, amongst whose merits the least is not that he was a true man of science. "Of all the ancients, no one was more imbued with the true scientific and positive spirit than was Eudoxus." Five reasons for this statement follow, and the article closes. The whole paper is a most interesting as well as valuable one; indeed the interest grows as the author approaches his goal, and we venture to predict for Dr. Allman, when his articles appear in a volume, a most cordial welcome from all mathematicians.

#### THE ROYAL GARDENS AT KEW

THE Report of the Director on the Progress and Condition of the Royal Gardens at Kew for the year 1882 was unavoidably delayed. It bears date only from November 1, 1883, and was not published until well on in 1884. The date of the Report has, however, nothing to say to its interest and merit, and there is always plenty of both in these too short accounts of the great work carried on at Kew. Passing over some details, noting that the amount of damage which the collections have suffered has been, notwithstanding the unprecedented number of visitors, practically *nil*, and that the lecture-classes for young gardeners continue to give satisfactory results, we find an account of the formation of a Rock Garden at Kew. The site selected lies between the wall bounding the Herbaceous Ground on the east and the New Range on the west. The general idea in laying out this space was to imitate in some measure the rocky course of some Pyrenean stream; the dry bed is represented by the broad walk (8 feet wide and 514 feet long), while on either side are the rock-piled banks, in the interstices and pockets of which grow the Alpine plants, and above all are thickets of box and rhododendrons. Tree stumps have been

somewhat freely used here and there. That some plants grow well on them will be admitted; that by their decay they require renewal is their chief drawback. The collection of 2630 plants bequeathed to the Gardens by Mr. Joad formed a splendid commencement to the Rock Garden series, and this section of the grounds has long since proved not only a centre of attraction to the general visitors, but has been a source of pleasure and profitable study to many an amateur gardener. An apology is made for not attempting some geographical arrangement of the Alpines; one was hardly needed. Where the plants grow best there ought to be their (artificial) habitat, and the practical gardener well knows what strange bed-fellows plants often are, and how marvellously they vary in their tastes. Within the last six weeks we noted two finely-grown plants of that popular Alpine cudweed, the edelweiss; one was flowering out of a crack in a dry limestone wall, the other was on a deep clay bank.

The elaboration of the natural family of the palms for the "Genera Plantarum" of Benth and Hooker led the Director to make a critical study of the species of palms in cultivation at Kew, the collection of which proved to be of unexpected richness. In an appendix is a classified list of 420 palms at present in cultivation at Kew. This collection has now but two rivals—the magnificent collection at Herrenhausen, Hanover, chiefly made by Herr Wendland, and that of the unrivalled tropical gardens at Buitenzorg in Java.

The report about the Arboretum shows an enormous amount of work accomplished. While the collection is one of the richest in existence, its importance is gradually more and more dawning upon those interested in planting, and its national importance in this respect should not be overlooked.

The part of the Report giving extracts from the large colonial correspondence that centres at Kew is full of interest, none the less so that much of the information is of a date often far on in 1883. The Argan tree seems likely to be acclimatised at Natal from seeds sent from Kew. The india-rubber (Ceara), introduced from Kew into Ceylon, seems in a fair way of paying as well as Cinchona. Dr. Trimen says it will grow anywhere up to almost 2500 feet, and its commercial success is most satisfactory. "About six months ago (October 24, 1883) some Ceara-rubber seed was imported from Ceylon into Southern India. The produce of these trees may now be seen flourishing in a wonderful manner at the foot of the Neilgherry Hills. The rapid growth of the trees is marvellous. Some which were six months old from seed were fully eight feet high; and a cutting, said to have been planted scarcely six months previously, was quite eight feet high, and was in blossom. It seems to thrive on poor soil, requires shelter but not shade, and very little rain. The demand for the produce seems to be unlimited." Of the mahogany seeds sent from Kew in 1863 to Mauritius, nine of the trees raised bore seeds in 1881, and numerous seedlings were found self-sown. In a report from the Seychelles allusion is made to "three different diseases which have seriously affected the cocoa-nut palms," whereby large forests of these valuable trees have been destroyed. No details are given as to what these diseases are, though they "have nearly stopped their depredations since 1882." In the same report it is mentioned that the remains of the clove plantations cover "about 250 acres"—surely a mistake. It is also stated that the Liberian coffee sent from Kew in 1880 has proved a success, and that about 100 acres of it have been recently planted. The report on *Cinchona robusta* quotes with approval Dr. Trimen's views on the hybrid forms of the Nilgiris—known under the names *pubescens* and *magnifolia*—now settled to be hybrids between *C. succirubra* and *C. officinalis*.

Among the more important additions to the Herbarium may be mentioned the collection of European and exotic lichens made by the Rev. W. A. Leighton, the type speci-

mens of Mr. Wilson Saunders's *Refugium Botanicum*, the Madagascar collection of the Rev. R. Baron—this latter of over 1100 species.

\* Reference is also made to the "North Gallery," an illustration of which is added to the Report. The collection of separate pictures of plants in the gallery amounts in number to 627, and has since been added to.

It will be seen from this brief sketch of Sir Joseph Hooker's Report that the work done at Kew is as varied as it is important, and that our colonies directly and our mother country indirectly are under lasting obligations to the zeal and energy of all concerned in the management of this great institution.

#### MR. THORODDSEN'S GEOLOGICAL EXPLORATIONS

ALTHOUGH situated at a comparatively short distance from Europe, and notwithstanding the frequent visits of late years by English tourists, Iceland is yet very far from being a well-known country. The upland is still, for the most part, an unexplored region, and there are whole districts where no man, native or foreign, ever set his foot, owing, chiefly, to the difficulties and dangers which attend travelling through these wildernesses. Foreigners travel mostly along beaten tracks; they come mostly without having acquired any previous knowledge of the peculiar nature of the country, consequently not knowing what parts are most worth visiting or exploring. Yet these regions are eminently interesting for students of natural science, being filled with innumerable glaciers, some of enormous magnitude, with multitudes of volcanoes, eruptive springs, &c., which it is of the greatest importance should be scientifically explored and described. In order to obtain reliable information about these upland wilds of the country, the Government of Iceland have commissioned Mr. Th. Thoroddsen to undertake systematic explorations with a view to establishing the geology of the country on a sound basis, and correcting its geography where necessary; for this purpose he has already undertaken various expeditions. In the course of last summer (1883) he explored the peninsula of Reykjanes and its upland connections. Although this part lies in close proximity to the inhabited parts of the country, it has hitherto remained for the most part a *terra incognita* on account of the innumerable waterless and utterly barren lavas which are crowded into it, and make travelling excessively arduous. Formerly people only knew that within historic times two volcanoes had been active in these parts. Mr. Thoroddsen has now determined the existence and site of no less than *thirty* separate volcanoes with at least *seven hundred* craters. In each case he has made all necessary measurements, and has constructed a geological map of the whole district.<sup>1</sup> The aggregate extent of the lavas covers about 44 square (geographical) miles. Out of the lavas up and down this tract there rise mountains composed of tufa and breccia, and through these the eruptions of the volcanoes proper have found their vent. Cases of individual volcanoes being built up in one spot by repeated eruptions are rare. The craters are in most cases traceable in distinct long rows, like pearls on a string, along terraces of tufa, situated along chasms through which the lava welled out. In some places there are no craters, the lava having boiled out of the chasm over either side of it, in which cases the rift remains open with its brims covered with a glazed crust of lava. In other localities are found volcanoes of colossal size, broad sublevations or convexities of lava, with a large crater at the apex from 800 to 1000 feet in diameter, instances of which are Skjaldbreid, 3400 feet, and Heidin-Há, 2000 feet above the level of the sea. Throughout the lava stretches one comes upon enormous fissures all following the same direction as the rows of the craters,

<sup>1</sup> published by the Geological Association of Stockholm.

namely, south-west to north-east. All about this district there are also found numbers of hot springs, solfataras, and boiling clay-pits. This peninsula, Mr. Thoroddsen maintains, must be one of the most thoroughly burnt spots on the globe, and a pre eminently instructive tract for geologists who make volcanic manifestations the speciality of their study.

This summer Mr. Thoroddsen is engaged in exploring the enormous lava wilderness of Odáðahraun, covering the central part of Iceland, and, as yet, for the most part entirely unknown. In the glaciers to the south of this wilderness great eruptions have taken place of late years, about which nothing is known, no one having as yet ventured into these wilds, lying 3000 to 4000 feet above the level of the sea. The difficulties of exploration here are enormously aggravated by the utter barrenness of the region, by scarcity of water, and by the frequent snow tempests by which the region is constantly harried even in the midst of summer. Even the compass is not to be relied upon, on account of the mass of iron which enters to such a large extent into the composition of the lava.

*Akreyri, June 24, 1884*

Grimsey is the name of a small island, situated in the Arctic Ocean, about 22 English miles due north of the promontory which divides the bays of Eyja-Ga-u and Skagafjord in Northern Iceland. It is inhabited by 88 human beings, debarred from all communication with the outer world, and equally ignorant of its motive thought as of its stirring events. Their intercourse with outward surroundings is confined to Arctic ice and ceaselessly recurring storms. Only once or twice a year they manage in their small open boats, at a perilous risk, to effect a landing on the mainland, for the purpose of obtaining by barter their necessities of life at some of the north coast trading stations.

The island having never before been visited by a naturalist, I eagerly embraced the opportunity of joining the governor of the North District on an expedition to it, undertaken at the instance of the commander of the gun-boat *Diana*, Capt. O. Irminger, of the Danish navy. In the evening of June 19 we steamed, in calm weather, from Akreyri down the broad bay of Eyja-fjord, enjoying the imposing scenery of the mountains on either side, lit up by the subdued vermilion tints of the nocturnal sun glare; when we reached the mouth of the bay, we had a full, un-intercepted view of the midnight sun, resting on the oceanic sky-line, like a ball of fire behind a veil of blood. Out of the inert calm of the deep, which looked like polished glass, there rose on either side of us black precipitous rocks that formed, as it were, the advanced basis of the snow-capped mountain-tops, which determined our sky-line in the landward distance.

We reached Grimsey at three o'clock in the morning of the 20th, still, as good luck would have it, favoured by the same calm weather and quiet sea—both being the indispensable condition of effecting a safe landing on the island. We took the shore just below the parsonage in a bright formed of precipitous rocks made of basaltic columns, here and there split up by yawning caves; and having succeeded in clambering to the top of the rocks, we set about exploring the island.

The formation of Grimsey is basaltic throughout, and, geologically speaking, resembles, closely on the whole, the stratification of Northern Iceland. From its non-volcanic nature one may therefore fairly assume that, once upon a time, it must have been connected with the mainland. But, though not volcanic itself, it seems that Grimsey is not very far removed from the lines along which the active subterranean fires in Iceland are operating. At various times the inhabitants state they have observed towards the south-east signs of submarine volcanic action, and towards Tjörnes (S.S.E.) a column of fire was distinctly observed breaking through

the surface of the sea in 1868; this, too (one of the northernmost promontories of Iceland), has frequently been visited by violent earthquakes, notably so in 1872. Towards the east the island rises precipitously out of the sea to the height of upwards of 300 feet, but slopes to the westward, where all the habitations of the people are scattered about. The flora is scanty, and the plants stunted in a remarkable degree; as far as I had opportunity to observe, the vegetation seemed to bear a distinct Arctic impress as compared with that of the mainland. The sward is covered with Arctic willow (*Salix herbacea*), resembling the same plant when met with on the mainland at an elevation of 1500 to 2000 feet above the sea-level. The flora of the eastern portion of the island is much more varied, as compared with that of the western, owing to the soil being much more fertile there from the guano deposited by the multitudes of birds which haunt that part of the island. Every ledge of rock is covered with the so-called "Skarfa-kál" (scurvy-kale, scurvy-grass, or spoon-wort, *Cochlearia officinalis*). Altogether I managed to collect here between fifty and sixty species of plants, all of which are also found on the mainland, only these are of a more stunted growth. No heath vegetation occurred, and no ligneous, if I except the above mentioned willow, which only grows to the height of six inches and a half.

The temperature of Grimsey is much milder than might be supposed from the geographical position of the island. Although it is visited every two out of three years by the Arctic ice, the average temperature of the year is  $+1^{\circ}4$  Celsius. August is the hottest month in the year,  $+7^{\circ}5$  C.; March the coldest,  $-3^{\circ}5$  C. The highest degree of heat in 1876 was  $+20^{\circ}$  C.; the greatest cold in 1880,  $-30^{\circ}$  C. The mildness of the temperature is accounted for by the fact, ascertained of late years beyond a doubt, that a small branch of the Gulf Stream splits off from the main current on encountering the resistance of the western submarine spurs of the rocky masses on which Iceland is built up, the flow of which branch, on wheeling round the north-western peninsula of the country, takes an eastward direction along the whole extent of the northern coast. The average temperature of the sea round Grimsey is about  $4^{\circ}$  C. in January and  $3^{\circ}$  C. in February. The pastor of the island, M. Pjetur Gudmundsson, has for many years been engaged in exceedingly careful meteorological observations on behalf of the Meteorological Institute of Copenhagen. This most worthy gentleman, living here in conspicuous poverty, like a hermit divorced from the world, though he has the comfort of a good wife to be thankful for, is not only regarded as a father by his primitive congregation, but enjoys moreover the reputation of being in the front rank among sacred poets in modern Iceland.

The inhabitants derive their livelihood, for the most part, from bird-catching, nest-robbing, and deep-sea fisheries. The precipices that form the eastern face of the island are crowded with myriads of various kinds of sea-fowl. On every ledge the birds are seen thickly packed together; the rocks are white with guano, or green-tufted with scurvy-grass; here everything is in ceaseless movement, stir, and flutter, accompanied by a myriad-voiced concert from screamers on the wing, from chatters on domestic affairs in the rock-ledges, and from brawlers at the parliament of love out at sea, the surface of which beneath the rocks is literally thatched at this time of the year with the wooing multitudes of this happy commonwealth. If the peace is broken by a stone rolled over the precipice, or by the report of a gunshot, the air is suddenly darkened by the rising clouds of the disturbed birds, which, viewed from the rocks, resemble what might be taken for gigantic swarms of bees or midges.

The method adopted for collecting eggs is the following:—Provided with a strong rope, some nine or ten stal-

wart men go to the precipice, where it is some 300 feet high, and one of the number volunteers or is singled out by the rest for the perilous "sig," i.e. "sink," or "drop," over the edge of the rocks. Round his thighs and waist, thickly padded generally with bags stuffed with feathers or hay, the "sigamadr," "sinkman," or "dropman," adjusts the rope in such a manner as to hang, when dropped, in a sitting posture. He is also dressed in a wide smock or sack of coarse calico, open at the breast, and tied round the waist with a belt, into the ample folds of which he slips the eggs he gathers, the capacity of the smock affording accommodation to from 100 to 150 eggs at a time. In one hand the "sinkman" holds a pole, 16 feet long, with a ladle tied to one end, and by this means scoops the eggs out of nests which are beyond the reach of his own hands. When the purpose of this "breath-fetthing" "sink" is accomplished, on a given sign the "drop-man" is hauled up again by his comrades. This, as may readily be imagined, is a most dangerous undertaking, and many a life has been lost over it in Grimsey from accidents occurring to the rope.<sup>1</sup>

For the pursuit of the fishery the island possesses fourteen small open boats, in which the men will venture out as far as four to six miles cod-fishing; but this is a most hazardous industry, owing both to the sudden manner in which the sea will rise, sometimes even a long time in advance of travelling storms, and to the difficulty of effecting a landing on a harbourless island.

Now and then the monotony of the life of the inhabitants is broken by visits from foreigners, mostly Icelandic shark-fishers, or English or French fishermen.

Of domestic animals the islanders now possess only a few sheep. Formerly there were five cows in the island, but the hard winter of 1860 necessitated their extermination, and since that time, for twenty-four years, the people have had to do without a cow! Of horses there are only two at present in the island! Strange to say, the health of the people seems, on the whole, to bear a fair comparison with more favoured localities. Scurvy, which formerly was very prevalent, has now almost disappeared, as has also a disease peculiar to children, which, in the form of spasm, or convulsive fit, used to be very fatal to infant life in former years.

Inexpressibly solitary must be the life of these people in winter, shut out from all communication with the outer world, and having in view, as far as the eye can reach, nothing but Arctic ice. The existence of generation after generation here seems to be spent in one continuous and unavailing Arctic expedition. The only diversion afforded by nature consists in the shifting colours of the flickering aurora borealis, in the twinkling of the stars in the heavens, and the fantastic forms of wandering icebergs. No wonder that such surroundings should serve to produce a quiet, serious, devout, and down-hearted race, in which respect the Grimsey men may perhaps be said to constitute a typical group among their compatriots. However, to dispel the heavy tedium of the long winter days, they seek their amusements in the reading of the Sagas, in chess-playing, and in such mild dissipations at mutual entertainments at Christmas-time as their splendid poverty will allow.

TH. THORODDSEN

#### SEATS IN RAILWAY CARRIAGES

IN a recent article in *Science et Nature* the writer, after animadverting on the lateness of the day at which shoemakers have at length begun, though still very imperfectly, to take account of the osseous framework of the human foot, proceeds to investigate the relation between

<sup>1</sup> This is a fate that befalls too many of the "sinkmen" of Iceland, for there are numbers of them all round the coast. It would be easy, at a very small cost to the treasury of Iceland, to provide a perfectly safe movable apparatus for every district where life must be sustained at the above-described risk. The authorities would, no doubt, readily meet any reasonable request on the subject.—E. M.

the structure of the human trunk and that of the seat, more particularly in railway carriages, designed for its accommodation. In a sitting posture the pelvis has for its sole function the support of the upper part of the

ports for the back, the shoulders, and the head. So far as these are wanting, the body will tend of itself, unless counteracted by an effort of will and nervous force, to bend forward, till at last the forehead finds the knees to lean on. The position of the body in sitting is all the easier, and its rest all the more complete, the more decided is the inclination of the back of the seat and the more obtuse is the angle formed by the trunk and

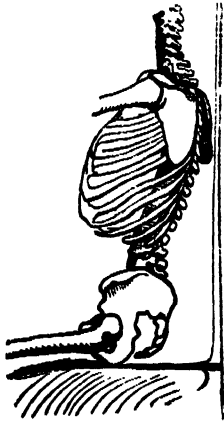

FIG. 1.

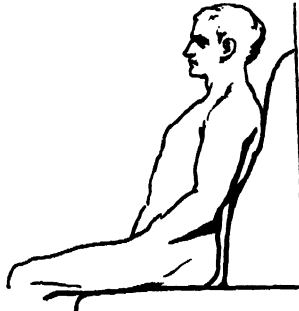

FIG. 2.



body. The spinal column, however, is inserted in the pelvis, not in the form of a straight line but of a curve (Fig. 1). This inflection on the part of the backbone, while adding to the mobility of the trunk, imposes on it

the thighs. Seats such as the *dormeuses* realise the most favourable conditions in this respect.

Fig. 2 represents a man comfortably seated and propped. The back of the seat supports him principally under the shoulder-blades, offers the chest a depression to sink in, and altogether keeps the upper part of the body in a free and easy position. Fig. 3 shows the same person in a similar position, but with his head resting

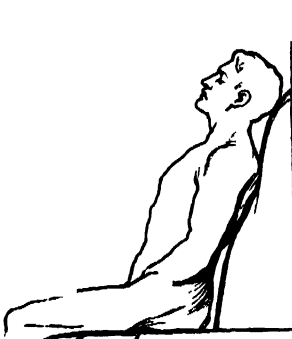

FIG. 3.



FIG. 4.

the necessity of a continual balancing movement, the centre of gravity being shifted every time the head and thorax sway to one side or the other. Such balancing

behind. In both these figures the back of the seat is seen exactly in profile, and to the writer of the article such seems the construction which is most convenient in railway carriages.

Fig. 4, on the other hand, represents the profile of a man seated as passengers are in many of our actual first-class carriages. His position is perceived to be a forced one in contrast with that just noticed, and alto-

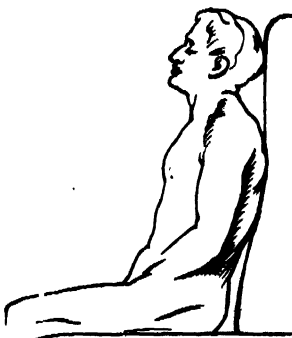

FIG. 5.

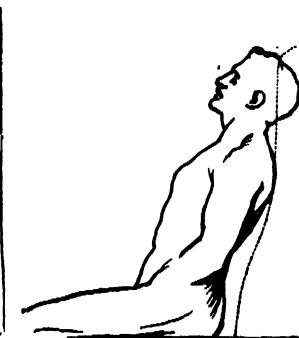

FIG. 6.

movement is necessarily also attended by a certain expenditure of energy. To allow the upper part of the body to remain comfortably at rest there must be sup-

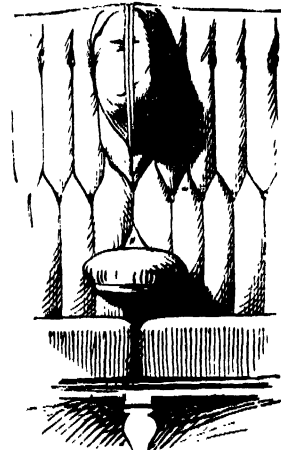

FIG. 8.



gether disagreeable. Fig. 5 shows exactly the stiff attitude the head is compelled to take in order to rest.

Finally, Fig. 6 reproduces the comfortable position indicated in Fig. 3, and at the same time represents the profile of the back of the seat actually in use in our railway carriages. On comparing this profile with the position of the man comfortably supported, the following defects in the back of the seat are observed:—

1. It is too vertical.
2. It allows an empty space between the lumbar vertebræ and the lower extremity of the shoulder-blade exactly at the place where one is in the habit of putting a cushion "behind the back," as it is called.
3. It is at least half a foot too high, and so makes it impossible for the head to rest behind. It is customary to make the back of the seat tally with the height of a man of average size seated bolt upright.

Under the actual conditions, such as they have been

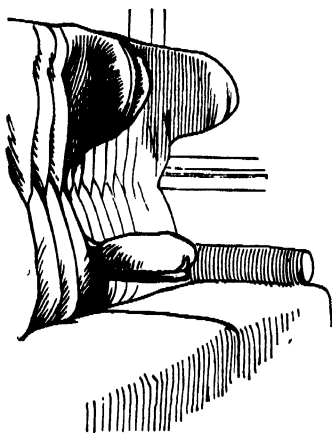

Fig. 9.

described, what becomes of the traveller when sleep at length overtakes him? Little by little he slides down on his seat till the lower extremity of his shoulder-blades, which has most need of support, finds the most sensible projection, which, as the backs of our railway carriages actually are, is precisely where it is least serviceable—at a point, namely, on a level with the region of the pelvis. Lastly, the head inclines forward or to the side, if it does not bury itself in the breast (Fig. 7).

Fig. 8 gives a front view of the face of the bench serving as the back of the seat. In the centre is seen a stuffed projection, on each side of which a passenger may rest his cheek. The shoulder, getting no separate support, must contrive to lodge itself between this stuffed projection and a kind of plateau fixed in the side of the back of the seat, and which, situated about a hand's breadth above the seat, offers a resting-place to the elbow (Figs. 8 and 9).

#### A NEW PRINCIPLE OF MEASURING HEAT

THE following method is intended to fulfil some conditions which probably will be more and more urgently required in the progress of modern science:—

1. *Measurements of heat should be executed at constant temperature, i.e. without the aid of thermometers.*—Every variation of temperature during calorimetric experiments causes unavoidable errors and necessitates corrections and compensations. The accuracy of the thermometric method ["method of mixture," of Regnault], which now predominates among experimentalists is unrivalled, only in those cases where the amount of heat to be measured is developed in the course of a few seconds or minutes; it is seriously impaired whenever the experiment lasts longer, while the

influence of the corrections for radiation, &c., increases proportionately with the duration of the operation. The first method used in thermo-chemical investigations, the ice-melting method of Lavoisier and Laplace, as well as the modern calorimetric method by Bunsen, avoids this inconvenience by executing all measurements at the melting-point of ice. Bunsen's ice calorimeter is, however, not exempt from corrections. Every physicist familiar with the use of this instrument will also, like the author, be well acquainted with its capriciousness. Bunsen prescribes that the calorimeter should be placed in a large vessel filled with absolutely pure snow. Although I have had abundant quantities of the purest snow at my disposal, I do not hesitate to declare, having tried, in company with Prof. Nilson, a whole winter to obtain reliable results with the original arrangement of the inventor, that the instrument would be impracticable for use without the improvement devised by Schuller and Wartha, viz. to immerse the calorimeter in a vessel containing ice and pure water at  $0^{\circ}$  C. Still the advantage of this arrangement is not to prevent variations in the position of the mercury index, but to make them quite *regular*. These variations are declared by some physicists to depend upon the vacillation of atmospheric pressure, but I think that the real

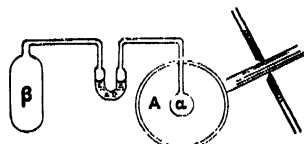

Fig. 1

cause of the unsteadiness of the index of the instrument lies in the peculiar behaviour of the ice in the vicinity of its melting-point. It was believed hitherto (and Bunsen's method theoretically rests upon this assumption) that ice at  $0^{\circ}$  C. suddenly changes its specific volume from that of ice [= 1.090686]<sup>1</sup> to that of water [= 1.000000]. I admit that this assumption may be true with regard to *absolutely pure ice*, but in every kind of frozen water which contains the smallest trace of impurity (which is unavoidable if the water has been boiled assiduously in a glass vessel) the transition of ice into liquid water is not sudden, but gradual, and begins already a little below  $0^{\circ}$  C. Such ice does not attain its maximum of volume exactly at  $0^{\circ}$  C., but some hundredths or tenths of a Centigrade degree below  $0^{\circ}$  (dependent upon its relative purity). Graphic representation<sup>2</sup> shows that the co-ordinate of specific volume of the ice comes not to a *point d'arrêt* at zero, but moves upon the rapidly-sloping branch of a curve just in the immediate vicinity of the melting-point. Now suppose the water in the external vessel to be either a little purer than that of the calorimeter, or *vice versa*. In the

<sup>1</sup> This number, which is almost identical with that of Bunsen, was found by the author in his research "Upon the Properties of Water and Ice," *Vegs-expeditionens vet. iakttagels.*, Bd. ii. p. 275.

<sup>2</sup> See the paper "Upon Water and Ice," by O. Pettersson, &c.

former case its temperature, *i.e.* its melting-point, will be situated a few thousandths of a Centigrade higher, and the volume of the ice in the calorimeter will move down-

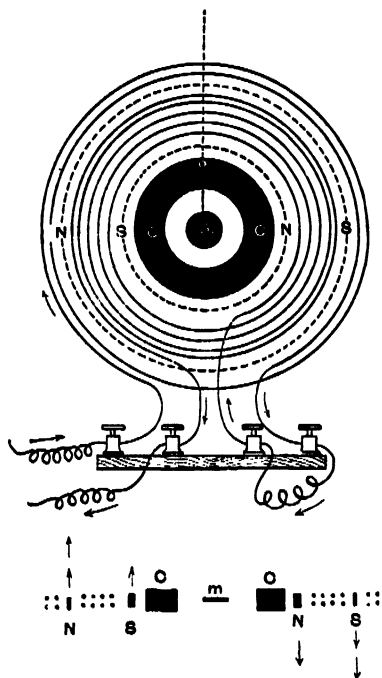

Fig. 2

wards on the branch of the curve in the attempt to gain the temperature of the surrounding medium. Then the index will move slowly backwards; in the other case the co-ordinate of specific volume will move upwards on the

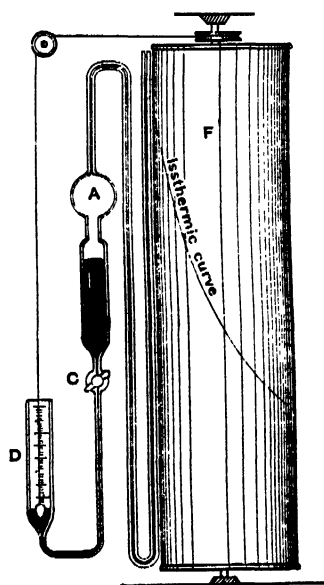

Fig. 3

sloping branch, and the index of the scale-tube will march forwards. These remarks may be sufficient to explain why there has been much dispute about the absolute

magnitude of the caloric units indicated by the ice calorimeter of Bunsen, and why this instrument is always empirically graduated, although its principle ought to allow of absolute measurements.

II. *The amount of heat developed in calorimetric experiments should be directly transformed into work and measured in absolute units [kilogramme-metres].*<sup>1</sup>—In every branch of physical science this manner of measurement is beginning to introduce itself, as, for example, in electricity, magnetism, &c. In thermal determinations it has the great advantage that the mechanic units are 430 times greater than the thermic units, and can be far more accurately determined.

III. *The principle should be applicable to the measurement of all kinds of caloric energy: as, specific heat, radiant heat, the heat absorbed or developed by chemical reactions, &c.*—It must be remarked that I have hitherto experimented only with radiant heat. An apparatus intended for other kinds of heat is under construction,

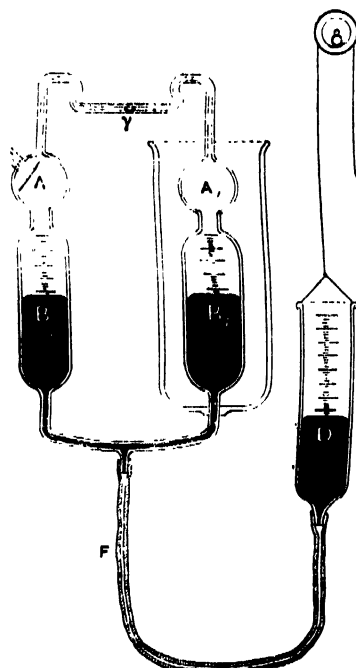

Fig. 4

but as this will take some time, and as I wish specially to direct my labour to the determination of the sun's radiant heat, I take the opportunity now of calling the attention of physicists to the principle of the method, which I foresee can be developed and varied in a multitude of ways. In case the matter should interest anybody sufficiently to make him try it experimentally, I will give some information in order that he may not be detained by those difficulties which have baffled my own efforts during nearly six years. The principle is extremely simple, and will be easily understood by a glance at the diagram (Fig. 1).

Let a beam of heat rays fall upon the thin glass wall of the reservoir A, which contains dry air. As soon as the thermometer  $\alpha\beta$  indicates that the temperature of the air in A increases, let mercury escape through the stopcock C. Thereby the air expands, and the heat received by radiation is transformed into mechanic work, as the level of mercury in B sinks under the influence of the expanding force imparted to the air by the radiant heat.

<sup>1</sup> I denote this in the following by the sign M:K°.

As the air in A in this case has expanded *isothermically*, the mechanic work is represented by the equation

$$x = p_0 v_0 \log_{\text{nat}} \frac{v}{v_0},$$

where  $p_0 v_0$  are the initial pressure and volume of the air in A, and  $v$  is its volume after the expansion. If we suppose that a beam of sun rays during a minute has fallen upon the blackened surface of A through a hole of a square centimetre, and that the experimenter has neutralised the tendency of the air to increase in temperature by careful manipulation of the stopcock C, which allows the air to expand its volume as it displaces the escaping mercury—suppose that in this way the cooling effect of the expansion has neutralised the tendency of the air to augment its temperature under the influence of the heat radiation, so that the index of the thermometer has been kept *constantly* at its initial point, then the *entire* amount of solar heat imparted to the glass reservoir A is converted into mechanic work by means of the isothermic dilatation of the air, and the value of  $x$  found by the above equation represents what is called by modern scientists "the solar constant."<sup>1</sup>

It is obvious that the chief difficulty lies with the thermometer. The indications of this part of the instrument must be *extremely sensitive* (up to some thousandths of a degree Centigrade) and *instantaneous*, in order that the experimenter may be able to regulate the expansion so that a real isothermic dilatation takes place. I judged that only two kinds of thermometers could suit the purpose, and tried first a differential glass thermometer. This is in fact very sensitive, but as the pressure in A diminishes during the experiment, the bulb  $a$  expands somewhat, and this has a disturbing influence upon the index. I next inserted in A a network of very thin thermo-electric elements (combinations of iron and German silver), and observed the alterations of temperature of the air in A by means of a mirror galvanometer. As I found the ordinary system of magnets in galvanometers far too heavy for the instantaneous deflections here required, I constructed a new kind of galvanometer, whereof I give a schematic view in Fig. 2, because I think that it may really do some good work in other cases, as it proved to be extremely sensitive. The dotted lines represent a system of two concentric (annular) magnets made of steel springs (from watches), each magnetised to saturation between the poles of a powerful Plücker electro-magnet. They are combined in the astatic manner, but the dimensions of the material are chosen so that the *inner* magnet has just sufficient force to keep the whole system in the magnetic meridian. The figure shows the position of the insulated copper wires relatively to the magnets. M is a mirror of very thin silvered glass; CC is a massive copper ring. I tested the sensibility of the instrument by adiabatic expansion of the air in A. This was effected by opening the stopcock C for a moment. The slightest dilatation of the air in this manner immediately showed its cooling effect by a deflection of the scale in the mirror, but as the deflection soon brought the magnets out of the electric field, the *amplitude* of the oscillation was, as I had calculated, not great. However, as the oscillations did not cease instantaneously, I found the method impracticable for *continuous* observation. I then abandoned the project of regulating the isothermic expansion by means of a thermometer altogether.<sup>2</sup>

The next arrangement, which succeeded better, was that shown in Fig. 3. Here the co-ordinates of the isothermic curve are traced out beforehand on the rotating cylinder F. As the mercury in B flows into D, it lifts a float, which, by a combination of wire and blocks,

makes the cylinder rotate at a rate which is proportional to the expansion of the volume of the air in A. Thus the horizontal co-ordinate ( $v$ ) of the isothermic curve is represented. The vertical co-ordinate of the pressure of the air in A ( $p$ ) is represented by the height of the liquid in the open branch of the manometer. The operator only has the task to regulate the outflow of the mercury from B to D by means of the stopcock C, so that the level of the fluid in the manometer closely follows the isothermic line drawn upon the paper envelope of the rotating cylinder. This is not difficult after a little experimenting. Whenever the level in the manometer shows a tendency to rise above the isothermic line, there is a surplus of heat in A waiting for transformation into work, which can be effected by accelerating the outflow of the mercury through C. The area contained between the initial and final ordinates [ $p_0$  and  $p$ , represented by the positions of the column of liquid in the manometer-tube relatively to the cylinder at the commencement and the close of the experiment] represents the value of the integral—

$$p_0 v_0 \int_{v_0}^v \frac{dv}{v}$$

or the amount of mechanic work equivalent to the transformed caloric energy. Thereby this method affords an elegant manner of showing the actual transformation of all kinds of heat into work to an auditory. In order to obtain indications on a grand scale I always used  $H_2SO_4$  tinted blue with indigo in the manometer. The rotating cylinder is about 2 m. high, and a quantity of heat of not more than 876 grammes-calories, imparted by radiation or otherwise to the air in A, makes the cylinder rotate  $360^\circ$ , and the level of the liquid in the manometer sink 1'84 m.<sup>1</sup> The volume of A was 400 c.c., and the initial pressure equal to 1000 mm. (of mercury). But for scientific measurements I cannot recommend this method. The sulphuric acid *adheres* to the glass tube, and does not take up its definitive level *at once*, the dimensions of the apparatus become inconveniently large, the co-ordinate  $p$  cannot be traced out on the paper of the cylinder directly from the isothermic equation,

$$p v = R T_0,$$

but must be recalculated with the aid of some corrections arising from the influence of the atmospheric pressure upon the columns of liquid in the manometer and in D, too complicated to be mentioned here.

Fig. 4 shows a kind of calorimeter which realises the condition of isothermic dilatation of the air in the most simple manner and still is capable of the most accurate measurements.

A and  $A_1$  are very thin glass vessels fabricated of equal shape and size by Franz Müller in Bonn. Both contain dry air over mercury, which stands at equal height in B and  $B_1$ . If the graduated glass tube D, which communicates with A and  $A_2$  through a caoutchouc tube, is raised or lowered by means of the arrangement shown in the figure, the level of the mercury rises or sinks equally in B and  $B_1$ , and the air in A and  $A_1$  is compressed or dilated equally, provided that the temperature is kept *constant* in both. This condition is realised in  $A_1$  by the surrounding large mass of water, which imparts to the air and mercury in  $A_1$  and  $B_1$  its own constant temperature. *The air in  $A_1$  therefore always expands or contracts isothermically.* If its initial volume and pressure are denoted by  $v_0$  and  $p_0$ , the law of Mariotte,

$$v p = v_0 p_0,$$

will always regulate the expansion of the air in  $A_1$ . It is easy to see that this will also be the case in A, if the experi-

<sup>1</sup> Uncorrected.

<sup>2</sup> I think the thing will be very difficult to realise in this way. If another indicator could be substituted for the galvanometer, for example, the Lippmann capillary electrometer in the ingenious form devised by Chr. Lovén, the experiment would be very easy. But, unhappily, this instrument is insensible to thermo-electric currents.

<sup>3</sup> i.e. theoretically. This height is somewhat reduced by the correction for the pressure, &c.

ment is conducted so that during the dilatation of the air in A and A<sub>1</sub>, the index of the differential thermometer  $\gamma$ , which combines both instruments, is kept constant. Suppose then a beam of heat rays to fall upon a thin piece of platinum foil<sup>1</sup> in A through the glass wall. The immediate effect of radiation is to elevate the temperature of the air in A, but as an increase of only 0.0016 of a centigrade causes a displacement of the differential index  $\gamma$  of 1 mm.,<sup>2</sup> it is easy for the operator to compensate this tendency and transform the heat into work by lowering the graduated tube D, which makes the air in A and A<sub>1</sub> expand. This expansion is isothermic in both, because volume and pressure varies in the same way in A as in A<sub>1</sub>, where it, as shown formerly, follows Mariotte's law.<sup>3</sup> The rate of expansion of the air is indicated by the rise of the mercury in the calibrated tube D. The sensibility of the differential index is so great that it requires a very steady hand to regulate the movement of D so that the index keeps constantly at its initial point, without making greater excursions to either side than 1 or 2 mm. Every irregularity in the movement changes the isothermic expansion into adiabatic dilatation or compression. I therefore prefer to regulate the sinking of D by means of a screw. During the experiment A must be protected by isolating screens, &c., from outward disturbing thermal influences. I think I have realised this in a satisfactory way, but as a detailed account of the arrangement would be too long, I must reserve the complete description for a future paper.

Lastly I will mention some examples of determinations of the radiant heat emitted by a regulation gas-burner at 22.5 cm. distance from A. The radiation was admitted through a screen with an opening of  $4\frac{1}{2} \times 2\frac{1}{2}$  cm. The initial volume of the air in A<sup>4</sup> was 622.22 c.c. The pressure was brought to 760 mm. Experiment I. was made at noon, 11. in the afternoon of the same day.

Experiment I.—Increase of volume by expansion during 6 minutes = 185.9 c.c. Mechanical equivalent of the radiation during 6 minutes = 1.680 M.K°. Mechanical equivalent of the radiation during 1 minute = 0.280 M.K°.

Experiment II.—Increase of volume, &c., during 5 minutes = 158.5 c.c. Mechanical effect of radiation in 5 minutes = 1.459 M.K°. Mechanical effect of radiation in 1 minute = 0.291 M.K°.

I have measured in this way the mechanical effect of radiations, the caloric energy of which was only 0.08 of a gramme-calorie in the minute. This method is free from every kind of correction. It is obvious that, by means of a thin test-tube hermetically inserted into A, calorimetric determinations of specific heat, &c., could be made, but I have not yet arranged the apparatus for this purpose.

OTTO PETTERSSON

Stockholms Höghskolas Laboratorium, June 25

### NOTES

THE Government have directed Dr. Klein, F.R.S., and Dr. Henegge Gibbes, to proceed to India to pursue a scientific inquiry into the nature of cholera. It is understood that these gentlemen will act in conjunction with the Commission nominated a few weeks ago by the Indian Government for the same object.

AT the meeting of the Council of the Marine Biological Association on Friday, July 25, Prof. Moseley in the chair, the names

<sup>1</sup> It is blackened in the following way. It is galvanically coated with a thin layer of metallic copper, and afterwards heated in a current of oxygen. This arrangement gives most sensitive indications.

<sup>2</sup> This is the case in the apparatus constructed by the author. The index there consists of a small drop of coloured alcohol. If H<sub>2</sub>SO<sub>4</sub> is substituted for the alcohol, the sensibility of the apparatus is lessened considerably.

<sup>3</sup> In my last constructed apparatus I have substituted a vessel of thin copper instead of the upper part of the glass vessel A<sub>1</sub>. This arrangement answers the purpose excellently.

<sup>4</sup> And also in A<sub>2</sub>, which is of the same size. This condition is, however, by no means indispensable. A<sub>1</sub> can be greater or smaller than A<sub>2</sub>, only the ratio of A and A<sub>1</sub>, B and B<sub>2</sub>, are proportional to each other.

of Prof. Allman, F.R.S., and Sir John St. Aubyn, Bart., M.P., were added to the list of Vice-Presidents, and Mr. Spence Bate of Plymouth was elected on the Council. It was decided that, provided certain arrangements promised by a committee of the Town Council of Plymouth were carried out, the Association should proceed to erect its first laboratory on Plymouth Sound. Plymouth is not only the best position for the laboratory on account of its natural features, but the local committee has offered to the Association a free site on the seashore and a subscription of 1000*l.* A vote of thanks to H.R.H. the Prince of Wales for having become the Patron of the Association was carried. The financial prospects of the Association were reported as highly satisfactory. The building of the laboratory will probably be commenced in the spring.

THE eighth International Medical Congress is to be held in Copenhagen from August 10 to 16. President, Prof. Dr. P. L. Panum; Secretary, Dr. C. Lange, both of Copenhagen. Among the most eminent of the 658 medical men who have engaged to attend are:—Prof. Lister, Sir William Gull, Bart., Prof. Dr. L. Pasteur, Prof. Paul Bert, and Prof. Dr. R. Virchow.

THE Congress of the British Medical Association opened in Belfast on Tuesday. Prof. Canning directed his presidential address mainly to an analysis of the origin and causes of the spread of epidemic diseases.

THE prospectus has just been issued of the new "Società di Geografia ed Etnografia," founded in Turin in anticipation of the Italian Geographical Congress, which meets in that city on August 15. The Congress is a passing event, but the Society has probably a brilliant career before it, established as it is under the auspices of Prof. Guido Cora, its first President. The well-known *Cosmos* of the distinguished geographer becomes the authorised scientific *Journal* of the Society, a happy arrangement which cannot but prove mutually beneficial. In other respects everything is for the present provisional, and the council, including besides Sig. Cora such names as those of Luigi, Schiaparelli, Enrico Morselli, and Alessandro di Cesnola, holds office only till the beginning of next year, when the statutes will be definitely settled, and a permanent administration established. Meantime it is satisfactory to find that ethnology, a branch of geographical science so strangely neglected by existing geographical institutes, is to receive all due prominence and encouragement. Another important feature is the attention to be paid to commercial and industrial geography, especially as regards Italy in its relations with foreign countries. This idea also, *mutatis mutandis*, might be advantageously adopted by similar learned bodies elsewhere.

THE *Bollettino* of the Italian Geographical Society for July publishes the circular, regulations, and programme of the first Italian Geographical Congress, which meets in Turin from the 15th to the 19th of next August under the presidency of the President of the Italian Geographical Society. All except honorary members to be specially named will be expected to contribute towards the expenses sums varying from ten to thirty francs. In return they will have free access to all the scientific gatherings, and will be entitled to a copy of the *Proceedings* of the Congress. There will be two Sections—a Scientific and Commercial, and questions will be discussed in connection with mathematical, physical, ethnographic, political, economic, and historic geography. Amongst the subjects proposed for discussion are the following:—"What ethnological conclusions are to be drawn from the more recent anthropological and philological data, regarding the indigenous populations of East Africa?" "Considering the part already taken by Italy in scientific exploration in the Polar seas, what are the best means of organising an independent Italian expedition to the Antarctic regions?" "On the need of preparatory schools for training

travellers in the work of exploration." "On the best means of turning to better account for science and commerce the work of Italian explorers." "On the importance of establishing commercial stations in the Barbary States as a means of gaining access to the Sudan"; and "On Geographical Education."

MR. RIVETT-CARNAC sends us a handy reprint of his valuable paper "On the Stone Implements from the North-Western Provinces of India," originally published in the *Journal* of the Asiatic Society of Bengal. The striking resemblance that the remains of the Palæolithic and Neolithic ages bear to each other wherever found in the Old and New Worlds, has often been commented on, and receives fresh illustration from the three plates of celts, arrowheads, hatchets, hammers, weights, and other objects, accompanying the brochure. These specimens are lithographed from photographs, and all made to scale, whereby their value is greatly enhanced for the comparative study of similar objects elsewhere. It is pleasant to learn that the best specimens have all been presented to the British Museum, while casts of some unique types peculiar to India have been made for the chief museums of India, Europe, and America, and even for some private persons interested in prehistoric research.

EVEN in Rome the aerial disturbances caused by the Krakatoa explosion were clearly indicated on the registering barometers. On examining the curves of the Richard barograph Prof. Tacchini found that, although the daily curves followed regularly in accordance with the normal barometrical conditions in Europe, those of August 27, 28, and 29, 1883, betrayed slight indentations, which, without changing the daily record of the pressure, show that for short intervals its precision oscillated abruptly, owing to the passage of the above-mentioned waves. These barometrical oscillations occurred at the following times:—12.7 of the 27th, 5.6 a.m. of the 28th, 1.48 a.m. of the 29th, and, lastly, about 4 p.m. of the same day. The time of the volcanic explosion was determined by Tacchini by the report of S. Raffo, captain of the Genoese brigantine the *Adriatic*. S. Raffo states that during the night of August 26-27 continual peals were heard, and that at eight o'clock next morning he heard one of extraordinary violence, accompanied by a shock to the vessel, which was then in 10° S. lat. and 105° E. of Greenwich. Tacchini accordingly concludes that the time of the explosion corresponded with 1.30 a.m. of the 27th at Rome. From these data he finds that the wave reached Rome from Krakatoa by the west, leaving the volcano at a velocity of 277 m. per second, and that moving in the opposite direction at a velocity of 296 m. He further calculated by the observations made at Rome that the complete atmospheric circuit round the globe was effected by the east, leaving Rome at a velocity of 295 m., and of 318 m. by the west. Captain Raffo has forwarded to Rome a quantity of the dust collected on board the ship on that day.

WE learn from *El Liberal* of Madrid, July 23, that D. Auguste Arcimis has been observing sunset phenomena very similar to those witnessed last autumn and winter. He has besides noticed an extremely brilliant silver-white corona around the sun, having a horizontal diameter of about 48°.

THE Afghan Frontier Commission will, we are glad to learn, include a geologist and native botanist, as well as three surveyors. But, as Mr. Sclater suggests in the *Times*, it is to be hoped that the scientific staff will also include a zoologist or at least a zoological collector. Mr. Sclater writes:—"The country to be passed through by the Afghan Frontier Commission, although probably in the main part bare and arid, is of the deepest interest to zoologists, as being situated nearly on the boundaries of the Palearctic and Oriental regions. The numerous Russian and American Surveys which have been sent out of late years with

similar objects have always given a place in the scientific staff to zoology as well as botany and geology. There is no reason, it seems to zoologists, why our Government should not follow such an excellent example, especially when there will be no difficulty among the numerous Indian officers who are now interested in zoology in finding a suitable person. Let me, therefore, express a hope in the name of British naturalists that a zoologist will be added to the 'scientific staff' of the Afghan Frontier Commission."

WE are glad to notice that the new St. Paul's School at Hammersmith includes physical and chemical laboratories.

IN a lecture on the Olympic Festival by Dr. A. Emerson at Johns Hopkins University, the lecturer stated that in the Olympic games uniform training, early registration, and fair play were required of the athletes, under penalty of exclusion, or, if fraud was discovered too late, of heavy fines. Dr. Emerson gave the following as the ancient and modern records of running and leaping:—

Day's run: Good Greek record, 150 km.;  
Good modern record, 168 km.  
Long running jump: Best Greek record, 55 feet;  
Best modern record, 49 feet (Engl.) 3 inches.

As the victors in the horse-races, Dr. Emerson stated, were the registered owners of the animals, such victories could be and often were won by women.

MR. H. M. STANLEY arrived in England from the Congo on Monday.

THE Bangkok Correspondent of the *Times* telegraphs that Mr. Holt Hallett and his party have reached Bangkok after an arduous expedition, lasting five months and thirteen days, from Moulmein to Bangkok through North Siam. Mr. Hallett succeeded in reaching his destination, though severely fatigued. He will return and spend one month in England, and it is hoped that the sea voyage will recruit his health. On his arrival in London he will submit a preliminary report to the Chambers of Commerce and the Geographical Society, and will return and continue the surveying operations in November. The work completed comprises the surveying of over 1500 miles, the determination of the position of the Shan ranges, and a large series of observations on the vocabularies of the aboriginal races and the histories of the several Shan States. A mass of information throwing light on the interior of Indo-China, especially of North Siam, was gathered. The reception of the expedition was from first to last excellent. This fact was due mainly to the favourable attitude of the natives and the tact and conciliation of the leader.

THE Norman coast of the Kola peninsula will be visited this summer by several explorers. MM. Enwald and Edgren will investigate its natural history; M. Kuschleff the fishing along the coast; M. Hartzenstein has undertaken researches into the fauna and flora of the neighbouring sea; M. Istomin is engaged in ethnographical researches; and M. Abels, of the Central Physical Observatory, is now at Archangel, in order to establish meteorological observatories in the north.

AT Forio, in the island of Ischia, a powerful shock of earthquake was felt on the 23rd inst. The tremor was preceded by loud subterranean rumbling like thunder, or the roar of artillery. The exact time when the event took place was twenty minutes to one o'clock p.m. Fortunately, the phenomenon lasted but momentarily, and passed off without doing any material damage to property, or causing any loss of life. An earthquake also occurred at Massowah on the 24th. Nearly all the houses in the town were destroyed or damaged by the shock. All the ships in the harbour were seen to rock violently.

THE employment of acupuncture and cauterisation by Chinese doctors forms the subject of an article in one of the last numbers

of the *North China Herald*. A native public writer not long since claimed that a skilful physician in this department of medicine could cure such diseases as imbecility, fits, cholera, &c. The principle of cauterisation is simply that of counter-irritation; and the English writer bears personal testimony to its efficacy in the case of a slight sunstroke, although the operator was a simple Manchu peasant, and instrument a couple of copper coins. Very extraordinary cures are attributed to acupuncture by the Chinese. It is first performed in the hollow of the elbow of each arm. If the puncture draws blood there is no danger, but if no blood appears the case is regarded as very grave. But before abandoning the sufferer, puncture of the abdomen is tried. Seizing a handful of flesh, the operator drives the needle right through it, and then draws it backwards and forwards a few times. If the patient manifests any sense of pain, or if any blood is drawn, a poultice of eggs and buckwheat flour is applied over the puncture, and recovery is regarded as almost certain; but if no pain is felt and no blood flows, the case is declared hopeless, and the sufferer is left to die. The case is then quoted of a young Chinese, educated abroad, who was attacked with cholera; his extremities became cold, and cramp set in in a somewhat alarming manner. The barber-surgeon who was called in commenced by running a needle into the pit of the patient's stomach, a jet of very dark blood following; he then punctured the calf, the two breasts, and the forehead of the sufferer, freeing a certain quantity of blood at each prick. The relief is said to have been instantaneous, and in two days recovery was complete. The Chinese explanation of this treatment is that, when the blood is in the poisoned condition which induces the choleraic symptoms, it becomes thick, and accumulates in certain portions of the body. A clever surgeon knows exactly how to put his finger on the particular spots, and, by skilfully "opening the mouth of the heart," as the operation is called, sets free the poisoned fluid which causes all the mischief. It is noteworthy that faith in the efficacy of this mode of treatment is not confined to the masses, but is shared by Chinese who have been abroad and have had ample experience of Western medical practice.

MR. JAMES HOPPS, Indian Engineering College, Cooper's Hill, writes us with regard to his paper on the electric resistance of metals, read before the Physical Society (*NATURE*, vol. xxx. p. 283), that an increase of resistance on uncoiling, and a decrease on coiling takes place with lead, copper, German silver, aluminium, and magnesium, and also during the first few operations on soft iron. An increase almost invariably follows coiling and uncoiling with zinc, but the effects of coiling vary from  $\frac{1}{4}$  to  $\frac{1}{2}$  of the effects of uncoiling. The full paper will appear in the Society's *Proceedings*.

THE additions to the Zoological Society's Gardens during the past week include a Malbrouck Monkey (*Cercopithecus cynosurus* ♂) from West Africa, presented by Mr. J. H. Harling; a Cape Sea Lion (*Otaria pusilla*) from South Africa, presented by Mr. John Hunt; two Daubenton's Curassows (*Crax daubentoni* ♂ ♀) from Venezuela, a Common Guinea-Fowl (*Nunida meleagris*), British, presented by Mr. W. Burch; two Indian Kites (*Milvus govinnda*) from Eastern Asia, presented by Mr. W. Jamrach; a Barn Owl (*Strix flammea*), European, presented by Mr. G. H. Garrett; three Angulated Tortoises (*Chersina angulata*), two Geometric Tortoises (*Testudo geometrica*) from South Africa, presented by the Rev. G. H. R. Fisk, C.M.Z.S.; two Smooth Snakes (*Coronella levis*), European, presented respectively by Mr. W. H. B. Pain and Mr. F. H. Jennings; two Black-tailed Deer (*Cariacus columbianus* ♂ ♀) from North America, two White-backed Piping Crows (*Gymnorhina leucocincta*) from Australia, two Common Cormorants (*Phalacrocorax carbo*), British, deposited; two Red-capped Parrots (*Pionopsitta*

*pileata*) from Brazil, a White-bellied Sea-Eagle (*Haliaeetus leucogaster*) from Australia, a Mohr Gazelle (*Gazella mohr* ♀) from North Africa, a Violet-necked Lory (*Eos rinciniata*) from Moluccas, a Black Tortoise (*Testudo carbonaria*), a Common Boa (*Boa constrictor*) from South America, two Electric Eels (*Gymnotus electricus*) from British Guiana, purchased; three Elliot's Pheasants (*Phasianus ellioti*), bred in England; a Mule Deer (*Cerviacus macrotis*), a Mesopotamian Fallow Deer (*Dama mesopotamica* ♂), born in the Gardens.

#### OUR ASTRONOMICAL COLUMN

SCHMIDT'S VARIABLE-STAR IN VIRGO.—On June 6, 1866, Schmidt remarked, east and south of Spica, a star which he at first estimated 4 m., subsequently 5.4, not found in Argelander's *Uranometria*; it was much better visible than  $\epsilon$  Virginis, the reddish-yellow fifth magnitude south of Spica. By observations during the next fortnight its light appeared to have slowly diminished, nevertheless on June 19 it was still visible with the naked eye, though there was strong moonlight. On examination of the catalogues, &c., it was found that Lalande estimated it 6.7 on May 10, 1795; Piazzini calls it 6.7 and 7 in the *Storia Celeste*, not 8 as in the printed catalogue; Bremicker entered it of the seventh magnitude on his Berlin chart, while Lamont calls it 8 m. in Zone 355, observed on May 22, 1846. Heis has it 6.7, while Gould says, "Var. 5.4-6.4." Houzeau judged it a sixth magnitude at the date 1875.11. We have thus evidence that it has been pretty conspicuously visible to the naked eye, while, on the authority of Bremicker and Lamont, it has been at other times beyond average unassisted vision.

Schjellerup has raised a point of much interest in connection with this star. There has been a difficulty in identifying satisfactorily Ptolemy's 19th star in Virgo, which he calls a fifth magnitude ( $\epsilon$  in his notation). Bailly, in his notes to his edition of Ptolemy's Catalogue, published in vol. xiii. of the *Memoirs* of the Royal Astronomical Society, writes: "The star 68 Virginis agrees with the position given by Ptolemy; but it is difficult to make it accord with the description, as being in the 'latus sequens' of the quadrilateral figure." Schjellerup, in his translation of Süfi, remarks: "A l'endroit où, selon la description détaillée que nous a fournie Süfi, doit se trouver la 19<sup>e</sup> étoile, il n'y a aucune étoile aujourd'hui visible à l'œil nu, selon *Uranometria Nova* d'Argelander, pendant qu'il s'accorde très-bien avec celui de Lalande 25086, étoile qui est entre la sixième et la septième grandeur. En faisant la révision de cette note, je me rappelai l'étoile variable au sud-est de  $\alpha$  Virginis, dont nous a donné avis M. Schmidt dans le n<sup>o</sup> 1597, *Astronomische Nachrichten*. Quelle ne fut ma surprise en m'apercevant de l'identité entre cette variable et la 19<sup>e</sup> de Süfi?"

This identification, however, is hardly so certain as may at first sight appear. Schmidt's star is in the Greenwich Catalogue for 1872, which gives its position for 1880.0—

Right Ascension  $202^{\circ} 4' 4''$  ... Declination  $-12^{\circ} 35' 9''$

Ptolemy professes to have reduced his catalogue to the first year of Antoninus, A.D. 138, though it is well known that his longitudes are in defect to the amount of about 1° for that epoch. Unfortunately, for the 19th star of Virgo, though the longitudes agree, the latitudes given in the various editions of the *Almagest* and by Süfi are materially different. Bailly has it  $-3^{\circ} 0'$ , with a note that in the Venice edition in Latin by Liechtenstein, in 1515, it is  $+0^{\circ} 20'$ , which he thought might arise, as regards the difference in amount, from mistaking  $\gamma$  for  $\gamma'$ . While in the two manuscript copies of Süfi (who adopted the positions of the *Almagest*, adding  $12^{\circ} 42'$  to the longitudes) the latitude is  $-1^{\circ} 20'$ .

To reduce the Greenwich position for 1880 to the year A.D. 138, we have in the usual notation—

$A = 168^{\circ} 47' 3''$  ...  $A' = 191^{\circ} 0' 8''$  ...  $\theta = 9^{\circ} 40' 6''$ ;

with which the position for Ptolemy's epoch is found to be—

Right Ascension ...  $179^{\circ} 36' 0''$  Declination ...  $-3^{\circ} 5' 4''$ ;  
and assuming the obliquity of the ecliptic to be  $23^{\circ} 41' 8''$ , we have—

Longitude ...  $180^{\circ} 53'$  Latitude ...  $-2^{\circ} 59'$

The longitude of the 19th of Virgo is apparently  $178^{\circ}$  in all the editions of the *Almagest*, and the latitude differs  $1^{\circ} 39'$  from that assigned in the manuscripts used by Schjellerup.

If we similarly reduce the Greenwich position of 68 Virginis to Ptolemy's epoch, we find—

Longitude ...  $178^{\circ} 53'$  Latitude ...  $- 3^{\circ} 14'$

and Baily's identification of the 19th of Virgo would thus appear the more satisfactory, at least if the reading he has adopted for the latitude is admitted; still there is the difficulty pointed out in his note which is given above; 68 Virginis is estimated a sixth magnitude both by Argelander and Heis.

In 1879 Mr. S. W. Burnham discovered that this star is a very close double, the mean of his measures giving—  
1879.39 Position  $81^{\circ} 2'$ . Distance  $0'' 47$ . Magnitude 6.1 and 6.6.

He remarks that hitherto close double-stars have not been found among the variables. It remains to be ascertained whether, if the variability of Schmidt's star be established, both or only one of the components vary.

A NEW COMET.—A telegram notifies the discovery of a comet by Mr. E. Barnard, on the 16th inst., though, probably from interruption from unfavourable weather in verifying it, the announcement appears not to have been made for several days subsequently. The position given is as follows:—

h. m. s.  
July 16 at  $15^{\text{h}} 21^{\text{m}} 2^{\text{s}}$  G.M.T. ... R.A.  $237^{\circ} 40' 0''$  ... N.P.D.  $127^{\circ} 9' 52''$

It would be well within reach of the observatories of Southern Europe. From a telegram received at Dun Echt, Dr. Copeland conjectures that the comet has been seen at Melbourne, Madras, and Cape Town; Prof. Krüger has no allusion to this in his note in the *Astronomische Nachrichten*. The comet's motion is stated to be slow.

#### SCOTTISH METEOROLOGICAL SOCIETY

THE half-yearly general meeting of the Society was held on Monday, July 21, in Edinburgh, Mr. Milne Home in the chair.

Mr. Buchan read the report from the Council. As regards the Society's stations, one has been added since last general meeting at Glencarron, in Ross-shire. It has been established by Lord M'Laren, and from its position it is one of the most important additions recently made to the Society's stations. The effort made to increase the membership has been already attended with marked success. The membership now numbers 601. The first number of the new series of the Society's *Journal* is now mostly in type, and will shortly be in the members' hands. It has been arranged that in future the proceedings will appear annually in March. The Council referred with much satisfaction to the successful manner in which Mr. Omond and his assistants carry on the observations on Ben Nevis. The discussion of the past observations shows that paramount importance must be assigned to a continuous record, not only of the barometer, but also of the temperature, humidity, wind, cloud, and precipitation, on account of their intimate relations to the barometric fluctuations and to coming changes of weather. Every effort will therefore be made to secure to science a continuous hourly record of the weather phenomena of Ben Nevis. Arrangements have been made for the completion of the Observatory buildings during the course of this summer. A beginning of the work is made to-day (July 21), and it is expected that the whole will be finished some time before October. The new buildings include a tower, on the top of which will be placed anemometers, specially designed by Prof. Chrystal and Prof. Crum Brown, for registering the direction, velocity, and pressure of the wind, a correct knowledge of which is of supreme importance in carrying on the scientific and practical inquiries aimed at in the establishment of the Observatory. To the expenses connected with the erection of the anemometers a grant of 50*l.* has been made by the Committee of the Government Research Fund. An exit from the building has been made in the upper part of the tower, which will enable the observers to make outside observations during the winter months, on many occasions when they could not otherwise be attempted. The Council regret to intimate that their application to the Treasury for a grant in aid of the establishment of the Marine Station at Granton was not successful. Notwithstanding the refusal of the Government to give assistance, the Marine Station, to which the Society contributes 300*l.* a year from the Fishery Fund, was established in April. There is every probability that the subscriptions from the general public will shortly permit of very desirable extensions being made to the further equipment of the

station. In response to an offer by the Scottish Sea-Fishing and Curing Company, Mr. Pearcey, of the *Challenger* Office, made observations on a cruise in the ship *Energy* in the North Sea, between Shetland and Norway. The specimens obtained during the cruise, and the observations made, are now under consideration.

A paper was read by Mr. Buchan on the meteorology of Ben Nevis, which we hope to give in an early number.

Dr. Arthur Mitchell described a new instrument for collecting continuously any cosmic dust, volcanic dust, or other impurities mechanically suspended in the atmosphere, the essential part of the instrument being a series of filters of fine platinum wires, through which the air is continuously drawn by an aspirator.

A report of the work done at the Scottish Marine Station at Granton was submitted by Mr. J. T. Cunningham, naturalist in charge. He detailed the nature of the work since the opening of the Station in April. The method of working in the yacht *Medusa* was then described. The position of the yacht is ascertained by means of bearings at the time when the dredge or other apparatus is put down or taken up. At these points the depth of the water and the nature of the bottom are ascertained, and various physical observations taken, including the temperature of the air, and that of the sea at the bottom, at the surface, and at intermediate depths; samples of sea water are also secured from different depths. When the dredge or trawl is hauled on deck, the contents are examined and the relative abundance of the animals and Algæ noted down. Some of the specimens are preserved on the spot, and a number of them are brought alive to the Station, and placed in the floating cages or in aquaria in the laboratory, so that they may be more minutely examined in the living state, and form a stock which may be drawn upon for purposes of special research. The products of the fine tow-nets are treated in the same way; a microscope is always on board, and in calm weather the minute specimens can be examined in the cabin. Samples of the contents of the tow-nets are preserved and labelled on board, and the remainder are brought back to the Station alive and examined in the laboratory. The results of one day's work at sea usually provide material for two or three days' work on shore. The work of dealing with the preserved collections, identifying and separating the animals, goes on continuously at the Station. The materials for faunological and systematic zoological work soon became abundant, and in the inquiries continuously carried on special attention is given to identify the numerous kinds of fish spawn, both floating and attached, which occur in the Firth of Forth and neighbouring parts of the sea. In order that the systematic and general work of the Station might not be neglected, the services of Mr. John Henderson as zoologist have been secured. The study of the Algæ has been energetically carried on by Mr. Rattray. The work carried on by Mr. Mill has been chiefly physical. A regular system of meteorological observations, both on land and in the "ark," has been set on foot. Up to the present time three biologists have availed themselves of the opportunities afforded by the Station for research—Prof. W. A. Herdman, University College, Liverpool; Prof. Haycraft, Mason's College, Birmingham; and Mr. J. R. Davis, University College, Aberystwith.

Mr. Hugh Robert Mill read a paper on the tidal variation of temperature at the Marine Station. He detailed the nature of the experiments, these including hourly and half-hourly observations by night and by day on three occasions, extending in all to ninety-seven hours. The results show interesting relations between the temperature, the time of day, and the state of the tide. Without attempting to generalise, the following facts observed in each series of observations may be stated:—The surface temperature rose when the air temperature rose, and fell when it fell, with no very apparent reference to the tides. The curve for bottom temperature also followed that of air temperature, though to a slight extent; but the crest of the heat wave was retarded for several hours, and the tide produced great modifications in the temperature. When the tide flowed early in the morning it cooled the bottom temperature; when it entered at a later hour it raised it. By day the bottom temperature was lower than that of the surface; by night it was equal to it or slightly higher. The causes which produced these various effects must be very complex. The contour of the bottom of the quarry, the rates of influx of the tide, the direction of the currents it originates, the duration and period of the sunshine, the direction of the wind, the heating of the sand by the sun and its cooling by radiation, the heating and cooling of the surface water by radiation, and

the bottom water by conduction and convection, must all be taken into account before a true explanation could be arrived at. It is intended to devote special attention to the effect of radiation on the sand, and of the heated or chilled sand on the tidal water which flows over it, it being probable that it is in this way the key to the curious tidal perturbations of temperature may be found.

### THE PHILOSOPHICAL SOCIETY OF GLASGOW

THE *Proceedings* of the eighty-first session have just been published in the form of a volume of 428 pages, and consisting of twenty-four papers, three plates, and a map. The papers are: an address on some of the chemical industries of the country, by Mr. R. R. Tatlock, President of the Chemical Section; on technical education, by Mr. Henry Dyer, C.E.; a discussion of Mr. Dyer's paper, by Mr. E. M. Dixon, B.Sc.; an introductory address on the definition and scope of geography and ethnology, by Dr. W. G. Blackie, President of the Geographical and Ethnological Section; on the use of litmus, rosolic acid, methyl-orange, phenacetolene, and phenolphthalein as indicators, parts ii. and iii., by Mr. Robert T. Thomson; on an easy way of determining specific gravity of solids, by Dr. Dobbie and Mr. John B. Hutcheson; note on Mr. Joseph Whitley's centrifugal mode of casting steel plates for shipbuilding, &c., by Dr. Henry Muirhead, President; notes on Cleopatra's Needle, by the President, on the occasion of presenting a large bronze model of the Needle to the Society; on a new method of measuring the heat-conducting power of various materials, such as cotton, wool, hair, &c., by Mr. J. J. Coleman; on a new thermometer or thermoscope, by Mr. Coleman; on the measurement of electric currents and potentials, by Sir William Thomson; a sketch of the life and work of Dr. Allen Thomson, by Dr. McKendrick; note on modern forms of the microscope, by Dr. W. Limont; on the chief features of the physical geography of China, by Rev. A. Williamson, B.A., LL.D., Missionary in China; on the recent progress of chemistry at home and abroad, by Prof. J. J. Dobbie; on the analysis of commercial carbonate of potash, by Robert Thomson; on a new process for the separation of nickel and cobalt, by Dr. John Clark; on an endless solenoid galvanometer and voltmeter, by Prof. James Blyth; on the chemical composition of the methyl and ethyl alcohols, by Dr. Otto Richter; on the Island of New Guinea, by Dr. W. G. Blackie, illustrated by a map published by permission of the Royal Geographical Society; on the consumption of smoke, especially in great cities, by Mr. A. Pinkerton; on rickets in Glasgow and neighbourhood, and the relation of the disease to food and water used by the inhabitants, by Mr. James Thomson, F.G.S.; and the Graham Lecture by the late Dr. R. Angus Smith, prepared for publication by Mr. J. J. Coleman.

The last paper is probably the most interesting and important of all, inasmuch as it contains many unpublished letters of Thomas Graham, so full of information as to his work and the circumstances in which his work was done that it cannot fail to attract the notice of all engaged in physico-chemical research. The paper has a mournful interest also as being the last from the late Dr. R. Angus Smith. It will be published separately, in a small volume, for the use of those who desire to have a memorial of Thomas Graham.

The Society has a membership of 690. Its work is carried on not only by the parent Society, but by five sections—Chemistry, Biology, Architecture, Sanitary Science and Social Economy, and Geography and Ethnology.

### SCIENCE IN RUSSIA

THE Kazan Society of Naturalists continues its useful work of exploration. The last volume of its *Memoirs* (*Trudy Obshchestva Estestvoispytateley pri Kazanskom Universite, vol. xii.*) contains two papers by the late M. Shell, on the botanical geography of the provinces of Ufa and Orenburg, being a list of 1054 Spermatophores already known from these two regions which have an intermediate flora between that of South-Eastern Russia and that of the Caspian Steppes. A most useful addition to the knowledge of the flora of these provinces is contained in the second paper by the same author, which gives a list of no less than 511 species of Sporophores (28 Vascular plants, 49 Mosses, 2 Charæ, 181 Algæ, 94 Lichens, and 157 Fungi). The importance of this addition may be seen from the fact that, before

M. Shell's work, only 39 species of Sporophores were known from these two provinces. It is worthy of notice that M. Shell has found among the Algæ the *Asterionella formosa*, Hassel, which has been discovered in England and was found on the Continent only by Brébisson in France, and by Heiberg in Denmark. The death of M. Shell in 1881 at Vilno was a great loss to Russian science. In the same volume M. Bekarevitch publishes his "Materials for the Flora of Kostroma," being a list of 514 species of Phanerogams and 18 Cryptogams. M. Flavitzky publishes his researches into the pitchers of different Conifers. The author has studied the deviations of their planes of polarisation, and has found that the value of the angle of deviation is quite characteristic for different pitchers; it varies from  $-42^{\circ}2$  (*Pinus abies*) to  $-13^{\circ}1$ ,  $-10^{\circ}9$ , and  $-9^{\circ}6$  for the *Pinus sylvestris*, *P. centra*, and *Abies sibirica*, and from  $+9^{\circ}1$  to  $+27^{\circ}2$  for the *Abies balsamea* and *Larix europæa*. We must notice also the elaborate researches, by A. Dogel, into the structure of the retina of the Ganoid fishes. These researches fill a gap which was pointed out many times; they are accompanied by excellent plates engraved at Leipzig.

The minutes of proceedings (*Protokoly*) of the same Society are especially interesting for mathematicians, as they contain a number of notes by MM. Maximowitch, Klark, and others. They are followed by papers on the motion of liquids in elastic tubes, by Prof. Gromeka; on the ichthyology of Kazan, by N. Varpakhovsky; and on the dangerous insects of Samara, by E. Peltzian.

The new volume of the *Memoirs* of the Kharkoff Society of Naturalists (*Trudy Obshchestva Ispytateley Prirody pri Kharkovskom Universite, vol. xvii.*) contains a paper by N. Koulchitzky, on the structure of the "Grandry corpuscles," being a description of that special form of corpuscle by which the nerve is terminated in the tongue of the duck, which M. Grandry distinguished in 1869 from the corpuscles of Herbst (or Pacini's with other animals). The paper is accompanied by three lithographed plates. M. Byeletzky's posthumous paper, on the physiology of the aerial or natatory bladder of fishes is a very elaborate memoir on this subject. The author, who has taken notice of nearly all the researches made in the same direction during more than a century, gives a detailed anatomical sketch of the bladder, and a summary of all known as to its contents. His own researches have been made on fifty-four individuals belonging to the following six species:—*Cyprinus carpio*, *Carassius vulgaris*, *Tinca vulgaris*, *Abramis brama*, *Idus melanotus*, and *Perca fluviatilis*. The gases contained in the bladder are: nitrogen, from 81 to 96 per cent. of the whole (sometimes even 98); oxygen, mostly less than 10 per cent., and very seldom from 15 to 20 per cent.; and carbonic acid from 2 to 5 per cent., falling to 0.6, and very seldom reaching more than 7 per cent. The contents of carbonic acid depends very much upon the conditions which the fish has been kept in before the experiments; but it stands in no correlation at all with the contents of oxygen. The amount of both may be simultaneously small, or greatly above the average. As to the origin of the gases in the bladder, the author indorses the views of Configliachi (Schweigger's *Journal für Chemie und Physik*, Band i. 1811), and concludes that they are not indebted for their origin either to digestion or to the supposed "swallowing" of air on the surface of the water; individuals kept for months under water, without having the possibility of reaching its surface, having been found to have the same composition of gases in the bladder as free individuals. It would rather seem that, with the raising of the fish on the surface, which is accompanied by a diminution of atmospheric pressure, a part of the gas is expelled from the bladder. The most probable origin of the gases in the bladder seems to be—Configliachi said—that the air contained in the water and entering into the mouth of the fish is in some way (perhaps in that pointed out by Erman) eliminated from it; it is dissolved in the blood of the gills, and the oxygen is slowly assimilated by the blood; while the remainder, that is, nitrogen and some oxygen which has remained dissolved, are secreted from the blood into the bladder. This is also the opinion of M. Byeletzky, who considers that blood, as also the lymph, is the source whence the gases of the bladder originate. Contrary to Configliachi's opinion, they are not secreted, however, by the "red corpuscles," but rather by the capillary vessels of the mucous membrane of the bladder; such was also the opinion of Rathke and Johann Müller; however, the argument by which they tried to establish this view cannot be longer held. In



a paper on the microscopic structure of the coal of the Doltz basin, M. Jenjourist shows that the coal contains remains of Sigillariæ and Lepidodendrons, while several Russian geologists are inclined to consider it as having originated only from marine Algae. M. Dybovsky contributes to this volume a description of a new species of fresh-water sponge from Southern Russia, which is closely allied to the *Dusillia baileyi* of Mr. Carter, and to which he gives the name of *Dusillia stepanovii*; it is figured in a plate. Finally, M. Shevireff gives a list of *Hymenoptera crebrantia* of the Governments of Kharkoff and Poltava; and M. Yaroshevsky publishes his fifth supplement to the list of Diptera of Kharkoff.

The last two volumes of the *Memoirs* of the St. Petersburg Society of Naturalists (*Trudy Sanktpeterburgskago Obschestva Estestvoispytateley*, vol. xiii. fasc. 2, and vol. xiv. fasc. 1) contain, besides the minutes of proceedings (which unhappily do not go further than March 1883), several valuable papers. Geology is the most favoured branch. Thus we find in vol. xiii. an interesting paper on the waterfalls of Northern Esthonia, by P. N. Vemikoff. The orography of the country whose Silurian deposits are cut towards the north by the abrupt terrace of the Glint, the lower parts of which contain looser strata easily destroyed by the water (as in the Niagara), favour the development of waterfalls, the chief of which are described by the author. In the same volume M. M. Koudryavtseff and Sokoloff publish a geological description (with a geological map) of the district of Kromy in Orel. The Quaternary formations are represented by the "black earth," loess, and mighty sheets of boulder-clay which cover the chalk, the Jurassic clays, containing sphaeroiderite, and the Devonian limestones, marls, and dolomites, appearing in the north. The paper is accompanied with a map on a large scale. In vol. xiv. we find a very interesting orographical sketch of the Kola peninsula, by N. Koudryavtseff. The author has devoted much attention to the leading features of this tableland, and the modifications its surface has undergone under the action of the ice-sheet of the Glacial period. The structure of the mountains; the parallelism of the valleys; the glacial erosion, which has covered the whole of the country with numberless depressions running in the direction of the glacial striation, and producing what might be called "telescopic striation"; the finer glacial striae, which run north and south, or north-north-west to south-south-east; the "glacial landscape" of the country; and finally its upheaval, are dealt with by the author. Several indications led the author to admit that the peninsula is rapidly rising up, the surest of them being the find of colonies of *Balanides* at a height of 8 metres above the sea, and the discovery of the *Buccinum undatum* (which still inhabits the White Sea), together with broken shells of Brachiopoda and Lamellibranchiata, about 280 feet above the present sea-level, at Kandalaksha. N. A. Sokoloff contributes to the same volume a note (with a plate) on the find of teeth of *Mustodon arvernensis* in the Crimea, at Zamruk, which would imply a wider extension of Pliocene in the yet unexplored steppes of the peninsula; and on the find, also in the Crimea, of teeth of *Hipparion gracile*, which was so widely spread during the Tertiary period on the prairies of the Missouri to the Himalayas. We notice also a note by P. P. Kudryavtseff, on prehistoric man on the Oka; and another note by M. Polyakoff on the bottom-moraine at Wiborg, in Finland.

In other branches of science we have to mention a sketch of the Phanerogam flora of the Government of Minsk, by W. Paszkewicz (vol. xiii.). It contains 958 species, the whole number reaching probably about 1000; 40 of them are new for this region. In vol. xiv. we find a note by M. Szihowsky on the chemical constitution of different parts of the *Zea Mays*, and two preliminary reports, botanical by A. Krasnoff, and zoological by A. Nikolsky, about explorations in the Altai Mountains. The collections of 720 Phanerogams and 100 Cryptogams, which have been brought in by M. Krasnoff, will surely yield interesting data. As to M. Nikolsky, he gives a lively sketch of the fauna of the Altai, followed by a list of observed species: 50 mammals, one of which, *Talpa altaica*, is new; 169 birds, a few reptiles and amphibia, and 16 fishes. A plate gives the comparison of the *T. altaica* with the *T. europea*.

## RECENT MORPHOLOGICAL SPECULATIONS<sup>1</sup>

### III.—Non-segmented Animals

THERE are certain groups of animals about whose systematic position naturalists never seem able to remain long agreed. These groups are changed from place to place in our schemes

<sup>1</sup> Continued from p. 297.

of classification; and often each new discovery seems to confute a current theory only to confirm that which preceded it. More than any other groups, the Polyzoa, Brachiopods, and Mollusks have been shifted from point to point, and it seems almost too much to expect that they have even now found a permanent resting-place.

The Polyzoa were brought into connection with "Mollusks" more than fifty years ago, when Milne-Edwards exhibited their supposed affinities with Ascidians, and their Molluscan affinities were more fully admitted when Von Siebold compared the Polyzoan lophophore and tentacles with the arms of a Brachiopod. Milne-Edwards, in combining Polyzoa and Tunicates in his new group Molluscoidea, argued the identity of the type in every detail of structure, and Huxley ("English Cyclopædia," 1855), laying more weight than previous writers had done on the affinities of Polyzoa with Brachiopods (as Mr. Albany Hancock was perhaps the first to suggest) definitely included this last class also in the group Molluscoidea. The Brachiopods seemed, in the light of that time's knowledge, to take a very natural position among the "neural Mollusks," between the Polyzoa on the one hand and the Lamellibranchs and the Pteropods on the other (*Proc. Roy. Soc.* 1854, p. 117).

But in the course of the next ten years Kowalevsky's discovery of *Loxosoma* seemed to supply a link between the Polyzoa and Worms, and afterwards Haeckel, emphasised this relation, and finally included the Polyzoa in the latter group. The Tunicata had by this time obtained, through Kowalevsky's researches, an established position far removed from their former allies in the "Molluscoidea," and Gegenbaur now analysed more critically the differences between Polyzoa and Brachiopods, and (denying that either had any affinity with Mollusks) maintained the eminently isolated position of Brachiopods, and asserted that their arms could no more be compared with the tentacles and lophophore of Polyzoa than these could with the branchial tufts of the Tubicolæ. The discovery by Kowalevsky (1874) of the apparently segmented larva of *Argiope*, &c., seemed to reveal almost obscured genetic relations with the Chaetopods, and at the same time Morse, working chiefly on *Lingula*, argued elaborately that the Brachiopods are much modified Annelides. Ray Lankester, on the other hand, upheld the Molluscan affinities of both Polyzoa and Brachiopods, and Huxley, in his "Anatomy of Invertebrates," kept the three groups in close juxtaposition. Lankester compared *Rhabdopleura* minutely with the embryo of *Pisidium* (*Phil. Trans.* 1874), and maintained the common origin from a primitive ciliated girdle of the gill-filaments of Lamellibranchs, the lophophore of Polyzoa, the arms of Brachiopods, the tentacles of Phoronis, the velum of embryo Mollusks and of Rotifers, and the ciliated proboscis of *Gephyrea*. Huxley ("Invertebrates," p. 674), influenced on the one hand by Lankester, and by Steenstrup and Morse on the other, proposed to combine Polyzoa and Brachiopods under the name *Malacoscolices*, to indicate relationship both with Mollusks and with Worms. Lastly, Caldwell (*P. R. S.* 1882), by his researches on Phoronis, has thrown new light on the structure of both Polyzoa and Brachiopods, and, in Lankester's words ("Encycl. Brit.," Art. "Mollusca," 1884), "has established the conclusion that the agreement of structure supposed to obtain between Polyzoa and true Mollusca is delusive; and accordingly they, together with the Brachiopoda, have to be removed from the Molluscan phylum."

We may examine this last important view more closely, and try afterwards to discuss the probable ancestry of these three much-debated classes.

*Actinotrocha*, the larva of Phoronis, is, according to Caldwell, a perfect and typical trochosphere. The larvæ of Brachiopods and Polyzoa are trochospheres in which, by a shortening of the "dorsal" surface, mouth and anus have been approximated, and the ventral surface has been enormously distended. The same change takes place, and to an even greater extent, in the "metamorphosis" of Phoronis: the adult animal has both mouth and anus situated at one end of a long body; the line joining them is the contracted dorsal surface; an epistome, said to be the persistent præ-oral lobe of the larva, lies between mouth and anus; a lophophore, whose new tentacles are added on either side of the median dorsal line, surrounds the mouth; within its concavity, on either side of the anus, lie two ciliated pits, whose homologue is found in *Rhabdopleura*. A single pair of nephridia exist. The body-cavity is traversed by mesenteries, one of which is ventral, and attaches the outside of both descending and ascending limbs of the alimentary canal to the body-wall; two are lateral, and pass from the side of the stomach to the body-wall, dividing the

cavity into two anterior chambers and one posterior; and lastly a transverse septum shuts off the space within the epistome and tentacles from the rest of the body-cavity. The nephridia open into the posterior chamber of the body-cavity on the sides of the lateral mesentery. At no stage, either in the embryo or the adult, is any trace to be found of segmentation.

The parallelism between Phoronis and Brachiopoda is full and clear. An ectodermal post-oral nerve-ring exists in both. The body-cavity of the præ-oral lobe is in both separated from the rest of the body-cavity by a septum. The tentacles are arranged and developed similarly in both. In both the nephridia have the same relations and the alimentary canal is divided into the same four parts. And in both the præ-oral lobe of the larva is represented in the adult by an epistome. The Polyzoa, though immensely simplified in structure, seem undoubtedly to be built upon the same plan; and Caldwell considers it probable that the epistome of Endoproct and Hippocrepian Polyzoa and the so-called foot in Rhabdopleura represent, like the epistome of Phoronis and Brachiopods, the præ-oral lobe.

Mr. Caldwell closes the abstract of his yet unpublished paper with a remark upon the affinities of the Gephyrea. We know nothing to show that Sipunculus and Phascolosoma are not referable to the same type of structure as Phoronis, Brachiopoda, and Polyzoa.

But as regards the types from which all these mutually-con-

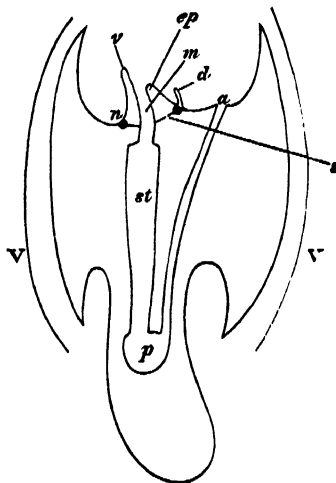

Diagram of body plan of *Brachiopod*, *Polyzoan*, and *Phoronis* (after Caldwell).—*m*, mouth; *a*, anus; *s*, septum; *n*, nervous system; *st*, stomach; *r*, second stomach; *ep*, epistome; *v*, tentacle of ventral series; *d*, tentacle of dorsal series; *v v* valves of Brachiopod skull.

nected forms sprang, we know little or nothing, and we look in vain for an unsegmented worm which shall show clear affinity with them.

Van Bemmelen, in a recent paper (*Jenaische Zeitschrift*, 1883) has compared at great length the Brachiopods with Sagitta, and arrives at the conclusion that the two types show such intimate agreement that they must be looked upon as very closely related. In the first place Dr. van Bemmelen recounts the histological resemblance between Sagitta and Brachiopods; and if he ascribes more weight to these than his readers may be inclined to do, he is not without weightier considerations in support of them. In both groups connective tissue is conspicuously scanty; in both a homogeneous intercellular substance or mesenchyme-layer is abundant. The epithelial layers are extremely simple and alike in both; the muscles in both are "built on an epithelial type;" the histological characters of the nervous system are identical in both. The chitinous hairs developed in ectodermal follicles on the mantle of Brachiopods are not without analogues in the Chaetognatha. The three metameres of the larval Brachiopod are compared with the divisions of the adult Sagitta; the four genital glands of the former (Testicardines) are identified with the ovaries and testes of the latter. The gastro- and ileo-parietal bands of the Brachiopod are made homologous with the transverse septa of Sagitta, and the hood of Sagitta with the arms of the Brachiopod. It is obvious that the above characters, many of which are mentioned in the Hertwig's "Coelomtheorie,"

are of very unequal value; and some are even wrong, for the gastro- and ileo-parietal bands of a Brachiopod are parallel with the gut, and in no way comparable to the transverse septa of Sagitta. But, on the other hand, there are other suggestive points of resemblance, and, though further developmental evidence in the case of Sagitta is sorely needed, I think that its possible affinity to the Phoronis type cannot be altogether passed over. Not only is the development of the mesoblast and body-cavity strikingly similar, but the dorsal and ventral mesenteries at first present in Phoronis agree with those of Sagitta, and the septum dividing off a part of the body-cavity within the head seems the same in both. Nothing in the nervous system offers great difficulty, and the relations of the hood in Sagitta seem not discordant with those of a lophophore. If we approximate the anus and mouth dorsally in Sagitta, the "olfactory organ" will assume the position of the two sense-organs of Phoronis and Rhabdopleura. The lateral mesenteries of Phoronis and Brachiopods arise late and secondarily, as does the transverse septum of the trunk in Sagitta. The anterior and posterior generative masses, arising first together, are no sign of true segmentation, and our embryological knowledge of the nephridia of Sagitta is too slight to permit us to make much use of them as arguments on either side.

If all this is true (and I am far from insisting upon it), it means that Sagitta (though extremely modified for a pelagic life) is akin to the unflexed, unsegmented worm, which, as it acquired a dorsal flexure and a more complex lophophore, gave rise to the proximate ancestors of the Phoronis type.

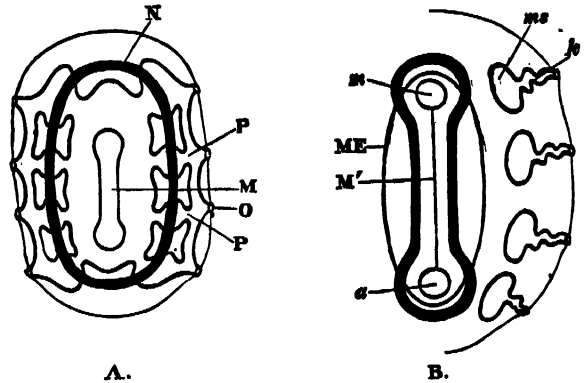

Sedgwick's theory of segmentation: A. Ideal ancestor of segmented animals; B. Invertebrate.—*m*, primitive mouth; *m'*, middle portion of primitive mouth or blastopore closed up; *n*, nervous system; *v*, pouch of gut; *ms*, mesoblastic somite; *k*, nephridium; *o*, external pore; *ME*, mesenteron.

And if we admit this even for a moment, it becomes worth while to consider the possibility of a distant Molluscan connection with the same line; for, possessing a trochosphere larva, a single pair of nephridia, and a nervous system with no trace of genuine segmentation, they are so far in agreement with our type. I cannot see that Caldwell's discoveries necessarily invalidate Lankester's old comparison of the Lamellibranch gills (and labial palps) with a lophophore; and even Lankester himself, in spite of his opinion already quoted, that, owing to Caldwell's research, Polyzoa, &c., must now be removed from the Molluscan phylum, yet still admits (*loc. cit.* p. 688) that "it is very probable that the labial tentacles and gill-plates are modifications of a double horseshoe-shaped area of ciliated filamentous processes, which existed in ancestral Mollusks much as in Phoronis and the Polyzoa, and is to be compared with the continuous præ- and post-oral ciliated band of the Echinid larva *Pluteus*, and of *Tornaria*;" and Langerhans' close comparison between the nervous systems of Sagitta and a Mollusk may be worth more consideration. The Molluscan foot may, after all, be an epistome, as Lankester formerly said, and the "osphradia" of the Mollusk may turn out homologous with the sense-organs of Phoronis and Rhabdopleura. But the extreme modifications that the Molluscan type has undergone—the reduction of the body-cavity, the development of the foot, the various flexures, and so forth—leave any connection that we may trace with it and our Sagitta type at best a distant one; if such exists, a distant relationship will be again traceable between Mollusks and

Brachiopods, though every argument on which their former connection was based is demonstrably false.

But to a great extent the whole matter turns upon our conception of *segmentation*, a subject which Mr. Sedgwick's recent speculations (*Q. J. M. S.*, No. xciii. 1884) may very seriously modify. Sedgwick derives all metameric segmentation from a Coelenterate-like ancestor, with a *pouch-like gut* like that of all the Actinozoa. The blastopore, including both mouth and anus, is derived from the Actinozoan mouth, the double nerve-cord from the aggregation of the nervous system round the mouth of the polyp, and the nephridia from specialised parts of the pouches represented now by the circular canal of Medusæ or the mesenteric perforations of Actinozoa and the pores leading to the exterior in those forms from the mesenteric chambers. But it is impossible to discuss this theory fully; it is enough to point out that it postulates segmented ancestors of all animals above Coelenterates. Mollusks, Brachiopods, and Sagitta must according to it have been once segmented, just like Vertebrates, Arthropods, and Worms. But surely this is a violent assumption. There is no evidence of segmentation among Mollusks save in Nautilus, for even the pedal commissures of Chiton in no way indicate a truly segmented condition; nor any among Polyzoa or Brachiopods save the four nephridia of Rhynchonella. And it is by no means clear that the development of Sagitta indicates its descent from an ancestor with "three pairs of gut-pouches." The vast number of animals with a single pair of nephridia can scarcely all be derived from ancestors with many pairs; and Hatschek's description of the origin of segmented nephridia (in Polygordius) from a single pair seems far from supporting Sedgwick's view. The still insufficiently investigated excretory organs of Rhynchonella, and the four gills, &c., of Nautilus, seem not enough to indicate descent of the groups to which these forms belong from segmented ancestors. On the contrary, it seems far more likely that the types we have more particularly discussed are all derived from some unsegmented trochosphere; and that the segmentation of the Chætopods only became marked after the ancestor of the Phoronis type had severed his course from the common stock of Worms. The distinction of segmentation and non-segmentation would thus divide the Invertebrata.

As regards the Gephyrea, there is much reason for connecting such members of the group as Sipunculus, Phascolosoma, and Bonellia with the unsegmented Phoronis type. But Hatschek maintains that the development of Echiurus proves it to be a degenerate Chætopod; and if so, Caldwell (*loc. cit.*) is ready to admit that the others may be further stages in such degeneration. But even as regards Echiurus this degeneration is far from clear. The Platylminths seem also never to have been segmented, and their "water-vascular canals" may give us some indication of the organs from which are derived the nephridia of Phoronis, Gephyrea, Brachiopods, and Mollusks. The larva of Thysanozoon has many points in common with the trochosphere, though its want of an anus is strange and difficult to explain. The Rotifers are acknowledged to be persistent trochospheres. And accordingly all these forms may be older and more primitive, by virtue of their lack of segmentation, than all the Chætopods.

D. W. T.

### SCIENTIFIC SERIALS

*The Journal of Anatomy and Physiology*, January 1884, contains:—A. Milnes Marshall, M.D., certain abnormal conditions of the reproductive organs of the frog.—S. A. Waddell, M.B., the urea elimination under the use of potassium fluoride in health.—B. C. A. Windle, M.A., M.D., primary sarcoma of the kidney.—R. J. Anderson, M.D., transverse measurements of human ribs.—Arthur W. Hare, M.B., a method of determining the position of the fissure of Rolando and some other cerebral fissures in the living subject.—G. Hoggan, M.B., new forms of nerve terminations in mammalian skin.—J. Symington, M.B., the fold of the nates.—W. Ainslie Holles, M.D., researches into the histology of the central gray substance of the spinal cord and medulla oblongata.—D. J. Cunningham, M.D., the musculus sternalis.—C. W. Cathcart, M.B., movements of the shoulder-girdle involved in those of the arm on the trunk.—J. B. Sutton, the relation of the orbito-sphenoid to the region pterion in the side wall of the skull.—Anatomical notices.

April contains:—J. B. Sutton, the nature of certain ligaments.—F. Le Gros Clark, F.R.S., some remarks on nervous exhaustion,

and on vasomotor action.—C. B. Lockwood, F.R.C.S. Lond., the development of the great omentum and the transverse mesocolon.—Arthur Thomson, M.B., notes of two instances of abnormality in the course and distribution of the radial artery.—J. W. Barrett, M.B., the cause of the first sound of the heart, and the mode of action of the cardiac muscle.—Prof. Cleland, F.R.S., notes on raising the arm.—R. W. Shufeldt, M.D., osteology of *Ceryle alcyon*.—A. M. Patterson, M.B., notes on abnormalities, with special reference to the vertebral arteries.—Geo. Hoggan, M.B., on multiple lymphatic nævi of the skin, and their relation to some kindred diseases of the lymphatics.—Prof. Cleland, F.R.S., notes on the viscera of the porpoise and white-beaked dolphin.—W. Arbuthnot Lane, F.R.C.S., costal and sternal asymmetry.—Anatomical notices.

*The Journal of Physiology*, vol. v. No. 1, contains:—E. Klein, M.D., F.R.S., the bacteria of swine-plague.—T. Lauder Brunton, on the rhythmic contraction of the capillaries in man, and on the physiological action of condurango.—J. Blake, on the connection between physiological action and chemical constitution.—H. H. Donaldson, and L. T. Stevens, note on the action of digitalis.—W. H. Gaskell, on the augmentator (accelerator) nerves of the heart of cold-blooded animals.

*Archives Italiennes de Biologie*, tome iv. fasc. 3, contains:—B. Grassi, the development of the vertebral column in bony fish.—L. Luciani, on the mechanical stimulation of the sensory centres of the brain-cortex.—A. Moriggia, on a new method of isolating the sensibility of the mobility of the nerves.—G. Magini, the induced unipolar current and the stimulation of nerves.—F. Marino-Zucco, upon the ptomaines with regard to toxicological investigations.—S. Richiardi, on the distribution of the nerves in the follicle of the tactile hairs of the ox, which are provided with a vascular erectile apparatus.—Ph. Lussana: (1) on the brain of the boa: considerations on comparative neuro-physiology; (2) on the sensibility of parts uncovered by skin; (3) on colour-hearing.—A. Maraccesi, the areola-mammillary muscle.—P. Foà, contribution to the study of the physiopathology of the spleen.—L. Griffini and G. Tizzoni, experimental study of the partial reproduction of the spleen; novel researches into the total reproduction of the spleen: an experimental contribution to the hematopoietic function of the connective tissue.—J. Bizzozero and A. A. Torre, upon the origin of red blood-corpuscles in the various orders of the Vertebrata.—J. Cattaneo, fixation, staining, and preservation of Infusoria.

Tome v. fasc. 1 contains:—C. Giacomini, the fascia dentata of the hippocampus major in the human brain.—A. Borzi, new studies in the sexuality of Ascomycetes (preliminary note).—L. Solera, contribution to the physiology of the succus intestinalis.—F. Schmi, tolerance of arsenic in domestic animals, and its distribution in the organism.—Ph. Lussana, on the quantitative and qualitative secretion of bile in the state of inanition after the section of the two pneumo-gastric nerves.—L. Camerano, (1) on the development of the Amphibia, and on what has been called their "Neotenia"; (2) researches on the prolongation of the branchial periods of the Amphibia.—G. Romiti, anatomical investigation of a case of death from the bite of a viper.—P. Fanzago, on the nest of *Geophilus flavus*.—E. Levier, the origin of the tulips of Savoy and of Italy.—P. Albertoni, critical and experimental studies upon the action and metamorphosis of certain substances in the organism, with respect to the pathogenesis of acetonæmia and diabetes.—L. Griffini, (1) an experimental study of the partial regeneration of the liver (preliminary communication); (2) on the total and partial reproduction of the follicular apparatus and of the calyciform papillæ in the rabbit (preliminary communication).—M. H. Peracca and C. Deregibus, note on *Calopeltis insignitus*.—L. Vincenzi, histological note on the true origin of some cerebral nerves.—A. Mosso, employment of the balance in the study of the circulation in man.

### SOCIETIES AND ACADEMIES

#### EDINBURGH

**Mineralogical Society**, June 24.—This meeting was held at the Museum of Science and Art, Edinburgh.—Prof. Jas. Geikie, F.R.S., in the chair.—The following papers were read:—On forms of silica, by Prof. John Ruskin, D.C.L. The Chairman and Dr. Dudgeon made some remarks.—On the application of the periodical law to mineralogy, by Prof. Thos. Carnelley of Dundee.—On the origin of the Andalucite schists of Aberdeenshire, by

Mr. John Horne, F.G.S.—On the occurrence of Prehnite and other zeolites in the rocks of Samson's Ribs and Salisbury Crags, by Mr. Andrew Taylor.—On a new locality for zoisite at Loch Garve, Ross-shire, by Mr. Hamilton-Bell.—On diatomaceous deposits in Scotland, by Prof. W. Ivison Macadam. The author drew attention to the vast extent of some of these beds, and gave particulars as to the proportions of silica, &c., contained in them. The deposits were being worked up to yield an absorbent for dynamite manufacture, and gave a material having double the liquid retaining power of samples of "kieselguhr" experimented on.—On the albertite beds of Strathpeffer, Ross-shire, by Mr. Wm. Morrison. Mr. J. Stuart Thomson referred to the fact that an allied jet mineral was found embedded in the oil-yielding bituminous shales of Midlothian. The substance only occurred in small quantities, the largest pieces not exceeding a pound in weight. It is capable of taking a fine polish, being similar to jet. In fact a jet-worker pronounced it at first to be Spanish jet.—On new localities for kyanite in Glen Urquhart, Drumlach Glen, Inverness-shire, and for staurolite at Fresholme, Enzie, Banffshire, by Mr. Thomas Walker.—On the crystallography of Bournonite, by Mr. H. R. Miers, British Museum. The paper criticised the history of the subject, and corrected various errors which have crept into the earlier literature. To those crystallographic forms hitherto recorded twenty-nine new forms are added as determined without doubt, and twenty-one as probable. A list of over 1000 angles, calculated from the elements of Miller, is given. The twinning (twin-plate the prism 110) is discussed; the observations of Hessenberg are supported, and it is concluded that the twinning is always by juxtaposition, not by interpenetration, but that Cornish crystals afford an example of composition perpendicular to, as well as parallel to, the plane of composition.—On a peculiar development of tourmaline from Lockport, New York County, by Mr. R. H. Solly, F.G.S.—Notes on the metallic veins of the Upper Hartz, Germany, by Mr. H. M. Cadell.—Scottish localities for actinolites, by Mr. Peyton.—On Welsh gold, by Mr. T. A. Readwin. A specimen weighing 160 grains, from the Mawddach Valley, Merionethshire, was exhibited.

DUBLIN

Royal Society, June 16.—Section of Physical and Experimental Science.—G. Johnstone Stoney, D.Sc., F.R.S., Vice-President, in the chair.—The following papers were read by Prof. G. F. Fitzgerald, M.A., F.R.S., Hon. Sec. :—(1) On a non-sparking dynamo. By applying the principles of Maxwell's modification of Thomson's electrical doubler to a dynamo in which the current passes through two or more coils in parallel circuit, it is possible to arrange the magnetic field and the brushes so that when the terminals of any coil come into contact with their brushes, the terminals shall be at the same difference of potential as the brushes, and that when they break contact there shall be no current running in the coil, thus avoiding all sparking. The energy of self-induction usually wasted on local currents and sparks will in this case be spent in producing useful current.—(2) On dust repulsion. Prof. Osborne Reynolds's theory of the action of the radiometer leads to the conclusion that a very small body in dense gas is subject to similar forces as the vanes of a radiometer in rare gas, and he made experiments which showed that silk fibres in air at considerable pressures were subject to apparent repulsion by radiation: a similar action on dust would explain the dust repulsion observed by Dr. Lodge.—(3) On currents of gas on the vortex atom theory of gases. As the momentum of a simple ring vortex is not proportional to its velocity and varies with its temperature, the momentum of a current of vortex rings would do so too. This and the variations with temperature of the velocity of sound and of the diffusion of gas through small apertures all point to the conclusion that a simple vortex ring is certainly too simple to explain the laws of material atoms. A difficulty is raised as to the amount by which the medium is carried forward by the translation and rotation of the earth.—(4) On a method of studying transient currents by means of an electro-dynamometer. By comparing the initial swing of a ballistic galvanometer which depends on  $SCdt$  with the initial swing of an electro-dynamometer which depends on  $SC^2dt$  it is possible in many cases to determine, in addition to the total quantity of electricity that passes in the current, several matters as to the distribution of the current during its time of passage.—Prof. E. Hull, LL.D., F.R.S., on the geological age of the North Atlantic Ocean as bearing on the question of the permanency of continents and oceans. After referring to the views

of those who hold the doctrine of "the permanency of oceans and continents" as opposed to those who, with Lyell, hold that continents and oceans have been interchanged during the past history of the globe, the author proceeded to consider how the formation of the North Atlantic Ocean might be adduced in support of one or other of these views. Remarking that this ocean was the only one at present known which could be used in evidence, inasmuch as we were in possession of sufficient knowledge of the geological structure of the regions by which it is bounded to the east and to the west, he proceeded to show how the distribution of the Silurian and Carboniferous rocks of North America, on the one hand, and of the British Isles and Western Europe on the other, pointed to the existence of the derivative lands in the direction of the Atlantic Ocean during these periods. In each case it was shown, by reference to details, that the sedimentary portions of these formations swell out towards the borders of the ocean, and tail out or become attenuated towards the interior of the continents in the opposite directions. From this it was inferred that the lands from which the sediment was derived occupied the region now overspread by the ocean; and, considering the great thickness of the sediments of these formations, the derivative lands were inferred to be of continental proportions. An additional argument in support of this view was also adduced from the distribution of the calcareous with the sedimentary deposits; for it was shown that the calcareous deposits (which were in the main of marine organic origin) swell out and sometimes replace the sedimentary deposits, as we recede from the borders of the ocean on either hand. From these considerations the author concluded that down to the close of the Carboniferous period the North Atlantic was for the most part in the condition of a continent, while the regions of Central and Eastern America, and of the British Isles and Western Europe, were submerged under oceanic waters. After this period, however, the relations were altered. With the upheaval of the Alleghanies at the close of the Palæozoic epoch, and with the terrestrial movement which at the same time affected the Carboniferous and older rocks of the British Islands and Western Europe, the Atlantic continent was converted into an ocean, in which condition it has remained to a great degree ever since. The author inferred from all this that the history of the North Atlantic Ocean might be adduced in support of the views of those who hold the doctrine of the "interchangeability of oceans and continents" rather than of the other.

Section of Natural Science.—Rev. M. H. Close, M.A., in the chair.—Rev. Dr. Haughton, F.R.S., on the possibility of the formation of coloured solar and lunar halos produced by the suspension in the air of volcanic dust caused by the explosion of Krakatoa in August 1883.—Prof. C. R. C. Tichborne, Ph.D., on an argenticiferous galenitic blende found at Ovoca, Co. Wicklow. This mineral is very little known; it has been called "kilmacooite" locally in Ovoca, and it is generally termed "blue-stone" in the Island of Anglesey, the only two places in the United Kingdom where it is found. An analysis of the mineral made by the author gave the following results:—

Silver <sup>1</sup>	...	...	...	...	...	0'024
Zinc	...	...	...	...	...	25'27
Lead	...	...	...	...	...	25'18
Iron	...	...	...	...	...	5'51
Manganese	...	...	...	...	...	trace
Antimony	...	...	...	...	...	0'21
Arsenic	...	...	...	...	...	0'08
Copper	...	...	...	...	...	2'50
Alumina	...	...	...	...	...	0'60
Magnesia, with traces of Calcium	...	...	...	...	...	0'02
Sulphur	...	...	...	...	...	23'71
Silica	...	...	...	...	...	16'896
						100'000

This mineral contains various amounts of pyrites according to the situation of the lode. The specific gravity was 4'73—intermediate between blende and galena—but it was harder than either of these minerals, and was therefore raised by blasting. The author finds by experiments that this mineral is a mechanical

<sup>1</sup> Equal to about 8 troy ounces per ton, or 8½ ounces avoirdupois. The mineral may be said therefore to consist of—  
 Sulphide of zinc ... .. 37'68 per cent.  
 Sulphide of lead ... .. 29'07  
 Sulphide of silver ... .. 0'0275 "

mixture of microscopic crystals of blende and galena; it forms a fine-grained saccharoidal mass, very homogeneous in structure, except as regards the pyrites, and occurs in isolated crystals easily discernible by the eye. The author objected to the terms which had been applied to this mineral on the grounds that they were too local, and did not describe the ore. He explained his method of determining the actual physical as well as the chemical composition of the ore. In conclusion, he said that he was tempted to quote from his report upon the Dublin International Exhibition of 1865 in connection with the raising of silver in Ireland. At that time he found that this country was a large supplier of silver, but he was almost afraid to make the calculation now that he then made of the silver supplied by Ireland. He stated that in 1865 Ireland yielded 14,000 ounces of silver per annum, or 2.4 per cent. of the whole of the silver raised in the world, and its value might be estimated at 3850*l.* per annum, exclusive of the accompanying lead. If 1000 tons of this ore could be supplied, which represented of silver alone 8000 ounces, how lamentable it seemed that this valuable industrial resource should remain unworked.—G. H. Kinahan, M.R.I.A., notes on the earthquake that took place in Essex on the morning of April 22, 1884.

## SYDNEY

**Royal Society of New South Wales, June 4.**—H. C. Russell, B.A., F.R.A.S., President, in the chair.—Three new members were elected, and forty-six donations were received.—The following papers were read:—On rain and its causes, by Edwin Lowe, in which he advocated the firing of cannon and of explosives for bringing about the precipitation of rain.—On the removal of bars from the entrances to our rivers, by Walter Shellshear, Assoc.M.Inst.C.E.—A specimen of scum from a pond near Campbelltown was exhibited. It had been noticed that the surface of the water was covered with a rich green growth in the mornings, and that this changed to a deep red in the afternoons. Messrs. Morris, M.R.C.S., and Wright, M.R.C.S., stated that it appeared to be due to *Astasia hæmatodes*, Ehr.

## PARIS

**Academy of Sciences, July 21.**—M. Rolland, President, in the chair.—Presentation of two unpublished essays of Augustin Fresnel, found among the papers of Ampère, by M. Bertrand. The subjects of these essays are the following:—(1) Comparison of the hypothesis of electric currents round the axis of a magnet with that of electric currents round each molecule of matter; (2) Second note on the hypothesis of particular electric currents. These documents are both in the handwriting of Fresnel, but without title or signature, and one only bears a date, that of June 5, 1821.—A study of the geometrical deformations determined by the crushing of a straight cylinder in the direction of its axis between two planes (two illustrations), by M. Tresca.—On two theorems of Prof. Sylvester in connection with his complete demonstration of the rule of Newton in the form given to it by Newton himself, by M. de Jonquières.—Note on the equation in matrices  $px = xq$  (continued), by Prof. Sylvester.—On the solution of the most general case of linear equations in binary quantities, that is to say, in quaternions or in matrices of the second order, by Prof. Sylvester.—Note on the maritime canals of Suez and Panama, by M. de Lesseps. In presenting the report of the International Commission on the widening of the Suez Canal, the author expresses the hope that it will soon be able to afford easy passage to ten or twelve million tons of shipping yearly. The Panama Canal, he expects on the report of Mr. Dingle, will be completed in the year 1888.—On the proposed formation of a so-called inland sea in Algeria and Tunisia, by M. E. Cosson. The author repeats the objections already urged against M. Roudaire's project, which, in the discussion that ensued, was supported by M. de Lesseps.—Remarks in connection with the last letter received from Lapérouse, dated Botany Bay, February 7, 1788, by M. de Jonquières.—On electro-capillary relations, by M. P. Garbe.—Direct measure of the two static components and of the dynamic component of the magnetic field of condensing-machines, by M. G. Cabanellas.—Researches on magnetism, by M. Duter.—On a new electric pile with carbon electrodes, producing an electromotor force equal to 0.6 volt, by MM. D. Tommasi and Radiguet.—On the numerical value of Poisson's coefficient as determined by experiments made with caoutchouc, by M. E. H. Amagat.—Temperature and critical pressure of nitrogen; boiling points of nitrogen and ethylene under slight pressures, by M. K. Olzewski.—On the properties of the liquefied vapour of

ethylene, and on its employment as a refrigerator, by M. K. Wroblewski.—Action of the induction spark on benzine, toluene, and aniline, by M. A. Destrem.—On the production of a crystallised manganite of baryta, by MM. G. Rousseau and A. Saglier.—On the combinations formed by the sesquioxide of chromium with the other metallic chlorides, by M. L. Godefroy.—On a general reaction of the polyatomic alcohols in presence of borax, and of the paratungstates, by M. D. Klein.—Remarks on the disinfecting properties of borax applied inwardly, by M. E. de Cyon. From experiments continued over six years the author concludes that borax is a powerful antiseptic, and that it may be introduced in any required quantity into the system to preserve it from all contagions caused by parasites or microbes. As a prophylactic against cholera he recommends boric acid or a solution of borax to be applied to all the external mucous membranes, and about six grains of borax to be taken every twenty-four hours with the food and drink. It appears not only to act directly on the microbes contained in the intestinal canal, but also to attack the bacilli that may have penetrated into the blood.—Researches on the physiological development of *Cerooma schreberi*, *Stenoria apicalis*, and other insects of the order of Cantharides, by M. H. Beauregard.—Remarks on the action of the heart in insects during their metamorphosis, by M. J. Künckel.—Note on the origin and distribution of phosphorus in coal and cannel-coal, by M. A. Carnot.—On the variation, under pressure, of the temperature determining the transformation of the iodide of silver, by MM. Mallard and Le Chatelier.—Researches on the influence of light on the respiration of vegetable tissues destitute of chlorophyll, by MM. G. Bonnier and L. Mangin.

## VIENNA

**Imperial Academy of Sciences, June 13.**—E. Mach and T. Wenzel, on the fixation of a very transitory phenomenon by instantaneous photography.—E. Tangl, on the continuity of protoplasm in vegetable tissue.—M. Loewit, contributions to theory of blood-coagulation, &c., on the importance of the blood-disks.—B. Schudel, on propylidene-dipropyl-ether.

## CONTENTS

Forestry . . . . .	
Lenses . . . . .	311
Our Book Shelf:—	
Schwackhöfer's "Fuel and Water."—Prof. Fleeming	
Jenkin, F.R.S. . . . .	311
Mackay's "Elements of Euclid" . . . . .	311
Jagnaux's "Traité Pratique d'Analyses chimiques et	
d'Essais industriels" . . . . .	311
Letters to the Editor:—	
The Relation between the B.A. Unit and the Legal	
Olm of the Paris Congress.—R. T. Glazebrook	311
The Yard, the Metre, and the Old French Foot.—	
Lieut.-Col. J. Herschel, R.E. . . . .	31
Fireballs.—W. J. Millar . . . . .	31
The Swallowing of one Snake by another.—Baron	
C. R. Osten Sacken . . . . .	312
The Red Sunsets.—Chas. Morris . . . . .	312
The Saltness and the Temperature of the Sea. By	
Hugh Robert Mill . . . . .	313
Specialisation in Scientific Study . . . . .	314
Two Greek Geometers . . . . .	315
The Royal Gardens at Kew . . . . .	316
Mr. Thoroddsen's Geological Explorations. By	
Th. Thoroddsen . . . . .	317
Seats in Railway Carriages. (Illustrated) . . . . .	318
A New Principle of Measuring Heat. By Otto	
Pettersson. (Illustrated) . . . . .	320
Notes . . . . .	323
Our Astronomical Column:—	
Schmidt's Variable-Star in Virgo . . . . .	325
A New Comet . . . . .	326
Scottish Meteorological Society . . . . .	326
The Philosophical Society of Glasgow . . . . .	327
Science in Russia . . . . .	327
Recent Morphological Speculations, III. (Illustrated)	
. . . . .	328
Scientific Serials . . . . .	330
Societies and Academies . . . . .	330

THURSDAY, AUGUST 7, 1884

ELECTRIC LIGHTING

*A Practical Treatise on Electric Lighting.* By J. E. H. Gordon. (London: Sampson Low and Co., 1884.)

PRACTICAL treatises on this subject are very numerous, but they do not emanate from the right men. We want a book from a perfectly independent authority, unflavoured with the taint of invention, the result of practical experience. Mr. Gordon is in many respects well qualified for the task, but he is an inventor, and his book is strongly impregnated with prejudice and a green-spectacle view of the subject. He is, however, a staunch believer in the immediate future of successful electric lighting, and is very hopeful that the dark clouds that now envelop it will be dispelled by the enlightenment of steady progress.

After an introductory chapter on the general principles of artificial lighting, he deals with the conversion of electric currents into heat, and shows how carbon, when raised to incandescence, fulfils all the conditions required to give the maximum light with the minimum expenditure of heat. The problem is to concentrate the heat in a solid of the smallest possible size or with the smallest possible cooling surface. Electrical units—amperes, volts, ohms, coulombs—and their relation to each other and to the ordinary heat and work units are explained, though, curiously enough, that most useful and much employed unit the *watt* is not even mentioned. The rules that regulate derived currents lead to an investigation of the method of calculating the power wasted in a network of conductors—a matter of very serious consequence in the commercial aspect of electric lighting, though Mr. Gordon does not touch on any of the recent methods devised to reduce the excessive cost of mains. We then have a disquisition on the experimental measurements of currents, electromotive forces, resistances, and power developed, with a description of various indicators and measurers employed. No reliable instrument has yet been introduced for ordinary practical use, and there are many instruments now undergoing trial which Mr. Gordon has not touched upon—particularly those of Marcel Deprez in use on the Continent, and which were exhibited at Munich and Vienna.

A capital chapter is devoted to glow lamps. "The first public exhibition of incandescent lamps that was made in this country was made by Mr. Swan before the Society of Telegraph Engineers on November 24, 1880. The first exhibition in America was made by Mr. Edison" (p. 62). Mr. Gordon does not give the date! Arc lamps follow, Mr. Crompton's admirable lamp being that selected for description.

Perhaps the most valuable and certainly the most novel chapter in the book is that written by Mr. Crompton on carbons used in arc lamps. The following information is useful (p. 105):—

"The diameters most commonly used have been as follows:

For currents from	7-12 amperes	9 mm. to 11 mm. diameter.
"	12-18 "	11 mm. to 13 mm. "
"	18-25 "	13 mm. to 15 mm. "
"	25-40 "	15 mm. to 18 mm. "
"	40 upwards	18 mm. to 20 mm. "

And the following is startling:—

*Illuminating Power per Electrical H.P. of 13 mm. Carbons of different Makers. Currents from 15 to 20 amperes*

Name of Maker	Candle Power per H.P.
Siemens (cored), pos. } ... .. 4270	
Carre (cored), neg. } ... .. 3514	
Siemens (cored) ... .. 3500	
Barnsley Co. ... .. 2986	
Johnson and Phillips ... .. 2920	
Sautter and Lemonnier ... .. 2773	
Carre (not cored) ... .. 2580	
Silvertown (Gray's) ... .. 1972	
Carre (cored) ... ..	

We then have a chapter on magnets and electro-magnetic induction, which leads to the general principles and theory of electric generators, including a very admirable account of that important subject, self-induction.

*"It is found experimentally, and can be proved mathematically, that if a coil of wire forms part of a circuit, and an alternating E.M.F. sends a current through it, that the current will be much less than it would have been had the same resistance been interposed in the form of a straight wire.*

*"Further, the proportional diminution becomes greater as the current is increased by the reduction of the resistance; and finally, for a given E.M.F., a given rate of alternation, and a coil of given shape, a limit is reached beyond which even reducing the resistance to zero does not increase the current" (p. 123).*

*"This diminution, however, does not, to the best of my belief, waste energy or diminish the efficiency of the machine; it only diminishes its output. Thus self-induction increases the size of a machine required to feed a certain number of lamps, but it does not perceptibly increase the H.P. required to drive the machine with that number of lamps on it.*

*"The effect of self-induction increases as the current increases, and therefore short-circuiting a coil of an alternating machine does not indefinitely increase the current in that coil, and seldom increases it enough to injure the insulation" (p. 137).<sup>1</sup>*

Of course we have a good description of alternate-current machines, and after some adverse criticism of the Ferranti type (which is imperfectly described), and not justified by the performance of the latter, Mr. Gordon describes his own form, which is chiefly distinguished by its size and weight. A few direct-current machines are described—not the best—and their regulation briefly referred to, with the curious conclusion (p. 183):—

CONCLUSION.

*"The true secret of successful regulation is to have very large dynamos, because then, as we have said before, the maximum number of lamps that can be turned out at one time is a very small percentage of the whole, and when there are a great number of lamps on one machine, the cost per lamp of regulating, either by hand or by an elaborate mechanical contrivance, is very trifling."*

Goulard and Gibbs' secondary generators and the various secondary batteries are briefly despatched. *Apropos* of the latter he says (p. 191):—

*"There is no doubt that the interest and depreciation on a set of secondary batteries large enough to enable an electric light plant to work day and night, and so give*

<sup>1</sup> The italics are not ours.

out to the lamps no electricity in the day but a double quantity in the night, is vastly greater than the interest and depreciation on a complete duplicate set of engines, boilers, and dynamos."

Photometry has only one page devoted to it, and Chapter XIX. is so unique that we reproduce it in full (p. 201):-

#### "CHAPTER XIX

##### "CENTRAL STATION LIGHTING

"I had intended to write a long chapter with the above heading, but, for various reasons, I am not yet prepared to do so. I have, however, left in the heading, for the convenience of inserting such a chapter in a future edition of this book, should one ever be required."

This reminds one of the celebrated chapter about Snakes in Ireland: "There are no snakes in Ireland."

The book ends with the excellent rules and regulations for the prevention of fire risks prepared by the Society of Telegraph Engineers. Several useful tables are given in the appendix.

The book is disappointing not for what it contains but for what it does not contain. There is in it a strange mixture of the elementary and the advanced. After an algebraical description of the relations that exist between current work and power, we are told by a footnote (p. 19), "The symbol  $\sqrt{\quad}$  means 'square root of' the quantity under it." There is much hasty editing. At p. 30 we are promised in a footnote a mathematical proof in the appendix which does not appear there. At p. 25 the symbol for a battery is wrong - the poles are reversed. The present value of  $H$  at Greenwich is given at p. 40 as '1794, and at p. 48 as '181. The illustrations, it may be remarked, are excellent.

It is to be hoped that a second edition will soon be required, so that Mr. Gordon may be able to remedy the defects of the present one. A good practical treatise is very much needed.

W. H. P.

#### OUR BOOK SHELF

*A Text-Book on the Method of Least Squares.* By Mansfield Merriman. (New York: John Wiley and Sons, 1884.)

THIS may almost be looked upon as a second edition of the "Elements" by the same author, which we favourably noticed in NATURE (vol. xviii. p. 299) soon after its appearance. The sale of the entire edition of the smaller book may be taken as evidence of its having met a want. The present work, though larger in appearance, covers about the same extent of ground, but, as is pointed out by the author, "the alterations and additions have been so numerous and radical as to render this a new and distinct book rather than a second edition."

In Chapters I. to IV., which present the mathematical developments of the principles, methods, and formulas, Dr. Merriman gives an introduction, and discusses the law of probability of error, the adjustment of observations, and the precision of observations at some length, and illustrates with numerous (for this subject) examples. In Chapters V. to IX. the application of the above to different classes of observations is made. These chapters are respectively headed: Direct Observations on a Single Quantity, Functions of Observed Quantities, Independent Observations on Several Quantities, Conditioned Observations, and the Discussion of Observations. These discussions are likely to be of use to engineers

and others specially interested in this branch of mathematics. In an appendix, *inter alia*, there is a short statistical statement on the history and literature of the subject, but the fuller list of literature of the earlier book is not reproduced: there are also given here eight handy tables and some other useful material. It is the only work of the kind with which we are acquainted, and is even better adapted, in our opinion, for the end Dr. Merriman has in view than his earlier book was.

*Some Propositions in Geometry.* In Five Parts. By John Harris. (London: Wertheimer, Lea, and Co., 1884.)

WHEN we received the parcel containing this work with some others for review, we speculated upon what the Editor could have sent us, and hope rose within our breast that some *magnum opus* awaited our perusal. But as we had heard no whisper of such work being on its way, our expectation cooled, and again casting our eyes on the unopened packet, and remembering former works of similar dimensions, a chill seized us, and we thought to ourselves, "Aut H. aut..." Shade of De Morgan! what are we to do with a work occupying  $144 + 8$  quarto pages treating of a subject so thoroughly threshed out, we had hoped, in your immortal "Budget"?

The title is an attractive one, and much of the work appears to be sound, but when we come across such problems as the trisection of any angle, the inscription of heptagons and nonagons in circles, *et id genus omne*, one draws in one's breath, and one's hair stands on end! The tentative methods given we dare say would enable one to perform these several operations to a very close degree of approximation, but this is not what ordinary mathematicians want. But we must be careful here, for Mr. Harris puts the question, "What is a mathematician?" and in his answer splits the creature up into "sorts." There is, for instance, the very positive and readily incensed mathematician, the highly exalted mathematician, the profound mathematician, and the exclusive orthodox mathematician.

It is under this last "sort" that we fear we must be classed. With him "Mathematics" is a sort of privileged religion, having its special *articles* and technical dogmas. None but the initiated must enter its temple, and woe be to him who dares to do so without a formal certificate from its priests. One of his most valued dogmas is that  $\pi = 3.14159 \dots$ . This is called an approximation; and which if a man do not faithfully believe he will inevitably go— Ah, well, never mind where he will go to; but, at all events, no mathematician must hold converse or communication with such a profane person."

It will be seen from this extract that Mr. Harris is a man of some humour, but even such oases do not render the vast Sahara of much of his book pleasanter reading. Indeed we have found it very hard work, and so we contented ourselves (for review purposes) with the careful reading of one of the "trisection" proofs; but we gave up in despair, as this proof involved the mastery of a previous proof, and we feared it would be a case of little fleas and lesser fleas, "and so *ad infinitum*." What did we do next? Why we applied a trigonometrical test, and found that the method in the text would not give the result at all, except in a special case. Life is really too short for such verification, and we must leave the task to others. The figures, as usual with Mr. Harris, are carefully drawn and very elaborate diagrams.

We regret more and more that so much labour should be bestowed upon such studies, which, we fear, an unbelieving world will never take up. What, then, is the value of  $\pi$ ? It is here said to be (Mr. Harris would say, proved to be) equal to  $\sqrt{8} \times \frac{10}{3} = 3.142696 \dots$

We lay down the book more in sorrow and pity than in anger and scorn.

## LETTERS TO THE EDITOR

[The Editor does not hold himself responsible for opinions expressed by his correspondents. Neither can he undertake to return, or to correspond with the writers of, rejected manuscripts. No notice is taken of anonymous communications.]

[The Editor urgently requests correspondents to keep their letters as short as possible. The pressure on his space is so great that it is impossible otherwise to insure the appearance even of communications containing interesting and novel facts.]

## "Gas-Burners, Old and New"

PERMIT me to point out a very obvious clerical error in the notice, in last week's NATURE (p. 270) of my little work having the above title, and to make a few remarks concerning your criticisms on the book. In the sentence, "Owen Merriman has taken pains to insist on the two great desiderata of gas-burners—high temperature and low temperature," the latter word is doubtless intended for *pressure*; and the sentence should read "high temperature and low pressure." It would have been scarcely necessary to make this correction, but that the notice may perhaps be read by many who are incapable of suggesting the correct reading, and to whom therefore the sentence as it stands will be absolutely meaningless.

While fully appreciating the kindly nature and intent of your criticisms, I cannot pass by, without a word of defence, your statement that you think I have "gone too far in attempting to give a popular theory of luminous combustion." I hope to be able to show that the particular extracts from that portion of the book to which exception is taken are practically correct, and, so far as could be looked for in a work addressed to miscellaneous readers, sufficiently precise. To this end I will deal with the various extracts *seriatim*. That "the various gases which constitute ordinary coal-gas do not all burn together in the flame" is a matter I had thought to be established beyond reach of dispute. But if evidence is required of the truth of the assertion, I need only point to a table prepared by Prof. Landolt, showing the composition of gases in the different parts of a gas flame, which is given by Prof. T. E. Thorpe, F.R.S., in a lecture on "Flame," forming one of the Manchester series of Science Lectures (Manchester: John Heywood). By this table it is clearly shown that in a gas flame, 3½ inches high, the olefines, or heavy hydrocarbons, do not diminish in amount until a height of 1·58 inches is reached; while the proportion of hydrogen is considerably diminished at a height only of 0·39 inch. Although it may not be mathematically correct to say that "the amount of light developed by any coal-gas flame is directly proportional to the degree of intensity to which the temperature of the carbon particles is raised," seeing that the light emitted is not in *exact* proportion to the temperature of heat, the statement is sufficiently correct for a popular treatise. What was chiefly intended to be enforced was that the amount of light evolved from a gas flame increases with its temperature, and in such a work a mathematical degree of exactitude is hardly looked for. Now, with regard to the other matters which are raised. To account for the destruction of luminosity which occurs when air is introduced into a gas flame, two theories have been put forward. According to the first, the heavy hydrocarbons at once meet with sufficient oxygen and are immediately consumed, without their carbon being first raised to a white-hot state; but this theory alone will scarcely explain the phenomenon, seeing that the effect of pure oxygen is to increase the luminosity of a flame. The other and more rational theory—and the one which is more generally accepted—supposes that the inert nitrogen which is thereby introduced reduces the heat-intensity of the flame "below the temperature required to decompose the hydrocarbons." It may be that to some extent both causes are at work. Lastly, as to the relative temperatures of a luminous and a non-luminous flame. Although the *average* temperature of the latter is higher than the former—as indeed it must be, seeing that the same *quantity* of heat is contained in a less space, the non-luminous flame nowhere develops so high a temperature as is found at certain of the hottest portions of the luminous flame. Mr. R. H. Patterson, in an article on the action of the blowpipe considered with reference to the principles of gas illumination (*Journal of Gas Lighting*, &c., vol. xxxv. p. 831), states that in the luminous region of an ordinary gas flame he has succeeded in melting a platinum wire: a result which he could never attain with a non-luminous flame."

July 21

"OWEN MERRIMAN"

‡ [We thank our correspondent for pointing out the clerical

error "low temperature" for "low pressure" in our article. We consider that the sentence, "The various simple gases which constitute ordinary coal do not all burn together in the flame; the temperature required to effect their ignition being lower for some of them than for others," is misleading. The ordinary reader would understand this to mean that the constituent having the lowest ignition point catches fire and burns away first, and then the constituent of next lowest ignition point catches fire and burns away, and so on; whereas Blochmann's researches show that the combustions are not distinct, but that the rate of combustion of the hydrogen is greater than the rate of combustion of the other inflammable gases.

We do not think it "sufficiently correct" to say that the intensity of light is *directly proportional* to the temperature of the coal-gas flame: perhaps it would be nearer the mark to say that the intensity of the light varies as the fifth power of the temperature within certain limits. The admission of air into the Bunsen flame destroys the luminosity more by *dilution* and *oxidation* than by *refrigeration*.—ED.]

## The "Cotton-Spinner"

IN a note on this rare British Holothurian (published in NATURE on June 12, p. 146), I drew a distinction between the kind of observations that were possible to a student in a museum and to one who was working at a laboratory specially adapted for biological investigation and situated on the sea-shore.

The experiences of the last few days have shown me only too well that this distinction was not overdrawn or too refined. By the kindness of Mr. John Snell of Truro, I have been favoured with two consignments of the "Cotton-Spinner;" three specimens which reached me on Monday by parcels post gave very sufficient evidence of having died some hours before. This mishap induced me to propose to Mr. Snell that he should send me specimens by express, and entrust them to the charge of the guard of the train; for this suggestion I am indebted to Dr. Günther. Mr. Snell not only did this to-day, but he was good enough also to warn me by telegram that the specimens would reach Paddington at 8 p.m. this evening. I was at the station to meet them, and I have no doubt that the comparatively fresh condition of the sea water was due to the attention of the guard of the train. Notwithstanding all this care and trouble, the three "Cotton-Spinners" were dead.

I have given this detailed, and, I fear, tedious exposition of the whole case, because it seems to me to clench the argument that the problems of the physiology of marine forms, and especially of those less-known creatures which live at a depth of—like the "Cotton-Spinner"—ten to twenty fathoms, are not soluble at some distance from the coast, however great be the trouble or the care that is taken in forwarding them. We must have a laboratory on the sea-shore.

The only fact that I have been able to observe is that the threads of the "Cotton-Spinner" do undoubtedly attach themselves to objects in their vicinity: one of the specimens obtained this evening was attached to sea-weed; from the cloacal orifice a connected strand of threads, about one-fifth of an inch in width and an inch in length, spread out at its free end into a number of more free threads which had attached themselves to the sea-weed which had been placed in the water; they extended over about two inches in breadth. From what I have learnt of the extensile and swelling power of these threads, I should take it that about as much had been expelled as would occupy the greater part of the cloacal cavity. A woodcut illustrating the cloacal cavity so filled by tubes, and drawn from a spirit specimen preserved in the British Museum, will be given in my paper on this animal, which will be published in the next (October) part of the *Proceedings* of the Zoological Society.

August 1

F. JEFFERY BELL.

## Krakatoa

I MOST respectfully beg to point out to you a few errors made in the English version of my "Short Report on the Krakatoa Eruption," published in NATURE, May 1.

It says on p. 15:—"In this eruption very curious objects were ejected, *i.e.* very smooth, round balls, resembling marbles, to the size of 1½ to 6 centimetres in diameter. *They are full of acids*; they contain 55 per cent. carbonate of lime," &c.

The words italicised are wrong. The original says: *Zij Cruisen sterk met Zuren*, which means: "*they strongly effervesce when*



moistened by powerful acids. P. 11, column 1, line 34, "1860" should be "1680"; p. 12, column 2, line 28, and also p. 13, column 1, line 5, *steatite* should be *pitchstone* (a vitreous variation of pyroxene andesite).

R. D. M. VERBECK,

Director of Java Geological Survey

Buitenzorg, Java, June 19

### THE METEOROLOGY OF BEN NEVIS

AS regards changes of weather and many other problems of meteorology, a knowledge of the vertical variations which take place in the atmospherical conditions is of first importance; and the only way we can hope to arrive at this knowledge is by regular observations made at stations as near each other as possible in horizontal direction, but differing as much as possible in height. This point was very clearly seen many years ago by the late Mr. Allan Broun, and the idea was practically worked out by him in the elaborate series of meteorological and magnetical observations simultaneously made on the peaks and ridges and in the adjoining valleys of the Western Ghats. These observations are the best anywhere yet made to supply the observational data for the discussion of some of the more important problems of meteorology; and the science sustained no ordinary loss in the death of Mr. Broun before he had discussed the observations which had been collected by his genius, energy, and self-denial.

Next in scientific value to Mr. Broun's observations are those made on Ben Nevis since June 1881. The special advantages of Ben Nevis as a meteorological observatory are that it rises to a height of 4406 feet, and is little more than four miles distant from the sea at Fort William, and that it is situated in the track of the great storms which sweep over North-Western Europe from the Atlantic. Hence observations made on the top and at the base of Ben Nevis possess a value altogether unique in meteorology; particularly in discussing the atmospheric movements which accompany cyclones and anticyclones, and in investigating tornadoes and other destructive winds which originate when the air is abnormally warm and moist near the surface, while aloft the temperature and humidity diminish with abnormal rapidity.

For the preliminary inquiry which is necessary in order to determine the chief points in the meteorology of Ben Nevis, there are now available for a comparison of the climate of the top of the mountain with that of the sea-level at Fort William, simultaneous observations for twenty-two months, viz.: from June to October of the years 1881 and 1882, and from June 1883 to June 1884. As regards the temperature, the monthly means for Fort William were compared with the normal monthly temperatures of that place as given in the paper on the "Climate of the British Islands" (*Journ. Scott. Met. Soc.*, vol. vi. p. 33). From the differences thus obtained, the approximate normal temperatures at Ben Nevis Observatory were determined. The coldest month is February, the mean being 22°0, and the warmest, July, 41°3, August being nearly as warm, the mean being 41°1; and the annual mean temperature 30°9. Comparing the normals with those of Fort William, the greatest difference is 18°0 in May, from which it steadily diminishes to 14°9 in December, and then rises more rapidly to the maximum in May; the annual difference is 16°3. The greatest difference, or the most rapid fall of temperature with height, is in the spring and early summer, when the climate of the west is driest, the temperature of the Atlantic lowest relatively to that of the air, and the top of the mountain still covered with snow. The least difference is in late autumn and early winter, when the climate of the west is wettest, Ben Nevis most frequently and densely clouded, and the temperature of the Atlantic highest relatively to that of the air. The observations of temperature at the high- and low-level stations show a variation with the hour of the day even

more decidedly marked than that with season. Thus, in January the decrease of temperature, deduced from the mean maxima and minima respectively were 16°2 and 15°2, but in April these were 23°1 and 12°9, being thus in January nearly equal, whereas in April the difference of the maxima was nearly double that of the minima.

The annual means give, therefore, a decrease of temperature with height at the rate of 1° for every 270 feet of ascent—the most rapid decrease being 1° for every 245 feet in April, and the least rapid 296 feet in December.

But the individual observations show wide divergences from these rates of decrease. As disturbing conditions, the more important of these are the instances of abnormally large decrease, seeing that these imply a temperature near the surface much above the normal with respect to the higher strata, by which the equilibrium of the atmosphere is destroyed, and rapidly ascending and descending currents are generated, thus giving rise to some of the most destructive storms of wind. Of the illustrations the observations give of a rapid decrease, reference may be made to those of October 13, the day preceding the great storm which proved so destructive to the fishermen on the Berwickshire coast.

Even more striking, and, as regards their bearing on the theory of storms and weather changes, perhaps even more important, are those instances of abnormally small differences between the temperature at the top and base of the mountain, of which a good example which occurred on September 21, 1882, was given in NATURE, vol. xxvii. p. 176. All such cases have been accompanied with a high temperature and an excessive dryness of the air. It is these qualities of air which immediately connect the phenomena with the great cyclonic and anticyclonic systems in which or near to which Ben Nevis is for the time situated. The most striking case of all occurred on December 31, 1883, on which day the maximum temperature at Fort William was 30°6, and minimum 27°2, these being at Ben Nevis Observatory 32°0 and 22°8. At 11 a.m. the temperature at Fort William was 27°5, but on Ben Nevis it was 32°0, with a wet bulb as low as 24°4. Hence at this hour the temperature of the air was 4°5 higher at the Ben Nevis Observatory than at Fort William, 4406 feet lower down, and this relatively high temperature was accompanied with excessive dryness represented by the humidity of 33. From 6 a.m. to noon temperature was continuously higher on Ben Nevis than at Fort William. At 11 a.m. the abnormality in the vertical distribution of the temperature amounted to 20°5. It is of importance to note that at this time of relatively high temperature and great drought, atmospheric pressure was very high at the Observatory, the reading of the barometer at 32° being 25.915 inches, being absolutely the highest that has occurred from November 28, 1883, to June 30, 1884. At Fort William the sea-level pressure was 30.608 inches.

Another peculiarity of the temperature is the small diurnal variation caused by the sun at all seasons, but particularly in winter; and the large variation due to the temperature changes which accompany the passage of cyclones and anticyclones over the Observatory. The means of the hourly observations show that even in May the difference between the mean warmest and mean coldest hour was only 3°3. In January the difference was only 0°8, and in this month the highest hourly mean occurred during the night, and the lowest during the day. On the other hand, the difference of the mean daily maxima and minima for January was 6°7. In truth, the influence of the sun on the temperature of the air is all but eliminated during the winter months owing to the thick covering of mist, fog, and cloud, in which the mountain is almost constantly wrapped.

Since June 1881 the highest temperature on Ben Nevis was 59°3 on August 8, 1882, and the lowest 9°9, on Feb-

ruary 2, 1884. During these months the extremes at Fort William were  $73^{\circ}8$  and  $27^{\circ}0$ .

The barometric observations at Fort William and Ben Nevis were dealt with in a similar manner, and a table of corrections of the Ben Nevis observations to sea-level was constructed directly from the observations of the two stations, the table giving the approximate corrections for each tenth of an inch of the sea-level pressure, and for each degree of mean temperature of the stratum of air from the Observatory to sea-level, which was assumed to be the arithmetic mean of the temperatures at the two stations. The normals of atmospheric pressure for Ben Nevis were then calculated. The lowest normal monthly pressure is  $25\cdot141$  inches for January, and the highest  $25\cdot410$  inches for June, and for the year  $25\cdot281$  inches. Comparing the normal pressures at the high- and low-level stations, pressure on Ben Nevis is on the mean of the year  $4\cdot557$  inches lower than at the sea-level at Fort William, the least monthly difference being  $4\cdot484$  inches in July, and the greatest  $4\cdot620$  inches in February.

The morning maximum of pressure was at 10 a.m. in January, at noon in February and March, 1.30 p.m. in April and May, while in June it was delayed to 3 p.m. From Mr. Wragge's observations in 1882, the same diurnal phase of the pressure occurred about 9 a.m. in the summer months at Fort William, being thus six hours earlier than on the top of Ben Nevis. From February to June the morning minimum of pressure was very large. On the other hand, the afternoon minimum was comparatively small; and as the season advanced it became less and less pronounced, till in June the diurnal oscillation approached closely to one single minimum and maximum. Owing to the low readings of the morning minimum and the high readings of the afternoon maximum, which have their explanation in the diurnal change of the temperature of the aerial stratum below the level of the Observatory, the diurnal range of pressure on Ben Nevis exceeds that of any other meteorological station in Scotland.

The rainfall on the top of Ben Nevis is very large. At Fort William the mean annual amount is about 83 inches. During the three years beginning 1881, while the rainfall at Fort William was  $24\cdot59$  inches from June to October, it was  $47\cdot10$  inches on Ben Nevis. During the two years 1882 and 1883, for the same months, the rainfall at Fort William was  $21\cdot96$  inches; at the lake (1840 feet high),  $28\cdot42$  inches; but on Ben Nevis,  $44\cdot35$  inches: hence during the summer months the rainfall on Ben Nevis is nearly double that of Fort William, and the greater part of the increase in the rainfall from Fort William to the top of Ben Nevis takes place above the level of the lake. No inconsiderable proportion of the large rainfall collected on the top is due to driving mists and drifting wet fogs, during which, though often no raindrops are visible, or only a few small drops at wide intervals apart, yet everything is dripping wet, and the funnel of the rain-gauge is crowded with numerous runnels of clear water, steadily trickling down into the receiver of the gauge.

On plains and extensive plateaux the wind attains a diurnal maximum velocity shortly after noon which is generally nearly double the minimum velocity, which occurs shortly before sunrise. But on Ben Nevis, in common with other observatories which are situated on peaks rising to a considerable height above the whole of the surrounding region, the reverse of this takes place, the maximum velocity occurring during the night, and the minimum during the day. The difference between the mean minimum and maximum hourly velocities on Ben Nevis in each of the seven months ending June last was about five miles. A tendency to a secondary maximum was shown in May, but in March, April, and June no such tendency was apparent. A full gale from south-east blew almost continuously at the Observatory from February 15 to 21, and during these seven days there was a mean maximum of 58 miles from 5 to 6 a.m. and a

mean minimum of 42 miles from 4 to 5 p.m. With an hourly difference of 16 miles, the daily variation in the velocity of the wind was maintained during the continuance of this great storm.

Another main object in constructing the table of corrections to sea-level for Ben Nevis Observatory was to afford a ready comparison between the atmospheric pressure at sea-level and that on Ben Nevis from the important bearings of the observed differences on the changes of weather which precede, accompany, and follow storms, and on such inquiries as the singular and opposite relations which obtain during storms of wind and during the remarkable weather which often occurs within, or on the confines of, anticyclones.

ALEXANDER BUCHAN

### THE FORESTRY EXHIBITION

SINCE our last notice of the International Forestry Exhibition great progress has been made in the concentration and arrangement of the various products which testify to the importance of the subject. We believe that the juries have now met, and such names as Sir Joseph Hooker, Colonel Moncreiff, R.A., Profs. T. R. Fraser of Edinburgh, Bayley Balfour of Oxford, Dr. Lyons, M.P., with several Indian and Scotch Forest Officials, and others will inspire confidence in their work. We to-day give a description of one of the most interesting sections, which well repays a visit.

The Japanese Court occupies the eastern transept, and forms one of the largest and most important sections. The whole arrangements have been carried out in the most thorough and business-like manner. Immediately on the arrival of their goods, knowing beforehand the amount of space required, and working with a rapidity and skill which might put to shame some more civilised nations, the Japanese Commissioners have shown that they are far in advance of many countries in business capacity as well as in the science of forestry. In Great Britain the importance of forestry to the welfare of the country and its colonies has but lately been recognised. In Japan, on the contrary, it has long formed an important feature in national education. This is evident from the ingenious devices represented on the walls of the department, and which can only have been the outcome of long experience.

With excellent taste the Japanese have placed the timber in the most prominent position, and the products in the background, giving at once the impression that it is purely a forestry exhibit. The central tables are occupied with longitudinal sections of trees, with the surface planed so as to render the grain visible. Above these are similar sections, but showing the bark, and above these are coloured drawings of the trees yielding them. At the foot of these sections a paper explains in English the Japanese name, the botanical name and habitat, and the relative rarity or abundance of the tree, its girth and height at fifty years old and at maturity, the best mode of propagation, the quality and uses of its wood and of other parts. Each section, drawing, and description is marked with a corresponding number. On the wall of the Southern Court are some artistic drawings in monochrome of the various devices for felling and floating the trees along mountain streams, for slipping them over precipitous cliffs, and for stopping and collecting the timber at certain localities in its course for storage. The expedients adopted for floating the timber down narrow gullies, and the sledges used for sliding it down over the snow in winter, and other details of forest work and a forester's life, are depicted in a manner that is easy to remember from the quaint dress, the life-like attitude, and excessive energy thrown into the actions represented. These drawings are mounted in wooden frames, and the background

tastefully decorated in a simple manner with fragments of veneer of different colours. They are accompanied by models which still better illustrate the means adopted in mountainous countries, and must prove exceedingly instructive to students of forestry.

Next in order come the tools used in the various operations of cutting, transporting, and working the timber and peeling the bark. Some of the axes and saws are of extremely peculiar shape, but admirably fitted for the purposes for which they are intended.

According to a printed table hung on the end wall, the area of the Japanese Empire is 38,563,718 chos (a cho = 2.450 acres), the area of forest (excluding the islands of Okinawa and Hokkaido) being 11,866,626 chos, or rather less than one-third of the country. Of this area 5,259,182 chos are worked by the Government, and 6,607,443 chos by private individuals. About a quarter of the Empire has, however, not yet been surveyed; the above figures, therefore, only refer to the surveyed portion. Accompanying this table is a map giving the distribution of trees in Japan, and marking out certain zones, each indicated by some particular tree forming a prominent feature in the landscape. Of these zones *Ficus Wightiana* characterises the lowest, *Pinus Thunbergii* the second; then follow in order *Fagus sylvatica*, *Abies Veitchii*, and *Pinus Cembra*. The extent of these zones is marked in colours on the map, and on excellent coloured drawings representing the habit of the five trees, and their foliage, flowers, and fruit in life-size are presented at one glance. The less important productions of the forests are appropriately illustrated by smaller collections, a simple expedient by which an idea of their relative consequence is easily conveyed. Fungi, dried and preserved in pickle, and a dried lichen (a species of *Gyrophora*), and a collection of seeds of forest-trees, well preserved, and carefully named, are placed near. Several fungi are cultivated on special trees. According to notes affixed to the tree-sections, among the trees thus employed are *Celtis sinensis*, *Carpinus laxiflora*, *Quercus crispula*, *cuspidata*, and *glandulifera*.

Roots, barks, and seeds used in medicine are not so well represented as usual. Even menthol, now tolerably well known in this country as a remedy for neuralgia, is not exhibited. A beautiful specimen of insect wax resembling spermaceti in appearance, but much harder, and identical with that used in China to coat candles to prevent their guttering, is exhibited. The insect producing it is cultivated on *Ligustrum Ibotu* and *Fraxinus pubinervis*.

An exceedingly ingenious double chop-stick is here shown, consisting of a piece of white wood, slit two-thirds of its length; on pulling the pieces apart, a wooden tooth-pick is seen inclosed in the centre. As the wood has never been entirely split, it is puzzling to know how the tooth-pick was inserted. This is done by cutting it with a special instrument when the wood is wet and can be extended. The leaves of two other plants besides those of tobacco are shown, the one made into cigarettes, and the other simply dried for smoking (*Sterculia platanifolia*).

The cooperage work seems to be carefully done, the barrels having polished surfaces, and in some instances the bands are made of plaited bamboo. The polishing of rough surfaces appears to be effected by the rough leaves of *Aphananthe aspera* and the stems of a species of *Equisetum*. Japanese tooth-brushes are exhibited, made of the frayed-out ends of a piece of white wood; and combs, and even tooth-combs, are made of similar material of a harder character, such as the wood of *Olea Aquifolium* and *Hovenia dulcis*. Dyeing and tanning barks are comparatively few in number, and walking sticks do not present any great variety, only a few being engraved or ornamented. A simple flower-pot for the wall of drawing-rooms consists of two joints of a large bamboo, with a piece cut out at the side of each joint so as to permit of a fern or bouquet depending over it.

In the left-hand court may be seen some bent wood furniture that might fairly compete with that of Austrian manufacture. In one corner may be seen a series of young trees four or five years old, imported from France, Germany, the United States, and other countries; indicating that acclimatisation of the useful trees of other countries has already been commenced in Japan. Wood-engraving and printing in one or more colours is illustrated by the engravings placed side by side with the blocks. The celebrated Japanese lacquer is exhibited in the crude state, and also applied to knick-knacks and other articles, some specimens of lacquered slabs having so high a polish as to appear like glazed ornamental tiles. These are accompanied by a coloured drawing of the foliage and flowers of the lacquer-tree painted on the wood of the same tree and framed, with other portions having the bark attached. Several other useful timber-trees are illustrated in the same ingenious manner. The almost transparent yet strong and tough paper made from the fibre of the paper mulberry-tree (*Broussonetia papyrifera*) is shown, but its manufacture is not illustrated by drawings, the exhibits being limited to products. This paper rolled into the form of a spill is strong enough to be used like string. Exceedingly thin planed shavings of wood, scarcely thicker than the paper above alluded to, occupy a conspicuous position. These are used for packing butter or other goods of similar description. A cursory glance at the notes appended to the sections of wood reveals many interesting facts regarding some Japanese trees and shrubs commonly cultivated in this country. Thus an oil is obtained from the seeds of the common *Camellia* (*C. japonica*), and rope is made from the stems of *Wistaria sinensis*. Charcoal, for the manufacture of gunpowder, is prepared from the wood of *Paurotonia imperialis*, and the wood of the deliciously scented *Olea fragrans* is used for wood-engraving and combs. A shrub, also indigenous in this country, *Viburnum opulus*, furnishes tooth-picks. A very ingenious use of the trunks of trees is the hollowing them out into drain-pipes, each about 6 or 8 feet long, and fitting into each other at the end. On the walls of this court illustrations are given of the mode of preventing the slipping away of soil on mountain-sides, and of the trees and shrubs and herbs useful for binding sandy soil or embankments, &c. Altogether the Japanese section is an exceedingly interesting one, and offers many useful suggestions to the foresters of Western countries.

#### PRACTICAL TAXIDERMY

AMIDST the many criticisms which are passed by visitors upon the collections in the new Natural History Museum of South Kensington, there is always to be found a word of praise for the improved appearance of the mounted animals in that Museum, and it may fairly be said that the encomiums which are heard on all sides have been justly earned by Dr. Günther and the staff of the Zoological Department; that is to say, if an honest endeavour to present to the public something better than can be seen in other museums counts for anything. The officers of the British Museum, in transferring the zoological collections from Bloomsbury to South Kensington, were heavily handicapped, for it was impossible to commence the mounting of the collections *de novo*, and they therefore had upon their hands a vast number of interesting specimens unfit to exhibit to the public, but valuable to the naturalist, and worthy of preservation as forming a historical part of that great zoological collection which is admitted by naturalists to be intrinsically the finest in the world. For some time before the removal a careful selection of duplicate specimens had been made, and these had been distributed to various provincial museums, but all those which possessed any scientific value, such as types, &c., have been carefully unmounted and added to the collection of skins, and it was curious

to note the progress of the art of taxidermy which these specimens exhibited. It is notorious that for many years the authorities of the Zoological Department have been troubled with the preservation of antique specimens of natural history which seemed to be falling into a state of natural decay; although no actual reason could be assigned for their dissolution, and moths and beetles have never been known to do any harm to the collections, thanks to the constant care which is exercised in that department. But on dismounting some of the ancient specimens, such as those presented by Colonel Montagu, it was discovered that they had never been properly skinned, and with the exception of the extraction of the entrails, the bones and flesh of the birds had been left entire, and apparently without an attempt to further preserve the specimens. The result may be imagined, and the difficulty of preserving these interesting relics will be fully appreciated by the naturalist of to-day. It has often been a source of wonder to zoologists as to what has become of many of the types of species recorded by Latham and the older writers on ornithology as existing in the British Museum, which certainly are no longer in the national collection. The records of the Museum show that they never descended to modern times, and there can be little doubt that the defective preparation of a hundred years ago was inadequate for their preservation, and that they were allowed to fall into decay by the earlier custodians of the national Museum, in whom the sacred value of a type was not so inherent as it is in the age in which we live.

We may hope that the improved preparation of the specimens in the Natural History Museum marks the commencement of a new era in the art of taxidermy, for the skilful mounting of animals is a real art, and ought to be recognised as such. An artist who portrays animal life successfully reaps the full appreciation of his countrymen, and is well paid for his work, but hitherto the taxidermist has never been properly appreciated, and until adequate remuneration is provided for the artists who reproduce natural specimens, we can never hope for the success of taxidermy as an art which ought to rank as high as that of the animal painter. The undoubted success which has attended the production of the groups of British birds which now adorn the corridors in the Natural History Museum is a great encouragement to those who have at heart the welfare of the art of taxidermy, and it cannot be denied that the mounting of these groups does credit to all concerned. We are aware that Prof. Flower (himself no mean taxidermist) takes a great interest in the improvement in the mounting of animals in the Museum of which he is so able a Director, and the exertions of Dr. Günther in this direction have been manifest since his appointment as Keeper of the Zoological Department in the British Museum, while the frequent occurrence of Lord Walsingham's name as a donor of many of these beautiful groups of "British birds in their haunts," shows the practical utility of having as a trustee a naturalist who labours to supply the wants of the institution of which he is one of the guardians. In the Bird Gallery itself, as well as in that of Mammalia and Osteology, the same wish to improve the natural appearance of the specimens exhibited is seen at every turn, and it is to be hoped that the lesson thus taught by the British Museum will be imprinted on the mind of every provincial curator, who will feel henceforth that the value of the collection under his charge will consist not so much in the array of mounted specimens which he can muster on his shelves, as in the excellent preparation of the few leading types which are really all that are necessary for the instruction of the public.

The above thoughts have been inspired by a perusal of a little work which has fallen into our hands, viz. the second edition of Mr. Montagu Brown's Essay on Taxidermy. Mr. Brown is the Curator of the Leicester

Museum, and he is a man of whom any provincial museum may well be proud. In a lecture delivered many years ago at Leicester Mr. Bowdler Sharpe gave some hints on what he conceived it to be the object of a County museum. It seemed to him that in the first place it was expected of every County museum to make as perfect a collection as possible of the natural productions of that County—that this should be the aim and object of every curator, and that all these exhibits should be arranged in the most popular and attractive form. It was impossible, he pointed out, for a local museum to attempt to show a perfect collection of all the classes of animals. This ought to be left to the British Museum; but he insisted that it was within the province of every such museum to exhibit a typical series of animals which would be useful for comparison with local species, and would educate the minds of an intelligent public towards an appreciation of the varied forms of animal life upon the globe, as compared with the zoology and botany of the county in which they lived. Shortly after the Committee of the Leicester Museum carried out this idea to a limited extent under the curatorship of Mr. Harrison, a most intelligent custodian, who is, we believe, now located at Birmingham; but the plan was fully developed by his successor, Mr. Brown, who has employed his talents as a taxidermist in a popular direction, and the result is that the collection of birds at Leicester is mounted in cases with the natural surroundings explaining their habits at a glance, and in a manner with which no guide-book attempting to illustrate a collection on a conventional plan can hope to vie. It may be a question for naturalists whether this will not be the museum of the future, but as evidence of the value of practical taxidermy this may be considered already *in fact accompli*; and in making these remarks it would be unfair not to mention the names of some of those who in England have contributed to the improvement of this art. Of these the honoured name of John Hancock stands first, for the influence of Waterton, who strove to import into this country an improved system of mounting animals, seems to have been but small among the generation which followed him. Mr. Hancock's groups in the Great Exhibition of 1851 left an indelible impress upon British taxidermy, and his rendering of a bird of prey is only equalled for life-like delineation by one of Wolf's pictures. Mr. A. D. Bartlett, the well-known Superintendent of the Zoological Gardens, is certainly one of the best taxidermists which this country has produced, while the art of mounting Mammalia has been studied with success by Mr. Rowland Ward and Mr. Edward Gerrard most of the best examples of the latter class in the British Museum having been mounted by the last-named artist. Many provincial men, such as Mr. Swainsland of Brighton, Mr. Shaw of Shrewsbury, and Mr. Quartermain of Stratford-on-Avon, have proved their ability as taxidermists, and London itself possesses adepts in the art who are equal to the great taxidermist Termayer of Holland, whose masterpieces may be seen in the Museums of Amsterdam and Leyden; but we doubt whether anybody has exercised more influence on the improvement in the mounting of animals than Mr. E. T. Booth of Brighton, whose collection of British birds exhibited in the Dyke Road Museum is one of the sights of England. To him belongs the credit of being the first to attempt a collection of British birds with their natural surroundings, and it is upon the lines introduced by Mr. Booth that the beautiful groups of our native species in their natural habitats has been attempted at the British Museum; and if the genius of Mr. Pickhardt who has mounted the birds, and of Mr. Mintorn, to whose skill the beautiful modelling of the flowers and trees is due, does not satisfy the aspirations of British naturalists, we shall feel that the improvements in the taxidermy of recent years have no real existence.

### NOTES ON THE CANADIAN NORTH WEST

THE excursion to the Rocky Mountains, along the Canadian Pacific Railroad, will probably prove a most attractive feature in connection with the British Association meeting this season. Living on the cars for several successive days and nights is a novel experience for most people, and one, it might be supposed, that would prove monotonous; but the alternation of forest, lake, prairie, and mountain scenery, each with its associated peculiarities, will probably prevent the trip becoming at all tedious. Some members of the Association may prefer taking the route through the United States to Winnipeg, but from thence all will proceed through the rich wheat lands of Manitoba, then over the rolling prairies west of Brandon, with their numerous alkali lakes and relatively unproductive soil beyond Moosejaw; through the cattle-ranching district at the eastern base of the Rocky Mountains, and up the winding Bow Valley to the summit-level in the Kicking Horse Pass. Here at Stephen, on the confines of British Columbia, the railway terminates for the present.

On crossing the prairies for the first time, many interesting peculiarities will arrest the attention; perhaps none so strongly as the general flatness and absence of timber, which as a rule only occurs skirting the rivers, or as a low scrub in certain wet or marshy lands, or in scattered individuals along the dry sand and gravel ridges. These are probably the patches of country that escape the prairie fires, owing to the vegetation being either too damp or too scanty to support a conflagration. Vegetation as a rule is luxuriant, especially on the rich lands, where the grasses grow to a great height. The soil is mostly a rich black loam of variable thickness, accumulating by the annual decay of the grasses or by the ash from the fires. The loam is thickest on those flat lands with clay subsoil that lie south of the Manitoba lakes; in the arid districts of the western sections it becomes very light.

The subsoil is for the most part stratified sand and sub-angular gravel, which often contain large boulders of gneiss and quartz; it appears to be in a great measure of glacial origin; but in many places, as in the vicinity of Winnipeg, the subsoil is a stiff brown clay which is probably the filling of an ancient lake; it is seen in the banks of the Red River and Assiniboine. In the high banks of the Saskatchewan at Medicine Hat the clay has more the appearance of a stiff boulder-clay.

A few miles up the River Saskatchewan from Medicine Hat there is an important outcropping of coal; another seam is exposed on the Bow River near Crowfoot Creek; but the most important is that on the Belly River, where there are active collieries, the fuel being conveyed down the river to Medicine Hat, whence it is distributed along the line of railway. These fuels are lignitic in character, and are considered to be either of later Cretaceous or early Tertiary age. They come to the surface in many localities, and evidently underlie a large portion of the western plains. Adjacent to the eastern face of the Rocky Mountains the strata in which the coals reappear are more indurated and highly inclined, and some of the beds contain silicified wood.

In the section of country between Moosejaw and Medicine Hat alkali lakes are numerous; the smaller ones evaporate during the dry season, leaving a flat surface covered by a thick, white, glistening deposit; from this district fine specimens of selenite are obtainable. Probably some of the largest of these bitter lakes are those called the Old Wives Lakes, which lie in a large, sterile depression, on Le Grand Coteau du Missouri, evidently representing the site of a former large inland sea. The fresh-water lakes and marshes, locally numerous along the track, generally teem with wild fowl. In many of them also the tall elevation of reeds, formed by the muskrat, may be seen.

Of other animal life on the plains there is a great absence. However, the so-called "blackbird" or purple crake (*Quiscalus*) is locally very abundant; during the early season they keep in pairs, but, on the ripening of the corn, immense flocks of them congregate about it; prairie chicken are also numerous, but of other birds there are very few. Snakes abound in some places; they are constantly to be seen basking in the sun along the railway track. Of mammals the most frequent is the little Gopher or "prairie dog." Almost the only other visible quadrupeds are foxes and a few antelope.

Of the former great numbers of the now practically exterminated buffalo there is abundance of evidence. Their wallowing holes and runs are seen in all directions; the latter, narrow furrow-like tracks, stretch in straight lines across the plains, being most numerous in the vicinity of water. Bleached bones and skeletons, which lie scattered about in great profusion, testify to the wholesale destruction effected, chiefly by the Indians and half-breeds. On the introduction of modern repeating rifles whole bands of buffaloes were ruthlessly slaughtered, solely for their tongues and skins, and often nothing save the tongues were taken from the carcasses.

This indiscriminate destruction has reduced the Indian of the plains to a state of the most abject poverty and destitution, for formerly most of his wants were supplied by the buffalo; now he is wholly dependent on the Canadian Government, which allows a grant to each individual for his support, amounting in all to about 200,000/ per annum. Alcohol is not permitted amongst them, and there is a very heavy penalty for bringing intoxicating liquors into the North-West Territories. Of the various tribes, Sioux, Crees, and Assiniboines are met on the eastern portions of the plains; the Blackfoot reserve is situated near the Blackfoot crossing on the Bow River, where an Indian supply farm has been established. The Sarsee reserve is near Calgary; and at Morley the Stonys have their reserve; the latter, however, migrate into the mountains early in the season, and spend the summer in hunting; and although game is now very scarce, they are better off in this respect than their brethren of the plains. From these they differ greatly in physique, being shorter and more thick-set. They are more tractable than many of the other tribes, and a mission has been for some time established among them at Morley.

The country of the plains does not appear to be wholly adapted for agricultural purposes; Manitoba and a great part of Assiniboia are very rich, producing magnificent crops of corn; but the most fertile belt appears to stretch away from Brandon towards Edmonton, the line of the railway traversing a less fertile district to the south. West of Moosejaw the agricultural prospects are indifferent, and in many cases very poor. About Calgary the season is short, but a good deal of cattle-ranching has been done, and the district is considered well suited for it, although two years ago about 75 per cent. of the imported cattle died; this mortality seems to have been the effect of bringing cattle from lower latitudes late in the season, as, on arriving, they were in such a poor condition that they were unable to bear the winter, which that year set in unusually early, and was particularly severe.

Further north, towards Edmonton, the climate is not considered to be so harsh as about Calgary; this is probably owing to the lower altitude of the mountains permitting the warm Pacific winds to be more beneficial.

Beyond Calgary the railway follows the valley of the Bow River through the district of the Foot Hills for a distance of about fifty miles, when it enters the Rocky Mountain by the Bow Pass at Padmore, or the Gap. Between Calgary and the mountains the character of the country is very different from the prairie districts: the surface is hilly, with patches of pine forest. The strata are more indurated and folded, being often highly inclined. Several well-marked river-terraces can be traced along

this valley, the uppermost extending far up the Bow Pass. In many districts on the plains the flies are so abundant as to interfere with surveying operations, alighting on the object-glasses in such numbers as to obscure the view. In all the houses the black flies literally cover everything. Earthworms do not occur in the north-west. To the botanist the plains are most attractive, there being an almost endless variety of grasses and pretty little flowers; many of our ordinary garden annuals growing wild over the plains.

To one who crosses the plains by the usual railroad route, the Rocky Mountains are first seen from near Crowfoot Creek, at the distance of about 150 miles. They appear as a serrated ridge on the south-western horizon, and numerous patches of snow can very soon be distinguished on them. The entrance to the Bow Pass, by which the mountains are entered, cannot be detected till one is close to the range. It is a comparatively broad winding valley, the direction of the bends being either south-west, across the strike of the strata, or north-west along that strike. The mountains rise precipitously on each side, but the valley itself presents a flat bottom, through which the river winds. This wide level plain, as a rule, is well timbered, the woods extending to a considerable altitude on the mountain sides; but forest fires have reduced the amount of available timber considerably. The trees are mostly either spruce or red fir, and, over the burnt areas, cotton-wood. Along the valley frequent large open un-timbered spaces, locally called "parks," bear good pasturage. The removal of the timber from their surface was evidently effected by recurrent fires.

The strata which compose the mountains are regularly disposed, striking north-west and south-east, and having a regular dip to the south-west, which at the outskirts of the range is moderate, but gradually increases till the beds are almost vertical about Castle Mountain. Westwards, in the main divide, they lie more flat. The chief rocks are crystalline magnesian limestones, with calcareous slate, and locally, peculiar siliceous rocks containing opal; amongst the upper beds of the series there are quartzites, grits, and conglomerates.

Near Cascade Mountain an outlier of coal of the same age as the beds on the plains, but much more indurated, rests unconformably on the older rocks, showing that in all probability these Secondary or Tertiary rocks formerly covered most of this Palaeozoic area. The older rocks which compose this part of the range are probably of Devonian or Carboniferous age; along the edge of the plains they are cut off by a large fault having a down-throw to the east, which brings the Cretaceous or Tertiary rocks into juxtaposition with them, while to the west they pass under newer strata. River terraces occur along the valley, and near Cascade Park there is a large accumulation of drift, apparently of glacial origin.

Many geologists will probably be disappointed in the Rocky Mountains of the Bow Pass section, for they hardly equal the familiar descriptions of the ranges further south. To the mineralogist, too, they promise but a poor field; the small amount of plication in the strata, and the absence of crystalline rocks, being unfavourable for the development of good mineral specimens. As to the industrial minerals, the resources of the valley have not yet been determined, but it appears that at least one metalliferous belt passes through the highly inclined rocks in the vicinity of Silver City: it bears copper pyrites and glance in veins running transversely to the general direction of the belt. Whether these veins are sufficiently rich, or whether there are large bunches of ore in the belt, has not yet been proved. Argentiferous galena is also known to occur in the grits and quartzites.

The climate of these mountains is very enjoyable in summer-time. During the day it is sometimes rather hot in the valleys, and the flies prove very troublesome, while at night there are often severe frosts. On the hills the

temperature is much more equable, there being usually a cool breeze during the day, and at night the air feels warm and balmy. The timber line here is about 6000 feet above sea-level, and although it is only the highest peaks that rise above the line of perpetual snow, yet there are large accumulations of snow on the northern slopes and in many of the valleys, extending some distance below the timber line. On warm days snow-slides may be constantly heard descending with a loud roar. Glacial lakes occur in several of the valleys and cooms.

Fish abound, but they are difficult to catch except in the small rivers and lakes, where, however, they are small.

To the botanist the mountains would probably prove even more attractive than the plains, as there is such variety in the flora according to the altitude. Above the present timber limit vegetation rapidly diminishes, only scattered individuals occurring at a distance above it, one of the most remarkable of these being the forget-me-not, bright blue patches of it not uncommonly occur right up alongside the snow banks.

GERRARD A. KINAHAN

#### NATIVE AMERICAN LITERATURE AND ETHNOLOGY<sup>1</sup>

OUR apology for grouping together so many valuable works on native American literature must be the extraordinary rapidity with which such productions are accumulating. Unless dealt with in this somewhat summary way, they run the risk of not being noticed at all. The great activity recently displayed in this department is largely due to the personal efforts of Dr. Brinton, whose spirited attempt to form a "Library of Aboriginal-American Literature" has already made some progress towards realisation. The first book on our list is practically a reply to those who may be sceptical as to the existence of sufficient materials to warrant such an enterprise. Based on a paper laid before the Congress of Americanists at Copenhagen last year, it takes a summary but comprehensive survey of all the still extant monuments of native literature in the various branches of history, legend, ritual, oratory, poetry, and the drama. In some of these branches the quantity of available matter is considerable. Hundreds of native tales and legends have been committed to writing by the Christian Eskimo of Greenland, and Dr. Heinrich Rink's manuscript collection of their historical traditions fills over two thousand pages. But the quantity of folk-lore and tribal myths floating about in the oral state amongst the Dakotahs, Athabascans, Algonquins, and other North American nations is alone sufficient to supply abundant materials for Dr. Brinton's undertaking. These, however, cannot be properly utilised until the natives have been educated and taught to write their own language, as, for instance, some of the Eskimo, Cherokees, and Iroquois have already learnt to do.

A brilliant result of such education is the "Iroquois Book of Rites," second on our list, which is now printed for the first time from native manuscripts recently brought to light by the editor, Mr. Horatio Hale. In the introduction a curious account is given of these manuscripts, of which there are three extant, two in the Canienga dialect procured at the Iroquois Reserve near Brantford, and one in the Onondaga dialect found at the Reservation near Syracuse, New York. The former are duplicate copies of the "Book of Rites" proper, and one of them appears to be traceable to an original, composed during the latter part of the last century, probably by the

<sup>1</sup> "Aboriginal American Authors." By Daniel G. Brinton, M.D. (Philadelphia, 1883.)

"The Iroquois Book of Rites." Edited by Horatio Hale, M.A. (Philadelphia, 1883.)

"The Gileghence: A Comedy Ballet in the Nahuatl-Spanish Dialect of Nicaragua." Edited by D. G. Brinton. (Philadelphia, 1883.)

"Sixteenth and Seventeenth Annual Reports of the Peabody Museum of American Archaeology and Ethnology." (Cambridge, 1884.)

Canienga Chief, David of Schoharie. The other, written by one "John Green," of the Mohawk Institute at Brantford, and dated November 1874, is based on an unknown text differing in some respects from that attributed to Chief David. The Onondaga is not a copy of the Canienga work, but its complement, comprising the speeches addressed by the younger to the elder nations when a chief of the latter is mourned, and hence named the "Book of the Younger Nations." All the original texts may possibly have been composed about the middle of the eighteenth century, by which time several of the natives had been sufficiently instructed by the English missionaries to read and write their mother tongue fluently.

Such is briefly the history of the "Book of Rites" in its written form, which consists mainly of the speeches, songs, formulas, and ceremonies performed at the meetings of the Great Council, or "Council of Condolence," of the Iroquois Confederacy, when it met for the combined purpose of mourning the death of a chief and celebrating the induction of his successor. The proceedings to be observed on this important occasion had evidently been handed down orally from the time of the formation of the famous League, or "Great Peace," an event usually referred to the middle of the fifteenth century. Much of the contents of the "Book of Rites" may therefore fairly claim to date from that period. But although the strictly ceremonial portions may have been written down in the very words in which they had been orally preserved for some three hundred years, the text as it now stands has obviously been coloured by the spirit of the eighteenth century, and is, so far, not a faithful reflection of the social ideas and inner life of the Iroquois nation in pre-European and pagan times." Such passages as "The Great League which you established has grown old"; "Hail, my grand-sires! You have said that sad will be the fate of those who come in the latter times"; "ye are in your graves who established it [the League]. Ye have taken it with you and have placed it under you, and there is nothing left but a desert," were written by men who felt that the Confederacy was already a thing of the past. The whole tone of the work is in fact pervaded by a spirit of sadness and despondency, and its very scope seems to have been the preservation of the empty forms and ceremonials of an institution whose days were already numbered. This point should be borne in mind in reading the comments of the editor on the present text, and especially the arguments drawn from it in favour of the superiority of the Iroquois race over "the Aryans of Europe" in humanity, public spirit, and political sagacity. The curious theory is even advanced that the fine qualities of the European Aryan, as compared with his barbarous Asiatic kindred, "may have been derived from admixture with an earlier population of Europe, identical in race and character with the aborigines of America" (Introduction, p. 98). And in an unfortunate appendix, where this idea is worked out at some length, it is suggested that the time is approaching when the "servile Aryans will cease to attract the undue admiration which they have received for qualities not their own; and we shall look with a new interest on the remnant of the Indian race, as possibly representing this noble type of man, whose inextinguishable love of freedom has evoked the idea of political rights and has created those institutions of regulated self-government by which genuine civilisation and progress are assured to the world" (p. 190).

Mr. Hale is more instructive in the section of his erudite introduction devoted to the genius and inner structure of the Iroquois language. Here he shows, against the general conclusions of philologists, that Iroquois really abounds in true abstract terms. Such are *olariténsera* = heat, *atariatitsera* = courage, *kanaitsera* = pride, *kanakwenstéra* = anger, regularly derived by the affix *sera* from verbal forms. He also makes it clear that true gram-

matical gender exists, forming, as in the Semitic system and in some neo-Sanskritic idioms, a distinctive feature of verbal conjugation. But its use is entirely restricted to the third person singular, dual and plural, as in *walkah-tos* = she sees, *kiakah-tos* = they two see (fem.), *kont-kah-tos* = they see (fem.). This point is of great importance as affecting the various psychological systems of linguistic classification that have been proposed by certain German theorists. It may be incidentally remarked that in Africa also the distinction between gender (Hamitic) and non-gender (Negro) languages no longer holds good; for it now appears that gender is also characteristic of the Masai, and of many Nilotic negro tongues.

Dealing with the tendency of Iroquois and so many other American languages to fuse the terms of the sentence into a single compound word, Mr. Hale observes: "The notion that the existence of these comprehensive words in an Indian language is an evidence of deficiency in analytic power, is a fallacy long ago exposed by . . . Duponceau. As he has well explained, analysis must precede synthesis. In fact, the power of what may be termed analytic synthesis—the mental power which first resolves words or things into their elements and then puts them together in new forms—is a creative or co-ordinative force indicative of a higher natural capacity than the act of mere analysis. The genius which framed the word 'tskenonhwerronne,' ['I come hither again to greet and thank'] is the same that, working with other elements, produced the steam-engine and the telephone" (p. 150). Here again it is to be feared that bias has got the better of reason. Certainly the world would have had to wait very long indeed for the steam-engine and the telephone had their invention depended on the natural evolution of the people who "framed the word" in question. Prof. Sayce ("Science of Language") has also made it tolerably evident that analysis does not precede synthesis, and that the unit or starting-point of speech is rather the sentence than the word. Hence the American polysynthetic is an infantile compared with the English analytical process in the example appealed to. But, apart from these eccentric views, it is a great pleasure to be able to say that Mr. Hale has given us an admirable edition of the "Book of Rites"—a priceless treasure opportunely rescued by him from the imminent danger of destruction.

An equal share of praise is due to Dr. Brinton as editor of the "Güeguence," which forms the third volume of his Library Series. This curious document presents considerable interest, both from the ethnological, philological, and literary points of view. An original native drama in the strict sense it can hardly be called. But although dating no further back than the last century, and composed in a strange medley of bad Spanish and Nahuatl (Aztec), it may be regarded as almost the last surviving specimen of the aboriginal semi-dramatic compositions which appear to have been in common use amongst the Central American peoples long before and after the Conquest. Such compositions, prepared for oral recitation at the public feasts and ceremonies, were so far dramatical that they took the form of dialogue, and turned on some simple incident with a happy *dénouement*. In the present instance the Güeguence, that is, the elder or village headman (from the Aztec "*huchucutzé*" = "dear old man"), is brought with his two sons before the provincial governor, charged with entering the province without a permit. This leads to a good deal of repartee, some broad jokes, and intentional misunderstandings on the part of the hero, who in the end comes off best and manages to bring about a marriage between one of his sons and the governor's daughter. The language of the piece is very peculiar, and will doubtless be appealed to by the advocates of mixed forms of speech in favour of their views. Yet a careful study of the text shows that here the Spanish and Aztec elements are not harmoniously fused, as are, for instance, the Saxon and Latin elements in

English. Thus we have sometimes two or three tolerably correct consecutive Spanish sentences with due observance of its grammatical forms, as, for instance, Pues, tome! Uno, dos, tres, quatro. Ha! mi plata, muchachos! Cuatro cientos y tantos pesos le he dado á mi amigo Cap<sup>n</sup> Alguacil. But beyond abrupt exclamations such as "*Mascamayagna, Güegüence*" = "at your service, Güegüence," complete grammatical Aztec sentences never occur, and the composition may on the whole be regarded as essentially Spanish copiously interlarded with native words and phrases. Hence it is rather a medley than a true *lingua franca*, or a jargon, such as "Pigeon-English," and the Chinook of the Columbia river, which involve a total destruction of the relational forms of all the constituent elements, thus preparing the way for a fresh grammatical departure. Thus only is it conceivable that true mixed languages can be developed, and the conditions favourable for such combinations are necessarily so exceptional that they must in any case always remain the rarest of linguistic phenomena.

Little space is left to speak of the last "Reports of the Peabody Museum," which are more than usually rich in original ethnological materials. Conspicuous amongst these are the graphic descriptions at first hand of the "White Buffalo Festival of the Unepapas," the "Elk Mystery or Festival of the Ogallala Sioux," the "Religious Ceremony of the Four Winds as observed by the Santee Sioux," the "Shadow or Ghost Lodge: a Ceremony of the Ogallala Sioux," and the "Wa Wan or Pipe Dance of the Omahas," all by Miss Alice C. Fletcher, who has recently been spending some profitable time in the midst of these North American tribes. By taking up her residence amongst them, sharing in their domestic joys and sorrows, making herself one of them, this enterprising and benevolent lady has enjoyed rare opportunities of penetrating into the inner life of the aborigines. Hence the great value of her remarks, especially on their religious views, a correct appreciation of which can only be had in this way. On the vexed subject of nature-worship and animism some current misconceptions are combated and fresh light thrown on the attitude of the native mind towards the outward and invisible world. "Careful inquiry and observation," she writes, "fail to show that the Indian actually worships the objects which are set up or mentioned by him in his ceremonies. The earth, the four winds, the sun, moon, and stars, the stones, the water, the various animals, are all exponents of a mysterious life and power encompassing the Indian, and filling him with vague apprehension and desire to propitiate and induce to friendly relations. This is attempted not so much through the ideas of sacrifice as through more or less ceremonial appeals. More faith is put in ritual and a careful observance of forms than in any act of self-denial in its moral sense as we understand it. . . . To the Indian mind the life of the universe has not been analysed, classified, and a great synthesis formed of the parts. To him the varied forms are all equally important and noble. A devout old Indian said: "The tree is like a human being, for it has life and grows; so we pray to it and put our offerings on it that the god may help us." Here we have placed in a vivid light the very essence of Anthropomorphism—ultimate base and starting-point of all primitive religions.

In the Curator's Report reference is made to the imprints of human feet discovered by Dr. Flint on December 24, 1883, in the volcanic rock some fourteen feet below the surface soil in Nicaragua. The tracks are in several series running nearly parallel with the banks of Lake Managua, within 300 feet of the present margin. Above the prints is a bed of clay and volcanic material containing fossil leaves, and over this four distinct beds of more recent volcanic matter. Blocks of rock containing the prints have been cut away and forwarded to the Museum. "That they were made by the feet of men

while the material of which the rock is formed was in a plastic condition there is not the least doubt. The imprints are from nine to ten inches long and about four wide across the ball of the foot . . . with heel-ball and toes perfectly distinct. Dr. Flint states that the stride was only from eleven to eighteen inches, which indicates slow walking over the plastic substance." It is hoped that a clue to the geological age of the deposit may be obtained from the fossil leaves, a report on which is expected from Prof. Lesquereux. A. H. KEANE

### NOTES

THE International Conference on Education was opened at the Health Exhibition on Monday by the address of Lord Carlisle, and has been continued during the week. There is a very large attendance both of English and foreign educationists, while the papers and discussions have been of much interest and importance. We hope to speak in detail of the Conference in our next number.

THE summer meeting of the Institution of Mechanical Engineers began at Cardiff on Tuesday with the address of the president, I. Lowthian Bell, F.R.S. The papers to be read are all of a technical nature. The meeting will be continued during the week, and many excursions have been organised, and visits to engineering and other works.

THE French Association for the Advancement of Science will hold its next meeting at Blois from September 4 to 11 next. The lecturers and subjects of lectures have not yet been decided upon.

DR. SCHWEINFURTH will return to Africa in a few weeks, on a commission from the Berlin Academy of Sciences; but the field of his exploratory labours has not yet been finally selected.

THE Government having decided to appoint a Royal Commission for the Exhibition of India and the Colonies, which is to be held in London in 1886, the Prince of Wales has issued a certain number of invitations to those persons whom it is desired should serve on this Commission.

THE death is announced of Mr. Charles Manby, F.R.S., M.Inst.C.E., for forty-five years identified with the Institution of Civil Engineers, for seventeen as the paid secretary, and for twenty-eight years as the honorary secretary. He was born on February 4, 1804, and was the eldest son of Aaron Manby, the founder of the Horseley Iron Works in Staffordshire, and later of the Paris Gas Works, and of ironworks at Charenton, near Paris, and who re-organised the now famous ironworks at Creuzot. For his father he was also engaged on the design and construction of the first pair of marine engines with oscillating cylinders, upon the building of the *Aaron Manby*, the first iron steamship that ever made a sea voyage, and upon the several works in France before enumerated. In 1839 he was appointed secretary of the Institution of Civil Engineers, and soon afterwards threw himself, heart and soul, into a movement which revolutionised the Society. As evidence of the appreciation in which he was held it may be mentioned that when, in 1856, he relinquished the position—which has since been filled by his pupil, James Forrest—he was presented with a service of plate and a sum of two thousand guineas, "as a token of personal esteem, and in recognition of the valuable services he had rendered to the members individually and collectively." Again, in 1876, Charles Manby received from the members of the Institute of Civil Engineers a silver salver and a purse of upwards of 4000*l.* "in friendly remembrance of many years valuable services."

ON Monday, August 4, taking advantage of Bank Holiday, the Essex Field Club held a meeting at Colchester. The party,



about fifty or sixty in number, were met at the station by Mr. J. Horace Round, who conducted them through the older parts of the town to the Castle, the history of which was lucidly sketched and the main points of interest shown by Mr. Round. A hurried visit to the Castle Museum, with its splendid collection of local antiquities and natural history objects, was next made under the guidance of the Rev. C. L. Acland and Mr. Round. The party then proceeding to lunch at the Cups Hotel. After lunch, a drive of about eight miles along the Mersea Road, passing through the villages of Abberton and Peldon, the scenes of the earthquake of April 22, brought the party to West Mersea, where Mr. H. Lauer addressed them upon the history of this and the surrounding districts during Roman times, suggesting that the Roman town of Othona may have been situated on the opposite shore of the River Blackwater in the neighbourhood of Bradwell. Mr. Lauer next called attention to the interesting and mysterious "salting-mounds" or "red hills," which occur also on the Norfolk coast and along the rivers in Suffolk and Kent, and of which eighteen still exist between Strood and Virley in Essex. These, according to Mr. H. Stopes, F.G.S., often cover as much as 10 to 30 acres, and are from 2 to 44 feet deep, being composed of red burnt clay mixed with rude broken pottery, charcoal, ashes, and often bones. A ramble eastward along the coast of Mersea Island brought the party to the "decoy" for the capture of wild-fowl, the working of which in former times was explained by Mr. Lauer. Here Mr. J. C. Shenstone gave a short demonstration of the interesting coast flora. Driving homewards the party stopped at the ruins of Langenhoe Church, wrecked by the earthquake, where Mr. R. Meldola gave a short statement on this subject in anticipation of the detailed report which he proposes to present to the Club. He stated that the area of structural damage covered about fifty square miles. After tea an ordinary meeting was held, Mr. R. Meldola in the chair, and the evening concluded with a *conversazione* at the Hotel, collections of insects, dried plants, and living insectivorous plants being exhibited by Mr. W. H. Harwood, Mr. Shenstone, and Dr. Alexander Wallace. The Mayor and many of the townspeople were present during the evening to listen to the short addresses on natural history subjects given in explanation of the various exhibits.

THE repeated failures of steamers to reach Siberia from Europe do not seem to have deterred M. Sibiriakoff, the well-known Russian merchant, from again despatching two steamers this year. Early last month the steamers *Nordenskjöld* and *Obi* left Tromsø (Norway) to attempt, it is stated, for the last time to reach Siberia. When in lat. 70° 55' N. and long. 52° 15' E. the engines of the *Nordenskjöld* broke down, and she was with great difficulty towed back to Vardø.

A SUBSCRIPTION has been opened at St. Petersburg, in order to raise the money for instituting at the University five bursaries in the name of Charles Darwin, to be employed for the maintenance of five students in the five chief branches of natural science.

THE Russian review, *Russkaya Starina*, and the *Jou nal* of the Russian Chemical and Physical Society have lately devoted some attention to the first steam-engine that was made in the Russian Empire, in 1763, at the ironworks of Barnaoul, in Western Siberia, by a mining engineer, Polzunoff. It appears from M. Woyekoff's description of this steam-engine, the model of which exists still at Barnaoul (both reviews have figured it on plates), that Polzunoff's engine was a reproduction of the "fire-engine" of Newcomen, with some original improvements. Thus it has two cylinders, instead of one, and, instead of the beam, Polzunoff made use of a wheel which received the chains of the pistons, and transmitted the circular movement, transformed again into a rectilinear one, to a pair of bellows, used for

blowing air into a high furnace. The distribution of vapour was automatic, as in Newcomen's engine, but with several improvements. The engine, which had cylinders 9 feet long and 9 inches in diameter, worked during two months from May 20, 1766, and 3100 cwts. of silver ore, yielding 5 cwts. of silver, were melted with its help. But Polzunoff did not see his engine at work, as he died from consumption four days before. He obviously was a remarkable man for his time, several of the physical remarks he made in the description of his engine showing not only a wide knowledge, but also a serious spirit of true physical reasoning, together with a notable skill for determining the limits of knowledge of that time. In his theoretical remarks about "Air, Water, and Vapour," he notices also that physicists are not yet agreed as to the origin of heat, some of them seeing in it a much-divided, fine moving matter, while others "see the origin of heat in friction and in the vibratory motion of the particles inaccessible to our senses, of which the bodies are constituted." He obviously quotes here the words of Lomonosoff, who stated in these very words the mechanical origin of heat in his most remarkable but unhappily little-known memoir, written as an instruction to Tchichagoff's Polar Expedition.

SEVERAL severe shocks of earthquake were felt on Sunday afternoon at Foca, in Bosnia. The duration of each shock was over two seconds.

A BROCHURE just issued by M. Ch. Montigny at Brussels contains in convenient form the result of his studies on the state of the atmosphere as affecting stellar scintillation, with a view to forecasting the state of the weather. From the fact determined by W. Spring, that the colour of pure water in great bulk is blue, he explains the predominance of this colour in the scintillation of the stars just before and during wet weather. The luminous rays, he argues, traversing the air charged with large quantities of pure water are necessarily tinged with the blue colour of this medium. The excess of blue thus becomes an almost certain means of predicting rain. This theoretic conclusion corresponds with the results of his observations continued for several years past on the appearance of the stellar rays in connection with the state of the weather. During the few months of fine weather in the present year blue has been much less conspicuous than in the corresponding months of previous years since 1876, when wet weather prevailed. It also appears that green, which had always coincided with clear skies during the fine years before 1876, has recently again become predominant. Hence he thinks it probable that we have got over the cycle of bad seasons, and that dry weather and more normal summers may be anticipated at least for some time to come.

PROF. F. NEESEN publishes a reprint of his paper in the *Archiv für Artillerie- und Ingenieur-Officiere* for 1884 on a generalisation of Sebert's method of registering the velocity of shot within the tube of a gun. Sebert's apparatus necessarily registers for a space somewhat shorter than the diameter of the ball. This defect is remedied and the registration extended to the whole length of the tube by means of a revolving appliance to which the registering tuning-fork is attached, and disposed parallel with the periphery of the cross-section of the shot. Pencils fastened to the prongs of the tuning-fork and vibrating with it are thus made to describe curves indicating the velocity of the ball in its course through the tube. The only objection to the process, which is made perfectly clear by several accompanying illustrations, is that by the concussion the registering apparatus may get deranged or jammed with the shot. This danger it is proposed to obviate by making the apparatus of the best steel, and diminishing the effect of the concussion by filling the shot with some fluid when fired for experimental purposes.

IN the last number of the *Bollettino* of the Italian Geographical Society, Dr. G. A. Colini continues his valuable

paper, already noticed in NATURE, on the Indians of the Upper Amazon regions. Much original and curious information is supplied regarding the Caribos, Shipivos, Amahuacs, Campas, Shetevos, and many other Christian and Pagan tribes, especially of the Ucayali and Huallaga basins. Thus we are told that most of the Christian women in the Ucayali villages don a European smock to attend mass, but after the service lay it aside for the native *pampanilla*, a scanty garment, white at first, but afterwards dyed blue or red with geometrical designs to save the trouble of washing it. Here also the men carefully pluck out the beard with pincers made of two shells, because the women consider this appendage as a sign of old age. Hence bearded youths are regarded as superannuated, while clean-faced old men are still eligible in the matrimonial market. The South American Indians are usually described as altogether beardless, an inference due probably to this custom, which appears to be very general.

THE principal articles in the current number of *Petermann's Mittheilungen* are on Arctic subjects. Prof. Mohn of the Norwegian Meteorological Institute writes on the hydrography of the Siberian Arctic from the observations of the *Vega*, while Lieut. Hovgaard, a member of the expedition, contributes a paper on the ice in the Kara Sea, and M. Lauriasen of Copenhagen on the point reached by Behring in his first expedition. In addition to these we have papers on the names of places in the Niger region, on the new map of Germany prepared by the general staff, and the usual notes.

THE plague of rabbits in our Australasian colonies is one of which much has been heard, and it appears that another European animal, the dog, is about to follow the example of the rabbit, and make himself a pest in place of a pet. It appears that the number of wild or semi-wild dogs has recently increased largely in Victoria and New South Wales, and the consequence is a great slaughter of sheep by these nomads. The Government has already offered rewards for their destruction. In New Zealand some enterprising people have hit on the idea of importing weasels and stoats from England to keep down the rabbits; but if the former increase in their new habitat as rapidly as the latter have done, the last state of New Zealand will be worse than the first, for a plague of rabbits must be as nothing compared to a plague of weasels, and a great increase of the latter, from their predatory and destructive habits, must be followed by a considerable alteration in the distribution of the fauna of New Zealand. In Jamaica, according to the last report of the Director of Public Gardens in that colony, the planters suffered greatly from the depredations of rats among the sugar-canes. The rat-eaten canes were good for nothing except rum, and accordingly large sums were spent in poison and dogs to keep down the rats, but apparently without much success. At last an enterprising planter determined to import the mongoose from India to destroy the rats on his sugar estate. The sugar-planters, Mr. Morris says, have unquestionably benefited greatly by its introduction, and rat-eaten canes are now hardly known where formerly they were found in large quantities. But the new importation continues to multiply and spread, not only on sugar estates, but on the highest mountains, as well as along shore, even amidst swamps and lagoons; and when the sugar-cane rat is wholly exterminated, the mongoose will still go on increasing, and what then? Must the colonists find something else to exterminate the mongoose, and save their poultry, and so on *ad infinitum*? As it is, negro settlers and persons not connected with sugar estates complain of its ravages amongst their poultry and even accuse it of destroying fruit and vegetables; and, although Mr. Morris doubts whether these complaints are all well founded, he acknowledges that the mongoose is the cause of great disturbance in the animal life of Jamaica. Harm-

less yellow and other snakes, lizards, ground-hatching birds, rabbits, and many members of the indigenous fauna of the island are likely to become extinct at no distant date. It will be interesting to watch the effect of the introduction of the mongoose, and we hope Mr. Morris will enlighten us from year to year on the subject.

At the last meeting of the Asiatic Society of Japan (as reported in the *Japan Weekly Mail*) a paper was read by Dr. Whitney on "Medical Progress in Japan." The first era in Japanese medicine was the mythological age, when the treatment of disease appears to have consisted in the use of charms and the employment of the simplest remedies originated by the "Great-name-possessing Deity"; the next period covers nearly 900 years from the middle of the second century B.C., during which Corean and Chinese medicine was introduced, as well as Buddhism and the useful arts. At the close of the eighth century the University and a medical school were established, and here commences the third period in the history of Japanese medical progress, which lasts down to the middle of the sixteenth century. In the medical college of those days the students pursued a seven years' course, and appear to have received a thorough and systematic training in Chinese medicine, which, as then taught, was embodied in works consisting chiefly in numerous dissertations and philosophical deductions based upon incorrect notions as to the anatomy of the human frame and the relation of its various viscera with one another and with the different phenomena of nature. In the fourth period, from the middle of the sixteenth century, when the Portuguese first appeared in Japan, down to the restoration of 1867, occurred the revival of both the Japanese and Chinese schools, and the introduction of Western medicine, which appears to have played no unimportant part in the temporary success of the missionaries. They received at one time a grant of 7500 acres of public lands for the purpose of cultivating medicinal plants. In 1775 was published the translation into Japanese of a Dutch work on anatomy, which was the first of its kind published in Japanese. Vaccination was introduced in 1824 from Russia by some Japanese fishermen, and in 1858 a medical school was founded in Nayasaki, in which Western medicine only was taught. With the effects of the revolution of 1868 on medicine, as on most other things in Japan, most people are familiar. The physicians and surgeons of new Japan are required to go through a three years' course of study, and to pass examinations in the manner familiar in Europe. Apothecaries, dentists, and midwives must similarly be provided with diplomas, which can only be obtained after satisfactory examination. Contagious diseases acts, the examination of drugs, a strict control of the sale of opium for medicinal purposes, and the numerous other measures by which governments seek to protect the public health, are now found in full working order in Japan.

DR. R. LENZ describes, in the last *Bulletin* of the St. Petersburg Academy of Sciences, a new application of the telephone to the measurement of temperatures at a distance. Let us imagine two stations, A and B, connected together by an iron and an argentan wire, which are looped together at both stations. If the looping at A has a different temperature to that of B, a thermal current will circulate through the wires; and if a silent interrupter and a telephone be introduced into the system, the telephone will emit a sound, which will cease immediately the observer at B has raised or lowered the temperature of his looping place, so as to render it equal to that of A, and to destroy thus the thermal current. The exactness of this method depends on the exactness of determination of the moment when the lull ceases in the telephone, which moment is influenced by a remnant of lull in the instrument after the equalisation of temperature at both ends of the apparatus. In a series of experiments where the points A and B were one metre distant, Dr. Lenz

determined temperatures by this method with great accuracy, the errors being only from  $0^{\circ}01$  to  $0^{\circ}17$ ; and he concludes that, by using iron-argentan wires two millimetres thick, the measurements could be made at a distance of five kilometres, which distance could be still increased, say to twenty-five kilometres, if antimony and bismuth wires were used.

THE last number (12) of the *Journal* of the Straits Branch of the Royal Asiatic Society has the continuation of a paper on Malayan Ornithology, by Capt. Kelham, and an official report by Mr. L. Wray, of Perak, on gutta-producing trees. Mr. Maxwell writes on "Shamanism in Perak," the term in this instance being applied to the incantations and ceremonies employed by the Malays to cure the sick. But surely Shamanism in its home in Thibet is something more than this. Mr. Ferguson contributes some notes on the curious changes which consonants undergo in passing from one Malay dialect to another. The papers, properly so called, conclude with a report on the Meteorology of the Straits. In the Annual Report of the Council of the Society we notice that it is intended to republish in a collected form valuable papers published in the Eastern Archipelago at one time or another, but now either out of print or difficult of access; also a text-book of the geography of the region, under the editorship of members of the Society, and a skeleton map of the Malay Peninsula, on a scale of a quarter of an inch to a mile, upon which all new information will be entered from time to time as exploration advances.

SEVERAL honorary promotions have been recently made by the French Government for scientific services. Dr. Cornelius Herz, director of *La Lumière Electrique*, has been nominated Commander in the Legion d'Honneur at the request of M. Cochery, Minister of Postal Telegraphy, for his works on Electricity. The Minister of Public Instruction has appointed Madame Camille Flammarion an officer of the Academy for having acted as a secretary to her husband in all his work in connection with astronomy. The Municipal Council of Paris has decided that one of the new streets of the Thirteenth Arrondissement shall be named Giffard, in commemoration of the inventor of the injector.

AN experiment has been made in Vienna which proves that even with incandescent lights special precautions must be taken to avoid any risk of fire. A lamp having been enveloped with paper and lighted by a current, the heat generated was sufficient to set fire to the paper, which burnt out and caused the lamp to explode.

ON July 27 there was celebrated at the Trocadéro Palace the centenary of the death of Diderot, the celebrated French philosopher, who was also a man of science in his time and editor of the famous *Encyclopædia*.

THE additions to the Zoological Society's Gardens during the past week include a Rhesus Monkey (*Macacus rhesus* ♀) from India, presented by Miss A. E. Sturge; a Bonnet Monkey (*Macacus sinicus* ♂) from India, presented by the Rev. T. Rickards; a Common Fox (*Canis vulpes*), British, presented by Mr. Thomas Legg; a King Vulture (*Gypagus papa*) from South America, presented by Mr. August Strunz; two Red-tailed Buzzards (*Buteo borealis*) from Jamaica, presented by Mr. D. Morris; a Martinique Waterhen (*Jouanornis martinicus*), captured at sea, presented by Mr. A. Jones; two Jackdaws (*Corvus monedula*), British, presented by Mrs. Frank; a Kestrel (*Tinnunculus alaudarius*), British, presented by Mr. G. Westrup; a Crested Curassow (*Cras alector*), an Anaconda (*Eunectes murinus*) from British Guiana, presented by Mr. G. H. Hawtayne, C.M.Z.S.; a Grey Amphibæna (*Bianus cinereus*) from Portugal, presented by Mr. W. C. Tait, C.M.Z.S.; a Golden-crowned Conure (*Conurus aureus*) from South-East Brazil, deposited; a Black

Hornbill (*Sphagolobus atratus*) from West Africa, purchased; a three-quarter bred Mesopotamian Deer (between *Dama mesopotamica* ♂ and hybrid *Dama vulgaris*), born in the Gardens. ¶ 7]

### OUR ASTRONOMICAL COLUMN

THE NEW COMET.—A circular issued from Dun Echt on July 31, contains the following approximate elements of the comet discovered by Mr. Barnard on July 16, calculated by Mr. S. C. Chandler of Harvard College Observatory:—

Perihelion passage, 1884, August 17<sup>h</sup> 6<sup>m</sup> 3 G.M.T.

Longitude of perihelion ... ..	302 4
"    ascending node ... ..	357 52
Inclination ... ..	7 2
Logarithm of perihelion distance ... ..	0.14780
Motion—direct.	

The comet will probably be observable in this country after perihelion passage, as will appear from the subjoined positions resulting from Mr. Chandler's orbit:—

12h. G.M.T.	R.A.	N.P.D.	Distance from Earth	Intensity of Light
September 3 ...	18 27.2 ...	123 8 ...	0.682 ...	1.06
"    7 ...	18 44.2 ...	122 6 ...	0.701 ...	0.98
"    11 ...	19 0.2 ...	120 58 ...	0.722 ...	0.91
"    15 ...	19 15.9 ...	119 46 ...	0.747 ...	0.83

At discovery on July 16 its distance from the earth was 0.627, and that from the sun 1.480, consequently the intensity of light was 1.16.

The supposition that this comet had been observed at Melbourne, Madras, and the Cape, arose from a mistake in telegraphing. M. Trepied (Algiers) calls it "nébulosité sans queue; condensation centrale."

PERIODICAL COMETS IN 1885.—During next year three comets of short period will return to perihelion. Encke's comet is due in March, probably in the first or second week, according to the elements of 1881. The next is Tempel's comet, 1867 II., in the case of which it is not possible to assign the time of perihelion passage without the calculation of the perturbations due to the attraction of Jupiter, near which planet the comet was situated during the last half of the year 1881; the least distance of the two bodies having been about 0.57 in October. The third comet referred to is Tuttle's, last observed in 1871, the perihelion passage probably in September or October.

A VARIABLE-STAR IN AQUARIUS.—Attention has been already directed in this column to a star, the position of which for 1884.0 is in R.A. 22h. 29m. 48s., N.P.D. 98° 12' 4", on the score of variability from the ninth magnitude to invisibility, or at least to below the twelfth magnitude. Mr. Knott has just made an observation which confirms the variation of the star, as notified by Mr. Hind some thirty years since. On August 11, by the method of gauging, Mr. Knott found its magnitude 11.7. It was 9m. according to the Markree Zones on October 27, 1848, and on four occasions was estimated 9.5 at Bonn. It was considered a ninth magnitude, probably in August 1855, at the late Mr. Bishop's observatory. Generally it seems to have been about 11.5m. There is some reason for supposing that it does not continue very long at maximum. Argelander was inclined to think that there was a mistake as to the variability of this star, but the evidence in favour of it appears now to be too strong to be thus set aside. It has not been included in Schönfeld's catalogues of known or suspected variables.

PTOLEMY'S 30TH OF CENTAURUS.—In Süfi's "Description of the Stars," according to Schjellerup, we read: "Ptolemy has reported that there are in this constellation (Centaurus) thirty-seven stars, but in reality there are only thirty-six, the thirtieth is wanting." The star is No. 964 of Baily's edition of Ptolemy's Catalogue, and is rated  $\gamma$ , the twenty-ninth star immediately preceding ( $\epsilon$  Centauri) being called  $\beta$ . From Ptolemy's longitudes and latitudes we find that the thirtieth star followed the twenty-ninth  $0^{\circ} 34'$  in R.A. and  $1^{\circ} 10'$  to the south of it. Q Centauri follows  $\epsilon$  26'.5, and is south  $1^{\circ} 57.7'$ ; it is estimated 5.7 m. in Gould's *Uranometria*, but is a double-star, the components  $6\frac{1}{2}$  and  $7\frac{1}{2}$ . Notwithstanding the difference in brightness, the approximate agreement of positions seems to point to Q Centauri as Ptolemy's thirtieth star.

OBSERVATIONS ON A GREEN SUN, AND ASSOCIATED PHENOMENA<sup>1</sup>

THE rarity of the phenomenon of a green or blue sun makes it desirable to record with the greatest accuracy and detail the observations made during its appearance in India during several days of September 1883.

The notes taken at Madras at the time of the appearance will best illustrate the general features of the phenomena:—

On September 9, the sun, before setting, assumed a peculiar silvery appearance, and its brightness was so much decreased that for about half an hour before sunset it could be observed with the naked eye. This was observed, I believe, though to a less extent, on the two days preceding, but I did not myself see it on these days. On September 10, from 5 to 5.30 p.m., the sun could easily be looked at with the naked eye, yet the limbs were sharply defined. At 5.30 the sun entered a low bank of clouds, and did not fully appear again; but a narrow strip seen through a rift in the cloud at 5.43 was coloured a bright pea-green. Round Madras this colour had been seen in the morning, but in Madras itself clouds concealed the sun till it had risen to a considerable altitude. Of the morning of the 11th I have no record, but in the evening the green colour was brilliant, and was visible for more than half an hour, being preceded, as on the former night, by the silvery white appearance of the sun's disk. On this evening a large sunspot about 1' long was so conspicuous an object that it attracted the attention of even the most casual observers.

September 12.—At 12.35 a.m. the moon, which was near the horizon, appeared a pale green. Bright stars near the horizon showed the same tint. From 5.15 to 5.30 the clouds to the east were coloured reddish brown. At 5.55 the sun rose with a yellowish green colour, but was almost instantly lost in clouds. It reappeared at 6.4, and was then of a bright green colour; this colour rapidly got fainter, but was quite perceptible till 7 o'clock. In the afternoon the phenomena of the previous nights were repeated, and the horizon being free from clouds, the actual sunset was observed. The entry in my notes is: "6.3.—The sun set as a greenish yellow ball; cumulus, stratus, and nimbus clouds near the horizon, but moon fairly clear; some blue sky, but hazy." The change from green to greenish yellow was evidently due to the great increase in the strength of the low-sun-band close to the horizon, which left the strip of yellow between that band and the rain-band by far the most prominent feature in the spectrum.

September 13.—In the early morning there was a good deal of distant lightning. The sun rose of a bright, golden yellow colour; no green was seen. In the afternoon there were slight showers.

A most remarkable observation made this morning by Mr. Pogson seems very difficult to explain, except by some form of auroral display. I give his notes in full:—

"1883, September 12, 17h. om. Madras mean time.—The sky a most remarkably intense reddish yellow, unusually bright. A dark cloud-bank from about east to south, and the vivid light above uncommonly auroral in appearance, more so than anything I have seen here before.

"At 17h. 10m. the red hue considerably diminished, and bright orange yellow the prevailing tint. The light quite bright enough to make notes by.

"At 17h. 20m. the dark blue-black stratum, now from about north to east, and very near the horizon. Sky tolerably clear to about 20° altitude, but of a rich red tint, with bright yellow clouds above, beginning at about 30°, and covering the rest of the sky.

"At 17h. 30m. all changed within the last four or five minutes, and writing now difficult without a lamp; a thick dark red stratum over the sunrise point, and everywhere else a very greenish yellow.

"At 17h. 40m. the low cloud stratum now sea-green. Light only enough to write by with difficulty.

"At 17h. 50m., sun rising a bright yellowish white, and otherwise nothing extraordinary, all unusual tints having disappeared with the sunrise."

September 14.—Before sunrise the clouds were blue and gray, with patches of red clouds of all sorts—cirrus, nimbus, stratus, cumulus, and mares' tails. Two bright flashes of lightning about 5.30 a.m. In the evening there was a slight green tinge, and

<sup>1</sup> Abstract of a paper read before the Royal Society of Edinburgh, July 7, 9y Prof. C. Michie Smith.

after sunset the sky was golden red till 6.50, while Mercury, seen through the red haze, was twinkling strongly.

September 15.—The sun rose golden. In the evening the sunset was very fine: in the west the colour was golden to orange-yellow, in the east it was greenish; red clouds remained till 7.5. There were very brilliant red "rayons de crépuscule."

From September 15 to September 20 the sunrises and sunsets were very fine, with red and gold, for more than half an hour before sunrise and after sunset.

September 21.—Sunset normal.

September 22.—The sun rose as a yellow ball, and showed distinct greenish yellow afterwards. From ten minutes before till sunset the sun was greenish yellow, but the sun was much brighter than on the 10th and 11th.

September 23.—The sun rose very green. At 5.37 p.m. the sun appeared from under clouds, very green; strong absorption in the red end of the spectrum to C; low-sun-bands weak. 5.45.—Clouds grayish purple. There was only one bank of clouds which was near the horizon; above this was a peculiar grayish haze. At 6 the clouds were of a marked purple colour; breaks near the horizon were reddish brown. During the night there was a great deal of sheet-lightning in the south.

September 24.—The sun rose bright yellow. The spectrum showed complete absorption up to B; the rain-band  $\alpha$  and  $\beta$  were very thick, and the low-sun-bands less marked than usual. There was lightning all night, beginning in the south, and working round to the south-east. It consisted chiefly of sheet-lightning, with occasional zig-zag flashes, but no thunder; the stars were fairly clear except near the horizon. Saturn and the moon, when near the horizon, were both very dim.

September 25.—Sunrise golden green. In the afternoon the shadows cast on white paper were still quite pink, but the sunset was bright yellow.

September 26.—Much the same as yesterday.

September 27.—Before sunrise C,  $\beta$ ,  $\alpha$ , the rain-band and the dry-air-band were very strong, but the dry-air-band was less than half as dark as the rain-band. The sun rose golden red. The spectrum showed signs of clearing up; glimpses of A could be obtained. After dark there was very bright lightning in the west.

September 28.—Spectrum still showed great absorption. Lightning at night.

September 29.—Spectrum absorption still very strong. After dark there was a display of luminous clouds specially towards the east. After 11 p.m. there was very heavy rain with much lightning and some thunder.

September 30.—Sunrise golden. The spectrum on the sun showed A clearly, a was very thick.

October 2.—In the morning from about 7 to 9 there was a thunderstorm, in which the thunder was almost continuous for about an hour and a half, but although the storm was almost vertically overhead, hardly any lightning was visible. . . . The total rainfall for the day was 4.88 inches.

Accounts were collected from trustworthy observers in various parts of India. All describe the brilliant sunsets of the first week of September, and record the appearance of a green sun on several days. It was seen at Muttum in the south of Madras on the 9th, and continued for several days both in the morning and the evening. The green colour was then lost, but reappeared from the 22nd to the 28th inclusive.

At Bellary the sun was seen "emerald-green" at rising and setting on the 10th to the 14th inclusive. The observations were not carried on longer.

At Coonoor on the Nilgiris the abundance of green tints in the sunsets was noted, but the sun itself was merely described as of a "shimmery" appearance.

The observations at Ongole have been already noticed in NATURE.

*The Spectrum.*—The spectrum of the sun when green was repeatedly observed and photographed with the large zodiacal-light spectroscope, which is furnished with one large prism of dense glass and a very long collimator permitting the use of a wide slit. The main features of the spectrum taken on the sun when green were—

1. A very strong general absorption in the red end.
2. A great development of the rain-band and of all other lines that are ascribed to the presence of water-vapour in the atmosphere, more especially of the group C<sub>1</sub> of  $\alpha$  and of the band at W.L. 504.

The absorption in the red end was of very varying intensity,

but when the phenomenon was at its maximum phase it gradually crept up from about B till past C, as the sun sank towards the horizon. On the 12th, when the sun was within a few degrees of the horizon, the absorption was well marked up to W.L. 621, *i.e.* to beyond *a*, while at the violet end the visible spectrum ended at W.L. 428, or just beyond G.

The lines A and *a* were never visible even on the sun, when it was green, and even B could be made out with difficulty from half an hour before sunset onwards, and before it vanished it grew intensely prominent with enormously thick bands on the less refrangible side. The band C<sub>1</sub> on the more refrangible side of C became very broad and black, while the fine line between this and C remained thin and sharp, and C itself thickened out on the less refrangible side. The rain-band was stronger than I have ever before observed it on the plains, and even with the dispersion produced by a single prism at least eight lines could be measured in it, while many more were visible. The low-sun-band was not very conspicuous, but this was partly due to contrast with the very strong rain-band. The line W.L. 568 at the more refrangible side of the low-sun-band was very well marked, and the band itself seemed to consist of a series of equidistant lines.

The apparently much stronger absorption in the red than in the blue end was a very marked feature, which became still more conspicuous when a photograph of the blue end was examined.

Since the passing away of the abnormal conditions I have made careful observations of the sunset spectrum with the same apparatus, and I find that ordinarily A and *a* are clearly visible as well as B, though at times they are strongly marked, and a good deal of shading is observable between them; C<sub>1</sub> is much thinner, and the rain-band is less prominent than the low-sun-band, which however does not now have the appearance of a number of fine lines. The nearest approach to the green-sun spectrum was observed recently during a severe thunderstorm, which was accompanied by a fall of about 1½ inches of rain. A very similar though less intense spectrum can be observed almost any evening by taking advantage of the passage of a small thin cloud over the sun's disk. If a lens is used in front of the slit of the spectroscopic, the absorption due to the cloud will be seen as a band in the middle of the bright spectrum from the unclouded part of the sun, and owing to the strong contrast, the details of the absorption will be well seen, just as in the case of the spectrum of a sunspot.

*Meteorological Phenomena.*—The electrification of the air was carefully studied during the green sun period, and the results are rather curious. From September 3 to 6 the potential of the air was positive in the early morning, diminished to zero between 9 and 10 a.m., then became negative, and remained so until the sea-breeze came on in the afternoon, when the charge was positive again, and continued so all night. The amount of electrification varied greatly and rapidly. On the 7th and 9th the potential was positive all day, on the 8th it was negative for a short time. From the 10th to the 12th it varied in the same way as from the 3rd to the 6th, and this state of matters was repeated from the 20th to the 27th; the electrometer readings from the 13th to the 19th having been normal. All the negative readings were got during a hot land wind from the west. Between the 6th and 9th of September a storm of unusual violence swept over the Madras Presidency from the south-west to the north-east, making itself felt in different ways at different places. The rainfall for September was unusually small all over Madras. The average for fifteen stations was 3.24 inches, not quite half the average for this month during previous years.

The barometric curves for Colombo, Madras, Belgaum, Allahabad, and Calcutta (Alipore) have been drawn and found to resemble each other closely. All over India there was a minimum between the 6th and the 7th, a maximum about the 18th, another minimum on the 21st, then a rise, and a third minimum on the 27th.

The first essential in any attempt to arrive at an explanation of the cause of the green sun is to ascertain the precise dates at which the phenomenon was first observed in various parts of the world. It is difficult to do this, for people are apt to make more precise statements than their observations warrant. For instance, the sun certainly set with a peculiar silvery gleam, but no greenness, at Madras on September 9, and yet many persons have assured me that they saw it set green there on that evening. The reason evidently was that after their attention had been arrested by the green sunsets of the 10th and 11th they remembered

having noticed something peculiar about the sunset on the 9th, and immediately concluded that the sun had been green on that occasion also. In consequence of this tendency of the mind, the evidence for all the dates given has been carefully tested, and has been found in all cases sufficient to justify the opinion that these dates are correct.

It appears that in Ceylon, in the south part of the Madras Presidency, and at Ongole in the north, the sun was first observed to be green on the evening of the 9th, and that over the east of the Presidency, when seen at all, it was first seen green on the morning of the 10th. The green sun was reported at Belgaum on the 8th, but although the observer was trustworthy, he did not make a note of the fact until afterwards, and it is just possible that it may be a mistake.

The captain of the *Cleomene* reports a green sun and moon on the 9th, 10th, and 11th, when his position was from lat. 8° N. to lat. 16° N., and from long. 83° 30' E. to long. 88° 40' E. The chief officer of the s.s. *Pelican* saw the moon greenish on the night of the 9th, and the sun green on the morning of the 10th. The steamer was more than 1000 miles away from Madras, in lat. 10° 4' N. and long. 64° 12' E., wind south-west.

The green sun was not seen further north than Ongole, except at Vizagapatam, Rajamundry, and Simla, and the dates of observation at these stations are not preserved. It was seen at Bombay, but was so inconspicuous that it escaped notice at the Observatory.

In Honolulu the sun's disk was seen to be green before it set on September 4 and 5 (*NATURE*, vol. xxix. p. 549). On September 4 the master of the *Jennie Walker* "noticed the strange appearance of the sun, which was greenish," in lat. 8° 20' N. and long. 155° 28' W. A passenger three days out from Honolulu for Sydney saw it blue on the 5th and 6th (*Ibid.*, p. 181). On September 2 it was observed bluish green in Venezuela and in Trinidad (*Ibid.*, vol. xxviii. p. 577, vol. xxix. p. 77). It was seen at Panama on the 2nd and 3rd, and at Cape Coast Castle apparently on the 1st of September. So much for the first appearance.

The sun was again seen green on September 20, in lat. 12° 50' N. and long. 48° 26' E. At almost all stations in Southern India the greenness reappeared on the 22nd, and Hicks Pasha noticed the sun green in the Soudan on the 24th.

The phenomena of the green sun must be distinguished from those of the remarkable sunsets that occurred all over the world some time later, and the reasons for considering them essentially different are:—

1. The general appearances of the sunsets were quite different. The sunsets accompanying the green sun were lurid, and the horizon so misty that stars were lost in it; the subsequent sunsets were remarkable for the play of delicate tints, the rose-coloured after-glow, and the unusual clearness of the horizon.
2. The spectra were totally different. In the latter case the red end was unusually free from absorption; A, *a*, and B stood out clearly, the rain-band was slight, and the low-sun-bands strong. This contrasts in every way with the description of the spectrum of the green sun already given.

Three hypotheses have been put forward to account for the phenomena of the green sun:—

1. That it was due to vapours or dust from the volcanic eruption at Krakatao. This was at first proposed by Mr. Pogson.
2. That the cause was the presence of an abnormal amount of aqueous vapour—an explanation which I offered at the time of the occurrence.
3. That it was caused by a cloud of meteoric dust.

The supporters of the Krakatao theory view the phenomena of the green sun and the remarkable sunsets as due to the same cause. The two great difficulties with regard to that hypothesis are (1) that there is no proof of the existence of an air current travelling at the enormous velocity required by the dates of the appearances of the green sun at various places, and (2) granting that there was such a current, how it was that the dust was such a long time in reaching India. Mr. Lockyer gets over these difficulties by assuming the existence of an upper current from east to west along the equator, and an under current from south to north. If, however, Mr. Manley's observations are accurate, as there seems every reason to believe they are, the green sun appeared at Ongole as soon as in Colombo, and at least twelve hours sooner than in Madras; and, if the Belgaum observations are correct, it appeared there a day before it was noticed at Colombo. Taking, however, only those observations about

which there can be no doubt, we get the following velocities, taking the shortest lines between Krakatao and the various stations:—

To Colombo	2000 miles,	6·7 miles per hour
„ Madras	2240 „	7·3 „ „
„ Bellary	2450 „	7·9 „ „
Lat. 10° 4' N., long. 64° 12' E.	3100 „	9·8 „ „

These required velocities increase with the distance, and, taking along with them the rate of forty miles an hour demanded by the Japan observations, it is difficult to believe that dust could have travelled in these various directions with such different velocities.

There is also the negative evidence that rain-water collected in Madras during the period of the green sun contained no volcanic dust, as far as a careful microscopic examination of the residue could determine it. On the dust hypothesis, too, it is difficult to understand the cessation and reappearance of the phenomenon.

There is some definite evidence on which to base the argument for the water-vapour theory. The observations detailed at the beginning of this paper show that the spectrum of the green sun had the absorption-lines of water-vapour very well marked, and that there was also a general absorption in the red. This absorption might indeed be accounted for by supposing a number of dust particles of a certain size to be suspended in the air; but a precisely similar absorption has been observed when the sunlight traversed the very thick clouds of a violent thunderstorm. The fact that water-vapour may make the sun appear green is proved by the numerous observations of a green sun through the escaping vapour from the funnel of a steamer, and through mist. The abundance of water-vapour in suspension was proved by the very heavy monsoonal rains which followed the appearance of the green sun. In Madras the rainfall was 19·17 inches above the average.

The green sun, although uncommon, is by no means so rare a phenomenon as is generally supposed. Since my attention has been directed to it, I have observed it several times, very conspicuously on May 13 and 14. But there is a reason why it should not appear much more frequently, and that is that, supposing the absorption producing it to be brought about by an abnormal amount of water-vapour, that vapour must be in suspension, while in fact it generally partly precipitates, forming clouds that conceal the sun as its hour of setting approaches. An interesting question arises as to whether the clearness of the atmosphere, when a large amount of aqueous vapour was in suspension during the appearance of the green sun, might not be due to an abnormal electrical state. The numerous and intense thunderstorms that occurred during the period showed that all the clouds were highly electrified, and the electrometer observations already referred to also indicated an unusually electrified atmosphere; but I am not prepared to lay much stress on the electrometer readings until I have made a more extended series of observations in ordinary weather.

The presence of abundance of aqueous vapour at the time of the appearance of the green sun may be explained naturally enough by the setting in of the moist monsoon currents in the upper parts of the atmosphere, or at least by the conflict between the north-east and south-west monsoons, which had commenced by that time.

It is not at all improbable that the Krakatao eruption had some influence on the direction of these currents. The ejection of a large volume of heated vapour would produce a centre of low pressure and set up a cyclonic influx of air from other places. It is possible that the peculiarities observed in the Indian barometric curves for some time after the eruptions were due to this cause. The eruption, too, might have something to do with the electrical conditions; for it is known from Prof. Palmieri's observations that electricity is generated by the eruptions of Vesuvius.

I was once inclined to view with favour the theory of the appearances being produced by cosmic dust, supposing the dust to act either by its mere presence or by forming nuclei for absorption; but considerations of the amount of solar radiation during the greenness have shaken my faith in this explanation.

We must, therefore, I think, give up any theory involving the presence of sufficient dust to render the sun green. Whether or not the following sunset glows were due to dust I cannot discuss here; but I would point out that an amount of dust sufficient to produce these effects would probably not materially affect the transparency of the atmosphere.

## EDUCATION, SCIENCE, AND ART

THE Select Committee of the House of Commons appointed to consider how the Ministerial responsibility under which the votes for Education, Science, and Art are administered may be best secured, have agreed to the following report:—

Your Committee have examined the present and several former Presidents and Vice-Presidents of the Council, Secretaries to the Lord Lieutenant of Ireland, permanent heads of the Education Department in London, the present Resident Commissioner of National Education in Ireland, and also other gentlemen conversant with the matters referred to your Committee. They have also considered the evidence taken before the Select Committee appointed in 1865 and 1866 to inquire into the constitution of the Committee of Council on Education.

The first question considered by your Committee was whether primary education in Great Britain and in Ireland should be placed under one supervising Minister. Your Committee are satisfied that under present circumstances it would be undesirable to disturb the existing arrangements as to the Ministerial responsibility for primary education in Ireland.

They are also of opinion that primary education in England and Scotland should be under the control of the same Minister.

The Lord President of the Council, almost always a peer, is nominally the head of the Education Department for Great Britain.

The Vice-President represents the department in the House of Commons, and really transacts almost all the business requiring authority above that of the permanent officials.

Your Committee are of opinion that this arrangement is neither logical nor convenient. They see no sufficient reason why there should be any more real connection between the Education Department and the Privy Council than between the Board of Trade and the Privy Council; but as it may be convenient that the Minister for Education should have occasionally the assistance, whether as to English or Scotch Education, of other Privy Councillors specially summoned for consultation with him, they recommend that a Board of (or Committee of Council for) Education should be constituted under a President, who should be the real as well as nominal Minister, in this respect holding a position like that of the President of the Board of Trade. Hitherto there has been a separate Scotch Department of the Privy Council, and your Committee consider that it would be well to have a distinct permanent secretary appointed for Scotland, responsible to the Minister of Education.

Whether the Minister of Education should always be a member of the Cabinet or of the House of Commons, and what should be his salary, are questions upon which it is hardly within the province of your Committee to make absolute recommendations. They think, however, that the duties of this Minister should be recognised as not less important than those of some of the Secretaries of State.

The Minister of Education should have the assistance of a Parliamentary Secretary, able to sit in either House of Parliament.

While on the whole preferring the plan they have suggested, your Committee do not deny that there are objections to the constitution of an administrative department in the form of a board which has no real existence. The permanent secretary and his assistants bind by their signature, nominally the board, really, the political chief.

This system, it must be admitted, tends to lessen the direct control and responsibility to Parliament and the public which is apparent in the office of a Secretary of State.

The second question discussed by your Committee was whether, and if so what, authority should be exercised by the Minister of Education over endowed schools. Your Committee recommend that when schemes for endowed schools, whether in England or in Scotland, have come into operation, the Minister of Education should have full authority to call on the governing bodies to furnish him with such reports and information as he may require, and to direct any inquiries or inspection to be made which he may deem necessary.

As to public schools, your Committee recommend that the Minister of Education should be authorised to call for such reports and information as he may require from the governing bodies, but they are not of opinion that his powers should extend to directing inspection.

With respect to the Universities in Great Britain receiving grants charged on the votes of Parliament or on the Consolidated

Fund, the Minister should be authorised to require from them an annual report in such form as he may order.

Your Committee have not taken any evidence as to reformatory and industrial schools, considering that these have so recently formed the subject of an inquiry by a Royal Commission, the report and recommendations of which are before Parliament. They see no reason for altering the present responsibility for workhouse schools or for the primary schools connected with the Army, the Navy, or the Marines. The responsibility for the administration of the votes for military and naval colleges do not appear to come within the reference to your Committee.

Your Committee see no reason to disturb the existing arrangements as to the supervision of the Science and Art Department.

There are various miscellaneous votes for science and art, such as those for scientific research, distributed through the Royal Society, votes for meteorology, and votes in aid of the Royal Society of Edinburgh and the Royal Irish Academy. These votes, your Committee think, should be moved by the Minister of Education, and reports, when necessary, should be made to him.

Your Committee do not propose to bring the British Museum and the National Gallery into closer relations with Her Majesty's Government than those now existing, with this exception, that, in their opinion, the Minister of Education and the Parliamentary Secretary should be *ex officio* trustees of each of those institutions. The President of the Council, your Committee notice, is now an *ex officio* trustee of the British Museum. The House of Commons would then look to the Education Department for explanations when the votes for the British Museum and the National Gallery are discussed in Committee of Supply.

The Committee, of which the Chancellor of the Exchequer was chairman, included, among other members, Sir J. Lubbock, Mr. Salt, Mr. Raikes, Sir L. Playfair, Mr. S. Morley, Mr. Pell, Mr. Selater-Booth, and Mr. J. Collings.

### THE MARINE BIOLOGICAL ASSOCIATION

THE Council of the Marine Biological Association adopted the following statements at its meeting held on July 25 last:—

#### MEMORANDUM NO. I.

The Marine Biological Association was founded in March, 1884, at a meeting held in the apartments of the Royal Society of London, Prof. Huxley, F.R.S., in the chair. Its officers and council include the leading naturalists of the country, as well as noblemen and others who took an active part in the late Fisheries Exhibition. H.R.H. the Prince of Wales has consented to be Patron of the Association, and has given evidence of the importance which he attaches to the success of its objects by contributing a handsome donation to its funds. The following is a list of the Executive of the Association:—

President: Prof. Huxley (President of the Royal Society).

Vice-Presidents: The Duke of Argyll, K.G.; the Duke of Sutherland, K.G.; the Marquis of Hamilton; the Earl of Dalhousie, K.T.; Lord Walsingham (Trustee of the British Museum of Natural History); Prof. Allmann, F.R.S.; Sir John St. Aubyn, Bart., M.P.; Edward Birkbeck, M.P. (Chairman of the Executive Committee of the International Fisheries Exhibition); George Busk, F.R.S.; W. B. Carpenter, C.B., M.D., F.R.S.; W. H. Flower (Director of the British Museum of Natural History); J. Gwyn Jeffreys, F.R.S.; Sir John Lubbock, Bart., M.P. (President of the Linnean Society).

Council: Prof. Moseley, F.R.S. (Oxford), Chairman; C. Spence Bate, F.R.S. (Plymouth); Prof. Jeffrey Bell, F.Z.S. (British Museum); W. S. Caine, M.P.; W. T. Thiselton Dyer, C.M.G., F.R.S. (Royal Gardens, Kew); John Evans, D.C.L. (Treasurer, R.S.); A. C. L. G. Günther, F.R.S. (British Museum); Prof. Herdman (Liverpool); E. W. H. Holdsworth; Prof. McIntosh (St. Andrew's); Prof. Milnes Marshall (Manchester); Sir Philip Cunliffe Owen, K.C.M.G., C.B.; G. J. Romanes, F.R.S. (Secretary of the Linnean Society); P. L. Selater, F.R.S. (Secretary of the Zoological Society); Adam Sedgwick (Cambridge).

Hon. Treasurer: Frank Crisp (Vice-President and Treasurer of the Linnean Society), 6, Old Jewry, E.C.

Hon. Secretary: Prof. E. Ray Lankester, F.R.S., 11, Wellington Mansions, North Bank, N.W.

The object of the Association is to erect one or more laboratories on the coast of the United Kingdom, where studies may

be carried on by naturalists, leading to an improvement in zoological and botanical science, and especially to an adequate acquaintance with the food, habits, spawning, and propagation of our marine food-fishes and shell-fish.

Great scientific and practical results have been obtained in other countries, notably in the United States of America, in Germany, France, and Italy, by studies carried on through such laboratories as the Marine Biological Association proposes to erect in this country. The knowledge which can be thus and thus only gained is precisely that knowledge which is at present *urgently* needed in order to regulate and improve British Sea Fisheries, and it therefore seems to be not inappropriate that public bodies as well as individuals interested in the progress of natural history science should take in hand the promotion of the first attempt to institute an efficient sea-coast laboratory in these islands.

It is estimated by the Council that a sum of 10,000*l.* will be required to build and equip an efficient laboratory, and to insure a successful start for the Association. This sum does not include any payment to the naturalists who may conduct the operations of the laboratory, since in the first instance, at any rate, such services will be rendered gratuitously. The money which is now asked for will be expended entirely upon the laboratory, its equipment, and necessary service.

As the result of an appeal to scientific men and their immediate friends the Association has raised a sum of about 2000*l.* In order to obtain the rest of the money which is required it is necessary to appeal to a wider circle.

The Council of the Association feel that they have undertaken a work of national importance, and therefore confidently appeal to those who have pecuniary resources at their disposal to give them substantial aid in its realisation.

According to the bye-laws of the Association adopted at a meeting of members on June 17, 1884, donors of 500*l.* to the Association become governors and permanent members of the Council of the Association. The Council hope that they may receive some contributions of this amount or of larger sums, and would suggest that it might be found convenient by those who may intend to assign sums of large amount to the Association to do so in the form of a payment of so much a year spread over a term of years.

The donor of 100*l.* to the Association becomes a "Founder" and life-member. An annual subscription of 1*l.* 1*s.*, or a composition fee of 15*l.* 15*s.*, is required of ordinary members. Members of the Association have the right to take part in the government of the Association by electing the Officers and Council at their annual meeting: they will receive the printed reports of the Association, and enjoy special privileges in the use of the laboratory and its resources.

It is intended to require an entrance fee of 5*l.* 5*s.* from members who join the Association later than June, 1885.

Signed (on behalf of the Council of the Marine Biological Association),

H. N. MOSELEY, M.A., F.R.S.,  
Chairman of the Council,

Linacre Professor of Anatomy in the University of Oxford  
July 25, 1884

MEMORANDUM NO. II.—*Nature of the Building, Management, and Work of the Proposed Marine Laboratory and Experimental Aquarium.*—The Council of the Marine Biological Association cannot as yet definitely pledge itself as to details, but the following is a sketch of the nature of the building which it proposes to erect, of the probable management of the Laboratory, and of the kind of work which may be expected to be accomplished by its aid.

The most complete institution of the kind is that at Naples, which is supported by contributions from various European States, and is especially subsidised by the German Imperial Government. The buildings, fittings, and boats belonging to this institution have cost 20,000*l.* It is proposed to start such an institution in this country with half this sum.

1. *Building.*—The first laboratory of the Marine Biological Association will probably be erected on the shore of Plymouth Sound. Plymouth is not only by its natural features one of the best possible localities for the purpose, but a Committee of the Town Council has offered to the Association a suitable site free of cost and a contribution of 1000*l.*

With regard to the building, the Council of the Marine Biological Association contemplate erecting a solid brick structure

of about 100 × 40 feet ground area, and of two stories. The exterior will be simple and unpretentious. The building will be placed close to the sea-shore, so that sea water can be readily pumped into the laboratory tank, and in order that there may be easy communication with fishing-boats. It will also be desirable to have a floating barge anchored near the laboratory for special experiments on the breeding of fish, &c., and, in close proximity, it will be necessary to erect tanks on the shore, open to the tidal water, but arranged so as to prevent the escape of the animals confined in them for study.

The basement of the building will contain a reservoir tank holding several thousand gallons of sea water; on the ground floor there will be two large rooms paved with stone; one fitted with large tanks and a service of sea water, the other used for the reception and examination of a day's trawling or dredging, and also used for keeping stores and for carrying out the pickling and proper preservation of specimens to be sent, as required, to naturalists at a distance. The upper floor will be divided into a series of larger and smaller working rooms fitted with suitable tables, with reagents and apparatus required in microscopy, and with a constant supply of sea water pumped from the reservoir tank. Accommodation for ten workers will be thus provided. One of the rooms on this floor must be set apart as a library and writing-room, and must contain as complete a series of works on marine zoology and botany, pisciculture, and such matters as can be brought together. The provision of such a library is one of the special conveniences which will be offered to naturalists working in the laboratory.

The building must also necessarily contain bed-room and sitting-room for a resident superintendent, and accommodation for one servant or caretaker.

2. *Apparatus and Boats.*—These need not at first be very extensive. Glass tanks, pumping engine and supply tubes are essential. There will be necessarily one small steam-launch for dredging in quiet weather at no great distance from shore, and a row-boat. For special expeditions larger boats or steamers could be either hired or borrowed from time to time. The local fishermen would also greatly aid the laboratory if regularly paid, and thus supplement the special boats of the Association.

3. *Salaried Staff.*—The Council would propose to begin work with the smallest possible number of permanent *employés*. These would be—(a) a resident superintendent, who should be a man of fair education and some knowledge of natural history, at a salary of 150*l.* a year, supplemented by free quarters; (b) a servant of the fisherman class, who would look after the tanks and workrooms, go out in search of specimens, and manage a boat and dredging apparatus when required. Other fishermen and boys might be hired from time to time. A sum of 100*l.* a year would be required for such service at the least.

4. *Conditions of Admission to Use of Laboratory: Work to be done there.*—The Council would propose to admit to the use of a table and other resources of the laboratory, so far as the space shall permit, any British or foreign naturalist who might make application and furnish evidence of his capability to make good use of the opportunities of the place. A preference would be given to a member of the Association. A fee might in some cases be charged for the use of a table, and other tables might be let out at an annual rental to such bodies as the Universities, this being the system adopted at Naples by Dr. Dohrn.

The Council will endeavour, when the laboratory is erected and in operation, to obtain grants of money from scientific societies, and from the Government, for the purpose of carrying out special investigations on a given subject, e.g., the conditions affecting the fall of oyster-spaw, the reproduction and general economy of the common sole, the complete determination and enumeration of the fauna and flora of the marine area adjacent to the site of the laboratory, its distribution within that area, and its relation to physical conditions. Naturalists will be nominated by the Council of the Association or by the authorities who find the money by which such naturalists are paid, to make such researches at the laboratory of the Association. When some special investigation is thus started at the laboratory, the other naturalists, who from time to time come there, will be sure to take part in the inquiry, and so help to carry it on to completion. It would be the business of the resident superintendent to facilitate this continuity of work, whilst the Council of the Association will make it a special object to bring together the results attained in the laboratory each year, in the form of a report, so as to gradually organise and direct towards definite ends the work done through its agency.

In the course of time, and with increased provision of funds for the special purpose, the Association might expect to be the means of producing—

1. A thorough knowledge of the life and conditions of the marine area adjacent to the laboratory.

2. A complete and detailed account of the natural history of certain fishes, molluscs, and crustaceans of economic importance with special reference to their increased supply.

3. Contributions to the knowledge of the growth from the egg, adult structure and physiology of such rare or otherwise scientifically interesting animals and plants as occur near the laboratory.

It is not supposed that this can be immediately accomplished by the 10,000*l.* which the Association now seeks to raise. That sum will be expended in erecting the laboratory and in starting it on its career of activity. The laboratory will necessarily attract support and increased means of usefulness as, year by year, its work becomes known, and the facilities which it offers to working naturalists appreciated.

Signed (by order of the Council of the  
Marine Biological Association),

E. RAY LANKESTER, M.A., F.R.S.,  
Hon. Secretary

July 25

### THE METEOROLOGICAL CONFERENCE

A METEOROLOGICAL conference was held at the Health Exhibition on July 17 and 18; the following is an abstract of the leading papers read at the conference.

Dr. J. W. Tripe read a paper of much interest on some relations of meteorological phenomena to health.

In ages long past these relations excited much attention, but the knowledge concerning them was of the vaguest kind; and indeed, even now, no very great advance has been made, because it is only quite recently that we have been able to compare a fairly accurate record of deaths with observations taken at a number of reliable meteorological stations. The more useful and searching comparison between cases of sickness, instead of deaths, and meteorological phenomena has yet to be accomplished on a large scale in this country, and especially as regards zymotic diseases. In Belgium there is a Society of Medical Practitioners, embracing nearly the whole country, that publishes a monthly record of cases of sickness, of deaths, and of meteorological observations; but the only attempt on a large scale in this country, which was started by the Society of Medical Officers of Health for the whole of London, failed partly from want of funds, and partly from irregularity in the returns. My remarks, which must necessarily be very brief, will refer to the relations between (1) meteorological phenomena and the bodily functions of man, and (2) between varying meteorological conditions and death-rates from certain diseases.

As regards the first, I will commence with a few brief remarks on the effects of varying barometric pressures. A great deal too much attention is paid to the barometer if we regard it as indicating only, as it really does, variations in the weight of the column of air pressing upon our bodies, because, except at considerable elevations, where the barometer is always much lower than at sea level, these variations produce but little effect on health. At considerable elevations the diminished pressure frequently causes a great feeling of malaise, giddiness, loss of strength, palpitation, and even nausea; and at greater heights, as was noticed by Mr. Glaisher in a very lofty balloon ascent, loss of sight, feeling, and consciousness. These were caused by want of a sufficient supply of oxygen to remove effete matters from the system, and to carry on the organic functions necessary for the maintenance of life. On elevated mountain plateaus, or even in high residences amongst the Alps, an increased rapidity in the number of respirations and of the pulse, as well as increased evaporation from the lungs and skin, occur.

For some years past, many persons suffering from consumption, gout, rheumatism, and anæmic affections have gone to mountain stations, chiefly in Switzerland, for relief, and many have derived much benefit from the change. It must not however, be supposed that diminished atmospheric pressure was the chief cause of the improvement in health, as its concomitants, viz., a diminution in the quantity of oxygen and moisture contained in each cubic foot of air, probably the low temperature, with a



total change in the daily habits of life, have assisted in the beneficial results. The diminution in the quantity of air, and consequently of oxygen, taken in at each breath is to a certain extent counterbalanced by an increased frequency and depth of the respirations, and a greater capacity of the chest. In this country, alterations in the barometric pressure are chiefly valuable as indicating an approaching change in the wind, and as well as of the amount of moisture in the air; hence the instrument is often called "the weather glass." A sudden diminution in the atmospheric pressure is likely to be attended with an escape of ground air from the soil, and therefore to cause injury to health, especially amongst the occupants of basement rooms, unless the whole interior of the building be covered with concrete.

*Temperature.*—Experience has shown that man can bear greater variations of temperature than any other animal, as in the Arctic regions a temperature of 70 degrees Fahrenheit, or more than 100 degrees below freezing-point, can be safely borne; that he can not only live but work, and remain in good health in these regions, provided that he be supplied with suitable clothing and plenty of proper food. On the other hand, man has existed and taken exercise in the interior of Australia, when the thermometer showed a temperature of 120 degrees Fahrenheit, or nearly 90 degrees above freezing-point, so that he can live and be in fairly good health within a range of nearly 200 degrees Fahrenheit.

The effects of a high temperature vary very much according to the amount of moisture in the air, as when the air is nearly saturated in hot climates, or even in summer in our own, more or less languor and malaise are felt, with great indisposition to bodily labour. With a dry air these are not so noticeable. The cause is evident; in the former case but little evaporation occurs from the skin, and the normal amount of moisture is not given off from the lungs, so that the body is not cooled down to such an extent as by dry air. Sunstroke is probably the result, not only of the direct action of the sun's rays, but partly from diminished cooling of the blood by want of evaporation from the lungs and skin.

The effects of temperature on man does not depend so much on the mean for the day, month, or year, as on the extremes, as when the days are hot and the nights comparatively cool, the energy of the system becomes partially restored, so that a residence near the sea, or in the vicinity of high mountains, in hot climates is, other things being equal, less enervating than in the plains, as the night air is generally cooler. It is commonly believed that hot climates are necessarily injurious to Europeans, by causing frequent liver derangements and diseases, dysentery, cholera, and fevers. This, however, is, to a certain extent, a mistake, as the recent medical statistical returns of our army in India show that in the new barracks, with more careful supervision as regards diet and clothing, the sickness and death-rates are much reduced. Planters and others, who ride about a good deal, as a rule keep in fairly good health; but the children of Europeans certainly degenerate, and after two or three generations die out, unless they intermarry with natives, and make frequent visits to colder climates. This fact shows that hot climates, probably by interfering with the due performance of the various processes concerned in the formation and destruction of the bodily tissues, eventually sap the foundations of life amongst Europeans; but how far this result has been caused by bad habits as regards food, exercise, and self-indulgence, I cannot say. Rapid changes of temperature in this country are often very injurious to the young and old, causing diarrhoea and derangements of the liver when great heat occurs, and inflammatory diseases of the lungs, colds, &c., when the air becomes suddenly colder, even in summer.

The *Direct* influence of rain on man is not very marked in this country, except by giving moisture to the air by evaporation from the ground and from vegetable life, and by altering the level of ground water. This is a subject almost overlooked by the public, and it is therefore as well that it should be known that when ground water has a level, persistently less than five feet from the surface of the soil, the locality is usually unhealthy, and should not, if possible, be selected for a residence. Fluctuations in the level of ground water, especially if great and sudden, generally cause ill-health amongst the residents. Thus, Dr. Buchanan in his Reports to the Privy Council in 1866-67, showed that consumption (using the word in its most extended sense) is more prevalent in damp than on dry soils, and numerous reports of medical officers of health, and others, which have been published since then, show that an effective drainage

of the land, and consequent carrying away of the ground water, has been followed by a diminution of these diseases.

Varying amounts of moisture in the air materially affect the health and comfort of man. In this country, however, it is not only the absolute but the relative proportions of aerial moisture which materially influence mankind. The quantity of aqueous vapour that a cubic foot of air can hold in suspension, when it is saturated, varies very much with the temperature. Thus at 40 degrees Fahr. it will hold 2.86 grains of water; at 50 degrees, 4.10 grains; at 60 degrees, 5.77 grains; at 70 degrees, 8.01 grains; and at 90 degrees as much as 14.85 grains. If saturation be represented by 100, more rapid evaporation from the skin will take place at 70 degrees, and 75 per cent. of saturation, than at 60 degrees when saturated, although the absolute quantity of moisture in the air is greater at the first-named temperature than at the latter. As regards the lungs, however, the case is different, as the air breathed out is, if the respirations be regular and fairly deep, completely saturated with moisture at the temperature of the body. In cold climates the amount of moisture and of the effete matters given off from the lungs in the expired air, is much greater than in hot climates, and the body is also cooled by the evaporation of water in the form of aqueous vapour. Moist air is a better conductor of heat than dry air, which accounts for much of the discomfort felt in winter when a thaw takes place as compared with the feeling of elasticity when the air is dry. In cold weather, therefore, moist air cools down the skin and lungs more rapidly than dry air, and colds consequently result. London fogs are injurious, not only on account of the various vapours given off by the combustion of coal, but in consequence of the air being in winter generally saturated with moisture at a low temperature. The injuriousness of fogs and low temperatures will be presently dwelt upon at greater length.

Variations in the pressure and temperature of the atmosphere exert a considerable influence on the circulation of air contained in the soil, which is called ground air. As all the interstices of the ground are filled with air or water, the more porous the soil, the greater is the bulk of air. The quantity of air contained in soil varies very much according to the material of which the soil is composed, as it is evident that in a gravelly or sandy soil it must be greater than when the ground consists of loam or clay. The estimates vary from 3 to 30 per cent., but the latter is probably too high. If, therefore, a cesspool leak into the ground, the offensive effluvia, if in large quantities, will escape into the soil, and are given off at the surface of the ground, or are drawn into a house by the fire; but, if small, they are rendered innocuous by oxidation. The distance to which injurious gases and suspended or dissolved organic matters may travel through a porous soil is sometimes considerable, as I have known it pass for 130 feet along a disused drain, and above 30 feet through loose soil.

Winds exercise a great effect on health both directly and indirectly. Directly, by promoting evaporation from the skin, and abstracting heat from the body in proportion to their dryness and rapidity of motion. Their indirect action is more important as the temperature and pressure of the air depend to a great extent in their direction. Thus winds from the north in this country are usually concomitant with a high barometer and dry weather; in summer with a pleasant feeling, but in winter with much cold. South-west winds are the most frequent here of any, as about 24 per cent. of the winds come from this quarter against 16½ from the west, 11½ from the east, and the same from the north-east; 10½ from the south, 8 from the north, and a smaller number from the other quarters. South-west winds are also those which are most frequently accompanied by rain, as about 30 per cent. of the rainy days are coincident with south-west winds. Another set of observations give precisely the same order, but a considerable difference in their prevalence, viz. south-west 31 per cent., west 14½, and north-east 11½ per cent. Easterly winds are the most unpleasant, as well as the most injurious to man of all that occur in this country.

I now propose discussing very briefly the known relations between meteorological phenomena and disease. I say the known relations, because it is evident that there are many unknown relations of which at present we have had the merest glimpse. For instance, small-pox, while of an ordinary type, and producing only a comparatively small proportion of deaths to those attacked, will sometimes suddenly assume an epidemic form, and spread with great rapidity at a time of year and under the meteorological conditions when it usually declines in fre-

quency. There are, however, in this country known relations between the temperature and, I may say, almost all diseases. As far back as 1847 I began a series of elaborate investigations on the mortality from scarlet fever at different periods of the year, and the relations between this disease and the heat, moisture, and electricity of the air. I then showed that a mean monthly temperature below 44°·6 F. was adverse to the spread of this disease, that the greatest relative decrease took place when the mean temperature was below 40°, and that the greatest number of deaths occurred in the months having a mean temperature of between 45° and 57° F. Diseases of the lungs, excluding consumption, are fatal in proportion to the lowness of the temperature and the presence of excess of moisture and fog. Thus, in January 1882 the mean weekly temperature fell from 43°·9 F. in the second week to 36°·2 in the third, with fog and mist. The number of deaths registered in London during the third week, which may be taken as corresponding with the meteorological conditions of the second week, was 1700, and in the next week 1971. Unusual cold, with frequent fogs and little sunshine, continued for four weeks, the weekly number of deaths rising from 1700 to 1971, 2023, 2632, and 2188. The deaths from acute diseases of the lungs in these weeks were respectively 279, 481, 566, 881, and 689, showing that a large proportion of the excessive mortality was caused by these diseases. At the end of November and in December of the same year there was a rapid fall of temperature, when the number of deaths from acute diseases of the lungs rose from 297 to 358, 350, 387, 541, 553, and 389 in the respective weeks. From November 29 to December 9 the sun was seen only on two days for 4½ hours, and from December 9 to the 18th also on two other days for less than 4 hours, making the total amount of sunshine 8·1 hours only in 20 days. In January and February the excess of weekly mortality from all diseases reached the large number of 504 deaths; in December it was less, the fogs not having been so dense, but the excess equalled 246 deaths per week.

The relations between a high summer temperature and excessive mortality from diarrhoea have long been well known, but the immediate cause of the disease as an epidemic is not known. Summer diarrhoea prevails to a greater extent in certain localities, notably in Leicester (and has done so for years); and the cause has been carefully sought for, but has not been found out. Recent researches, however, point to a kind of bacillus as the immediate cause, as it has been found in the air of water-closets, in the traps under the pans, and in the discharges from infants and young children. In order to indicate more readily how intimately the mortality from diarrhoea depends on temperature, I now lay before you a table showing the mean temperature for ten weeks in summer, of seven cold and hot summers, the temperature of Thames water, and the death-rates of infants under one year per million population of London:—

London. Deaths under 1 Year, in July, August, and part of September, from Diarrhoea per 1,000,000 Population Living at all Ages, arranged in the Order of Mortality

	Mean temperature, to weeks	Temperature of Thames water	Age 0-1 year. Deaths from diarrhoea per 1,000,000 population living at all ages
1860	58°·1	60°·6	151
1862	59°·0	62°·0	189
1879	58°·7	60°·7	228
1877	61°·2	63°·3	347
1874	61°·7	63°·8	447
1878	63°·7	64°·1	576
1876	64°·4	64°·9	642

As may be seen, the deaths of infants under 1 year of age from diarrhoea per 1,000,000 population was only 151; whilst the mean summer temperature was only 58°·1 F. against 189 in 1862, when the mean temperature was 59°·0. In 1879, when the mean temperature was 58°·7, the deaths from diarrhoea rose to 228 per million, but a few days were unusually hot. In 1877 the mean temperature of the air was 61°·2, of the Thames water 63°·3, and the mortality of infants from diarrhoea 347 per million population. In 1874, when the mean temperature of the air was 61°·7, the mortality rose to 447 per million; and in the hot summers of 1878 and 1876, when the mean air temperatures were 64°·1 and 64°·9 respectively, the death-rates of infants were 576 and 642 per million population. The relations, therefore, between a high summer temperature and the mortality from diarrhoea in infants are very intimate. I have selected the

mortality amongst infants in preference to that at all ages, as the deaths occur more quickly, and because young children suffer in greater proportion than other persons.

The proportionate number of deaths at all ages from diarrhoea corresponds pretty closely with those of infants. To prove this, I made calculations for three years, and ascertained that only 3·9 per cent. of all the deaths from this disease were registered in the weeks having a temperature of less than 50°; 11·9 per cent. in the weeks having a temperature between 50° and 60°; whilst in the comparatively few weeks in which the temperature exceeded 60° F., as many as 84·2 per cent. of the total number of deaths was registered. In the sixteen years, 1840-56, for which many years ago I made a special inquiry, only 18·9 per cent. of all the deaths from diarrhoea occurred in winter and spring, against 81·1 per cent. in summer and autumn. In the twenty years, 1860-79, there were seven years in which the summer temperature was in defect when the mortality per 100,000 inhabitants of London was 200; whilst in ten summers, during which the temperature was in excess by 2° or less, the mortality was 317 per 100,000. The mean temperature was largely in excess, that is to say, more than 2° plus in three of these summers, when the mortality reached 339 per 100,000 inhabitants. These figures show that great care should be taken in hot weather to prevent diarrhoea, especially amongst young children; by frequent washing with soap and water to ensure cleanliness, and proper action of the skin; by great attention to the food, especially of infants fed from the bottle; free ventilation of living rooms, and especially of bedrooms; and by protection, as far as possible, being afforded from a hot sun, as well as by avoiding excessive exercise. All animal and vegetable matter should be removed from the vicinity of dwelling-houses as quickly as possible (indeed these should be burnt instead of being put in the dust-bin), the drains should be frequently disinfected and well flushed out, especially when the mean daily temperature of the air is above 60° F.

Time will not admit of more than a mere mention of the relations between meteorological phenomena and the mortality from many other diseases and affections, such as apoplexy from heat, sunstroke, liver diseases, yellow fever, cholera, whooping-cough, measles, &c., especially as the state of our knowledge on the subject is so very limited. A comparison between the mortality from several diseases in this and other countries shows that certain of these do not prevail under closely corresponding conditions. Thus the curves of mortality from whooping-cough, typhoid fever, and scarlet fever, do not correspond with the curves of temperature in both London and New York, and the same may be said of diarrhoea in India. It is therefore evident that some other cause or causes than a varying temperature must be concerned in the production of an increased death-rate from these diseases. The subject is of great importance, and I do not despair of our obtaining some day a knowledge of the agents through which meteorological phenomena act in the production of increased and decreased death-rates from certain diseases, and the means by which, to a certain extent, these injurious effects on man be prevented.

Mr. R. H. Scott, F.R.S., read a paper on "The Equinoctial Gales—do they occur in the British Isles?" Most scientific meteorologists, Mr. Scott stated, are disposed to give up, almost in despair, the idea of eradicating from the popular mind the belief in the influence of the moon on the weather. There is, however, another belief, not quite so widely spread, but still very generally accepted, which attributes to the equinoxes a peculiarly stormy character. Over and over again have I heard the remark that it would be well for those proposing to take a voyage to wait until the equinoctial gales were over. It has struck me, therefore, that as we have had for several years past a regular system of storm warnings, it might be of interest to ascertain if the record of these warnings, and of the storms with which they were connected, exhibited any maximum of storm frequency about the equinoxes.

The period I have taken has been that of the fourteen years beginning with the spring of 1870, and I have commenced with the spring in order to include the past winter, that of 1883-4. With the year 1870, the systematic checking of storm warnings was commenced on the demand of the late Colonel Sykes. The results were published as "Parliamentary Papers" for the first seven years, and subsequently the returns have been regularly prepared in the Meteorological Office, though only the summary of results has appeared in the Annual Reports. As these returns give not only the storms for which warnings were issued,

but also those for which none were sent out, they afford a ready index to the storms which have been felt on the coasts.

Only such storms have been selected as have been really severe, such as have attained force 9 of the Beaufort scale at more than two stations, with a velocity exceeding 50 miles an hour recorded by an anemograph for more than a single hour. I have also not discriminated between the directions from which the strongest winds were felt.

The results of these records show that gales are of no greater frequency at the equinoxes than at any other time.

The diagrams show that the storms are all but exclusively confined to the winter half-year, if we take that to include part of the autumn and spring.

The diagrams show that there is no strongly-marked maximum at either equinox, but they do exhibit indications of periodicity which are very interesting.

Leaving the summer alone, as not worth notice, the frequency rises from nine and eight in the periods preceding the autumn equinox to ten at that epoch. The curve then rises rapidly, the value doubling itself and trebling itself in the two succeeding intervals. We then find a falling off at the time of the Martinmas summer in the first half of November, and a second maximum in the end of that month—the period indicated by Sir John Herschel long ago, in an article in *Good Words* for January 1864, as that succeeding what he called "The Great November Wave," a phenomenon which does not receive as much attention now as formerly. The first part of December is comparatively quiet, but after that the frequency rises to its absolute maximum at the latter half of January, from which period the curve descends gradually, with one decided check in February, to the same value which it had in August, and which it attains at the end of April. The check in February reminds us of the well-known tradition of the "halcyon" days at the end of winter. The frequency at the spring equinoctial period is nearly double what it is at the corresponding interval at the autumn equinox, being 19 as compared with 10. In one particular, however, the phenomena agree—the equinoxes are periods of sudden change in storm frequency. In the autumn this rises from 10 to 20 as soon as the equinox is passed; in the spring it falls from 27 to 19 as the equinox arrives. Accordingly, persons who wait till the equinox is passed in autumn improve their chances of falling in with a storm, for the diagram shows no signs of a lull once a heavy storm has occurred. In the spring it would apparently be wise to wait till April was well advanced, if you wished to get calm weather in the Bay of Biscay.

If we now look to see what evidence of recurrence of storms for particular short periods is discoverable in our data, we find that the day most frequently so distinguished is January 1, on which a storm was recorded six times in the fourteen years. This is very remarkable, as December 31 only shows one, and January 2 only two storms. Five days—November 10 and 20, January 18 and 19, and February 26—show five each, and no less than sixteen days show four. The stormiest two-day interval is that of January 18 and 19, which, as just explained, exhibits five storms each. The most disturbed three-day period is that of January 24 to 26, where we find four storms on each day. The date of the Battle of Trafalgar, October 21, is marked by two fairs, on the 21st and 22nd, but the end of October is not so disturbed as the end of January.

The diagram also shows that almost every month in the year is occasionally nearly free from storms. October, November, December, and January have only one apiece, but in different years. March is the only month which has at least two storms, thus justifying its epithet, "March many-weathers."

Mr. Scott also read a paper on Cumulative Temperature, of which the following are the leading points:—

On the walls of the Meteorological Annexe will be found a series of diagrams, exhibiting from various districts in the United Kingdom, in a graphical form, the March of Temperature, Rainfall, and Bright Sunshine, from the beginning of the present year, and also for the entire year 1881, which is reproduced for purposes of comparison.

The object of these curves is to show clearly some of the most important factors in the growth of crops.

It is proved, almost beyond a doubt, that each plant, say each individual cereal, requires a definite amount of heat to bring it to maturity. Thus, maize requires more than wheat, and wheat again more than barley or oats.

Now various investigators, and notably Bousingault and Prof.

Alphonse de Candolle, of Geneva, have devoted much attention to this subject, and the latter writer, in his "*Géographie Botanique*," has come to the conclusion that a certain total amount of temperature above a definite base line is necessary for plant growth, and that this amount, or, as he calls it, this "sum of temperature," varies for each crop.

He found that plants, as a rule, did not begin to give indications of active vegetation until the temperature rose above 6° C. This temperature, 6° C., or, in round numbers, 42° F., that is ten degrees above the freezing point, is taken as the base for all the diagrams. Although Prof. de Candolle propounded his views some years ago, as recently as the year 1874, at the Agricultural Conference at Vienna, meteorologists were quite at sea as to how these sums of temperature were to be calculated.

The credit of solving this problem belongs to Lieut.-General Richard Strachey, the Chairman of the Meteorological Council. In the first place he proposes to adopt a certain unit of temperature to supply a standard for calculation, the unit being one degree continued for the unit of time, either one hour or one day, as the case may be. Such a unit may be conveniently called an hour degree, or day degree. The unit of time adopted for the calculations to which I am about to refer is a day, and the unit of what may be termed the effective temperature is therefore a *day degree*. A day degree therefore signifies 1° F. of excess or defect of temperature above or below 42° F. continued for twenty-four hours, or any other number of degrees for an inversely proportional number of hours.

Now the first idea I want you to take in about these day degrees is that when we speak generally of the mean or average temperature for a day, or month, or year, we imply that the resulting temperature is the same as would be observed if the thermometer indicated this mean temperature throughout the entire period for which the mean is taken. Thus, if we were dealing with daily means, an average daily temperature of 62° F., which is an ordinary temperature for a warm summer's day, would mean twenty day degrees of temperature for that day, starting from the assumed base line of 42° F., which has already been mentioned.

The first step therefore towards determining this effective temperature in day degrees resolves itself into determining as speedily and simply as possible the average temperature for the period under consideration.

We have, fortunately, to our hands, a very simple mode of arriving at the mean temperature with accuracy sufficient for our purposes. Almost all observers record the maximum and minimum temperatures once in the twenty-four hours. It is found that the half sum of these readings, the mean between them, is nearly but not exactly the average for the day. It must, of course, be understood that the instruments must be read regularly and at the same hour every day.

The next points which require attention are: whether the maximum and minimum are both above 42°, which occurs in summer, or both below that point, which occurs in winter; or, finally, whether one is above, and the other below. In the first case all the accumulated temperature is to the good; it is all on the positive side. In the second case it is all on the negative side. The third case is the only one which presents difficulty, for when the extreme temperatures are on either side of the line of 42°, one portion of the effective temperature for the day is positive, and the other negative.

Now, General Strachey carried out a long series of calculations, based on the observed hourly temperatures at Kew Observatory, and at other stations in the United Kingdom, in order to ascertain the magnitude of the co-efficient by which the difference between either of these extreme temperatures and the base temperature (42° F.) should be multiplied in order to obtain the values of the temperatures in excess or defect of 42° F. expressed in day-degrees, and he found that this, for a weekly period, was 0.4.

Accordingly we get the following rules:—

If the mean of the day is above 42° F., we multiply the difference between the minimum and 42° F. by 0.4 (four-tenths), and call this the *negative effective temperature*.

To find the positive effective temperature we subtract from the difference between the mean for the day and 42°, the negative effective temperature just determined.

If the mean of the day is below 42° F. the proceeding is similar; but we first ascertain the positive effective temperature, and subtract that from the difference between 42° F. and the mean, thus obtaining the negative effective temperature.

The method of determining the effective temperature, which may briefly be called the accumulated temperature, is fully explained in a paper by General Strachey, which will appear in the forthcoming volume of the "Quarterly Weather Report," that for 1878. Meanwhile it is extremely interesting to examine the diagrams in the Annexe somewhat minutely, and to observe how the total accumulated temperature, say, up to July 1, is made up in very different ways in the two years, 1881 and 1884, there exhibited.

The year 1881 was very cold in the winter, and its accumulated temperature was made up in the spring and early summer. In the present year we had practically no frost, but then we had unusually cold weather at Easter and at the end of May.

The practical application of the data thus obtained as standards of comparison for the growth and ripening of various agricultural products must of course be left to the agriculturists, and it will be interesting to learn how far a correspondence between the character of the several crops and the accumulated temperature of the year can be established.

The measure of temperature afforded by this system of computation appears to be as well suited to supply a standard of comparison of climates for hygienic purposes as for agriculture, and the diagrams indicate in a forcible manner the characteristic differences of climate, in respect of temperature, of the portions our islands to which they refer.

Mr. William Marriott read a paper on "Some Occasional Winds and their Influence on Health." After referring briefly to the causes of winds, Mr. Marriott spoke of the East wind, the Mistral, the Sirocco, and other well-known occasional winds. Of the East wind, Mr. Marriott said it was the most dreaded in this country. It is usually dry, cold, and very penetrating, and is well described in the old saying—

"When the wind is in the East  
'Tis neither good for man nor beast."

Dr. Arthur Mitchell, in a "Note on the Weather of 1867, and on some effects of East winds," says, "Such winds blowing over a moist surface, like that, for instance, of the human body, tend to reduce the temperature of that surface to the temperature of evaporation, which in this case is much below that of the air itself. In licking up the moisture—that is, in causing its evaporation—a large amount of heat is rendered latent. This heat must be taken from something, and, in point of fact, our bodies are, and must be, almost its entire source. A cold and dry wind, therefore, cools the surface of our bodies, not simply by enveloping them in a cool medium, and warming itself by conduction at their expense. It does this of course; but, being dry as well as cold, it does it with less activity than it would if moist and cold—damp air being a better conductor than dry air. It is chiefly, however, by the other mode that dry cold winds abstract heat from our bodies,—that is, by using their heat in the conversion of moisture into vapour. The heat so used becomes latent, and is for the time being lost. It does not raise the temperature of the air in immediate contact with the body. On the contrary, that air itself, low as its temperature may be, gives up some of its heat to become latent in the vaporised moisture, and probably gives up more than it gains from our bodies by conduction, so that the temperature of the film of air actually in contact with our bodies may be, and probably is, a little lower than the temperature of the bulk. The quantity of heat which our bodies lose in this way is far from insignificant, and the loss cannot be sustained without involving extensive and important physiological actions, and without influencing the state of health. In feeble and delicate constitutions, the resources of nature prove insufficient to meet the demand made on them, and a condition of disease then ensues."—(*Journal of the Scottish Meteorological Society*, vol. ii. p. 80.)

### SCIENTIFIC SERIALS

*Proceedings of the Linnæan Society of New South Wales*, vol. viii. part iv. contains:—Occasional notes on plants indigenous in the neighbourhood of Sydney, by E. Haviland.—Temperature of the body of *Echidna hystrix*, by N. de Miklouho-Maclay.—Plagiostomata of the Pacific, part 2, by N. de Miklouho-Maclay and W. Macleay, F.L.S.—Notes on some reptiles of the Herbert River, by W. Macleay, F.L.S.—Notes on some customs of the aborigines of the Albert district, by C.

S. Wilkinson, F.G.S., F.L.S.—On the brain of Grey's whale, by W. A. Haswell, M.A., B.Sc.—On a new genus of fish from Port Jackson, by W. Macleay, F.L.S.—Fishes from the South Sea Islands, by Charles De Vis, M.A.—Some results of trawling outside Port Jackson, by W. Macleay, F.L.S.—The "Barometro Araucano" from the Chiloe Islands, by N. de Miklouho-Maclay.—Far southern localities of New South Wales plants, by Baron Sir F. von Müller, K.C.M.G., F.R.S.—Description of Australian Micro-lepidoptera, part 10, by E. Meyrick, B.A.—Notes on the geology of the southern portion of the Clarence River basin, by Prof. Stephens, M.A.—Dimensions of some gigantic land-tortoises, by J. C. Cox, M.D., F.L.S.

THE *Zeitschrift für wissenschaftliche Zoologie*, vol. xl. part 1, contains:—P. M. Fischer, upon the structure of *Opisthotrema cochlear*, nov. genus et spec.: a contribution to the anatomy of the Trematoda.—F. Blochmann, remarks upon some Flagellates.—A. Korotneff, the budding of Anchinia.—L. Döderlein, studies of Japanese Lithistidæ.—J. Brock, the male of *Sepioloidea lineolata*, d'Orb. (*Sepiola lineolata*, Quoy and Gaim.), with general remarks upon the family of Sepioladæ.—A. Gruber, upon the nucleus and nuclear-fission in the Protozoa.—O. E. Imhof, results of a study of the pelagic fauna of the Swiss fresh-water lakes and tarns.

Part 2 contains:—A. Kölliker, the embryonic germinal layers and tissues (with a postscript).—C. R. Hoffmann, contribution to the history of the development of reptiles.—P. Langerhans, the worm-fauna of Madeira.—F. Ahlborn, (1) upon the origin and exit of the cerebral nerves in Petromyzon; (2) upon the segmentation of the body in Vertebrates; (3) upon the importance of the pineal gland (conarium, epiphysis cerebri).—C. Emery, study of *Luciola italica*, L.

THE *Morphologisches Jahrbuch*, vol. ix. part 3, contains the following:—G. Ruge, contributions to the study of the hæmal system in man.—J. E. V. Boas, a contribution to the morphology of the nails, claws, and hoofs of the Mammalia.—M. Davidoff, on the variations of the plexus lumbosacralis of *Salamandra maculosa*.—O. Bütschli, remarks upon the gastræa theory.—C. Gegenbaur, on the accessory tongue (*Plica fimbriata*) of man and other mammals.

Vol. ix. part 4 contains:—M. Sagemehl, contributions to the comparative anatomy of fishes, ii., some remarks upon the membranes of the brain in bony fishes.—P. Leshaff, upon the muscles and fasciæ of the female perineum.—H. Klaatsch, contributions to a more exact knowledge of the Campanularia.—G. Baur, the carpus of the Artiodactyles: a morphogenetic study.—G. Gegenbaur, contributions to the anatomy of the mammary organs in Echidna.

### SOCIETIES AND ACADEMIES

#### EDINBURGH

**Mathematical Society**, July 11.—Dr. R. M. Ferguson in the chair.—Prof. Chrystal contributed three papers on the application of the multiplication of matrices to prove a theorem in spherical geometry, on the discrimination of conics enveloped by rays joining the corresponding points of two projective ranges, and on the partition of numbers; in connection with the second of these he indicated a solution he had received in a note from Signor Cremona of Rome.—Dr. Alexander Macfarlane gave illustrations of a common error in geometrical calculations; and Mr. A. Y. Fraser explained two solutions (by himself and Mr. R. E. Allardice) of a problem of arrangements entitled *La Tour d'Hanoï*, which appeared in the *Journal des Débats* for December 27, 1883.

#### PARIS

**Academy of Sciences**, July 28.—M. Rolland, President, in the chair.—On the rule of Newton as demonstrated by Sylvester; a sequel to the two previous communications, by M. de Jonquières. Here two cases of indeterminants are dealt with: (1) That in which several consecutive terms are wanting in the equation, the absence of one or more non-consecutive terms giving rise to no uncertainty; (2) that in which one or more of the quadratic functions intervening in the operation are identically nul.—A study of the deviations of the pendulum at Fort Loreto, Puebla, Mexico, two illustrations, by M. Bouquet de la Grye. These observations were conducted by means of a multiplying seismograph set up in connection with the expedition sent out to observe the transit of Venus. Their object was

to ascertain how far the oscillations of the ground and the phenomenon of tides may be determined by the vibrations of the pendulum in volcanic and mountainous regions.—Report of the Commissioners, MM. Gosselin, Pasteur, Marey, Bert, and others on various recent communications received in connection with the present outbreak of cholera in the South of France. The Commission has examined altogether 240 communications, mostly from Spain, and either suggesting "infallible nostrums," or such remedies as are already in practice. Others recommend hypodermic injections of the nitrate of pilocarpine, arsenic, copper, phenic acid, salicylic acid, vapour of hyponitric acid, intra-venous injections of pure water, or mixed with chloride of calcium or other salts. All these methods have been tried, mostly with indifferent results, although phenic acid and the intra-venous injections seem to call for further consideration. But, speaking generally, the Commission regrets to have to report that none of the communications contain any really useful suggestions.—On a new application of electricity to the treatment of fibrous tumours of the womb, by M. G. Apontoli.—Researches on wheaten and other flours; distribution of the acid and saccharine elements in the various products of the corn-mill, by M. Balland.—Note on the analytical calculating machine invented by Charles Babbage, by General F. L. Menabrea. The author gives a full description of the machine left incomplete by the inventor. He also gives an unpublished letter of Mr. Babbage, dated August 28, 1843, and certifying that the anonymous English translation of Signor Menabrea's original account of the machine, which appeared with some brilliant accompanying explanations in the third volume of the *Scientific Memoirs*, was by Lady Ada Lovelace, only daughter of Lord Byron.—Note on the exact number of the variations gained or lost in the multiplication of the polynome  $f(a)$  by the binome  $x^b \pm a$ , by M. D. André.—Note on the temperature and critical pressure of the atmosphere. Relation between atmospheric temperature and the pressure of evaporation, by M. K. Olzewski.—Description of a new method of directly measuring absolute magnetic intensities, by M. A. Leduc. This method, which is an application of M. Lippmann's discovery, is extremely simple and expeditious. It enables magnetic intensities to be measured in absolute unities, and is now being applied by the author to the study of a magnetic field.—Note on the combustion of explosive gases in various states of dilution, by M. A. Witz.—Note on the quantitative analysis of nitric acid by precipitation in the state of nitrate of cinchonamine. Application of this process to the quantitative analysis of the nitrates contained in natural waters and in plants, by M. Arnaud.—Note on the triacetic ether of a butylic glycerine, by M. L. Prunier.—Note on a new method of making a quantitative analysis of the dry extract of wines, by M. E. H. Amagat.—Anatomical and physiological description of *Convoluta Schultzei*, a curious animal of relatively high organisation, but in which the association with chlorophyll elements has produced some interesting physiological phenomena, by M. A. Barthélemy. Although deprived of eyes even in the rudimentary state, these worms appear to possess a sort of visual sensation. The act of breathing by absorption of carbonic acid through the cuticle also presents a striking analogy to that of submerged aquatic plants.—Fourth contribution to the history of the formation of coal, isolated carboniferous blocks, from Commeny, by M. B. Renault.—Note on the microscopic organism associated with the zooglaic tuberculosis, by MM. L. Malassez and W. Vignal.—Note on a hitherto unobserved portion of the sting of melliferous insects, and on the mechanism employed by them in expelling the venom, by M. G. Carlet.—Memoir on the geology of the Kepp district, Tunisia, one illustration, by M. P. Mares. The author determines in this district a regular superposition of the Upper Cretaceous, Eocene, and Miocene formations, a detailed study of which promises to be of great interest.—Note on the relations existing between the crystalline systems of various substances, by M. E. Mallard.

BERLIN

**Physical Society, June 27.**—Dr. König described a subjective optical perception of which he had repeatedly become conscious in the morning on waking from sleep and while his eyes were yet shut. On a blue-gray background he saw regular closely adjoining hexagons, like the cells of a beehive, the contours of which appeared black, while the upper sides and the outwardly adjoining sides of the hexagons had a yellow appear-

ance interiorly, an effect produced perhaps by way of contrast to the bluish background. In the interior of each hexagon, but not exactly in the centre, and just a little uniformly in the different fields, a black point was visible. The radius of each figure was about the length of the diameter of the moon's image. In endeavouring to explain this phenomenon Dr. König thought first of the epithelial cells of the eye, which formed a similar mosaic behind the retina, and calculated the visual angle under which such a phenomenon was produced. From this calculation it appeared that these hexagons were considerably less than the subjective ones, as many as twelve epithelial cells being needed to tally with the field of the subjective figure. No other explanation of the phenomenon had yet been come upon by Dr. König.—Prof. Neesen gave a short survey of the methods that had hitherto been proposed with a view to regulating the electric current in its technical application. No method, it appeared, had yet been introduced into practice, and for the present the question turned only about proposals on points of principle. These were divisible into such as sought to regulate the energy by changing the resistance, and into such, on the other hand, as attempted this object by changing the electromotive force. The change in resistance was effected at first by means of the hand, and later in different ways automatically. The change of electromotive force in the case of dynamic machines was sought in part by regulation of the propelling steam-engine, in part by change of the magnet, in part by means of a second counteracting engine, in part by changing longitudinally the wire pulleys, and in part by opposed windings of the rolling wires. Thirdly, and lastly, it was proposed as a means towards regulating the electric current, that when the dynamic machine delivered more electricity than was used, the surplus should be diverted to the supply of an accumulator where, when the machine yielded too feeble a current, the supplementary energy required could be drawn. Prof. Neesen gave a more detailed account of some of these proposals, and concluded in favour of the last or third method, that, namely, of the transference and storage of surplus energy in an accumulator, as the most advisable of all the plans proposed from a practical point of view.

## CONTENTS

	PAGE
Electric Lighting . . . . .	333
Our Book Shelf:—	
Merriman's "Text-Book on the Method of Least Squares" . . . . .	334
Harris's "Propositions in Geometry" . . . . .	334
Letters to the Editor:—	
"Gas-Burners, Old and New."—Owen Merri-	
man" . . . . .	335
The "Cotton-Spinner."—Dr. F. Jeffery Bell . . . . .	335
Krakatoa.—R. D. M. Verbeck . . . . .	335
The Meteorology of Ben Nevis. By Alexander Buchan . . . . .	336
The Forestry Exhibition . . . . .	337
Practical Taxidermy . . . . .	338
Notes on the Canadian North-West. By Gerrard A. Kinahan . . . . .	340
Native American Literature and Ethnology. By A. H. Keane . . . . .	341
Notes . . . . .	343
Our Astronomical Column:—	
The New Comet . . . . .	346
Periodical Comets in 1885 . . . . .	346
A Variable-Star in Aquarius . . . . .	346
Ptolemy's 30th of Centaurus . . . . .	346
Observations on a Green Sun and Associated Phenomena. By Prof. C. Michie Smith . . . . .	347
Education, Science, and Art . . . . .	349
The Marine Biological Association . . . . .	350
The Meteorological Conference . . . . .	351
Scientific Serials . . . . .	355
Societies and Academies . . . . .	355

THURSDAY, AUGUST 14, 1884

*THE REPORT ON TECHNICAL INSTRUCTION*

**T**HE Report of the Royal Commissioners on Technical Instruction is now before the public. These two volumes, together with the short interim Report on Apprenticeship Schools in France, which was issued two years ago, extend over a wide range of matter. The Commissioners' account of their travels abroad and at home is narrated in vol. i., which concludes with their various recommendations. Vol. ii. contains a Report on Agricultural Education, by Mr. Jenkins, and another on Technical Education in America, by Mr. Wm. Mather. In the remaining volumes will be found a Report by Mr. Wardle on Silk Industries, and a scheme by Prof. Sullivan for Technical Education in Ireland, and a variety of Statistics and Programmes are also promised.

The immense mass of detail thus gathered together in this voluminous and interesting blue-book renders it a matter of some difficulty to give anything like an adequate review of the labours of the Commission. In the present article we shall confine our attention to that part of the Report which deals with technical schools in foreign countries, reserving for a second notice that part of the Report which relates to Great Britain.

The Commissioners preface their account of Continental Technical Instruction with some concise introductory notices of the general conditions of Primary and Secondary Education in various nations. Their remarks on the gradation of schools, on the use of school museums, and on the prominence given to drawing are worthy of attention. After these notices the Commissioners deal with artisans' evening technical schools, artisans' apprenticeship schools, intermediate technical schools for foremen, trade and professional schools for women, and the higher technical instruction for employers and managers. Concerning the first of these matters the Commissioners remark on the value of the numerous continuation-schools (*Fortbildungsschulen*) which exist in nearly all towns of Germany and Switzerland. It appears that in Bavaria, Baden, and elsewhere, pupils leaving the primary schools at the age of 13 are compelled by law to continue their studies in the evening schools until the age of 16: a truly wise rule, calculated to sustain the benefits of school training at a period when such training is too often prematurely cut short. It also appears that although in no country abroad is there any organisation for systematic evening instruction at all comparable to that under the control of our Science and Art Department, the teaching, at least in many foreign towns, is conducted by professors of higher standing than, and of superior attainments to, the ordinary English "science-teacher" who, it must be confessed, is too often sadly deficient in training. On the subject of artisan apprenticeship schools the Commissioners do not add much to the information given two years ago in their preliminary report, so far as France is concerned; but, in relation to some of the German schools, as, for example, the clock-making and wood-carving schools at Furtwangen and other districts of the Black Forest, there is much interesting information. In Wurtemberg there are no such schools, as the

VOL. XXX.—No. 772

authorities prefer to attempt to give sound education by means of evening and Sunday schools, without interfering with the conditions of daily labour.

In regard to Intermediate Technical Schools for foremen and others much is being done abroad, both in the special departments of weaving, mining, and industrial art, and in more general schools. In France particularly this is the case. The great schools of this type at Lyons, Rheims, and Paris are practically unique. There is nothing approaching them in this country except perhaps the Allan Glen's Institution in Glasgow. These schools and the secondary technical schools of Germany are elaborately described. The Higher Trade Institute of Chemnitz, and the four "Industrie Schulen" of Munich, Augsburg, Nuremberg, and Kaiserslautern are of this class, intermediate between the Real-Schulen and the Polytechnics. No classics are taught in these schools. Throughout Austria, Germany, France, and Holland there are also special schools for mining and for the building trades. The Commissioners devote many pages to the weaving schools, which, like those of Chemnitz, Crefeld, and Mulhouse, are to be found doing work of utmost importance to the continental industries. The spirit with which municipalities and manufacturers support these schools is truly remarkable. Employers are constantly looking out for students who have attended the technical classes. The manufacturers feel it imperative to extend their work in order that in troublous times they may have more than one string to their bow. Thus in Crefeld, where silk goods are the staple manufacture, much attention is given in the weaving school to the weaving of jute, wool, and cotton. The people cheerfully tax themselves to pay for efficient management. They recognise that the day has gone by when money can be made without effort: "to exist they must move on." Heavily taxed as the German people are by the burden of enormous civil and military expenditure, they yet believe that it is cheapest in the long run to educate the "human machine" to the highest pitch of perfection.

It is, however, with the higher technical instruction, with the great Polytechnic colleges of Germany, and with the *École Centrale* and *École Polytechnique* of Paris that the interest of the Commissioners' Report culminates. The German Polytechnics form a group of institutions of which the type is absolutely wanting in this country. These institutions, though in many respects resembling the German universities, differ absolutely from them, not merely in being technical and practical, but in having fixed curricula of study, and regular systems of examination. The eleven schools of this type (eight of which are in Germany proper, one at Zürich, one at Delft, one at Moscow) have been built at a cost of not less than three millions sterling, and are maintained at an annual cost of over 200,000*l.* This amounts to a State expenditure of about 100*l.* per annum for each student in attendance. This may be contrasted with the case of the two leading English Universities of Cambridge and Oxford. These and their colleges are believed to have a total annual income from endowments of 500,000*l.*, and as there are about 5000 men in total attending the two Universities, this also is at the rate of 100*l.* per annum per student. There is, however, room in the Polytechnic for three times the number of students

R

actually in attendance. A few figures respecting some of these schools will show how these institutions stand in public opinion. The Munich Technical High School cost 157,000*l.*, the apparatus alone being worth 36,000*l.*, and the annual expenses amounting to 20,000*l.* The Zürich Polytechnic spends 20,000*l.* annually, 13,800*l.* being derived from Federal taxes, and 3794*l.* only from fees. There are forty-five professors on the lecturing staff. 50,000*l.* have just been spent on laboratory extension. The Stuttgart Polytechnic has a State subvention of 12,000*l.*, that of Dresden 12,200*l.* The Hanover Polytechnic cost 350,000*l.*; its collection of models (chiefly engineering), 36,000*l.*, and 1250*l.* is spent every year in adding to the collection. Some idea of the preparation made for teaching engineering students may be gathered from the fact that there are stated to be in this one school no fewer than 673 tables for drawing. The Berlin Polytechnic, now nearly completed, has cost 450,000*l.*; that of Moscow 496,000*l.* The chemical laboratory of the Polytechnic of Aachen alone cost 45,000*l.* The Bernoullianum of Berne cost that little town more than 1*l.* per inhabitant! At such a price do our neighbours provide for the higher technical training. In France, too, the technical schools are maintained at great cost. In the École Polytechnique, salaries alone amount to 22,000*l.* per annum. A new addition to the laboratories is costing 96,000*l.* All this is found by the Government. On the other hand the École Centrale, which spends 17,836*l.* per annum, is self-supporting, the fees being very high.

From this enormous expenditure of money on Higher Technical Education, tangible results cannot but accrue. Many such are mentioned in the pages of the Commissioners' Report. They adduce examples of improvements in machinery which are the result to a large extent of students' training. They point out how in Continental chemical works and dye works there is a thoroughly trained chemist at the head of each separate department. They indorse the opinion of Prof. von Helmholtz as to the absolute economy of employing as heads of departments persons conversant with the theory of their work, and able by virtue of their scientific knowledge to anticipate results and to make quantitative calculations. They remark that in physics, as also in chemistry, the knowledge of the principles of the science and of the methods of research is the more important part of the equipment of the technical student. They ascribe the general diffusion of high scientific knowledge in Germany to the multiplication of the Polytechnics, and to the small cost of a higher or University education. Amongst the opinions, which they quote, of authoritative speakers, there is one of particular appositeness from the mouth of Prof. Quincke. He holds that it is an error to suppose that any Polytechnic course of instruction can *by itself* teach a student to erect an engine, work a blast-furnace, or manufacture sulphuric acid: he holds that lectures and laboratory work are obviously insufficient to prepare the student for carrying on work where actual practical experience is needed; but that, in contradistinction, the object of the Polytechnic School is *to facilitate the transition from pure science to practice*. The functions of the Polytechnic have probably never before been so well defined. It may be an open question what kind of training is the best to qualify a man to be manager of an in-

dustrial concern. But there can be no question whatever of the consensus of opinion on the Continent as to the value of the Polytechnic training. It may not, nay, cannot, supplant the experience of the workshop: but it gives something that no amount of mere workshop experience can give—something which, were it suitably introduced into industrial Britain, would supply the greatest industrial want of our time.

### BRITISH MINING

*British Mining, a Treatise on the History, Discovery, Practical Development, and Future Prospects of Metalliferous Mines in the United Kingdom.* By Robert Hunt, F.R.S. 4to. Pp. xx. 944, 231 Woodcuts and 2 Folding Plates. (London: Crosby Lockwood and Co., 1884.)

THE title shows that the author's object is to describe the past and present condition of British metal mines, and to venture some prophecies as to their future. It requires a bold heart to attempt a work of this kind: but, as explained in the preface, Mr. Hunt's long connection with mines and his official position as Keeper of Mining Records have given him excellent opportunities for gathering information.

The work is divided into four books. Book I. gives a long historical sketch of British metal mining from the time of the Phœnicians downwards. With reference to St. Michael's Mount being their trading station, the author indorses the old Cornish tradition and disagrees (p. 845) with Prof. Rhys, who has suggested that the Isle of Thanet was the *Iktis* of Diodorus. From detached memoirs and reports much information has been collated concerning mining work carried on by the Romans for lead, iron, copper, and gold.

In Chapter III., upon mining to the eighteenth century, Mr. Hunt fixes very exactly the date of the introduction of gunpowder for blasting in Cornish mines. Chapters IV., V., and VI., relating to the mining of tin, copper, lead, silver, iron, and zinc to the end of the eighteenth century, are full of valuable facts, and both here and in Chapter III. we notice many interesting statements concerning the special privileges of miners and the charters granted to them.

Book II., occupying one-third of the volume, is devoted to the formation of metalliferous deposits. The rocks and mineral veins of the principal mining districts are described, and long quotations are made from sundry writers. Mr. Hunt then sets forth the hypotheses of the best-known authors concerning the origin of lodes, and very wisely does not bind himself to any particular theory; he admits that mineral veins have been formed by deposition in fissures from lateral infiltration, from surface-water carrying down soluble salts they have dissolved out in their passage, and lastly, from ascending mineral springs. He further considers that many of the conditions observed are due to electro-chemical influences.

In the last chapter of this book the author brings forward instances of remarkable tin, lead, and copper mines in Cornwall, Wales, Ireland, and the North of England.

Book III., which is of the same length as the preceding one, is a treatise on practical mining. Rock-boring by machinery very properly comes in for a large share of attention, but some other departments of mining are

treated rather cursorily. In speaking of the *man-engine* for raising and lowering men, Mr. Hunt points out that the reason why this valuable invention is so little used is "the unfortunate system under which the mines of Cornwall and Devon are worked—a system which does not encourage the holder of shares to take any interest in the mines themselves, his interest being confined to the market value of the shares which he holds." This remark is unhappily applicable to other districts.

In Chapter IV., on ore-dressing, after an historical sketch, the principles of the mechanical preparation of ores for the smelter and the various kinds of machines now in use are described with the aid of numerous illustrations.

Chapter V., upon the discovery and extraction of iron ores from veins and other deposits, is disappointing, on account of its meagreness compared with the space devoted to less important metals, and the Cleveland ore should scarcely have been dismissed in a dozen lines.

Book IV. relates to the future prospects of British mining. To persons interested in mines, whether as owners, shareholders, workmen, or merchants furnishing them with supplies, this book will no doubt seem the most important in the volume. Mr. Hunt is not sanguine about better prices for tin, and he says that "it is improbable that our native copper mines can be expected to prove profitable for some time to come"; in the case of lead he evidently is not more hopeful, and though the prospects as regards zinc are brighter, still we are unable to supply our own wants. In spite of the productiveness of our iron mines, we have to import more than three million tons of iron ore annually.

The fourth chapter of this book contains numerous useful suggestions for working mines, and is well worthy of consideration by miners and shareholders in mines. With reference to profitable mining, Mr. Hunt says (p. 868):—"The question is frequently asked, Is British mining a remunerative pursuit? Various replies might doubtless be given in accordance with any particular set of views and opinions held on the subject, but mines promoted by mere speculation can scarcely be expected to become profitable, inasmuch as they are too frequently grounded upon a misrepresentation of facts, while the capital connected with them is often largely diverted to the pockets of individuals whose main purpose is immediate gain. Further, the management or conduct of affairs is often leavened with ignorance and incompetency; the acquisition of personal gain, at the cost of unsuspecting shareholders, being unfortunately sometimes the rule of action." No one who knows anything about mining can fail to indorse these remarks.

In Chapter V., which contains the general summary and conclusion, Mr. Hunt says that "the exhaustion of our mineral wealth is now going onward at a rapidly increasing rate," and the question arises whether we can meet the demands of trade from British mines or not. According to the author, our tin ore is practically inexhaustible, but for copper, lead, zinc, and silver we must depend greatly upon foreign and colonial mines; of iron ore we have enough for some years, though certain foreign ores are of importance to us.

The situation is summed up as follows:—"Without great improvements in the principles of mining it will not

be possible to work, at a profit, many of our deeper and more extensive mines."

The last two pages of the work, before the appendix, contain several important maxims which deserve the careful study of all persons engaged in mines, such as the necessity of supplying pure air *at any cost*, of raising and lowering the men by machinery, and providing for them in the event of accident or disease. The concluding words very properly strike at the rascality which has done much to wreck British metal mining. "Beyond these, to enable the adventurers in our Home Mines to compete satisfactorily in the metal markets with the proprietors of colonial and foreign mines, and to realise a profit on the sale of their minerals, it is absolutely necessary to study the strictest economy, and to establish—beyond the risk of any failure—the highest principles of honesty in every department, directly or indirectly, connected with British Mining."

The size of Mr. Hunt's volume is apt to alarm the reader, and the publishers would probably have done better by issuing the work in separate books. It strikes us, too, that undue prominence is given to tin, to the detriment of the more important metal iron. From the "Mineral Statistics" for 1883, we see that the iron ore raised had a value of about 5½ millions sterling, whereas the value of all the other metalliferous ores put together was only 1½ million. However, in spite of this favour shown to tin and of occasional inaccuracies, Mr. Hunt's *magnum opus* is very praiseworthy, as it contains a vast store of useful information, and the antiquary, the miner, and the capitalist are greatly indebted to him for having taken the trouble to chronicle so many valuable facts relating to such an important branch of British industry as Metal Mining.

#### LETTERS TO THE EDITOR

[The Editor does not hold himself responsible for opinions expressed by his correspondents. Neither can he undertake to return, or to correspond with the writers of, rejected manuscripts. No notice is taken of anonymous communications.]

[The Editor urgently requests correspondents to keep their letters as short as possible. The pressure on his space is so great that it is impossible otherwise to insure the appearance even of communications containing interesting and novel facts.]

#### The International Geological Congress

WILL you allow me to announce in your columns that, in consequence of the outbreak of cholera in the South of Europe, the International Geological Congress is postponed to September 1885.

JOHN MCKENNY HUGHES  
Woodwardian Museum, Cambridge, August 12

#### The Volcanic Dust Phenomena

I WOULD draw the attention of such of your readers as may be travelling in Switzerland or other mountainous countries to the circumstance that in the clear atmosphere of the mountains the great corona or circle round the sun, as well as the semicircle seen opposite the sun before and after sunset continue to be markedly conspicuous; and the higher one ascends the more striking these phenomena are. I saw both the phenomena especially remarkable on the Gornergrat, altitude 10,289 feet, on the 21st and 22nd of last month; and even as low as 4000 feet they are decidedly more striking than at sea-level. It appears, therefore, that the bulk of the volcanic dust, if such it be, that still remains continues at a great elevation, and the prediction made last autumn that it might remain for years in the atmosphere, seems likely to be fulfilled.

The explanation of the strange sunsets given by "F. A. R. R." in NATURE (p. 155), seems a good one, except as regards the green appearance of the moon and stars; I must confess I am



not convinced that this was anything but a subjective phenomenon. It is true I saw it myself when there was little if any redness perceptible in the sky; but the probability is that one's eyes had become so dazzled by, and used to, the intense redness previously existing, that one was rendered incapable of seeing a moderate degree of red, and the complementary colour was produced in uncoloured objects. Besides, gas-lights sometimes partook of this colour. As regards the sun, I agree with "F. A. R. R." in the impression that when it was moderately near the horizon it was whiter than usual all last winter and spring, and perhaps to the present time.

Sunderland, August 6

T. W. BACKHOUSE

#### Upon the Occurrence of Bacteria and Minute Algae on the Surface of Paper Money

THE recent researches of Paul Reinsch of Erlangen have shown the occurrence of different schizomycetes and of two new minute algae (*Chroococcus monetarum*, *Pleurococcus monetarum*, Paul Reinsch) on the surfaces of the coins of many nations, living in the thin incrustations of organic detritus (composed especially of starch grains, fibres, &c.) deposited upon their surfaces in the course of long circulation. This extremely thin incrustation renders the coins very suitable for this micro-vegetation, but the same phenomenon is also exhibited in the case of paper money, and indeed by notes of clean and, to the unassisted vision of a quite unaltered appearance.

Having scraped off some of these minute incrustations with a scalpel and needle and divided them into fragments in recently boiled distilled water, with lenses of high powers (1/10th inch of Messrs. Beck) there were distinctly seen various schizomycetes, &c.

I have investigated the Hungarian recent and older (from the year 1848-49) bank and State notes, also Russian 1-rouble notes, and have found upon all of them—even upon the cleanest—schizomycetes, &c.

On the surface of all the paper money is always to be found the bacterium of putrefaction (*Bacterium termo*, Dujardin).

In the thin incrustations of paper-money the occurrence of starch grains, especially that of wheat-starch, linen, and cotton fibres, animal hairs, &c., are easily to be demonstrated, and upon the 1-forint<sup>1</sup> State-notes in such deposits the common saccharomyces are also to be found. Various micrococci, leptotriches (many with club-shaped swelled-up ends), and bacilli are also very frequent plants in these deposits on paper-money.

The two new species of algae described by Paul Reinsch are very rare on the paper-money. The green pleurococcus cell I have observed in some cases on 1- and 5-forint State-notes and the bluish-green minute chroococcus on the edges of the 5-forint State notes.

The vegetation of the paper-money is, as a result of my researches, composed of the following minute plants:—

1. *Micrococcus* (various forms).
2. *Bacterium termo*.
3. *Bacillus* (various forms).
4. *Leptothrix* (various forms).
5. *Saccharomyces cerevisie*.
6. *Chroococcus monetarum*.
7. *Pleurococcus monetarum*.

From a hygienic point of view, also, the investigations of the commonest necessary household objects may not be superfluous, and I would especially call attention to these forms as occurring on the means of instruction, viz. the handbooks, &c., used by our young scholars.

JULIUS SCHIAARSSCHMIDT,

*Privat docent* of Cryptogamic Botany and Anatomy of Plants, Assistant at the Botanic Institute and Gardens, Royal Hungarian University, Kolosvár

#### Fireballs

THE following account I have received from a lady at Brühl near Cologne, July 26:—"8.22. A large fireball of scarlet fire almost as large as a harvest moon just sailed along and upwards, at a varying but mostly very rapid rate, until, at a great height, it remained for some minutes almost or quite stationary; then after some uncertain movements rose again, and rising, became smaller, until it finally disappeared. . . . Every one who saw it seemed

petrified with amazement." This is of interest from the long time that the ball was visible, and its being seen by several people. I described some time ago some fireballs which I saw slowly moving at a distance during a storm in Egypt, which were then put down as illusory results of a flash (*NATURE*, vol. xxiv. p. 284), but now many similar cases have been lately reported. A large fireball, described as about a foot in diameter, was seen a few years ago near here; it struck a pavement, went over a low wall, moved across a wide lawn, and finally vanished in a wet ditch.

While living lately at San (Tanis), thirty-two miles south-west of Port Said, there occurred a most remarkable thunderstorm on May 12, lasting from 1.15 till 4 p.m. The rainfall in two hours was over 1½ inches; the hailstones (which covered half the area of the ground) were mostly 3/10ths to 4/10ths inch in diameter, and some 7/10ths, of concentric structure with jagged edges. Whenever I could hear anything above the battering of the hail on my iron roof there was always thunder going on; and as soon as the rain ceased I went out of doors, where for half an hour longer I can positively assert that there was not an instant of silence. This thunder was not in loud, reverberating peals, but was a continuous rushing, gusty, swishing sound; the noise rising and falling just like a gusty, tearing, high wind, without any crashes or explosive bursts, and with very little bumping or knocking sounds. It only lightened once or twice during that half hour, and there was but a faint breeze of wind. To the best of my belief the thunder was similar during the whole time of the storm, though with more explosive sounds and more lightning in the early part. It is impossible to refer such a storm to the ordinary instantaneous, sharp discharges with echoes, as the sound had no character of a reverberation; it appears to be due to a continuous discharge like that from a point. The storm was quite local, only extending a few miles. Since returning to England I have also heard thunder which was apparently not from an instantaneous discharge, as it began lightly and waxed louder for two or three seconds, until a loud crash of the main discharge took place.

The whole question of slow or peculiar discharges and of fireballs needs clearing up by careful observation; it is useless to ignore it or refer it to illusion, merely because we have not imitated it artificially or made a theory on the subject.

Bromley, Kent

W. M. FLINDERS PETRIE

#### Museums

IN an excellent article on "Practical Taxidermy" in *NATURE* of August 7, reference is made to the Museum at Leicester as approaching to the ideal of what museums should be. While fully agreeing with the opinions attributed in that article to Mr. Bowdler Sharpe, and admitting that the Leicester Museum has at last taken one step towards the ideal which was worked out for it some years ago, I feel bound to point out to such other museums as are waking up to the necessity of a radical revolution, that perfection is a long way off yet; that there is ample room for each to do better than its predecessor; that Leicester has not even carried out the general principles laid down by Mr. Bowdler Sharpe; and that these general principles may be developed in various directions.

They should consider what a provincial museum can do to the best advantage, for the world, for local students, and for the unlearned public; and by what methods of arrangement, of public exhibition and of private access, its highest functions can be most completely brought out.

Of the three educational objects for which rates can be levied by Town Councils, viz. museums, free libraries, and art galleries, the popular taste is rather tending just now towards the free libraries and the art galleries. There is a disposition to regard museums as mere hobbies for the few, and to devote the lion's share of the rate to literature and art. This is perhaps only a swing of the pendulum, but it is justified to a large extent by the condition of nearly every provincial museum at the present time.

Science is taught in most museums as reading, writing, and arithmetic were taught in the old-dame schools—in a clumsy, thoughtless, perfunctory manner, which wasted half the time and interested nobody. Mr. Mundella, with the Education Act in his hands, has made a revolution in the schools; if Mr. Bowdler Sharpe will get his ideas developed in museums with equal success, he will supplement the schools in a most valuable and important direction.

<sup>1</sup> 1-forint (to German Gulden) = 2s.

His first principle, that the primary object of every county museum should be to make as perfect a collection as possible of the natural productions of that county, exhibited in the most attractive form, is undoubtedly correct, and has been definitely sanctioned by a large body of competent authorities. This is just what can be done by each provincial museum better than by any other institution in the world, and it is just what is especially wanted by scientists, by students, and by the public. But this unfortunately has not been made the primary object either at Leicester, Nottingham, or Derby.

Mr. Sharpe's second principle, that each museum should possess also a typical series of foreign specimens for comparison with the local ones is equally correct. Science depends upon the appreciation of similarities and differences. The faculty of careful observation and comparison is of such fundamental value in all education and might be so effectively cultivated in museums that these institutions will in the future be found essential adjuncts to the schools. But here all existing museums are particularly weak. Opportunities for comparison are not sought out. The collections are not arranged with any special view to making comparisons easy and obvious. If, for instance, the local birds are in one room, and the foreign types in another, comparison is made as difficult as possible. Even if they are on opposite sides of one gallery, and the divisions of the orders made exactly to correspond, it is still difficult. They must be brought so near together that the eye can match them as it would match two patterns. This can be accomplished, and in an artistic and very interesting manner. It is to be hoped that the museum of the future will work out Mr. Bowdler Sharpe's principles much more completely than has yet been done.

Birstal Hill, Leicester

F. T. MOTT

#### Measuring Heat

DURING the past twelve months I have been endeavouring to construct some form of calorimeter which should aid me in the identification of minerals, and which should, to that end, combine accuracy with ease of manipulation. The avoidance of thermometry seemed highly desirable, and a *differential* method suggested itself.

One gramme of the mineral undergoing investigation, and one gramme of pure silver, are heated in the same steam chamber and simultaneously transferred into the muffles of two Favre and Silbermann's calorimeters, made of uniform size and placed side by side, similarly shielded from external sources of error during experiment. The specific heats are compared by the index movements of the calorimeters, the index tubes being either simply calibrated or empirically graduated.

Both calorimeters are here exposed to the same external sources of error. The amount of heat lost by radiation, however, will, for each calorimeter, depend on the duration of the experiment and the rise of temperature experienced. Now the heat received is communicated to the walls of the calorimeters by convection currents, ascending from the muffles, in the first instance, very much more slowly by conduction. It appeared, then, that an *internal* non-conducting shield of a porous nature lining the walls and retarding convection currents might reduce such loss very considerably. Experiment confirmed this supposition. An apparatus I have had constructed on this principle by Yeates of Dublin is now nearly ready for experiment.

Engineering School, Trinity College, Dublin,  
August 5

J. JOY

#### Circular Rainbow seen from Hill-top

THIS is not such an unusual phenomenon. It depends of course on the position of the observer as regards the sun, and his "coin of vantage," viz. having a space below him. I have seen it several times in my life, and remember a beautiful illustration of it given by Mr. Bains, the artist who accompanied the traveller Chapman to the Victoria Falls on the Zambese. His painting was, and probably is, in the Library at Cape Town. He is represented as standing on a projecting rock overlooking the Falls, or perhaps I should say looking up the crevice into which the water falls, and in the centre of a glorious double circular rainbow. I have heard the picture much criticised and its accuracy doubted, but having had actual experience of such a sight, I always maintained its correctness.

I saw lately another "bow," which struck me as very remark-

able—perhaps because I never saw one like it before. My house stands on a hill-top; below me at some distance is a piece of low ground, covered by the tide at high water. The sun was low behind me, and the "bow" was formed on a mist coming up from the sea and swamp. It was, however, so *flat* that it at once arrested my attention, and I called the members of my family to see a "flat rainbow"! All agreed they had never seen one like it. It was quite near us, as was proved by its intervening between certain objects; but I subsequently detected one part a long way to the left of me, showing it was, of course, a true "bow," but of an enormous size.

British Consulate, Noumea, June 17

E. L. LAYARD

#### THE MIGRATION OF SALMON

DURING the last ten years some exceedingly interesting researches have been effected by German, Finnish, Swedish, and Norwegian ichthyologists as to the migration of salmon on their respective coasts. Thus, by careful researches, some Swedish and Finnish *savants* have proved that the salmon, which in the summer are caught in the rivers of the upper gulf of the Baltic, have at another season, most probably in the winter, paid a visit to the shores and rivers of Northern Germany. This has been conclusively proved by salmon caught in the Swedish and Finnish rivers having German-made hooks in their gills and stomach. From this it is therefore apparent that, in the Baltic, salmon are in the habit of quitting the rivers of Northern Sweden and Finland in the autumn in order to visit the shores of Northern Germany during the winter, and return to their haunts in the spring. That the fish should be capable of performing the enormous journey across the Baltic—from the upper gulf to the Pomeranian coast—and back every year may indeed seem incredible, but that it is impossible is fully disproved by the experiments with salmon and trout effected by the late Mr. Frank Buckland on the coasts of Scotland and England in the same direction.

In March 1872 Profs. Virchow and Hansen were commissioned by the German Fishery Association to "mark" some of the salmon which had been hatched artificially near Hameln, in order to ascertain whether they were in the habit of returning to the river. The fish then in the hatching reservoirs were one year old, and mostly seven centimetres in length, although some were twice the size. Having tried cutting off various parts of the fins, it was found that it was most suitable for the object in view and the health of the fish to cut the so-called "fat" fin right away, particularly as the fish would retain this mark even when full grown.

On March 23 and 24, 1872, a thousand salmon marked in this manner were let out into the Weser. The marking was effected by taking the fish in the left hand, and then cutting the fin away with a pair of scissors, whereby the fish were perfectly uninjured. The little fat fin, which is mostly found on *Salmonidæ* only, contains no nerves of any importance, and has no particular function, so that its removal does not impair the fish in the least.

Ever since that year the fishermen between Bremen and Hameln have been on the look out for the marked fish, but not until a month ago a fish was caught, weighing 30 lbs., at Osterdeich, just above Bremen. The fat fin, which, on the fish one metre long, ought to have been six centimetres, was entirely absent; and, when the well-healed cut was felt, the hard membrane indicated that an operation had at one time or another been performed at this spot. The fish, which was marked as a grilse in 1872, was then thirteen years old—an age which in every respect corresponds with the age fixed by the fishermen. According to general observation, it has been demonstrated that the salmon in the Weser is, when one year old, from five to twelve centimetres long. In the second year it has been proved that the salmon go into the sea, and when they re-enter the river at four years of

age they weigh from eight to twelve pounds, and in the fifth year from twelve to fifteen pounds. From that age upwards the weight increases rapidly.

The results of the artificial hatching in the Weser are exceedingly promising. Thus the salmon fisheries at Hameln have been doubled in consequence during the last ten years, the tax at present paid to this town alone by the salmon fisheries being more than a thousand pounds.

In Norway, too, efforts have been made in the same direction during the last few years. Thus in 1883 the Storting granted a sum of money for this purpose, and with this amount the Chief Inspector of Fisheries, Herr A. Landmark, has effected the marking of several hundreds of salmon and trout, chiefly on the west coast of Norway, during last autumn and winter. The marking here is effected by means of a tiny bit of platinum, 7 mm. long, and 4 mm. broad, being thus about the size of the nail on the little finger, which is attached by a very fine platinum wire to the fat fin of the big fish and the tail of the smaller ones. The piece has a number stamped on it, which corresponds with one in a "log" giving all the particulars as to the date the fish was marked, its weight, size, &c.

In order to encourage fishermen to be on the look-out for these marked fish, the inspector offers a reward of two shillings and sixpence for each mark forwarded to him, if accompanied with precise information as to the spot and date when it was taken, the length and breadth of the fish, and its weight.

As these researches will tend greatly to ascertain the habits and migrations of *Salmonide*, the result will be watched with interest.

#### THE TRINITY HOUSE EXPERIMENTS ON LIGHTHOUSE ILLUMINANTS

THE great advances made during the past few years in the science of illumination have rendered it desirable, or rather absolutely necessary, that experiments should be undertaken with a view to the determination of the advantages and disadvantages attending the use of different illuminants in lighthouses. With this view the Corporation of Trinity House have commenced a series of experiments at the South Foreland.

There are at present on the South Foreland two lighthouses, known as the high light and low light, and both of these are illuminated by electricity. Near these, three experimental lighthouses have been erected for use with the electric light, with gas and with oil respectively. The electric apparatus consists of three arc lamps and three magneto-electric machines made by Baron de Meritens. The lamps are placed one above the other in the tower. The carbons being used are "compound carbons," made up of many small rods of carbon of square section, coated with copper, and Siemens's "core-carbons," made of gas-carbon, with a central rod of graphite. When worked up to their full power, each lamp is estimated to be capable of giving a light equal to 30,000 candles.

The second tower is fitted up with Mr. Wigham's gas-burners. To supply the burners a small gasworks, fitted with retorts, purifiers, and a gasholder capable of holding about 5000 cubic feet, have been erected near by. The tower contains four burners, one above the other, each burner consisting of concentric rings of jets. The total number of jets on each burner is 108, making a total on the four burners of 432 jets; but the outer rings may be removed when less light is required: so that each burner may be used with 28, 48, 68, 88, or 108 jets. A talc chimney above the flame produces the necessary draught; no glass or talc is placed over the most luminous portion of the flame.

The intensity of the light when all the jets on all four burners are used is stated by the inventor to be equal to

12,000 candles. The third tower is for the present devoted to the oil and gas-burners invented by Sir James Douglass. The oil is supplied from a tank to the burners under a slight pressure. One oil-burner has six concentric wicks, and has a power of 720 candles; a second has seven wicks and a power of 1000 candles. There are three burners in the tower, placed one above the other. Each tower is provided with lenses both for revolving and for fixed lights. The highest power of the gas tower is a quadriform light, of the other towers a triform light. Besides the illuminants already mentioned, there are gas-burners from the Sugg and from the Siemens Companies, which will be tested in the lighthouse towers.

For observing the lights and testing them, a line of

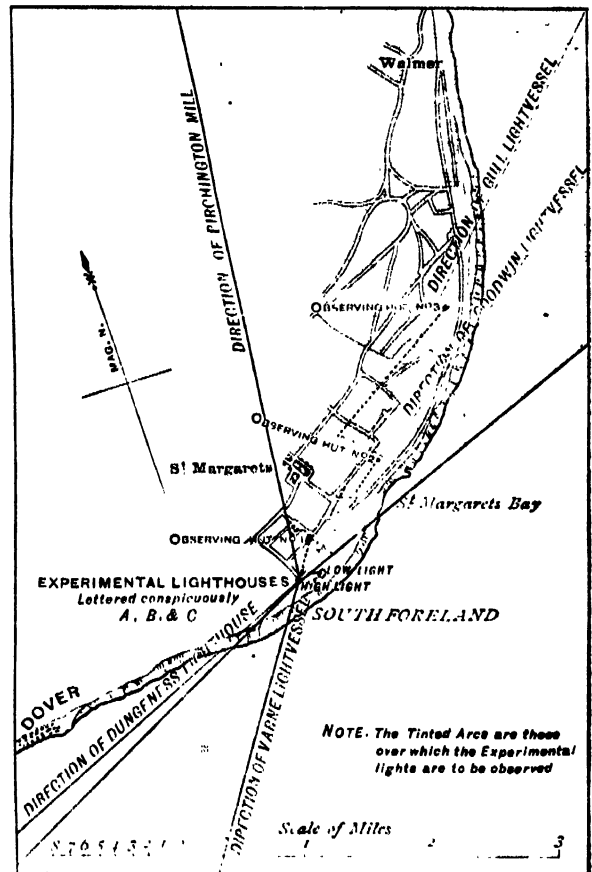

Local Map for Observations on Land.

observation has been measured out in the direction of Deal, and three huts have been erected at a distance of  $\frac{1}{2}$  mile,  $1\frac{1}{2}$  mile, and  $2\frac{1}{2}$  miles respectively from the towers. These huts are fitted up as photometric observatories. The lights are focussed on one of the huts, and they are then measured in all conditions of weather by means of the pentane unit of light devised by Mr. Vernon Harcourt. When the weather is too thick to allow of direct comparison with the unit, the lights are compared one with another by means of a polariscope-photometer, in which the ordinary image of one light is brought to equality by means of a Nicol prism with the extraordinary image of another light. In ordinary weather a ray from the lighthouse tower enters a hole in a shutter and falls

on a portion of a paper disk : a contiguous portion of the disk is illuminated by the pentane candle fixed on one side of the opening in the shutter. The disk can be moved on a trolley to and fro until equality of illumination is reached, when its distance from the candle is measured. This measure and the known distance of the observatory from the lighthouse give the necessary data for determining the illuminating power of the light. By these measurements, taken at different distances in various states of the atmosphere, the penetrative power of the several illuminants will be determined. For instance, in very clear weather the electric light may give twenty times the light of the oil light ; a slight haze comes on and the electric light is found to be only ten times as bright. It has suffered in a greater ratio than the other. A mist blows by the towers, and the superiority of the electric light becomes less and less marked : before the lights are finally obscured the superiority has vanished. It need hardly be stated that this question of penetration is the most important point the Trinity House are called on to settle.

The principle of superposition of lights also raises an interesting point. When two lights are placed close together they can be seen at a greater distance than one light. Up to what point will this increase of range continue on multiplying the lights—without altering the intrinsic brightness of each? It may be that in thick weather the eye can detect a large area of low illumination better than a smaller area of higher illumination ; and it may be that the electric light with its smaller lenses suffers from this reason in comparison with the oil and gas lights with their larger lenses.

We hope that the experiments will not be discontinued before these points have been thoroughly sifted, as they only can be satisfactorily, on the actual working scale.

We may add that the electric machines and cables are being tested by Prof. Grylls Adams, and the photometric observations taken by Mr. Harold Dixon. Mr. Vernon Harcourt is appointed to watch the experiments generally and report to the Board of Trade.

We give a plan of the district showing the point of observation, which includes the coast-guard stations and light-ships in the vicinity.

#### THE INTERNATIONAL CONFERENCE ON EDUCATION

THE Conference which was held at the Health Exhibition last week has achieved a remarkable success. It was attended by upwards of a thousand persons, including many of the leading teachers in English, Scotch, and continental schools, University professors, statesmen, managers of schools, and others interested in different ways in the subject of education. The interest was so well sustained that all four sections were more crowded on the last day than the first, and very general regret was expressed that the Conference should close so soon. Two circumstances mainly contributed to this result. The president, Lord Reay, by his tact and courtesy, his knowledge of foreign languages, and his cosmopolitan experience was singularly qualified, both to obtain from different continental States their most fitting representatives, and to give to these representatives when they arrived appropriate tasks and a worthy welcome. And Lord Reay was helped in the task of organising the Conference by a small but efficient committee, by whom during several previous months the work of selecting the readers of papers had been sedulously pursued. Unless pains had been taken in relation to each subject of discussion to secure that it should be initiated by a person who spoke upon it with some authority, and special knowledge, the result would have been far less satisfactory.

The Conference sat in four sections, which were at

work simultaneously during five days. The first of these was devoted mainly to the consideration of questions relating to elementary education. The best and most fruitful subjects of discussion here were the Kindergarten, physical training, and the right way of inspecting, examining, or otherwise testing the work of pupils. Fröbel's principles, which have done so much to transform the system of training very young children in England, in Belgium, and in France, were expounded with much fulness of knowledge and felicity of illustration by some of Fröbel's own countrymen and disciples, as well as by ladies who have in England qualified themselves by special sympathy and knowledge to become his exponents. Closely akin to this subject were the topics of gymnastic and physical training, the better construction of schools and school apparatus, and the indirect effect of pictorial or other decorations in improving the taste and cultivating the imagination, and of increasing the scholars' interest in their work. The Swedish and other systems of bodily exercise, and the means of sense training by music and by object lessons were well discussed. On the general subject of the organisation of elementary education, which was debated in a crowded audience under the presidency of the Vice-President of the Council, the results were somewhat disappointing. Some of the teachers took the opportunity of the presence of their official chief to urge the demand with which the public have been long familiar, for grants of public money on easier conditions, and for the abandonment of the principle of payment by results. But no other practical method of distributing the public money was suggested, and it was generally felt that the Vice-President had an easy victory over those who sought to attack the principles of the recently-modified Code. A more important subject was raised in the animated debate on the inspection and examination of schools, which was rendered more apposite at the moment by the appearance of the recommendations of the Select Committee of the House of Commons, recommending that there should be in England a Minister of Public Instruction, and that he should have *inter alia* the duty of inspecting and annually reporting on the endowed secondary schools. It was perceived that this was a step of considerable moment and significance. Under the Act of 1869 endowed schools have been re-organised, and their governing bodies and schemes of study re-constituted. But neither the Commissioners who administer that Act, nor the public, know anything of the way in which those schemes are carried out, nor of the actual performances of the schools from year to year. There was among the larger number of earnest speakers on this point, a very general agreement on two points: first that some such public supervision over the reformed foundations was absolutely necessary, in order to keep them efficient ; and secondly, that as there would be in this case no grant to administer, there would not be, as in elementary schools, any need to formulate conditions as to instruction, but simply to inquire in every case what the endowed school professed to do, and to see how far it had realised its own ideal. It is rather for the purpose of knowing what the schools are doing, than for that of imposing upon them by authority any theory or official ideal that State supervision seems to be demanded in regard to endowed schools.

In the second of the sections the principal topics of discussion were connected with scientific, technical, and artistic instruction. The fact that the Conference held its sittings in the new and beautiful buildings recently erected for the City and Guilds of London Technical Institute, naturally excited special interest, and awakened discussion as to the place which the physical sciences ought to hold in general education, as well as the special uses to which the Institute might be put in connection with the improvement of handicrafts and skilled trade. Mr. Magnus, Prof. Armstrong, Mr. Sparkes, and other

authorities whose names are associated with the improved teaching of science or of art in this country, were enabled to compare notes with professors of similar subjects from France and the United States, and some useful results were arrived at. In one special department of this Section, the agriculturists, under the presidency of Lord Fortescue and Sir Thomas Acland, held several long and animated discussions on the better teaching of agricultural science, on farm schools, and on the right education of boys intended to be farmers. In another department the subject of school museums was brought forward in an interesting paper by Dr. Jex-Blake of Rugby, and divers subsidiary aids to school instruction, such as field excursions, organised visits to factories, museums, and other places of interest, were suggested or described. Some of the more skilled and earnest of the elementary teachers, who, by their own personal influence, have secured the co-operation of their scholars in the formation of school museums illustrative of the flora, fauna, history, or industry of particular districts, gave interesting accounts of their plans and of the practical results which attended them; and from France and Belgium, and particularly from Liverpool, remarkable testimony was produced as to the success which had attended school savings' banks, and the influence they had exercised on the children and their parents.

The third section was mainly concerned with Universities and their relation to secondary instruction on the one hand, and to the liberal professions on the other. Profs. Morley, Fleeming Jenkin, and Seeley discoursed severally on those parts of the University curriculum with which their own names are most prominently associated, while the legal and theological aspects of the University question were discussed by Sir C. Bowen and Prof. Lorimer, by Cardinal Manning and Dr. Wace. The chief interest of this section, however, lay in that department in which the proper relation between the teaching and the examining functions of a University were examined by Sir George Young and others. The status of the present University of London was regarded by many speakers as unsatisfactory, notwithstanding the searching and effective character of its examinations, and the stimulating influence which its regulations have had upon the education of students in all parts of the country. A strong wish was expressed by many speakers, that the greatest city in the world should possess a teaching University, rather than a mere examining Board; and that some means should be found of co-ordinating all the higher agencies now at work in the metropolis in such a way as to constitute a London University of a new and nobler type. The duties of the Universities to our Indian Empire were well urged upon the Conference by Prof. Monier Williams; and the whole subject of the relations of the Universities to the education of women was debated in a crowded room and with great animation and interest, *apropos* of a paper by Mrs. Henry Sidgwick, whose own valuable services at Newnham have given her a special claim to speak with authority on such a topic.

The fourth section had a somewhat miscellaneous programme, but may be briefly described as concerned with problems connected with secondary and intermediate education. The first of these problems was the training of teachers, and the best means of securing for secondary schools a supply of teachers, qualified in respect to their knowledge of the theory and practice of their art, not less satisfactorily than the trained and certificated teachers of the elementary schools are, relatively to the humbler work which they have to do. Mr. Quick, Mr. Storr, Professors Laurie and Meiklejohn, and others who have made this a special subject of investigation, were enabled to throw much light on the recent efforts of the Universities to provide instruction in the art and philosophy of teaching, and to give professional certificates to persons qualified to receive them. It was

manifest, however, from this discussion, that the one great hindrance in the way of such progress was the practical disbelief among the head-masters in the value of special professional training. Were it once understood that over and above the possession of a good University degree a head-master in search of an assistant would require, or would even *ceteris paribus* prefer that the candidate should show a knowledge of the principles of teaching or the literature of his profession, the arrangements of the Universities for imparting such knowledge would soon produce good fruit. At present, however, the teacher's diplomas issued by the Universities of Cambridge and London appear to possess but little market value in the public schools. It was shown, however, that in girls' schools of the highest class the work of professional training was much more keenly appreciated; and that among the foremost women engaged in the teaching profession, the strongest interest had been taken not only in the proposals of the Universities, but also in the Bishopsgate Training College, the Lectures of the College of Preceptors, and other public measures for ensuring specific instruction in the art and mystery of their craft for the skilled teachers of the future. One of the warmest, and at the same time one of the ablest debates in the Conference concerned the possible future relations of the State to secondary and higher education. Mr. Lyulph Stanley contended strongly for some public provision for the establishment of good secondary schools where they are deficient, and sketched out a plan which had evidently been thought out with some care, for the creation of such schools by means of rates, and for the supervision of such schools by local bodies having the public confidence. Canon Daniel, on the other hand, contended with much ability in favour of absolute freedom for local and religious bodies in the matter of secondary instruction, and against any attempt on the part of the State to initiate or control it. He pointed out, with considerable force, the remarkable success of the Girls' Public Day Schools Company, and remarked on the rapid growth of other agencies of a similar kind for supplying good middle-class schools, and for adapting the supply to the religious, social, and educational wants of different classes of the community.

Perhaps, on the whole, the most striking feature of the Conference, in the eyes of the numerous foreigners who were present and took part in the proceedings, was the remarkable interest evinced in the improved education of women; the variety of new fields now opening to their intelligence, activity, and public usefulness, and the number of ladies who took an active and effective share in the various discussions. Another point of special interest was the international character of the whole Conference, and the warm welcome with which the experience of experts from France, Belgium, Switzerland, Germany, and the United States, was received in all the sections. There has probably never been in the history of education in this country a gathering which afforded such an excellent opportunity for the interchange of opinions and suggestions between English and foreign teachers. And the executive of the Exhibition may well be congratulated on having added to their other successes the completion of a work of pre-eminent and far-reaching usefulness—a Conference which, for the ability of those who took part in it, for the high tone and courtesy of its discussions, and for the fruitfulness of its practical suggestions, has left an enduring and most pleasing impression on all who took part in it.

Among the subsidiary features of the Conference not the least useful were the visits organised by the Committee to some of the more characteristic and important of English schools. The most successful of these visits was that paid to the new buildings of St. Paul's School at West Kensington, which, though not yet occupied by the scholars, is now nearly complete in all its appointments. The party, nearly fifty in number, consisted largely of

foreign teachers from various countries. They were conducted over Mr. Waterhouse's costly and beautiful building by the Clerk of the Works and by a member of the governing body, and evinced much interest in observing all the latest improvements in school construction and fittings, and in inspecting the library, laboratories, lecture-rooms, and the ample appliances for physical training.

It is understood that the results of the Conference, the text of the papers, and a summary of the discussions will shortly appear in four or five volumes.

#### THE VOYAGE OF THE "VETTOR PISANI"

KNOWING how much NATURE is read by all the naturalists of the world, I send these few lines, which I hope will be of some interest.

The Italian R.N. corvette *Vettor Pisani* left Italy in April 1882 for a voyage round the world with the ordinary commission of a man-of-war. The Minister of Marine, wishing to obtain scientific results, gave orders to form, when possible, a marine zoological collection, and to carry on surveying, deep-sea soundings, and abyssal thermometrical measurements. The officers of the ship received their different scientific charges, and Prof. Dohrn, director of the Zoological Station at Naples, gave to the writer the necessary instructions for collecting and preserving sea animals.

At the end of 1882 the *Vettor Pisani* visited the Straits of Magellan, the Patagonian Channels, and Chonos and Chiloe Islands; we surveyed the Darwin Channel, and following Dr. Cuningham's work (who visited these places on board H.M.S. *Nassau*), we made a numerous collection of sea animals by dredging and fishing along the coasts.

While fishing for a big shark in the Gulf of Panama during the stay of our ship in Taboga Island one day in February, with a dead calm, we saw several great sharks some miles from our anchorage. In a short time several boats with natives went to sea, accompanied by two of the *Vettor Pisani's* boats.

Having wounded one of these animals in the lateral part of the belly, we held him with lines fixed to the spears; he then began to describe a very narrow curve, and irritated by the cries of the people that were in the boats, ran off with a moderate velocity. To the first boat, which held the lines just mentioned, the other boats were fastened, and it was a rather strange emotion to feel ourselves towed by the monster for more than three hours with a velocity that proved to be two miles per hour. One of the boats was filled with water. At last the animal was tired by the great loss of blood, and the boats assembled to haul in the lines and tow the shark on shore.

With much difficulty the nine boats towed the animal alongside the *Vettor Pisani* to have him hoisted on board, but it was impossible on account of his colossal dimensions. But, as it was high water we went towards a sand beach with the animal, and we had him safely stranded at night.

With much care were inspected the mouth, the nostrils, the ears, and all the body, but no parasite was found. The eyes were taken out and prepared for histological study. The set of teeth was all covered by a membrane that surrounded internally the lips; the teeth are very little and almost in a rudimental state. The mouth, instead of opening in the inferior part of the head, as in common sharks, was at the extremity of the head; the jaws having the same bend.

Cutting the animal on one side of the backbone we met  
(1) a compact layer of white fat 20 centimetres deep;  
(2) the cartilaginous ribs covered with blood vessels; (3)  
a stratum of flabby, stringy, white muscle, 60 centi-

metres high, apparently in adipose degeneracy; (4) the stomach.

By each side of the backbone he had three chamferings, or flutings, that were distinguished by inflected interstices. The colour of the back was brown with yellow spots that became close and small towards the head so as to be like marble spots. The length of the shark was 8.90 m. from the mouth to the *pinna caudalis* extremity, the greatest circumference 6.50 m., and 2.50 m. the main diameter (the outline of the two projections is made for giving other dimensions).

The natives call the species *Tintoreau*, and the most aged of the village had only once before fished such an animal, but smaller. While the animal was on board we saw several *Remora* about a foot long drop from his mouth; it was proved that these fish lived fixed to the palate, and one of them was pulled off and kept in the zoological collection of the ship.

The *Vettor Pisani* has up to the present visited Gibraltar, Cape Verde Islands, Pernambuco, Rio Janeiro, Monte Video, Valparaiso, many ports of Peru, Guayaquil, Panama, Galapagos Islands, and all the collections were up to this sent to the Zoological Station at Naples to be studied by the naturalists. By this time the ship left Callao for Honolulu, Manila, Hong Kong, and, as the *Challenger* had not crossed the Pacific Ocean in these directions, we made several soundings and deep-sea thermometrical measurements from Callao to Honolulu. Soundings are made with a steel wire (Thomson system) and a sounding-rod invented by J. Palumbo, captain of the ship. The thermometer employed is a Negretti and Zambra deep-sea thermometer, improved by Captain Maguaghi (director of the Italian R.N. Hydrographic Office).

With the thermometer wire has always been sent down a tow-net which opens and closes automatically, also invented by Captain Palumbo. This tow-net has brought up some little animals that I think are unknown.

Honolulu, July 1

G. CHERCHIA

The shark captured by the *Vettor Pisani* in the Gulf of Panama is *Rhinodon typicus*, probably the most gigantic fish in existence. Mr. Swinburne Ward, formerly Commissioner of the Seychelles, has informed me that it attains to a length of 50 feet or more, which statement was afterwards confirmed by Prof. E. P. Wright. Originally described by Sir A. Smith from a single specimen which was killed in the neighbourhood of Cape Town, this species proved to be of not uncommon occurrence in the Seychelle Archipelago, where it is known by the name of "Chagrin." Quite recently Mr. Haly reported the capture of a specimen on the coast of Ceylon. Like other large sharks (*Carcharodon rondeletii*, *Selache maxima*, &c.), *Rhinodon* has a wide geographical range, and the fact of its occurrence on the Pacific Coast of America, previously indicated by two sources, appears now to be fully established. T. Gill in 1865 described a large shark known in the Gulf of California by the name of "Tiburón ballenas" or whale-shark, as a distinct genus—*Micristodon punctatus*—which, in my opinion, is the same fish. And finally, Prof. W. Nation examined in 1878 a specimen captured at Callao. Of this specimen we possess in the British Museum a portion of the dental plate. The teeth differ in no respect from those of a Seychelles Chagrin; they are conical, sharply pointed, recurved, with the base of attachment swollen. Making no more than due allowance for such variations in the descriptions by different observers, as are unavoidable in accounts of huge creatures examined by some in a fresh, by others in a preserved state, we find the principal characteristics identical in all these accounts, viz. the form of the body, head, and snout, relative measurements, position of mouth, nostrils and eyes, dentition, peculiar ridges on the side of the trunk and tail, coloration, &c. I have only to add that this

shark is stated to be of mild disposition and quite harmless. Indeed, the minute size of its teeth has led to the belief in the Seychelles that it is a herbivorous fish, which, however, is not probable.

ALBERT GÜNTHER

Natural History Museum, July 30

### PYROMETERS

THE accurate measurement of very high temperatures is a matter of great importance, especially with regard to metallurgical operations; but it is also one of great difficulty. Until recent years the only methods suggested were to measure the expansion of a given fluid or gas, as in the air pyrometer; or to measure the contraction of a cone of hard, burnt clay, as in the Wedgwood pyrometer. Neither of these systems were at all reliable or satisfactory. Lately, however, other principles have been introduced with considerable success, and the matter is of so much interest not only to the practical manufacturer but also to the physicist, that a sketch of the chief systems now in use will probably be acceptable. He will thus be enabled to select the instrument best suited for the particular purpose he may have in view.

The first real improvement in this direction, as in so many others, is due to the genius of Sir William Siemens. His first attempt was a calorimetric pyrometer, in which a mass of copper at the temperature required to be known is thrown into the water of a calorimeter, and the heat it has absorbed thus determined. This method, however, is not very reliable, and was superseded by his well-known electric pyrometer. This rests on the principle that the electric resistance of metal conductors increases with the temperature. In the case of platinum, the metal chosen for the purpose, this increase up to  $1500^{\circ}$  C. is very nearly in the exact proportion of the rise of temperature. The principle is applied in the following manner:—A cylinder of fireclay slides in a metal tube, and has two platinum wires 100th of an inch in diameter wound round it in separate grooves. Their ends are connected at the top to two conductors, which pass down inside the tube and end in a fireclay plug at the bottom. The other ends of the wires are connected with a small platinum coil, which is kept at a constant resistance. A third conductor starting from the top of the tube passes down through it and comes out at the face of the metal plug. The tube is inserted in the medium whose temperature is to be found, and the electric resistance of the coil is measured by a differential voltmeter. From this it is easy to deduce the temperature to which the platinum has been raised. This pyrometer is probably the most widely used at the present time.

Tremeschini's pyrometer is based on a different principle, viz. on the expansion of a thin plate of platinum, which is heated by a mass of metal previously raised to the temperature of the medium. The exact arrangements are difficult to describe without the aid of drawings, but the result is to measure the difference of temperature between the medium to be tested and the atmosphere at the position of the instrument. The whole apparatus is simple, compact, and easy to manage, and its indications appear to be correct at least up to  $800^{\circ}$  C.

The Trampler pyrometer is based upon the difference in the coefficients of dilatation for iron and graphite, that of the latter being about two-thirds that of the former. There is an iron tube containing a stick of hard graphite. This is placed in the medium to be examined, and both lengthen under the heat, but the iron the most of the two. At the top of the stick of graphite is a metal cap carrying a knife-edge, on which rests a bent lever pressed down upon it by a light spring. A fine chain attached to the long arm of this lever is wound upon a small pulley; a larger pulley on the same axis has wound upon it a

second chain, which actuates a third pulley on the axis of the indicating needle. In this way the relative dilatation of the graphite is sufficiently magnified to be easily visible.

A somewhat similar instrument is the Gauntlett pyrometer, which is largely used in the north of England. Here the instrument is partly of iron, partly of fireclay, and the difference in the expansion of the two materials is caused to act by a system of springs upon a needle revolving upon a dial.

The Ducomet pyrometer is on a very different principle, and only applicable to rough determinations. It consists of a series of rings made of alloys which have slightly different melting-points. These are strung upon a rod, which is pushed into the medium to be measured, and are pressed together by a spiral spring. As soon as any one of the rings begins to soften under the heat, it is squeezed together by the pressure, and, as it melts, it is completely squeezed out and disappears. The rod is then made to rise by the thickness of the melted ring, and a simple apparatus shows at any moment the number of rings which have melted, and therefore the temperature which has been attained. This instrument cannot be used to follow variations of temperature, but indicates clearly the moment when a particular temperature is attained. It is of course entirely dependent on the accuracy with which the melting-points of the various alloys have been fixed.

Yet another principle is involved in the instrument called the Thalpotasimeter, which may be used either with ether, water, or mercury. It is based on the principle that the pressure of any saturated vapour corresponds to its temperature. The instrument consists of a tube of metal partly filled with liquid, which is exposed to the medium which is to be measured. A metallic pressure gauge is connected with the tube, and indicates the pressure existing within it at any moment. By graduating the face of the gauge when the instrument is at known temperatures, the temperature can be read off directly from the position of the needle. From  $100^{\circ}$  to  $220^{\circ}$  F. ether is the liquid used, from thence to  $680^{\circ}$  it is water, and above the latter temperature mercury is employed.

Another class of pyrometers having great promise in the future is based on what may be called the "water-current" principle. Here the temperature is determined by noting the amount of heat communicated to a known current of water circulating in the medium to be observed. The idea, which was due to M. de Saintignon, has been carried out in its most improved form by M. Boulier. Here the pyrometer itself consists of a set of tubes one inside the other, and all inclosed for safety in a large tube of fireclay. The central tube or pipe brings in the water from a tank above, where it is maintained at a constant level. The water descends to the bottom of the instrument and opens into the end of another small tube called the explorer (*explorateur*). This tube projects from the fireclay casing into the medium to be examined, and can be pushed in or out as required. After circulating through this tube the water rises again in the annular space between the central pipe and the second pipe. The similar space between the second pipe and the third pipe is always filled by another and much larger current of water which keeps the interior cool. The result is that no loss of heat is possible in the instrument, and the water in the central tube merely takes up just so much heat as is conducted into it through the metal of the explorer. This heat it brings back through a short india-rubber pipe to a casing containing a thermometer. This thermometer is immersed in the returning current of water and records its temperature. It is graduated by immersing the instrument in known and constant temperatures, and thus the graduations on the thermometer give at once the temperature, not of the current of water, but of the medium from which it has received its heat.

In order to render the instrument perfectly reliable, all that is necessary is that the current of water should be always perfectly uniform, and this is easily attained by fixing the size of the outlet once for all, and also the level of water in the tank. So arranged, the pyrometer works with great regularity, indicating the least variations of temperature, requiring no sort of attention, and never suffering injury under the most intense heat; in fact the tube, when withdrawn from the furnace, is found to be merely warm. If there is any risk of the instrument getting broken from fall of materials or other causes, it may be fitted with an ingenious self-acting apparatus shutting off the supply. For this purpose the water which has passed the thermometer is made to fall into a funnel hung on the longer arm of a balanced lever. With an ordinary flow the water stands at a certain height in the funnel, and, while this is so, the lever remains balanced; but if from any accident the flow is diminished, the level of the water in the funnel descends, the other arm of the lever falls, and in doing so releases two springs, one of which in flying up rings a bell, and the other by detaching a counterweight closes a cock and stops the supply of water altogether.

It will be seen that these instruments are not adapted for shifting about from place to place in order to observe different temperatures, but rather for following the variations of temperature at one and the same place. For many purposes this is of great importance. They have been used with great success in porcelain furnaces, both at the famous manufactories at Sèvres and at another porcelain works in Limoges. From both these establishments very favourable reports as to their working have been received.

W. R. BROWNE

#### THE AGRICULTURAL INSTITUTE OF BEAUVAIS

WE have already referred to the interesting collection exhibited in the Technical School at the Health Exhibition by the Brothers of the Christian Schools. One of the most instructive of their specimen museums is that from their Agricultural Institute at Beauvais.

This Institute was founded in 1855, the late Prince Consort being one of its first patrons. Recently the Agronomical Society of France have extended to it an encouraging hand.

Candidates for admission to the school must be at least sixteen years of age, and must give evidence, either by certificates obtained or by a preliminary examination, of their having successfully studied the recognised branches of a good modern education. The course of instruction extends over a period of three years, and is intended to prepare young men to manage and develop estates and direct all farming operations. Special provision is made, in the third year, for those who wish to qualify themselves for agricultural professorships. The syllabus of subjects is framed by a Board appointed by the prefect of the *département*, and consists of the Director and Professors of the Institute, of the Professor of Agriculture, and the Veterinary Surgeon of the *département*, as also of three other members.

The subjects for the first year are: French language, book-keeping and commercial subjects, elementary algebra and geometry, the fundamental principles of agriculture, rural law and engineering, general zoology, arboriculture, horticulture, physics, chemistry, and linear drawing.

In the second year the students follow more advanced courses of agriculture, zoology, botany, entomology, geology, surveying, levelling, physics, general and analytical chemistry, rural law and engineering, linear drawing, arboriculture, and horticulture.

The instruction for the last year comprises agriculture, arboriculture, horticulture, analytical chemistry, botany,

geology, entomology, applied mathematics and mechanics, and architectural drawing.

Science teaching, to be of any use, must be practical; the authorities of the Agricultural Institute, fully convinced of this, attach great importance to laboratory and field work. In the physical laboratory, the work is exclusively of a demonstrational kind, the students not being required to test the accuracy of their knowledge or their familiarity with instruments by the actual and precise measurement of physical constants. Nor do such measurements appear necessary for the object in view. It is, of course, quite different with chemistry, where skill in quantitative analysis is of the highest value to any one who intends to direct the agricultural interests of a district. The students are consequently trained with much care in those branches of analytical chemistry which bear directly upon the science of agriculture. The study of botany, geology, and entomology is encouraged and stimulated by frequent excursions to the neighbouring country, the specimens brought back being compared, classified, and minutely described in appropriate language.

The school has also a model farm of 325 acres, in which the principal operations of farming are extensively carried on. The students visit this farm at stated hours every week; they are familiarised with the chief implements and agricultural appliances, and are required to take part in all the regular work that may be going on.

The Professors have set aside a number of acres for experimenting upon the conditions most favourable to the growth of the principal cereals. These comparative studies are carried out with the assistance of the students mainly for the purpose of showing them how to practically initiate a scientific investigation of an agricultural nature. The results of these studies are fully described in the *Annales de l'Institut agricole*, a yearly publication of considerable merit. A valuable synopsis of the results obtained by the Director of the School, Brother Eugene, will be found in the Educational Section of the International Health Exhibition, Room 5.

From a recent report, we find that there have been, this year, under cultivation no less than sixty-five kinds of wheat, twenty of oats, ten of barley, eight of rye, besides fields of potatoes, beetroot, cabbage, &c. There are also pasture lands for sheep and cows, and a well-stocked poultry yard.

At the end of each year the students are put through a practical examination, when they are expected to give satisfactory evidence of their competency to deal with the general working of the farm. It is also required by the programme of the Institute that the students shall visit exhibitions of an agricultural character which may be held in the vicinity, and attend with their Professors certain markets and sales of live stock.

The attention of the students is maintained and quickened by requiring them to write, with considerable care, notes of all their courses, as well as detailed reports of what they may have seen in their visits or met with in their excursions. Several volumes of these reports, notes, and theses, together with typical herbaria, specimens of grain and seeds, may be seen in the Exhibition, Room 5.

Besides superintending the museum and giving instruction in the laboratories, the Brothers teach drawing, physics, chemistry, botany, geology, zoology, &c., leaving such subjects as rural jurisprudence and engineering, agriculture, and the like to other eminent professors.

#### IS SALPA AN EXAMPLE OF ALTERNATION OF GENERATIONS?

THE chances against the accidental discovery of a great natural law are so great that we cannot feel surprise that naturalists are slow to believe that Salpa,



the animal in which Chamisso discovered alternation of generations, is not an example of alternation.

The historical associations which render the life-history of Salpa so interesting to the naturalist have induced me to restate briefly my reasons for believing that the solitary Salpa is a female and the chain Salpa a male; since a recent contributor to NATURE ("Recent Morphological Speculations," by R. N. G., in NATURE, May 15, p. 67) rejects my observations for reasons which a little examination will show to be inconclusive.

The author characterises my opinion as "Brooks' theory," but it is neither a theory, nor was I the first to describe the phenomenon in question. Embryological observations by Kowalevsky must be received by all

the solitary Salpa is a female, and the chain Salpa a male. Our knowledge of Pyrosoma and of other Tunicates certainly leads us to believe that Salpa is the descendant of a hermaphrodite ancestor, but it proves nothing more.

The fact that nearly all the Arthropods are bisexual does not disprove the hermaphroditism of Balanus. It simply shows that Balanus is the modified descendant of bisexual ancestors.

While the life-history of Pyrosoma cannot be quoted to disprove the statement that the solitary Salpa has an ovary, it can help us to understand the way in which the present life-history of Salpa has been acquired, and thus show that my own view is not very anomalous after all.

As the phenomena are very complex, I have attempted to exhibit the leading features by diagrams, and Fig. 1 shows the points of greatest importance in the life-history of Pyrosoma.

The egg gives rise, by a process which does not here concern us, to several sexual animals, one of which is represented by A in Fig. 1. It has a testis, T, and an ovary, O, which consists in part of "generative blastema," and, in part, of ova in various stages of growth. It is, therefore, a hermaphrodite. One of the ova, E, is very much larger than any of the others. This hermaphrodite,

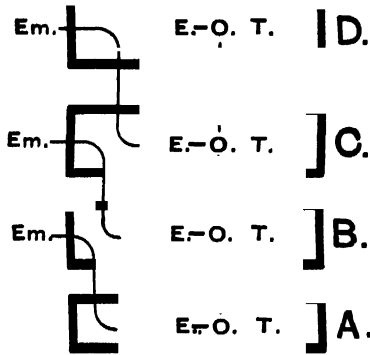

Fig. 1

naturalists with the greatest respect, and I therefore call the attention of R. N. G. to the fact that this great observer published, while my first paper was in the press, the following account of the life-history of Salpa (see *Arch. f. Mik. Anat.* xi. 604):—"Bei den Salpen giebt es bekanntlich zwei Generationen, in der einen entwickelt sich der aus vielen eikeimen bestehende Eierstock, welcher in den Stolo hineingeht, und sich hier zu je einem Eie vertheilt, sodann die einzelnen Knospen resp. Kettensalpen in welchen weiter aus diesem Eie ein Embryo entsteht, wieder mit einem aus mehreren Eikeimen bestehende Eierstock."

No one will question the statement that the animal in whose body an ovum is produced is the mother of the

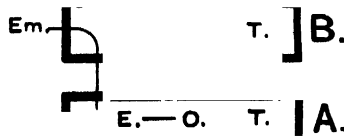

Fig. 2

embryo to which this ovum gives rise, and if the egg which is fertilised in the body of the chain Salpa is developed, as Kowalevsky and I have stated, in the body of the solitary Salpa, the latter is certainly a female, and as no one has ever observed the production by a chain Salpa of more than one embryo, either from an egg or by budding, there is no true alternation of generations.

This view is in no sense a "morphological speculation," nor should it be spoken of as "Brooks' theory." It is either an observed fact or an erroneous statement, and its untruth can be proved only by observation.

R. N. G. lays much stress upon the life-history of Pyrosoma, a closely related but less modified form, and regards it as an "indirect negation" of my statement that

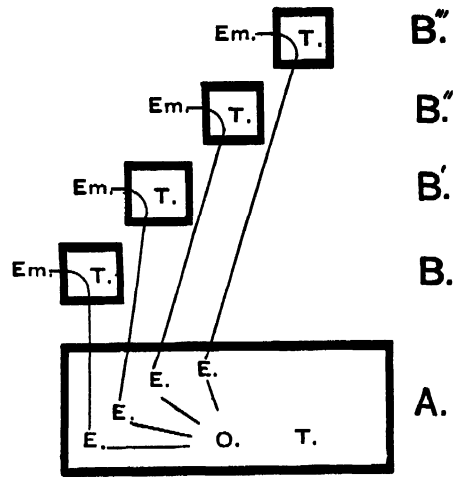

Fig. 3

A, produces a second, B, by budding, and during this process part of the "generative blastema" from the ovary of A passes into the body of B, and forms its ovary, O, which here produces one fully developed ovum, E, and a number of small ones. As B has a testis, T, it is a hermaphrodite like A.

The single mature ovum, E, of A, also passes into the body of B, where it is fertilised and gives rise to an embryo, EM, which undergoes development within, and finally escapes from, the body of B, although A is its mother, because the egg which has produced it was formed in the ovary of A before the body of B was formed by budding.

B then gives rise by budding to C, and the single mature egg of B passes into the body of C, where it is fertilised, and gives rise to an embryo.

Part of the "generative blastema" of B's ovary passes into the body of the bud C, and becomes an ovary, O, which again gives rise to one mature ovum, E; and C produces another bud, D, and discharges into it one ripe ovum and part of the ovary in the same way, and so on indefinitely. As C and D have testes like A and B, they are all hermaphrodite.

After the bud B has become independent of A, another ovum is matured in A's ovary, another hermaphrodite bud

is produced, and so on indefinitely, and each hermaphrodite bud produces in succession an indefinite series of similar buds.

Now let us imagine a limit to this indefinite series of buds, and examine its effect.

Suppose that, while B retains its power to produce in succession an indefinite series of C's, the C's lose this power. As the function of the ovary of C is to provide the "generative blastema" for the ovaries of the series of D's, and to mature the eggs E, which are to be fertilised and developed within the bodies of the D's, it is plain that with the loss by the C's of the power to reproduce by

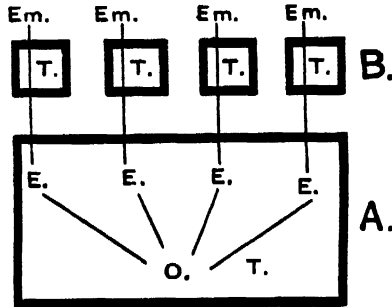

Fig. 4

budding, the ovary will be left without function, and we should therefore expect it to disappear. C would then become simply a male, but it would while young contain a single unfertilised egg, EM, derived from the ovary of B.

If the power to bud were lost by the first generation of buds, B, we should have the condition of things which is shown in Fig. 2, where the hermaphrodite A produces a male bud, B, and discharges the egg E into its body, there to be fertilised and developed into the embryo EM. A has, however, the power to repeat this process indefinitely, and to produce in succession a series of buds of the generation B, and the life-history is therefore now exactly shown in Fig. 3.

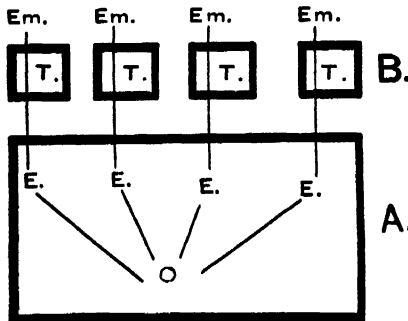

Fig. 5

Now suppose that, instead of appearing in succession, a number of buds of the generation B are formed at the same time, we shall then have the phenomena shown in Fig. 4, where a number of eggs, E, E, E, E, are matured simultaneously in the ovary, O, of the hermaphrodite A, and are discharged while still unfertilised into the bodies of the male buds, B, B, B, B, there to give rise to the embryos, EM, EM, EM, EM.

This is very nearly what we have in Salpa, where very many chain Salpæ are produced at one time. As these have no power to reproduce by budding, they have lost their ovaries, although each of them, when it is born, con-

tains, like the buds of Pyrosoma, a single unfertilised egg, derived, according to my observations and those of Kowalevsky, and according to the analogy of Pyrosoma, from the ovary of the solitary Salpa A, Fig. 5.

The solitary Salpa is therefore a true female, and as it has lost the testis which, according to the analogy of Pyrosoma, its ancestors must have possessed, it is a true female and not a hermaphrodite.

We therefore have in place of the indefinite series of hermaphrodite buds of Pyrosoma, a single generation of male buds, each of which receives, like the buds of Pyrosoma, a single mature ovum from the ovary of its gemmiparous ancestor.

While the series of stages which are here described may not correspond exactly to the actual phylogeny of Salpa, it certainly shows that our knowledge of Pyrosoma cannot be quoted as an "indirect negation" of my view; for it shows that the analogy of Pyrosoma would lead us to look to the ovary of the solitary Salpa for the origin of the egg which is fertilised and developed within the body of the chain Salpa.

All observers agree that the so-called "ovary" of the chain Salpa consists of a single egg, which is fertilised while the animal which carries it is very young and almost embryonic, and all agree that normally no more eggs are produced by the chain Salpa. A "rudiment of an ovary, which only consists of one fully developed ovum" is certainly not an ovary at all, but an ovum, for the origin of which we must search elsewhere, and Kowalevsky's observation as well as my own show that it originates in the ovary of the solitary Salpa.

As all observers agree that the chain Salpa has a testis, and that it normally contains only one egg, it is certainly a male; and as all observers agree that the solitary Salpa has no testis, while Kowalevsky and I agree that it has an ovary, we must regard it as a female, and we therefore have, instead of an instance of alternation, a very remarkable example of sexual difference.

There seems to be only one way to escape this conclusion;—that is, by denying that the structure which Kowalevsky and I have described as an ovary is an ovary at all.

Salensky is an advocate of this view, and claims that my so-called ovary is simply a mass of embryonic cells destined to give rise to the branchial sacs, as well as the ovaries of the chain Salpæ, but I have shown in a recent paper in the *Zoologischer Anzeiger* that the branchial sacs of the chain Salpa originate from quite a different part of the stolon, and that the ovary contains cells which are in no sense embryonic or unspecialised, since they have all the characteristics of ova. In a paper which is now ready for publication, I shall give photographs of sections which prove this point beyond question.

R. N. G. gives, as another reason for rejecting my view, the fact that Salensky has found a second ovary in a chain Salpa.

This is clearly exceptional, for all observers agree that no such second ovary normally occurs, nor has Salensky given conclusive proof that the cells which he observed were ova at all, as he has not observed their development. Out of many thousand sections which I have examined, I have found three chain Salpæ which had received two ova from the ovary of the solitary Salpa instead of one, and if Salpa is descended from a form like Pyrosoma, it is quite possible that a chain Salpa may occasionally receive with its ovum part of the ovary, and that this may give rise to other ova, but the discovery of such an abnormal Salpa would not prove that the normal chain Salpa is hermaphrodite, even if it could be shown that these eggs completed their development and became embryos.

In conclusion, I wish to point out to R. N. G. that, inasmuch as the writer who attempts to generalise from the observed phenomena of science for the benefit of the public should use every precaution to insure accuracy in

the statement of facts, he will do well to examine his authority for his statements that I have called the *solitary Salpa a nurse*; that I have described a *Cunina* in which the "hydroid produces medusæ by gemmation;" and that I believe "that the solitary *Salpa* is hermaphrodite."

Baltimore, July 14

W. K. BROOKS

#### COLONIAL AND FOREIGN REPORTS

**T**HE annual reports of colonial botanical gardens, Government plantations, museums, &c., form at the present day no inconsiderable item of the literature of scientific progress in different parts of the world which constantly crowd an editor's table. These records become, year after year, of increasing importance as well as of increasing bulk, and it is right that their contents should be better known, so that they may become useful, and this can only be done by a wide distribution of the reports themselves, and attention drawn to them by other publications.

Taking a few of these reports, which have recently come to hand, in the order of their issue, we first find one from Wellington, New Zealand, under the following title, "Eighteenth Annual Report on the Colonial Museum and Laboratory," together with the "Fourteenth Annual Report on the Colonial Botanic Garden, 1882-83." This Report treats of various branches of science, and, as might be expected, geology has its full share. In the observatory the principal work is said to have been the observation of the transit of Venus, Dr. Hector's account of his observation, which, he says, was written out within an hour after the transit, being given as an appendix. Under the head of Botanic Garden, after describing some successful experiments in planting wattles (species of *Acacia*), Dr. Hector refers to experiments in the cultivation of *Sorghum*, which, however, are said not to have been continued in the garden, but in the northern part of the colony, the results were very favourable, proving that quite as large a percentage of crystallisable sugar can be obtained in New Zealand as in America. "Recent improvements," it is said, "have been made in the machinery, and by the use of a vacuum evaporating pan all the causes of the former miscarriage in the production of the sugar appear to have been removed, so that there is every prospect of the growth of the *Sorghum* becoming an important industry in the north of New Zealand." A most interesting and important feature of the year is said to be the sudden expansion of the cultivation of hops in the colony. In Nelson it is shown that the cultivation has been most successful, and in the neighbourhood of Wellington the hop also grows well. The plants are subject more or less to attacks from the red spider and what is known as the plant louse, but they have not yet committed any great damage.

Mr. Morris's "Annual Report of the Public Gardens and Plantations for the year ended September 30, 1883," shows that the usual operations of the department have been fully maintained, while the "chief scientific work of the year has been connected with the collection and determination of numerous native plants of the island which have been added to the Department Herbarium, and the large addition of others to the growing collections." Referring to the attacks by insects on the sugar cane, Mr. Morris points out that the spasmodic or intermittent character of the attack is in accordance with their general habit in all parts of the world; "but," he says, "it is well for us to note their appearance and disappearance with great care, in order that we may thereby be prepared for their attacks, and reduce the amount of damage they do to our crops to a minimum."

The indiscriminate destruction of small birds in the island has attracted some attention, and measures have been suggested whereby it may be checked or perhaps stopped.

The mungoose, which has been imported from India to destroy rats on sugar estates, is stated to be increasing very rapidly, not only on sugar estates, but on the highest mountains along the shore, and even amidst swamps and lagoons. The sugar planters have greatly benefited by its introduction, rat-eaten canes being now scarcely known. The negro settlers and persons not connected with sugar estates complain of its ravages amongst their poultry, fruit, and vegetables. Mr. Morris says, however, that poultry is still fairly plentiful in country districts, and from his experience of the mungoose in confinement, the creature is not likely to eat either sugar cane, banana, or field vegetables, except under the influence of extreme hunger, which would not occur so long as there are rats, mice, lizards, and other small animals to feed on. "The mungoose is, however," Mr. Morris says, "disturbing greatly the distribution of animal life in the island; and the harmless yellow and other snakes, lizards, ground-hatching birds, the interesting cony, and many members of our indigenous fauna, are likely to become extinct at no distant period."

Under the head of cultivation and distribution of economic plants Mr. Morris reports progress in many new products. It is not encouraging, however, to find that the cultivation of ginger in Jamaica appears to be dying out, due "to the smaller yield of plants cultivated so persistently on the same land, to the uncertain nature of the crop, no less than the difficulty experienced in many districts in curing it properly." Jamaica ginger has hitherto held a prominent position in the market as to quality, and it is a pity that its reputation should become a thing of the past.

The next report before us is that of Dr. Schomburgk, and treats of the "Progress and condition of the Botanic Garden and Government plantations" at Adelaide, South Australia. A similar work seems to be going on here as at most other colonial gardens at the present time, namely, the distribution of native, and the acclimatisation of foreign plants, chiefly of economic value. The Gardens seem to be very popular, as well as the Museum of Economic Botany, which is a comparatively new institution to Adelaide. Two appendices are added to Dr. Schomburgk's report, one consisting of a "Catalogue of Plants added during 1883 to those under cultivation in the Botanic Garden," arranged according to their natural orders, and the other a "List of *Palmae*, *Bromeliaceæ*, *Filices*, and *Lycopodiaceæ*, cultivated in the Botanic Garden." The report is illustrated by eight views in the Gardens.

A Report of the Committee of Management for 1883 of the Technological Industrial and Sanitary Museum of New South Wales shows that a great deal of progress has been made in extending the utility of the Museum during the year. The Museum, which seems to have been opened so recently as December last, bids fair to become of very great service to the colony. One paragraph in the Report says, "Special endeavours are being made to collect the raw products and samples illustrative of the industries and manufactures of the Australian colonies, and the Committee have already secured a considerable number of native vegetable and mineral products and a comprehensive series of specimens of wood."

The "Annual Report of the Royal Botanic Garden, Calcutta, for the year 1883-84," and that of the Government Cinchona Plantations in Bengal for the same period, are, as usual, very creditable to Dr. King as superintendent. Dr. King's reports are always concise and interesting records of admirable work both at the Botanic Garden and at the cinchona plantations, and those before us show that in the former a good deal of consideration has been paid during the year to the extension of plants of real commercial value, such, for instance, as paper materials, including the sabai grass (*Pollinia eriopoda*, Hance), and the

paper mulberry (*Broussonetia papyrifera*, Vent), also fibrous plants, including the Rhea, or China grass (*Boehmeria nivea*, W. and A.). Much progress has been made in arranging the specimens in the new building which has been provided for the herbarium, and numerous contributions have been received both to the herbarium and to the gardens. In the Report on the cinchona plantations Dr. King gives details of the year's crop, of the expenditure for the year, and of the progress of the several forms or varieties. At the factory the total out-turns for the year was 8714 lbs. of febrifuge, 250 lbs. of which were of the new crystalline preparation, which closely resembles the ordinary febrifuge, but, on examination, the grains are seen to be small crystals; it differs, however, in constitution from the old febrifuge, inasmuch as it contains none of the amorphous alkaloid which is the ingredient in that preparation which causes the nausea which sometimes follows its administration. The efficiency of the staff both in the Calcutta Gardens and at the cinchona plantations is indicated by the testimony which Dr. King, with his usual frankness and consideration, bears to the ability of his subordinates.

From the Botanic Garden, Hong Kong, Mr. Charles Ford, the Superintendent of the Botanical and Afforestation Department, reports, under date April 30, 1884, of the department under his charge. A good many plants both of commercial and horticultural interest have been grown with more or less success, including the carob tree (*Ceratonia Siliqua*) of Southern Europe, the Chinese tea oil tree (*Camellia drupifera*), the Chinese varnish tree (*Aleurites vernicia*), and many others. A very interesting account of a visit to the Lo-fau-shan Mountains and a list of the plants collected is given in this Report.

### NOTES

HER MAJESTY'S GOVERNMENT, on the recommendation of the Lords of the Committee of Council on Education, have given their adhesion to the International Geodetic Association, and have nominated the undermentioned gentlemen as delegates of the United Kingdom to the Association, viz.:—The Director-General of the Ordnance Survey (for the time being), Col. A. R. Clarke, R.E., F.R.S., the Astronomer-Royal, the Hydrographer of the Navy (for the time being), General J. T. Walker, R.E., C.B., F.R.S.

Two academic honours have recently, *Science* states, been conferred in the United States upon scientific men, which are worthy of note because more rare and costly than such distinctions usually are. At New Haven, on the day before commencement, a bronze statue of Prof. Silliman, for more than fifty years a teacher of chemistry, mineralogy, and geology in Yale College, and the founder of the *American Journal of Science and Arts*, was placed on its pedestal near the new chapel. The other honour is that of a medal struck at the U.S. Mint in Philadelphia, at the request of the colleagues and friends of Prof. Sylvester, to commemorate his residence in Baltimore during a period of seven years, marked, among other things, by the establishment of the *American Journal of Mathematics*. The medal, in size and general aspect, is not unlike that which was struck in commemoration of the life of Agassiz. On one side is an accurate and spirited portrait of the mathematician, with the name Sylvester; on the reverse a Latin inscription commemorates the fact that he was for seven years Professor of Mathematics in the Johns Hopkins University—from 1876 to 1883. The original medal in gold was sent to Prof. Sylvester, in his new home in the University of Oxford; a duplicate in silver was retained in Baltimore, and a few impressions in bronze have been distributed among his scientific friends and correspondents.

*Science*, in referring to the recent researches of Koch, states that work of value upon the subject of micro-organisms is not done in this country (the United States), nor will it be until some such encouragement is offered to investigators as is the case in France and Germany. This kind of research requires the rare combination of many forms of training, added to a critical, analytical, and judicial mind. These we can have; but until the facilities for the work are offered, until the necessity for personal sacrifice and self-denial is done away with, we can hope for no better work in the future than has been done in the past; in other words, what is first needed in order to place our own investigations upon an equality with those of the two countries mentioned above, is a thoroughly-equipped, fully-endowed laboratory, with a strong corps of well-trained and salaried officials. These remarks might very well have been written concerning our own country, and the official mission of Dr. Klein to India is a tardy recognition by our Government of the necessity of State intervention if scientific research is to be pursued with any hope of speedy and substantial practical results. The true way to encourage such inquiries (*Science* truly says) lies in the establishment of a Commission composed of men thoroughly trained and qualified for the work, and then to treat it as the German Government has treated its Cholera Commission, that is, to give it full powers and funds to allow the prosecution of its labours to the end.

THE death is announced at the age of seventy-five years of Sir Erasmus Wilson, the eminent surgeon.

THE death is also announced of Mr. John Aitken, J.P., of Urmoston, well known as a geologist in the northern counties. Deceased was born in 1820. He was early distinguished for his application to scientific matters, and he twice filled the office of President of the Manchester Geological Society. He wrote for the Society's papers a number of articles relating chiefly to the geology of Clitheroe, Bacup, and Holcombe, and he also contributed to the *Geological Magazine* and the *American Journal of Science*. He furnished for Newbiggin's "History of the Forest of Rossendale" the geological section relating to that district.

SIR JOHN LUBBOCK has been compelled, for personal reasons, to abandon his intention of attending the meeting of the British Association at Montreal.

A COMMITTEE was appointed in 1882 at the Montreal meeting of the American Association for the Advancement of Science, "to confer with committees of foreign associations for the advancement of science with reference to an international convention of scientific associations." The committee consists of Dr. T. Sterry Hunt, Mr. Alexander Agassiz, and Prof. Simon Newcomb. If the British Association responds, as has been suggested, by also appointing a committee, the official channels for the interchange of opinion between the two national bodies will be suitably established on both sides. We (*Science*) are unable to make any authorised statement as to what the American committee has done or proposes, but its membership justifies the conviction that it is capable of efficient action, wisely planned. We shall await their report with interest.

THE Committee appointed by the Government at M. Pasteur's request to verify his experiments in the treatment of hydrophobia has just presented its first report. M. Bouley is president, his colleagues being MM. Beclard, Paul Bert, Tisserand, Villemin, and Vulpian. The Committee states that M. Pasteur's experiments have been entirely borne out. Inoculation with the attenuated virus of hydrophobia gives a dog immunity from the disease, just as similar treatment preserves a sheep from *charbon*. All the twenty-three dogs submitted by M. Pasteur as having been thus inoculated have resisted the strongest virus on inoculation, whereas the majority of the nineteen non-inoculated dogs have suc-

cumbed. Of the latter, six were bitten by mad dogs, three of them becoming mad, eight were subjected to intra-venous inoculation, all becoming mad, and five to inoculation by trepanning, all becoming mad. The result is decisive; but the Committee will now inoculate a large number of fresh dogs, and will compare these with an equal number of dogs not inoculated. It will likewise investigate the question whether after a dog has been bitten inoculation with the attenuated virus will prevent any consequences from the bite. M. Pasteur will lay before the International Health Congress at Copenhagen results which, as the Committee remarks, "are so honourable for French science, and give it a fresh claim on the gratitude of mankind."

A CORRESPONDENT living about two hundred yards from the river at West Chelsea complains that mosquitos first appeared sparingly in the middle of July, but are now almost nightly visitors. There is too much reason to fear, he states, that they are thoroughly acclimatised in this part.—Mosquitos and gnats are synonymous terms. Whenever the heat is greater than usual we constantly receive notices similar to the above. Possibly it renders the gnats more vicious, and at the same time the object of their attacks more irritable. Gnats (mosquitos) inhabit water (not sea-water) in their early stages, and from this reason it is practically impossible to import them, unless intentionally. The conditions at West Chelsea at the present moment are particularly favourable to the welfare of gnats (see article "Mosquito" in the new edition of the "Encyclopædia Britannica").

THE eighth International Medical Congress, of which the King of Denmark has consented to be the patron, was opened on Sunday in the Grand Hall of National Industry, Copenhagen, in the presence of the King and Queen of Denmark, the King and Queen of the Hellenes, the Crown Prince and Crown Princess of Denmark, and the rest of the Royal Family, the Danish Ministers, the Corps Diplomatique, the official authorities, civil and military, and delegates from Great Britain and Ireland, Germany, France, Russia, Austria, Holland, Belgium, Greece, Switzerland, Japan, New York, Columbia, Kentucky, and California. Addresses were delivered by the President, Prof. Panum, the Secretary, Dr. Lange, Sir James Paget, Prof. Virchow, and Prof. Pasteur. The assembly consisted of about 1500 members.

EARTHQUAKES have been frequent and widespread during the past few days. The inhabitants of the towns and villages along the whole range of the Alban hills were alarmed at two a.m. on August 7 by a sharp shock of earthquake, followed by another at a quarter past three. The direction taken by the wave was through Velletri, Nemi, Ariccia, Albano, Castel Gandolfo, and Rocca di Papa and Frascati. The shocks were most severely felt at Rocca di Papa, but no damage was done beyond the felling of two chimneys at Ariccia. At half-past three a severe shock, quickly followed by another, was distinctly felt at Rome, and that which shook the Alban hills extended also as far as Porto d'Anzio, on the coast.

AN earthquake shock shook the most solid buildings in New York at two o'clock on Sunday afternoon, and produced a sensation like that on board a steamer under way. At Brooklyn the residents were frightened into running out of their houses. The earthquake suddenly moved along the Alleghany Mountains and their eastern slopes, from Virginia to Vermont, in a direction from south-west towards north-east, extending over the entire country from the mountains to the ocean. The most southerly city in which the shocks were noticed was Washington, and the most northerly Brattleborough, Vermont. Two distinct shocks, each of about two seconds' duration, with an interval of about four seconds, were generally felt, while in New York and further eastwards a slight third shock was experienced a few minutes afterwards. The earthquake was ob-

served at nine minutes past two o'clock in the afternoon at Philadelphia, and somewhat later to the eastward of this city. It was most severe in New York City, Connecticut, and Boston. The vibration was slighter elsewhere.

SLIGHT earthquake shocks, recurring at short intervals, have recently been felt at Massowah.

PROF. MILNE, of Tokio, Japan, writing to the *Times* on the subject of the Essex earthquake, concludes as follows:—"Before earth movements can be generally understood, it is necessary that they should be observed as other natural phenomena are observed. A reason that has been expressed against the establishment of seismometers in British observatories is that in Britain earthquakes are a rare occurrence. Such a reason appears to arise from an imperfect acquaintance with the phenomena to be observed. Earth-tremors, which are minute earthquakes, may be observed in Britain every day. Messrs. George and Horace Darwin have shown that such movements are of common occurrence in Cambridge. Then there are the slow earthquakes or earth-pulsations, like those which I have from time to time observed in Tokio. Whether these exist in Britain cannot be known until they are sought for. That they existed on the outer rim of the area where the Essex earthquake was felt is tolerably certain. It is also certain that shortly after great earthquakes—as, for instance, some which have shaken South America—pulse-like motions have been observed in the bubbles of astronomical levels at places as distant as St. Petersburg. When we consider that we are observing meteorological changes with which earth-tremors have a close relationship, that we observe the tides, magnetic and electric changes in our earth, and the escape of gas in our mines, with all of which earth-movements may be closely associated, when we possess so many earthquake-shaken colonies, and send our Navy and mercantile marine to all the earthquake countries of the world, it would certainly not be an unreasonable undertaking for us to investigate the ill-understood phenomena which continually occur beneath our feet. We study our oceans, our atmosphere, the sky above us, and, I may add, the ice at our poles, while the changes in the earth on which we live are almost neglected."

MESSRS. COTTEAU AND KORTHALS, members of the French Mission sent by the Minister of Public Instruction to explore the Krakatoa volcano, write from Batavia on June 2 that the object of the expedition has been fully realised. Soon after their arrival at Batavia on May 14, the Dutch Colonial Government placed at their disposal a small steamer, on board of which they started for the Sunda Strait on the 21st. Along the west coast a well-marked line, running at an elevation of from fifty to eighty feet above sea-level, indicated the limit reached by the terrible wave that spread disaster far and wide towards the end of August 1883. The plantations had been swept away, and all the houses of this populous district, together with the town of Anjer, had completely disappeared. On the 23rd the steamer cast anchor at the head of Lampong Bay on the south coast of Sumatra, whence a visit was paid to the Telok-Betong district. Here the extensive and thickly-settled coastlands had assumed the aspect of a desolate swamp, relieved here and there by a few bamboo huts recently set up. Nearly three miles inland lay the steamer *Boronu*, which had been borne on the crest of the wave into the forest, where it now forms a sort of bridge across a small stream. On the 25th the formerly fertile and densely-peopled islands of Sibuku and Sibesi were successively visited and found to be entirely covered by a deposit of dry mud several yards thick and furrowed by deep crevasses. Of the inhabitants, all had perished to a man. Continuing the trip on the 26th to Krakatoa itself, the mission was surprised to note the complete disappearance of the three islands of Steers, Calmeyer, and the islet east of Verlaten, which had risen above the

surface at the time of the eruption, but which are now covered by 12 or 14 feet of water. Approached from the north Krakatoa seemed wrapped in a whitish smoke, vapours apparently issuing from fissures on this side, and settling on the summit, which is at present 2730 feet high. It was at this point that the great convulsion took place on August 26-27, when about half the island was blown into the air. A closer examination showed that what had been taken for fissures were simply ravines, and the vapours were clouds of dust stirred up by stones incessantly rolling down the steep slope of the mountain. This was accompanied by a continuous noise like the rattling of distant musketry, while stones of a certain size were seen whirling in the air, then falling and ricocheting down to the sea. Notwithstanding the evident danger, the boats of the expedition succeeded in approaching the foot of the volcano and collecting specimens of the rocks at several points. The same afternoon they reached the island of Verlaten, formerly one mass of verdure, now uniformly covered with a layer of solidified ashes about 100 feet thick. The deep crevasses, widened by the erosion of tropical rains, give the aspect of a glacier to this island, which has been doubled in extent by the deposits from the last eruption. Returning next day to Krakatoa the members of the expedition found a safe landing place, where it was possible to study the nature of the rocks and other matter ejected by the volcano. No trace was found of animal or vegetable life, with the exception of a solitary little spider, and the solidified bed of mud and ashes was estimated in some places to have attained a thickness of from 200 to 260 feet. A black rock rising a few yards above the surface about a mile and a quarter from the present shore, represents a last fragment of the portion of the island engulfed during the eruption. After touching at Lang Island, which presented much the same appearance as its neighbour Verlaten, the expedition concluded its survey of the Strait, landing on the 28th at Merak at the north-west extremity of Java. Merak had shared the fate of Anjer, and the coast-line in this district had been considerably modified. The expedition returned to Batavia on the 29th, after determining two new facts—the disappearance of the islands upheaving during the eruption, and the total cessation for the present of all volcanic activity at Krakatoa.

On Saturday, August 9, M. Renard, Captain of Engineers, and M. Krebs, Captain of Infantry, made an experiment with the directing balloon which they are constructing at the expense of the French Government in the aeronautical works of Chalet Meudon. The balloon, which is about 60 metres in length and 10 metres in diameter, carries a long platform of about 40 metres in length and 3 metres in breadth. At one of its extremities sit the aeronauts in a car. The aerial helix and a gramme magneto-electric machine are placed at the other. The voltaic elements and ballast are disposed on the platform. The wind not being strong, the aeronauts ascended and tried first the effect of their rudder, which is a sail of about 10 metres square. The results were very satisfactory indeed, and the steering of the balloon remarkably quick and easy. The balloon was drifted by the wind from Chalet Meudon to Petit Bicetre, above the Meudon woods. Then the aeronauts, wishing to return home, adjusted the rudder and the experiment succeeded wonderfully; in five minutes the distance, which is about two miles, was run. The balloon landed just before the doorway of its wooden house. This experiment will be tried again in a few days for a longer distance. The system practised by the French officers is a slight modification of the one used by Gaston Tissandier and described in *NATURE*. The French officers were originally adherents of the helix moving round an axis traversing the balloon, but the result of the experiments published by Tissandier seems to have modified their opinion.

M. F. LHOSTE, Secretary of the Académie d'Aérostation Météorologique de France, who started in a balloon from Bou-

logne on Thursday last, descended at Romney, fifteen miles from Folkestone, at half-past eight o'clock the same evening. M. Lhoste left Boulogne at seven p.m. He encountered three distinct currents of air, one of which carried him in the direction of the North Sea. The descent was effected without difficulty.

ALREADY a prospectus has been issued of the International Exhibition of Inventions and of Musical Instruments, to be opened in May 1885, in the buildings now standing in the gardens of the Royal Horticultural Society at South Kensington. The Exhibition will have all the advantages of royal patronage and support. Her Majesty the Queen becomes patron, and the Prince of Wales assumes once more the duties of president. The Executive Council, appointed by the royal president, having for chairman Sir Frederick Bramwell, F.R.S., vice-president of the Institute of Civil Engineers, and for vice-chairman the Marquis of Hamilton, is composed of Sir Frederick Abel, C.B., Mr. I. Lowthian Bell, F.R.S., president of the Institution of Mechanical Engineers, Mr. Birkbeck, M.P. (honorary treasurer), Colonel Sir Francis Bolton, Sir Phillip Cunliffe-Owen, C.B., C.I.E., Prof. Dewar, F.R.S., Mr. Joseph Dickenson, Sir George Grove, D.C.L., Mr. E. W. Hamilton, Mr. Henry E. Jones, M.Inst.C.E., Mr. W. H. Preece, F.R.S., Sir E. J. Reed, M.P., F.R.S., Prof. Chandler Roberts, F.R.S., Mr. John Robinson, Mr. Warrington W. Smyth, F.R.S., Dr. Stainer, and Mr. R. E. Webster, Q.C., with Mr. Edward Cunliffe-Owen as secretary. Mr. J. R. Somers Vine will be the City and official agent. The idea upon which the Exhibition is planned is not to bring together a mere collection of models of inventions, but rather to illustrate the progress which has been made in the practical applications of science during the past twenty years. In order to carry out this intention the Council will, as far as possible, confine the exhibits to processes and appliances, products being admitted only where they are themselves novel or where their introduction is required to make the purpose or advantages of that which is new in any process more interesting and intelligible. It is not proposed to allot space for manufactured goods unaccompanied by any illustrations of the process of manufacture. Generally it may be said that, as far as is practicable, inventions will be shown by models, with, in the case of models of entire machines, actual specimens of the portions improved under the exhibitor's patent, and when the invention relates to parts only the whole machine will not be admitted unless indeed the improvement effected cannot be sufficiently shown without the exhibition of the entire apparatus. The limitations of space which make these restrictions necessary, also compel the Council to decline, unless in exceptional circumstances, to receive objects which have already been shown in the Smoke Abatement Exhibition, 1881, in the Fisheries Exhibition, 1883, or in the present Health and Education Exhibition, and it is thought that the annual shows of the Royal Agricultural and kindred Societies have served so well to exhibit inventions bearing upon agriculture that it will suffice to present a few typical examples (and these models or diagrams) of each class of improvements effected during recent years.

THE U.S. National Academy of Sciences recently received a gift of 8000 dollars from the widow of the late Dr. J. Lawrence Smith. The deed of trust has now been executed, and provides that the interest of the fund shall be used in striking a gold medal of the value of 200 dollars, to be called the "Lawrence Smith Medal," and to be awarded by the Academy, not oftener than once in two years, "to any person in the United States of America, or elsewhere, who shall make an original investigation of meteoric bodies, the results of which shall be made known to the public, such result being, in the opinion of the National Academy of Sciences, of sufficient importance and benefit to science to merit such recognition."

Any sums which may accumulate from the interest of the fund, above what is required for the purposes specified, are to be used "in aid of investigation of meteoric bodies, to be made and carried on by a citizen or citizens of the United States of America."

THERE being a notable difference between the determinations of specific weight of the normal hydrate of sulphuric acid, H<sub>2</sub>SO<sub>4</sub>, which have been made by Marignac in 1853 and 1870, and later on by MM. Schertel, Kohlrausch, Lunge, and Naëff, Prof. Mendeléeff, aided by M. Pavloff, has recently determined it again with all possible accuracy, and communicated the results of his determinations to the Russian Chemical Society (*Journal*, vol. xvi. fasc. 5). The hydrate was crystallised four times, the operations being made in a perfectly dry atmosphere of carbonic acid. Out of 6 kilogrammes, a remainder of only 300 grammes was received. The thus prepared hydrate melted at 10°·1 to 10°·6, and an accurate titration of it gave the following figures: 81·71, 81·52, and 81·58, that is, on the average, 81·6 per cent. of SO<sub>3</sub>, the theoretic percentage deduced from the chemical formula being 81·64. The specific weight of the hydrate has been determined with great accuracy, and the average result, with all necessary corrections, was 1·83295 at 19°·02. The reduction to 15°, as compared with water at 4°, being made with Marignac's data for dilatation, the final result will be 1·8371, which figure differs only by 0·0001 from that of Marignac, and widely differs from those of Kohlrausch, Lunge, and Naëff.

WHEN submitting the Baku naphtha to fractional distillation, carried on at each 2°, Prof. Mendeléeff had shown that the specific weight of the products of distillation, while rising on the whole together with temperature, decreases however three times, namely, between 55° and 62°, between 80° and 90°, and between 105° and 110°. He shows now, in a recent communication to the Russian Chemical Society (*Journal*, vol. xvi. fasc. 5), that this is not a peculiar feature of the Baku naphtha, but that the same decrease of specific weights is displayed also by American naphtha, if this last be submitted to fractional distillation at each 2°, and that the phenomenon is produced at nearly the same temperatures. The products that boil below 60° were insufficiently represented in Prof. Mendeléeff's samples; but from 60° (where the specific weight, reduced to 17°, like all following, was 0·6642) until 124° (where it was 0·7322), there are two decreases of specific weight. Thus, at 80° it was 0·7347, but only 0·7069 at 92°, that is, the same as at 75°. After that it increases until 104°, where it reaches 0·7543; but it soon decreases for a second time, and at 115° to 117° it reaches 0·7270, that is, the same figure as it had between 85° and 98°. Beyond 117° it continues to rise. Both kinds of naphtha—Caucasian and American—however different their origin, thus display the same phenomena at nearly the same temperatures; the corresponding specific weights, however, are not the same; the portion at 80° has, in the Baku naphtha, a specific weight of 0·7486, and only 0·7347 in the American; and at 100° the respective densities are 0·7607 and 0·7380. The amounts of substance distilled at each temperature are also different. The researches will be continued in Prof. Mendeléeff's laboratory.

WE have been requested to state that at the meeting of the Essex Field Club, referred to in last week's NATURE (p. 343), the natural history and archaeological conductor who addressed the Club on the "salting mounds" and other subjects was Mr. Henry Laver, F.L.S., of Colchester.

THE additions to the Zoological Society's Gardens during the past week include a Bonnet Monkey (*Macacus sinicus* ♂) from India, presented by Mr. T. S. T. Tregellas; a Striped Hyæna (*Hyæna striata*) from North Africa, presented by Sir John H. Drummond Hay, K.C.B., C.M.Z.S.; three Greater Sulphur-

crested Cockatoos (*Cacatus galerita*), three Leadbeater's Cockatoos (*Cacatus leadbeateri*), a White-backed Piping Crow (*Gymnorhina leuconota*) from Australia, a Red-sided Eclectus (*Eclectus pectoralis*) from New Guinea, a Blue and Yellow Macaw (*Ararauna*) from South America, six Amherst Pheasants (*Thaumalea amherstia*) from China, eight Himalayan Monauls (*Lophophorus impeyanus*) from the Himalayas, two Javan Peafowls (*Pavo spicifer* ♂♂) from Java, presented by Mr. Charles Clifton, F.Z.S.; a Rough-legged Buzzard (*Archibuteo lagopus*), British, presented by Sir R. Payne Gallwey, Bart.; a Cockateel (*Calypsitia nova-hollandia*), a Rose-Hill Parrakeet (*Platycercus eximius*) from Australia, presented by Mr. J. W. Dixon; a Green Turtle (*Chelone viridis*) from the West Indies, presented by Mr. A. E. Painter, F.Z.S.; a Loggerhead Turtle (*Thalassochelys caonana*) from the Atlantic Ocean, presented by the Surrey Commercial Docks Company; a Leopard Tortoise (*Testudo pardalis*) from South Africa, presented by Mr. William Lane; a Slow-worm (*Anguis fragilis*) from Norfolk, presented by Mr. T. E. Gunn; a Bonnet Monkey (*Macacus sinicus*) from India, a Blue-fronted Amazon (*Chrysotis aestiva*) from Brazil, a Grey Parrot (*Psittacus erithacus*) from West Africa, an Alligator Terrapin (*Chelydra serpentina*) from North America, deposited; two Jardine's Parrots (*Piceocephalus galiclemi*) from West Africa, two — Conures (*Conurus perlatus*) from the Lower Amazons, an Electric Eel (*Gymnotus electricus*) from British Guiana, purchased; a Mule Deer (*Cariacus macrotis*), born in the Gardens.

OUR ASTRONOMICAL COLUMN

THE NEXT MINIMUM OF MIRA CETI.—In the ephemeris of variable stars for 1884 in the *Vierteljahrsschrift*, the next minimum of Mira is fixed to 1884 October 24, a date which does not appear to result from Argelander's formula of sines, as it is given in Schönfeld's Catalogue of 1875, viz. :—

$$\begin{aligned} \text{Epoch Min.} &= 1866 \text{ August } 8^{\text{o}} + 331^{\text{d}}.3363. E \\ &+ 10^{\text{d}}.48 \sin \left( \frac{360^{\circ}}{11} \cdot E + 282^{\circ} 45' \right) \\ &+ 18^{\text{d}}.16 \sin \left( \frac{45^{\circ}}{11} \cdot E + 31^{\circ} 15' \right) \\ &+ 33^{\text{d}}.90 \sin \left( \frac{45^{\circ}}{22} \cdot E + 70^{\circ} 5' \right) \\ &+ 65^{\text{d}}.31 \sin \left( \frac{15^{\circ}}{11} \cdot E + 179^{\circ} 48' \right) \end{aligned}$$

For the present year E = 20, and hence substituting logarithms the four perturbations become—

$$\begin{aligned} + [1^{\text{d}}.02036] \sin (217^{\circ}.20) &= - 6^{\text{d}}.35 \\ + [1^{\text{d}}.25912] \sin (113^{\circ}.07) &= + 16^{\text{d}}.71 \\ + [1^{\text{d}}.53020] \sin (110^{\circ}.00) &= + 31^{\text{d}}.05 \\ + [1^{\text{d}}.81498] \sin (207^{\circ}.07) &= - 29^{\text{d}}.72 \end{aligned}$$

The Julian date of the initial minimum is 2402822, and we have—

331·3363. E	...	...	...	...	2402822 <sup>o</sup>
Sum of perturbations	...	...	...	...	6626 <sup>o</sup> .73
					+ 12 <sup>o</sup> .29
Julian date of next minimum	...	...	...	...	2409461 <sup>o</sup>

Which it will be seen from the *Nautical Almanac* (p. 486) corresponds to 1884 October 11. In 1882 by a very precise determination of the time of minimum, Schmidt found that it occurred on December 16, which is 18 days earlier than the date given by Argelander's formula, and the previous maximum had also been earlier by about 19 days. If this correction still applies the next minimum might be expected to fall about September 23, or a month earlier than the *Vierteljahrsschrift* has it. Still there is the possibility that Prof. Schönfeld may have applied corrections to the formula.

The present year's minimum may be therefore advantageously observed. In that phase Mira descends to about the brightness of the well-known star following it, not far from the parallel. or to about 8·5 m.

Another of the more interesting variables,  $\chi$  Cygni, may be expected at a maximum about November 15, and R Leporis, "the crimson star," at a minimum on January 5.

**THE DOUBLE-STAR 99 HERCULIS.**—Mr. S. W. Burnham, in his last Catalogue of double-star measures, refers to a statement by M. Flammarion to the effect that the change in the position of the companion of 99 Herculis (one of Alvan Clark's discoveries) very nearly corresponds to the proper motion of the large star. But although the alteration in position between Dawes' measures in 1859 and Mr. Burnham's in 1880, may be fairly represented by rectilinear motion, it will hardly appear, when the best value we can assign at present for the proper motion of 99 Herculis is introduced, that it accounts for the observed change in the position of the companion. If we compare Bradley for 1755 with the Greenwich Catalogue for 1864, employing the accurate formulæ, we find:—

Secular proper motion in right ascension ... - 11"34  
 " " " declination ... + 6"90

Mädler assigned for the respective proper motions - 10"4, and + 7"0.

Taking for comparison the following measures of 99 Herculis,

	Position	Distance	
1859'63 ..	347'2 ..	1'705 ..	Dawes
1880'18 ..	29'9 ..	0'91 ..	Burnham

we find on bringing up Dawes' measures to Burnham's epoch, with the proper motions of the principal star given above, the angle of position becomes 81°5, and the distance 1'65, showing a great difference from the result of the American astronomer. It seems at least probable, as he remarks, that it will prove to be a physical pair.

### THE WATER SUPPLY CONFERENCE

**T**HE Water Supply Conference of the Society of Arts, held at the National Health Exhibition, in the unavoidable absence of the President, H.R.H. the Prince of Wales, was opened by Sir Frederick Abel, C.B., F.R.S., chairman of the Council, who alluded in his introductory address, to these Congresses having been originated by His Royal Highness, who hoped a comprehensive scheme might be elaborated that would provide not only for the urban populations, but for the rural communities. He alluded to the good and useful work done by the Congress held in 1878, and in 1879, and reviewed the present position of the water-question in this country.

The papers read at the Conference were placed under three heads, viz. :—"sources of supply," "quality of water, with methods of filtration and softening," and "methods of distribution, with modes of giving pressure, house fittings, discovery and prevention of waste." Under all heads valuable papers were contributed, and the Society may again be congratulated on bringing together a jury of experts capable not only of showing us the weak points in our existing water-supply, but the methods by which these defects may be remedied. This was done to a large extent by the previous Conference, but the dangers then pointed out have been hardly appreciated, owing to the years of the Conference being followed by a remarkable succession of wet seasons. Now that a hot summer is succeeding a dry winter, the gravity of the situation is forcing itself upon public attention, and the importance of husbanding our water resources is found to be a matter of vital necessity, the neglecting of which has already facilitated the spread of English cholera, in certain districts, and will be a constant element of danger, should Asiatic cholera appear on this side of the English Channel.

Rainfall being the source of all water supply, it may be well to first notice the paper contributed by Mr. G. T. Symons, F.R.S., who, just a quarter of a century ago, instituted the first general series of rainfall observations ever made in this country, and who since that time has been gradually increasing their number, until there are now nearly 3000 observers, no less than 2433 stations having furnished perfect records of rainfall last year. Worthy of all praise as is this remarkable voluntary staff of observers, not only giving their services, but actually contributing 99 per cent. of the cost of publishing the observations made, it is obvious, looking to the direct bearing such observations have on engineering, agricultural, and sanitary questions, bearing on the health and welfare of our population, that the scope of the inquiry should be enlarged so as to increase its sphere of usefulness, and that it should be placed under a

Government department with a grant from Parliament, and the inquiry be no longer crippled for want of funds as regards possible and necessary extensions, though ten years ago the British Association for the Advancement of Science, feeling it their duty to initiate, rather than support, investigations of national importance, withdrew the vote with which they had aided the work for many years, it is due to Mr. Symons to point out that he has not merely maintained the standard of excellence found in his annual volumes of that period, but has increased their size and usefulness. In his paper Mr. Symons urges as a question of general policy the necessity of the formation of an hydraulic office, the early duty of a Government being "to see that all parts are completely supplied with the chief necessary of life. Englishmen," he says, "have a dread of centralisation, but in many ways they pay a long price for their dread. At present, it is not often that any town can even state before Parliament its views as to the effect upon it of what its next neighbour may be obtaining powers to do," and which, when passed by Parliamentary Committees become law, and "law for all time to come:" he truly adds that "no one can foresee what will be the total population of the country a century hence. No one can tell where the bulk of the people will reside, nor what will be the need for water in various parts of the country," and he justly urges that special water rights, "now asked to be created, should be subject to revision, *without compensation*, after the lapse of 100 years."

Mr. E. Bailey-Denton, in his paper on "The Water Supply of Villages and Rural Districts," points out that though a state department exists charged with sanitary matters, the condition of our rural districts as regards water supply "is a positive disgrace," and he considers the department should have their efforts specially directed to the protection of small communities, and states that those who form the "Local Boards" and "Boards of Guardians," having jurisdiction over such districts are elected under pledges to oppose all sanitary works that will increase the rates, and that even when men of knowledge and position are elected to such posts—outvoted by the majority they fall back to quietly agreeing with the *laissez faire* policy of their colleagues, and allow their constituents to continue to inhale and imbibe those germs of disease which float in the foul air that surrounds them, and are present in the only water provided for their use. Mr. Denton is evidently of the opinion that the writer has already advocated in these columns, that the Local Government Board should not only have the power to sanction local authorities providing pure water and efficient sanitary arrangements, but should themselves survey the country and seek out the districts where advantage is not taken of the law, as it even now exists, and to compel the authorities to remedy the abuses and shortcomings discovered.

In the present position of our knowledge it would be difficult, and often impossible, for an engineer to advise such a rural authority, suddenly called on to provide itself with an efficient water supply, even were the legal difficulties, and cost of parliamentary struggles obliterated. Thanks to Mr. Symons, we know something of the rainfall, but as Mr. Conder and others have pointed out, our knowledge of the discharge of our rivers is lamentably small. Daily gaugings have been taken of the Thames, but no systematic examination of the quantities run off by streams draining equal areas of rocks of varying degrees of permeability have been carried out, and the necessity of such observations being taken in all our streams cannot be too highly insisted on, and should be made a matter of State care. The few observations we have were chiefly made in the last century by Rennie, if we except the comparison of chalk and clay basins, made by Mr. C. Homersham, who showed the large quantity of water absorbed by the chalk, which never appears as streams. As regards underground waters, our knowledge is also not yet sufficiently definite to safely predicate the quantity of water a given unknown district will yield. A large body of information has been published by the Underground Water Committee of the British Association, during the past ten years, from which the direct relation of yield to rainfall, modified by degree of permeability is clearly made out, and details given of actual supplies obtained in enormous quantities, in certain districts, but what is still required, is a systematic examination of the height of water in wells and borings throughout the kingdom, and until the seasonal variation is clearly established, the minimum yield to be obtained in a given district, during a dry year, and still more after a succession of dry years cannot be ascertained, or calculations made dependent on with any safety. Information of this class is being steadily



accumulated in the Epsom, Croydon, and in some other districts by Mr. Baldwin Latham, C.E., who is ascertaining the seasonal variation in level of the underground waters, and the difference of cubic discharge of springs by self-recording apparatus. Valuable as are such observations for special districts for general use and public advantage, it is necessary that they should be extended to the whole country and be made by official observers for public use, and free access to the results.

In a paper on "Water from the Chalk," Mr. Joseph Lucas alluded to the work he has been doing during the past twelve years in measuring the height of the water in the wells over a large district in the Thames and Hampshire Basins, connecting together the points of observations by imaginary lines, or underground contours. He is able to map out with some degree of accuracy the height at which water stands in the rocks, the varying width, or proximity of the contours, indicating the varying decrease or increase of the steepness of the water gradients, *i.e.* the angle which the slope of the water-plane makes with the sea-level, which, as shown by the Rev. J. Clutterbuck in 1841, varies in the chalk from 14 to 47 feet per mile. Mr. Lucas is of opinion that a comprehensive and uniform survey of the sources of water-supply, both surface and subterranean, should be carried out by the nation, and that maps should be constructed, "defining levels, areas, and quantities of water."

The Geological Survey have done much to prepare the way for such an examination as was pointed out by Mr. Edwin Chadwick, C.B. at a previous Congress, and it is encouraging to note that the first four papers read on "Sources of Supply" at the present Conference, were contributed by three present officers, and one former officer of that staff. Mr. Whitaker's paper commenced by pointing out that ordinary geological map, including the greater number as yet issued by the Geological Survey, are of little use in estimating the quantity of water obtainable from a given porous rock that may be represented on the map, and whose water-bearing capacity may be well known, owing to the thick covering of various beds of clay, sand, gravel, loam, and alluvial silt, together called by geologists drift, which obscures the solid geology, and where the beds consist of impermeable material entirely cut off the percolation of rainfall into the pervious rock beneath. Before, therefore, any estimate can be made with any degree of accuracy, of the quantity of water capable of being yielded by a given area of permeable rock, as represented on the ordinary geological map, it is necessary to have a Drift survey, showing the actual condition of the surface. Such maps are now being issued by the Geological Survey, the various rocks, being shown by their proper colour, in the areas, when they are not overlaid by any material, the surrounding districts being coloured to indicate the nature and character of the drift deposits overlying them, distinguishing the different clays and various gravels by distinct tints. For waterworks purposes, so elaborate a classification is not requisite, and in the interesting and valuable series of maps Mr. Whitaker laid before the Congress, the results of many years of work, he has adopted the following classification:—1, bare chalk; 2, chalk covered only by beds of a permeable kind; 3, chalk protected by beds of mixed or varying character; 4, chalk protected by impermeable beds. The result of Mr. Whitaker's investigations is to curtail the somewhat excessive estimates that may have been made in bygone years of the amount of chalk area available for the absorption of rain, but he states that the "chalk remains our chief water-bearing bed in the south-east of England; for though not always coming up to some of the sand-beds in permeability or porosity, it is pre-eminent over all other geological formations in thickness and extent of outcrop."

Mr. Topley contributed an interesting paper on a subject he has already done good and original work, "Water Supply in its Influence on the Distribution of the Population." He shows there "is a well marked and constant relation between the outcrop of porous strata and the parish or township boundaries, the longer axes of the parishes crossing the outcrops more or less at right angles." The arrangement of parish boundaries depends upon the sites of early settlements, which were entirely controlled by the outcrop of the water-bearing beds. Mr. Topley points out that with the river, London has at present no less than four different sources of supply of water, each giving a different quality, and he notes that no city in Europe is better situated for supplying itself from its own area, but it has become so vast that all sources have become insufficient. He notes that most of the other great capitals of Europe are also situated on basins capable of yielding deep well water, and instances Paris, Berlin, and Vienna.

Mr. De Rance, in a paper on "A Possible Increase of Underground Water Supply," endeavoured to show that the flow of intermittent springs might be increased, and the violence of floods diminished by the construction of "dumb wells," through impermeable beds to pervious beds below, draining what is now unproductive rainfall, passing in destructive floods to the sea, into permeable rocks which are now not storing water owing to their being covered by impermeable formations.

Mr. Edward Easton gives a useful *résumé*, gathered from his own practical experience, of well recognised principles which should govern the supply of water for domestic and other purposes, which, he justly observes, are too often neglected or forgotten. He appears to have a very decided predilection for soft water in preference to hard, and alludes to the value and cheapness of the lime-softening process of Prof. Clark; as regards filtration of supplies, in which it is found impossible to altogether prevent the chance of contamination, the filtering medium should include some deodorising agent, and he refers to the good results obtained in this direction at Wakefield by Spencer's magnetic carbide of iron, and at Antwerp by Prof. Bischof's spongy iron; in both cases the water was much contaminated, and was rendered perfectly wholesome. Referring to the dangerous practice of storing water in cisterns, he states that after an elaborate and exhaustive examination of the waters supplied by the London water companies, by Sir Frederick Abel, assisted by Dr. Dupré, Mr. G. H. Ogston, Prof. Voelcker, and the late able chemist to the Metropolitan Board, Mr. Keates, it was found that during the session of 1877-8, when two bills were introduced into Parliament at the instance of the Metropolitan Board of Works for purchasing the undertakings of the London water companies, and for providing a separate supply from the chalk for drinking purposes, that whilst the water in the main was in almost all cases excellent, the condition and position of the cisterns frequently rendered it utterly unfit for human consumption, a condition of affairs affording a most fruitful source of disease, and not alone confined to the dwellings of the poor, cisterns fixed on the roofs of the better class of houses being "rarely sufficiently covered, and often open to contamination from soot, dust, inroads of blackbeetles, and other abominations." Mr. Easton quotes Sir F. Bolton as to the importance of waste-pipes from cisterns being carried outside each house and the end left exposed to the air, instead of communicating, as now, with the drains, from which gases flow back into the cisterns, and are absorbed by the water; but it is to be hoped, with the steadily increasing expansion of the constant service in London, this frightful evil will cease to exist. According to Colonel Sir F. Bolton's return for the month of May, the quantity of water supplied to London amounts to 32 gallons per head per day, about 20 per cent. of which, say 6 gallons, it is estimated is used for other than domestic purposes, leaving 26 gallons per head as the quantity supposed to be absolutely consumed in the houses, while long practical experience has proved that the water really required is not half that quantity, and there can be little doubt that a system of supervision like that carried out at Liverpool would have similar results. The use of Deacon's meter has reduced the consumption of water from 33 to 22 gallons per head per day; this ingenious instrument enables waste of water to be localised, and the house or place detected where the flow-off is taking place.

Mr. Easton then shows the advantage to consumer and supplier of a constant service being given to each house by water, the quantity being regulated by the rateable value of the property, but returns to the keynote of all the speakers, that "it is useless to discuss the method and conditions of supply if the sources of water are not to be preserved to us," and adds, "it is quite certain that with the immense growth of the population of this kingdom, it will not be long before this preservation becomes a pressing necessity."

Mr. Easton repeats the proposition he made in his Presidential address to the Mechanical Section of the British Association at Dublin in 1878, which, expressing as it does a widespread feeling shared by all who have given attention to the subject, it may be well to quote at length. Mr. Easton considers that the question "of the management of rivers is of sufficient importance to make it worthy of being dealt with by new laws, to be framed in its exclusive behalf;" and that "a new department should be created—one not only endowed with powers analogous to those of the Local Government Board, but charged with the duty of collecting and digesting for use all the facts and knowledge necessary for a due comprehension and satisfactory dealing with every river-basin or watershed area in the United Kingdom

—a department which should be presided over, if not by a Cabinet Minister, at all events by a member of the Government who can be appealed to in Parliament."

Mr. J. Mansergh, C.E., states that "altitude and geological structure of a district on the two principal factors which determine what the source of water-supply must be in each district." He divides source of supply into (a) aboveground, and (b) underground. The former he subdivides, into—1. Water taken from heads of streams by pipes, just when it ceases to be underground water, as in the case of Lancaster. 2. Water obtained from natural lakes, as in the case of Glasgow. 3. Water collected from high-lying moorland watershed areas, as at Manchester. 4. Water taken from a large river flowing past a town, as the Thames and Lea, near London. His second class (b) he does not subdivide, and includes all waters taken from all classes of stratification; he appears to take twelve degrees of hardness of Dr. Clark's scale as the maximum limit of safety for health, and regards a pure soft supply as preferable to a pure hard supply, using the word "pure" to mean absence from organic impurity. Speaking of towns which are compelled by position, and on the score of expense to be content with a water-supply derived from an adjacent river, he states that such sources "would be inadmissible but for the great rehabilitating process which nature silently carries on in a river, and to which chemists apply the term 'oxidation.'" In this wonderful process the polluting organic matters which the water contains are converted by the agency of oxygen into harmless inorganic salts, and the water again becomes fit for the use of man. He here refers to the burning controversy between the two schools of opinion on this matter, which have at their heads Dr. Frankland and Dr. Meymott Tidy respectively; the former admits that oxidation is effective in converting the most vile contamination into a harmless condition, but does not admit it destroys the organised germs, which he believes cause the virulent zymotic diseases, and which, being indestructible, may travel scores of miles in a running stream without being deprived of their fatal potency. Dr. Tidy, on the other hand, denies the existence of the germs, and affirms, after a run of a few miles, a river is fully oxygenated. Mr. Mansergh observes that, though Dr. Frankland's opponents appear to have the facts in their favour—as London, a city chiefly supplied from a polluted river, being one of the healthiest cities in the world—yet the "germ" theory is making steady advances under the investigations and researches of competent men.

Since the London water companies have come under the official supervision of Sir Francis Bolton, large sums of money have been spent in increasing the efficiency of the subsidence tanks, by greatly augmenting their capacity, in fact, their operations have converted them into storage reservoirs; from these the water is delivered into filter beds, the varieties in the construction of which, adopted by the different companies, are shown in the angle of the very interesting water pavilion erected in the Health Exhibition, under the auspices of Sir Francis Bolton, and which is full of interest to the student of the subject, and is decorated with some very artistic representations of the various waterworks on the banks of the Thames.

Any scheme of new legislation, and construction of a new department to carry out its provisions should, in the opinion of the writer, be made to include underground water supplies, the state of the law at the present time being exceedingly unsatisfactory, and the decisions of parliamentary committees being uncertain and contradictory. The law places underground water in the category of wild and free creatures, that he who can catch can hold, and just as one landowner can shoot a hare on his own property that has been bred on his neighbour's land, so can he take, by sinking a well, the water that has been received on his neighbour's property, notwithstanding his neighbour may be wholly dependent upon it for water supply, and it may have been used from time immemorial, and further than this, on the principle "of doing what you like with your own," he may actually pour poison down his own well, and destroy the value of the water in the well on his neighbour's land without hindrance and without compensation. Two of the es-ayists at the congress referred to the recent judgment of Justice Pearson confirming this view.

Considering the opinions expressed in the papers read at this congress, and the statements made in the discussion upon them, it appears to be generally believed by those who have made the water question a special study, that the existing complex legislation, sanctioning various and often antagonistic authorities in our water-basin, is productive of the greatest harm to the community,

and can only be remedied by the constitution of an hydraulic department with absolute control over streams from their source to their outfall; that such department should at once make systematic arrangements for taking rain-gauge observations, the gauging of the whole of our streams, and the height and seasonal variation of the water stored in the rocks beneath the surface.

C. E. DE RANCE

### THE CITY AND GUILDS OF LONDON INSTITUTE

FROM the Report on the Technological Examinations, 1884, we learn that a considerable increase is shown in the number of candidates at the recent examination, May 28, 1884, as compared with that of the previous year. In 1883, 2397 candidates were examined, of whom 1498 passed. In 1884, 3635 were examined, of whom 1829 passed. There is also shown a satisfactory increase in the number of centres at which the examinations have been held.

From the returns received at the office of the Institute in November last, it appears that 5874 persons were receiving instruction, with a view to these examinations, in the registered classes of the Institute. The number of students at the corresponding period of the previous year was 4052, this being 585 in excess of the number in 1882. Of the candidates who received instruction in the registered classes of the Institute, about one-half presented themselves for examination; of the remaining candidates who came up, some had received instruction in colleges the Professors in which do not accept payment on results, whilst others had supplemented their workshop practice by private study.

This year, as last year, Glasgow heads the list of centres from which the largest number of candidates have passed, the number being 139, as compared with 123 in 1883. Of the other centres, Manchester sent up 115 successful candidates, as against 76 in the previous year; Bolton 98, as against 117; Bradford 90, as against 51; Leeds 70, as against 64 (50 coming from the Yorkshire College, as against 43); Preston 59, as against 46.

In carpentry and joinery, which was added this year to the examination programme, 369 candidates were examined, of whom 125 passed. Nottingham sent up this year for the first time 19 candidates in lace manufacture, of whom 13 succeeded in satisfying the examiner.

Examinations were held this year in 43 subjects, as against 37 in 1883, the only subjects included in the programme in which no examinations were held being the Mechanical Preparation of Ores and Salt Manufacture.

Practical examinations were held this year for the first time in weaving and pattern designing, and in metal plate work, and owing to an alteration in the arrangements for the conduct of the Practical Examination in Mine Surveying, the results of the examination in this subject are also included in the accompanying tables.

Of the 23 candidates for honours who, besides undergoing a written examination in pattern designing and weaving, sent up specimens of their work, 13 succeeded in obtaining a certificate. In metal plate work, two candidates presented themselves for honours, but neither succeeded in obtaining the institute's certificate. In all subjects of examination, the honours certificate of the Institute is intended to be regarded as a diploma of proficiency, and is awarded in those cases only, in which the candidate shows a sound theoretical and practical knowledge of the subject.

The percentage of failures on the results of the examinations in all the subjects has increased from 37.5 in 1883 to 49.7 in 1884. This increase in the number of failures is due to many causes, which are referred to in the separate reports of the examiners, prominent among which is the want of skill in drawing, and of previous science teaching on the part of the candidates. In many subjects, too, there is still experienced the serious want of competent teachers, which it is hoped will to some extent be remedied when the Central Institution is in working order.

The large accession to the total number of candidates is due mainly to the increase in the number of candidates in cloth and cotton manufacture, in weaving and in mechanical engineering, and to the addition of the subject of carpentry and joinery to the programme. In 28 subjects there has been an increase in the number of candidates; in nine subjects, chiefly chemicals,

there has been a slight decrease, and in the remaining subjects the number has remained the same.

Table III. shows the proportion of candidates in each subject who have attended classes the teachers of which receive payment on results. By reference to this table it is seen that of the 1829 successful candidates, 1387 were taught in such classes, and of these, 176 have obtained certificates in honours.

Of the 1829 successful candidates, 1362 were examined this year for the first time. Of the remainder, 189, who had previously obtained an ordinary certificate, have this year gained an honours certificate; 98 have gained a higher place in the same grade; 180 have obtained a second class only in the same grade in which they previously passed, or have competed for a prize and failed to obtain it, and their names are consequently not included in the pass list. Last year, the number of candidates who passed the examination, but in the same class and grade as in the previous year, was 128.

A satisfactory feature of this year's examination is the increase, although small, in the proportion of candidates who, having already passed examinations under the Science and Art Department, are qualified to receive the Institute's full technological certificate. Although the returns of the candidates have not yet been verified, it may be assumed that at least 570 of the successful candidates will be entitled to the full certificate. The corresponding number last year was 420, and comparing these numbers with the total number of successful candidates, it will be seen that the percentage of those to whom full certificates will be awarded has increased from 28 per cent. last year to 31.2 per cent. this year.

In several subjects the full complement of prizes has not been awarded, the merits of the candidates not having justified the examiners in awarding them, whilst in other subjects additional prizes have been given. We see that 156 prizes have been granted, including 137 money prizes, 44 silver medals, and 112 bronze medals. Last year 143 prizes were granted, including 129 money prizes, 48 silver medals, and 95 bronze medals.

Looking at the general results of the examination, the large increase in the number of students under instruction and of the candidates who presented themselves for examination, may be considered satisfactory, as indicating the more general desire of artisans and of those engaged in manufacturing industry to take advantage of the opportunities now offered to them of receiving technical instruction. At the same time, the large proportion of failures consequent upon the accession of candidates, the majority of whom are already familiar with the practice of their trades, but possess a very imperfect knowledge of the application thereto of the principles of science, shows the need that still exists of improved and of more systematic technical instruction for those who are employed in factories and workshops.

Although the Royal Commissioners on Technical Instruction, the Report states, have spoken encouragingly of the facilities now offered to artisans of obtaining in evening classes good scientific and technical teaching, it would appear that the number of persons engaged in manufacturing industry, who avail themselves of the Science and Art Classes under the Department, is still comparatively small, and that the proportion of children who learn drawing in the public elementary schools is, as yet, inconsiderable. These causes doubtless prevent our artisans from deriving the full advantage of the Technical Classes now organised in different parts of the kingdom.

In considering the foregoing results, the inadequate supply of competent teachers in technology must also be taken into account.

### SCIENTIFIC SERIALS

*American Journal of Science*, July.—Contributions to meteorology, twentieth paper: reduction of barometric observations to sea-level, by Prof. Elias Loomis. The results embodied in this paper have been determined by an extensive comparison of observations at five mountain stations, three in the United States and two in Europe. The reductions thus obtained were compared with those computed from the theories of Laplace and Plantamour, and exhibited very great discrepancies for all the stations, especially at the lowest pressures. The cause of these discrepancies is referred to the pressure coefficient in the Laplace formula, which appears to be too small.—Light of comparison stars for Vesta, by Edward C. Pickering. The light of the planet is here determined from comparison with the two stars  $D_M + 22^\circ 21'63$  and  $2164$ , observed with the large meridian

photometer of the Harvard College Observatory. The mean result thus obtained for the magnitude of Vesta is  $6.64$ , as compared with  $6.49$  and  $6.45$  of previous observations at the same Observatory.—Mineral notes from the laboratory of the United States' Geological Survey, by F. W. Clarke and T. M. Chatard. The paper embodies a complete analysis of the jade or nephrite and pectolite implements in use amongst the Eskimo of Point Barrow, Alaska, and obtained from a region to the east, not yet visited by civilised man. Analyses are also given of Saussurite from Shasta County, California; of Allanite from Topsham, Maine; of Damourite from Stoneham, Maine; of Margarite from Gainesville, Georgia; of Halloysite from near Lake Mono, California; and several other rare minerals.—On the occurrence of alkalies in beryl, by Samuel L. Penfield. The results of numerous investigations show that alkalies are always present, undoubtedly replacing the beryllium, that water is also present, and cannot be disintegrated in the formula, and that the formula



is the one best agreeing with the analyses.—The Niagara River and the Glacial Period, with map, by Prof. G. F. Wright. The author infers that the Niagara River itself has worn the whole of the Gorge, from Queenston to the falls, with perhaps some little help from pre-Glacial erosion above the whirlpool. The rate of erosion, calculated at about 3 feet a year, would make the time required not over 10,000 or 12,000 years.—Note on the discovery of primordial fossils in the town of Stuyvesant, Columbia County, New York, by S. W. Ford. The fossils obtained from the stratified rocks of this region show that they belong to the Lower Potsdam formations. Amongst the species obtained were *Palaeophycus incipiens*, *Obolella crassa*, *Stenotheca rugosa*, *Hyolithes Americanus*, *H. impar*, *Hyolithellus micans*.—Notes on some apparently undescribed forms of freshwater infusoria (ten illustrations), by Dr. Alfred C. Stokes. The species named and described are: *Lovodes vorax*, *Apgaria undulans*, *A. ovata*, *A. elongata*, *Heonema dispar*, *Solenatus apocampius*, *S. orbicularis*.—On the causes of variation of species, by Romyn Hitchcock. The author combats Dr. Carpenter's view, published in the Reports of the *Challenger* Expedition, that variation in the orbolites group is the expression of a not understood "progressive tendency along a definite line towards a higher specialised type of structure in the calcareous fabric." He contends that the highly complex form of shell developed by this simple sarcode organism is not due to any inherent tendency towards a definite plan, but to change of environment and other easily understood causes.—Remarks on the crustacea of the *Albatross* dredgings off Cape Hatteras, and thence to the region of George's Banks in the year 1883, by Sidney J. Smith. The whole number of species of Decapoda determined from these dredgings was 72, of which 40 were taken below 500 fathoms, 29 below 1000, 13 below 2000, and 6 at a single haul in 2949 fathoms. Striking characteristics of the deep-sea specimens are their red or reddish colour and distinctly faceted eyes in the normal position, showing conclusively against the arguments of physicists that some rays of light must penetrate to depths of over 2000 fathoms.—Crystallised gold in prismatic forms, by Wm. P. Blake.—Mode of action of shell- and rock-boring molluscs, by Prof. F. H. Storer. The author argues that it is not a drilling or other mechanical action, but a distinctly chemical process, the solvent being probably free muriatic acid.—Memorials of the late George Engelmann and Oswald Heer, Associate Fellows of the American Academy, Botanical Section, by Asa Gray.

*Journal of the Chemical and Physical Society*, vol. xvi. fasc. 4.—On the action of aldehydes on zinc-organic compounds, and the formation of secondary alcohols, by G. Wagner. Aldehydes of the fatty and aromatic series give, with zinc-ethyl, alcoholates of secondary alcohols, these last being the exclusive, or nearly exclusive, produce of the reaction, which circumstance gives an easy means for preparing secondary alcohols; the speeds of the reactions are, however, very different. On the influence of temperature on the acceleration of certain reactions, a preliminary communication by M. Menschutkin.—Quantitative determination of zinc in zinc-powder, by Th. Beilstein and G. Javein.—On anhydride of erythrite, by S. Prybitck.—On canarine, a new tinctorial substance discovered by O. Müller, by W. Markovnikoff. It is not soluble in water, spirit, ether, and benzene, but only in bases, according to the strength of which it gives different colours from pale yellow to red.—On anhydrides of

mannite, by A. Sivoloboff and A. Alekhin.—On the structure of the atmosphere and on the general laws of gases (second paper), by E. Rogovsky. The criticism of the author brings him to the conclusion that the kinetic theory of gases must be revised before deducing the hypometrical formula. The inquiry is to be continued.—On the magnetism of iron wires which are partially inclosed by a magnetising bobbin, by P. Bakhmetieff. The curve which expresses the relations between the magnetic momentum ( $m$ ) and that part of the wire ( $l$ ) which is directly submitted to the action of the bobbin has an irregular shape; the fraction  $m:l$  reaches a maximum, which is reached sooner when the magnetising force is greater.—On the specific heat of liquids, by A. Nadejdin.—On the theory of dimensions, by N. Sloughinoff.—On a general law of dilatation of liquids, by M. Avenarius.—Remarks on M. Bardsky's paper on the intramolecular force.

Vol. xvi. fasc. 5.—On alizarine oils, by P. Loukianoff. They are found to consist chiefly of basic salts of common fatty and sulpho-fatty acids, the former in greater amount.—On the dependency of photo-chemical phenomena upon the amplitude of the luminous wave, by C. Timiriazeff. On the ground of several observations the author concludes that it is probable that the more energetic reactions are due to waves having a greater amplitude; and that, out of the waves absorbed by a body, those having a greater amplitude act more energetically.—Action of ethylic iodide on the azobenzoate of silver, by P. Goloubeff.—On naphthochinone and its derivatives, by O. Miller.—On the separation of calcium from strontium by Snidersky's method, by J. Bogomoletz.—On triphenylamidomethan, by W. Hemilian and G. Silberstein.—On some salts of mesotartaric acid, by S. Przibyttek.—On the heat of magnetisation of a circular magnet, by P. Bakhmetieff. It is much less than in rectilinear magnets, and seems to follow other laws; the development of heat is altogether doubtful in such magnets.—The steam-engine made by Polzounoff in Siberia in 1763, by W. Lermontoff.—Notes on elementary optics.—Note on M. Kraævitch's paper on a hydrodynamic equation, by N. Petroff.—On the dilatation of liquids and its relation to their absolute boiling-points; an answer to M. Avenarius, by D. Mendeleeff, being a few remarks on the history of the subject and on M. Avenarius's logarithmic formula of dilatation.

*Schriften der Physikalisch-Ökonomischen Gesellschaft*, Königsberg, 1883.—On hybrid varieties of the violet; inaugural dissertation, by A. Bethke.—Memorial address on Charles Darwin, by Dr. Richard Hertwig.—Report on the twenty-first meeting of the Prussian Botanical Society at Osterode, October 1883, by Dr. Caspary, President.—Memoir on the latest discovery of the Stone Age in the East Baltic region, and on the beginning of plastic art in North-East Europe, by Dr. Otto Tischler.—On the sources whence plants derive their nourishment, by Dr. Klien.—Report on the expedition to Aiken to observe the transit of Venus, by Dr. Franz.—On some disputed questions connected with the anatomy of the eye, by Dr. Schwalbe.—On the degrees of sensitiveness in living substances, by Dr. Grünhagen.—On abnormal vision, by Dr. Richard Hilbert.—On the geology of the region between Elbing and Dirschau.—On the primeval history of the Caucasus, by Dr. Otto Tischler.—Anatomical description of the cinnamon plant, by Prof. Sanio.—On the microscopic Algae and spores of the Russian coal-measures, by Prof. Robert Caspary.—Anatomical and physiological remarks on the wasp family (*Nematus pollipes* and *N. rufipes*), by Prof. Gustav Zaddach and C. G. A. Brischke.—Description of a new myograph for measuring the velocity of the nervous processes, by Prof. A. Gruenhagen.—On subjective impressions of colour, by Dr. Berthold.—On some new and rare plants found in Prussia, by Prof. Caspary.—On the fossil fishes in the provincial museum, by Dr. Jentzsch.—On the Jurassic system of the Inowrazlav district, by Dr. Jentzsch.—On the site of the Oracle of Dodona, by Dr. G. Hirschfeld.

*Atti della R. Accademia dei Lincei*, April 20.—Report on the archaeological discoveries made in various parts of Italy during the month of March, by S. Fiorelli.—On the normal annual recurrence of certain meteorological phenomena deduced from the observations made at the Collegio Romano, by Pietro Tacchini.—Note on the equilibrium of elastic and rigid surfaces (continued), by S. Betti.

May 4.—Inaugural address by the new President, Cavaliere Francesco Brioschi.—Obituary notice of M. Dumas, by S.

Cannizzaro.—On the relations existing between the refrangent power and chemical constitution of organic substances, by Drs. R. Nasini and O. Bernheimer.—On the groups of the series of  $a, b \dots k$  dimensions, by Giovanni Frattini.—Observations of the new planet 236 between Mars and Jupiter, made at the Observatory of the Collegio Romano, by Elia Millosevich.—Observations of the Pons-Brooks comet made at the Observatory of the Campidoglio, by Francesco Giacomelli.—Remarks on the declination and horizontal composition of terrestrial magnetism in Rome during the last ten years, by Filippo Keller.—Influence of magnetism on the embryogenesis and sterility of the ovum, by Carlo Maggiorani.—Meteorological observations at the Observatory of the Campidoglio during the month of March.

*Rendiconti del R. Istituto Lombardo*, June 19, 1884.—The concept of linear length is independent not only of the idea of derivation but also of that of continuity, by Prof. G. Ascoli.—A contribution to the study of the Northern Apennines, by Prof. T. Taramelli.—On the representation of the Newtonian forces, by means of the elastic forces, by Prof. E. Beltrami.—On the integration of the differential equations of the conic pendulum, by Dr. Gian Antonio Maggi.—On the revival of the critical philosophy of Kant, by Prof. C. Cantoni.—Note on a poem of Alessandro Volta in honour of Saussure's ascent of Mont Blanc in 1787, by Zanino Volta.—Meteorological observations made at the Brera Observatory, Milan, during the month of May.

July 3.—New measurements of the planet Uranus, by Prof. G. V. Schiaparelli.—Researches on the alkalis of the blood and their variations in intensity artificially produced; physiopathological and therapeutic importance of these experiments, by Prof. C. Raimondi.—Integration of the differential equation  $\Delta^2 u = 0$  in the area of a circle, by Prof. Giulio Ascoli.—A pathological study of the cellulæ and parasites in the animal system, by Prof. G. Sangalli.—Meteorological observations made at the Brera Observatory, Milan, during the month of June.

## SOCIETIES AND ACADEMIES

### PARIS

**Academy of Sciences**, August 4.—M. Rolland, President, in the chair.—Reply to two notes of M. Wroblewski on the subject of the liquefaction of hydrogen and other gases, by M. L. Cailliet.—On the influence of temperature on the property of absorbing and losing moisture, possessed by vegetable earth and other substances exposed to contact with the atmosphere, by M. Th. Schlering.—On the change in the eccentricities of the planetary orbits due to the concentration of matter in space, by M. Hugo Glyden.—Report of Messrs. Gosselet, Vulpian, Marey, Bert, Pasteur, Richet, Bouley, and Charcot on various communications received by the Academy on the subject of cholera. An examination of forty-three letters, notes, and memoirs has led to no results calling for special consideration. The chief remedies proposed are hypodermic injections of chloride of pilocarpine, the internal application of sulphate of quinine, of oxygenated water, sulphuric lemonade, &c. More important are the views of Dr. Duboué of Pau, who recommends as a preventative the strengthening of the endothelial and epithelial systems by the daily administration of two doses of 0.25 grain of pure tannin prepared with ether. His curative method consists in restoring the circulation by copious intravenous injections of an artificial serum to which should be added one grain per litre of pure tannin.—Observations of the Barnard comet made in Algiers, by M. Trépid.—Note on the distribution of the faecules on the solar disk during the year 1883, with tabulated results, by M. P. Tacchini.—Description of a fixed astronomic telescope, being a modification of M. Lœwy's "equatorial coude," by M. G. Hermite.—An account of the method by which the absolute value has been determined of the horizontal component of terrestrial magnetism at the observatory of the Park Saint-Maur, Paris, by M. Mascart.—Description of a new apparatus for collecting the snow of carbonic acid required in producing low temperatures (one illustration), by M. Ducretet.—On the decomposition of white cast iron by heat, by M. L. Forquignon.—Note on the composition of the cyanides of mercury, zinc, and of some other elementary compounds of cyanogen, by M. G. Calmels.—On the nature of the visual faculty, and on the respective parts played by the retina and the brain in the elaboration of optical impressions, by M. H. Parinaud.—Researches on the biological rôle of phosphoric acid, and on the part played by this

substance in the formation of the animal tissues, by M. A. Mairet. —On the permanent immunity from charbon of rabbits vaccinated with the attenuated virus of this disease, by M. Feltz. Seven months after the vaccination six rabbits so treated and six others were operated on with a strong preparation of the virus. The six fresh animals all died of charbon, while the six that had been vaccinated remained unaffected by the second operation. But when again treated, eighteen months afterwards, they yielded to the virus, and all ultimately perished. The author infers that the operation preserves its efficacy in the rabbit not longer than eighteen months. —Description of a filter which yields absolutely pure water free of all animal life, by M. Ch. Chamberland. —On the anatomical origin of spermaceti; description of the so-called spermaceti case, by M. M. Pouchet and Beauregard. —Memoir on the carboniferous measures of the Central Pyrenees, by M. L. Lartet. —On the composition and quality of coal in connection with the nature of the plants from which it has been formed, by M. Ad. Carnot. —On the oxychloride of calcium, and the simple and chloruretted silicates of lime, by M. Alex. Gorgen. —On the origin of the phosphorites and of the ferruginous clays in limestone districts, by M. Dieulafait. —Account of the effects produced by a stroke of lightning at Campan on July 24, by M. A. Soucaze. A house near the telegraph station was entered through the closed door by a living mass of flame, which, after a few seconds withdrew by the same way without injuring any of the inmates or damaging the furniture. —A hypothesis on the temperature of the zone of the solar protuberances, by M. Tardy. The author suggests that in this zone the hydrogen is rendered luminous by an atmosphere of oxygen, in which case the temperature would be that of the fusion of platina, while the temperature of the inner zone would be still higher.

## BERLIN

**Physiological Society, July 18.**—The conception that, just as the chemical elements in *status nascendi* are characterised by greater energy of action than in the ordinary state, so also in the living organism the substances in process of generation and development would exhibit a different or more intense action than substances already fully formed, has been subjected to an experimental proof by Dr. Falk. He first made an examination in the case of prussic acid. A dilute mixture of emulsin and amygdalin, which yielded prussic acid both outside as well as in the body, was divided into two halves, one being injected by a syringe, immediately after the process of mixture, subcutaneously or directly into the sanguineous channel of one of the animals operated on, the other into that of the other animal intended to serve the purpose of comparison, but not till twenty-four hours after the process of mixture, and therefore after all the hydrocyanic acid had become completely formed in the solution. In both cases the phenomena of poisoning occurred, produced by the prussic acid. In the first case, however, in which the prussic acid was developed in the organism, the phenomena of poisoning occurred always at a later stage and in a milder form than in the second case, in which the prussic acid was administered when it was already completely formed. The second substance examined by Dr. Falk was the oil of mustard, which was produced from the myrosin and myronic acid salts contained in black mustard. The experiment in this case was performed in the same manner, and yielded a similar result, as in the former case. Thirdly, an experiment was instituted with hydroquinine, which was formed from arbutin; and here, too, the substance acted more weakly and slowly when it had first to develop itself in the body. From these experiments Dr. Falk drew the conclusion that substances in process of formation, or in the so-called *status nascendi*, possessed no peculiar or greater activity than in the ordinary state. —Prof. Kronecker spoke of a series of precautionary measures to be observed in cases of saving life by an infusion of common salt solution. He first described how animals after severe loss of blood recovered in the best and most rapid manner by introducing into their blood-channels a like quantity of physiological common salt solution. In the case of infusions of albuminous solutions, of serum sanguinis, and even of the blood of another individual of the same species deprived of its fibrin, there was, according to direct measurements, an invariable destruction of blood-corpuscles. With infusions of common salt solution, on the other hand, blood-corpuscles were seen to increase somewhat rapidly. Prof. Kronecker then proceeded more particularly to lay down precautionary rules to be observed in applying this agency to man. In the first place, the composition of the solution must be such as was most compatible with

the human organism. It would appear that a solution of 0.7 per cent. exercised the least irritation on the human body, and was therefore the most appropriate for infusions designed to save life. The addition of carbonate of alkali, recommended by some, had an injurious effect. Of great importance were the velocity and pressure with which the infusion was injected; both ought to correspond with the velocity and pressure in the vein into which the solution entered. The common salt solution should, further, be disinfected beforehand by boiling, and the air which penetrated into the reservoir while it was being emptied must be filtered off by means of a wadding stopper. The injurious effect of too strong pressure was illustrated by a comparative experiment on two rabbits. —Dr. Krause reported some attempts towards the experimental production of contractions of the vocal chords. The possibility he had demonstrated on a former occasion, by pulling forward the tongue and pushing back the epiglottis, of observing the vocal chords of dogs by daylight, facilitated these experiments in a very considerable degree. He applied a prolonged, weak, mechanical stimulation of the nervus recurrens or vagus. A thin slice of cork having, by means of a piece of catgut, been loosely wound together with the nerve so as to exercise on it a continuous moderate pressure, he observed, about the second day of the experiment, the vocal chords under inhalation lie close to each other, and only under exhalation form a small opening between each other. This continuous closure of the glottis was followed, in about four to five days, by a paralysis of the chords, which lasted to the death of the animal. Sections showed in the first stages of the experiment reddening of the nerve and infiltration of the surrounding tissue; later on were found inflammation and extravasation in the nerve; and ultimately molecular decay of the nerve-fibrillæ. The closure of the glottis during the continuance of a prolonged moderate pressure on the recurrens or vagus was explained by Dr. Krause as a contraction of the laryngeal muscles, of which the stronger sphincters of the glottis obtained the preponderance. That the contraction occurred only the second day after the operation was effected, according to the ideas of the speaker, in this way: that the moderate pressure in the normal nerve produced no stimulation beyond what caused the minimum of irritability, and that only after the nerve had become inflamed by the pressure did that pressure suffice to produce a contraction of the muscles and to maintain it till the destruction of the nerve-fibrillæ brought about a paralysis.

## CONTENTS

	PAGE
The Report on Technical Instruction . . . . .	357
British Mining . . . . .	358
Letters to the Editor:—	
The International Geological Congress.—Prof. John McKenny Hughes, F.R.S. . . . .	359
The Volcanic Dust Phenomena.—T. W. Backhouse . . . . .	359
Upon the Occurrence of Bacteria and Minute Algae upon the Surface of Paper Money.—Jules Schaarschmidt . . . . .	360
Fireballs.—W. M. Flinders Petrie . . . . .	360
Museums.—F. T. Mott . . . . .	360
Measuring Heat.—Prof. J. Joly . . . . .	361
Circular Rainbow seen from Hill-top.—Consul E. L. Layard . . . . .	361
The Migration of Salmon . . . . .	361
The Trinity House Experiments on Lighthouse Illuminants. (Illustrated) . . . . .	362
The International Conference on Education . . . . .	363
The Voyage of the "Vettor Pisani." By Lieut. G. Chierchia and Dr. Albert Günther, F.R.S. . . . .	365
Pyrometers. By W. R. Browne . . . . .	366
The Agricultural Institute of Beauvais . . . . .	367
Is Salpa an Example of Alternation of Generations? By W. K. Brooks. (Illustrated) . . . . .	367
Colonial and Foreign Reports . . . . .	370
Notes . . . . .	371
Our Astronomical Column:—	
The Next Minimum of Mira Ceti . . . . .	374
The Double-Star 99 Herculis . . . . .	375
The Water Supply Conference. By C. E. de Rance . . . . .	375
The City and Guilds of London Institute . . . . .	377
Scientific Serials . . . . .	378
Societies and Academies . . . . .	379

THURSDAY, AUGUST 21, 1884

## TECHNICAL INSTRUCTION

## II.

IN a former article the Report of the Royal Commissioners on Technical Education was reviewed so far as relates to the technical schools and colleges of the Continent. The present article deals only with that part of the Report which relates to the United Kingdom.

In the Report of the Royal Commissioners we have a very careful and full account of the various colleges and technical schools that are in existence at the present time. The condition and history of each of these institutions has been thoroughly looked into, and their importance has been fully estimated.

After having passed in review all the important institutions of this kind, the Commissioners devote an exceedingly important part of their Report to conclusions which they have drawn up from the facts placed before them in their various inquiries.

The early part of this chapter is devoted to comparing the development of the various industries both at home and abroad. The fact is pointed out that we were practically the sole possessors of modern appliances until the early part of the present reign, when the Continental nations, settling down to peace after troubled times, found that to compete in any way with us they must give every facility to the then rising generation to improve their position. For this purpose, as was shown in the previous article, technical or polytechnic schools were instituted in most of the Continental States. It is within this period that most of our present institutions for technical education have sprung into existence; but now, on all hands, we find that the advantages obtained from these are acknowledged both by those who directly benefit by their teaching and by manufacturers, who are able to advance the perfection of their products through the higher state of education of those serving under them.

One great aim of the Technical Commissioners has been to examine into the condition and systems of working of these institutes, and in this point they have to be congratulated upon the care and thoroughness with which they have sought and grappled with the weak points of the present system of education. Not only have the Technical Commissioners so carefully considered the defects in our system of education, but they have just as laboriously and skilfully offered suggestions and made recommendations of reform which it is only right that the nation should insist on being carried out.

One of the first weak points noticed is that almost all the colleges and technical schools stand in need of funds to enable them to cope with the demand made upon them for larger teaching staffs, greater accommodation, and better equipment in their art departments, laboratories, and workshops. Another great need that is pointed out, is the non-existence of modern secondary schools, which are necessary to give a preliminary training to students before entering one of the higher colleges or technical schools, where they can continue their study side by side

with their practical work. In this case the Commissioners are of opinion that this, the greatest defect of our system, should be made a matter of legislation, and that local governing bodies should be empowered to found technical and secondary schools wherever necessary.

In discussing the value of the existing colleges the Technical Commissioners remark that "It is most praiseworthy on the part of the professors and teachers that they devote themselves to the important work of tuition for salaries so small as those which they as a rule receive, when many would, by employing their scientific and technical knowledge in private enterprise, obtain much larger pecuniary remuneration." This is of course a fact due in most cases to the lack of funds in such institutions, and in all probability would be considerably remedied if they were relieved from this trouble.

Again, in discussing this same question the Commissioners are of opinion that all colleges do not need to be of the highest type, but of those that are, they say:—"It is, however, of national importance that these few should be placed in such a position of efficiency as to enable them to carry out successfully the highest educational work in the special direction for which the circumstances, particularly of locality, have fitted them; your Commissioners believe that no portion of the national expenditure on education is of greater importance than that employed in the scientific culture of the leaders of industry." Surely the Commissioners could not have spoken plainer. They have without doubt placed on record the fact that such colleges are necessary for the increase of education; and that as yet they are not sufficiently well supported to carry on the duties intrusted to them to their fullest extent.

Two points are well worthy of note in reference to instruction in elementary schools. The Commissioners call attention to the fact that on the Continent *drawing* is an obligatory subject and is held as of equal importance with writing; this is a point which seems to have impressed them, because they are of opinion that "instruction in the rudiments of drawing should be incorporated with writing." This is a point referred to repeatedly in the Report, and great importance is attached to it, as will be seen by the recommendations quoted below.

The second point is the employment of a special science teacher, as at Liverpool and Birmingham, who devotes his time to going round to the various schools giving sound scientific instruction; each lesson being repeated during the week by the schoolmaster.

The whole Report is one mass of useful information, and the suggestions and recommendations which it contains are very valuable. The following are among the most important recommendations quoted at the close of the Report:—

1. As to public elementary schools:—(a) That rudimentary drawing be incorporated with writing as a single elementary subject, and that instruction in elementary drawing be continued throughout the standards. That the inspectors of the Education Department, Whitehall, be responsible for the instruction in drawing. That drawing from casts and models be required as part of the work, and that modelling be encouraged by grant. (c) That, after reasonable notice, a school shall not be deemed provided with proper "apparatus of elementary

<sup>1</sup> Continued from p. 358.

instruction," under Art. 115 of the Code, unless it have a proper supply of casts and models for drawing.

II. As to classes under the Science and Art Department, and grants by the Department:—(a) That school boards have power to establish, conduct, and contribute to the maintenance of classes for young persons and adults (being artisans) under the Science and Art Department. That, in localities having no school board, the local authority have analogous powers.

IV. Secondary and technical instruction:—(a) That steps be taken to accelerate the application of ancient endowments, under amended schemes, to secondary and technical instruction. (b) That provision be made by the Charity Commissioners for the establishment, in suitable localities, of schools or departments of schools in which the study of natural science, drawing, mathematics, and modern languages shall take the place of Latin and Greek. (c) That local authorities be empowered, if they think fit, to establish, maintain, and contribute to the establishment and maintenance of secondary and technical (including agricultural) schools and colleges.

V. Public libraries and museums:—(b) That museums of art and science and technological collections be open to the public on Sundays.

#### COTTERILL'S "APPLIED MECHANICS"

*Applied Mechanics: an Elementary General Introduction to the Theory of Structures and Machines.* By James H. Cotterill, F.R.S. (London: Macmillan and Co., 1884.)

AMONG the many indications of the increasing interest which technical education, in its widest extent, now calls forth, one of the most conspicuous is the production of manuals and text-books on the various subjects with which it deals. Amongst these there is none which is more important than Applied Mechanics, and, at the same time, we may add that there is none which has been more in need of a good elementary text-book. The great works on the subject by Rankine and Moseley are not adapted for elementary teaching, involving mathematical processes beyond the power of a beginner, and thus it has come to pass that a country renowned for its engineering triumphs and for the excellence of many treatises dealing with the practical applications of applied mechanics, has hitherto possessed no book devoted to an exposition of its principles and suitable for educational purposes. Those persons, therefore, who are familiar with Prof. Cotterill's work on the Steam-Engine will have looked forward with much interest to the publication of his long-advertised book on "Applied Mechanics." Its recent appearance we venture to think has in no sense disappointed their expectation, for it bears on every page evidence that its author has not only studied and become intimately acquainted with his subject, but that he possesses the rare faculty of having learned by experience in teaching, the best way of presenting a subject so as to diminish its difficulties and make rough places smooth for the footsteps of the beginner. By assuming a knowledge on the part of the reader of the elements of theoretical mechanics he has been enabled to devote the whole of this large volume to the exposition of the more complicated science, in which

the principles of the former are applied to the problems of construction presented to the architect and the engineer. The treatise is strictly elementary in its methods, the mathematics used being, almost without exception, of the simplest kind, and many results, which have usually been obtained by complicated investigations, are here arrived at by neat and elegant simple processes. The style of reasoning adopted is also very successful, being neither too diffuse, nor, on the other hand, so much compressed as to puzzle and dishearten the beginner by gaps in the reasoning which his mental capacity is not able to bridge. This is particularly evident in the earlier parts of the book. Towards the end, in the section on Hydraulics and Pneumatics, we think that sufficient fulness of explanation has hardly been furnished, in dealing with the application of the principles of Energy, Momentum and Moment of Momentum, to Fluids, and especially in the case of Hydraulic Motors, to enable the student to grasp the subject without a frequent reference to some of the text-books which the author names.

Another point of supreme importance in which Prof. Cotterill's treatment leaves nothing to be desired, is the manner in which he has attained the aim he set before himself of endeavouring "to distinguish as clearly as possible between those parts of the subject which are universally and necessarily true, and those parts which rest on hypotheses more or less questionable." In Applied Mechanics it frequently, we may say usually, happens that, owing to various disturbing causes, exact investigations are either impossible to effect or useless from a practical point of view when carried out, owing to the complexity of the results, and we are therefore led either to adopt results derived from experiments conducted under the guidance of a roughly approximate theory or obliged to rely on experiment alone and, in studying the subject, it is of prime importance that the exact limitations should be stated under which the formulae and rules given can with certainty be applied. This exact knowledge is necessary not only in the interests of science, but also in many practical applications involving the security of life or property. Many writers on this subject have slurred over or insufficiently estimated the importance of an exact statement of conditions and limitations, and consequently we are glad to recognise and point out the thorough and satisfactory way in which this has been attended to by the author.

The book is divided into five parts, of which the first is devoted to "The Statics of Structures." In this section there is not room in an elementary work for much new matter, but we may point out as specially good the manner in which the communication of stress from part to part of a compound frame is traced out. The relation and interdependence of the primary and secondary trusses of such a structure is here indicated more clearly than in any work with which we are acquainted.

The principal peculiarity of the book consists in the complete adoption of Reuleaux's Kinematic Analysis as the basis of the description and treatment of machines, both in their kinematic and kinetic aspects. In this system a machine is regarded as consisting "of a number of parts so connected together as to be capable of moving relatively to one another in a way completely defined by the nature of the machine. Each part forms an element

of two consecutive pairs, and serves to connect the pairs so that the whole mechanism may be described as a chain, of which the parts form the links. Such a series of connected pieces is called a kinematic chain." It is in this mode of regarding the component parts of a machine and in the consequences that flow from it that the peculiarities of the modern system consist. A valuable feature of this work is the series of curves of velocity given for different mechanistic combinations, especially those derived from the slider-crank chain. The special use of such curves is that the varying motion of different parts is exhibited to the eye, which is thus enabled to realise its changes during the cycle in a complete way which would otherwise be difficult, if not impossible. Of the large and intricate subject of the Teeth of Wheels only a sketch is given, which a student would need to supplement by extensive reference to other books in order to understand.

In the Part on the Dynamics of Machines we find the chapter on "The Dynamics of the Steam-Engine" the best in the book. The mode of constructing curves of crank effort of two kinds is shown, and the results given in different cases for two cranks at right angles and for three cranks at angles of  $120^\circ$ , and these curves are used to determine the fluctuation of energy in a complete revolution. This last is expressed in terms of the total energy as a fraction which, in the case of a three-throw crank with connecting rod equal in length to six cranks is as low as  $\frac{1}{10084}$ . A method is afterwards given by which to obtain similar results from any indicator diagram.

The chapter on Friction contains a complete *résumé* of modern experiments on friction with an investigation by both exact and approximate methods of the efficiency of mechanism when friction is considered.

The Principle of Work is assumed throughout the book, being regarded as "a fundamental mechanical principle continually verified by experience, and a great many results are thus arrived at in the simplest way. One very interesting example is got by applying this principle (in the form known as the principle of virtual velocities) to the determination of the bending moment in the case of a loaded beam. Nowhere has the author been more successful in his simple mathematical treatment than in the chapters which deal with the strength and deflection of beams, and the power possessed by a combination of the mathematical and the graphical methods could hardly be shown more strongly than by the proof, given without the use of the calculus, of the most general form of Clapeyron's Theorem of Three Moments.

The fundamental theorems of the theory of elasticity are presented in an equally simple and elementary way. In describing the behaviour of matter strained beyond the elastic limit, a brief account is given of the mode of rupture of different classes of bodies when loaded so as to exceed that limit, and the information here furnished, as in all the other descriptive parts of the book, is brought up to the level of our present experimental knowledge.

The concluding chapters treat of the transmission and conversion of energy by fluids, and contain a brief account of the ordinary propositions in hydraulics and pneumatics, together with the outlines of the theories of hydraulic motors and of heat-engines. The flow of liquids and gases through pipes is also dealt with.

The aim of the book excludes any detailed description of machines, although the drawings of machines are, as a rule, working drawings, the desire being to elucidate the principles and theory of machines in general, but incidentally much valuable descriptive matter is introduced, and the illustrations are in all cases derived from actual machines and structures. Thus, among other valuable topics of practical interest we have an exposition of the theory of fly-wheels, centrifugal regulators, dynamometers, the balancing of machines, and of impact, this last being illustrated, amongst other examples, by the action of a gust of wind on a vessel.

At the end of each chapter we find a selection of well devised and admirable examples, most of them so framed as either by way of illustration to bring into prominence particular parts of the text or to show the influence in special cases of modifying causes. This collection, which must have taken much time and trouble to prepare, is by no means the least useful part of the book, the value of which is yet further increased by the full list of authorities for reference which is appended to each chapter, which will assist the student in extending his studies in any special direction.

This book may be recommended not only for the admirable mode of treatment of that which it contains, but also for the exclusion of that which does not find a place there. The same knowledge of the needs of a reader beginning the study of applied mechanics which has led to the selection and arrangement of the topics introduced, has led to the omission of other parts which, though useful and interesting in themselves, are not necessary to be mastered on a first approach to the subject. We could wish that the proofs had been more carefully revised, so that a number of, for the most part trifling, though tiresome, errata might have been corrected. A careful perusal of the volume leads us to express almost unqualified praise of this latest addition to the English literature of applied mechanics.

J. F. MAIN

#### OUR BOOK SHELF

*Graphic and Analytic Statics in Theory and Comparison.*

By Robert Hudson Graham, C.E. (London: Crosby Lockwood and Co., 1884.)

THIS is an extensive treatise for the use of engineers, the distinguishing feature of it being that graphic and analytic methods are both employed. The first part (30 pp.) deals with the principles of graphic statics, and contains some well-chosen examples of the beautiful method of reciprocal figures. The second part (50 pp.) treats of the stresses of roofs and bridge structures, both methods being employed. The third part (290 pp.), which for some reason is called comparative statics, consists of eight chapters, the subjects of which are direct stress (elongation of bars, &c.), couples, composition of forces, centre of gravity, moments, straight beams and girders, solid girders in equilibrium, and wind pressures. Throughout the book there are interspersed collections of valuable exercises with their results.

The most manifest defect of the work is a prevailing inaccuracy of expression. With such a subject this is quite inexcusable, and is sure to be found excessively trying to the patience of a student. It is not at all due to want of mathematical knowledge on the author's part, so that, as might be expected, he is perfectly unconscious of it. Ludicrously so indeed; for in the preface he tells us



that "the language used has been carefully studied with a view to simplicity and clearness," and explains how there came to be in his eye such a mote as "*angular-point*," without making the most distant reference to a store of *beams* sufficient for a rather massive engineering structure.

The choice and arrangement of the matter, too, cannot be commended. Elementary integrations are performed at full length, which may be done by the reader himself if he knows anything of integration, and which are useless if he does not. The expression for the radius of curvature in terms of  $dy/dx$  and  $d^2y/dx^2$  is used at p. 252, and it is not until forty pages farther on that we find the usual elementary explanation of rectangular co-ordinates, the construction of a curve from knowing simultaneous values of  $x$  and  $y$ , and the meaning of  $dy/dx$ . This defect is really not distinct from the other: both are the consequence of a certain logical haziness of mind which may not, and we believe does not, detract from the author's skill as an engineer, but which is certain to be fatal to his success as an exponent of engineering science.

Had the main matter of the book been worthless or commonplace it could have been summarily dismissed; but there is so much evidence in it of ability and power of work that one eagerly wishes to see the style and structure of it improved. We trust a second edition may be called for, and that for the preparation of it the author may be induced to associate himself with some one having the necessary logical clearness and pedagogic skill to make it what it might easily be—an admirable text-book.

#### LETTERS TO THE EDITOR

[The Editor does not hold himself responsible for opinions expressed by his correspondents. Neither can he undertake to return, or to correspond with the writers of, rejected manuscripts. No notice is taken of anonymous communications.]

[The Editor urgently requests correspondents to keep their letters as short as possible. The pressure on his space is so great that it is impossible otherwise to insure the appearance even of communications containing interesting and novel facts.]

#### School Museums

WHILE the very valuable display of educational appliances is still on view at the Health Exhibition, I should like to draw attention to the school museums which are becoming now an important element in the teaching of science. In Mr. Lant Carpenter's papers they were only slightly alluded to, though he did full justice to the technical exhibits. In the recent Instructions to Her Majesty's Inspectors it is laid down that an infant school which deserves to be considered "excellent" and to receive a corresponding merit grant should have a cabinet of objects which it is suggested should be partly collected by the children themselves. This of course is making teachers anxious to form such collections, and the London School Board supplies a cabinet wherever there is a promising nucleus for such a museum; it also supplies to any teacher that desires it a small box of chemical apparatus for making simple experiments on these objects, with instructions for the use of the different pieces of apparatus. One of these sets of apparatus forms part of the exhibit of the London Board. Of course the collection of the infants' department will be of a miscellaneous character, but in the museums that are now being formed in many of the boys' and girls' departments something better may be aimed at. The School Cabinet in Room No. 4 is filled principally from the schools in the neighbourhood of South Kensington. There are stuffed birds and a small crocodile, together with neatly-mounted skulls of animals, and specimens of corals, shells, and sponges, all from the collections at Park Walk, Chelsea. From other schools there are the skeleton of a rabbit dissected by a boy of eleven years of age, insects, reptiles, and other objects. There is also a collection from the Silver Street School at Kensington, contributed by scholars, teachers, and managers, comprising colonial products of various descriptions, specimens of different kinds of wood, many of them cut from the trees blown down by the great storm that was

so destructive in Kensington Gardens in the autumn of 1881. There are also specimens of horseshoes with their appropriate nails, and illustrations of the successive processes in the manufacture of iron, cotton, and jute. These are all properly named and labelled by the schoolmaster. The lowest shelf of the cabinet contains illustrations of the geology of Peckham, ranging from the sands and gravels of the ancient Thames, the London Clay, the Woolwich and Reading beds, and the Thanet Sands, down to the Chalk. These form part of a fine collection at the Nunhead Passage Board School, Peckham. From the same school also there is a separate cabinet of minerals, which is displayed in the corridor. Some of the training colleges have formed good museums, as is evidenced by the collection from the Wesleyan College in Westminster.

In the further development of these museums two things may well be borne in mind:—(1) In addition to the more miscellaneous collections got together by the children and friends of the school, there should be supplied typical specimens for more systematic instruction. The Japanese exhibit such a collection of zoological types. (2) The special industries of the neighbourhood should be well illustrated in these museums. That this is well carried out in France and Belgium is shown by the contributions to the Exhibition from these countries, and especially by that of the Brothers of the Écoles Chrétiennes.

At the Educational Conference an afternoon was devoted to this subject. Dr. Jex-Blake described a Museum of Science and Art which has been formed at Rugby School, and in the discussion which followed particulars were also given of the loan collections for schools now being organised by the Liverpool School Board, of the Communal Museums, which are an important development of the French School Museums, and of a large Educational Museum which has lately been organised at Madrid. All these show the gradual, but sure, advance which is being made all along the line in the objective teaching of natural science.

August 14

J. H. GLADSTONE

#### The Red Glows

I HAVE recently been staying at Zermatt and have observed the great corona or circle round the sun mentioned by your correspondent, Mr. T. W. Backhouse, in NATURE for August 14 (p. 359). It was very distinct on July 29, both at Zermatt and on the Garnergrat, and likewise on the four following days. On August 3 rain fell in the evening, but the night became cloudless; on the 4th the corona had gone. I noted the following points:—

(1) The colour of the circle was like the red of clean copper when it has become coated with suboxide; this faded away into what appeared brown against the blue sky. (2) Immediately surrounding the sun and between it and the circle the sky was blue. (3) The spectroscopic directed towards the blue sky or a white cloud showed a complete absence of the bands lying near B, C, and D, which indicate the presence of water vapour. (4) A band appearing like a broad line was observed between D and E, distinct, but of lesser density than it usually appears at lower elevations. (5) There did not appear to be any marked difference in the intensity of the colour of the corona when viewed on the same day at altitudes varying between 6000 and 10,000 feet. (6) After rain had fallen on the evening of August 3 the almost cloudless sky altered in appearance; in that part close to the sun it appeared whitish, and the whiteness diminished as the distance from the sun increased, until it had faded away into blue. (7) On occasions when there were fleecy clouds in the sky during the visibility of the corona, the clouds as they approached the corona appeared of a pale but very vivid green. This colour effect was due to contrast.

Savile Club, August 15

W. N. HARTLEY

#### Remarkable Raised Sea-Bed near Lattakia, Syria

IN reference to the changes which have taken place along the coast of Syria and Palestine in recent times, the following letter from Dr. Post, of the Syrian Protestant College, Beirut, descriptive of beds of shells now living in the Mediterranean may prove of interest.

Geological Survey Office, Dublin

*On a Deposit of Marine Shells in the Alluvium of the Lattakia Plain, in Syria*

The Plain of Lattakia extends from Jeblah, a few hours south, to the chalky ridge which forms the southernmost of the roots

EDWARD HULL

of Mount Cassius, and separates it from the first of the valleys of that chain, the Wadi Kondil; and from the Mediterranean on the west to the Nusairy Mountains on the east. A little to the north of Lattakia the plain juts out into the sea, in the Ras Ibn Hani. The portion of the plain north of Lattakia is low, flat, and separated from that lying east and south-east of the town by a low ridge which divides it from the valley of the Nahr-el-Kebir. The eastern and south-eastern portion of the plain is traversed by three streams, flowing south-south-west from the Nusairy Mountains, and emptying into the Mediterranean east of the meridian of Lattakia. The first of these is the Nahr-el-Kebir, the second the Nahr-el-Snowbar, and the third the Nahr-el-Beidha. The surface line of the plain rises gradually from the western limiting ridge of the Nahr-el-Kebir to the base of the mountains, about five hours (by camel) east of Lattakia. The plain, however, in this portion is so channelled by the deep valleys of the above-mentioned streams and their affluents that it can only be called a plain with reference to an ideal surface tangent to the tops of its hills, or rather ridges, which occupy but a small portion of the total area. The height of the ridges near the centre of the table-land is about 350 feet, and increases gradually, with each successive ridge, until the foot of the mountain is reached. The flanks of these ridges are steep, often at an angle of 45°, and the bottoms of the main streams on the parallel of Lattakia are about 100 feet above the sea.

The soil of this table-land is a tenacious clayey loam, the product of alluvial deposit from the streams which now flow through its valleys. The deposits of marine shells are found at various points in the valleys of all three of the streams flowing through this plain. In my recent visit to some of these localities with Dr. Dodds of Lattakia, my aim was rather to survey the general character of the sites and the nature of the deposits than to make an exhaustive collection of the species, which would require much time and labour.

The nearest locality is in the basin of the Nahr-el-Kebir, about an hour and a half north-east of Lattakia. Dr. Dodds has visited it, and found it less productive than that which we chose for our search. Our route lay nearly due east from Lattakia to a village called el-Qutrujeh, three hours away from the town. At a distance of about an hour and a half from Lattakia we came upon a detached mass of conglomerate, the clay of which was barely solidified, containing many of the species of shells and corals which we afterwards found loose in the soil. The mass was about two feet long by a foot broad and six inches thick. It was the only one we found, and the only one found by Dr. Dodds in all his journeys through this plain. Near it were many detached shells, but of two or three species only. The most productive locality is the sides of the ridges east of el-Qutrujeh. What seems most curious is that the shells are almost all found between the levels of 150 and 250 feet (measured by the aneroid). We found few above 250 feet, and those below that level were manifestly carried down by water.

The shells are found loose on the surface of the soil, or projecting from the steep slope of the hillside, associated with recent snail-shells. In a subsequent article I hope to give the names of the species found.

So far as I know, no similar deposit has been found in the alluvium of Syria. In a recent journey through Northern Syria we searched in vain for any traces of marine shells in the western portion of the Lattakia Plain and the valley of the Orontes. I have never seen them in the plains of Akkar, or Esdraelon, or Sharon.

GEORGE E. POST

Syrian Protestant College, Beirût, Syria

### A Carnivorous Wasp

A FEW days ago a wasp, which had created some mild excitement by sailing over our luncheon-table, was observed to seize a fly which was on the back of an arm-chair. It settled on the fly, and when I came to look at the butchery—for I cannot call it a fight—the poor fly was minus its head, and I was in time to see one of its wings fluttering down to the ground. The wasp was stretching over its victim and holding him as a spider might do, and on my approach he spread his wings and carried off the body to the other end of the room, presumably to eat it. Both the wasp and the hou efly seemed to be of the common sort which have given so much trouble to the Queen's lieges in this hot weather. I never heard before of a wasp that imitated the

habits of a spider. Could you tell me if this is an ordinary thing, or whether it was merely an individual eccentricity of this wasp?

August 16

### Intelligence of a Frog

LAST night I rescued a frog from the claws of a cat, and, to my great surprise, it turned, and, after gazing at me for a few seconds, jumped slightly towards me, halting after each leap and looking up into my face. It thus gradually approached, and in about two or three minutes had actually climbed upon one of my feet. Its mute appeal for protection was most remarkable, and could not possibly be misunderstood.

R. R.

Lawton, August 15

### Meteor

LAST night, about 10.20 p.m., I happened to see a meteor worth recording. It moved horizontally, from south to north, across the middle of the western sky (about half way down from the zenith. The sky was cloudless: had that sky not been flooded by the light of a moon that was scarce on the wane, and that extinguished all but very few stars, the meteor would, no doubt, have been a brilliant phenomenon; under the circumstances its splendour was much dimmed. Its course was indicated by a series of small sparkling spangles, which flashed forth beautifully amid the gold-gray glow; the intermission of its lustre is a noteworthy fact.

J. HOSKYNNS-ABRAHAM.

Combe Vicarage, near Woodstock, August 8

### Podalirius minutus

IN Prof. Mayer's recent work on the Caprellidae ("Fauna u. Flora des Golfes Neapal") there is a species figured and described as *Podalirius minutus*, in which the anterior of the three posterior pairs of thoracic appendages are very minute, contain only two joints, and are attached about midway between the two ends of the segment which bears them. With this marked exception this species agrees very closely on all points with *Caprella lobata* and *C. linearis*. My object in drawing attention to it is to ascertain if it has been recorded as a member of the British fauna.

H. C. CHADWICK

### SCALES

SCALES, as used by the architect and surveyor, may be roughly divided into two classes. In the first we have scales of equal parts, in the second scales of unequal parts, by means of which results may be obtained which otherwise would require more or less calculation. The fundamental idea of a scale of equal parts is that any assigned magnitude may be represented by a line of determinate length, and that thus any relation between magnitudes of the same kind may be indicated by a relation between lines in the same ratio. The simplest form in which they can be used is to represent in an enlarged or diminished size the magnitude of a length, as when, for instance, a mile is represented by an inch. By altering in two rectangular directions the magnitude of an area, we obtain a plan of it in which the scales used may be different for the two directions, as when the cross-section of a stretch of country has one scale for horizontal distances, and a different scale for vertical heights.

By introducing the system of coordinates, and representing, according to selected scales, the magnitudes of two or three related and dependent quantities, by lengths measured in two or three perpendicular directions, we are able to represent by geometry the connection between those quantities. This is done in innumerable cases in which the plotting of a quantity is effected and is the basis of the methods employed for obtaining continuous records of changing magnitudes. The important subject of graphical arithmetic and statics, curves of velocity, indicator diagrams, curves of bending moment, &c., as

well as working drawings for machinery and plans for building, all depend for their usefulness on the representation of magnitudes by lines of proportional length. In the widest application of plain scales we may say that the relations between material things are represented by relations between magnitudes in space, and they have in this way been of the utmost service in scientific discovery, presenting to the eye the general nature of the relation between two associated quantities, and suggesting to the mind the probable law of their connection in cases when the law is unknown.

A convenient form in which to use ordinary scales is to have a foot-rule divided into inches, and into the half, quarter, and eighth of an inch, like plotting scales, and then subdivided on the one side decimally and on the other side duodecimally, the edges of the rule being bevelled off so as to enable distances to be immediately pricked off from the scale on to the drawing. Frequently scales are required different from those which are usually made, and it is then necessary to make a scale of the required size on the drawing. This is also required when measurement has to be made on the drawing itself. The scale must then be put on the paper at the same time that the drawing is made, so that if the paper should alter its dimensions, the scale will alter in the same proportion. A valuable adjunct to a scale of this kind is a vernier scale, which enables us to take off small distances with far more accuracy than the ordinary diagonal scales.

Of the scales in the construction of which numbers found by calculation are used, the commonest are those found on the ordinary sector, which contains a scale of chords by means of which an angle may be more accurately set out than by the ordinary plain scale protractor. By it we are enabled also to set off lines proportional to the trigonometrical functions, to solve all questions in proportion, to reduce or enlarge drawings in a required ratio, to describe a polygon of a given number of sides, and to perform calculations by means of the logarithmic line. This last is a line numbered from 1 to 100, the distance from 1 to any number being made proportional to the logarithm of that number. Thus, since the logarithm of 10 is 1 and of 100 is 2, the scale consists of two parts, the part from 10 to 100 being a repetition of that from 1 to 10, since the logarithm of a number between 10 and 100, say 40, is equal to the logarithm of 10 added to the logarithm of the same number divided by 10, such as 4. Thus by the compasses alone we are able to perform, with a certain degree of accuracy, the operations of multiplication, division, finding a third or fourth proportional, and evolution and involution. For instance, to multiply 35 by 27 we should first multiply 35 by 27, or of 35 by 27, in order that the product might be less than 100, and afterwards multiply the result by 10. Taking in the compasses the distance on the scale from 1 to 35 we should set that interval beyond the 27 on the scale. We should then find the leg of the compass furthest from the beginning of the scale pointing to 94.5, so that the product required would be 945. A similar process obviously enables us to perform division. There is, however, some inconvenience in using the compasses, and this may be avoided by the use of the slide-rule. This rule consists of two parts, one fixed, which we shall call A, the other sliding, which we shall call B; on each of these parts a logarithmic line of numbers is placed. Hence by the sliding of the rule we can perform the same operations which would otherwise require the use of compasses. For instance, to divide  $x$  by  $y$ , place the number on B denoting  $y$  against the number on A denoting  $x$ , then the number on A which is opposite to the beginning of B will give the quotient required. Similarly the square root of a number may be extracted by so sliding B that the number on A opposite to 1 on B may be the same as the number on B which is opposite the number on A, the square root

of which is required. The rule may be arranged in other ways so as to give at once the squares of numbers, the lengths of the spaces being made proportional to the logarithms of the squares of the numbers indicated. This is used, for instance, in finding the content of timber.

A slide-rule which has lately been devised by Major General Hannington, whilst remaining very compact in size, is capable of much greater accuracy. Here instead of one very long rule, the rule is divided into a number of parts which are placed under each other, each part being a continuation of the part above it; the slide also consists of a number of parts arranged under each other, consisting of a set of bars with spaces between, which are united at the extremities by cross pieces. The bars on the slide fit into grooves in the fixed part or stock, and are so arranged that the numbers on the stock and on the slide both begin together, although the former is longer than the latter, in order that in every position the slide may have a part of the stock opposite to it. The use of this "extended slide-rule" is the same as that of the ordinary rule, but in the case of the largest which is made, it is as exact as a rule ten feet long, whilst it is compactly arranged, so as to be only one foot long. By this rule all the operations performed by the ordinary slide-rule may be effected, but with much greater accuracy. On account of this it would seem as if this rule ought to become very popular when its merits become known.

The graduating of a scale so that the distances from the end of it may be proportional to the logarithms of the numbers which are marked on it, which is the principle of the slide-rule, is evidently capable of a greatly extended application, and different scales may be devised intended for different purposes. Thus a set of three scales has been devised by Mr. Lala Ganga Ram, intended for the use of engineers, architects, and builders. The first of these is intended to show at a glance the scantlings of timber in beams and joists, and to obtain the stresses in trusses. The principle employed is correct, and the results obtained are very approximate. The depth and breadth of a beam sufficient either for strength or stiffness, can be found by the same rule. It has on the reverse side a scale, by means of which the stresses in the principal rafter and the beam of a king post truss may be found, and then the same quantities may be determined for trusses of different form by multiplying by a certain coefficient marked on the edge of the scale. This gives without any difficulty the maximum stresses coming on the principal rafter and tie-beam, and is all that is usually required, since the scantlings or minor components of a truss are generally determined from practical rather than from theoretical considerations. The second scale is designed to give the thickness of retaining walls. By means of information contained on the back of it the thickness may be found for various forms of wall and kinds of loading. Here again the method of using the scales could not be simpler, and the results are such as agree with calculation. The third of the set enables us to find the stresses (or, as they are called by the inventor, in accordance with ancient custom, strains) on girders. When we state that this scale enables us to ascertain the stress on the flanges at any point of a beam up to 200 feet span, and also the shearing stress at any point of beams with different systems of bracing under both uniform and travelling loads, and that this is effected by merely sliding the scale, it is evident that we have here a means of obtaining at sight results which would otherwise require a considerable amount of calculation. The results are such as, for all practical purposes, seem to be abundantly accurate.

The principle of the slide-rule is thus one which is susceptible of almost indefinite application. It may be used in all cases when the results we wish to attain depend on calculations for which logarithms are ordinarily used

—in just those cases, in fact, in which calculation is laborious. It has the defect of logarithmic calculation in a very exaggerated degree, inasmuch as it is not accurate, but in very many cases this is of no great importance, since the degree of accuracy attainable is abundantly sufficient for all practical requirements. Scales possess one great advantage over methods of calculation, in that it is not possible to make the mistakes which so easily enter into arithmetical calculations. If they be accurately constructed, the modes of using them are so simple that there is scarcely a possibility of making a mistake, and we can predict beforehand the degree of accuracy which may be relied on. For engineering and other simple calculations we believe that these scales, and others like them, will be more and more used as they become more widely known.

#### THE FISHERY BOARD FOR SCOTLAND

THE second Annual Report of the Fishery Board for Scotland has just been issued, and contains much of scientific as well as economic interest.

The first Royal Commission on British Fisheries was founded in 1630. Immediately after the Union the fishing industry almost ceased to exist, owing apparently to the enactment of salt duties. In 1727 an Act was passed, by which the Board of Trustees for Manufactures and Fisheries was created, which, besides encouraging and superintending the fisheries, was empowered to pay certain "bounties" to the herring "busses," and offer premiums to the fishermen who first discovered herrings during each season at the different parts of the coast. In 1808 "An Act for the further encouragement and better regulation of the British White Herring Fishery" was passed. The Commission appointed to carry it into effect had charge of the whole fisheries of the British coasts, and later of the Isle of Man, and, in addition to granting bounties, had 3000*l.* placed at their disposal for encouraging the fishermen to use larger boats, so that they might go further out to sea. The Commissioners stationed officers at the chief coast fishing centres both in England and Scotland, and later two officers to the port of London, from whence large consignments of herring were sent abroad. The Admiralty provided a ship of war to assist in the work of superintending, and in 1815 a cutter was obtained for use in the Firth of Forth, and afterwards at other parts of the coast. Whatever influence the Commissioners had in improving the supply of fish and in developing the fisheries cannot now be estimated, but there can be no doubt that they rendered immense service in collecting statistics, which were till recently the only reliable fishery statistics extant, and of sufficient value to have justified the existence of the Board of Fisheries, even though all other work done were left out of consideration. From the statistics so collected, a valuable chart (Appendix A, Table VIII.) has been prepared by Mr. Robertson, one of the clerks of the Board, which shows at once the take of herring from 1809 to 1882; while Appendix C gives fresh statistics of the quantities and values of white fish and shell-fish. In 1820 the officers were instructed to take the cod and ling fishery under their charge; in 1821 the bounty for encouraging deep-sea fishing was withdrawn; in 1830 all bounties were repealed, and part of the money set aside for the erection of piers and harbours. In 1839 the Secretary of the Board of Manufactures was appointed Secretary of the Fishery Commissioners, and soon after this the Commissioners began to direct their attention to some of the hitherto neglected problems connected with the fisheries. In 1836 the question arose whether or not sprats were young herring, which Dr. Knox, who was appealed to, decided in the negative. This question having led the Commissioners to take an interest in the young herring, and to see the necessity of gaining some

definite information as to the growth, food, and habits of the fish, Mr. Henry Goodsir carried on investigations in the Firth of Forth during 1843-44, from which it was ascertained that the food of the herring consists chiefly of young Crustacea. From the Report of 1846 it is evident that the Commissioners were acquainted with the fact that the herring ova sink and adhere to whatever they come in contact with. In 1850 the English stations were discontinued, and in 1856 another step in the right direction was taken, at the request of Dr. Buys Ballot, who invited those engaged in the great herring fishery to make observations in order to ascertain the circumstances likely to lead to the most profitable fishing and to enable them to make a herring chart. According to instructions issued by the Board of Trade, samples of herring collected on various parts of the coast of Scotland were forwarded to it, but no record is made of their examination. In 1800 complaints of the effects of trawling for white fish in the spawning grounds having led to another inquiry, Prof. Allmann decided that there was no evidence to show that trawling was likely to do injury to the spawning ground. No continuous investigations were, however, carried on by the Board, a new complaint being merely followed by a new inquiry or new Commission. Had the Board been provided with funds necessary to carry on continuous investigations as to growth, food, and habits of the herring and other useful fishes, much valuable information might have been obtained and great expense of Commissions of Inquiry avoided. It is therefore a matter of surprise and regret that, notwithstanding the example of other States, the influence of the Fisheries Exhibitions, and the demand for more information, the Treasury has not yet provided the new Board with sufficient funds. Another agitation arose in 1860, which led to the appointment of Prof. Allmann and Dr. Lyon Playfair, C.B., to inquire into the effects of trawling at the Fluke Hole, Pittenweem, and about the same time Dr. Playfair and Vice-Admiral Henry Dundas were requested to inquire into the claims of the sprat fishermen of the Firth of Forth. The agitation continuing, a Royal Commission, consisting of Dr. Lyon Playfair, C.B., Prof. Huxley, F.R.S., and Lieut.-Col. Francis Maxwell, was appointed in 1862 to inquire as to "the operation of the Acts relating to trawling for Herring on the Coasts of Scotland." The Report of this Commission is especially interesting, because it contains the results of the inquiries made by Prof. Allmann during the winter and spring of 1862 as to the nature of herring ova. The investigations made by him proved that the spawn of the herring "was deposited on the surface of stones, shingle, and gravel, on old shells and coarse sea-sand, and even on the shells of small living crabs and other Crustacea," and that it "adhered tenaciously to whatever matter it happened to be deposited on." The Report also contained a valuable chapter on the natural history of the herring, in which it is pointed out for the first time that there are two principal spawning periods, an autumn period with August and September as the two principal months, and a spring period with February and March as the principal months.

In 1873 the Scottish Meteorological Society began a series of inquiries with a view of determining how far the temperature of the sea and other meteorological conditions affect the migration of the herrings. From information obtained it was concluded (1) that the catch of herrings is less during any season with a high temperature than during a corresponding season with a low temperature; (2) that if the catch of herrings is higher in one district than in the other, the catch is greatest in the district with the lowest temperature; (3) that when the surface temperature is higher than the temperature lower down, the herrings seek the deeper water. It will be seen from the foregoing statement that the officers of the old Board were not utilised for making investigations. Important facts were however established as to (1) the

nature of the spawn; (2) the periods of spawning; (3) the food of the herring. In 1882 the Board of British White Herring Fishery having been dissolved, the present Fishery Board for Scotland was established, to carry on the work of superintending the fisheries, and also to "take such measures for their improvement as the funds under their ministrations may admit of." The Board soon recognised the absolute necessity of obtaining accurate scientific information as to the habits and life-history of the food fishes, and therefore appointed a Committee consisting of Prof. Cossar Ewart (convener), Sir James R. Gibson Maitland, Sheriff Forbes Irvine, and J. Maxtone Graham, to carry on scientific investigations.

The preliminary report of work done in the autumn of 1883 and at Ballantrae has been already given in NATURE. The Admiralty has been pleased to provide a gunboat, H.M.S. *Jackal*, Lieut. Pritchett, R.N., commander, to help in the investigations and inspect the spawning grounds, and the Board has also at its service the cruiser *Vigilant*, both of which vessels have done excellent work, though it is desirable that they should be replaced by others more capable of sea-going service. The Board is fortunate in having in its service a large staff of intelligent officers not only familiar with all the practical aspects of the fishing industry but deeply interested in the scientific work of the Board, which they aid to their utmost power. The future lines of inquiry which the Board hope to undertake include (1) the examination of the spawning beds round the Scottish coast; (2) the determination of the food of useful fishes; (3) the investigation of percentage of young herring, &c., destroyed by present modes of fishing; (4) the influence of sea-birds, &c., on supply of fishes; (5) study of spawning, nature of the eggs, and general life and development of herring, &c.; (6) best means of restocking deserted fishing grounds; (7) of increasing artificially the supply of shell-fish; and (8) of inquiry into fungi, &c., hurtful to fish life. The Board is fitting up a marine station at St. Andrew's, where Prof. McIntosh will make investigations for the Board, whilst similar work will be carried on in the Moray Firth. We trust that the impetus given to and the interest excited in the work of the Board may produce most favourable results, both economic and scientific.

We hope to return in a future number to some of the papers of specially scientific interest contained in this Report.

#### THE HISTORY OF A TYPHOON

PÈRE DECHEVRENS, the indefatigable head of the Meteorological and Magnetic Observatory at Zikawei near Shanghai, has just published the first part of a work dealing with the typhoons of 1882. The present instalment is confined to those of the months of July and August in that year. The various plans and maps showing the course of the typhoons, and the height of the barometer at various times during their progress in different places, are so "fabulously complicated," to use the writer's phrase, that he fears more than one reader will regard his pamphlet as a work of imagination. Père Dechevrens, however, has had the advantage of observation; made in China, Japan, and the Philippines by captains of vessels, lighthouse keepers, Customs officers, &c., such as have never before been made of any cyclone. Chinese typhoons, as he points out, fortunately for the meteorologist, though unfortunately for the navigator, ravage places visited by the ships of all nationalities, and hence with a little arrangement and organisation these phenomena may be easily studied in these regions. The Shanghai Chamber of Commerce and Sir Robert Hart have arranged for a regular supply to Père Dechevrens of a regular series of meteorological observations, and one of the earliest results is the pamphlet now before us. As a consequence of these wide and varied observations, the

writer, while acknowledging the work of his predecessors, such as Spindler in Russia, Knipping in Japan, and Faura in Manila, claims that, while they were only able to give the history, as it were, of incidents in the life of a typhoon, he, thanks to the vast number and extent of the documents placed in his hands, has been able to connect these various fragments, and to trace the history of several typhoons from their cradle in equatorial maritime regions to their grave in the North Pacific Ocean. This, in his own words, is what Père Dechevrens has now done in his pamphlet. The first section deals with July 1882, and it is divided into several sub-sections, dealing with the formation of a typhoon on July 5, its progress in the China Sea, and a first separation or offshoot from the main storm, its progress on the mainland of China, the second typhoon of July 10 in the China Sea, and before Hong Kong, in the Formosa Channel, "its flight towards India, and its disappearance in the north of China," and finally an account of a typhoon in Hong Kong and Indo-China. The typhoons of August are discussed in a similar manner in detail, the conclusions being supported by observations made in all parts of the China seas and coasts. There are also a large number of diagrams. In his recapitulation the writer points out that, though he has been speaking of various typhoons, such as that in the Formosa Channel, in Hong Kong, &c., he has really been dealing with only one widespread storm, which, during its life of fifteen days, visited every coast from the equator to Siberia, and from the extreme east of Japan to the western frontier of India. The character which Père Dechevrens gives the phenomenon he has so carefully studied is this:—"It allows itself to stray with the greatest ease outside the straight path. In a truly headlong way it throws itself against all obstacles, gets into difficulties from which it can scarcely extricate itself, wastes its energies in whirlwinds, often powerless, which it abandons readily, goes, returns, hastens, stops still, in a word revolving always in the same circle, until, having expended all its strength, it disappears miserably at that part of the Pacific which in a short time would have been able to give it the necessary vigour to sustain a longer career, and, like many others, to reach the shores of North America, or at least, if retarded by the violence of the North Pacific, as far as Behring Straits." Three facts which this study renders prominent are:—

1. The extreme facility with which these typhoons divide and subdivide.
2. The mutual attraction and repulsion of atmospheric disturbances (whirlwinds).
3. The absence of the south-west monsoon in the Philippine Islands.

In his recapitulation these three points are discussed at some length in the summary, and we merely indicate them here to show the student what he may expect in this painstaking and learned publication.

#### HEALTHY SCHOOLS<sup>1</sup>

THERE can be no more appropriate product of an exhibition which seeks to illustrate the two problems of health and education than a handbook on healthy schools. Within the brief space of 72 pages Mr. Paget has brought together here some of the most important counsels which experience has suggested on structure, drainage, fitting, food, recreation, ventilation, and other conditions on which the health of children in schools depends. No school manager or teacher can read it without much profit; and the executive of the Exhibition has done the community a service by placing within its reach in a succinct and readable form so much practical knowledge and fruitful suggestion.

<sup>1</sup> "Healthy Schools." By Charles E. Paget, Medical Officer of Health for the Westminster and Combined Sanitary District; Honorary Secretary of the Epidemiological Society of London. International Health Exhibition Handbook Series. (Clowes and Sons.)

Mr. Paget divides his handbook into two parts, the first relating to the right construction of schools, and the second to their right administration. Under the former head he discusses in succession the questions of the site, soil, and aspect best suited for the erection of schools; the due provision of light and of air, and the importance of a good supply of water both for drinking and for cleanliness. His estimate of the space required for each child appears to be excessive, and to be almost the only feature of his work which betokens a lack of practical experience, and a striving after an unattainable ideal. It is well known that the minimum space recognised by the Education Department under any conditions as sufficient is eight square feet of area, or eighty cubic feet of internal space for each child; but in schools built by Boards, or out of funds levied by rates, the Department insists on a larger provision, *i.e.* ten square feet of area and 120 cubic feet. Any one familiar with well-planned Board Schools of a modern type knows well that this space suffices to secure ample room for movement, for change of position for the arrangement and supervision of classes, and for a due supply of air. It will, therefore, be somewhat startling to school managers to learn that in Mr. Paget's opinion this provision is absurdly insufficient, and that 800 or even 1,000 cubic feet per scholar would not be too much. Perhaps it is wrong in such a connection to dwell on the question of expense. But when it is considered that the building of a good school, apart from the cost of the site, requires an expenditure of 10% per head—a great London Board School for, say, 500 boys, 500 girls, and 600 infants, in three stories costing about 16,000*l.*—it will be easy to compute what would be the charge on the rates if each of the 1,600 children were to be furnished with an area of forty or fifty square feet in a room twenty feet high. The estimate is clearly enormous, and can certainly not have been founded on an observation of the actual dimensions of any school, whether elementary or secondary. Apart, however, from the consideration of expense, it may well be doubted whether such vast space would in any circumstances be needed. For the purposes of teaching and organisation a certain compactness of arrangement is clearly desirable, and the supervision of the head teacher becomes more difficult and less complete in proportion to the size of the area over which the work of the school is spread. These are considerations, however, which it would be right to overrule, if on sanitary grounds there were any necessity for such large spaces. But when the ordinary precautions which Mr. Paget suggests for insuring light cheerfulness and ventilation are taken, it is scarcely credible that any such necessity actually exists. Mr. Paget's estimate of the amount of cubic space needed in boarding schools, in cubicles, and dormitories, is not so large in proportion, and is indeed not wholly consistent with the demands he makes for space in a purely day school. Nevertheless, by placing it at 1,200 cubic feet per scholar, he practically condemns the arrangements in almost every boarding school in England; for the usual requirements are thought to be well fulfilled with exactly half that amount.

On the extent of the window-space, the provision of fresh air, the right construction and care of offices, the colouring of walls, the admission of light, the right attitude of the scholar, and the distance of his book in reading or writing, and the form of desks, the handbook abounds in judicious and definite suggestion. It is much less full and useful, however, in regard to the fitting of playgrounds, the organisation of games, and recreations generally. Teachers will be disappointed to find how little of practical guidance the book affords as to the best and healthiest forms of recreation, and the proportion which should exist between regulated gymnastics and the free spontaneous exercises which all boys and many girls can readily discover for themselves. On diet, bathing, sanatoria, and many details which specially concern boarding

schools, Mr. Paget's advice is especially valuable and complete. His estimate of the time per day which may with full regard to all considerations of health be given to intellectual pursuits, will surprise some of his medical brethren who have been complaining of late of the ordinary school hours as excessive, and have been denouncing little home-tasks of half an hour long in the elder classes as a "burden too grievous to be borne." He computes that between the ages of seven and ten five hours a day is probably sufficient, and between the ages of ten and fifteen seven hours. When it is considered that even the elder and more diligent pupils in an elementary school are never under instruction more than five and a half hours a day for five days in the week, and that the hardest home-lessons ever given in such a school do not occupy nearly an hour a day; and when it is also considered that even in the girls' high school—in which the justest complaints have been made of excessive home-tasks lasting sometimes two hours—the actual attendance in the school itself is generally limited to four hours, it will be seen that the absurdly exaggerated modern outcry about over-strain receives no countenance from Mr. Paget. His own good sense and experience, in short, lead him to recognise the fact that after all the chief business of the boy's or girl's life is training and instruction; and that provided all needful precautions are taken for right distribution and variety of work, and for securing all the conditions of healthy and cheerful life, the hours usually devoted to education in England do not exceed a reasonable amount, but rather fall short of them.

It is not the least of the merits of the book that its suggestions are put forth modestly, and with a remarkable absence of dogmatism. When the writer is not quite sure of his ground he is careful to say that his remarks are tentative and suggestive only, intended to awaken interest in the subject rather than to exhaust it; and to lead the way to a fuller and more careful study of the whole theory of school hygiene with the aid of the numerous appliances now on view at the Exhibition. This reticence on points not yet finally settled tends greatly to increase the confidence of the reader in Mr. Paget's judgment on those topics on which he expresses a decided opinion.

#### NOTES FROM THE LEYDEN MUSEUM

IT was a very happy thought of the late Prof. Schlegel to publish under the above title a quarterly record of the work done in the Royal Zoological Museum of the Netherlands at Leyden. The publication commenced in 1879, and the five yearly volumes before us, edited by Prof. Schlegel, will be one of the several enduring monuments to his memory. To all those interested in zoological research, the important treasures of the Leyden Museum are of necessity known. However indebted the Museum was to the well-known labours of Temminck, it is to the zeal and knowledge of Schlegel that it occupies its present high position among the museums of Europe. A very few words will show the importance from a zoological standpoint of these volumes, which contain on an average 250 pages each. The first volume contains descriptions of new species of mammals, birds, reptiles, insects, crustacea, and worms. These descriptions are for the most part by the director of the Museum and his Assistants, but help seems also welcomed from every hand, and the well-known names of R. B. Sharpe, P. Herbert Carpenter, Dr. D. Sharpe, Rev. H. S. Gorham, Prof. J. O. Westwood, occur among the British contributors. Besides containing numerous diagnoses of new species, these notes also from time to time present us with very important critical essays. Thus, in vol. i. Dr. A. A. W. Hubrecht's "Genera of European Nemerteans critically revised, with Descriptions of New Species," with a first appendix in vol. ii., is of great interest. It gives, so far

as European forms are concerned, a classification of the genera and details of the species found at Naples. With regard to a genus of De Blainville, *Lobilabrum*, which was founded on a single specimen of the species *L. ostrrearum*, and which has never been again met with, the following instructive facts are recorded. This genus was easily distinguished from all others by the possession of a blunt snout with two horizontal lips at the extremity, both of them bilobed, and apparently with tentacles. The slit between the lips was described as being a continuation of the lateral fissures of both sides of the head. In other respects the genus bore a strong resemblance to species of *Lineus* or *Cerebratulus* living in the same localities. One day at Naples Dr. Hubrecht was fortunate enough to come across a second specimen of this rare worm, which, like De Blainville's specimen, was dredged from a bottom covered with bivalve shells. It was duly figured and preserved, and longitudinal sections were made of its curious snout. Soon after he was struck by the extraordinary resemblance in habitat which existed between another Nemertean (whose anterior extremity exactly answered to that of a *Lineus* or *Cerebratulus*, and carried two well-pronounced fissures), and this single specimen of *Lobilabrum*. Once the doubt was raised, Dr. Hubrecht pursued the investigation by purposely cutting off the tip of the snout in one of the last-mentioned species, in a direction vertical to the body axis. Immediately the curious arrangement of the lobed and tentaculated lips which had hitherto been limited to the genus *Lobilabrum* appeared, the animal operated on lived for several weeks, and afterwards longitudinal sections showed that an epidermal covering had made its appearance identical with what had been found in the *Lobilabrum* specimen. Considering these results with the fact of the habitat amongst bivalve shells, Dr. Hubrecht concluded that the genus of De Blainville had been founded on a specimen the tip of whose snout had been severed by an oyster into whose open shell it was stealthily trying to penetrate.

Amidst the many contributions to vol. ii. of especial importance is a memoir by G. C. J. Vosmaër, on the sponges belonging to the family of the Desmacidinæ; siliceous forms known by bow, anchor, and bihamate spicules with some criticisms on the works of Bowerbank and others. It is a well-known fact that the late Mr. Bowerbank did "not sufficiently understand the German language," and his remarks on Oscar Schmidt's important works in the preface in vol. iii. of the "Monograph of the British Spongiæ" were rendered still more negligent by the many typographical errors. Surely Vosmaër is wrong in the assertion that "only one man in England, Sir Wyville Thomson, has declared himself in favour of Schmidt's views" on classification, and we would venture to assert that of the classifications of the siliceous sponges invented by Bowerbank, Gray, or Carter, none have replaced that of Oscar Schmidt as recently modified. While promising to publish a more extensive memoir on the Desmacidinæ, with the indispensable illustrations of the new species, Vosmaër's present enumeration of the species is of very great value. As most of Bowerbank's type species are in existence, we trust that Vosmaër may consult them ere publishing his final memoir, as while we acknowledge as a fact that Dr. Bowerbank was a most accurate and painstaking observer, and a fairly good recorder of what he saw, experience has proved that he often, from one cause or another, overlooked even quite easily recognised characters. Vosmaër accepts 16 genera and enumerates 162 species. Of these he naively remarks:—"As the result of my study of them, plenty of synonyms have been described, but I have never felt the necessity of making two species from one!" F. E. Schulze has given many examples in his splendid studies on the Ceraospongiæ, especially in his "Die Familie der Spongiæ." Both Schmidt and Schulze have demonstrated that the word "species is to be used in a very

wide sense" as regards the sponges. The scientific zoologist will hardly mind how wide, provided the definition thereof is such that, while it embraces all the forms it excludes none; and, despite their heteromorphism—their plasticness, so to say—the sponges are, as a result of good honest work, getting arranged into species and genera that may satisfy the most fastidious critic.

In the same volume of these "Notes" we find a paper by Prof. K. Martin, on a revision of the fossil Echini from the Tertiary strata of Java, which, working anew over the species described some thirty years ago by J. A. Herklots, quite reverses the conclusions of that author; and, instead of all or almost all of the species being different from existing forms, as insisted on by Herklots, Martin has succeeded in "demonstrating that by far the majority of all the well-preserved individuals could be identified with species still living in the Indian Ocean;" and he further mentions, citing the species found, and in addition the Mollusca, Crustacea, and Corals, that these Tertiary strata of Java contain no fossils which have also been found in extra-tropical Tertiary deposits, so that even in the Tertiary period the separation of the fauna of the tropical oceans appears to have been quite as distinct as we find it in the present day.

Vol. iii. contains a very charming account of the habits of the harvest mouse (*Mus minutus*) and of its winter nest, by Prof. Schlegel. It is written—as indeed are very many of the contributions to these "Notes"—in English, but the language of this little history is worthy of the author's name. There are also by Prof. Schlegel some interesting notes on the zoological researches in West Africa, which were carried on under his directions; and an important contribution to our knowledge of the Comatulæ in a memoir on the species to be found in the Leyden Museum, by P. Herbert Carpenter. The collection at Leyden is one of considerable importance, owing to its containing a large proportion of the types of the species described by Johannes Müller in his classical memoir, "Ueber die Gattung Comatula, Lamk., und ihre Arten." It is noteworthy that the whole of the Leyden collection of Comatulidæ were forwarded to Eton for study. For a possible trifling loss that a public museum may now and then sustain in a loan like this, there is sure to be an immense preponderance of gain.

A monograph of the African squirrels, with an enumeration of the specimens in the Leyden Museum by Dr. F. A. Jentink, commences vol. iv. While fairly and equitably reviewing the work on this group by Gray and Temminck he admits but two genera—*Sciurus* and *Xerus*, enumerating sixteen species of the former and three species of the latter genus. The synonymic lists appear to have been made out with the greatest care, of which care a very interesting example will be found in tracing the authority for the species *Xerus capensis* to Robert Kerr, who published his "Animal Kingdom, or Zoological System of the celebrated Sir Charles Linnæus" in 1792. Another contribution of Dr. Jentink which we find space to allude to is a revision of the Manidæ in the Museum. Seven species are described in detail. Under *Manis aurita*, Hodg., we read that it is still questionable whether a *Manis* occurs in Japan. Temminck mentions that Von Siebold sent over to the Leyden Museum two pieces of the skin of a *manis* from Japan, but as these fragments are not now to be found in the collection, it is of course impossible to say to what species they may have belonged. Mr. Serrurier, the director of the Ethnographical Museum at Leyden, informs Dr. Jentink that in the Japanese books at his disposal he finds nothing to justify the conclusion that the anteaters are inhabitants of Japan; but it would appear that the Japanese do introduce them for medical purposes from China. The Japanese also relate that the anteaters catch ants in the following way:—"The *manis* erects its scales and feigns to be dead; the ants creep in between the erected scales, after which the anteater

again closes its scales and enters the water. He now again erects the scales, the ants are set floating, and are then swallowed by the ant eater.

From a list of the Holothurians in the collection of the Leyden Museum, drawn up by Prof. Dr. Hubert Ludwig of Giessen, we find that the majority of the specimens in the Museum were incorrectly named, which is somewhat surprising; it seems also strange that of the species not so very long since described by Prof. Selenka the specimens are either *sine patria* or have the rather indefinite habitat of "Indian Ocean." The collection contains fifty-two species, two being new; most of them were obtained from the Oriental and Moluccan regions.

In vol. v. Dr. Jentink continues his very useful researches on the squirrels in the Museum. This time he treats of the American, European, and Asiatic squirrels; he acknowledges that the profound and extensive studies upon the American squirrels by Allen and Alston have made this group one of the best known among the Mammals; he enumerates ten species from America, forty from Europe and Asia. All the former are represented generally by numerous examples in the Museum, and of the latter only six species are among the desiderata.

The same volume contains "Notes of new species of the genus *Megascolex*, Templeton," by Dr. R. Horst. Very satisfactory evidence is given to show that Schmarida's genus *Perichata* is but a synonym of Templeton's. Nine new species are described, chiefly from Sumatra, Java, and Japan; one, *M. musicus*, is described as living in the high mountain forests at Java, and is said to make a sharp interrupted noise during the night. The natives call it "tjatjing sondaric."

If in calling attention to these important contributions to our knowledge of the treasures of the Leyden Museum we have passed over the very numerous contributions to entomology, it is simply because our space forbids us referring to the immense number of new genera and species herein described; indeed these notes form a perfect magazine of entomology, and we feel sure are long ere this quite well known to all our entomological readers.

#### PRZEVALSKY'S WILD HORSE

GREAT interest is attached to the question of the origin of our domestic animals, and especially to that of the horse—which is generally supposed not now to exist in an aboriginally wild state. Every fact bearing upon this subject is of importance, and the discovery by the great Russian traveller, Przevalsky, of a new wild horse, more nearly allied to the domestic horse than any previously known species, is certainly well worthy of attention.

The horses, which constitute the genera *Equus* of Linnaeus, and are the sole recent representatives of the family *Equidae*, fall naturally into two sub-genera, as was first shown by Gray in 1825 (*Zool. Journ.* i. p. 241)—*Equus* and *Asinus*.

The typical horses (*Equus*) are distinguishable from the asses (*Asinus*) by the presence of warts upon the hind-legs as well as upon the fore-legs, by their broad rounded hoofs, and by their tails beginning to throw off long hairs from the base, instead of having these hairs confined, as a sort of pencil, to the extremity of the tail. Up to a recent period all the wild species of *Equus* known to science were referable to the second of these sections, that is, to the sub-genus *Asinus*, known from *Equus* by the absence of warts or callosities on the hind-legs, by the contracted hoofs, and by the long hairs of the tail being restricted to the extremity of that organ. Of this group the best known species, commonly called wild asses and zebras, are (1) the wild ass of Upper Nubia (*Equus hemionus*), probably the origin of the domestic ass; (2) the wild ass of Persia and Kutch (*E. onager*); (3) the

hemippe or wild ass of the Syrian Desert (*E. hemippus*); (4) the kiang or wild ass of Tibet (*E. hemionus*); (5) the quagga (*E. quagga*) of South Africa; (6) the Burchell's zebra (*E. burchelli*) of Southern and Eastern Africa; (7) the zebra (*E. zebra*) of Southern Africa. As already stated, these seven animals all possess the characters of the second sub-genus *Asinus* as above given, and no recent species of horse referable to the first sub-genus (*Equus*) was hitherto known to exist on the earth's surface, except the descendants of such as had been formerly in captivity.

Under the circumstances great interest was manifested when it was known that Przevalsky, on his return from his third great journey into Central Asia, had brought back with him to St. Petersburg an example of a new species of wild horse, which belonged, in some of its characters at least, to true *Equus*.

This new animal was described in 1881 in a Russian journal by Mr. J. S. Poliatow, and dedicated to its discoverer as *Equus przewalskii*.

The recently issued German translation of Przevalsky's third journey<sup>1</sup> enables us to give further particulars of this interesting discovery.

Przevalsky's wild horse has warts on its hind-legs as well as on its fore-legs, and has broad hoofs like the true horse. But the long hairs of the tail, instead of commencing at the base, do not begin until about half-way

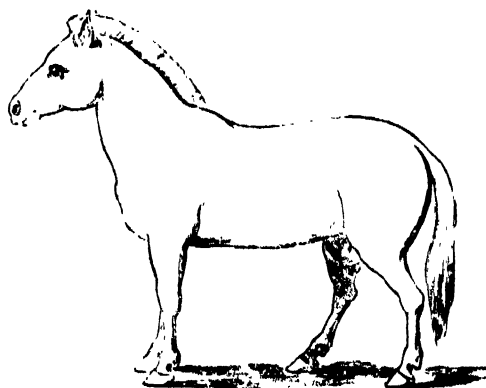

Przevalsky's Wild Horse.

down the tail. In this respect *Equus przewalskii* is intermediate between the true horse and the asses. It also differs from typical *Equus* in having a short, erect mane, and in having no fore-lock, that is, no bunch of hairs in front of the mane falling down over the forehead. Nor has Przevalsky's horse any dorsal stripe, which, although by no means universal, is often found in the typical horses, and is almost always present in the asses. Its whole general colour is of a whitish gray, paler and whiter beneath, and reddish on the head. The legs are reddish to the knees, and thence blackish down to the hoofs. It is of small stature, but the legs are very thick and strong, and the head is large and heavy. The ears are smaller than those of the asses.

Przevalsky's wild horse inhabits the great Dsungarian Desert between the Altai and Tianschan Mountains, where it is called by the Tartars "Kertag," and by the Mongols "Statur." It is met with in troops of from five to fifteen individuals, led by an old stallion. Apparently the rest of these troops consist of mares, which all belong to the single stallion. They are lively animals, very shy, and with highly-developed organs of sight, hearing, and smelling.

They keep to the wildest parts of the desert, and are

<sup>1</sup> "Reisen in Tibet und am oberen Lauf des Gelben Flusses in den Jahren 1870 bis 1880," von N. von Przewalski. Aus den Russischen frei in das Deutsche übertragen von Stein-Nordheim. (Jena, 1884.)



very hard to approach. They seem to prefer especially the saline districts, and to be able to do long without water.

The pursuit of this wild horse can only be carried on in winter, because the hunter must live in the waterless districts, and must depend upon a supply of water from melted snow. As may well be believed, such an expedition during the severest cold of winter into the most remote part of the desert, must take at least a month. During the whole time of his stay in the Dsungarian Desert, Przevalsky met with only two herds of this wild horse.

In vain he and his companions fired at these animals. With outstretched head and uplifted tail the stallion disappeared like lightning, with the rest of the herd after him. Przevalsky and his companions could not keep near them, and soon lost their tracks. On the second occasion they came upon them from one side, yet one of the herd discovered their presence, and they were all gone in an instant.

The single specimen of Przevalsky's horse subsequently procured is now in the Museum of the Academy of Sciences of St. Petersburg, and is the only example of this species in Europe.

#### THE DIFFERENCE BETWEEN THE SEA AND CONTINENTAL CLIMATE WITH REGARD TO VEGETATION

THE difference in vegetation between the sea and continental climate is no doubt best observed in the growth of plants generally cultivated in the temperate zone for different purposes, as every climate has its own region or flora. Whether the climate of a country is favourable to those plants or not is shown, in the first place, by their extension to the north; therefore we shall first endeavour to trace the northern limits of the most important plants, either cultivated in one country and growing wild in another, or cultivated everywhere.

To the first class trees mostly belong; to the second, annual or perennial plants. We begin with trees:—  
1. *Pinus sylvestris*, L. (Scotch pine). Scotland, 59°; Norway, 70° 20'; Kola, 69°; Petchora region, 67° 15'; Ob River, 66°; Turukansk, 65°. The Verkhoyansk Mountains, east of the Lena River (64°), are the eastern limits of this tree.<sup>1</sup>

*Betula odorata*, Bechst. (*alba*, L., var.) (birch). Greenland, 61° (shrub); Iceland, 65° (shrub to ten feet high); Britain, 59°; Norway, 70° 50'; Kola Peninsula, 69° 30'; Kanin Peninsula, 67°; to the Ob River (66°), and from the River Kolyma (68°) to the Peshina Gulf (63°) and Kamchatka; on this peninsula it is a large tree.

*Quercus pedunculata*, Ehrh. (*Q. robur*, L., var.) (common oak). England, 58°; Norway (wild), to 62° 55', and cultivated to 65° 54'; Finland (coast), 61° 30' (Bjorneborg); St. Petersburg, Yaroslav, Perm, 58°.<sup>2</sup>

*Larix europæa*, Dec. (including *L. sibirica*, Ledeb., and *L. dahurica*, Turcz.) (common larch). Norway (*europæa*, Dec.), 66° 5', (*dahurica*, Turcz.), 59° 55', both cultivated; Onega River, White Sea, south-western shore of Onega Lake, Mesen (Kanin Peninsula), 67°; Petchora River, 67° 30'; Ural Mountains, 67° 15'; Kara River, 68° (northern limit in Europe); Yenisei River, 70°; Boganida River, 71° 15'; Chatanga River, 72° 30' (most northern limit of trees on the globe); Anabar, 71°; Olenek and Lena, 72°; Yana, 71°; Indigirka, 70° 45'; Kolyma, 69°; Anadyr, 65°; between Okotsk and Gishiga, 61°; Sakalin Peninsula, 49°; to Jeddo and the island of Kunaschir, 43° 45'. On the shores of Kamchatka the larch is nowhere to be found; in the valleys of this peninsula, however, protected from sea winds, it is a very large tree.<sup>3</sup>

*Pyrus Malus*, L. (apple-tree). Shetland Isles (cultivated); Britain, 57°; Norway, cultivated, 65° 28', wild, 63° 40'; Gulf of Bothnia, 63° 45' (cultivated); Finland, 63° (cultivated), 60° (wild); northern shore of Onega Lake (wild); Narva, 59° 30' (wild); Tver, 56° 45' (wild); Nijni Novgorod, 56° (wild); Kasan, 56° (wild); south-west of Orenburg, 50°; Kopal, Asia, 45°.

*Fagus sylvatica*, L. (common beech). Britain, 58°; Norway, 59°, cultivated, 67° 56'; Sweden, 57°; Königsberg, Poland, South-West Russia, Crimea, Caucasus, Persia.

*Castanea vesca*, Grtn. (chestnut). South Britain, Germany (to the island of Rügen), Austria, Caucasus.

*Populus alba*, L. (abele tree). Britain (wild and cultivated), 56°; Norway (cultivated), 67° 56'; Germany (wild and cultivated), Austria, Russia; Volhynia, Kieff, Charkoff, Tambov, Kasan, Ufa, Altai Mountains.

*Populus tremula*, L. (aspens). Britain, 59°; Norway, 70° 37'; Russia: Kola Peninsula, 69° 30'; eastern shores of the White Sea, 66°; Yenisei, 66°; Kolyma River, 67° 30';<sup>1</sup> Amur River.

*Alnus incana*, W. (hoary-leaved elder). Canada, Norway, 70° 30'; Kola, 69° 30'; Yenisei, 67°; Amur region, Petropaulovsk on Kamchatka.

*Ulmus campestris*, L. (common elm-tree). Britain, 57°; Norway (cultivated), 63° 26'; Russia: Ilmen Lake, south of Moscow, Riazan, south of Kazan and Ufa to the Ural Mountains.

*Tilia europæa*, L. (including *parvifolia*, *grandifolia*, and *intermedia*) (lime-tree). Britain, 57° (*parvifolia*); Norway (wild), 62° 9', (cultivated) 67° 56'; St. Petersburg, Kargopol, Ust Süssolsk, about 62°; Solikamsk, Ural Mountains, about 58° 50'; Verkhoturgi.

*Vitis vinifera*, L. (common grape). Bretagne, 47° 30'; Liège, 50° 45'; Thuringia to Silesia, 51° 55'; South Galicia, South Russia, between about 48° and 49°; Astrakan, Bokhara in Turkestan, 40° (here the vine is cultivated in the open fields<sup>2</sup>); Khiva, 42°; China, 40°; California. This plant cannot stand the extreme continental climate on account of the frost in winter, but wants a very warm or a very long summer (as in California), therefore it cannot be cultivated generally in Britain. California is warmer in summer than some latitudes in Europe.

*Triticum vulgare*, Vill., var. *æstivum* (summer wheat). Britain; Norway, in the fields, 64° 40', in gardens, 69° 28'; Finland, 65°;<sup>3</sup> Dwina River, 63°; Yakutsk, western shores of North America, 55°; Fort Liard, 60° 5' (North-West Territory of Canada);<sup>4</sup> Peace River, 56° 6'; Ontario, East Canada.

*Hordeum vulgare*, L. (including *hexastichum*) (barley). Faroe Isles, 62° 15' (grain seldom ripens); Norway, 70°; western shores of the White Sea, 67°; Ob River, 61°; Yakutsk, 62°; Udskoi Ostrog, near the Okotsk Sea, 54° 30'; Kamchatka (inland), 53° to 54°; North-West American shore, south of Sitka, 57°; Fort Norman, Mackenzie River, 65°;<sup>5</sup> east of Winnipeg, 50°; St. Lawrence Bay, 50°.

*Avena sativa*, L. (oat). Scotland; Norway, 69° 28'; Finland, 69°; Asia, the same latitude as *Hordeum vulgare*; Yenisei, 61°; Yakutsk, Kamchatka (inland); North America, the same latitude as *Hordeum vulgare*.

*Secale cereale*, L. (common rye). Britain; Norway, 69° 30'; Finland, 67°; Mesen River, 65° 45'; Petchora region, 65° 45'; Ural Mountains, 57°; Ob River, 60°; Yenisei, 59° 30'; Yakutsk, Kamchatka (inland); North America, a little south of the latitude of the barley, eastern shores, 50°.

*Solanum tuberosum*, L. (potato). Britain; Norway, 71° 7'; Russia, Pinega River, 65°; Turukansk, 65°; Yakutsk, shores of the Okotsk Sea, Kamchatka, Kadjah Island,

<sup>1</sup> Middendorff, p. 573.

<sup>2</sup> Grisebach, "Die Vegetation der Erde," vol. i. p. 407.

<sup>3</sup> Middendorff, p. 709.

<sup>4</sup> Richardson, "Searching Expedition through Rupert's Land," vol. ii. 267. Fort Liard has an altitude between 400 and 500 feet above sea-level.

<sup>5</sup> Richardson, p. 269.

<sup>1</sup> Middendorff, "Sibirische Reise," Bd. iv. Th. 1, p. 556.  
<sup>2</sup> 16, p. 567.

<sup>3</sup> 16, p. 536.

Sitka Island; Mackenzie River, 65°; Canada; Labrador, 58° 45';<sup>1</sup> Greenland.

*Zea mays*, L. (Indian corn). This plant requires also a very warm summer to ripen its seeds. In England it can only be cultivated as a green vegetable; on the western shores of Europe we can say that the cultivation is only profitable to the 46th degree N. lat., and in the valley of the Rhine it reaches to 49°. In North Germany the grain usually does not ripen. In North America, however, it is cultivated in certain regions with profitable returns up to 51° N. lat.<sup>2</sup> The period of vegetation varies there between seven and three months. To cultivate the varieties of such a short period in Europe is tried, but without result; they were transformed after a few generations into the common corn.

Thus we see that, of the plants just named, the larch, the pine, the birch, and the aspen grow in Siberia, with its excessive continental climate, farthest to the north; yet many of the cultivated plants mentioned above, and almost all those of the temperate zone, are either cultivated or grow wild in the sea climate of Norway, to very high latitudes.

On the north-western shores of America the pine attains a considerable size (island of Sitka), in a climate with continual rain, but partly the same size is observed on the Rocky Mountains (eastern slope), where the climate is wholly changed.

In British Columbia the climate is continental, very cold in winter; yet the same gigantic trees as on the coast are to be found here; precipitation takes place in spring, but the amount is very great.

In California, with its largest coniferous trees of the world (*Wellingtonia gigantea*), rain falls chiefly in winter (November to April). The enormous differences of coast and inland climates of California are not apparently known.

In the southern parts of the Amur region in Asia there is in summer a luxuriant vegetation; the annual precipitation amounts to 27.56 inches (about the same amount as in Germany), the plants much resembling those of Central Europe,<sup>3</sup> and this notwithstanding a winter temperature much lower than observed in the most northern parts of Lapland; but the summer here is much warmer than in Europe under the same latitude, and precipitation occurs only in summer.

In the interior of Siberia the vegetation consists chiefly of coniferous trees; thus the luxurious growth in the region just named must be caused by the influence of the sea climate, as Middendorff suggests,<sup>4</sup> though there is a mountain chain on the east coast. The extensive forests of Russia and Siberia prove that an extreme continental climate is resisted by some coniferous and other trees, but it is evident that in general a sea climate with mild winters, and thus a long period of vegetation, suits them best.

As we have seen, the northern limit of the cultivation of corn reaches on the continent a much higher latitude than on the shores. On the north-west coast of North America the island of Sitka (57° N. lat.) and Kadjak are on the extreme limit. On the Færoe Isles, barley (this can only be the coarse variety) is cultivated, but the grain very seldom ripens;<sup>5</sup> the cause is absence of sunlight on account of the continual cloudy sky, storms and precipitation, causing low temperature in summer (mean temperature at Thorshaven, July, 49° 8'), for corn wants a sunny climate, and to be under the direct influence of the sun's rays. This explains why it can be cultivated within the Polar Circle (Norway), where the sun in the summer season remains constantly above the horizon.

In North America, on the shores of Hudson's Bay, the tree limit goes down to 59°, the corn limit to 50° (Ontario).

<sup>1</sup> Petermann, *Geogr. Mittheilungen*, 1859, p. 124.

<sup>2</sup> Richardson, vol. ii. p. 267.

<sup>3</sup> Kittlitz, "Vierundzwanzig Vegetationsansichten von Küstenländern und Inseln des Süllen Oceans," p. 53.

<sup>4</sup> Middendorff, p. 763.

<sup>5</sup> Martins, "Sur la Végétation de l'Archipel des Færoe."

On the shores of the Okotsk Sea corn cannot be cultivated at all, even on the south coast, under 50° N. lat. In Greenland the culture of corn is also impossible. The causes are the same as said above: the sea winds, wet climate, and fog in summer—thus want of sunlight.

Of all the cultivated vegetables, *Raphanus sativus*, L., et var. (radish), *Brassica rapa*, L., et var. (turnip), and *Brassica Napus*, L., et var. (rape), grow as far north as there are settlements—in Norway beyond 70° N. lat.; in Siberia to the Polar Circle; on the north-west coast of America to 64° 45' (Nulato), and Redoute St. Michael, 63° 30', in the interior to 67° (Fort Good Hope).<sup>1</sup> In Greenland rapes, turnips, cabbage, and salad are cultivated under 70° N. lat. (Island Disko).

The potato follows the above-named plants in their distribution to the north, and belongs also to the sea climate; at its northern limit in Siberia, however, as well as in North America, it is the size of a walnut.<sup>2</sup> In Greenland only the most careful treatment can produce eatable ones. The plant never blossoms here.<sup>3</sup>

When comparing the vegetation of the extreme continental climate with that of the extreme sea climate on the globe, the continental has the advantage; the South Shetland Isles, in 60°-63° S. lat., are at the most southern limit of phanerogamous plants (only a grass, *Aira antarctica*, Forst., is found here), and on Cockburn Island (64° S. lat.) the last trace of vegetation is found (cryptogamous plants). At this latitude north there is in Siberia a forest of very high coniferous trees. In the Antarctic regions there are several causes why vegetation ceases at such a low latitude, but these are all consequences of the chief cause, viz. the fact that the whole southern hemisphere, with the exception of relatively small spaces, is covered with water; severe storms<sup>4</sup> combined with a very low summer temperature<sup>5</sup> banish all vegetation.

The extreme continental climate has also its disadvantages, but chiefly with relation to the cultivation of corn. In the first place corn is very often destroyed by night frosts; they make the harvest uncertain.

The constantly frozen ground is the chief cause why corn cannot be cultivated in Siberia beyond 62° (Yakutsk). The temperature of the soil in which the roots vegetate varies between 36° and 41°. Thus notwithstanding the mean temperature of June at Yakutsk being 57° and that of July 62°<sup>6</sup> the vegetation is relatively slow, though its period is the same as observed in Central Europe (ten to twelve weeks).<sup>7</sup> The same period is observed in North America, at 63° (Fort Simpson), of the barley (wheat does not come to maturity here). But harvests of thirty to forty times the amount of what was sown alternate in this climate with years of no harvest at all.<sup>8</sup> It is known that the native plants withstand the lowest temperatures of the Siberian winter.

Returning to Europe, we have seen that even the climate of the northern parts of the British Isles is not suited for many vegetables and other cultivated plants. It is Germany which has a climate where we can find almost all the plants of the temperate zone and those commonly cultivated; we see the vine in this country ascend farthest to the north, while corn and all vegetables ripen their seeds perfectly. It is clear that the climate is best suited for the vegetation of this latitude.

Now if we compare the mean temperature of July in Germany with the mean for the latitude (for 50° N. lat. 62°) calculated by Dove, we find that even in this country

<sup>1</sup> Richardson, vol. i. p. 214.

<sup>2</sup> Middendorff, p. 700.

<sup>3</sup> Von Etzel, "Grönland geographisch und statistisch beschrieben," p. 282 (Stuttgart, 1860).

<sup>4</sup> Lowest reading of the barometer by the United States Exploring Expedition under Wilkes in lat. 65° 15', 27° 50' (see "Narrative of the Expedition," vol. ii. p. 281 (London, 1852)).

<sup>5</sup> In lat. 64° 5' mean temperature of January 1843, 31°; in 62°-66° in February, 31° (see Kohn, "Voyage in the Southern and Antarctic Regions," vol. ii. pp. 352, 360).

<sup>6</sup> Middendorff, p. 772.

<sup>7</sup> *Jh.* p. 718.

<sup>8</sup> *Jb.* p. 720.

the summer temperature in general is only a few degrees above the calculated; Germany is crossed in July by the isotherm of 68°, and Britain by that of 59°; but the difference in vegetation is not caused by a difference in mean temperature of 9°, but by the difference in the amount of sunshine.

Thus we come to the conclusion that a mixed climate, with relatively mild winters (the anomaly of temperature for January is for Germany about 19° on the 50th parallel of latitude) and warm sunny summers, is the best suited for the vegetation of the temperate zone.

Flushing

M. BERGSMAN

### NOTES

THE International Congress of Hygiene will sit at the Hague from to-day till the 27th inst. Papers will be read by Messrs. Pasteur of Paris, Finkellberg of Bonn, Stephen Smith of New York, Marcy of Paris, W. H. Corfield of London, Emile Tielat of Paris, J. Crocq of Brussels, and A. Corradi of Pavia.

THE International Medical Congress at Copenhagen has been a great success. The next meeting will be held at Washington in September 1887. On behalf of the Collective Investigation Committee of the British Medical Association, Sir William Gull delivered an interesting lecture on the International Collective Investigation of Disease. A resolution for the establishment of a Permanent International Committee for the Collective Investigation of Disease was received with acclamation.

In an interesting descriptive article in the *Times* of yesterday on the Health Exhibition Biological Laboratory, the writer makes some forcible remarks on the position of research in this country. "Just as the advantages of such an institution as the projected Marine Biological Laboratory were illustrated and brought home to the mind by the International Fisheries Exhibition of 1883, so the present Health Exhibition should, as one outcome of its usefulness, lead to the foundation of some such institution for the extended and systematic study of the minute organisms which there is reason to believe are the causes of many forms of disease in plants, in animals, and in man. In Germany the State, recognising the value of the labours of Dr. Koch, contributes, though not very largely, to the prosecution of researches which give promise of invaluable results to all mankind. France, too, has acknowledged the practical character of the benefits which have in some measure already resulted from the experiments of M. Pasteur. In this country, where the State endowment of research is hardly admitted in principle, and where we have, perhaps too long, been content to leave all scientific research which was not directly remunerative to be pursued, with few attempts at organisation, by the few private individuals who, having the means, care to devote time and money to such objects, students of biological science are wondering whether the Royal College of Surgeons will apply some portion of the splendid bequest of Sir Erasmus Wilson to the purposes of research in this comparatively little-known but interesting field of inquiry. Without entering upon debatable ground, it may be said that in the small model laboratory for biological research, fitted up under the direction and now under the charge of Mr. Watson Cheyne at the Health Exhibition, the public may see and learn enough to convince the most sceptical of the vital importance of the knowledge which it is the purpose of such observations and experiments as are there exemplified to obtain."

PROF. G. F. ARMSTRONG, of the Yorkshire College, Leeds, and formerly of Montreal University, writes to the *Times* of Monday last, drawing attention to the liberal provision made for technical education in America. The Americans, he maintains, are a generation ahead of us in this respect. At the same time he

draws attention to the danger of neglecting the preliminary general culture which is absolutely necessary as a sound foundation for any special training.

It is worthy of note that the Roman Catholic Church of St. John, built by the Marquis of Bute, at Old Cumnock, Ayrshire, has recently been fitted throughout with the electric light under the personal superintendence of Mr. William Massey, of Twyford. There are in all about seventy glow lamps of twenty candles each, and the effect is very perfect, the architectural features of the building having been carefully studied and the lamps arranged with due regard to the religious character of the place. The necessary current is supplied by means of a dynamo and steam-engine placed in a small house hidden among the trees of the churchyard, where it is also intended to generate electricity for working the organ bellows.

THE inauguration of the Jouffroy statue at Besançon took place on Aug. 17. According to the French notion the Marquis de Jouffroy is believed to have been the real inventor of steam navigation, and the precursor of Fulton. M. de Lesseps was present at the ceremony.

THE effect of cheap interior telegraphy has been felt most happily in France, where the number of telegrams has multiplied in the most extraordinary manner. Last year there were 58 telegrams for each 100 inhabitants.

A FRENCH surveying vessel, the *Henri Rivière*, so called after the great explorer who lost his life in Tonquin, is to be sent to the higher waters of the Songkoi or Red River, not only to keep order among the pirates there, but also to survey the districts adjoining, and correct the inexactness of existing maps of the course of the river. As the ancient Khmer kingdom, Cambodia, has now been practically annexed to France, we may soon expect that the centre and eastern coast of the Indo-Chinese peninsula will be as well known to us as British India now is, for the French spare no money or pains to study their colonial possessions thoroughly.

AT the last meeting of the Paris Academy of Sciences, M. F. A. Forel described some peculiar luminous phenomena frequently observed by him and others during the spring and summer of this year at Morges on the Lake of Geneva, and especially on the Alps. When the sun was half veiled in white vapours, the clouds at Morges presented a reddish appearance at a distance of 20° or 25° from the solar disk. But the light effects were far more vivid when seen in the pure atmosphere of the Alpine regions; and in clear weather, that is to say, almost every day during the last fortnight, they were distinctly observed in the upland valley of Saas-Fée, Canton of Valais. The sun appeared as if encircled by a silvery white halo, very bright and lustrous, somewhat similar in appearance to the weird glow noted in the first phase of the crepuscular displays so frequently observed during last winter. This halo, whose radius may perhaps have measured some 12°, was itself surrounded by a broad, reddish corona with badly defined limits, whose orange or violet tints blended on the inner side with the silver halo, and outwardly with the azure sky. In breadth this corona was about equal to the radius of the halo. For a considerable distance from the sun the sky beyond these effects was of a deeper blue than usual, as was evident especially in the evening, when the setting sun disappearing behind the snowy Alpine crests seemed to impart to the western regions the shifting hues of a stormy sky. One might fancy the sun visited by a great dust-cloud, but for the fact that, beyond these displays of colour, it was as luminous as ever, the firmament itself as serene, with deep azure tints, the transparency of which nothing seemed to impair. The phenomenon attained its greatest intensity on July 23, a lovely midsummer day, when it was also observed at Sand-Alp in the

Canton of Glaris, at Kandersteg in the Canton of Berne, and at Charmey in the lower Valais. On the same day M. Auguste Arcimis noted crepuscular glows at Madrid analogous to those of last winter. He remarked in particular a bright corona around the sun, of a silvery white and with a diameter of about 48°. On the Alps the display remained more or less visible every day; but since his return to the plains on August 8, M. Forel lost all traces of it. He was assured by several observers that the phenomenon had been constantly noticed in Valais during the spring and summer of the present year. M. Forel asks whether it is to be regarded as a sequel to the surprising series of optical effects successively observed in the various regions of the globe since the tremendous eruption of Krakatoa on August 27, 1883, effects which in Europe reached their culminating point in the crepuscular glows and auroral displays of last November, December, and January. In connection with the same subject M. Jamin remarked that similar phenomena have been observed at Paris and in various parts of France during the exceptional heats of the last few weeks.

LIEUTENANT GREELY has published further details respecting his three years' residence in the Arctic regions. He says the extremes of temperature at the camp on Discovery Bay, which they had named Fort Conger, was from 52° above freezing-point to 66° below. In February 1883 the mercury was frozen into a solid mass, and continued in that state for fifteen days. The ordinary outdoor clothing of heavy flannels was found to be quite sufficient even on the coldest days. The extreme range of the barometer was from 29 in. to 31 in. The electrometer registered nothing. The aurora was noiseless, which is contrary to Sir George Nares's experience in 1876, but it was sufficiently bright to cast a shadow. The tide at their most northern settlement flowed from the north; that at Cape Sabine came from the south. The northern tide was two degrees warmer than that from the south. In Lady Franklin Bay it rose eight feet, and the Cape Sabine tide twelve feet. Surf was seen twice. The temperature of the water at the earlier camp averaged three degrees below freezing-point. During two years only two small sea fish were caught; but in Lake Alexander fine salmon were taken. Between Capes Bryant and Britannia Lieut. Lockwood found no bottom with a line of 155 fathoms. At the furthest point north which Lieut. Lockwood reached there was no Polar current, nor did he discover any open sea. The only sea animals met with were the walrus and different species of seal. The vegetation was similar to that seen all over the extreme north. At Lady Franklin Bay the deflection of the magnetic needle was 104 west. The coast of Greenland trended in a northeasterly direction as far as it could be traced. Lieut. Greely thinks the Pole will never be reached, unless every condition which has hitherto been unfavourable should be simultaneously favourable. The only route at all likely to prove successful is, he thinks, by Franz Josef Land. The Polar pack generally, which was reported by Dr. Pavy and Lieut. Lockwood to have been seen by them, almost certainly, Greely considers, proves the existence of an open Polar sea. No hardship was experienced by the explorers while they remained at Fort Conger; and if their physical condition had not degenerated the survivors believe they could have remained there ten years.

UNDER the title of "Bosquejos Ethnolicos," S. Carlos von Koseritz has just published in collective form a series of papers contributed by him during the last three years to the *Gazeta de Porto Alegre* on anthropological subjects in the province of Rio Grande do Sul and other parts of Brazil. A chief object of these papers is to place on permanent record the general conclusions based on a comparative study of the extensive ethnological collection to the formation of which the writer had devoted fifteen years' patient labour, but which was unfortunately com-

pletely destroyed in the disastrous fire at the Brazilian German Exhibition of Porto Alegre last year. The collection comprised over 2000 objects of all sorts, but chiefly rude and polished stone implements brought together from various parts of Rio Grande, and generally corresponding to those of the stone epochs in Europe. But those of a strictly Palæolithic type appear to be very rare, and as they occur promiscuously with Neolithic objects, the author infers that it is impossible to determine a Palæolithic antecedent to a Neolithic age in Brazil. A few rudely wrought diorite or nephrite weapons occur, as well as some quartz arrow-heads fashioned with great labour. But the great majority of the arms and utensils are of more or less polished diorite. Many were found associated with the remains of the Megatherium, of the *Rhinoceros tichorhinus*, and the cave bear, thus confirming the conclusions already deduced from the discovery of the fossil man of Lagoa Santa in Minas Geraes, and arguing as great an antiquity for the *homo Americanus* as for the River Drift men of the Old World. At the same time the writer considers that the earliest inhabitants of South Brazil were quite distinct from, and of a much lower type than, the Charruas and other tribes in possession of that region during the historic period. This conclusion is based especially on the evidence afforded by the skeleton recently found in a shell-mound on the banks of a fresh-water lagoon near Cidreira, within three miles of the present coast of Rio Grande. During its removal to Porto Alegre, this skeleton, which must have been many thousand years old, got broken, but the skull has been carefully restored by Theodore Bischoff, and presents the same remarkable characteristics as two others of uncertain origin preserved in the National Museum of Porto Alegre. It is even of a more decidedly bestial type, with excessive prognathism of the upper jaw, extremely long and high cranium (hypsisencephaly), depressed brow, prominent superciliary arches, imparting altogether a most ferocious expression to this specimen, which from the worn state of the teeth seems to have belonged to a very old man. Altogether the Cidreira skull completely confirms the views of Lacerda regarding the prehistoric race associated with the shell-mounds of South Brazil, a race which appears to be at present best represented, at least in some of its salient features, by the fierce Botocudos of the Aimores Mountains further north. It seems to have come originally from those highlands, and the author thinks it probable that the men of the Santa Catharina and Rio Grande refuse-heaps all belonged to the same aboriginal stock.

THE glaciers of the province of Terek, in the Caucasus, are the subject of a vivid description by M. Dinnik, in the last number of the *Memoirs* of the Caucasian Geographical Society (vol. xiii.) With the exception of the Adyl glacier, all those visited by M. Dinnik have been rapidly decreasing during this century. The great glacier of Bizinghi, one of the largest in the Caucasus (it is nine miles long, and one mile wide about the middle), has two great terminal moraines, one mile below its present end, and several lateral moraines, some 500 yards distant from its present borders, some of which still conceal masses of ice under the boulders and mud. On its western border an old moraine rises at least 200 feet above its surface. The same is true with regard to the great Azaou glacier of the Elbrus. Even the inhabitants have witnessed the retreat of glaciers, and they remember the time when the Bizinghi and Mijirghi glaciers, now one mile distant from one another, were connected together at their ends. Besides these relatively recent moraines, there are around the glaciers several others the boulders of which are much more worn out and more rounded, which testify to a former still greater extension of glaciers. As to the Adyl glacier, it was also decreasing when a formidable mass of mountain above it fell into the valley some eighteen years ago. It was broken to pieces, and its debris thickly covered the glacier for some five miles. The debris, which have still at

many places a thickness of several yards, have protected the ice from melting, and have made it advance down the valley.

THE last number of the *Memoirs* of the Caucasian Geographical Society (vol. xiii. part 1) contains a series of very interesting papers. M. Dinnik contributes three papers, in which he describes his wanderings through "the mountains and gorges" of the provinces of Terek and Kuban in Ossetia and about the sources of the Rion. The author devoted his attention especially to the glaciers of the tracts he visited, but his descriptions give a very striking picture of the general characters of the region, of its flora, and especially of its fauna. His remarks on this last will be most welcome to the zoologist and geographer. M. Weidenbaum gives an historical sketch of the different ascents of Ararat, and of the scientific conquest of its summit, so boldly denied each time by the Armenians, who do not admit that human feet may step on the virgin snow of the holy summit. The ascents of Tournefort, Parrot, Abich, Khodzko, Messrs. Freshfield and Tucker, and Bryce are described by the author. M. Lessar contributes a paper on his journeys to South Turcomania, Merv, Chardjui, and Khiva (already known from what has appeared in the *St. Petersburg Ivestia*). M. Kossikov gives a narrative of his journeys to the Upper Daghestan and Chechnia, and describes also two villages, Konhidat and Enheli, situated in the gorge of the Andian Koyson, the inhabitants of which are engaged in salt-mining. Two lithographs give an excellent idea of this crow's nest in the mountains, the flat-roofed houses of which are built upon one another, offering at the same time a means of defence and an economy of the poorly-allotted space on the slopes of stony crags.

IN a former paper to the Russian Chemical Society, Prof. Mendeléeff had arrived at the conclusion that the dilatation of liquids can be expressed by the formula  $V = \frac{1}{1 - kt}$  where  $k$  is a module which varies for different liquids, and increases with their volatility. The researches of M. Van der Vaals, combined with the above, have enabled Messrs. Thorpe and Rücker, in the April number of the *Journal* of the London Chemical Society, to establish the remarkable relation between the absolute temperature of boiling  $t_1$ , reckoned from the absolute zero ( $-273^\circ$ ), the volume  $V_1$ , measured at a temperature  $t$ , and a constant  $a$ , which seems to be near to 1.995 or 2. Now, in a communication to the Russian Chemical Society (vol. xvi. fasc. 5), Prof. Mendeléeff shows that, if the dilatation of gases and that of liquids be expressed by the formulæ—

$$V_1 = 1 + at \text{ and } V_t = \frac{1}{1 - kt},$$

which would give  $2t_1 = \frac{1}{k} - \frac{1}{a}$ , and the constant  $a$  be taken equal to 2, we receive—

$$\frac{1}{k} = 2t_1 + 273,$$

where  $k$  and  $t_1$  are determining one another. This deduction is confirmed, in fact, by direct measurements. The further progress in the mechanics of liquids, he says, must be expected from new experimental and theoretical researches into the compressibility of liquids at different temperatures and into its relations to the modulus of dilatation; the fundamental equation of liquids must express the relations between their volume, temperature, and pressure, as is the case for gases. As to a complete conception of the ideal state of bodies, it must contain also the relations to their molecular weight and composition.

THE "Handbook of the St. Nicholas Agassiz Association," issued by the President, Mr. Haslan H. Ballard of Lenox, Mass., is a little work of great interest, and should also be of much utility to those who desire to train up the young with a love for

Nature, and a desire to study her products and ways. The Association had a very modest beginning. Mr. Ballard was teaching in a school in Lenox, and in 1875 got his pupils to band together for the observation and study of natural objects. "It was the outgrowth of a life-long love for Nature, and a belief that education is incomplete unless it include some practical knowledge of the common objects that surround us." The idea was actually derived from a similar association in Switzerland, took root and flourished in Lenox, and after a few years the President thought that it might be extended to other places. The assistance of the editors of the well-known *St. Nicholas* magazine for the young was then invoked, and in 1880 a general invitation to others to join in the work appeared in that periodical. The response was very gratifying. Classes have been formed in various towns under the direction of the central organisation, and now 650 local scientific societies are at work with over 7000 students. Nor is it confined to the youth of both sexes, although originally intended for them, for the parents in many instances join, and there are some "chapters," or classes, wholly composed of adults. Still the work is principally among the young, and Mr. Ballard notes that the Association has found a wide field of usefulness in connection with public and private schools. Many teachers, he says, who have not been able to find a place for natural science in the ordinary school curriculum, and who have yet felt that their pupils should not grow up strangers to the flowers, trees, birds, and butterflies, have been glad to devote an hour once a fortnight to the guidance of a meeting devoted to these studies. The "Handbook," after describing somewhat enthusiastically and picturesquely the advantages of the Association, proceeds to give directions as to the formation and conduct of a class. Then follow chapters on the plan of work, how to make a cabinet, to collect specimens, what to do in winter and in the city, and so on—in fact, directions for the young student in every department of natural history to which he could turn his attention. A list of books recommended and of the various branches of the Association conclude the little book. Almost every State in the Union is represented among the branches, some of them very numerous, while foreign countries are represented by Canada, Chili, England, and Scotland. On the whole Mr. Ballard has a very gratifying story to tell of successful and voluntary effort, and we have no doubt that his little book will lead to a large increase in the Agassiz or similar associations by showing how easy it is to organise and work a "chapter," and the benefit derived from study carried on in this way.

IN the Report of the Bureau of Education of the United States for 1881 (see NATURE, vol. xxix. p. 506) the increase of a class of illiterate population recorded in the census of 1880 was touched upon. A Circular recently issued by the Bureau goes more thoroughly into the subject, and carefully compares the numbers of all the different classes of the population which came under this head at the last census with those of the census of 1870. It is satisfactory to find, from the safe ground of such statistics, that the late alarmist assertions of the terrible growth of an uneducated *proportion* of population is true only of five States out of forty-seven, viz. Maine, New Hampshire, California, Montana, and Nevada. In other States, and on the whole, the ratios of ignorance to education were diminished, even in the Southern States, where so large a proportion of the inhabitants have a tendency to "helpless over-production." Nevertheless, it is true that the *absolute number* of illiterates has increased, in spite of philanthropic as well as Government efforts, by over half a million in these States, and not among the coloured population only. There were 46,000 more in the Pacific States; and thirteen white children out of a hundred throughout the whole States "escaped the combined influences of church, day school, Sunday school, and family teaching." The objection raised in England to the franchise being given to an uneducated

class is urged most strongly in an appendix to this Circular, as being far more dangerous in the United States, where custom exerts no check. Since the danger is equal to the whole Union, while the burden of meeting it falls so heavily on certain States, it is again strongly urged that a part of the expense should be met by national taxation.

The writer of the second Circular of Information published this year by the United States Bureau of Education trusts that the Shorthand Society of London will throw light upon the history of their art, as the material is quite inaccessible to the American student. Yet his industrious researches there enable him, after speaking of the shorthand invented by Cicero's freedman, and of its revival by Dr. Timothe Bright in Queen Elizabeth's time, to append the names and dates of more than 400 authors of English systems; a catalogue, 100 pages long, of writers and their works on the subject, and 112 alphabets of various dates, from 1602 to 1882. He is able also to quote thirteen monthly publications in the United States and Canada on this subject. It is to be hoped that, in this art as in nature, the result will be the survival of the fittest (Mr. J. Pitman's system already counts its 810th thousand of copies issued), and one is inclined to wonder whether some full and skilful system of denoting sounds might not be worked out, which would render unnecessary the more partial working of phonetic spelling.

THE culture of the tea-tree in Transcaucasia, which has been recently advocated by Dr. Woeikoff, has already been successfully carried out on a small scale for several years—as we learn from a recent communication of M. Zeidlitz to a Russian newspaper. It was an Englishman, Mr. Marr, who has inhabited Transcaucasia since 1822, who brought to a flourishing state the Crown garden at Ozurghety, and embellished it with a number of lemon, orange, and tea trees, these last numbering more than two hundred. After the Crimean war only twenty-five tea-trees were growing in this garden, and according to Mr. Marr's advice they were transplanted to a private estate at Gora, close to Tchakhtaour. Since the estate has changed its proprietor, only two tea-trees have remained, but still they continue every year to flower and to give fruit, and M. Zeidlitz is sure that if the culture be seriously tried it might be successful in the valleys of the Koura and Rion.

THE additions to the Zoological Society's Gardens during the past week include a Ring-tailed Coati (*Nasua rufa* ♂) from South America, presented by Miss K. M. Battam; two Patagonian Cavies (*Dolichotis patachonica*) from Patagonia, a Hairy-rumped Agouti (*Dasyprocta prymnolopha*) from Guiana, a Ring-tailed Coati (*Nasua rufa*) from South America, two Rufous Tinamous (*Rhynchotus rufescens*) from Brazil, two Tuberculated Iguanas (*Iguana tuberculata*) from the West Indies, two Huanacos (*Lama huanacos* ♂ ♀) from Bolivia, presented by Mr. Frank Parish, C.M.Z.S.; a Gray Parrot (*Psittacus erithacus*) from West Africa, presented by Mr. E. T. Holloway; a Vulpine Phalanger (*Phalangista vulpina*) from Australia, presented by Mr. H. Livermore; two Smooth Snakes (*Coronella levis*), European, presented by Mr. W. H. B. Pain; a Two-streaked Python (*Python bivittatus*), a Reticulated Python (*Python reticulata*), a Two-banded Monitor (*Varanus salvator*), a Fringed Tree Gecko (*Phychozoön homalocephala*), a Javan Porcupine (*Hystrix javanica*) from Java, presented by Dr. F. H. Bauer, C.M.Z.S.; two Mountain Ka-Kas (*Nestor notabilis*) from New Zealand, a Three-coloured Lory (*Lorius tricolor*) from New Guinea, a Severe Macaw (*Ara severa*) from Brazil, deposited; ten Common Chameleons (*Chameleon vulgaris*) from North Africa, two Brazilian Cariamas (*Cariama cristata*) from Brazil, purchased; a Somali Wild Ass (*Ejvus somalicus* ♂) from Somali Land, received in exchange.

OUR ASTRONOMICAL COLUMN

SCHMIDT'S VARIABLE-STAR IN VIRGO.—Prof. Schjellerup, writing from the Observatory, Copenhagen, on August 9, thus expresses himself with reference to a note which appeared in this column on his identification of the above object:—"On the article that is to be found in NATURE, July 31 last, about this star, allow me to make some essential remarks. The author entirely misconceives the sense of my note in Süfi. It does not at all concern No. 19 Ptol., but only sets out that Lalande 25086 takes that place where there must have been the star which Süfi saw; and I may yet maintain the correctness of the note. I only ask the author to look at Bremicker's map, Hora XIII.; he will find there that Lalande 25086 has just equal distances from Spica and from  $\delta$  Virginis (Ptol. 17), and, what is more, that this distance is nearly one and a half times the distance between Spica and  $\delta$  Virginis, very conformably to Süfi's remark in the text: 'Entre elle (19) et al-simäk ( $\alpha$  Virginis) vers le sud-est, il y a environ une coudée et demie, et entre elle et la 17<sup>e</sup> il y a la meme distance. Avec al-simäk et la 17<sup>e</sup> elle forme un triangle isoscèle, cette étoile étant au sommet.' It is also to be remarked that Süfi has before declared the distance between No. 17 and Spica as 'environ une coudée,' that is, nearly 2' 20". What is here said about 19 (Süfi) does not at all agree with the position of No. 19 by Ptolemy, which is also pointed out by Süfi himself as follows: 'La latitude de cette étoile, indiquée dans le livre de Ptolémée, se trouve erronée, parce que, au ciel, elle se fait voir autrement qu'elle ne tombe sur le globe.'" We are glad to print Prof. Schjellerup's explanation of the purport of his note; it is quite possible that others may have interpreted it as we did.

THE NEW COMET.—Several orbits for this comet have been published in the *Astronomische Nachrichten*, founded for the most part upon the position obtained on the night of discovery, July 16, and on M. Trépied's observations on July 23 and 29, where there appears to have been at first some doubt as to the comparison-star. The middle observation is not well represented by any of these parabolic orbits, and Prof. Weiss conjectures that there is considerable ellipticity, at the same time remarking that a certain general resemblance exists between the elements of the present comet and those of the lost short-period comet of De Vico, observed in 1844, but not found since that year. In the uncertainty which seems to have attached to the observations at Algiers, it would not be safe to speak confidently as to the nature of the orbit, though it may be decided in a very short time.

Prof. Tacchini has kindly communicated the following observation made at the Observatory of the Collegio Romano:—

Rome M.T.	Right Ascension	Declination
h. m. s.	h. m. s.	h. m. s.
August 9, at 8 31 56	16 51 20.14	- 36 56 25.5

The comet was very faint, and the observations, by Prof. Millosevich, are a little uncertain.

The best parabola, according to Prof. Weiss, has the following elements:—

Perihelion passage, August 17.5109 G.M.T.		
Longitude of perihelion	301 57 24	M. Eq.
ascending node	357 45 51	1884.0
Inclination	7 2 31	
Logarithm of perihelion distance	0.147982	
Motion—direct.		

The most reliable elements of De Vico's comet of 1844 are those given by Brunnow in the *Ann Arbor Astronomical Notices*.

BRORSSEN'S COMET.—From a note of Prof. Krueger's in the *Astronomische Nachrichten*, it seems that Dr. Schulze has not been able to undertake the calculation of the perturbations of this comet since its last appearance in 1879, and accordingly the rough ephemeris lately given in NATURE is transferred to that journal.

THE FORESTS OF NORTHERN EUROPE

A VERY recent report has appeared on this subject in the shape of a small Blue-Book which deals with the various aspects of the forestry question in certain of the more northerly States of Europe, such as Germany, Russia, Norway, Sweden, Coburg, and Gotha. The Report, which contains matter of great interest in many ways, is the outcome of the proposals of Dr. Lyon, M.P., to rehabilitate the ancient forest system in Ireland; and although the greater part of it deals with the

administrative and commercial results, in themselves of great value, many facts are elucidated which bear upon the natural history of the countries under discussion. The Duchy of Gotha contains a forest area of 32,054 hectares, of which at least 94 per cent. are massed together in the Thuringian Forest, whilst the remainder cover the height above the plains, at an elevation of about 900 metres above the sea. The geological formation of these heights is for the most part Lower New Red interspersed with thick veins of porphyry, while that on which the plain forests are situated is limestone. At least 85 per cent. of the Gotha trees are pine, the remainder consisting of larch, oak, maple, ash, birch, and elm. The Duchy of Coburg does not possess half the forest area of Gotha, there being only 15,718 hectares altogether, of which 86 per cent. is pine. Considering the minuteness of information which is gathered together by most of the German Departmental Bureaus, it is surprising how difficult it is to obtain statistical knowledge on the subject of forests, the reason being that each State has its own Department of Agriculture, quite irrespective of the Imperial Administration. Prussia, however, seems to have been more awake than the others, to the desirability of attempting to cultivate other than indigenous trees in the kingdom; and in the Budget for 1880, no less than 50,000 marks (2500*l.*) was set aside for the purpose. The following list was made out of new trees, but as there has not been any further mention of their introduction in subsequent Reports, it is uncertain how far the proposal was really carried out. The trees were as follows:—

NAME	HABITAT	
<i>Pinus rigida</i>	North America, eastern portion.	
<i>Thuja gigantea</i>		
<i>Juglans nigra</i>		
<i>Carya alba</i>		
<i>C. amara</i>		
<i>C. aquatica</i>		
<i>C. tomentosa</i>		
<i>C. porcina</i>		
<i>Quercus rubra</i>		
<i>Populus monilifera</i>		
<i>Abies Douglasii</i>	North America, western portion.	
<i>Pinus ponderosa</i>		
<i>Cupressus Lawsoniana</i>		
<i>Juniperus Virginiana</i>		
<i>Acer Negundo</i>		
<i>A. saccharinum</i>		
<i>A. dasycarpum</i>		
<i>Betula lenta</i>		
<i>Abies Nordmanniana</i>		Caucasus.
<i>Pinus Laricio</i>		Southern Europe.
<i>Picea sitchensis</i>	Japan.	

The estimated area of forest land in European Russia is about 146,460,000 dessiatines (1 dess. = 2.69 acres), or 33 per cent. of the total area of the country, compared with which Austria has 29 per cent., Germany 26, France 19, Italy 18, and Turkey 14. It is a drawback to Russia that her forests are so unevenly concentrated, at least three-fifths being situated in four Governments, leaving but two-fifths to the other forty-five. As a rule, the further one travels south in Russia the less forest is met with, the Governments of Archangel, Wolgoda, Olonetz, and Perm possessing 60 per cent., while in those of Poltawa, Bessarabia, and the country of the Don Cossacks, there is not more than 4 per cent. It is an undoubted fact that Russian timber is on the decrease; and ten years ago M. Aschakow in his evidence before a Commission to inquire into the condition of the forests in the Ufa, stated that the whole of that part of the country was threatened with an absolute want of wood, hundreds of thousands of trees being stripped for the sake of the bark and the roots. Naturally the evil does not stop here; but the climate also shows a considerable change—the rivers, such as the Bielina, showing each year a smaller volume of water. Floods are more frequent, property is destroyed to an alarming extent, the beds of the rivers silt up, and the navigation becomes annually more and more uncertain. From observations made at Kieff, the winter lasts longer, and the harvests are not so productive as of yore; while Dr. Grimm notes that rivers which once had a reputation for abundance of fish, the banks of their rivers being well covered with timber, are now as deficient as formerly they were rich, and he attributes the change to the dearth of insects, whose larva furnish food for the fish. Another evil arising from the destruction of the forests is the much greater

liability to hailstorms; and in this respect the same complaint comes from France, Germany, and Switzerland. Indeed, districts that were once wooded, rarely, if ever, suffered from hailstorms; and the converse has been noted that, where new trees have grown up, the storms have been less and less severe.

So general has been the conviction that this forest destruction is causing serious damage to the country, that a society has been formed at Moscow to consider the question, and engineers have been sent with a view of ascertaining the height of the water in the rivers during the spring, the changes in the number and size of the lakes, the changes which have taken place in the character of the summer and winter seasons, particularly as affecting the vegetation and the growth of plants. M. Wagner, in an article in the *Noroe Vremya*, 1882, considers that the systematic forest waste will lay Western Russia open to the action of the south-east wind, and thus bring undue dryness and contagion from Central Asia; and according to the latest accounts of the advance of the Siberian plague, M. Wagner's prognostications seem in a fair way of fulfilment.

The climatic conditions of Russia are such as to allow a great variety of trees to flourish. If a line be drawn from Orenburg towards the west, through the Governments of Samara, Pensa, and Tamboff, as far as Tula, and thence to Charkoff, Kieff, and Volhynia, the deciduous trees will be found to predominate to the south, and the coniferous trees to the north. As far as 67° N. lat. *Pinus sylvestris* is the most universal tree, being found in the south, indeed, only in isolated patches. It extends northwards as far as 70° N. lat., and eastwards as far as the Petchora, its southern boundary being at 44½°, though, passing over the steppes, it is again seen in the Caucasus at from 41½° to 43°. *Abies excelsa* is the next common, being found in Finland as far north as 68½°, while in the east the predominating tree is *A. oberata*. *A. sibirica* extends to 64°, and not further south than Nijni Novgorod. The larch (*Larix europæa*) is only met with in Poland, though *L. sibirica* inhabits the Government of Olonetz, Nijni Novgorod, and the Ural as far as the river Sakmara (51½°), and is in high repute for ship-building purposes. The cedar (*Pinus cembra*) extends north-east to 64½°, and also in the northern part of Orenburg to 51°. There are large forests of this pine in Perm and Wolgoda, and an extensive trade is carried on in the exportation of cones. As to the deciduous trees, the birches (*Betula alba*, *B. pubescens*, *B. verrucosa*, *B. fruticosa*, and *B. nana*) are very general throughout Russia, being found on the Petchora in 67° N. lat., as well as in the Crimea and the Caucasus. The oaks (*Quercus pedunculata*) have the same range southward, but are not met with on the north further than St. Petersburg and Southern Finland, and not at all east of the watershed of the Ural. The variety known as *Q. pedunculata tardiflora* grows in the Governments of Kieff, Poltawa, Charkow, and Voronetz, and is the only oak that flourishes in the Crimea. *Q. robur* and the beech (*Fagus sylvatica*) have their homes in Poland, Podolia, Volhynia, Bessarabia, the Crimea, and the Caucasus. The aspen (*Populus tremula*) is found all over the land as far as 66°, and is a valuable industrial tree, being used in paper-making. The lime-tree also (*Tilia parvifolia*) is valuable in the bast manufactories and for making matting, and is found from 64° as far as Wolgoda and Perm and in the Governments of Kostroma, Kazan, and Simbirsk. The red beech flourishes at heights varying from 1500 to 4000 feet above the sea-level, and, with the white beech (*Carpinus betulus*), is chiefly found in the south-west of the Empire, and also in the Caucasus and Crimea. There are large forests in the neighbourhood of Kieff and Poltawa, entirely composed of this tree. The elms (*Ulmus effusa*, *U. campestris*, and *U. suberosa*) usually frequent the south, though not in profusion; but the ash (*Fraxinus excelsior*) is much more plentiful, and is particularly valuable, as affording shelter for the Spanish fly, the exporting of which is a somewhat extensive industry. The maples (*Acer platanoides* and *A. tataricum*) are tolerably plentiful in all parts, though not as forest trees. The same may be said of the alder (*Alnus incana*), the willow, wild apple, pear, and plum.

The average annual produce of the Russian forests is about 600,000,000 cubic feet, at which rate the yield of a dessiatine is not more than six cubic feet, a poor result when compared with other countries, Prussia giving at the rate of 84.7 cubic feet a year, Bavaria 131, and Saxony 165. It is singular, however, that where the extent of productive forest in Russia is smaller, the yield per dessiatine is greater, the average of the central provinces being 60 cubic feet, and in the south 37, while in the

north it scarcely amounts to 3 cubic feet. Nor is the return very satisfactory from a pecuniary point of view, most of the Governments being far under one rouble per dessiatine, though a few can show better results, those of Moscow, Kursk, and Voronetz being  $3\frac{1}{2}$  roubles, of Charkow  $5\frac{1}{2}$ , Tula 6.16. But the general value is not as satisfactory as in other countries, Prussia showing an equivalent of  $2\frac{1}{2}$  roubles, Bavaria 4 $\frac{1}{2}$ , Saxony 10, and France 9. One of the most useful developments of tree cultivation in Russia has been the formation of plantations along the railway tracks, about 2000 dessiatines having been already covered in this way on the Kursk-Charkoff-Azov, the Kozloff-Voronetz-Rostoff, the Orel-Griasi and Fastovo lines, the object being of course the protecting of the rails from snowdrift. M. Sredinsky, the inventor of this very successful system, considers that seven rows of trees are sufficient for this purpose, and on this calculation one verst would require 33,000 plants, of which 9000 must be trees, and the remaining 24,000 shrubs. The trees which he finds best adapted for this purpose are elm, ash, oak, white and yellow acacia, maple, white thorn, hazel (*Corylus avellana*), wild plum, gleditschia, mulberry, elder, &c., but along the Sumi Railway in the Government of Charkoff, *Pinus sylvestris* has been planted, and does well. Tree-planting has also proved invaluable for fixing the sand plains at Aleschki on the Dnieper, the best for this purpose being *Salix acutifolia*, *Genista tinctoria*, *Ulex europæus*, *Fraxinus spinosa*, and *Pinus maritima*. When Russia first got possession of the Crimea, the banks of the Dnieper were wooded for at least seventy versts; but, as colonisation extended and population increased, the herds and flocks destroyed the roots of the trees, and thus allowed the formation of these sand plains, which comprise 139,000 dessiatines. Of these, some 20,000 are fairly covered with *Salix viminalis*. Birch are found on about 10,000 dessiatines, while at least 34,000 are of the pure sand.

#### THE AMERICAN INITIATIVE IN METHODS OF DEEP-SEA DREDGING<sup>1</sup>

THE published records respecting the use of dredges for natural history purposes carry us back to scarcely more than a century and a quarter ago, when Otho Frederick Muller, a prominent Danish naturalist, began his studies of the aquatic life inhabiting the coasts of Norway and Denmark below the shore-level. The dredge he used, a very simple affair, was, so far as we know, the first one ever devised for the special needs of the naturalist; and yet, with only a single important modification as to the shape of the frame, it has been handed down to our time as the most efficient appliance for the ordinary purposes of dredging.

As described and figured in 1779, it consisted of a plain, rectangular iron frame, with all four sides of equal length, and bevelled to sharp edges in front, forming the mouthpiece to a large and open net. Four handles extended forward from the angles, and met in a single ring for the attachment of the drag-rope. The principle defect of this dredge consisted in its very wide mouth, permitting the easy escape of specimens both while dragging and during the hauling in.

Although Muller's researches were confined to shallow water, apparently not exceeding a depth of thirty fathoms, they established a precedent for subsequent operations, and afforded proof of the value of submarine collecting.

This new field of exploration did not, however, begin to enlist the active services of working naturalists to any extent until about the third or fourth decade of the present century, since which time the interest in marine zoological research has rapidly increased, and our knowledge of the sea-bottom has been extended to the deepest-known areas. For the first thirty or forty years the improvement in methods of work scarcely kept pace with the progress of knowledge regarding the inhabitants of the sea; and it is only within the past fifteen years that the methods of deep-sea dredging have been at all perfected.

To Dr. Robert Ball of Dublin, who was afterwards associated with Prof. Edward Forbes in his memorable explorations, has generally been given the credit of having devised, about 1838, the improved form of naturalists' dredge, in nearly the same shape in which it is used to-day. However that may be, it was about the year last mentioned that both European and American naturalists entered actively into the study of the sea-bottom; and the history of their various exploits down to the present

time affords an exceedingly interesting chapter, upon which the subject of our paper permits us to touch but slightly.

It may be well to remark, however, that the character and results of European, and especially British, exploration are much more widely and popularly known than are those of our own country. The reason is obvious. The active mercantile pursuits of a young and progressive people have naturally made them less appreciative of scientific facts and results than the inhabitants of many older countries, where business interests have fewer claims upon all classes. There has been but a slight demand for popular writings upon such an unpractical subject, and the plodding naturalist has generally been content to record his observations and methods where they were accessible only to his brother-workers. For this reason American naturalists have not received the credit which is their due, either at home or abroad; and much of the honour that justly belongs to them has passed into other hands.

So far as concerns the general public, this is not to be wondered at, when we consider that the only popular accounts of deep-sea dredging explorations obtainable in this country are of English origin. But the same excuse does not hold good for the working naturalists of any country, including our own; as the progress of American deep-sea research, and the improvements in methods for carrying it on, have in nearly all instances been duly and promptly recorded in the proper channels to insure wide and timely distribution.

Since the very beginning of activity in this branch of investigation, American workers have not been far behind those of any European country; and their record is as creditable. Dredging was carried on by the Wilkes U.S. Exploring Expedition during the early part of its cruise, beginning in 1838; and at about this same time a few of our most earnest naturalists were using the dredge at home. The late Dr. William Stimpson, one of the most intelligent observers in this branch, and whose name is closely linked with several important explorations, began his career in Boston Harbour between 1848 and 1850; his first instructions having been received from Dr. W. O. Ayres, who began dredging fully ten years before. Stimpson's researches were largely conducted under Government auspices; and the collection of submarine specimens resulting from his labours, distributed over many portions of the Atlantic and Pacific Oceans, was probably one of the very largest of its kind that had been made, up to the time of its unfortunate destruction by fire at Chicago, in 1871. The loss of these collections, and of all the voluminous manuscript reports treating of them, followed by the sad death of the author, has deprived our country of a most important chapter in the history of submarine exploration.

The sixth decade of this century, however, brought out many additional investigators, and a fresh impetus was given to the work, which has since been expanded and developed to such an extent as to establish beyond all question American precedence in the methods of deep-sea research at least, both as regards dredging and sounding.

From among the more energetic and successful of our modern dredgers may be mentioned Prof. A. E. Verrill of Yale College, whose dredging studies began in 1864, on the coast of Maine, and who, since the organisation of the U.S. Fish Commission, has been its main helper and adviser in all matters pertaining to submarine research, the special direction of the dredging operations having been intrusted to him from the beginning. His earlier experiences gave him a clear insight into the requirements of the new project, and enabled him to devise many valuable appliances, and improve upon those which had been in use. To his zealous and untiring efforts is due much of the perfection in present methods of work.

In 1867 Mr. L. F. de Pourtales, of the U.S. Coast Survey, began the extensive series of deep-sea explorations off the southern coast of the United States, which were carried on for several years, and subsequently led to the eventful cruises of the steamer *Blake* between 1877 and 1880, resulting in an entire revolution in the methods of deep-sea dredging and sounding. The investigations of Mr. Pourtales anticipated by a year those of the English steamers *Lightning* and *Porcupine*, which have been so widely described, and were preceded by only one series of systematic dredgings in equal depths of water—those of the Professors Sars, father and son, of Norway. But little credit for this fact has been received from naturalists abroad, the date of Mr. Pourtales' first cruise being generally regarded by them as 1868, although his first paper, descriptive of the character of his work and of many new forms of deep-sea animals, appeared in

<sup>1</sup> From *Science*.



December 1867.<sup>1</sup> His collections, representing principally the fauna of the Gulf Stream off Florida, gave new and interesting results, going farther to prove the existence of a rich and diversified deep-sea fauna, different from that of the shore regions, than any previously obtained.

That these dredgings were not undertaken to please the passing whim of some over-enthusiastic naturalist, but were as deliberately planned and carried out, and as successful in their results, as those of the English steamers which followed them in conception, a reference to the official publications of the Coast Survey will sufficiently prove. As substantiating this statement, we may be pardoned for quoting a short paragraph from the report of Mr. Pourtalès, above referred to (December 1867), in which the plans and objects of the new explorations are briefly stated. This would not be called for, were it not that it is this identical report which has been so utterly ignored by European writers, and equally overlooked by many Americans. Had it only been written in popular language, and been published with copious illustrations, it might have received the credit which has been denied it; but such channels of publication are seldom deemed necessary to establish priority in scientific research.

The plan of operations, according to Mr. Pourtalès, was as follows:—

"The present Superintendent of the Coast Survey, Prof. B. Peirce, has lately directed the resumption of the investigations of the Gulf Stream, so successfully inaugurated by his predecessor, but interrupted for several years by the war. Besides observations of the depth, velocity, and direction of that current, and the temperature and density of the water at different depths, the researches will be extended to the fauna of the bottom, of the surface, and of the intervening depths. Not only will an insight be thus obtained into a world scarcely known heretofore, but that knowledge will have a direct bearing on many of the phenomena of that great current. Thus a new light may be thrown on its powers of transportation from shallow to deeper water or along its bed, on its action of forming deposits in particular localities, or on its possible influence on the growth of coral-reefs on its shores."

In a subsequent passage he summarises his first season's results in the following terse remarks, the italics being his own:—

"However, short as the season's work was, and few as were the casts of the dredge, the highly interesting fact was disclosed, that *animal life exists at great depths, in as great a diversity and as great an abundance as in shallow water.*"

Early in the following year (1868) the same explorations were resumed, and they were continued through 1869.

It may be thought that we have departed too widely from our subject in discussing with so much detail the progress of American research during a period in which no great improvements were made in methods of work on this side of the Atlantic; but how could we have better furnished proof of the rapid growth of interest in such matters, and of the maturing of ideas which prepared the way for the important changes marking the next decade.

There is, however, one noteworthy addition to the collector's outfit made in this period, which deserves special mention. On one of the dredging cruises of the English exploring steamer *Porcupine*, between 1868 and 1870, Capt. Calver, the naval officer in charge, attached several of the common deck-swabs to the end of the dredge-net, with the expectation that, in sweeping the ocean-bottom, they would securely entangle all the rough and spiny objects lying loose within their path. His fondest hopes were realised, and the novel experiment, suggested by often finding such objects as sea-urchins, corals, and sponges, adhering to the exterior of the dredge-net, and even to the lower part of the drag-rope, gave origin to one of the most efficient implements of modern deep-sea research.

When the beam-trawl, a well-known English appliance for the capture of bottom-fish, was first adopted into the outfit of the marine zoologist, we are unable to state; but it does not appear to have ever been extensively and systematically employed in scientific research until so used by the U.S. Fish Commission, beginning in 1873. It was afterwards used by the *Challenger* from 1873 to 1878, and now greatly excels the dredge in the extent and value of its results, wherever the ground is suited to its use.

The year 1871 was signalised by the organisation of the U.S. Fish Commission, one of the most important scientific establishments of modern times for marine zoological work. Although

instituted primarily for the investigation of fishery matters, it has, through the wise and liberal policy of its Director, Prof. Baird, accomplished most valuable results for marine biology. The latter department has been sedulously fostered, in the belief that its results would have an important bearing upon the practical questions at issue. No pains have been spared to perfect the methods of research, and many valuable contributions have already been made to the marine collector's outfit. These are briefly described below, and, as the history of the Commission is already well known to most readers, we need refer here to only a few points which have marked its progress.

The earlier explorations were carried on mainly by means of sail-boats, and were confined to comparatively shallow water. From 1873 to 1879 a naval tug was placed at the disposal of the Commission every year; but in 1880 the steamer *Fish Hawk*, a twin-screw propeller of 205 tons (n.m), was built expressly for the combined purposes of fish-hatching and dredging. Its small size and light draught prevented long trips at sea, but it was well adapted for deep-sea work, and was supplied with all the improved appliances, as well as those which had originated with the Commission, including wire rope, then recently introduced by the Coast Survey. In 1883 the steamer *Albatross*, described in vol. ii. of *Science* (pp. 6, 66), was completed, and made her first successful cruise in the spring of that year. Her log for the summer of 1883 records the deepest trawling yet made in the Atlantic Ocean, the depth having been 2949 fathoms, and the results successful. Brief accounts of her dredging cruises under Lieut.-Commander Tanner, U.S.N., have appeared from time to time in late numbers of *Science*.

While the Fish Commission claims priority for many improvements in apparatus primarily intended for depths under a thousand fathoms, it willingly yields the palm for deep-sea improvements to the U.S. Coast Survey, especially in the persons of Commander Sigsbee, U.S.N., and Mr. Agassiz. The explorations of the steamer *Blake* from 1877 to 1880, in which the methods of deep-sea dredging and sounding were completely revolutionised, mark one of the most important stages in the progress of marine research. Wire rope was substituted for hemp, the dredge was altered to adapt it to the soft bottoms of deep water, on which dredging results had always been uncertain, and the beam-trawl was made reversible. The methods of handling and reeling the rope were also perfected. These changes and additions were briefly described and figured from time to time as work progressed in the *Bulletin* of the Museum of Comparative Zoology, at Cambridge, by Mr. Agassiz and Mr. Sigsbee, and were afterwards fully discussed by the latter in one of the most elaborate and instructive reports ever dedicated to the methods of deep-sea research.<sup>1</sup> It is a quarto volume of 208 pages and 41 plates, describing the sounding and dredging appliances used by the *Blake*, and which, for the greater part, were devised or improved during her dredging cruise. So far as her dredging appliances are concerned, the credit for changes made belongs mostly to Mr. Sigsbee and Mr. Agassiz, the former having been in command of the expedition, and the latter in charge of the natural history operations.

During the seventh decade, European explorers were not idle, and numerous deep-sea expeditions were fitted out. Most notable among these was the cruise of the British ship *Challenger* around the world between 1873 and 1878. Her scientific results were most interesting; but the older methods of deep-sea work were not greatly altered, although the practicability of using the beam-trawl successfully in the deepest water was fully demonstrated.

In 1881 the French Government inaugurated a series of submarine explorations in the Atlantic Ocean and Mediterranean Sea; for that purpose fitting out a small naval vessel, the *Travailleur*, and placing the management of affairs in the hands of a competent scientific staff, under the directorship of Prof. A. Milne-Edwards. These investigations were continued by the same vessel during 1882, the appliances and methods of work having apparently been patterned after those generally recognised in Europe. In 1883 a larger vessel, the *Talisman*, was assigned to the work, and operations were established on a much grander scale than before.

For an account of these explorations, descriptive of the methods of work and general results, we are indebted to the last volume of *La Nature*, a French journal of the character of

<sup>1</sup> "Deep-Sea Sounding and Dredging: a Description and Discussion of the Methods and Appliances used on Board the Coast and Geodetic Survey Steamer *Blake*." By Charles D. Sigsbee, Lieut.-Commander U.S. Navy Assistant on the Coast and Geodetic Survey. (Washington, 1880.)

<sup>1</sup> *Bulletin Mus. Comp. Zool.*, Cambridge, vol. i., 1863-69, pp. 103-120.

*Science*, which began in a January number the publication of a series of articles by one of the naturalists who accompanied the steamer.<sup>1</sup> Coming from such an authoritative source, we are led to regard these papers almost in the light of a semi-official report, and look to them for at least a correct statement regarding the origin of their methods of work, inasmuch as these matters are discussed in some detail, and with evident pride at the completeness of the outfit. That the outfit was complete no one who is at all posted on the subject can deny; for nearly all of the many improvements introduced by the Coast Survey and Fish Commission prior to 1880 are most faithfully copied, and most heartily praised for their perfect adaptation to the requirements of research.

We glance through the several pages of the report for at least some slight acknowledgment on behalf of American inventive skill; but beyond a brief statement to the effect that the hoisting-engine "was of the same type as that employed by Mr. Agassiz," and that he also "used with good results the common form of beam-trawl," we are left to infer that the entire outfit was of French origin; and such must be the impression of every one who reads these papers. In fact, in several instances, credit is explicitly bestowed on French inventors for certain of the appliances which do not differ in any essential features from the corresponding American patterns.

What is to be gained by thus appropriating to the credit of a nation what properly belongs to another and a friendly one, by all the rights of international courtesy, it is difficult to understand, and especially so in this age of supposed enlightenment, when every important discovery is carried with lightning rapidity to all parts of the civilised world. The field of marine research is sufficiently broad to engage the entire attention of all the naturalists who have yet entered it; and the frequent manifestations of jealousy on the part of foreign, and especially French, investigators, which often result in wholly ignoring the works of an able American author, can but retard progress instead of aiding it.

Proofs of the superior excellence of American methods of deep-sea research may be found in every important scientific library of Europe as well as this country; and at the two most prominent International Fisheries Exhibitions of the world—those of Berlin in 1880, and London in 1883—all of the American appliances were displayed, and received the highest awards. They have therefore been made sufficiently well known to establish their merits before the scientific world; but, as no descriptions of them have yet been published for the benefit of the general public, we propose in future numbers of *Science* to give accounts of their construction, and of the causes which lead to their introduction.

RICHARD RATHBUN

### WHY TROPICAL MAN IS BLACK

THERE are few subjects the explanation of which has taxed the ingenuity of man more than the existence of extremes of colour in different sections of the human race. Tradition has attributed the dark race to one of three brothers, the other two being progenitors of the opposite hue, without at the same time offering any solution of the variation from a common

Physiologists have vaguely asserted that a black skin is best suited to a hot climate, but do not attempt to reconcile the fact that a black coat is certainly the least adapted to the same condition. Evolutionists would doubtless say that in those early days when man in the dense forests of the time was fighting his brave struggle of brain against fangs and claws, the dark skin mingling with the shadows of the overhanging foliage gave him a chance of survival; but this reaches the conclusion that the first men were black, and that all white men proceeded out from these.

Yet even if this be so, and if the dark skin served only for concealment, why on the burning tablelands and treeless undulations of Central and Southern Africa, where there is scarce a bough to shelter him, has man for so many thousand years preserved a colour which has become the standard of all blackness? Surely there must be some other explanation of the fact that man beneath the vertical rays of a tropic sun has persisted in maintaining a hue of skin which would appear to have the effect only of absorbing and accumulating the intense heat of his surroundings. Some reason why the ryot of India can labour in the plains

<sup>1</sup> For an abstract of the portion relating to the apparatus employed, see *Science*, No. 62.

clad only in the scantiest loin-cloth, and why the African can limit his full dress to a few inches of monkey-tails.

The rapidly accumulating evidence of the practical utility of every peculiarity, and the proofs that nature, by hoarding up a little of each individual advantage through countless generations, has arrived at the best condition for each environment, compel us to realise the fact that in the tropics darkness of skin contributes to survival.

That this colour will absorb heat more than any other is as true of the skin of a man as of the roof of a house; therefore the anomaly is reached that in the tropics he is fittest who is hottest, so long as heat is regarded as the only factor in the consideration. But that one cannot live by heat alone is as true of the animal kingdom as of the whole vegetable world. Light, the twin stimulant of life, because perceptible to our consciousness by its action on a specialised nerve, has been too much limited in our conceptions of its influence to that duty only.

The gigantic processes of nature by which the great vegetable world, past and present, has been built up, the oxygen of water divorced from its hydrogen in the leaves of plants, and carbonic acid resolved into its constituents, were and are accomplished by the light-waves of the sun; and yet in the animal kingdom the action of these waves upon the eye is held to be almost their sole effect.

The craning offshoot of a window-plant, the twisted leaves of an indoor flower are sufficient evidence of the resistless power of light, and the proofs of its effect on man are as numerous as those of its action on plants; the mode only of that action is the mystery, and yet if this can be even partially explained, enough may be attained to show why those in whom a portion of the rays of the glaring tropic sun are blocked at the surface are best adapted for survival beneath its vertical beams.

As has been expressed by Prof. Tyndall ("Atoms, Molecules, and Ether Waves," *Longman's Magazine*, Nov. 1882), "We know that all organic matter is composed of ultimate molecules made up of atoms, and that these constituent atoms can vibrate to and fro millions and millions of times in a second." Nerve is organic matter, and "whether we meet with nerve tissue in a jelly fish, an oyster, an insect, a bird or a man, we have no difficulty in recognising its structural units as everywhere more or less similar. These structural units are microscopic cells and microscopic fibres, the function of the fibres is that of conducting impressions (represented by molecular movements) to and from the nerve cells, while the function of the cells is that of originating those of the impressions which are conducted by the fibres outwards," (*vide* "Mental Evolution in Animals," Romanes).

We can conceive then that the way in which a nerve-fibre conveys to a more central nerve-cell an impression from the surface is by rapid vibration of its component molecules. Such vibrations can be rudely originated by contact, pressure, or such like stimuli, till they give rise to feeling, or, if severe, to pain, but they can be not only improvised, they can be communicated. The simplest illustration of vibrations being communicated is when a piano is opened and sung into; whereupon the string whose tension coincides with the uttered note will take it up and pass it on in sound. If then vibrations were taking place in the immediate vicinity of the sentient extremities of nerves all over the surface of the body, the same would be expected to occur.

The waves of light and heat follow each other at similar rates through the luminiferous ether.

Man lives at the bottom of a measureless ocean of this subtle medium, and is, in common with all else in the universe, permeated by it. "When, therefore, light or radiant heat impinge, like the waves of sound just adverted to, their waves select those atoms whose periods of vibration synchronise with their own periods of recurrence, and to such atoms deliver up their motion. It is thus that light and radiant heat are absorbed." (Tyndall).

Is it not from this easily intelligible how heat-waves notify their existence and intensity along the surface fibre to the central nerve cell, and so enable the animal to avoid their action, if excessive, or seek their increase, when deficient. And shall it be said that while the heat-waves are thus received, and responded to, through every instant of existence, their fellow-workers, the waves of light, are practically inert except for the stimulation of the one specialised nerve of the eye?

By going from the complicated and compound to the structureless and simple, the question can be answered in no uncertain way.

In some of his recently published experiments, Engelmann found that many of the protoplasmic and unicellular organisms are affected by light, and when the first animals possessed of organs of special sense, viz., the jelly-fish, (*Meduse*), are reached it is found that one particular *Medusa* (*Thiaropsis polybladema*) always responds to strong luminous stimulation by going into a spasm or cramp (Romanes).

But there is a still stronger argument in favour of the powerful action of light on the nerves of the skin in the fact that, as Prof. Hæckel says, "the general conclusion has been reached that in man, and in all other animals, the sense organs as a whole arise in essentially the same way, viz. as parts of the external integument, or epidermis." In fact, that nerves which now see could once but feel. That the highly sensitive optic nerves are but nerves of the skin, whose molecules once could vibrate only in consonance with the large ultra-red waves of heat, whereas now their molecules have become attuned to the shorter waves of the visible part of the spectrum.

Surely, then, if any one of the nerve-endings of the skin indiscriminately can be specialised for the recognition of light, whether at the margin of the swimming disk in the jelly-fish, at the point of the ray in the star-fish, on the fringe of the mantle in the shell-fish, or on the back in some species of snail, it must be conceded that in the first instance all surface nerves must feel the influence of that agent by which they are to be hereafter exalted. And this has been reduced to a demonstration by Mr. Darwin in his investigations on earthworms, which, although destitute of eyes, are able to distinguish with much rapidity between light and darkness, and as only the anterior extremity of the animal displays this power he concludes that the light affects the anterior nerve-cells immediately, or without the intervention of a sense-organ. But a yet more wondrous lesson is to be learned from the steps which Nature takes for the exaltation of a heat-responding nerve into one capable of vibrating in harmony with the shorter waves of light.

The only external agents available are heat and light, and by these, with such local adaptations as are possible, the conversion must be brought about.

Seeking again from the lowest organisms the secrets of the highest, it has been found by Engelmann that the simplest creature which responded to luminous stimulation was the protoplasmic *Englema viridis*; moreover, that it would only do so if the light were allowed to fall upon the anterior part of the body. Here there is a pigment spot, but careful experiment showed that this was not the point most sensitive to light, a colourless and transparent area of protoplasm lying in front of it being found to be so.

From this, the most rudimentary, through the pigmental bodies round the margin of the swimming disk of medusæ, and the pigmented ocelli at the tips of the rays in star-fish, to the lowest vermes, in which Prof. Hæckel finds the usual cells sensitive to light separated by a layer of pigment cells from the outer expansion of the optic nerve, we meet with the same arrangement ever progressing upwards, viz., transparency immediately in front of the part to be exalted, and pigment immediately behind it, and are left to infer from the object ultimately attained what is the reason of this primary adaptation.

Nature has made the most of her two factors, by exposing the selected tissue to the continued impinging upon it of the waves of light, while at the same time securing not only the transmission through it of the waves of heat, but their constant accumulation behind it, thereby causing the molecular constituents of the protoplasm to be thrown into the highest rates of vibration possibly obtainable with the means at disposal, and undoubtedly more rapid than those of any protoplasm not so situated; till little by little, by the survival here and there of individuals who had derived some benefit from inherited increase of sensitiveness in the exposed parts, the time arrived when the advantage became permanent in the species, and the foundation was laid in a transparent atom of protoplasm lying in front of a speck of pigment, of those wondrous organs which in aeons of ages afterwards were to enable man to look upon the universe and to behold that it was good.

Such is what light and heat in unison have wrought, and is it to be supposed that their action on the surface nerves is less powerful now than ever? Is it not more reasonable to think that a larger number of specialised nerves not being an advantage have not been developed, and that though we are unconscious of the power of light upon our bodies, yet that analogy points to the fact that to it, when combined with heat, we owe the highest exaltation of our keenest sense?

Recognising thus the effects of simultaneous light and heat when their influence is concentrated by a local peculiarity on a particular part, must it not be evident that in an individual unprotected by hair and unscreened by clothes, living beneath the vertical rays of an equatorial sun, the action of these two forces playing through a transparent skin upon the nerve-endings over the entire surface of the body, must be productive of intense, but at the same time disadvantageous, nerve vibrations, and that presumably such individuals as were least subject thereto would be best adapted to the surroundings?

Nature, therefore, having learned in ages past that pigment placed behind a transparent nerve will exalt its vibrations to the highest pitch, now proceeds upon the converse reasoning, and placing the pigment in front of the endangered nerve reduces its vibrations by so much as the interrupted light would have excited, a quantity which, though apparently trifling, would, when multiplied by the whole area of body-surface, represent a total of nervous action that if continued would soon exhaust the individual and degrade the species.

Thus it is that man, though so many generations have come and gone since the days of his weaponless struggles with the beasts of the forest, still retains in its full strength that colour of skin which, while it aided him materially in his early escapes, is now continued because it has a more important office to fulfil in warding off the millions of vibrations a second which would otherwise be poured in an uninterrupted stream upon his exposed nervous system.

Again, the chemical power of light expressed in degree is, according to Professor Bunsen in Berlin, on the 21st of June at 12 o'clock, 38°, while at the same place and time on the 21st of December it is but 20°, that is, that the difference in the angle at which light strikes the same spot in December and in June causes its chemical effect to be almost doubled. What then must be its potential difference all the year round in the latitude of London and in that of Sierra Leone?

If, therefore, light be a necessary factor in the development of animal life, and be of sufficient intensity to attain the required end in the northern position of England, it must of necessity be at the equator immensely in excess, all other things being equal of what is needed, and it would be a reasonable expectation that could unclothed man be traced through the parallels of latitude northwards in distinct tribes that never intermingled with those beyond, the colour of the various sections would lessen in direct proportion to their distance from the equator, modified only by such local conditions as materially influenced the effect of light, or the action of light and heat combined.

And this is forcibly corroborated by the facts put forward in Carpenter's "Physiology," p. 985: "It may be freely admitted that among European colonists settled in hot climates such changes do not present themselves within a few generations; but in many well-known instances of earlier colonisation they are very clearly manifested."

"Thus the wide dispersion of the Jewish nation and their remarkable isolation, maintained by their religious observances from the people among whom they live, render them peculiarly appropriate subjects for such observations, and we accordingly find that the brunette complexion and dark hair which are usually regarded as characteristic of that race are frequently superseded in the Jews of Northern Europe by red or brown hair and fair complexion, whilst the Jews who settled in India some centuries ago have become as dark as the Hindoos around them."

Finally, there is in a footnote to the same page an extraordinary physiological demonstration of the truth of the proposition that skin colour is in direct proportion to light-rays, which is as follows:—

"A very curious example of change of colour in a negro has been recorded on unquestionable authority. The subject of it was a negro slave in Kentucky, æt. forty-five, who was born of black parents, and was himself black until twelve years of age. At that time a portion of the skin an inch wide encircling the cranium just within the edge of the hair gradually changed to white, also the hair occupying that locality; a white spot next appeared near the inner canthus of the left eye, and from this the white colour gradually extended over the face, trunk, and extremities until it covered the entire surface. The complete change from black to white occupied about ten years, and but for his hair, which was crisp and woolly, no one would have supposed at this time that his progenitors had offered any of the characteristics of the negro—his skin presenting the healthy vascular appearance of a fair-complexioned European. When he was about twenty-two years of age, however, dark copper-

coloured or brown spots began to appear on the face and hands, but these remained limited to the portions of the surface exposed to light."

May it not therefore be claimed that there is much foundation for the suggestion that the black skin of the negro is but the smoked glass through which alone his widespread sentient nerve-endings could be enabled to regard the sun?

NATHANIEL ALCOCK,  
Surgeon-Major, Army Medical Department.

Since the foregoing was written there has appeared in the *British Medical Journal*, July 26, a most valuable paper by Dr. Gresswell on "Some Effects of Variations of Light," which sums up in these words, "We are tempted to conclude that light and heat impose each its own effects upon plants, as they do upon animals," and that "light is a stimulus direct as well as indirect."

### SCIENTIFIC SERIALS

*Atti della R. Accademia dei Lincei*, May 18.—On the molybdate of didymium, by Alfonso Cossa.—On the geological constitution of the Maritime Alps, by D. Zaccagna.—On some psychological difficulties that may be solved by means of the idea of the infinite, by Francesco Bonatelli.—Remarks on the Oriental manuscripts of the Marsigli Collection at Bologna, with a complete list of the Arabic manuscripts in the same collection, by Baron Victor Rosen.—The Ligurians associated with the barrows of the first Iron Age found in the district of Golasecca, Lombardy, by Luigi Pigorini.—Note on Bartolomeo da Parma, an astronomer of the thirteenth century, and on a treatise by him on the sphere preserved in the Victor Emmanuel Library, by Enrico Narducci.—Report on the antiquities discovered in various parts of Italy during the month of April, by S. Fiorelli.—Meteorological observations made at the Observatory of the Campidoglio during the month of April.

June 1.—Obituary notice of A. Wurtz, by S. Camizzaro.—On the expansion of sulphuric ether under various pressures, by G. Pietro Grimaldi.—On the physiology and pathology of the supra-renal capsules, by Guido Tizzoni.—Analysis of a silicated hydrate of baryta, by Alfonso Cossa and Giuseppe La Valle.—On the observations of atmospheric electricity made at the Central Meteorological Office, Rome, by Pietro Tacchini. Meteorological observations made at the Observatory of the Campidoglio during the month of May.

June 15.—Description of a Buddhist Codex in the Pali language, forwarded to the Academy by L. Nocentini, Italian Vice-Consul at Shanghai.—Obituary notice of Hermann Ulrich, by S. Ferri.—Reports on the influence of heat and magnetism on the electric resistance of bismuth, by Prof. Augusto Righi; on the constants of refraction, by Dr. R. Nasini; on the capillary equivalents of simple bodies, by Prof. R. Schiff.—Note on a problem in electrostatics, by Vito Volterra.—A method of determining the ohm in absolute measure, by Guglielmo Mengarini.—Experimental researches on the variation in the density of water between 0° and 10°, by Filippo Bonetti.—On the spectrum of absorption of the vapour of iodine, by Arnolfo Morghen.—Remarks on Shelford Bidwell's new explanation of Hall's phenomenon, by Augusto Righi.—On the electric conductivity of the combinations of carbon, by Adolfo Bartoli.—On the penetrability of glass by gases under pressure, by Adolfo Bartoli.—On the coexistence of different empirical formulas, and especially on those containing the capillary constant of liquids or the cohesion of solids, by Adolfo Bartoli.—On the atmospheric waves produced by the Krakatoa eruption, and observed at Palermo, by Gaetano Cacciatore.—Remarks on the dynamics of storms, by Ciro Ferrari.—On the intestinal canals and branchial tubes of the Salpidae, by Francesco Todaro.—Report on the antiquities found in various parts of Italy during the month of May, by S. Fiorelli.

*Revue d'Anthropologie*, tome viii., fasc. 3, Paris, 1884.—The contents are:—An unfinished paper of Paul Broca, on his mode of preparing the cerebral hemispheres, which, with another chapter on the best methods of casting the required moulds, was to have formed part of the treatise on the circonvolutions of the cerebral brain, on which he was engaged at the time of his death. The present paper breaks off in the middle of his examination of the process of mummifying the brain.—An essay on the ethnology of North Africa, by M. Camille Sabatier. The paper is entirely devoted to the consideration and recapitulation

of the geographical descriptions given by Herodotus, Salust, and other ancient writers of Lybia, under which designation most of the then known African continent was included. It also treats of the great invasions from Asia, and of the differences between the various African races. As distinct from the Lybians or mountaineers, and the Getulæ or pastoral occupants of the plains, the author believes we may recognise a separate branch, which bore the name of Esces or Oses, and which probably have given origin to the modern Basque Escaldunacs and other kindred western races.—A continuation of M. Deniker's observations on the Kalmuks. This paper is devoted specially to the sociology of the people, the condition of the women, and the practices observed at betrothals, marriages, &c., being fully treated of. The Lamas, who exercise a great influence on the people—intervening in all the great events of life from the cradle to the grave—are employed in several of the steppes by the Russian Government to keep the civil registers of the various hordes. On various skulls of Arizona and New Mexico, by M. Ten Kate. From a comparative study of these and other crania collected by the author in his extensive travels in the Far West and in the Mexican territories, he is inclined to regard the constructors of the *casas grandes* of Arizona and the "cliff-dwellers" as closely allied to the Indian tribes of the Pueblos, or so-called "towns" of New Mexico. He found the same brachycephalic characteristics and the same evidence of artificial deformity in skulls of the ancient Pueblos of Quarra as in the modern Mexican Indians.—On the circumference of the thorax, and its relation to the dimensions of the rest of the body, by M. Ed. Goldstein. This paper is based on the data supplied by Dr. Snigerev in his great work on the recruiting of the Russian army, more especially in the districts of the Vistula and the north west of the empire. The great ethnological fact established by these determinations appears to be that, as compared with Poles, Germans, Lithuanians, Russians, and Samogitians, the Jews are distinguished by relative smallness of stature, and by the generally inferior dimensions of the chest, in both of which particulars they would appear to fall considerably below the mean of all the other races brought under the notice of the authorities at the head of the department for recruiting the Russian army.

*Rendiconti del Reale Istituto Lombardo*, July 17.—Note on the present conditions of the agricultural interests in Europe and America (continued), by Prof. Gaetano Cantoni.—Memoir on cellules and parasites in their pathological relations (concluded), by Prof. G. Sangalli.—Mental affection of Torquato Tasso; his detention in the Hospital of Sant' Anna, according to some recently-discovered documents, by Prof. A. Corradi.—On the equilibrium of elastic and rigid surfaces, by Dr. Gian Antonio Maggi.

### SOCIETIES AND ACADEMIES

#### EDINBURGH

**Royal Society**, July 21.—The Right Hon. Lord Moncreiff, President, in the chair.—Mr. John Murray communicated, with remarks, a paper by Dr. Guppy of H.M.S. *Lark*, on the coral reefs and calcareous formations of the Solomon Group Islands. Dr. Guppy showed that the coral rocks were merely superficial, thus confirming Mr. Murray's theory that coral atoll and barrier reefs were formed without subsidence. A chalk, like the white chalk of England, had been discovered on one of the islands.—Prof. Tait gave an approximate empirical formula representing, for certain ranges, the compressibility of water in terms of the temperature and pressure.—Mr. J. T. Cunningham read a critical note on the latest theory in vertebrate morphology.—Mr. Milne Home submitted the tenth and final report of the Boulder Committee. At some period, geologically recent in the earth's history, an Arctic climate prevailed in the part of Northern Europe considered. As an effect, local glaciers occurred in Scotland, of some of which there were traces still visible. Subsequently Scotland was entirely submerged beneath the sea, and most of the valleys were filled with sand, gravel, and mud. A north-westerly oceanic current prevailed, carrying masses of floating ice with boulders, which were deposited on the hills.—Mr. H. R. Mill gave a paper on the periodic variation of temperature in tidal basins.—Mr. W. Peddie gave a communication on the isothermals and adiabatics of water near the maximum density point.—The meeting, which was the last for the session, was brought to a close by remarks from the Chairman on the work of the past session.

## SYDNEY

Linnean Society of New South Wales, June 25.—The vice-president, Dr. James C. Cox, F.L.S., &c., in the chair.—The following papers were read:—Occasional notes on plants indigenous in the immediate neighbourhood of Sydney, No. 7, by E. Haviland.—On the new Australian fishes in the Queensland Museum, Part II., by Charles W. De Vis, M.A.—Sixteen species are here described, viz.:—Seven of the family Squamipinnes, two of the Mullidæ, one of the Sparidæ, four of Scorpænidæ, and two of the Teuthididæ.—On a marine species of *Philongria*, by Charles Chilton, M.A. The Isopod described in this paper was obtained at Coogee Bay last December. The specific name "*marina*" is given to it, as it is the only marine species of the genus known to the author.—The Australian Hydromedusæ (continued), Part iv., by R. von Lendenfeld, Ph.D. In this paper the numerous Australian species of Graptolithes, described by Prof. McCoy, of Plumularidæ described by Allman, Bale, Kirchenpauer and Busk, and of the Dicoryuidæ, are sifted and catalogued with references, and a large number of new and interesting species, and one new genus discovered by the author are described and figured. The Australian Plumularidæ exceed in the number of species the Plumularidæ of all the rest of the world put together.—On the flesh spicules of certain sponges, by R. von Lendenfeld, Ph.D. In a former paper the author expressed his opinion that flesh-spicules in sponges do not, as it was hitherto supposed, only occur in such species as possess a fibrous siliceous skeleton, but that they may make their appearance in any species, so that their existence cannot be considered of sufficient import to allow of a separate family being formed, comprising such sponges only which possess flesh-spicules. The author had based this hypothesis partly on general conclusions and partly on the observation of a true horn-sponge, a *Hircinia*, with flesh-spicules. Now the author is enabled to prove his hypothesis by further discoveries, which he made during the investigation of the numerous and valuable sponges of Port Jackson. He found, namely, three species possessing flesh-spicules, which, according to the structure of their fibrous skeleton, should be placed in the families of the horn-sponges.—Note on the slimy coating of certain *Boltenias* in Port Jackson, by R. von Lendenfeld, Ph.D. Some solitary Ascidians, similar to the ordinary *Boltenia australis*, which grows close to low tide mark, but which are found in deep water exclusively, are covered with a very slippery slime, an occurrence without precedence in Ascidians. This slime was investigated by the author, and found to consist of a thick layer of ova in their follicular-capsules. The slime is supposed to be formed by the cylindrical cells of the Follicule.—Report on the Australian Echinodermata exhibited at the Fisheries Exhibition, London, by F. Jeffery Bell, M.A., &c. This paper was communicated and read by E. P. Ramsay, F.L.S., &c. It contains a list of all the named species in the collection sent to London, viz. 10 species of the class *Crinoidea*, 12 of the *Asteroidæ*, 19 of the *Ophiuridæ*, and 30 of the *Echinoidæ*, with critical notes, &c.—Mr. Macleay exhibited for Mr. Wilkinson a very peculiar conical stone implement, found by Mr. A. G. Brook of Gondoblu Station, embedded in the soil on the plains near the Queensland border, between the Narran and Barwon Rivers. The note accompanying the exhibit states that there are no rocks near that locality, and that the old aboriginals of the district know nothing about it. The stone is composed of a soft, fine, white sandstone, is of conical form, nineteen inches in length and four inches in diameter in the middle: the surface presents a smooth, worn appearance. Dr. Cox suggested that it had probably been used for grinding nardoo, and that view seemed to receive most favour, though a number of different opinions were expressed. Mr. Macleay also exhibited for Mr. Wilkinson a number of helix-like shells, wound spirally round the leaf-stalks of a species of Eucalyptus, at Branxton on the Hunter. These shells, though calcareous, were pronounced not to be the production of any molluscous animal, and the general opinion was that they must be egg cases of some insect.—A large collection of shells and echinodermata from Cossack, Western Australia, sent by Mr. J. F. Bailey of Melbourne for exhibition, were on the table. Among the rarities *Comus trigonus* (Reeve), *Comus Victoria* (Reeve), *Ancillaria cingulata* (Sowb.), *Ancillaria elongata* (Gray), *Olivæ Caldanica* (Duclos), *Spondylius Wrightianus* (Cross).

## PARIS

Academy of Sciences, August 11.—M. Rolland, President, in the chair.—Note on the disposition of the foetal envelopes in

the aye-aye (*Chiromys madagascariensis*), by M. Alphonse Milne-Edwards. The author finds that there is nothing abnormal in the foetal membranes of the aye-aye, and that they correspond in every respect with those of the typical lemuriens, with which they must be definitely classified.—Observations in connection with a recent communication of General Menabrea on Charles Babbage's analytical calculating-machine, by M. Léon Lalanne. From an interview with Mr. Babbage at London in 1851 the author is led to believe that a document is still in existence either among the papers of M. Binet or among those of Mr. Babbage himself, in which he gives his final views on the subject of calculating-machines in general. M. Lalanne here publishes two original letters of Mr. Babbage referring to that document, and dated June 19, 1851.—Examination of two theorems connected with the rule of Newton; conclusions, by M. E. de Jonquières.—Remarks on the volcanic debris collected on the east coast of the island of Mayotte, at the north-west end of Madagascar, by M. E. de Jonquières. These debris, which were thrown up in considerable quantities on May 16, 1884, consisted of fine pumice, probably from Krakatoa. Amongst them was a large specimen already incrustated with shells. They appear to have traversed a distance of about 3840 nautical miles in 259 days at a mean velocity of 14·8 miles a day.—Note on the phenomenon of globular electric bolts, two illustrations, by M. Gaston Planté. The author produces artificially effects analogous to those of the fire-balls so often witnessed in the atmosphere.—Researches on some combinations formed by haloid salts with the oxygenated salts of the same metal, by M. II. de Chatelier.—Note on the influence of heat on the respiratory organs, by M. Ch. Richey.—Note on the influence of intellectual work on the elimination of phosphoric acid by the urine, by M. A. Mairet.—Anatomy of the maxillary apparatus in the locust, grasshopper, cricket, and other members of the family of grinding insects, by M. J. Chatin.—Contributions to the history of the Pliocene flora of Java, by M. L. Crié.—On some peculiar luminous phenomena observed about the sun at Morges, on the Lake of Geneva, by M. F. A. Forel.—Notes were received from M. Ch. W. Zenger on the possible existence of still undiscovered planetary bodies; from M. L. Jaubert on an acrolite seen on July 10; and from M. I. Favre on a classification of the sciences.

## CONTENTS

	PAGE
Technical Instruction, II. . . . .	381
Cotterill's "Applied Mechanics." By Dr. J. F. Main . . . . .	382
Our Book Shelf:—	
Graham's "Graphic and Analytic Statics in Theory and Comparison" . . . . .	383
Letters to the Editor:—	
School Museums.—Dr. J. H. Gladstone, F.R.S. . . . .	384
The Red Glows.—Prof. W. N. Hartley . . . . .	384
Remarkable Raised Sea-Bed near Lattakia, Syria.—Prof. Edward Hull, F.R.S.; Rev. Dr. George E. Post . . . . .	384
A Carnivorous Wasp.—F. N. . . . .	385
Intelligence of a Frog.—R. R. . . . .	385
Meteor.—Rev. J. Hoskyns-Abraham . . . . .	385
Podalirius minutus.—H. C. Chadwick . . . . .	385
Scales . . . . .	385
The Fishery Board for Scotland . . . . .	387
The History of a Typhoon . . . . .	388
Healthy Schools . . . . .	388
Notes from the Leyden Museum . . . . .	389
Przevalsky's Wild Horse. (Illustrated) . . . . .	391
The Difference between the Sea and Continental Climate with Regard to Vegetation. By Dr. M. Bergsman . . . . .	392
Notes . . . . .	394
Our Astronomical Column:—	
Schmidt's Variable-Star in Virgo . . . . .	397
The New Comet . . . . .	397
Brosen's Comet . . . . .	397
The Forests of Northern Europe . . . . .	397
The American Initiative in Methods of Deep-Sea Dredging. By Richard Rathbun . . . . .	399
Why Tropical Man is Black. By Surgeon-Major Nathaniel Alcock . . . . .	401
Scientific Serials . . . . .	403
Societies and Academies . . . . .	403

THURSDAY, AUGUST 28, 1884

## THE "ENCYCLOPÆDIA BRITANNICA"

*The Encyclopædia Britannica.* Ninth Edition. Vol. XVII. Mot-Orm. (Edinburgh: A. and C. Black, 1884.)

THE present volume of the "Britannica" contains an unusual number of articles of moderate length but of great importance. Among them are numerous articles of scientific interest, and of these we note especially the following:—

The article *Optics*, by Lord Rayleigh, is so good that it is to be regretted that considerations of space had to be attended to. The subject is one which has hitherto been presented in a form somewhat repulsive to the student; and the writer, who has contrived to make even *Primary and Secondary Focal Lines* attractive as well as interesting, deserves high credit. The general subject of Geometrical Optics had already been sketched in the article *Light*, so that the present article deals, almost exclusively, with the second (and sometimes higher) approximations. But Lord Rayleigh has not confined himself to the postulates of that science; he has freely availed himself of the principles of the wave-theory, whenever they were required to simplify a demonstration or to explain a result. And he intersperses, here and there, hints as to the easier methods of exhibiting and testing the results of theory, hints which will be of great advantage to the student.

Commencing with the theorem that a set of rays, originally perpendicular to a surface, can, after any number of reflections and ordinary refractions, be cut orthogonally by another surface, the author develops generally the properties of Caustics and Focal Lines. He then proceeds to apply these properties to prisms, mirrors, and lenses. The practical adjustment of the collimating and observing telescopes for spectroscopic work, and the accurate measurement of refractive indices are described. Here we have some interesting remarks on the reasons for employing the position of minimum deviation in the observation of spectral lines. Next we have the formation of a pure spectrum, specially for the purpose of securing a visual field uniformly illuminated with homogeneous light. This leads to a general sketch of the methods and results of von Helmholtz and Clerk-Maxwell with regard to compound colours. Then we have a discussion of Spherical and Chromatic Aberration, with some brief but highly practical remarks on the construction of achromatic and aplanatic lenses for different purposes. Stokes' important results as to the secondary spectrum are here given with some detail; and the methods of Foucault and Töpler for detecting slight defects of figure, or slight irregularities of refractive index, are explained. Next come the important questions of the brightness of an image, and the *resolving power* of an optical instrument. The limits to resolving power, with the important difference, in this respect, between the telescope and the microscope, are well, but only too briefly, given:—and we have also a short *résumé* of the author's own important discussion of the same question

VOL. XXX.—NO. 774

for spectroscopes and gratings. We conclude with the remark, which has been forced on us at almost every paragraph, that while brevity is often a most desirable virtue, it is one whose exercise should be permitted only to those (no doubt the majority) who have nothing to say. Lord Rayleigh would do a great service to science if, taking the present essay as a skeleton, he would develop it into a handy volume.

Prof. Cayley handles the subject of Numbers, from the mathematician's point of view, in two compact articles. That on the *Partition of Numbers*, which is little more than explanatory of the term, we pass over. That on the *Theory of Numbers* is a very carefully written account of the past condition and present position of a subject, "which, originating with Euclid, has in modern times, in the hands of Legendre, Gauss, Lejeune-Dirichlet, Kummer, Kronecker, and others [we may interpolate the names of Cayley, Sylvester, and Henry Smith], been developed into a most extensive and interesting branch of mathematics." The branch is well known to be one of limited interest, for does not De Morgan write that the subject is an isolated part of mathematics, which may be taken up or not at the choice of the student? It may possibly at some future time be connected with ordinary analysis; that is to say, the determination of the *integer* solutions of a set of equations may not be so distinct a thing from that of a mere solution, integer or not, as it is at present." The author distinguishes between the ordinary (or simplex) theory and the various complex theories. "In any theory, ordinary or complex, we have a first part, which has been termed the theory of congruences; a second part, the theory of homogeneous forms; and a third part, comprising those miscellaneous investigations which do not come properly under either of the foregoing heads." The details are too technical for these columns, but the *résumé* of results is drawn up in a manner likely to be most useful to a student, as it clearly indicates the present condition of matters, being brought down to the very latest date by a master who has done good work in this very direction. There are a few typographical inaccuracies; besides we note the following trifling (we think) oversights:—In Article 15 it is said: "If  $\phi$  is not a prime number, then  $1, 2, 3, \dots, (\phi - 1) \equiv 0 \pmod{\phi}$ ,"—surely it should be added, "except when  $\phi = 4$ "; in Art. 16, line 13, last bracket, for  $x - 3$  read  $x - 4$ ; in Art. 19, lines 9, 10, interchange 11 and 17; in Art. 20, line 15, should not 13 and 35 be relegated to the next line? The whole article is so carefully printed that we have thought it not out of place to point out these oversights.

Capt. Moriarty's reputation as a practical navigator has given an unusual interest to the article on *Navigation*, in which he may have been expected to impart to others the trick of his own skill. We must confess to a certain amount of disappointment. The essay is well enough, but it is not what we expected; not what, we still think, we had a right to expect. It is in fact little more than a short elementary treatise on the subject, comprising some of the simpler and more familiar problems, but taking little note of the more exact or more convenient methods which are often required, not perhaps for the daily determination of a ship's position at sea, but for the checking

T

of the chronometers and compasses, or for the more certain guidance of the vessel when in with the land. And for an account of such the "Encyclopædia" is, we conceive, the proper place: for it is not a work addressed to a youngster learning for the first time how to rough out a course and distance, or to work a meridian altitude or chronometer; but rather to the general reader wishing to gain some insight into the methods in use, or to the adept who is desirous of a ready reference to those branches of the subject which do not come within the scope of the ordinary text-books.

It is thus that we do not agree with Capt. Moriarty in the disparagement of lunars, which he would relegate altogether to the examination room; the excellence of chronometers in the present day renders—he seems to say—lunars of no practical use; and holding this opinion, his notice of the problem is incomplete, and certainly very unpractical. But Sir Charles Shadwell, whose scientific knowledge of the subject is at least equal to that of Capt. Moriarty, has within these last three years pointed out ("Notes on the Reduction of Lunar Observations," Potter, 1881) that the lunar method is the only one which gives the seaman an independent astronomical solution of the problem of finding longitude at sea. "Chronometers," he says, "may fail, or go a-stray; accident or carelessness may neglect to wind them up; errors may have been committed in determining or applying their rates, which may not have been discovered till too late to rectify them. In these dilemmas, the sole remedy available for pointing out the real position of the ship in longitude, is a lunar observation." Capt. Moriarty presumably thinks that the rarity of such "dilemmas" renders them of no practical importance: that they do occur, however, is within the cognisance of every navigator; but we fear that under the influence of teaching such as this, the skill to get out of the dilemma in a masterly manner is rapidly becoming scarce: for, as Sir Charles Shadwell has well said, "Confidence in the hour of uncertainty cannot be improvised for the occasion; it can only be the result of habitual practice." We venture therefore to protest most earnestly against the pernicious doctrine to which Capt. Moriarty has lent the sanction of his name. If it is worth a ship's while to carry the cumbrous and costly array of masts and rigging as a stand-by in the event of the huge and powerful engines being disabled, it is surely at least equally worth while to carry the handy and inexpensive skill to observe and compute a lunar, as a check on the very delicate machinery of a chronometer.

In speaking of these, the most exact of all observations with the sextant, we may call attention to the very insidious error which arises from false centering, and which is much more common than is generally understood. To detect this and find the corrections for it, Capt. Moriarty recommends the taking and computing a number of equal altitudes, comparing the error of chronometer so found with the known error of chronometer. This method is excessively laborious, but may be shortened somewhat by the construction of a curve of error, as Capt. Moriarty has described. There is also the danger, which he has omitted to notice, of the whole work going round in a vicious circle; of first determining the error of chronometer by a faulty sextant, and of then using that error to correct the sextant. Capt. Moriarty appears not to

know, or has at any rate neglected to point out, that, for an almost nominal fee, sextants can be tested at Kew by a specially constructed apparatus, the invention (we believe) of Mr. Francis Galton. Many men buy a sextant with as little care as they would buy a gridiron; but no one who means to use his sextant for purposes of exact navigation should think of concluding the purchase without getting a satisfactory Kew certificate with it. If he does, he richly deserves all the trouble and annoyance which the neglect of this very simple precaution may entail.

Perhaps the best section of Capt. Moriarty's article is that in which he has treated of the modern application of what is commonly known as Sumner's method of determining a ship's position; what he says on this subject is admirable; we can only wish that he had devoted a little more space to it, and given it a full development; for the theory and the practical use of lines of equal altitude are, as yet, neither sufficiently understood nor attended to by navigators. It would, for instance, have been well to have called attention to the very exceptional value of Venus for these observations; and to the many special cases which arise when the bearing of a distant peak can be taken. In conclusion, we would heartily endorse Capt. Moriarty's commendation of Raper's "Practice of Navigation." It is, beyond question, the best practical work which has yet appeared, and we cannot but express our regret that neither in the Royal Navy nor in the Merchant Service, are its merits properly recognised. The text-book commonly used in the Navy is Inman's, as edited by Jeans; that used in the Mercantile Marine is Norie's. Either of them is very far inferior, as a practical work, to Raper; but the difficulty of changing an established text-book has hitherto been found insuperable.

#### LETTERS TO THE EDITOR

- [The Editor does not hold himself responsible for opinions expressed by his correspondents. Neither can he undertake to return, or to correspond with the writers of, rejected manuscripts. No notice is taken of anonymous communications.]
- [The Editor urgently requests correspondents to keep their letters as short as possible. The pressure on his space is so great that it is impossible otherwise to insure the appearance even of communications containing interesting and novel facts.]

#### The Electric Light for Lighthouses

IN your interesting article on the experiments on lighthouse illumination now in progress at the South Foreland (p. 362) the writer alludes to the remarkable quenching influence of even a light mist on the electric light as compared with either gas or oil lights, and suggests that the smaller area of the illuminating centre in the case of electricity may have something to do with the matter.

Apart from this, however, selective absorption by water vapour must play an important part, and a great deal must depend on the colour of the beam; that is to say, the proportion of different rays combined in it.

MM. Janssen, Angström, and others have shown that vapour of water in the atmosphere reduces the intensity of the violet end of the spectrum in a general manner and the red end in a more special manner. An examination of Angström's map of the telluric lines in the solar spectrum (see Schellen's "Spectrum Analysis," Huggins' translation, Fig. 95, p. 264) will show that, while the extreme red and all the blue ends of the spectrum are much darkened by absorption lines, there is a zone from between B and C to  $\delta$  which is comparatively free from them. This region includes the orange rays, and part of the red and yellow. It is the most luminous part of the spectrum, and contains the rays which will penetrate farthest in a fog. Hence it is that the

sun appears redder as it sinks towards the horizon, and loses more of its blue rays in the thicker atmosphere.

Gas and oil lights are richer in these penetrative rays than the arc light, which is peculiarly rich in the blue rays easily absorbed. Hence a gas jet can be seen a long distance in a fog, though, like the sun, it appears redder in tinge than usual. An arc light, on the other hand, is not seen far, however penetrative it may be in clear weather. I have often observed on London Bridge, in a fog, that the arc lamps become of a blank white; the brilliant arc seems to disappear, and the carbon points, slightly reddened, glow through the mist. The arc with its blue rays is the part which suffers most, and hence the larger the incandescent points in comparison, the likelier the light to penetrate. The ordinary electric incandescent lamp has, according to the late R. Sabine, 20 per cent. more orange rays than daylight, a fact which may account for its greater penetrative power than the arc; but, owing to its cost, it is debarred from lighthouse work.

On the whole it would appear advisable to employ the spectroscope in the South Foreland experiments, in order to find out what the absorptive action of mists is on arc, gas, and oil lights. If it should turn out, as above indicated, that the arc fails in penetration from lack of certain yellow, orange, and red rays, it might be useful to try the effect of supplying the needful rays by mixing certain salts with the carbons.

West Croydon

J. MUNKO

### The Cholera Germ

THE importance of our gaining clear ideas of the cause of cholera as soon as possible prompts me to venture to suggest the direction in which may be sought an explanation of the three propositions in NATURE (p. 26), and which "E. K." there says "appear to me to be in hopeless contradiction." The propositions are, substantially, as follows:—(1) The comma-shaped bacillus is the cause of cholera; (2) the alimentary canal is the exclusive organ of its entrance into the body; (3) the comma-shaped bacillus is killed by acid.

The life of most plants is destroyed by passing through the alimentary canal of animals or man, yet seeds of grasses, grains of cereals, &c., not infrequently pass through animals without destruction, and afterwards germinate and reproduce their kind. Seeds of small fruits sometimes pass uninjured through the human body and through birds. Spores of bacilli are known to withstand treatment which is destructive of the bacilli themselves. Unless the comma shaped bacillus is exceptional in not forming such spores, it seems to me that the three foregoing propositions may not only be thus explained, but that they may soon supply an explanation of what has been long wanting explanation, namely, the fact that the dejections of cholera patients are not often, if ever, found infectious when first voided, but soon become infectious. This accords perfectly with the three propositions if we suppose that the comma-shaped bacillus, soon after being voided in the dejections, forms spores which are capable of resisting the acids of the stomach. It seems very important to have this point investigated. To plead for such investigation, by whoever has opportunity, is a main object of this letter.

The many instances of the outbreak of cholera in this country (U.S.A.) immediately after infected baggage has been unpacked, might then receive easy explanation; the spores, being inhaled with the breath, would be likely to lodge in the posterior nares and pharynx, be swallowed, passed through the stomach, and in the nutritive alkaline fluids of the intestines find a congenial soil in which to germinate, forming comma-shaped bacilli giving off their poisonous by-product which seems to have such baneful influence on the human nervous system.

Lansing, Michigan, August 8

HENRY B. BAKER

### School Museums

DR. GLADSTONE does not allude to botanical specimens in his communication to NATURE last week (p. 384), but these can form a very interesting addition. In my father's parish school of Hitcham, he had a long row of phials fixed against the wall of the class-room, with the name of every plant of the parish attached below. These were kept constantly supplied by the children all through the summer. Whoever first brought any species had a small reward. The School Herbarium was entirely made by the children; and for the last twenty-five years I have used for teaching purposes specimens dried, mounted, and

labelled by the children of Hitcham School. Should any one desire further details on the subject of botany in schools, I shall be very glad to communicate with such.

Drayton House, Ealing

GEORGE HENSLOW

THE circulating loan collections of natural history specimens, referred to by Dr. Gladstone in his letter on this subject as being established at Liverpool, have been provided and organised not by the School Board but by the Free Library and Museum Committee of the Corporation. They owe their origin almost entirely to the Rev. H. H. Higgins, chairman of the Museum Sub-Committee, and their great value is due to the close personal attention which that gentleman and the Curator of the Museum (Mr. T. J. Moore) have bestowed on them. The specimens included in the collections are not only typical, but are of excellent quality, and cannot fail to arouse the interest of the children before whom they are brought. So far as the experiment has already gone it has proved very successful, and deserves to be widely known.

Having had the pleasure of bringing the matter of these collections forward in the discussion on Dr. Jex-Blake's paper at the Educational Conference, I should be glad if you would allow me to make this correction as to their origin.

21, Verulam Street, Liverpool, Aug. 25

W. HEWITT

### The Permanency of Continents

AS a small contribution to this theory, the Cornish beaches may furnish a quota. They are entirely composed of finely comminuted shells, with a small admixture of fragments of Bryozoa, spines of minute Echinoderms, and occasional mica flakes. Such sandy beaches occur in small bays, and if subjected to metamorphic action would form *lenticular masses of limestone* intercalated between the strata deposited above and below them. Hence such occurrences of limestone might well indicate such a *littoral* origin as is here displayed.

St. Ives

GEORGE HENSLOW

### Carnivorous Wasps

I ONCE witnessed a somewhat similar feat to that mentioned by "F. N." (p. 385). It was at a wayside inn in the Eifel. The tablecloth was covered with flies. The window was closed excepting one small corner at the top. A wasp entered, came direct to the table, but instead of attacking some stewed fruit thereupon, instantly seized a fly, bore it off, and after whirling round with it, made straight for the small means of exit and vanished.

One evening when at College a small beetle was flying round and round, but at some height over the lamp. A spider on the ceiling watching his opportunity, suddenly dropped upon it and *caught it flying!* He then ran up with it and began winding a belt of silk round its body. However the beetle ultimately managed to slip its meshes and escaped.

GEORGE HENSLOW

IN reply to your correspondent "F. N.," I would say that, while I do not recollect to have seen wasps, under natural conditions and in the open air, attacking flies, I have frequently seen a wasp, when shut up in a room, or supposing himself to be so (for wasps are very stupid in finding their way out of a room), attack and partially devour the common house-fly. I yesterday witnessed an instance of cannibalism on the part of the wasp. One of my drawing-room windows was closed, and on this seven or eight wasps were engaged in a fruitless struggle against the irritating and inexplicable glass, instead of escaping, as they might have done, through the other windows, which were open. One of them, more languid and weary than the rest, was crawling slowly up and down near the corner of the pane. Some minutes afterwards, looking up from my book, I noticed two of the other wasps engaged in furiously attacking this individual. After a few seconds, one of the opponents, perhaps endowed with higher moral susceptibilities than the other, flew away. The other seized upon the thorax of the now moribund wasp, and, after a few moments, began devouring him. I watched the process for a minute or two, and then the cover of a book put an end to the existence of the cannibal and of his prey.

A day without food reduces a wasp to a state of famine, and it might be easily ascertained whether he does not commonly,



like animals of a higher order, become a cannibal under these circumstances.

W. CLEMENT LEY

Lutterworth, August 22

I HAVE twice within the last few days noticed the same thing that your correspondent writes about, viz. wasps devouring flies. In the first instance the fly was found held fast by the feet of a wasp which I had killed; the fly was dead, but I think intact. In the second instance the body of the fly was reduced to a shapeless mass, and about half had been devoured, no doubt by the wasp. I had previously observed a wasp apparently attacking a butterfly (small white), possibly for the same purpose; it was, however, unsuccessful. I do not know whether it is unusual for wasps to do this, but I have certainly never observed it before.

H. N. DIXON

Northampton

THE question of your correspondent "F. N." in your last number (p. 385), inquiring whether the incident observed by him is an unusual occurrence or not, is one that has been so frequently asked that it is somewhat curious that the fact has not become recognised generally as constituting a regular habit of the insect. Four years ago several letters upon this subject were communicated to NATURE (*vide* vol. xxi. pp. 417, 494, 538, 563, and vol. xxii. p. 31), and many other notices of the practice might be quoted. Darwin related having observed a wasp seize and carry off a fly too large for convenient transport, which returned to the ground to cut off the wings to lighten its weight, and then flew away with it. During the hot months, butchers' shops, as I have frequently noticed, are much resorted to by wasps as a hunting-ground, and although they are also fond of the juice of dead meat, they are encouraged rather than destroyed, in consequence of the benefit they confer by their habit of preying upon "blow-flies," as I have more than once been told by the shopkeepers themselves.

WILLIAM WHITE

Highbury Hill, N., August 23

WITH reference to the account of the wasp and fly in NATURE by "F. N.," though not exactly an answer to the query put, still the following may be of some interest to him and others of your readers:—

I was sitting one day in an arbour in the grounds of Duff House, when a wasp and a bluebottle-fly fell at my feet. Here a scuffle (it could scarcely be called a fight) ensued, which lasted a few seconds. I think the wasp used its sting as well as its mandibles. The fly dead, the wasp then tried to lift it. This was frequently repeated, but without avail. The wasp then went round and round and over the fly several times. Then another trial. But no; it seemed to me that the fly was too heavy or too bulky. The wasp now began to nibble at the body of its prostrate victim, and at last severed it in two. It then seized one portion, and after making the attempt twice, succeeded, rose, and disappeared. In a little while, however, I was rather surprised to see the wasp return; at least one similar came, and having whizzed round about my head, looked at me, went and hovered for an instant or so above the spot where the other half of the fly lay, then alighted, and bore it off in triumph. I do not think that the wasp intended to eat the fly, but rather meant it as food for the larvæ at home.

THOMAS EDWARD

Banff, Scotland

SEEING the communication of "F. N." on a "Carnivorous Wasp" in last week's NATURE brings to my recollection a similar observation of my own about a fortnight ago. My attention was drawn to an immense number of wasps and flies feeding together, apparently in perfect amity, at the bottom of a recently emptied sugar hogshead that was lying on its side in the sun. The amity, I may say, was not altogether perfect, as when a wasp approached a fly the latter speedily gave way. Suddenly a wasp, which was flying about in the interior of the tub, darted on an unsuspecting fly which was peacefully regaling itself with sweets, and carried it off. I managed to trace its flight to a neighbouring wall, where I saw the wasp apparently busily engaged in devouring the fly. On approaching more closely, in order to find out if I could what these unamiable proceedings were, I disturbed the wasp, which flew away with the fly still in its grasp, and this time I was unable to follow it. My impres-

sion at the time was, I remember, that the wasp wished to rob the fly of its sugar. This was the only case I noticed.

Leicester, August 25

E. F. BATES

[We have received numerous letters of the same purport as the above. The subject was discussed in NATURE, vols. xxi. and xxii., as referred to by Mr. White above.—ED.]

### Fireballs

WHILST speaking of the electric discharge to the Rev. Canon Thomas, of Meifod, a few days ago, he told me that he was some years ago overtaken by a most violent storm of thunder and lightning whilst crossing on horseback a Merionethshire mountain. During this storm Mr. Thomas saw (what appeared to him to be) three balls of fire successively hurled to the ground near him from the clouds.

About a fortnight ago a sudden and violent thunderstorm broke over North-East London, when at least one building was struck. The window of my room was wide open at the top. During one of the peals of thunder a zigzag line of lightning was distinctly seen by me (and another person) to come into the room by the open window and form an irregular line of fire along the cornice of the room. In the middle of the zigzag there seemed to be a momentary stoppage, with a star-like expansion of the line. There was no reflection or optical illusion, and no damage was done.

W. G. SMITH

### A Cannibal Snake

I SEND the following brief history of a snake's meal off another about his equal in bulk.

Some years since I was amused at the conduct of a small triangular-headed snake about ten inches long that I encountered in a road, who coiled himself and struck at me as if to dispute my progress. He was a pretty little fellow, gray spotted, and I picked him up, and carrying him home, deposited him in a small fish globe with sand and stones in the bottom. Here he lived contentedly for several months without eating anything, although frequently tempted with various insects and other food. After three months or so, my neighbour's children brought in a small black snake, shorter, but rather larger in diameter than my pet, and we decided to place the two together. Scarcely had the new-comer touched the sand than my pet glided rapidly around the sides of the globe, and struck him with his fangs just behind the head. The black snake dropped apparently lifeless, the other retained his hold with his jaws, and winding his tail closely about midway up the body, stretched himself out and his prey at the same time, till he seemed to dislocate his vertebra. We could hear the black snake crack. An hour or so later I found that he had begun to swallow him, having already got the head fairly inside his jaws. I called my family and neighbours, and we watched the process for several hours. He coiled the lower part of his body around his prey at the distance of an inch or two from his jaws, so tightly that it seemed almost to cut it in two, and then appeared to curl himself together and force the portion between the coil and his jaw down his throat. When that portion was ingested, he took a fresh hold lower down and repeated the action. The black snake disappeared quite rapidly, until the amount swallowed distended and stiffened the other, so that he could not hold it with a coil. After this the process was slow and tedious, apparently being mainly carried on by alternate retractions of the jaws, and it took nearly half an hour to dispose of the last inch, which was of course very small. Finally he succeeded, and lay stretched out, a singular-looking specimen, his outline distorted by the convolutions of the reptile he had swallowed, which could plainly be traced through his distended skin. He lay quiet for several days, and apparently digested the greater portion of it. I never fed him again, and finally turned him loose, his parting salute being a vicious attack upon my boot.

C. F. CREHORE

Newton, Massachusetts, August 12

### WATER BELLS

THE accompanying design (from *La Nature*) represents a water bell, the invention of M. Bourdon, of more transparent and complete effect than those hitherto produced, which have all either made the water issue by a very diminutive annular orifice, or shot the liquid jet

against a disk of polished metal with slightly elliptic rim, producing in either case a bell fringed all round its circumference and lacking transparency.

The bell to which we here call attention is distinguished by the way in which it causes the liquid vein to expand as soon as it reaches the orifice of the ajutage. Instead of making it strike against a metal plate, the surface of which, however carefully polished, always betrays some imperfection, M. E. Bourdon brings an antagonistic column of water to bear on it, so that the jet expands and falls into the basin, forming a bell as clear as crystal and impervious enough to cut off all communication between the interior and circumambient air.

The pipe conducting the water from the reservoir ends in a truncated form of nozzle, of about 12 degrees of angular opening, in such a way as to make all the threads of water converge towards the middle of the jet. Over this is placed concentrically to the truncated nozzle a glass tube of about 20 cm. in length, and of the same interior diameter as that of the orifice by which the water rises from the reservoir. This antagonistic tube, as it may be called, has to be supported by a copper rod fixed either against a wall or on the margin of the basin, at a distance of 2 cm. between its lower extremity and the truncated appendage. The reservoir must be kept at a constant level by means of a water-gauge cock. The

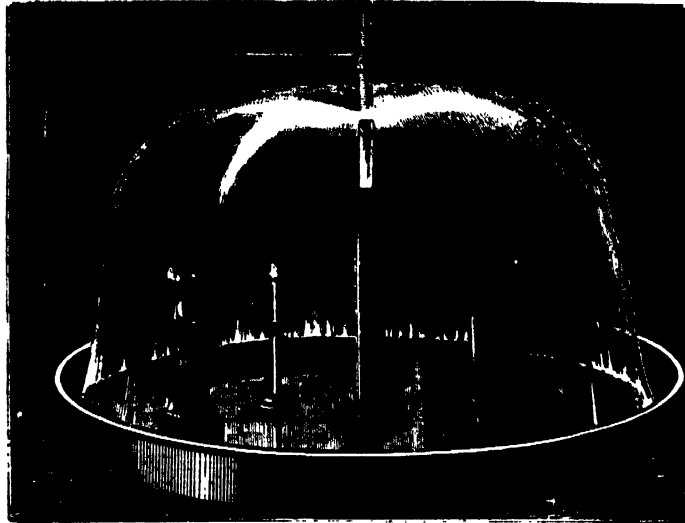

water-height above the jet will be about 60 cm. The flow of the water or its stoppage will of course be regulated by a cock.

The apparatus so arranged and the basin filled with water to the level of the overflow, the cock will be gently opened, and the water traversing the interval between the ajutage and the antagonistic tube will rise a few centimetres high in the latter. A ball of ovoidal shape will then come to view. By opening the cock very slowly its diameter will gradually enlarge till the bell assumes the form of a hemisphere. At this point let the opening of the cock be reduced a very little, and the bell will change its shape; its rim will become lowered to the

plane of the water of the basin, and its profile will show a bell similar to the gardener's bell glass.

By placing a very thin copper wire vertically towards the top of the bell, a vertical incision may be made in the bell, parting it into two separate sides. Through the gap thus formed, a statuette, a lighted candle, or a cage containing a bird, may be introduced inside the bell without wetting it. The tubes hitherto used have not exceeded 20 mm. in diameter; but by employing apparatus of much larger dimensions, water bells of from 3 to 4 metres in diameter might be produced just as perfect as those of from 60 to 80 centimetres, and under which people might walk about or lounge at pleasure.

SCIENCE AND THE SANDHURST EXAMINATIONS

WE have now before us the revised regulations for the examinations of candidates for admission to the Royal Military College, Sandhurst. Up to and including the summer examination of 1885 the present scheme is to remain in force. Under it Mathematics, English History, and Latin receive 3000 marks each; Greek, French, German, Experimental Science, General and Physical Geography and Geology count 2000 marks each. Candidates are left free to select any four of these subjects. They may also take up drawing, for which 1500 marks are given. After the summer of 1885 the subjects are to be grouped and marked as follows:—

	Marks
CLASS I.—1. Mathematics ... ..	3000
2. Latin ... ..	3000
3. French ... ..	3000
4. German ... ..	3000

CLASS II.—1. Greek ... ..	2000
2. Higher Mathematics ... ..	2000
3. English History ... ..	2000
4. Experimental Sciences ... ..	2000
5. Physical Geography and Geology	2000
CLASS III.—1. English Composition ... ..	500
2. Drawing, Freehand ... ..	500
3. „ Geometrical ... ..	500

Of these subjects candidates *must* take up three from Class I., and may take up either the remaining subject in Class I. or any one subject in Class II., and may also take up all the subjects in Class III.

These figures speak for themselves. Science is now placed on an equal footing with Greek and Higher Mathematics, &c., and its position is therefore somewhat improved as compared with that assigned to it in the proposals of a few months since. In the main, however, the revised scheme cannot be satisfactory to any one who has the interests of education at heart.

After our article of June 26 (p. 189) it is needless to go much further into detail, but it may be pointed out that hitherto certain subjects, of which Science is one, have had 2000 marks each, whilst three others have had 3000, and free choice of four subjects among these has been allowed. Owing to the great influence which marks have naturally exercised upon the choice of candidates and to other circumstances, the position of Science has been modest enough. In future, however, it will have (to put it numerically) about one-fourth of its previous chance, since, instead of the candidates being free to select four subjects, they will now only be free to select one. In short the final arrangements, though undoubtedly improvements upon those announced a few months since, and in one particular considerable improvements, are in their main features retrograde and unsound. They will hamper those of our schools which make it their aim to widen the basis of education in this country by the introduction of science into their regular work, and they will further discourage those who have hitherto hesitated from following their example. They will be a check on freedom and progress in education. The new regulations no doubt will encourage the study of modern languages. They do this, however, at too great a cost to other subjects of at least equal importance. We regret very much that the War Office authorities have not adopted some plan by which, whilst securing a knowledge of those subjects which they regard as professionally essential, they would have left a fairer field to such studies as Higher Mathematics, Natural Science, Greek, &c. Whilst we regret so much the blow to science teaching in our schools which is given by the final adoption of the scheme before us, and that young men of scientific capacity should stand so poor a chance of employment in our military services, we must acknowledge that in their revised regulations the War Office authorities have effected a distinct improvement by the new grouping of the experimental sciences and the addition of a practical examination to each group; although, from the greatly inferior position which science will hold in future, we fear that the practical advantage in the Sandhurst examinations will be very small. If, however, such a grouping of the natural sciences could be extended to the Woolwich examination also, it would be a great gain. The allotment of marks at present in force in the Woolwich competitions deals very fairly with the various subjects. Mathematics and Drawing, which are of special importance, are duly encouraged, whilst a fair liberty of choice among other subjects is left to the candidates. It has, however, been a complaint that, owing to the unequal difficulties presented by the present groups, some science subjects are unduly encouraged at the cost of others. This complaint ought practically to cease under such a classification as is now introduced into the Sandhurst scheme, for it ought no longer to be difficult for the examiners to set papers of fairly equal difficulty and range. We hope this change of detail may be extended to the science of the Woolwich examinations. We believe it would be welcomed by all those who have the interests of science teaching at heart.

#### THE BRITISH ASSOCIATION

THE fifty-fourth annual meeting of the British Association commenced yesterday at Montreal. About 800 members have arrived in Montreal from England, and the interest taken in the meeting both in Canada and the United States is evidenced by the great number of visitors which it has attracted to that city. The reception accorded to the Association both by the city and the Dominion is all that could be wished. Montreal itself has raised a fund of 40,000 dollars for expenses, and over 300 members have been received as guests into private houses. McGill College, where the Association meets, has been specially prepared for the purpose, and

there is every probability that the meeting will be a success in all respects.

The proceedings began last night with the address of the President, Lord Rayleigh, who was to be introduced by Sir William Thomson. To-day the Sectional proceedings began, and it will be seen from what follows that the addresses are quite up to the average. To-morrow evening Prof. Lodge delivers his lecture on "Dust"; on Saturday Prof. R. S. Ball gives the popular lecture, his subject being "Comets"; and on Monday evening Dr. Dallinger gives a richly illustrated account of the lowest forms of life.

Extensive arrangements have been made for excursions of the members to Quebec, Ottawa, and other places of interest in the Dominion and the United States, with garden parties, *soirées*, and receptions, in the intervals of the meetings. The citizens of Quebec are arranging to entertain 600 members on Saturday.

INAUGURAL ADDRESS BY THE RIGHT HON. LORD RAYLEIGH, M.A., D.C.L., F.R.S., F.R.A.S., F.R.G.S., PROFESSOR OF EXPERIMENTAL PHYSICS IN THE UNIVERSITY OF CAMBRIDGE, PRESIDENT

IT is no ordinary meeting of the British Association which I have now the honour of addressing. For more than fifty years the Association has held its autumn gathering in various towns of the United Kingdom, and within those limits there is, I suppose, no place of importance which we have not visited. And now, not satisfied with past successes, we are seeking new worlds to conquer. When it was first proposed to visit Canada, there were some who viewed the project with hesitation. For my own part, I never quite understood the grounds of their apprehension. Perhaps they feared the thin end of the wedge. When once the principle was admitted, there was no knowing to what it might lead. So rapid is the development of the British Empire, that the time might come when a visit to such out-of-the-way places as London or Manchester could no longer be claimed as a right, but only asked for as a concession to the susceptibilities of the English. But seriously, whatever objections may have at first been felt soon were outweighed by the consideration of the magnificent opportunities which your hospitality affords of extending the sphere of our influence and of becoming acquainted with a part of the Queen's dominion which, associated with splendid memories of the past, is advancing daily by leaps and bounds to a position of importance such as not long ago was scarcely dreamed of. For myself, I am not a stranger to your shores. I remember well the impression made upon me, seventeen years ago, by the wild rapids of the St. Lawrence, and the gloomy grandeur of the Saguenay. If anything impressed me more, it was the kindness with which I was received by yourselves, and which I doubt not will be again extended not merely to myself but to all the English members of the Association. I am confident that those who have made up their minds to cross the ocean will not repent their decision, and that, apart altogether from scientific interests, great advantage may be expected from this visit. We Englishmen ought to know more than we do of matters relating to the Colonies, and anything which tends to bring the various parts of the Empire into closer contact can hardly be over-valued. It is pleasant to think that this Association is the means of furthering an object which should be dear to the hearts of all of us; and I venture to say that a large proportion of the visitors to this country will be astonished by what they see, and will carry home an impression which time will not readily efface.

To be connected with this meeting is to me a great honour, but also a great responsibility. In one respect, especially, I feel that the Association might have done well to choose another President. My own tastes have led me to study mathematics and physics rather than geology and biology, to which naturally more attention turns in a new country, presenting as it does a fresh field for investigation. A chronicle of achievements in these departments by workers from among yourselves would have been suitable to the occasion, but could not come from me. If you would have preferred a different subject for this address, I hope at least that you will not hold me entirely responsible.

At annual gatherings like ours the pleasure with which friends meet friends again is sadly marred by the absence of those who can never more take their part in our proceedings. Last year my predecessor in this office had to lament the untimely loss of

Spottiswoode and Henry Smith, dear friends of many of us, and prominent members of our Association. And now, again, a well-known form is missing. For many years Sir W. Siemens has been a regular attendant at our meetings, and to few indeed have they been more indebted for success. Whatever the occasion, in his Presidential Address of two years ago, or in communications to the Physical and Mechanical Sections, he had always new and interesting ideas, put forward in language which a child could understand, so great a master was he of the art of lucid statement in his adopted tongue. Practice with Science was his motto. Deeply engaged in industry, and conversant all his life with engineering operations, his opinion was never that of a mere theorist. On the other hand, he abhorred rule of thumb, striving always to master the scientific principles which underlie rational design and invention.

It is not necessary that I should review in detail the work of Siemens. The part which he took, during recent years, in the development of the dynamo machine must be known to many of you. We owe to him the practical adoption of the method, first suggested by Wheatstone, of throwing into a shunt the coils of the field-magnets, by which a greatly improved steadiness of action is obtained. The same characteristics are observable throughout—a definite object in view and a well-directed perseverance in overcoming the difficulties by which the path is usually obstructed.

These are indeed the conditions of successful invention. The world knows little of such things, and regards the new machine or the new method as the immediate outcome of a happy idea. Probably, if the truth were known, we should see that, in nine cases out of ten, success depends as much upon good judgment and perseverance as upon fertility of imagination. The labours of our great inventors are not unappreciated, but I doubt whether we adequately realise the enormous obligations under which we lie. It is no exaggeration to say that the life of such a man as Siemens is spent in the public service; the advantages which he reaps for himself being as nothing in comparison with those which he confers upon the community at large.

As an example of this it will be sufficient to mention one of the most valuable achievements of his active life—his introduction, in conjunction with his brother, of the regenerative gas furnace, by which an immense economy of fuel (estimated at millions of tons annually) has been effected in the manufacture of steel and glass. The nature of this economy is easily explained. Whatever may be the work to be done by the burning of fuel, a certain *temperature* is necessary. For example, no amount of heat in the form of boiling water would be of any avail for the fusion of steel. When the products of combustion are cooled down to the point in question, the heat which they still contain is useless as regards the purpose in view. The importance of this consideration depends entirely upon the working temperature. If the object be the evaporation of water or the warming of a house, almost all the heat may be extracted from the fuel without special arrangements. But it is otherwise when the temperature required is not much below that of combustion itself, for then the escaping gases carry away with them the larger part of the whole heat developed. It was to meet this difficulty that the regenerative furnace was devised. The products of combustion, before dismissal into the chimney, are caused to pass through piles of loosely stacked fire-brick, to which they give up their heat. After a time the fire-brick, upon which the gases first impinge, becomes nearly as hot as the furnace itself. By suitable valves the burnt gases are then diverted through another stack of brickwork, which they heat up in like manner, while the heat stored up in the first stack is utilised to warm the unburnt gas and air on their way to the furnace. In this way almost all the heat developed at a high temperature during the combustion is made available for the work in hand.

As it is now several years since your presidential chair has been occupied by a professed physicist, it may naturally be expected that I should attempt some record of recent progress in that branch of science, if indeed such a term be applicable. For it is one of the difficulties of the task that subjects as distinct as mechanics, electricity, heat, optics, and acoustics, to say nothing of astronomy and meteorology, are included under physics. Any one of these may well occupy the life-long attention of a man of science, and to be thoroughly conversant with all of them is more than can be expected of any one individual, and is probably incompatible with the devotion of much time and energy to the actual advancement of knowledge. Not that I

would complain of the association sanctioned by common parlance. A sound knowledge of at least the principles of general physics is necessary to the cultivation of any department. The predominance of the sense of sight as the medium of communication with the outer world, brings with it dependence upon the science of optics; and there is hardly a branch of science in which the effects of *temperature* have not (often without much success) to be reckoned with. Besides the neglected borderland between two branches of knowledge is often that which best repays cultivation, or, to use a metaphor of Maxwell's, the greatest benefits may be derived from a cross-fertilisation of the sciences. The wealth of material is an evil only from the point of view of one of whom too much may be expected. Another difficulty incident to the task, which must be faced, but cannot be overcome, is that of estimating rightly the value, and even the correctness, of recent work. It is not always that which seems at first the most important that proves in the end to be so. The history of science teems with examples of discoveries which attracted little notice at the time, but afterwards have taken root downwards and borne much fruit upwards.

One of the most striking advances of recent years is in the production and application of electricity upon a large scale—a subject to which I have already had occasion to allude in connection with the work of Sir W. Siemens. The dynamo machine is indeed founded upon discoveries of Faraday now more than half a century old; but it has required the protracted labours of many inventors to bring it to its present high degree of efficiency. Looking back at the matter, it seems strange that progress should have been so slow. I do not refer to details of design, the elaboration of which must always, I suppose, require the experience of actual work to indicate what parts are structurally weaker than they should be, or are exposed to undue wear and tear. But with regard to the main features of the problem it would almost seem as if the difficulty lay in want of faith. Long ago it was recognised that electricity derived from chemical action is (on a large scale) too expensive a source of mechanical power, notwithstanding the fact that (as proved by Joule in 1846) the conversion of electrical into mechanical work can be effected with great economy. From this it is an evident consequence that electricity may advantageously be obtained from mechanical power; and one cannot help thinking that if the fact had been borne steadily in mind, the development of the dynamo might have been much more rapid. But discoveries and inventions are apt to appear obvious when regarded from the standpoint of accomplished fact; and I draw attention to the matter only to point the moral that we do well to push the attack persistently when we can be sure beforehand that the obstacles to be overcome are only difficulties of contrivance, and that we are not vainly fighting unawares against a law of Nature.

The present development of electricity on a large scale depends, however, almost as much upon the incandescent lamp as upon the dynamo. The success of these lamps demands a very perfect vacuum—not more than about one-millionth of the normal quantity of air should remain—and it is interesting to recall that, twenty years ago, such vacua were rare even in the laboratory of the physicist. It is pretty safe to say that these wonderful results would never have been accomplished had practical applications alone been in view. The way was prepared by an army of scientific men whose main object was the advancement of knowledge, and who could scarcely have imagined that the processes which they elaborated would soon be in use on a commercial scale and intrusted to the hands of ordinary workmen.

When I speak in hopeful language of practical electricity, I do not forget the disappointment within the last year or two of many over-sanguine expectations. The enthusiasm of the inventor and promoter are necessary to progress, and it seems to be almost a law of nature that it should overpass the bounds marked out by reason and experience. What is most to be regretted is the advantage taken by speculators of the often un-instructed interest felt by the public in novel schemes by which its imagination is fired. But looking forward to the future of electric lighting, we have good ground for encouragement. Already the lighting of large passenger-ships is an assured success, and one which will be highly appreciated by those travellers who have experienced the tedium of long winter evenings unrelieved by adequate illumination. Here, no doubt, the conditions are in many respects especially favourable. As regards space, life on board ship is highly concentrated; while unity of

management and the presence on the spot of skilled engineers obviate some of the difficulties that are met with under other circumstances. At present we have no experience of a house-to-house system of illumination on a great scale and in competition with cheap gas; but preparations are already far advanced for trial on an adequate scale in London. In large institutions, such as theatres and factories, we all know that electricity is in successful and daily extending operation.

When the necessary power can be obtained from the fall of water, instead of from the combustion of coal, the conditions of the problem are far more favourable. Possibly the severity of your winters may prove an obstacle, but it is impossible to regard your splendid river without the thought arising that the day may come when the vast powers now running to waste shall be bent into your service. Such a project demands of course the most careful consideration, but it is one worthy of an intelligent and enterprising community.

The requirements of practice react in the most healthy manner upon scientific electricity. Just as in former days the science received a stimulus from the application to telegraphy, under which everything relating to measurement on a small scale acquired an importance and development for which we might otherwise have had long to wait, so now the requirements of electric lighting are giving rise to a new development of the art of measurement upon a large scale, which cannot fail to prove of scientific as well as practical importance. Mere change of scale may not at first appear a very important matter, but it is surprising how much modification it entails in the instruments, and in the processes of measurement. For instance, the resistance coils on which the electrician relies in dealing with currents whose maximum is a fraction of an ampere fail altogether when it becomes a question of hundreds, not to say thousands, of amperes.

The powerful currents, which are now at command, constitute almost a new weapon in the hands of the physicist. Effects which in old days were rare and difficult of observation may now be produced at will on the most conspicuous scale. Consider for a moment Faraday's great discovery of the "Magnetisation of Light," which Tyndall likens to the Weisshorn among mountains, as high, beautiful, and alone. This judgment (in which I fully concur) relates to the scientific aspect of the discovery, for to the eye of sense nothing could have been more insignificant. It is even possible that it might have eluded altogether the penetration of Faraday, had he not been provided with a special quality of very heavy glass. At the present day these effects may be produced upon a scale that would have delighted their discoverer, a rotation of the plane of polarisation through  $180^\circ$  being perfectly feasible. With the aid of modern appliances, Kundt and Röntgen in Germany, and H. Becquerel in France, have detected the rotation in gases and vapours, where, on account of its extreme smallness, it had previously escaped notice.

Again, the question of the magnetic saturation of iron has now an importance entirely beyond what it possessed at the time of Joule's early observations. Then it required special arrangements purposely contrived to bring it into prominence. Now in every dynamo machine, the iron of the field-magnets approaches a state of saturation, and the very elements of an explanation of the action require us to take the fact into account. It is indeed probable that a better knowledge of this subject might lead to improvements in the design of these machines.

Notwithstanding the important work of Rowland and Stolew, the whole theory of the behaviour of soft iron under varying magnetic conditions is still somewhat obscure. Much may be hoped from the induction balance of Hughes, by which the marvellous powers of the telephone are applied to the discrimination of the properties of metals, as regards magnetism and electric conductivity.

The introduction of powerful alternate-current in machines by Siemens, Gordon, Ferranti, and others, is likely also to have a salutary effect in educating those so-called practical electricians whose ideas do not easily rise above ohms and volts. It has long been known that when the changes are sufficiently rapid, the phenomena are governed much more by induction, or electric inertia, than by mere resistance. On this principle much may be explained that would otherwise seem paradoxical. To take a comparatively simple case, conceive an electro-magnet wound with two contiguous wires, upon which acts a given rapidly periodic electromotive force. If one wire only be used, a certain amount of heat is developed in the circuit. Suppose now that

the second wire is brought into operation in parallel—a proceeding equivalent to doubling the section of the original wire. An electrician accustomed only to constant currents would be sure to think that the heating effect would be doubled by the change, as much heat being developed in each wire separately as was at first in the single wire. But such a conclusion would be entirely erroneous. The total current, being governed practically by the self-induction of the circuit, would not be augmented by the accession of the second wire, and the total heating effect, so far from being doubled, would, in virtue of the superior conductivity, be halved.

During the last few years much interest has been felt in the reduction to an absolute standard of measurements of electromotive force, current, resistance, &c., and to this end many laborious investigations have been undertaken. The subject is one that has engaged a good deal of my own attention, and I should naturally have felt inclined to dilate upon it, but that I feel it to be too abstruse and special to be dealt with in detail upon an occasion like the present. As regards resistance, I will merely remind you that the recent determinations have shown a so greatly improved agreement that the Conference of Electricians assembled at Paris in May have felt themselves justified in defining the ohm for practical use as the resistance of a column of mercury of  $0^\circ\text{C}$ ., one square millimetre in section, and 106 cm. in length—a definition differing by a little more than 1 per cent. from that arrived at twenty years ago by a committee of this Association.

A standard of resistance once determined upon can be embodied in a "resistance coil," and copied without much trouble, and with great accuracy. But in order to complete the electrical system, a second standard of some kind is necessary, and this is not so easily embodied in a permanent form. It might conveniently consist of a standard galvanic cell, capable of being prepared in a definite manner, whose electromotive force is once for all determined. Unfortunately, most of the batteries in ordinary use are for one reason or another unsuitable for this purpose, but the cell introduced by Mr. Latimer Clark, in which the metals are zinc in contact with saturated zinc sulphate and pure mercury in contact with mercurous sulphate, appears to give satisfactory results. According to my measurements, the electromotive force of this cell is 1.435 theoretical volts.

We may also conveniently express the second absolute electrical measurement necessary to the completion of the system by taking advantage of Faraday's law that the quantity of metal decomposed in an electrolytic cell is proportional to the whole quantity of electricity that passes. The best metal for the purpose is silver, deposited from a solution of the nitrate or of the chlorate. The results recently obtained by Prof. Kohlrausch and by myself are in very good agreement, and the conclusion that one ampere flowing for one hour decomposes 4.025 grains of silver, can hardly be in error by more than a thousandth part. This number being known, the silver voltameter gives a ready and very accurate method of measuring currents of intensity varying from one-tenth of an ampere to four or five amperes.

The beautiful and mysterious phenomena attending the discharge of electricity in nearly vacuous spaces have been investigated and in some degree explained by De La Rue, Crookes, Schuster, Moulton, and the lamented Spottiswoode, as well as by various able foreign experimenters. In a recent research Crookes has sought the origin of a bright citron-coloured band in the phosphorescent spectrum of certain earths, and after encountering difficulties and anomalies of a most bewildering kind, has succeeded in proving that it is due to yttrium, an element much more widely distributed than had been supposed. A conclusion like this is stated in a few words, but those only who have undergone similar experience are likely to appreciate the skill and perseverance of which it is the final reward.

A remarkable observation by Hall of Baltimore, from which it appeared that the flow of electricity in a conducting sheet was disturbed by magnetic force, has been the subject of much discussion. Mr. Shelford Bidwell has brought forward experiments tending to prove that the effect is of a secondary character, due in the first instance to the mechanical force operating upon the conductor of an electric current when situated in a powerful magnetic field. Mr. Bidwell's view agrees in the main with Mr. Hall's division of the metals into two groups according to the direction of the effect.

Without doubt the most important achievement of the older generation of scientific men has been the establishment and

application of the great laws of thermo-dynamics, or, as it is often called, the mechanical theory of heat. The first law, which asserts that heat and mechanical work can be transformed one into the other at a certain fixed rate, is now well understood by every student of physics, and the number expressing the mechanical equivalent of heat resulting from the experiments of Joule has been confirmed by the researches of others, and especially of Rowland. But the second law, which practically is even more important than the first, is only now beginning to receive the full appreciation due to it. One reason of this may be found in a not unnatural confusion of ideas. Words do not always lend themselves readily to the demands that are made upon them by a growing science, and I think that the almost unavoidable use of the word equivalent in the statement of the first law is partly responsible for the little attention that is given to the second. For the second law so far contradicts the usual statement of the first, as to assert that equivalents of heat and work are not of equal value. While work can always be converted into heat, heat can only be converted into work under certain limitations. For every practical purpose the work is worth the most, and when we speak of equivalents, we use the word in the same sort of special sense as that in which chemists speak of equivalents of gold and iron. The second law teaches us that the real value of heat, as a source of mechanical power, depends upon the temperature of the body in which it resides: the hotter the body in relation to its surroundings, the more available the heat.

In order to see the relations which obtain between the first and the second law of thermo-dynamics, it is only necessary for us to glance at the theory of the steam-engine. Not many years ago calculations were plentiful demonstrating the inefficiency of the steam-engine on the basis of a comparison of the work actually got out of the engine with the mechanical equivalent of the heat supplied to the boiler. Such calculations took into account only the first law of thermo-dynamics, which deals with the equivalents of heat and work, and have very little bearing upon the practical question of efficiency, which requires us to have regard also to the second law. According to that law the fraction of the total energy which can be converted into work depends upon the relative temperatures of the boiler and condenser; and it is, therefore, manifest that, as the temperature of the boiler cannot be raised indefinitely, it is impossible to utilise all the energy which, according to the first law of thermo-dynamics, is resident in the coal.

On a sounder view of the matter, the efficiency of the steam-engine is found to be so high that there is no great margin remaining for improvement. The higher initial temperature possible in the gas-engine opens out much wider possibilities, and many good judges look forward to a time when the steam-engine will have to give way to its younger rival.

To return to the theoretical question, we may say with Sir W. Thomson that, though energy cannot be destroyed, it ever tends to be dissipated, or to pass from more available to less available forms. No one who has grasped this principle can fail to recognise its immense importance in the system of the universe. Every change, chemical, thermal, or mechanical—which takes place, or can take place, in Nature, does so, at the cost of a certain amount of available energy. If, therefore, we wish to inquire whether or not a proposed transformation can take place, the question to be considered is whether its occurrence would involve dissipation of energy. If not, the transformation is (under the circumstances of the case) absolutely excluded. Some years ago, in a lecture at the Royal Institution, I endeavoured to draw the attention of chemists to the importance of the principle of dissipation in relation to their science, pointing out the error of the usual assumption that a general criterion is to be found in respect of the development of heat. For example, the solution of a salt in water is, if I may be allowed the phrase, a downhill transformation. It involves dissipation of energy, and can therefore go forward; but in many cases it is associated with the absorption rather than with the development of heat. I am glad to take advantage of the present opportunity in order to repeat my recommendation, with an emphasis justified by actual achievement. The foundations laid by Thomson now bear an edifice of no mean proportions, thanks to the labours of several physicists, among whom must be especially mentioned Willard, Gibbs, and Helmholtz. The former has elaborated a theory of the equilibrium of heterogeneous substances, wide in its principles, and we cannot doubt far-reaching in its consequences. In a series of masterly papers Helmholtz has developed the concep-

tion of *free energy* with very important applications to the theory of the galvanic cell. He points out that the mere tendency to solution bears in some cases no small proportion to the affinities more usually reckoned chemical, and contributes largely to the total electromotive force. Also in our own country Dr. Alder Wright has published some valuable experiments relating to the subject.

From the further study of electrolysis we may expect to gain improved views as to the nature of the chemical reactions, and of the forces concerned in bringing them about. I am not qualified—I wish I were—to speak to you on recent progress in general chemistry. Perhaps my feelings towards a first love may blind me, but I cannot help thinking that the next great advance, of which we have already some foreshadowing, will come on this side. And if I might without presumption venture a word of recommendation, it would be in favour of a more minute study of the simpler chemical phenomena.

Under the head of scientific mechanics it is principally in relation to fluid motion that advances may be looked for. In speaking upon this subject I must limit myself almost entirely to experimental work. Theoretical hydrodynamics, however important and interesting to the mathematician, are eminently unsuited to oral exposition. All I can do to attenuate an injustice, to which theorists are pretty well accustomed, is to refer you to the admirable reports of Mr. Hicks, published under the auspices of this Association.

The important and highly practical work of the late Mr. Froude in relation to the propulsion of ships is doubtless known to most of you. Recognising the fallacy of views then widely held as to the nature of the resistance to be overcome, he showed to demonstration that, in the case of fair-shaped bodies, we have to deal almost entirely with resistance dependent upon skin friction, and at high speeds upon the generation of surface-waves by which energy is carried off. At speeds which are moderate in relation to the size of the ship, the resistance is practically dependent upon skin friction only. Although Prof. Stokes and other mathematicians had previously published calculations pointing to the same conclusion, there can be no doubt that the view generally entertained was very different. At the first meeting of the Association which I ever attended, as an intelligent listener, at Bath in 1864, I well remember the surprise which greeted a statement by Rankine that he regarded skin friction as the only legitimate resistance to the progress of a well-designed ship. Mr. Froude's experiments have set the question at rest in a manner satisfactory to those who had little confidence in theoretical prevision.

In speaking of an explanation as satisfactory in which skin friction is accepted as the cause of resistance, I must guard myself against being supposed to mean that the nature of skin friction is itself well understood. Although its magnitude varies with the smoothness of the surface, we have no reason to think that it would disappear at any degree of smoothness consistent with an ultimate molecular structure. That it is connected with fluid viscosity is evident enough, but the *modus operandi* is still obscure.

Some important work bearing upon the subject has recently been published by Prof. O. Reynolds, who has investigated the flow of water in tubes as dependent upon the velocity of motion and upon the size of the bore. The laws of motion in capillary tubes, discovered experimentally by Poiseuille, are in complete harmony with theory. The resistance varies as the velocity, and depends in a direct manner upon the constant of viscosity. But when we come to the larger pipes and higher velocities with which engineers usually have to deal, the theory which presupposes a regularly stratified motion evidently ceases to be applicable, and the problem becomes essentially identical with that of skin friction in relation to ship propulsion. Prof. Reynolds has traced with much success the passage from the one state of things to the other, and has proved the applicability under these complicated conditions of the general laws of dynamical similarity as adapted to viscous fluids by Prof. Stokes. In spite of the difficulties which beset both the theoretical and experimental treatment, we may hope to attain before long to a better understanding of a subject which is certainly second to none in scientific as well as practical interest.

As also closely connected with the mechanics of viscous fluids, I must not forget to mention an important series of experiments upon the friction of oiled surfaces, recently executed by Mr. Tower for the Institution of Mechanical Engineers. The results

go far towards upsetting some ideas hitherto widely admitted. When the lubrication is adequate, the friction is found to be nearly independent of the load, and much smaller than is usually supposed, giving a coefficient as low as  $1/1000$ . When the layer of oil is well formed, the pressure between the solid surfaces is really borne by the fluid, and the work lost is spent in shearing, that is, in causing one stratum of the oil to glide over another.

In order to maintain its position, the fluid must possess a certain degree of viscosity, proportionate to the pressure; and even when this condition is satisfied, it would appear to be necessary that the layer should be thicker on the ingoing than on the outgoing side. We may, I believe, expect from Prof. Stokes a further elucidation of the processes involved. In the meantime, it is obvious that the results already obtained are of the utmost value, and fully justify the action of the Institution in devoting a part of its resources to experimental work. We may hope indeed that the example thus wisely set may be followed by other public bodies associated with various departments of industry.

I can do little more than refer to the interesting observations of Prof. Darwin, Mr. Hunt, and M. Forel on ripplemark. The processes concerned would seem to be of a rather intricate character, and largely dependent upon fluid viscosity. It may be noted indeed that most of the still obscure phenomena of hydrodynamics require for their elucidation a better comprehension of the laws of viscous motion. The subject is one which offers peculiar difficulties. In some problems in which I have lately been interested, a circulating motion presents itself of the kind which the mathematician excludes from the first when he is treating of fluids destitute altogether of viscosity. The intensity of this motion proves, however, to be independent of the coefficient of viscosity, so that it cannot be correctly dismissed from consideration as a consequence of a supposition that the viscosity is infinitely small. The apparent breach of continuity can be explained, but it shows how much care is needful in dealing with the subject, and how easy it is to fall into error.

The nature of gaseous viscosity, as due to the diffusion of momentum, has been made clear by the theoretical and experimental researches of Maxwell. A flat disk moving in its own plane between two parallel solid surfaces is impeded by the necessity of shearing the intervening layers of gas, and the magnitude of the hindrance is proportional to the velocity of the motion and to the viscosity of the gas, so that under similar circumstances this effect may be taken as a measure, or rather definition, of the viscosity. From the dynamical theory of gases, to the development of which he contributed so much, Maxwell drew the startling conclusion that the viscosity of a gas should be independent of its density,—that within wide limits the resistance to the moving disk should be scarcely diminished by pumping out the gas, so as to form a partial vacuum. Experiment fully confirmed this theoretical anticipation—one of the most remarkable to be found in the whole history of science, and proved that the swinging disk was retarded by the gas, as much when the barometer stood at half an inch as when it stood at thirty inches. It was obvious, of course, that the law must have a limit, that at a certain point of exhaustion the gas must begin to lose its power; and I remember discussing with Maxwell, soon after the publication of his experiments, the whereabouts of the point at which the gas would cease to produce its ordinary effect. His apparatus, however, was quite unsuited for high degrees of exhaustion, and the failure of the law was first observed by Kundt and Warburg, at pressures below 1 mm. of mercury. Subsequently the matter has been thoroughly examined by Crookes, who extended his observations to the highest degrees of exhaustion as measured by MacLeod's gauge. Perhaps the most remarkable results relate to hydrogen. From the atmospheric pressure of 760 mm. down to about  $\frac{1}{4}$  mm. of mercury the viscosity is sensibly constant. From this point to the highest vacua, in which less than one-millionth of the original gas remains, the coefficient of viscosity drops down gradually to a small fraction of its original value. In these vacua Mr. Crookes regards the gas as having assumed a different, ultra-gaseous condition; but we must remember that the phenomena have relation to the other circumstances of the case, especially the dimensions of the vessel, as well as to the condition of the gas.

Such an achievement as the prediction of Maxwell's law of viscosity has of course drawn increased attention to the dynamical theory of gases. The success which has attended the theory in the hands of Clausius, Maxwell, Boltzmann, and other mathematicians, not only in relation to viscosity, but over a large part

of the entire field of our knowledge of gases, proves that some of its fundamental postulates are in harmony with the reality of Nature. At the same time it presents serious difficulties; and we cannot but feel that, while the electrical and optical properties of gases remain out of relation to the theory, no final judgment is possible. The growth of experimental knowledge may be trusted to clear up many doubtful points, and a younger generation of theorists will bring to bear improved mathematical weapons. In the meantime we may fairly congratulate ourselves on the possession of a guide which has already conducted us to a position which could hardly otherwise have been attained.

In optics attention has naturally centred upon the spectrum. The mystery attaching to the invisible rays lying beyond the red has been fathomed to an extent that, a few years ago, would have seemed almost impossible. By the use of special photographic methods Abney has mapped out the peculiarities of this region with such success that our knowledge of it begins to be comparable with that of the parts visible to the eye. Equally important work has been done by Langley, using a refined invention of his own based upon the principle of Siemens' pyrometer. This instrument measures the actual energy of the radiation, and thus expresses the effects of various parts of the spectrum upon a common scale, independent of the properties of the eye and of sensitive photographic preparations. Interesting results have also been obtained by Becquerel, whose method is founded upon a curious action of the ultra-red rays in enfeebling the light emitted by phosphorescent substances. One of the most startling of Langley's conclusions relates to the influence of the atmosphere in modifying the quality of solar light. By the comparison of observations made through varying thicknesses of air he shows that the atmospheric absorption tells most upon the light of high refrangibility; so that to an eye situated outside the atmosphere the sun would present a decidedly bluish tint. It would be interesting to compare the experimental numbers with the law of scattering of light by small particles given some years ago as the result of theory. The demonstration by Langley of the inadequacy of Cauchy's law of dispersion to represent the relation between refrangibility and wave-length in the lower part of the spectrum must have an important bearing upon optical theory.

The investigation of the relation of the visible and ultra-violet spectrum to various forms of matter has occupied the attention of a host of able workers, among whom none have been more successful than my colleagues at Cambridge, Profs. Liveing and Dewar. The subject is too large both for the occasion and for the individual, and I must pass it by. But, as more closely related to optics proper, I cannot resist recalling to your notice a beautiful application of the idea of Doppler to the discrimination of the origin of certain lines observed in the solar spectrum. If a vibrating body have a general motion of approach or recession, the waves emitted from it reach the observer with a frequency which in the first case exceeds, and in the second case falls short of, the real frequency of the vibrations themselves. The consequence is that, if a glowing gas be in motion in the line of sight, the spectral lines are thereby displaced from the position that they would occupy were the gas at rest—a principle which, in the hands of Huggins and others, has led to a determination of the motion of certain fixed stars relatively to the solar system. But the sun is itself in rotation, and thus the position of a solar spectral line is slightly different according as the light comes from the advancing or from the retreating limb. This displacement was, I believe, first observed by Thollon; but what I desire now to draw attention to is the application of it by Cornu to determine whether a line is of solar or atmospheric origin. For this purpose a small image of the sun is thrown upon the slit of the spectroscope, and caused to vibrate two or three times a second, in such a manner that the light entering the instrument comes alternately from the advancing and retreating limbs. Under these circumstances a line due to absorption within the sun appears to tremble, as the result of slight alternately opposite displacements. But if the seat of the absorption be in the atmosphere it is a matter of indifference from what part of the sun the light originally proceeds, and the line maintains its position in spite of the oscillation of the image upon the slit of the spectroscope. In this way Cornu was able to make a discrimination which can only otherwise be effected by a difficult comparison of appearances under various solar altitudes. —

The instrumental weapon of investigation, the spectroscope itself, has made important advances. On the theoretical side, we have for our guidance the law that the optical power in gratings is proportional to the total number of lines accurately ruled, without regard to the degree of closeness, and in prisms that it is proportional to the thickness of glass traversed. The magnificent gratings of Rowland are a new power in the hands of the spectroscopist, and as triumphs of mechanical art seem to be little short of perfection. In our own report for 1882 Mr. Mallock has described a machine, constructed by him, for ruling large diffraction gratings, similar in some respects to that of Rowland.

The great optical constant, the velocity of light, has been the subject of three distinct investigations by Cornu, Michelson, and Forbes. As may be supposed, the matter is of no ordinary difficulty, and it is therefore not surprising that the agreement should be less decided than could be wished. From their observations, which were made by a modification of Fizeau's method of the toothed wheel, Young and Forbes drew the conclusion that the velocity of light *in vacuo* varies from colour to colour, to such an extent that the velocity of blue light is nearly 2 per cent. greater than that of red light. Such a variation is quite opposed to existing theoretical notions, and could only be accepted on the strongest evidence. Mr. Michelson, whose method (that of Foucault) is well suited to bring into prominence a variation of velocity with wave-length, informs me that he has recently repeated his experiments with special reference to the point in question, and has arrived at the conclusion that no variation exists comparable with that asserted by Young and Forbes. The actual velocity differs little from that found from his first series of experiments, and may be taken to be 299,800 km. per second.

It is remarkable how many of the playthings of our childhood give rise to questions of the deepest scientific interest. The top, or may be, understood, but a complete comprehension of the kite and of the soap-bubble would carry us far beyond our present stage of knowledge. In spite of the admirable investigations of Plateau, it still remains a mystery why soapy water stands almost alone among fluids as a material for bubbles. The beautiful development of colour was long ago ascribed to the interference of light, called into play by the gradual thinning of the film. In accordance with this view the tint is determined solely by the thickness of the film, and the refractive index of the fluid. Some of the phenomena are, however, so curious as to have led excellent observers like Brewster to reject the theory of thin plates, and to assume the secretion of various kinds of colouring matter. If the rim of a wine-glass be dipped in soapy water, and then held in a vertical position, horizontal bands soon begin to show at the top of the film, and extend themselves gradually downwards. According to Brewster these bands are not formed by the "subsidence and gradual thinning of the film," because they maintain their horizontal position when the glass is turned round its axis. The experiment is both easy and interesting; but the conclusion drawn from it, cannot be accepted. The fact is that the various parts of the film cannot quickly alter their thickness, and hence when the glass is rotated they rearrange themselves in order of superficial density, the thinner parts floating up over, or through, the thicker parts. Only thus can the tendency be satisfied for the centre of gravity to assume the lowest possible position.

When the thickness of a film falls below a small fraction of the length of a wave of light, the colour disappears and is replaced by an intense blackness. Profs. Reinold and Rucker have recently made the remarkable observation that the whole of the black region, soon after its formation, is of uniform thickness, the passage from the black to the coloured portions being exceedingly abrupt. By two independent methods they have determined the thickness of the black film to lie between seven and fourteen millionths of a millimetre; so that the thinnest films correspond to about one-seventieth of a wave-length of light. The importance of these results in regard to molecular theory is too obvious to be insisted upon.

The beautiful inventions of the telephone and the phonograph, although in the main dependent upon principles long since established, have imparted a new interest to the study of acoustics. The former, apart from its uses in every-day life, has become in the hands of its inventor, Graham Bell, and of Hughes, an instrument of first-class scientific importance. The theory of its action is still in some respects obscure, as is shown

by the comparative failure of the many attempts to improve it. In connection with some explanations that have been offered, we do well to remember that molecular changes in solid masses are inaudible in themselves, and can only be manifested to our ears by the generation of a to-and-fro motion of the external surface extending over a sensible area. If the surface of a solid remains undisturbed, our ears can tell us nothing of what goes on in the interior.

In theoretical acoustics progress has been steadily maintained, and many phenomena which were obscure twenty or thirty years ago, have since received adequate explanation. If some important practical questions remain unsolved, one reason is that they have not yet been definitely stated. Almost everything in connection with the ordinary use of our senses presents peculiar difficulties to scientific investigation. Some kinds of information with regard to their surroundings are of such paramount importance to successive generations of living beings, that they have learned to interpret indications which, from a physical point of view, are of the slenderest character. Every day we are in the habit of recognising, without much difficulty, the quarter from which a sound proceeds, but by what steps we attain that end has not yet been satisfactorily explained. It has been proved that when proper precautions are taken we are unable to distinguish whether a pure tone (as from a vibrating tuning-fork held over a suitable resonator) comes to us from in front or from behind. This is what might have been expected from an *a priori* point of view; but what would not have been expected is that with almost any other sort of sound, from a clap of the hands to the clearest vowel sound, the discrimination is not only possible, but easy and instinctive. In these cases it does not appear how the possession of two ears helps us, though there is some evidence that it does; and even when sounds come to us from the right or left, the explanation of the ready discrimination which is then possible with pure tones is not so easy as might at first appear. We should be inclined to think that the sound was heard much more loudly with the ear that is turned towards than with the ear that is turned from it, and that in this way the direction was recognised. But if we try the experiment we find that, at any rate with notes near the middle of the musical scale, the difference of loudness is by no means so very great. The wave lengths of such notes are long enough in relation to the dimensions of the head to forbid the formation of anything like a sound shadow in which the averted ear might be sheltered.

In concluding this imperfect survey of recent progress in physics, I must warn you emphatically that much of great importance has been passed over altogether. I should have liked to speak to you of those far-reaching speculations, especially associated with the name of Maxwell, in which light is regarded as a disturbance in an electro-magnetic medium. Indeed, at one time I had thought of taking the scientific work of Maxwell as the principal theme of this address. But, like most men of genius, Maxwell delighted in questions too obscure and difficult for hasty treatment, and thus much of his work could hardly be considered upon such an occasion as the present. His biography has recently been published, and should be read by all who are interested in science and in scientific men. His many-sided character, the quaintness of his humour, the penetration of his intellect, his simple but deep religious feeling, the affection between son and father, the devotion of husband to wife, all combine to form a rare and fascinating picture. To estimate rightly his influence upon the present state of science, we must regard not only the work that he executed himself, important as that was, but also the ideas and the spirit which he communicated to others. Speaking for myself as one who in a special sense entered into his labours, I should find it difficult to express adequately my feeling of obligation. The impress of his thoughts may be recognised in much of the best work of the present time. As a teacher and examiner he was well acquainted with the almost universal tendency of uninstructed minds to elevate phrases above things; to refer, for example, to the principle of the conservation of energy for an explanation of the persistent rotation of a fly-wheel, almost in the style of the doctor in "Le Malade Imaginaire," who explains the fact that opium sends you to sleep by its soporific virtue. Maxwell's endeavour was always to keep the facts in the foreground, and to his influence, in conjunction with that of Thomson and Helmholtz, is largely due that elimination of unnecessary hypothesis which is one of the distinguishing characteristics of the science of the present day.



In speaking unfavourably of superfluous hypothesis let me not be misunderstood. Science is nothing without generalisations. Detached and ill-assorted facts are only raw material, and in the absence of a theoretical solvent have but little nutritive value. At the present time and in some departments the accumulation of material is so rapid that there is danger of indigestion. By a fiction as remarkable as any to be found in law, what has once been published, even though it be in the Russian language, is usually spoken of as "known," and it is often forgotten that the rediscovery in the library may be a more difficult and uncertain process than the first discovery in the laboratory. In this matter we are greatly dependent upon annual reports and abstracts, issued principally in Germany, without which the search for the discoveries of a little-known author would be well-nigh hopeless. Much useful work has been done in this direction in connection with our Association. Such critical reports as those upon hydrodynamics, upon tides, and upon spectroscopy, guide the investigator to the points most requiring attention, and in discussing past achievements contribute in no small degree to future progress. But, though good work has been done, much yet remains to do.

If, as is sometimes supposed, science consisted in nothing but the laborious accumulation of facts, it would soon come to a standstill, crushed, as it were, under its own weight. The suggestion of a new idea, or the detection of a law, supersedes much that had previously been a burden upon the memory, and by introducing order and coherence facilitates the retention of the remainder in an available form. Those who are acquainted with the writings of the older electricians will understand my meaning when I instance the discovery of Ohm's law as a step by which the science was rendered easier to understand and to remember. Two processes are thus at work side by side, the reception of new material and the digestion and assimilation of the old; and as both are essential, we may spare ourselves the discussion of their relative importance. One remark, however, should be made. The work which deserves, but I am afraid does not always receive, the most credit, is that in which discovery and explanation go hand in hand, in which not only are new facts presented, but their relation to old ones is pointed out.

In making one's self acquainted with what has been done in any subject, it is good policy to consult first the writers of highest general reputation. Although in scientific matters we should aim at independent judgment, and not rely too much upon authority, it remains true that a good deal must often be taken upon trust. Occasionally an observation is so simple and easily repeated, that it scarcely matters from whom it proceeds; but as a rule it can hardly carry full weight when put forward by a novice whose care and judgment there has been no opportunity of testing, and whose irresponsibility may tempt him to "take shots," as it is called. Those who have had experience in accurate work know how easy it would be to save time and trouble by omitting precautions and passing over discrepancies, and yet, even without dishonest intention, to convey the impression of conscientious attention to details. Although the most careful and experienced cannot hope to escape occasional mistakes, the effective value of this kind of work depends much upon the reputation of the individual responsible for it.

In estimating the present position and prospects of experimental science, there is good ground for encouragement. The multiplication of laboratories gives to the younger generation opportunities such as have never existed before, and which excite the envy of those who have had to learn in middle life much that now forms part of an undergraduate course. As to the management of such institutions, there is room for a healthy difference of opinion. For many kinds of original work, especially in connection with accurate measurement, there is need of expensive apparatus; and it is often difficult to persuade a student to do his best with imperfect appliances when he knows that by other means a better result could be attained with greater facility. Nevertheless it seems to me important to discourage too great reliance upon the instrument-maker. Much of the best original work has been done with the homeliest appliances; and the endeavour to turn to the best account the means that may be at hand develops ingenuity and resource more than the most elaborate determinations with ready-made instruments. There is danger otherwise that the experimental education of a plodding student should be too mechanical and artificial, so that he is puzzled by small changes of apparatus much as many school-boys are puzzled by a transposition of the letters in a diagram of Euclid.

From the general spread of a more scientific education we are warranted in expecting important results. Just as there are some brilliant literary men with an inability, or at least a distaste practically amounting to inability, for scientific ideas, so there are a few with scientific tastes whose imaginations are never touched by merely literary studies. To save these from intellectual stagnation during several important years of their lives is something gained; but the thoroughgoing advocates of scientific education aim at much more. To them it appears strange, and almost monstrous, that the dead languages should hold the place they do in general education; and it can hardly be denied that their supremacy is the result of routine rather than of argument. I do not myself take up the extreme position. I doubt whether an exclusively scientific training would be satisfactory; and where there is plenty of time and a literary aptitude I can believe that Latin and Greek may make a good foundation. But it is useless to discuss the question upon the supposition that the majority of boys attain either to a knowledge of the languages or to an appreciation of the writings of the ancient authors. The contrary is notoriously the truth; and the defenders of the existing system usually take their stand upon the excellence of its discipline. From this point of view there is something to be said. The laziest boy must exert himself a little in puzzling out a sentence with grammar and dictionary, while instruction and supervision are easy to organise and not too costly. But when the case is stated plainly, few will agree that we can afford so entirely to disregard results. In after life the intellectual energies are usually engrossed with business, and no further opportunity is found for attacking the difficulties which block the gateways of knowledge. Mathematics, especially, if not learned young, are likely to remain unlearned. I will not further insist upon the educational importance of mathematics and science, because with respect to them I shall probably be supposed to be prejudiced. But of modern languages I am ignorant enough to give value to my advocacy. I believe that French and German, if properly taught, which I admit they rarely are at present, would go far to replace Latin and Greek from a disciplinary point of view, while the actual value of the acquisition would, in the majority of cases, be incomparably greater. In half the time usually devoted without success to the classical languages, most boys could acquire a really serviceable knowledge of French and German. History and the serious study of English literature, now shamefully neglected, would also find a place in such a scheme.

There is one objection often felt to a modernised education, as to which a word may not be without use. Many excellent people are afraid of science as tending towards materialism. That such apprehension should exist is not surprising, for unfortunately there are writers, speaking in the name of science, who have set themselves to foster it. It is true that among scientific men, as in other classes, crude views are to be met with as to the deeper things of Nature; but that the life-long beliefs of Newton, of Faraday, and of Maxwell are inconsistent with the scientific habit of mind is surely a proposition which I need not pause to refute. It would be easy, however, to lay too much stress upon the opinions of even such distinguished workers as these. Men who devote their lives to investigation cultivate a love of truth for its own sake, and endeavour instinctively to clear up, and not, as is too often the object in business and politics, to obscure, a difficult question. So far the opinion of a scientific worker may have a special value; but I do not think that he has a claim, superior to that of other educated men, to assume the attitude of a prophet. In his heart he knows that underneath the theories that he constructs there lie contradictions which he cannot reconcile. The higher mysteries of being, if penetrable at all by human intellect, require other weapons than those of calculation and experiment.

Without encroaching upon grounds appertaining to the theologian and the philosopher, the domain of natural science is surely broad enough to satisfy the wildest ambition of its devotees. In other departments of human life and interest, true progress is rather an article of faith than a rational belief; but in science a retrograde movement is, from the nature of the case, almost impossible. Increasing knowledge brings with it increasing power, and great as are the triumphs of the present century, we may well believe that they are but a foretaste of what discovery and invention have yet in store for mankind. Encouraged by the thought that our labours cannot be thrown away, let us double our efforts in the noble struggle. In the

Old World and in the New, recruits must be enlisted to fill the place of those whose work is done. Happy should I be if, through this visit of the Association, or by any words of mine, a larger measure of the youthful activity of the West could be drawn into this service. The work may be hard, and the discipline severe, but the interest never fails, and great is the privilege of achievement.

## SECTION A

## MATHEMATICAL AND PHYSICAL SCIENCE

OPENING ADDRESS BY PROF. SIR WILLIAM THOMSON, M.A., LL.D., D.C.L., F.R.S.S.L. & E., F.R.A.S., PRESIDENT OF THE SECTION

*Steps towards a Kinetic Theory of Matter*

THE now well-known kinetic theory of gases is a step so important in the way of explaining seemingly static properties of matter by motion, that it is scarcely possible to help anticipating in idea the arrival at a complete theory of matter, in which all its properties will be seen to be merely attributes of motion. If we are to look for the origin of this idea, we must go back to Democritus, Epicurus, and Lucretius. We may then, I believe, without missing a single step, skip 1800 years. Early last century we find in Malebranche's "Recherche de la Vérité," the statement that "La dureté de corps" depends on "petits tourbillons."<sup>1</sup> These words, embedded in a hopeless mass of unintelligible statements of the physical, metaphysical, and theological philosophies of the day, and unsupported by any explanation, elucidation, or illustration throughout the rest of the three volumes, and only marred by any other single sentence or word to be found in the great book, still do express a distinct conception, which forms a most remarkable step towards the kinetic theory of matter. A little later we have Daniel Bernoulli's promulgation of what we now accept as a surest article of scientific faith—the kinetic theory of gases. He, so far as I know, thought only of the Boyle's and Marriot's law of the "spring of air," as Boyle called it, without reference to change of temperature or the augmentation of its pressure if not allowed to expand for elevation of temperature, a phenomenon which perhaps he scarcely knew, still less the elevation of temperature produced by compression, and the lowering of temperature by dilatation, and the consequent necessity of waiting for a fraction of a second or a few seconds of time (with apparatus of ordinary experimental magnitude), to see a subsidence from a larger change of pressure, down to the amount of change that verifies Boyle's law. The consideration of these phenomena forty years ago by Joule, in connection with Bernoulli's original conception, formed the foundation of the kinetic theory of gases as we now have it. But what a splendid and useful building has been placed on this foundation by Clausius and Maxwell, and what a beautiful ornament we see on the top of it in the radiometer of Crookes, securely attached to it by the happy discovery of Tait and Dewar,<sup>2</sup> that the length of the free path of the residual molecules of air in a good modern vacuum may amount to several inches. Clausius' and Maxwell's explanations of the diffusion of gases, and of thermal conduction in gases, their charmingly intelligible conclusion that in gases the diffusion of heat is just a little more rapid than the diffusion of molecules, because of the interchange of energy in collisions between molecules,<sup>3</sup> while the chief transference of heat is by actual transport

<sup>1</sup> "Preuve de la supposition que j'ay faite : Que la matière subtile ou étherée est nécessairement composée de PETITS TOURBILLONS ; et qu'ils sont les causes naturelles de tous les changements qui arrivent à la matière ; ce que je confirme par l'explication des effets le plus généraux de la Physique, tels que sont la dureté des corps, leur fluidité, leur pesanteur, leur légèreté, la lumière et la réfraction et réflexion de ses rayons."—Malebranche, "Recherche de la Vérité," 272.

<sup>2</sup> Proc. R. S. E., March 2, 1874, and July 5, 1875.

<sup>3</sup> On the other hand, in liquids, on account of the crowdedness of the molecules, the diffusion of heat must be chiefly by interchange of energies between the molecules, and should be, as experiment proves it is, enormously more rapid than the diffusion of the molecules themselves, and this again ought to be much less rapid than either the material or thermal diffusivities of gases. Thus the diffusivity of common salt through water was found by Fick to be as small as '00025 square centimetres per second; nearly 200 times as great as this is the diffusivity of heat through water, which was found by J. T. Bottomley to be about '008 square centimetres per second. The material diffusivities of gases, according to Loschmidt's experiments, range from '008 (the interdiffusivity of carbonic acid and nitrous oxide) to '642 (the interdiffusivity of carbonic oxide and hydrogen), while the thermal diffusivities of gases, calculated according to Clausius' and Maxwell's kinetic theory of gases, are '089 for carbonic acid, '16 for common air or other gases of nearly the same density, and '112 for hydrogen (all, both material and thermal, being reckoned in square centimetres per second).

of the molecules themselves, and Maxwell's explanation of the viscosity of gases, with the absolute numerical relations which the work of those two great discoverers found among the three properties of diffusion, thermal conduction, and viscosity, have annexed to the domain of science a vast and ever-growing province.

Rich as it is in practical results, the kinetic theory of gases, as hitherto developed, stops absolutely short at the atom or molecule, and gives not even a suggestion towards explaining the properties in virtue of which the atoms or molecules mutually influence one another. For some guidance towards a deeper and more comprehensive theory of matter, we may look back with advantage to the end of last century, and the beginning of this century, and find Rumford's conclusion regarding the heat generated in boring a brass gun: "It appears to me to be extremely difficult, if not quite impossible, to form any distinct idea of anything capable of being excited and communicated in the manner the heat was excited and communicated in these experiments, except it be MOTION," and Davy's still more suggestive statements: "The phenomena of repulsion are not dependent on a peculiar elastic fluid for their existence. . . ." "Heat may be defined as a peculiar motion, probably a vibration, of the corpuscles of bodies, tending to separate them. . . ." "To distinguish this motion from others, and to signify the causes of our sensations of heat, &c., the name *repulsive* motion has been adopted." Here we have a most important idea. It would be somewhat a bold figure of speech to say the earth and moon are kept apart by a repulsive motion; and yet, after all, what is centrifugal force but a repulsive motion, and may it not be that there is no such thing as repulsion, and that it is solely by inertia that what seems to be repulsion is produced? Two bodies fly together, and, accelerated by mutual attraction, if they do not precisely hit one another, they cannot but separate in virtue of the inertia of their masses. So, after dashing past one another in sharply concave curves round their common centre of gravity, they fly asunder again. A careless onlooker might imagine they had repelled one another, and might not notice the difference between what he actually sees and what he would see if the two bodies had been projected with great velocity towards one another, and either colliding and rebounding, or repelling one another into sharply convex continuous curves, fly asunder again.

Joule, Clausius, and Maxwell, and no doubt Daniel Bernoulli himself, and I believe every one who has hitherto written or done anything very explicit in the kinetic theory of gases, has taken the mutual action of molecules in collision as repulsive. May it not after all be attractive? This idea has never left my mind since I first read Davy's "Repulsive Motion," about thirty-five years ago, but I never made anything of it, at all events have not done so until to-day (June 16, 1884)—if this can be said to be making anything of it—when, in endeavouring to prepare the present address, I notice that Joule's and my own old experiments<sup>1</sup> on the thermal effect of gases expanding from a high-pressure vessel through a porous plug, proves the less dense gas to have greater intrinsic potential energy than the denser gas, if we assume the ordinary hypothesis regarding the temperature of a gas, according to which two gases are of equal temperatures<sup>2</sup> when the kinetic energies of their constituent molecules are of equal average amounts per molecule.

Think of the thing thus. Imagine a great multitude of particles inclosed by a boundary which may be pushed inwards in any part all round at pleasure. Now station an engineer corps of Maxwell's army of sorting demons all round the inclosure, with orders to push in the boundary diligently everywhere, when none of the besieged troops are near, and to do nothing when any of them are seen approaching, and until after they have turned again inwards. The result will be that, with exactly the same sum of kinetic and potential energies of the same inclosed multitude of particles, the throng has been caused to be denser. Now Joule's and my own old experiments on the efflux of air prove that if the crowd be common air, or

<sup>1</sup> Republished in Sir W. Thomson's "Mathematical and Physical Papers," vol. i. Article xlix. p. 381.

<sup>2</sup> That this is a mere hypothesis has been scarcely remarked by the founders themselves, nor by almost any writer on the kinetic theory of gases. No one has yet examined the question: What is the condition as to the average distribution of kinetic energy, which is ultimately fulfilled by

interchange of kinetic energy by collisions against itself? Indeed I do not know but that the present is the very first statement which has ever been published of this condition of the problem of equal temperatures between two gaseous masses.

oxygen, or nitrogen, or carbonic acid, the temperature is a little higher in the denser than in the rarer condition when the energies are the same. By the hypothesis, equality of temperature between two different gases or two portions of the same gas at different densities means equality of kinetic energies in the same number of molecules of the two. From our observations proving the temperature to be higher, it therefore follows that the potential energy is smaller in the condensed crowd. This—always, however, under protest as to the temperature hypothesis—proves some degree of attraction among the molecules, but it does not prove ultimate attraction between two molecules in collision, or at distances much less than the average mutual distance of nearest neighbours in the multitude. The collisional force might be repulsive, as generally supposed hitherto, and yet attraction might predominate in the whole reckoning of difference between the intrinsic potential energies of the more dense and less dense multitudes. It is, however, remarkable that the explanation of the propagation of sound through gases, and even of the positive fluid pressure of a gas against the sides of the containing vessel, according to the kinetic theory of gases, is quite independent of the question whether the ultimate collisional force is attractive or repulsive. Of course it must be understood that, if it is attractive, the particles must be so small that they hardly ever meet—they would have to be infinitely small to *never* meet—that, in fact, they meet so seldom, in comparison with the number of times their courses are turned through large angles by attraction, that the influence of these purely attractive collisions is preponderant over that of the comparatively very rare impacts from actual contact. Thus, after all, the train of speculation suggested by Davy's "Repulsive Motion" does not allow us to escape from the idea of true repulsion, does not do more than let us say it is of no consequence, nor even say this with truth, because, if there are impacts at all, the nature of the force during the impact and the effects of the mutual impacts, however rare, cannot be evaded in any attempt to realise a conception of the kinetic theory of gases. And in fact, unless we are satisfied to imagine the atoms of a gas as mathematical points endowed with inertia, and, as according to Roscovich, endowed with forces of mutual positive and negative attraction, varying according to some definite function of the distance, we cannot avoid the question of impacts, and of vibrations and rotations of the molecules resulting from impacts, and we must look distinctly on each molecule as being either a little elastic solid or a configuration of motion in a continuous all-pervading liquid. I do not myself see how we can ever permanently rest anywhere short of this last view; but it would be a very pleasant temporary resting-place on the way to it if we could, as it were, make a mechanical model of a gas out of little pieces of round perfectly elastic solid matter, flying about through the space occupied by the gas, and colliding with one another and against the sides of the containing vessel. This is, in fact, all we have of the kinetic theory of gases up to the present time, and this has done for us, in the hands of Clausius and Maxwell, the great things which constitute our first step towards a molecular theory of matter. Of course from it we should have to go on to find an explanation of the elasticity and all the other properties of the molecules themselves, a subject vastly more complex and difficult than the gaseous properties, for the explanation of which we assume the elastic molecule; but without any explanation of the properties of the molecule itself, with merely the assumption that the molecule has the requisite properties, we might rest happy for a while in the contemplation of the kinetic theory of gases, and its explanation of the gaseous properties, which is not only stupendously important as a step towards a more thoroughgoing theory of matter, but is undoubtedly the expression of a perfectly intelligible and definite set of facts in Nature. But alas for our mechanical model consisting of the cloud of little elastic solids flying about amongst one another. Though each particle have absolutely perfect elasticity, the end must be pretty much the same as if it were but imperfectly elastic. The average effect of repeated and repeated mutual collisions must be to gradually convert all the translational energy into energy of shriller and shriller vibrations of the molecule. It seems certain that each collision must have something more of energy in vibrations of very finely divided nodal parts than there was of energy in such vibrations before the impact. The more minute this nodal subdivision, the less must be the tendency to give up part of the vibrational energy into the shape of translational energy in the course of a collision, and I think it is rigorously demonstrable that the whole translational energy must ultimately become transformed into

vibrational energy of higher and higher nodal subdivisions if each molecule is a continuous elastic solid. Let us, then, leave the kinetic theory of gases for a time with this difficulty unsolved, in the hope that we or others after us may return to it, armed with more knowledge of the properties of matter, and with sharper mathematical weapons to cut through the barrier which at present hides from us any view of the molecule itself, and of the effects other than mere change of translational motion which it experiences in collision.

To explain the elasticity of a gas was the primary object of the kinetic theory of gases. This object is only attainable by the assumption of an elasticity more complex in character, and more difficult of explanation, than the elasticity of gases—the elasticity of a solid. Thus, even if the fatal fault in the theory, to which I have alluded, did not exist, and if we could be perfectly satisfied with the kinetic theory of gases founded on the collisions of elastic solid molecules, there would still be beyond it a grander theory which need not be considered a chimerical object of scientific ambition—to explain the elasticity of solids. But we may be stopped when we commence to look in the direction of such a theory with the cynical question: What do you mean by explaining a property of matter? As to being stopped by any such question, all I can say is that if engineering were to be all and to end all physical science, we should perforce be content with merely finding properties of matter by observation, and using them for practical purposes. But I am sure very few, if any, engineers are practically satisfied with so narrow a view of their noble profession. They must and do patiently observe, and discover by observation, properties of matter, and results of material combinations. But deeper questions are always present, and always fraught with interest to the true engineer, and he will be the last to give weight to any other objection to any attempt to see below the surface of things than the practical question: Is it likely to prove wholly futile? But now, instead of imagining the question: What do you mean by explaining a property of matter? to be put cynically, and letting ourselves be irritated by it, suppose we give to the questioner credit for being sympathetic, and condescend to try and answer his question. We find it not very easy to do so. All the properties of matter are so connected that we can scarcely imagine one *thoroughly explained* without our seeing its relation to all the others, without in fact having the explanation of all, and till we have this we cannot tell what we mean by "explaining a property," or "explaining the properties" of matter. But though this consummation may never be reached by man, the progress of science may be, I believe will be, step by step towards it, on many different roads converging towards it from all sides. The kinetic theory of gases is, as I have said, a true step on one of the roads. On the very distinct road of chemical science, St. Clair Deville arrived at his grand theory of dissociation without the slightest aid from the kinetic theory of gases. The fact that he worked it out solely from chemical observation and experiment, and expounded it to the world without any hypothesis whatever, and seemingly even without consciousness of the beautiful explanation it has in the kinetic theory of gases, secured for it immediately an independent solidity and importance as a chemical theory when he first promulgated it, to which it might even by this time scarcely have attained if it had first been suggested as a probability indicated by the kinetic theory of gases, and been only afterwards confirmed by observation. Now, however, guided by the views which Clausius and Williamson have given us of the continuous interchange of partners between the compound molecules constituting chemical compounds in the gaseous state, we see in Deville's theory of dissociation a point of contact of the most transcendent interest between the chemical and physical lines of scientific progress.

To return to elasticity: if we could make out of matter devoid of elasticity a combined system of relatively moving parts which, in virtue of motion, has the essential characteristics of an elastic body, this would surely be, if not positively a step in the kinetic theory of matter, at least a finger-post pointing a way which we may hope will lead to a kinetic theory of matter. Now this, as I have already shown,<sup>1</sup> we can do in several ways. In the case of the last of the communications referred to, of which only the title has hitherto been published, I showed that, from the

<sup>1</sup> Paper on "Vortex Atoms," *Proc. R. S. E.* February 1867; abstract of a lecture before the Royal Institution of Great Britain, March 4, 1881, on "Elasticity Viewed as possibly a Mode of Motion"; Thomson and Tait's "Natural Philosophy," second edition, part 1, §§ 345 viii. to 345 xxvii.; "On Oscillation and Waves in an Adynamic Gyrostatic System" (title only), *Proc. R. S. E.* March 1883.

mathematical investigation of a gyrostatically dominated combination contained in the passage of Thomson and Tait's "Natural Philosophy" referred to, it follows that any ideal system of material particles, acting on one another mutually through massless connecting springs, may be perfectly imitated in a model consisting of rigid links jointed together, and having rapidly rotating fly-wheels pivoted on some or on all of the links. The imitation is not confined to cases of equilibrium. It holds also for vibration produced by disturbing the system infinitesimally from a position of stable equilibrium and leaving it to itself. Thus we may make a gyrostatic system such that it is in equilibrium under the influence of certain positive forces applied to different points of this system; all the forces being precisely the same as, and the points of application similarly situated to, those of the stable system with springs. Then, provided proper masses (that is to say, proper amounts and distributions of inertia) be attributed to the links, we may remove the external forces from each system, and the consequent vibration of the points of application of the forces will be identical. Or we may act upon the systems of material points and springs with any given forces for any given time, and leave it to itself, and do the same thing for the gyrostatic system; the consequent motion will be the same in the two cases. If in the one case the springs are made more and more stiff, and in the other case the

ellipses, which show in perspective the direction of rotation of the fly-wheel of each gyrostat. The gyrostatic system (Fig. 2) might have been constituted of two gyrostatic members, but four are shown for symmetry. The inclosing circle represents in each case in section an inclosing spherical shell to prevent the interior from being seen. In the inside of one there are fly-wheels, in the inside of the other a massless spring. The projecting hooked rods seem as if they are connected by a spring in each case. If we hang any one of the systems up by the hook on one of its projecting rods, and hang a weight to the hook of the other projecting rod, the weight, when first put on, will oscillate up and down, and will go on doing so for ever if the system be absolutely unfrictional. If we check the vibration by hand, the weight will hang down at rest, the pin drawn out to a certain degree; and the distance drawn out will be simply proportional to the weight hung on, as in an ordinary spring balance.

Here, then, out of matter possessing rigidity, but absolutely devoid of elasticity, we have made a perfect model of a spring in the form of a spring balance. Connect millions of millions of particles by pairs of rods such as these of this spring balance, and we have a group of particles constituting an elastic solid; exactly fulfilling the mathematical ideal worked out by Navier, Poisson, and Cauchy, and many other mathematicians who, fol-

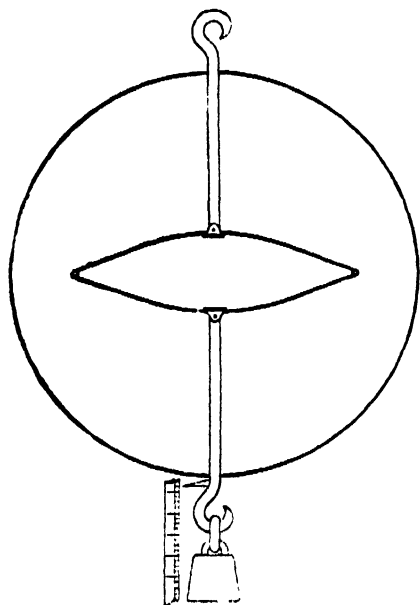

FIG. 1.

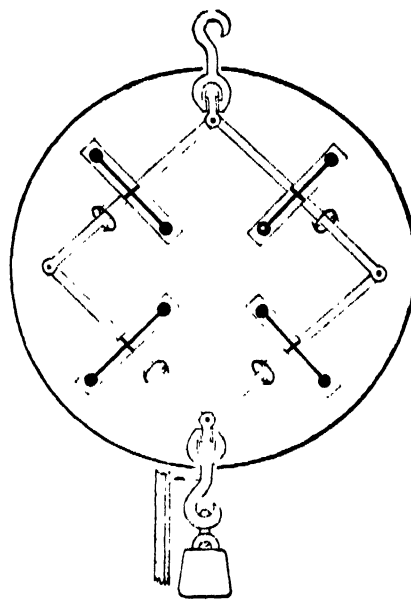

FIG. 2.

angular velocities of the fly-wheels are made greater and greater, the periods of the vibrational constituents of the motion will become shorter and shorter, and the amplitudes smaller and smaller, and the motions will approach more and more nearly those of two perfectly rigid groups of material points, moving through space and rotating according to the well-known mode of rotation of a rigid body having unequal moments of inertia about its three principal axes. In one case the ideal nearly rigid connection between the particles is produced by massless exceedingly stiff springs; in the other case it is produced by the exceedingly rapid rotation of the fly-wheels in a system which, when the fly-wheels are deprived of their rotation, is perfectly limp.

The drawings (Figs. 1 and 2) before you illustrate two such material systems.<sup>1</sup> The directions of rotation of the fly-wheels in the gyrostatic system (Fig. 2) are indicated by directional

<sup>1</sup> In Fig. 1 the two hooked rods seen projecting from the sphere are connected by an elastic coach-spring. In Fig. 2 the hooked rods are connected one to each of two opposite corners of a four-sided jointed frame, each member of which carries a gyrostat so that the axis of rotation of the fly-wheel is in the axis of the member of the frame which bears it. Each of the hooked rods in Fig. 2 is connected to the framework through a swivel joint, so that the whole gyrostatic framework may be rotated about the axis of the hooked rods in order to annul the moment of momentum of the framework about this axis due to rotation of the fly-wheels in the gyrostat.

lowing their example, have endeavoured to found a theory of the elasticity of solids on mutual attraction and repulsion between a group of material particles. All that can possibly be done by this theory, with its assumption of forces acting according to any assumed law of relation to distance, is done by the gyrostatic system. But the gyrostatic system does, besides, what the system of naturally acting material particles cannot do: it constitutes an elastic solid which can have the Faraday magneto-optic rotation of the plane of polarisation of light; supposing the application of our solid to be a model of the luminiferous ether for illustrating the undulatory theory of light. The gyrostatic model spring balance is arranged to have zero moment of momentum as a whole, and therefore to contribute nothing to the Faraday rotation; with this arrangement the model illustrates the luminiferous ether in a field unaffected by magnetic force. But now let there be a different rotational velocity imparted to the jointed square round the axis of the two projecting hooked rods, such as to give a resultant moment of momentum round any given line through the centre of inertia of the system, and let pairs of the hooked rods in the model thus altered, which is no longer a model of a mere spring balance, be applied as connections between millions of pairs of particles as before; with the lines of resultant moment of momentum all similarly directed. We now have a model elastic

solid which will have the property that the direction of vibration in waves of rectilinear vibrations propagated through it shall turn round the line of propagation of the waves, just as Faraday's observation proves to be done by the line of vibration of light in a dense medium between the poles of a powerful magnet. The case of wave front perpendicular to the lines of resultant moment of momentum (that is to say, the direction of propagation being parallel to these lines) corresponds, in our mechanical model, to the case of light travelling in the direction of the lines of force in a magnetic field.

In these illustrations and models we have different portions of ideal rigid matter acting upon one another, by normal pressure at mathematical points of contact—of course no forces of friction are supposed. It is exceedingly interesting to see how thus, with no other postulates than inertia, rigidity, and mutual impenetrability, we can thoroughly model not only an elastic solid, and any combination of elastic solids, but so complex and recon-dite a phenomenon as the passage of polarised light through a magnetic field. But now, with the view of ultimately discarding the postulate of rigidity from all our materials, let us suppose some to be absolutely destitute of rigidity, and to possess merely inertia and incompressibility, and mutual impenetrability with reference to the still remaining rigid matter. With these postulates we can produce a perfect model of mutual action at a distance between solid particles, fulfilling the condition, so keenly desired by Newton and Faraday, of being explained by continuous action through an intervening medium. The law of the mutual force in our model, however, is not the simple Newtonian law, but the much more complex law of the mutual action between electro-magnets—with this difference, that in the hydro-kinetic model in every case the force is opposite in direction to the corresponding force in the electro-magnetic analogue. Imagine a solid bored through with a hole and placed in our ideal perfect liquid. For a moment let the hole be stopped by a diaphragm, and let an impulsive pressure be applied for an instant uniformly over the whole membrane, and then instantly let the membrane be dissolved into liquid. This action originates a motion of the liquid relatively to the solid, of a kind to which I have given the name of "irrotational circulation," which remains absolutely constant however the solid be moved through the liquid. Thus, at any time the actual motion of the liquid at any point in the neighbourhood of the solid will be the resultant of the motion it would have in virtue of the circulation alone, were the solid at rest, and the motion it would have in virtue of the motion of the solid itself, had there been no circulation established through the aperture. It is interesting and important to remark in passing that the whole kinetic energy of the liquid is the sum of the kinetic energies which it would have in the two cases separately. Now, imagine the whole liquid to be inclosed in an infinitely large, rigid, containing vessel, and in the liquid, at an infinite distance from any part of the containing vessel, let two perforated solids, with irrotational circulation through each, be placed at rest near one another. The resultant fluid motion due to the two circulations will give rise to fluid pressure on the two bodies, which, if unbalanced, will cause them to move. The force systems—force-and-torques, or pairs of forces—required to prevent them from moving will be mutual and opposite, and will be the same as, but opposite in direction to, the mutual force systems required to hold at rest two electro-magnets fulfilling the following specification. The two electro-magnets are to be of the same shape and size as the two bodies, and to be placed in the same relative positions, and to consist of infinitely thin layers of electric currents in the surfaces of solids possessing extreme diamagnetic quality—in other words, infinitely small permeability. The distribution of electric current on each body may be any whatever which fulfils the condition that the total current across any closed line drawn on the surface once through the aperture is equal to  $1/4\pi$  of the circulation<sup>1</sup> through the aperture in the hydro-kinetic analogue.

It might be imagined that the action at a distance thus provided for by fluid motion could serve as a foundation for a theory of the equilibrium, and the vibrations, of elastic solids, and the transmission of waves like those of light through an extended quasi-elastic solid medium. But unfortunately for this

<sup>1</sup> The integral of tangential component velocity all round any closed curve, passing once through the aperture, is defined as the "cyclic constant," or the "circulation" ("Vortex Motion," § 60 (a), *Trans. R. S. E. April 29, 1867*). It has the same value for all closed curves passing just once through the aperture, and it remains constant through all time, whether the solid body be in motion or at rest.

idea the equilibrium is essentially unstable, both in the case of magnets, and, notwithstanding the fact that the forces are oppositely directed, in the hydro-kinetic analogue also, when the several movable bodies (two or any greater number) are so placed relatively as to be in equilibrium. If, however, we connect the perforated bodies with circulation through them in the hydro-kinetic system, by jointed rigid connecting links, we may arrange for configurations of stable equilibrium. Thus without fly-wheels, but with fluid circulations through apertures, we may make a model spring balance, or a model luminiferous ether, either without or with the rotational quality corresponding to that of the true luminiferous ether in the magnetic fluid—in short, do all by the perforated solids with circulations through them that we saw we could do by means of linked gyrostats. But something that we cannot do by linked gyrostats we can do by the perforated bodies with fluid circulation: we can make a model gas. The mutual action at a distance, repulsive or attractive according to the mutual aspect of the two bodies when passing within collisional distance<sup>2</sup> of one another, suffices to produce the change of direction of motion in collision, which essentially constitutes the foundation of the kinetic theory of gases, and which, as we have seen before, may as well be due to attraction as to repulsion, so far as we know from any investigation hitherto made in this theory.

There remains, however, as we have seen before, the difficulty of providing for the case of actual impacts between the solids, which must be done by giving them some massless spring buffers, or, which amounts to the same thing, attributing to them repulsive forces sufficiently powerful at very short distances to absolutely prevent impacts between solid and solid; unless we adopt the equally repugnant idea of infinitely small perforated solids, with infinitely great fluid circulations through them. Were it not for this fundamental difficulty, the hydro-kinetic model gas would be exceedingly interesting; and, though we could scarcely adopt it as conceivably a true representation of what gases really are, it might still have some importance as a model configuration of solid and liquid matter, by which without elasticity the elasticity of a true gas might be represented.

But lastly, since the hydro-kinetic model gas with perforated solids and fluid circulations through them fails because of the impacts between the solids, let us annul the solids and leave the liquid performing irrotational circulation round vacancy,<sup>3</sup> in the place of the solid cores which we have hitherto supposed; or let us annul the rigidity of the solid cores of the rings and give them molecular rotation according to Helmholtz's theory of vortex motion. For stability the molecular rotation must be such as to give the same velocity at the boundary of the rotational fluid core as that of the irrotationally circulating liquid in contact with it, because, as I have proved, frictional slip between two portions of liquid in contact is inconsistent with stability. There is a further condition, upon which I cannot enter into detail just now, but which may be understood in a general way when I say that it is a condition of either uniform or of increasing molecular rotation from the surface inwards, analogous to the condition that the density of a liquid, resting for example under the influence of gravity, must either be uniform or must be greater below than above for stability of equilibrium. All that I have said in favour of the model vortex gas composed of perforated solids with fluid circulations through them holds without modification for the purely hydro-kinetic model, composed of either Helmholtz cored vortex-rings or of coreless vortices, and we are now troubled with no such difficulty as that of the impacts between solids. Whether, however, when the vortex theory of gases is thoroughly worked out, it will or will not be found to fail in a manner analogous to the failure which I have already pointed out in connection with the kinetic theory of gases composed of little elastic solid molecules, I cannot at present undertake to speak with certainty. It seems to me most probable that the vortex theory cannot fail in any such way, because all I have been able to find out hitherto regarding the vibration of

<sup>2</sup> According to this view there is no precise distance, or definite condition respecting the distance, between two molecules, at which apparently they come to be in collision, or when receding from one another they cease to be in collision. It is convenient, however, in the kinetic theory of gases, to adopt arbitrarily a precise definition of collision, according to which two bodies or particles mutually acting at a distance may be said to be in collision when their mutual action exceeds some definite arbitrarily assigned limit, as, for example, when the radius of curvature of the path of either body is less than a stated fraction ( $1/100$ , for instance) of the distance between them.

<sup>3</sup> Investigations respecting coreless vortices will be found in a paper by the author, "Vibrations of a Columnar Vortex," *Proc. R. S. E.*, March 1880; and a paper by Hicks, recently read before the Royal Society.

vortices,<sup>1</sup> whether cored or coreless, does not seem to imply the liability of translational or impulsive energies of the individual vortices becoming lost in energy of smaller and smaller vibrations.

As a step towards kinetic theory of matter it is certainly most interesting to remark that in the quasi-elasticity, elasticity looking like that of an india-rubber band, which we see in a vibrating smoke-ring launched from an elliptic aperture, or in two smoke-rings which were circular, but which have become deformed from circularity by mutual collision, we have in reality a virtual elasticity in matter devoid of elasticity, and even devoid of rigidity, the virtual elasticity being due to motion, and generated by the generation of motion.

## SECTION B

## CHEMICAL SCIENCE

OPENING ADDRESS BY PROF. SIR HENRY ENFIELD ROSCOE, PH.D., LL.D., F.R.S., F.C.S., PRESIDENT OF THE SECTION

WITH the death of Berzelius in 1848 ended a well-marked epoch in the history of our science; with that of Dumas—and, alas! that of Wurtz also—in 1884 closes a second. It may not perhaps be unprofitable on the present occasion to glance at some few points in the general progress which chemistry has made during this period, and thus to contrast the position of the science in the “*sturm und drang*” year of 1848, with that in the present, perhaps quieter, period.

The differences between what may probably be termed the Berzelian era and that with which the name of Dumas will for ever be associated show themselves in many ways, but in none more markedly than by the distinct views entertained as to the nature of a chemical compound.

According to the older notions, the properties of compounds are essentially governed by a qualitative nature of their constituent atoms, which were supposed to be so arranged as to form a binary system. Under the new ideas, on the other hand, it is mainly the number and arrangement of the atoms within the molecule, which regulate the characteristics of the compound which is to be looked on not as built up of two constituent groups of atoms, but as forming one group.

Amongst those who successfully worked to secure this important change of view on a fundamental question of chemical theory, the name of Dumas himself must first be mentioned, and, following upon him, the great chemical twin-brethren Laurent and Gerhardt, who, using both the arguments of test-tube and of pen in opposition to the prevailing views, gradually succeeded, though scarcely during the lifetime of the first, in convincing chemists that the condition of things could hardly be a healthy one when chemistry was truly defined “as the science of bodies which do not exist.” For Berzelius, adhering to his preconceived notions, had been forced by the pressure of new discovery into the adoption of formulæ which gradually became more and more complicated, and led to more and more doubtful hypotheses, until his followers at last could barely succeed in building up the original radical from its numerous supposed component parts. Such a state of things naturally brought about its own cure, and the unitary formulæ of Gerhardt began to be generally adopted.

It was not, however, merely as an expression of the nature of the single chemical compound that this change was beneficial, but, more particularly, because it laid open the general analogies of similarly constituted compounds, and placed fact as the touchstone by which the constitution of these allied bodies should be ascertained. Indeed, Gerhardt, in 1852, gave evidence of the truth of this in his well-known theory of type, according to which, organic compounds of ascertained constitution can be arranged under the four types of hydrogen, hydrochloric acid, water, and ammonia, and of which it is, perhaps, not too much to say that it has, more than any other of its time, contributed to the clearer understanding of the relations existing amongst chemical compounds.

Another striking difference of view between the chemistry of the Berzelian era and that of what we sometimes term the modern epoch is illustrated by the so-called substitution theory. Dumas,

to whom we owe this theory, showed that chlorine can take the place of hydrogen in many compounds, and that the resulting body possesses characters similar to the original. Berzelius opposed this view, insisting that the essential differences between these two elements rendered the idea of a substitution impossible, and notwithstanding the powerful advocacy of Liebig, and the discovery by Melsens of reverse substitutions (that is, the reformation of the original compound from its substitution-product), Berzelius remained to the end unconvinced, and that which was in reality a confirmation of his own theory of compound radicals, which, as Liebig says, “illuminated many a dark chapter in organic chemistry,” was looked upon by him as an error of the deepest dye. This inability of many minds to see in the discoveries of others confirmation of their own views is not uncommon; thus Dalton, we may remember, could never bring himself to admit the truth of Gay-Lussac’s laws of gaseous volume-combination, although, as Berzelius very truly says, if we write *atom* for *volume* and consider the substance in the solid state in place of the state of gas, the discovery of Gay-Lussac is seen to be one of the most powerful arguments in favour of Dalton’s hypothesis.

But there is another change of view, dating from the commencement of the Dumas epoch, which has exerted an influence equal, if not superior, to those already named on the progress of our science. The relative weights of the ultimate particles, to use Dalton’s own words, which up to this time had been generally adopted by chemists, were the equivalent weights of Dalton and Wollaston, representing, in the case of oxygen and hydrogen, the proportions in which these elements combine, viz. as 8 to 1. The great Swedish chemist at this time stood almost alone in supporting another hypothesis; for, founding his argument on the simple laws of volume-combination enunciated by Gay-Lussac, he asserted that the true atomic weights are to be represented by the relations existing between equal volumes of the two gases, viz. as 16 to 1. Still these views found no favour in the eyes of chemists until Gerhardt, in 1843, proposed to double the equivalent weights of oxygen, sulphur, and carbon, and then the opposition which this suggestion met with was most intense, Berzelius himself not even deigning to mention it in his annual account of the progress of the science, thus proving the truth of his own words: “That to hold an opinion habitually often leads to such an absolute conviction of its truth that its weak points are unregarded, and all proofs against it ignored.” Nor were these views generally adopted by chemists until Cannizaro, in 1858, placed the whole subject on its present firm basis by clearly distinguishing between equivalent and molecular weights, showing how the atomic weights of the constituent elements are derived from the molecular weights of their volatile compounds based upon the law of Avogadro and Ampère, or where, as is the case with many metals, no compounds of known vapour-density exist, how the same result may be ascertained by the help of the specific heat of the element itself. Remarkable as it may appear, it is nevertheless true that it is in the country of their birth that Gerhardt’s atomic weights and the consequent atomic nomenclature have met with most opposition, so much so that within a year or two of the present time there was not a single course of lectures delivered in Paris in which these were used.

The theory of organic radicals, developed by Liebig so long ago as 1834, received numerous experimental confirmations in succeeding years. Bunsen’s classical research on cacodyl, proving the possibility of the existence of metallo-organic radicals capable of playing the part of a metal, and the isolation of the hydrocarbon ethyl by Frankland in 1849, laid what the supporters of the theory deemed the final stone in the structure.

The fusion of the radical and type theories, chiefly effected by the discovery in 1849 of the compound ammonias by Wurtz, brings us to the dawn of modern chemistry. Henceforward organic compounds were seen to be capable of comparison with simple inorganic bodies, and hydrogen not only capable of replacement by chlorine, or by a metal, but by an organic group or radical.

To this period my memory takes me back. Liebig at Giessen, Wöhler in Göttingen, Bunsen in Marburg, Dumas, Wurtz, and Laurent and Gerhardt in Paris, were the active spirits in Continental chemistry. In our own country, Graham, whose memorable researches on the phosphates had enabled Liebig to found his theory of polybasic acids, was working and lecturing at University College, London; and Williamson, imbued with the new doctrines and views of the twin French chemists, had just

<sup>1</sup> See papers by the author “On Vortex Motion,” *Trans. R. S. E.*, April 1867, and “Vortex Statics,” *Proc. R. S. E.*, December 1875; also a paper by J. J. Thomson, B.A., “On the Vibrations of a Vortex Ring,” *Trans. R. S. E.*, December 1881, and his valuable book on “Vortex Motion.”

been appointed to the Chair of Practical Chemistry in the same College, vacant by the death of poor Fownes. At the same time, Hofmann, in whom Liebig found a spirit as enthusiastic in the cause of scientific progress as his own, bringing to England a good share of the Giessen fire, founded the most successful school of chemistry which this country has yet seen.

At the Edinburgh meeting of this Association in 1850, Williamson read a paper on "Results of a Research on *Ætherification*," which included not only a satisfactory solution of an interesting and hitherto unexplained problem, but was destined to exert a most important influence on the development of our theoretical views. For he proved, contrary to the then prevailing ideas, that ether contains twice as much carbon as alcohol, and that it is not formed from the latter by a mere separation of the elements of water, but by an exchange of hydrogen for ethyl, and this fact, being in accordance with Avogadro's law of molecular volumes, could only be represented by regarding the molecule of water as containing two atoms of hydrogen to one of oxygen, one of the former being replaced by one of ethyl to form alcohol, and the two of hydrogen by two of ethyl to form ether. Then Williamson introduced the type of water (subsequently adopted by Gerhardt) into organic chemistry, and extended our views of the analogies between alcohols and acids, by pointing out that these latter are also referable to the water-type, predicting that bodies bearing the same relations to the ordinary acids as the ethers do to the alcohols must exist, a prediction shortly afterwards (1852) verified by Gerhardt's discovery of the anhydrides. Other results followed in rapid succession, all tending to knit together the framework of modern theoretical chemistry. Of these the most important was the adoption of condensed types, of compounds constructed on the type of two and three molecules of water, with which the names of Williamson and Odling are connected, culminating in the researches of Brodie on the higher alcohols, of Berthelot on glycerine, and of Wurtz on the dibasic alcohols or glycols; whilst, in another direction, the researches of Hofmann on the compound amines and amides opened out an entirely new field, showing that either a part or the whole of the hydrogen in ammonia can be replaced by other elements or elementary groups without the type losing its characteristic properties.

Again, in 1852, we note the first germs of a theory which was destined to play an all-important part in the progress of the science, viz., the doctrine of valency or atomicity, and to Frankland it is that we owe this new departure. Singularly enough, whilst considering the symmetry of construction visible amongst the inorganic compounds of nitrogen, phosphorus, arsenic, and antimony, and whilst putting forward the fact that the combining power of the attracting element is always satisfied by the same number of atoms, he does not point out the characteristic tetrad nature of carbon; and it was not until 1858 that Couper initiated, and Kekulé, in the same year, thoroughly established, the doctrine of the linking of the tetrad carbon atoms, a doctrine to which, more than to any other, is due the extraordinary progress which organic chemistry has made during the last twenty years, a progress so vast that it is already found impossible for one individual, even though he devote his whole time and energies to the task, to master all the details, or make himself at home with the increasing mass of new facts which the busy workers in this field are daily bringing forth.

The subject of the valency of the elements is one which, since the year above referred to, has given chemists much food for discussion, as well as opportunity for experimental work. But whether we range ourselves with Kekulé, who supports the unalterable character of the valency of each element, or with Frankland, who insists on its variability, it is now clear to most chemists that the hard and fast lines upon which this theory was supposed to stand cannot be held to be secure. For if the progress of investigation has shown that it is impossible in many instances to affix one valency to an element which forms a large number of different compounds, it is also equally impossible to look on the opposite view as tending towards progress, inasmuch as to ascribe to an element as many valencies as it possesses compounds with some other element, is only expressing by circuitous methods what the old Daltonian law of combination in multiple proportion states in simple terms. Still we may note certain generally-accepted conclusions: in the first place, that of the existence of non-saturated compounds both inorganic and organic, as carbon-monoxide on the one hand, and malic and citraconic acids on the other. Secondly, that the valency of an element is not only dependent upon the nature of the element with which it

combines, but that this valency is a periodic function of the atomic weight of the other component. Thus the elements of the chlorine group are always monads when combined with positive elements or radicals, but triad, pentad, and heptad with negative ones. Again, the elements of the sulphur group are dyads in the first case, but tetrad and hexad in the second. The periodicity of this property of the atoms, increasing and again diminishing, is clearly seen in such a series as



as well as in the series of oxides. The difficulties which beset this subject may be judged of by the mention of a case or two:—Is vanadium a tetrad because its highest chloride contains four atoms of chlorine? What are we to say is the valency of lead when one atom unites with four methyls to form a volatile product, and yet the vapour-density of the chloride shows that the molecule contains one of metal to two of chlorine? Or, how can our method be said to determine the valency of tungsten when the hexachloride decomposes in the state of vapour, and the pentachloride is the highest volatile stable compound? How again are we to define the point at which a body is volatile without decomposition?—thus sulphur tetrachloride, one of the most unstable of compounds, can be vaporised without decomposition at all temperatures below  $-22^\circ$ , whilst water, one of the most stable of known compounds, is dissociated into its elements at the temperature of melting platinum.

But, however many doubts may have been raised in special instances against a thorough application of the law of valency, it cannot be denied that the general relations of the elements which this question of valency has been the means of bringing to light are of the highest importance, and point to the existence of laws of Nature of the widest significance; I allude to the periodic law of the elements first foreshadowed by Newlands, but fully developed by Mendeléeff and Lothar Meyer. Guided by the principle that the chemical properties of the elements are a periodic function of their atomic weights, or that matter becomes endowed with analogous properties when the atomic weight of an element is increased by the same or nearly the same number, we find ourselves for the first time in possession of a key which enables us to arrange the hitherto *disjecta membra* of our chemical household in something like order, and thus gives us means of indicating the family resemblances by which these elements are characterised.

And here we may congratulate ourselves on the fact that, by the recent experiments of Brauner, and of Nilson and Pettersen respectively, tellurium and beryllium, two of the hitherto outstanding members, have been induced to join the ranks, so that at the present time osmium is the only important defaulter amongst the sixty-four elements, and few persons will doubt that a little careful attention to this case will remove the stigma which yet attaches to its name. But this periodic law makes it possible for us to do more; for as the astronomer, by the perturbations of known planets, can predict the existence of hitherto unknown ones, so the chemist, though, of course, with much less satisfactory means, has been able to predict with precision the properties, physical and chemical, of certain missing links amongst the elements, such as ekaaluminium and ekaboron, then unborn, but which shortly afterwards became well known to us in the flesh as gallium and scandium. We must, however, take care that success in a few cases does not blind us to the fact that the law of Nature which expresses the relation between the properties of the elements and the value of the atomic weights is as yet unknown; that many of the groupings are not due to any well-ascertained analogy of properties of the elements, and that it is only because the values of their atomic weights exhibit certain regularities that such a grouping is rendered possible. So, to quote Lothar Meyer, we shall do well in this, as indeed in all similar cases in science, to remember the danger pointed out in Bacon's aphorism, that "The mind delights in springing up to the most general axioms, that it may find rest, but after a short stay here it disdains experience," and to bear in mind that it is only the lawful union of hypothesis with experiment which will prove a fruitful one in the establishment of a systematic inorganic chemistry which need not fear comparison with the order which reigns in the organic branch of our science. And here it will be reminded that complexity of constitution is not the sole prerogative of the carbon compounds, and that before this systematisation of inorganic chemistry can be effected we shall have to come to terms with many compounds concerning whose constitution we are at present wholly in ignorance. As instances

of such I would refer to the finely crystalline phospho-molybdates, containing several hundred atoms in the molecule, lately prepared by Wolcott Gibbs.

Arising out of Kekulé's theory of the tetrad nature of the carbon atom, came the questions which have caused much debate among chemists: (1) Are the four combining units of the carbon atom of equal value or not? and (2) Is the assumption of a dyad carbon atom in the so-called non-saturated compounds justifiable or not? The answer to the first of these, a favourite view of Kolbe's, is given in the now well-ascertained laws of isomerism; and from the year 1862, when Schorlemmer proved the identity of the hydrides of the alcohol radicals with the so-called radicals themselves, this question may be said to have been set at rest; for Lossen himself admits that the existence of his singular isomeric hydroxylamine derivatives can be explained otherwise than by the assumption of a difference between each of the combining units of nitrogen, and the differences supposed by Schreiner to hold good between the methyl-ethyl carbonic ethers have been shown to have no existence in fact. With respect to the second point the reply is no less definite, and is recorded in the fact, amongst others, that ethylene chlorhydrin yields on oxidation chloracetic acid, a reaction which cannot be explained on the hypothesis of the existence in ethylene of a dyad carbon atom.

Passing from this subject, we arrive, by a process of natural selection, at more complicated cases of chemical orientation—that is, given certain compounds which possess the same composition and molecular formula but varying properties, to find the difference in molecular structure by which such variation of properties is determined. Problems of this nature can now be satisfactorily solved, the number of possible isomers foretold, and this prediction confirmed by experiment. The general method adopted in such an experimental inquiry into the molecular arrangement or chemical constitution of a given compound is either to build up the structure from less complicated ones of known constitution, or to resolve it into such component parts. Thus, for example, if we wish to discriminate between several isomeric alcohols, distinguishing the ordinary or primary class from the secondary or tertiary class, the existence of which was predicted by Kolbe in 1862, and of which the first member was prepared by Friedel in 1864, we have to study their products of oxidation. If one yields an acid having the same number of carbon atoms as the alcohol, it belongs to the first class and possesses a definite molecular structure; if it splits up into two distinct carbon compounds, it is a secondary alcohol; and if three carbon compounds result from its oxidation, it must be classed in the third category, and to it belongs a definite molecular structure, different from that of the other two.

In a similar way orientation in the much more complicated aromatic hydrocarbons can be effected. This class of bodies forms the nucleus of an enormous number of carbon compounds which, both from a theoretical and a practical point of view, are of the highest interest. For these bodies exhibit characters and possess a constitution totally different from those of the so-called fatty substances, the carbon atoms being linked together more intimately than is the case in the latter-named group of bodies. Amongst them are found all the artificial colouring matters, and some of the most valuable pharmaceutical and therapeutical agents.

The discovery of the aniline colours by Perkin, their elaboration by Hofmann, the synthesis of alizarin by Graebe and Liebermann, being the first vegetable colouring matter which has been artificially obtained, the artificial production of indigo by Baeyer, and lastly the preparation, by Fischer, of kairin, a febrifuge as potent as quinine, are some of the well-known recent triumphs of modern synthetical chemistry. And these triumphs, let us remember, have not been obtained by any such "random haphazarding" as yielded results in Priestley's time. In the virgin soil of a century ago, the ground only required to be scratched and the seed thrown in to yield a fruitful crop; now the surface soil has long been exhausted, and the successful cultivator can only obtain results by a deep and thorough preparation, and by a systematic and scientific treatment of his material.

In no department of our science has the progress made been more important than in that concerned with the accurate determination of the numerical, physical, and chemical constants upon the exactitude of which every quantitative chemical operation depends. For the foundation of an accurate knowledge of the first of these constants, viz., the atomic weights of the elements, science is indebted to the indefatigable labours of Berzelius. But

"humanum est errare," and even Berzelius's accurate hand and delicate conscientiousness did not preserve him from mistakes, since corrected by other workers. In such determinations it is difficult, if not impossible, always to ascertain the limits of error attaching to the number. The errors may be due in the first place to manipulative faults, in the second to inaccuracy of the methods, or lastly to mistaken views as to the composition of the material operated upon; and hence the uniformity of any series of similar determinations gives no guarantee of their truth, the only safe guide being the agreement of determinations made by altogether different methods. The work commenced by Berzelius was worthily continued by many chemists. Stas and Marignac, bringing work of an almost astronomical accuracy into our science, have ascertained the atomic weights of silver and iodine to within one hundred-thousandth of their value, whilst the numbers for chlorine, bromine, potassium, sodium, nitrogen, sulphur, and oxygen may now be considered correct to within a unit in the fourth figure. Few of the elements, however, boast numbers approaching this degree of accuracy, and many may even still be erroneous from half to a whole unit of hydrogen. And, as Lothar Meyer says, until the greater number of the atomic weights are determined to within one or two tenths of the unit, we cannot expect to be able to ascertain the laws which certainly govern these numbers, or to recognise the relations which undoubtedly exist between them and the general chemical and physical properties of the elements. Amongst the most interesting recent additions to our knowledge made in this department we may note the classical experiments, in 1880, of J. W. Mallet on aluminium, and in the same year of J. P. Cooke on antimony, and those, in the present year, of Thorpe on titanium.

Since the date of Berzelius's death to the present day, no discovery in our science has been so far-reaching, or led to such unforeseen and remarkable conclusions, as the foundation of Spectrum Analysis by Bunsen and Kirchhoff in 1860.

Independently altogether of the knowledge which has been gained concerning the distribution of the elementary bodies in terrestrial matter, and of the discovery of half a dozen new elements by its means, and putting aside for a moment the revelation of a chemistry not bounded by this world, but limitless as the heavens, we find that over and above all these results spectrum analysis offers the means, not otherwise open to us, of obtaining knowledge concerning the atomic and molecular condition of matter.

Let me recall some of the more remarkable conclusions to which the researches of Lockyer, Schuster, Liveing and Dewar, Wüllner, and others in this direction have led. In the first place it is well to bear in mind that a difference of a very marked kind, first distinctly pointed out by Alex. Mitscherlich, is to be observed between the spectrum of an element and that of its compounds, the latter only being seen in cases in which the compound is not dissociated at temperatures necessary to give rise to a glowing gas. Secondly, that these compound spectra—as, for instance, those of the halogen compounds of the alkaline-earth metals—exhibit a certain family likeness, and show signs of systematic variation in the position of the lines, corresponding to changes in the molecular weight of the vibrating system. Still this important subject of the relation of the spectra of different elements is far from being placed on a satisfactory basis, and in spite of the researches of Lecoq de Boisbaudran, Ditte, Troost and Hautefeuille, Ciamician, and others, it cannot be said that as yet definite proof has been given in support of the theory that a causal connection is to be found between the emission spectra of the several elements belonging to allied groups and their atomic weights or other chemical or physical properties. In certain of the single elements, however, the connection between the spectra and the molecular constitution can be traced. In the case of sulphur, for example, three distinct spectra are known. The first of these, a continuous one, is exhibited at temperatures below 500°, when, as we know from Dumas' experiments, the density of the vapour is three times the normal, showing that at this temperature the molecule consists of six atoms. The second spectrum is seen when the temperature is raised to above 1000°, when, as Deville and Troost have shown, the vapour reaches its normal density, and the molecule of sulphur, as with most other gases, contains two atoms, and this is a band spectrum, or one characterised by channelled spaces. Together with this band spectrum, and especially round the negative pole, a spectrum of bright lines is observed. This latter is doubtless due to the vibrations of the single atoms of the dissociated molecule, the



existence of traces of a band spectrum demonstrating the fact that in some parts of the discharge the tension of dissociation is insufficient to prevent the reunion of the atoms to form the molecule.

To this instance of the light thrown on molecular relations by changes in the spectra, others may be added. Thus the low-temperature spectrum of channelled spaces, mapped by Schuster and myself, in the case of potassium, corresponds to the molecule of two atoms and to the vapour-density of seventy-nine, as observed by Dewar and Dittmar. Again, both oxygen and nitrogen exhibit two, if not three, distinct spectra: of these the line spectrum seen at the highest temperatures corresponds to the atom; the band spectrum seen at intermediate temperatures represents the molecule of two atoms; whilst that observed at a still lower point would, as in the case of sulphur, indicate the existence of a more complicated molecule, known to us in one instance as ozone.

That this explanation of the cause of these different spectra of an element is the true one, can be verified in a remarkable way. Contrary to the general rule amongst those elements which can readily be volatilised, and with which, therefore, low-temperature spectra can be studied, mercury exhibits but one spectrum, and that one of bright lines, or, according to the preceding theory, a spectrum of atoms. So that, judging from spectroscopic evidence, we infer that the atoms of mercury do not unite to form a molecule, and we should predict that the vapour-density of mercury is only half its atomic weight. Such we know, from chemical evidence, is really the case, the molecule of mercury being identical in weight with its atom.

The cases of cadmium and iodine require further elucidation. The molecule of gaseous cadmium, like that of mercury, consists of one atom; probably, therefore, the cadmium spectrum is also distinguished by one set of lines. Again, the molecule of iodine at 1200° separates, as we know from Victor Meyer's researches, into single atoms. Here spectrum analysis may come again to our aid; but, as Schuster remarks, in his report on the spectra of the non-metallic elements, a more extensive series of experiments than those already made by Ciamician is required before any definite opinion as to the connection of the different iodine spectra with the molecular condition of the gas can be expressed.

It is not to be wondered at that these relations are only exhibited in the case of a few elements. For most of the metals the vapour-density remains, and probably will remain, an unknown quantity, and therefore the connection between any observed changes in the spectra and the molecular weights must also remain unknown. The remarkable changes which the emission spectrum of a single element—iron, for instance—exhibits have been the subject of much discussion, experimental and otherwise. Of these, the phenomenon of long and short lines is one of the most striking, and the explanation that the long lines are those of low temperature appears to meet the fact satisfactorily, although the effect of dilution, that is, a reduction of the quantity of material undergoing volatilisation, is, remarkably enough, the same as that of diminution of temperature. Thus it is possible, by the examination of a spectrum by Lockyer's method, to predict the changes which it will undergo, either on alteration of temperature, or by an increase or decrease of quantity. There appears to be no theoretical difficulty in assuming that the relative intensity of the lines may vary when the temperature is altered, and the molecular theory of gases furnishes us with a plausible explanation of the corresponding change when the relative quantities of the luminous elements in a mixture are altered. Lockyer has proposed a different explanation of the facts. According to him, every change of relative intensity means a corresponding change of molecular complexity, and the lines which we see strong near the poles would bear the same relation to those which are visible throughout the field, as a line spectrum bears to a band spectrum; but then almost every line must be due to a different molecular grouping, a conclusion which is scarcely capable of being upheld without very cogent proof.

The examination of the absorption-spectra of salts, saline and organic liquids, first by Gladstone, and afterwards by Bunsen, and by Russell, as well as by Hartley for the ultra-violet, and by Abney and Festing for the infra-red region, have led to interesting results in relation to molecular chemistry. Thus Hartley finds that, in some of the more complicated aromatic compounds, definite absorption-bands in the more refrangible region are only produced by substances in which three pairs of carbon atoms are

doubly linked, as in the benzene ring, and thus the means of ascertaining this double linkage is given. The most remarkable results obtained by Abney and Festing show that the radical of an organic body is always represented by certain well-marked absorption-bands, differing, however, in position, according as it is linked with hydrogen, a halogen, or with carbon, oxygen, or nitrogen. Indeed, these experimenters go so far as to say that it is highly probable that by this delicate mode of analysis the hypothetical position of any hydrogen which is replaced may be identified, thus pointing out a method of physical orientation of which, if confirmed by other observers, chemists will not be slow to avail themselves. This result, it is interesting to learn, has been rendered more than probable by the recent important researches of Perkin on the connection between the constitution and the optical properties of chemical compound.

One of the noteworthy features of chemical progress is the interest taken by physicists in fundamental questions of our science. We all remember, in the first place, Sir William Thomson's interesting speculations, founded upon physical phenomena, respecting the probable size of the atom, viz. "that if a drop of water were magnified to the size of the earth, the constituent atoms would be larger than small shot, but smaller than cricket balls." Again, Helmholtz, in the Faraday Lecture, delivered in 1881, discusses the relation of electricity and chemical energy, and points out that Faraday's law of electrolysis, and the modern theory of valency, are both expressions of the fact that, when the same quantity of electricity passes through an electrolyte, it always either sets free, or transfers to other combinations, the same number of units of affinity at both electrodes. Helmholtz further argues that, if we accept the Daltonian atomic hypothesis, we cannot avoid the conclusion that electricity, both positive and negative, is divided into elementary portions which behave like atoms of electricity. He also shows that these charges of atomic electricity are enormously large as compared, for example, with the attraction of gravitation between the same atoms; in the case of oxygen and hydrogen, 71,000 billion times larger.

A further subject of interest to chemists is the theory of the vortex-ring constitution of matter thrown out by Sir William Thomson, and lately worked out from a chemical point of view by J. J. Thomson, of Cambridge. He finds that if one such ring be supposed to constitute the most simple form of matter, say the monad hydrogen atom, then two such rings must, on coming into contact with nearly the same velocity, remain enchain'd together, constituting what we know as the molecule of free hydrogen. So, in like manner, systems containing two, three, and four such rings constitute the dyad, tryad, and tetrad atoms. How far this mathematical expression of chemical theory may prove consistent with fact remains to be seen.

Another branch of our science which has recently attracted much experimental attention is that of thermo-chemistry, a subject upon which in the future the foundation of dynamical chemistry must rest, and one which already proclaims the truth of the great principle of the conservation of energy in all cases of chemical as well as of physical change. But here, although the materials hitherto collected are of very considerable amount and value, the time has not yet arrived for expressing these results in general terms, and we must, therefore, be content to note progress in special lines and wait for the expansion into wider areas. Reference may, however, be properly made to one interesting observation of general significance. It is well known that, while, in most instances, the act of combination is accompanied by evolution of heat—that is, whilst the potential energy of most combining bodies is greater than that of most compounds—cases occur in which the reverse of this is true, and heat is absorbed in combination. In such cases the compound readily undergoes decomposition, frequently suddenly and with explosion. Acetylene and cyanogen seem to be exceptions to this rule, inasmuch as, whilst their component elements require to have energy added to them in order to enable them to combine, the compounds appear to be very stable bodies. Berthelot has explained this enigma by showing that, just as we may ignite a mass of dynamite without danger, whilst explosion takes place if we agitate the molecules by a detonator, so acetylene and cyanogen burn, as we know, quietly when ignited, but when their molecules are shaken by the detonation of even a minute quantity of fulminate, the constituents fly apart with explosive violence, carbon and hydrogen, or carbon and nitrogen, being set free, and the quantity of heat absorbed in the act of combination being suddenly liberated.

In conclusion, whilst far from proposing even to mention all the important steps by which our science has advanced since the year 1848, I cannot refrain from referring to two more. In the first place, to that discovery, more than foreshadowed by Faraday, of the liquefaction of the so-called permanent gases by Pictet and Cailletet; and secondly, to that of the laws of dissociation as investigated by Deville. The former, including Andrews's discovery of the critical point, indicates a connection, long unseen, between the liquid and the gaseous states of matter; the latter has opened out entirely fresh fields for research, and has given us new views concerning the stability of chemical compounds of great importance and interest.

Turning for a moment to another topic, we feel that, although science knows no nationalities, it is impossible for those who, like ourselves, exhibit strong national traits, to avoid asking whether we Anglo-Saxons hold our own, as compared with other nations, in the part we have played and are playing in the development of our science. With regard to the past, the names of Boyle, Cavendish, Priestley, Dalton, Black, Davy, are sufficient guarantees that the English have, to say the least, occupied a position second to none in the early annals of chemistry. How has it been in the era which I have attempted to describe? What is the present position of English chemistry, and what its look-out for the future? In endeavouring to make this estimate, I would take the widest ground, including not only the efforts made to extend the boundaries of our science by new discovery, both in the theoretical and applied branches, but also those which have the no less important aims of spreading the knowledge of the subject amongst the people, and of establishing industries dependent on chemical principles by which the human race is benefited. Taking this wide view, I think we may, without hesitation, affirm that the progress which chemistry has made through the energies of the Anglo-Saxon race is not less than that made by any other nation.

In so far as pure science is concerned, I have already given evidence of the not inconsiderable part which English chemists have played in the progress since 1848. We must, however, acknowledge that the number of original chemical papers now published in our language is much smaller than that appearing in the German tongue, and that the activity and devotion displayed in this direction by the heads of German laboratories may well be laid to heart by some of us in England; yet, on the other hand, it must be remembered that the circumstances of different countries are so different that it is by no means clear that we should follow the same lines. Indeed our national characteristics forbid us to do so, and it may be that the bent of the Germanic lies in the assiduous collection of facts, whilst their subsequent elaboration and connection is the natural work of our own race.

As regards the publication of so-called original work by students, and speaking now only for myself as the director of an English chemical laboratory, I feel I am doing the best for the young men who, wishing to become either scientific or industrial chemists, are placed under my charge, in giving them as sound and extensive a foundation in the theory and practice of chemical science as their time and abilities will allow, rather than forcing them prematurely into the preparation of a new series of homologous compounds or the investigation of some special reaction, or of some possible new colouring matter, though such work might doubtless lead to publication. My aim has been to prepare a young man, by a careful and fairly complete general training, to fill with intelligence and success a post either as teacher or industrial chemist, rather than to turn out mere specialists, who, placed under other conditions than those to which they have been accustomed, are unable to get out of the narrow groove in which they have been trained. And this seems a reasonable course, for whilst the market for the pure specialist, as the colour chemist for example, may easily be overstocked, the man of all-round intelligence will always find opportunity for the exercise of his powers. Far, however, from underrating the educational advantages of working at original subjects, I consider this sort of training to be of the highest and best kind, but only useful when founded upon a sound and general basis.

The difficulty which the English teacher of chemistry—and in this I may include Canada and the United States—has to contend against is that, whilst in Germany the value of this high and thorough training is generally admitted, in England a belief in its efficacy is as yet not generally entertained. "The Englishman," to quote from the recent Report of the Royal Commission on Technical Instruction, "is accustomed

to seek for an immediate return, and has yet to learn that an extended and systematic education, up to and including the methods of original research, is now a necessary preliminary to the fullest development of industry, and it is to the gradual but sure growth of public opinion in this direction that we must look for the means of securing to this country in the future, as in the past, the highest position as an industrial nation."

If, in the second place, we consider the influence which Englishmen have exerted on the teaching of our science, we shall feel reason for satisfaction; many of our text-books are translated into every European language and largely used abroad; often to the exclusion of those written by Continental chemists.

Again, science teaching, both practical and theoretical, in our elementary and many secondary schools, is certainly not inferior to that in schools of similar grade abroad, and the interest in and desire for scientific training is rapidly spreading throughout our working population, and is even now as great as, if not greater than, abroad. The universities and higher colleges are also moving to take their share of the work which has hitherto been far less completely done in our country than on the continent of Europe, especially in Germany, where the healthful spirit of competition, fostered by the numerous State-supported institutions, is much more common than with us, and, being of equal value in educational as in professional or commercial matters, has had its due effect.

Turning lastly to the practical applications of our science, in what department does England not excel? and in which has she not made the most important new departures? Even in colour chemistry, concerning which we have heard, with truth, much of German supremacy, we must remember that the industry is originally an English one, as the names of Perkin and of Maule, Simpson and Nicholson, testify; and if we have hitherto been beaten hollow in the development of this branch, signs are not wanting that this may not always be the case. But take any other branch of applied chemistry, the alkali trade for instance, what names but English, with the two great exceptions of Leblanc and Solvay, do we find in connection with real discoveries? In the application of chemistry to metallurgical processes, too, the names of Darby, Cort, Neilson, and Bell in iron, of Bessemer, Thomas, Gilchrist, and Snelus in steel, of Elkington and Matthey in the noble metals, show that in these branches the discoveries which have revolutionised processes have been made by Englishmen; whilst Young, the father of paraffin, Spence the alum-maker, and Abel of gun-cotton fame, are some amongst many of our countrymen whose names may be honourably mentioned as having founded new chemical industries.

Hence, whilst there is much to stimulate us to action in the energy and zeal shown by our Continental brethren in the pursuit both of pure and applied chemistry, there is nothing to lead us to think that the chemistry of the English-speaking nations in the next fifty years will be less worthy than that of the past half-century of standing side by side with that of her friendly rivals elsewhere.

## SECTION D

## BIOLOGY

OPENING ADDRESS BY H. N. MOSELEY, M.A., F.R.S.,  
LINACRE PROFESSOR OF HUMAN AND COMPARATIVE  
ANATOMY IN THE UNIVERSITY OF OXFORD, PRESIDENT  
OF THE SECTION

IN appointing the phenomena of pelagic and deep-sea life as one of the subjects specially selected for consideration at the present meeting of this Section, the Organising Committee have, I think, done wisely. Our knowledge of the subject is at present in most active progress. It is one of the widest and deepest interest to the physiologist as well as the zoologist, and in some features claims a share of attention from the botanist. And the proximity here of the United States, to which science is indebted for so many important discoveries on deep-sea matters, is a strong argument in favour of the subject being brought forward at a British Association meeting on this side of the Atlantic. I have naturally been led to choose the consideration of some deep-sea biological questions as the subject of my address by the special interest which I have been led to take in deep-sea phenomena generally, owing to my long participation in actual deep-sea research during the voyage of H.M.S. *Challenger*.

Unfortunately, the physiology of deep-sea life has until lately

received but little attention from professed physiologists. No physiologist has, as far as I am aware, as yet set forth comprehensively and dwelt upon the numerous difficulties which are encountered when the attempt is made to comprehend the mode in which the ordinary physiological processes of Vertebrata and other animals are carried on under the peculiar physical conditions which exist at great depths.

Whilst I was on the *Challenger* voyage, absorbed principally in the zoological discoveries daily resulting from the dredging operations, I received a letter from my revered teacher, Prof. Ludwig, of Leipzig, which brought deep-sea phenomena before me in a very different light. The Professor naturally regarded deep-sea questions mainly from a physiological point of view, and asked a series of most suggestive questions bearing on it. I am much indebted to him for this and recent letters on the same subject. One of the first questions he asked was, naturally, as to the amount of oxygen present in deep-sea water. A knowledge of the conditions under which gases occur in a state of absorption in the ocean-waters is of primary importance to the physiologist. With regard to this subject, most valuable information is contained in the report by the distinguished chemist, Prof. Dittmar, on "Researches into the Composition of the Ocean-Water collected by H.M.S. *Challenger*," which has appeared during the present year, and which embodies Mr. J. Y. Buchanan's results.<sup>1</sup> It appears from his results that, contrary to what was before suspected, the presence of free carbonic acid in sea-water is an exception. What carbonic acid is present occurs as a bicarbonate, in general more or less incompletely saturated. In surface-waters the proportion of carbonic acid increases when the temperature falls, and *vice versa*. Deep-sea water does not contain an abnormal proportion of loose or free carbonic acid.

Hence, with regard to Mr. John Murray's interesting discovery that after certain depths are reached *Pteropod* shells are dissolved and disappear from the sea-bottom, and at certain further depths *Globigerina* shells suffer the same fate, Prof. Dittmar holds the opinion that the solution is not due to the presence of free acid, but to the solvent action of the sea-water itself, which will, even when alkaline, take up additional carbonate of lime if sufficient time be given. Thus the amount of carbonic acid normally present throughout the ocean cannot be inimical to life; but, according to the Professor, there must be in the depths of the ocean numerous bodies of richly carbonated water, for he regards the principal supply of carbonic acid to the sea-water as derived from volcanic springs and discharges issuing from the ocean-bed, the quantity derived from the decay of marine plants and animals being insignificant in comparison with this. Possibly the *Challenger*, when it dredged from deep water off the Azores immense quantities of dead and blackened coral, encountered an area which had thus been visited by a carbonic acid discharge.

With regard to the absorbed oxygen and nitrogen, the theoretical maximum quantity of oxygen absorbed at normal surface-pressure by a litre of sea-water should range, according to Prof. Dittmar's experiments and calculations, from 8.18 c.c. in cold regions at 0° C. to 4.50 c.c. in the tropics, with a temperature of 30° C. The result experimentally obtained from samples of surface-water collected during the voyage differ considerably in detail from the calculated estimates, from various causes explained, and especially because of the reduction of the amount of oxygen by oxidation and respiration. The main and almost sole source of the nitrogen and oxygen present in deep-sea water lies in the atmosphere, and is absorbed there, its quantity being thus dependent on surface conditions of temperature and pressure, and not those of the depths. A given quantity of water, having absorbed its oxygen and nitrogen at the surface, may be supposed to sink unmixed with surrounding water to the depths. During the process its amount of contained nitrogen remains constant, whilst its oxygen-supply becomes gradually diminished, owing to the process of oxidation, which in the depths goes on without compensation. That the amount of absorbed oxygen present in sea-water diminishes with the depth has been shown already by Dr. Lant Carpenter's experiments. It is not yet possible to formulate in any precise terms the relation between the depth and the diminution of the oxygen present, but Mr. J. Y. Buchanan's previous conclusion that a minimum of oxygen is attained at a depth of about 800 fathoms is not confirmed by the summing-up of the whole of the evidence now

available. This result is not without biological significance, since the existence of this supposed zone with a minimum of oxygen has been used as an argument in favour of the occurrence of especially abundant life at this depth below the ocean-surface.

Prof. Dittmar finds that there is nothing characteristic of bottom-waters as such in regard to their absorbed gases, nothing to distinguish them from waters from intermediate depths. This, it seems to me, is not quite what might have been expected, as the concentration of the food-supply, and consequently of life, on the actual bottom might have led to a different result.

If there were absolute stagnation of the water at great depths, the oxygen might be reduced there to zero, but the fact that in no case has oxygen been entirely absent from any sample of deep-sea water examined proves that a certain motion and change must occur. The smallest amount of oxygen found at all was in a sample of water from a depth of 2,875 fathoms, and amounted to 0.65 c.c. per litre only, a result long ago published by Mr. Buchanan. Even this, however, may well be sufficient to support life, since Humboldt and Provençal<sup>2</sup> found that certain fish could breathe in water containing only one-third of that quantity of oxygen per litre. In another sample, from 1645 fathoms, it was 2.04 c.c. On the other hand, as much as 4.055 c.c. was found in a sample from 4575 fathoms, and 4.39 c.c. in one from 3025. Most remarkable, in one instance water from a depth of only 300 fathoms yielded only 1.65 c.c. of oxygen. Prof. Dittmar admits that there was no lack of anomalous results, some, no doubt, due to some extent to imperfection in the apparatus employed in collecting the water.

In connection with the valuable investigations carried on in the *Travailleur* and the *Talisman* by Prof. Milne-Edwards and his associates, French physiologists have lately commenced researches on some of the problems of deep-sea life.

Experiments have been made by M. Regnard<sup>3</sup> with a view of determining the effects of high pressures, corresponding with those of the deep sea, on various organisms. Yeast, after being exposed to a pressure of 1000 atmospheres, equal to a depth of about 6500 fathoms of sea-water, for an hour, was mixed with a solution of sugar. An hour elapsed before any signs of fermentation appeared, and a mixture of yeast and sugar solution did not ferment at all whilst under a pressure of 600 atmospheres, equal to a depth of about 3900 fathoms. Alga, seeds of phanerogamic plants, Infusoria, and even Mollusca and leeches, were found to be thrown into a sort of state of sleep or latency by exposure to similar pressures, recovering from this condition after a shorter or longer period of return to normal conditions. A fish without a swimming bladder, or one with the bladder emptied of air, may be submitted to a pressure of 100 atmospheres, equivalent to a depth of 650 fathoms, without injurious effect. At 200 atmospheres, equivalent to a depth of 1300 fathoms, it becomes torpid, but soon revives when the pressure is removed. At 300 atmospheres, equivalent to a depth of about 2000 fathoms, the fish dies.

These experiments are of the highest interest. The pressure made use of was obtained by means of water in the absence of air other than that absorbed at the normal atmosphere pressure, and thus the physical conditions produced were closely similar to those actually existent in the deep sea. They are the first of their kind.

Prof. Paul Bert's<sup>3</sup> somewhat similar experiments related to a different question altogether—namely, the effect on aquatic organisms of water subjected to the pressure of compressed air. He found that young eels were rapidly killed when subjected to a pressure of only 15 atmospheres, and could not survive one of even 7 atmospheres for any considerable time.<sup>4</sup> He pointed out the essential difference between the conditions produced in such experiments and those existing in the deep sea, where the charge of oxygen contained by the water has been taken up at the surface at a pressure of one atmosphere only.

In the experiments on animals made by M. Regnard's method there is the obvious difficulty that the supply of oxygen in the water compressed cannot be renewed during the experiment but must be gradually reduced by respiration, and for this reason it would probably be useless, unless a large quantity of water would

<sup>1</sup> "Sur la Respiration des Poissons," *Journ. de Physique, de Chimie, et d'Histoire Naturelle*, t. lxxix. October 1860, p. 268.

<sup>2</sup> P. Regnard, "Recherches Experimentales sur l'Influence des très-hautes Pressions sur les Organismes vivants," *Comptes Rendus*, No. 12, 24 mars 1884, p. 745.

<sup>3</sup> *Pression barométrique*, Paris, 1878, p. 814.

<sup>4</sup> *Ibid.* p. 1151.

<sup>1</sup> "Official Report on the Scientific Results of the Voyage of H.M.S. *Challenger*: *Physics and Chemistry*," vol. i.

be employed, to try the effect on a fish of a very gradual application of pressure, extending over many hours. It is probable that the results would be greatly modified if plenty of time could be given for the fish to accommodate itself to the change of pressure, and the conditions in which it moves in nature slowly from one depth to another be imitated. The results of M. Regnard's further experiments will be looked forward to with great interest.

A question of the utmost moment, and one that has received a good deal of attention, is that as to the source of food of the deep-sea animals. Certainly a large proportion of this food is derived from the life on the ocean-surface. The debris of pelagic animals sinks slowly downwards, forming on its passage a sparsely scattered supply of food for any animals possibly living at intermediate depths, but becoming concentrated as it were on the bottom. The pelagic animals depend for their ultimate source of food, no doubt, largely on the various pelagic plants, the range of which in depth is limited by the penetration of sea-water by the sunlight, and probably to an important extent is dependent on the symbiotic combinations of radiolarians with zooxanthella. But a large part of their food-supply is also constituted by animal and vegetable debris derived from the coasts, either directly from the littoral zone or by rivers and the action of the tides from terrestrial life. Immense quantities of shore-debris have been dredged from deep water near coasts, and deep-sea life appears to diminish in abundance as coasts are receded from. Unfortunately our knowledge of pelagic vegetable life is very imperfect, and it is to be hoped that botanists may be led to take up the subject and bring together what is known with regard to the geological ranges and abundance of the various larger sea-weeds, trichodesmium, diatoms, and other Algae by which the sea-surface is inhabited. It will, then, be possible to form a nearer estimate of the extent to which these plants are capable of forming a sufficient ultimate food-source for the greater part of the pelagic fauna, and through it of deep-sea life. The question is of importance, because if the deep sea, having no ultimate source of food in itself, derived its main supply from the coasts and land-surfaces in the early history of the habitation of the globe by animals, there can have existed scarcely any deep-sea fauna until the littoral and terrestrial faunas and floras had become well established.

Whether the littoral and terrestrial plants or the pelagic be proved to have the larger share in composing the ultimate food-source of the deep sea, it seems certain that the food as it reaches the deep sea is mostly in the form of dead matter, and I imagine that the long but slender backwardly-directed teeth of many deep-sea fish, resembling those of snakes, are used rather as aids for swallowing whole other fishes which have fallen from above dead, and thus making the best of an occasional opportunity of a meal, than for catching and killing living prey. In a lecture on "Life in the Deep Sea," delivered in 1880,<sup>1</sup> I suggested that putrefaction of organic matter, such as ordinarily occurs elsewhere, may possibly be entirely absent in the deep sea, the Bacteria and other microphytes which cause it being possibly absent. Some interesting experiments with regard to this question have lately been made by M. A. Certes.<sup>2</sup> He added to sterilised solutions of hay-extract, milk, broth, and other organic nutrient fluids mixed with sea-water, with the usual necessary precautions, small quantities of deep-sea mud, or deep-sea water, procured by the *Travailleur* and *Talisman*. In some experiments air was present; others were made *in vacuo*. In nearly all the former putrefaction occurred after some time, especially after application of warmth, and micro-organisms were developed, whilst the latter remained without exception sterile, apparently indicating that the microbes which live where air is absent are not present in the deep sea. The others, which developed in the presence of oxygen, may possibly have sunk from the surface to the bottom, and have retained their vitality, although it is not improbable that they may be incapable of active existence and multiplication under the physical conditions there existing. M. Certes is to make further experiments on this question under conditions of pressure and temperature as nearly resembling those of the deep sea as possible. In the deep sea the ordinary cycle of chemical changes of matter produced by life is incomplete, there being no plants to work up the decom-

position-products. These, therefore, in the absence of any rapid change of the deep-sea waters, must accumulate there, and can only be turned to account when they reach the surface-waters on the littoral regions.

Many interesting results may be expected to be obtained when the histology of animals from great depths comes to be worked out, and especially that of the special sense-organs. At present very little has been attempted in this direction, principally, no doubt, because deep-sea specimens are too precious to be used for the purpose. In a remarkable scopolid fish dredged by the *Challenger* from deep water, *Scopelogadus murrayi* of Dr. Gunther, the eyes are curiously flattened out and occupy the whole upper surface of the mouth. They are devoid of any trace of lens or iris, and, as appears from observations by Mr. John Murray and my own examination of his preparations, the retina consists of a layer of long rods, with a very thin layer indeed of nerve-fibres in front of it, and apparently no intervening granular ganglionic or other layers. The rods are disposed in hexagonal bundles, the free ends of which rest on corresponding well-defined hexagonal areas, into which the choroid is divided. It is probable that aberrant structures may be found in the retinas of deep-sea fish, which may conceivably help towards physiological conclusions as to the functions of the various components. With regard to the all-important question of the nature of the light undoubtedly present in the deep sea, it is hardly possible to accept Prof. Verrill's recent startling suggestion that sunlight penetrates to the greatest depths with perhaps an intensity at from 2000 to 3000 fathoms equal to that of some of our partially moonlight nights. Such a conjecture is entirely at variance with the results of all experiments on the penetration of sea-water by sunlight as yet made by physicists, results which have prevented other naturalists from adopting this solution of the problem.

The progress of research by experts on the deep-sea fauna confirms the conclusions early formed that it is impossible to determine any successive zones of depth in the deep-sea regions characterised by the presence of special groups of animals. Within the deep-sea region the contents of a trawl brought up from the bottom give no evidence which can be relied on as to the depth at which the bottom lies within a range of at least 2500 fathoms. Some groups of animals appear to be characteristic of water of considerable depth, but representatives of them struggle up into much shallower regions. Thus of the remarkable order of Holothurian *Elasipoda* nearly all the representatives occur at very considerable depths, and their numbers diminish shorewards, but one has been found in only 100 fathoms. Again, the Pourtalesidae range upwards into about 300 fathoms, and the Phormosomas, which Loven considers as eminently deep-sea forms, range up to a little over 100 fathoms depth, and are nearly represented in shallow water at a depth of only five fathoms by *Asthenosoma*. As has often been pointed out before, there are numerous genera, and even species, which range even from the shore-region to great depths.

The fact that zones of depth cannot thus be determined adds seriously to the difficulties encountered in the attempt to determine approximately the depths at which geological deposits have been found. Dr. Theodore Fuchs,<sup>3</sup> in an elaborate essay on all questions bearing on the subject, has attempted to determine what geological strata should be considered as of deep-sea formation, but, as he defines the deep-sea fauna as commencing at 100 fathoms and extending downwards to all depths, his results may be considered as merely determining whether certain deposits have been found in as great a depth as 100 fathoms or less, a result of little value as indicating the depths of ancient seas or the extent of upheaval or depression of their bottoms. Mr. John Murray has shown that the depths at which modern deep-sea deposits have been formed can be approximately ascertained by the examination of their microscopical composition and the condition of preservation of the contained pelagic and other shells and spicules.

The most important question with regard to life in the ocean, at present insufficiently answered, is that as to the conditions with regard to life of the intermediate waters between the surface and the bottom. It is most necessary that further investigations should be made in extension of those carried out by Mr. Alexander Agassiz with similar apparatus—a net, or vessel, which can be let down to a certain depth whilst completely closed,

<sup>1</sup> Lecture delivered at the Royal Institution, March 5, 1880, *Nature*, vol. xxi. p. 592.

<sup>2</sup> "Sur la Culture, à l'abri des Germes atmosphériques, des Eaux et des Sédiments rapportés par les Expéditions du *Travailleur* et du *Talisman*, 1882, 1883," *Comptes Rendus*, No. 12, 11 mars 1884, p. 690.

<sup>3</sup> "Welche Ablagerungen haben wir als Tiefseebildungen zu betrachten?" *Neues Jahrbuch für Mineralogie, Geologie, und Paläontologie*, 1878, Bd. 1282.

then opened, lowered for some distance, and again closed before it is drawn to the surface. The greatest uncertainty and difference of opinion exist as to whether the intermediate waters are inhabited at all by animals, and, if they are inhabited, to what extent; and these intermediate waters constitute by far the greatest part of the ocean. If we estimate roughly the depth of the surface-zone inhabited by an abundant pelagic fauna at 100 fathoms, and that of the zone inhabited by the bottom animals at 100 fathoms also, the average depth of the ocean being about 1880 fathoms, it results that the intermediate waters, concerning the conditions of life in which we are at present in the utmost uncertainty, really represent more than eight-ninths of the bulk of the entire ocean. Great care should be exercised in drawing conclusions from the depths ascribed to animals in some of the memoirs in the official work on the *Challenger* Expedition. The scientific staff of the Expedition merely recorded on each bottle containing a specimen the depth from which the net in which the specimen was found had been drawn up. In many instances, from the nature of the specimen, it is impossible that it can have come from anywhere but the bottom, but in many others it is quite possible that a particular specimen may have entered the net at any intermediate depth, or close to the surface, and this is a matter on which the author of the monograph in which the specimen is described can form the best conclusion, if one can be formed at all from his knowledge of the animal itself. In all doubtful cases the mere record of the depth must be received with caution.

Just as before the commencement of the present period of deep-sea research there was a strong tendency amongst naturalists, owing to the influence of the views of Edward Forbes, to refuse to accept the clearest evidences of the existence of starfish and other animal life on the sea-bottom at great depths, so there seems now to have sprung up in certain quarters an opposite tendency, leading to the assignment of animals possibly of surface origin to great depths on inconclusive evidence.

With regard to the constitution of the deep-sea fauna, one of its most remarkable features is the general absence from it of Palæozoic forms, excepting so far as representatives of the Mollusca and Brachiopoda are concerned, and it is remarkable that amongst the deep-sea Mollusca no representatives of the *Nautilidae* and *Ammonitidae*, so excessively abundant in ancient periods, occur, and that *Lingula*, the most ancient Brachiopod, should occur in shallow water only.

There are no representatives of the most characteristic of the Palæozoic corals, such as *Zaphrentis*, *Cystiphyllum*, *Stauria*, or *Goniophyllum*. Possible representatives of the *Cyathonanida* have indeed been obtained in *Gryyina*, described by Prof. Martin Duncan, and *Haplophyllia* and *Duncania*, described by the late Count Pourtales, but the *Cyathonanida* are the least observant and characteristic members of so-called *Rugosa*. Pourtales justly felt doubtful whether the arrangement of the septa in four systems instead of six could in itself be considered as a criterion of the *Rugosa*,<sup>1</sup> and in the cases of *Haplophyllia* and *Duncania* the septa may be described rather as devoid of any definite numerical arrangement than exhibiting any tetrameral grouping. Further, I have lately examined by means of sections the structure of the soft parts of *Duncania* in a specimen kindly given to me by Mr. Alexander Agassiz for the purpose, and find that with regard to the peculiar arrangement of the longitudinal septal muscles and the demarcation of the directive septa the coral agrees essentially with the hexactinian *Caryophyllia* and all other modern *Madreporaria* the anatomy of which has been adequately investigated.

There are further no representatives of the ancient *Alcyonarians*, forming massive coralla, the *Helioporida* and their allies, in deep water, no *Palaecrinoids*, *Cystidea*, or *Blastoidea*, no *Palaechinoida*, no *Trilobites*, no allies of *Limulus*, no *Ganoids*. Further, other ancestral forms, certainly of great antiquity, although unrecorded geologically, such as *Amphioxus*, do not occur in deep water. It might well have been expected that, had the deep sea been fully colonised in the Palæozoic period, a considerable series of representative forms of that age might have survived there in the absence of most of the active physical agents of modification which characterise the coast regions.

From the results of present deep-sea research, it appears that almost all modern littoral forms are capable of adapting themselves to the conditions of deep-sea life, and there is no reason why Palæozoic forms should not have done so if the abyssal

conditions were similar to those now existing, just as a considerable number of forms of the chalk period have survived there. In fact, however, most of the survivals of very ancient forms—*Heliopora*, *Limulus*, *Amphioxus*, *Dipnoi*, *Ganoids*—occur in shallow seas or fresh water.

With regard to the origin of the deep-sea fauna, there can be little doubt that it has been derived almost entirely from the littoral fauna, which also must have preceded, and possibly given rise to, the entire terrestrial fauna. Although the littoral, and even its offspring, the terrestrial faunas, have undoubtedly, during the progress of time, contributed to the pelagic fauna, and although it is very likely that the first traces of life may have come into existence in the shallow waters of the coast, it is not improbable that we should look to the pelagic conditions of existence as those under which most of the earliest types of animal life were developed. Nearly all the present inhabitants of the littoral zone revert to the pelagic free-swimming form of existence in their early developmental stages, or in cases where these stages have been lost can be shown to have once possessed it. And these pelagic larval forms are in many cases so closely alike in essential structure, though springing from parents allied but widely differentiated from one another in the adult form, that it is impossible to regard them as otherwise than ancestral. Had they been produced by independent modification of the early stages of the several adult forms as a means of aiding in the diffusion of the species, they must have become more widely differentiated from one another. The various early pelagic free-swimming forms, represented now mostly only by larvæ, gradually adapted themselves to coast life, and underwent various modifications to enable them to withstand the beating of the surf on the shores and the actual modifying alterations of the tides, which, together with other circumstances of coast life, acted as strong impulses to their further development and differentiation. Some developed hard shells and skeletons as protections; others secured their position by boring in the rocks or mud; others assumed an attached condition, and thus resisted the wash of the waves. A remarkable instance in point, about the circumstances of which there can be little doubt, is that of the *Cirripedia*. The *Cypris* larva of *Balanus*, evidently of pelagic origin, sprung from a *Nauplius*, fixes itself by its head to the rocks and develops a hard conical shell, by means of which it withstands the surf in places where nothing else can live. In the same way the *Planula* larva, the Palæozoic cœlenterate form, produces the reef coral and various other forms specially modified for and by the conditions of littoral existence. Similarly echinoderms, Mollusca, Polyzoa, Crustacea, recapitulate in their ontogeny their passage from a pelagic into a littoral form of existence.

It is because the ancestors of nearly all animals have passed through a littoral phase of existence, preceded mostly by a pelagic phase, that the investigations now being carried on on the coasts in marine laboratories throw floods of light on all the fundamental problems of zoology. From the littoral fauna a gradual migration must have taken place into the deep sea, but probably this did not occur till the littoral fauna was very fully established and considerable pressure was brought to bear on it by the struggle for existence. Further, since a large share of the present food of deep-sea animals is derived from coast-debris, life must have become abundant in the littoral zone before there could have been a sufficient food-supply in the deeper regions adjoining it. Not until the development of terrestrial vegetation and animal life can the supply have reached its present abundance. Such a condition was, however, certainly reached in the Carboniferous period. From what has been stated as to the general absence of representatives of Palæozoic forms from the deep sea, it is just possible that if deep oceans existed in Palæozoic periods they may not have been colonised at all, or to a very small extent, then, and that active migration into deep waters commenced in the secondary period. Very possibly the discharges of carbonic acid from the interior of the earth, which Prof. Dittmar believes may have been sufficient to account for the vast existing deposits of coal and limestone, may have been much more abundant than at present over the deep-sea beds in the Palæozoic period, and have rendered the deep waters more or less uninhabitable.

In his splendid monograph on the *Pourtalesia*,<sup>1</sup> which has recently appeared, Prof. Loven has dwelt on the peculiar importance of the littoral region, and of the infinity of agencies present in it "competent to call into play the tendencies to vary

<sup>1</sup> "Zoological Results of the Hassler Expedition." See *Cat. Mus. Comp. Zool. Harvard*, No. viii. 1874, p. 44.

<sup>1</sup> On *Pourtalesia*, a Group of Echinoida, by Even Loven. (Stockholm. 1883.)

which are embodied in each species." He treats of the origin of the deep-sea fauna from that of the littoral region. It is impossible here to follow him in his most valuable speculations. In one matter, however, I would venture to express a difference of opinion. He regards the littoral forms of invertebrates as migrating into the deep sea by the following process: Their free-swimming larvæ are supposed to be carried out by currents far from land, and then, having completed their development, to sink to the bottom, where a very few survive and thrive. It is hardly to be conceived that any animal, especially in a young and tender condition, could suddenly adapt itself to the vast change of conditions entailed in a move from littoral to deep-sea life. It seems to me much more likely that the move of animals from the shallow to the deep sea has been of the most gradual kind, and spread over long series of generations, which may have migrated downwards, perhaps a fathom or so in a century, partly by very slight migrations of the adults, partly by very short excursions of larvæ. Thus alone, by almost insensible steps, could animals, such as those under consideration, be enabled to survive an entire change of food, light, temperature, and surroundings.

### NOTES

WE have received a box of plants from the Ben Nevis Observatory, including specimens of *Saxifraga stellaris*, from a height of 4400 feet, and *Armeria vulgaris*, from 4370 feet. The plants of these two species, with the numerous flowers which covered them, are as large and well grown as any we have ever seen at lower levels. There is also a specimen of *Gnaphalium supinum*, fairly well grown and in flower, from a height of 4370 feet, and a single plant of *Oxyria reniformis* from 4390 feet, also fairly well grown, but not in flower. The interest attached to the collection is the great height at which they have been found growing in full vigour, the heights being greater than those hitherto given in our "Floras" as the limits of growth of the species in the British Islands. In the case of *Armeria vulgaris* the height is considerably greater, 3800 feet being the limit assigned to this species in Hooker's "British Flora."

THE Hygienic Congress has voted a resolution requesting the Dutch Government to convoke an International Conference on Cholera, for the purpose of establishing a permanent International Epidemical Committee, and preparing an international penal sanitary code. The Congress has denounced the modern system of education and competitive examinations as injurious to health.

ON the afternoon of Tuesday, August 12, the foundation-stone of the new Meteorological Observatory at Falmouth was laid by the Right Hon. the Earl of Mount Edgcumbe, the President of the Royal Cornwall Polytechnic Society, in the presence of an assembly of over 400 persons. Some eighteen months ago the Meteorological Council of London gave notice that they intended to maintain only three first-class Observatories in the British Isles, and that the grants to four out of the seven then existing would cease on December 31, 1883. The three which they decided on continuing to subsidise were Kew, Valentia, and Aberdeen, but in view of the good work done and the value of the observations, the Council expressed the hope that local efforts would succeed in maintaining the Observatories at the other four stations. The Meteorological Committee of the Royal Cornwall Polytechnic Society, which has the local management of the Observatory, made strenuous efforts to retain the institution in Falmouth, and, after much negotiation, the Meteorological Office agreed to continue their grant of 250*l.* a year, provided a new building were erected on a site approved by them, at some distance from the harbour, so as to be free from the disturbing influences on the wind which the harbour and its surroundings were supposed to cause. The Polytechnic Society took the matter up with great zeal and determination, and the result has been that matters in connection with the new

Observatory have become sufficiently matured to admit of the foundation-stone being laid. The new Observatory is situate at the top of Killigrew Street, opposite Belmont. It will not take the shape of the present one, with its high octagonal tower, but will be built in the form of a villa residence, one portion to be the dwelling-house of the superintendent (Mr. E. Kitto, F.R.Met.S.), the other to be specially constructed for the reception of the various instruments. The apparatus in the present Observatory will be transferred to the new one, and the observations now carried on will be continued without alteration, so that the Falmouth Observatory will still be one of the first-class Observatories of the United Kingdom, under the control of the Meteorological Office. The instruments are a barograph, for recording the changes of the barometer; a thermograph, for recording the variations of both the dry and the wet bulb thermometers; the anemograph, to measure the force and direction of the wind; a sunshine recorder; and a self-registering rain-gauge. In addition to these, the Royal Society have made a grant for the purchase of a complete set of magnetographs for recording the declination of the needle, and the force of the magnetic currents. Although these will entail an extra annual expense of 50*l.* a year, the Polytechnic Society has boldly undertaken the responsibility of this work. Seeing that the great value of magnetic observations depends to a large extent on their being taken simultaneously and continuously at stations far removed from one another, and that there is now no first-class magnetic Observatory in the British Isles west of Oxford, Falmouth Observatory may be expected to supply a valuable additional data to our knowledge of this comparatively little-known subject. The Observatory will be under the superintendence of Mr. E. Kitto, the Secretary of the Royal Cornwall Polytechnic Society.

PROF. C. V. RILEY, U.S. Entomologist, and Curator of Insects in the U.S. National Museum, left for home on the 23rd, expecting to arrive in time for the meeting of the American Association for the Advancement of Science in Philadelphia. During his two month's sojourn in Europe he has twice been on the Continent, and has visited correspondents and acquaintances both there and in England, examining the insect collections in various museums, and especially in our own at South Kensington. He speaks favourably of the lasting influence for good which the International Forestry Exhibition at Edinburgh will have, and of the Serrel serigraph—an American invention which has of late years been perfected in Lyons, and which he thinks is destined to revolutionise silk-reeling and profoundly influence silk-culture, which is just now attracting unusual attention in the States. He was also much interested with the investigations into the life-habits of the *Aphididae* that are being carried on by Jules Lichtenstein at Montpellier, and with the thoroughness with which the French authorities encourage experimental research in advanced agriculture. He received a warm welcome at Montpellier, whither he went at the invitation of the French Minister of Agriculture to explain some new methods of dealing with the Phylloxera, and where he found his own recommendations of previous years so fully carried out. He was also surprised at the very extensive and successful experiments with American vines carried on at Pageset near Nîmes. At a meeting of the Société d'Agriculture d'Hérault, held on June 30, he read a paper entitled "Quelques Mots sur les Insecticides aux États-Unis, et proposition d'un nouveau remède," which appears in full, with an account of the discussion, &c., in *Le Messager Agricole* for July 10, 1884. The "new" remedy is kerosene emulsion, which has been successfully used, especially against *Coccida*, in the States. Its application against the Phylloxera is recommended in much the same manner as is used with regard to bisulphate of carbon; the proportions recommended are 300 or 400 grammes of the emulsion in 40 litres of water.

THE Russian Ministry of Marine has distributed among several learned societies a plan for despatching a Russian expedition to the North Pole, starting from North-Eastern Siberia or Jeannette Island, discovered by the *Jeannette* Expedition, and proceeding entirely on foot over the ice in several parties, with large depots in the rear. It is thought that there are many islands north of Jeannette Island which may be explored.

THE following lecture demonstrations will be given in the Hygienic Laboratory at the International Health Exhibition during the forthcoming week by Mr. Charles E. Cassal, F.C.S., Chief Demonstrator:—Tuesday, September 2, Arsenic in Wall Papers and Articles of Clothing; Wednesday, September 3, Drinking-Water; Friday, September 5, Common Food Adulterations. The lectures will commence at 4 p.m.

WHILE at Newcastle last week, the Prince of Wales opened a new Library and Museum of Natural History.

HAVING been asked by M. Wilkens if there are not among the plants of Central Asia remains of the Tertiary period corresponding to those which have been discovered among the animals, Dr. A. Regel, in a letter from Tashkend, which has just appeared in the *Bulletin de la Société des Naturalistes de Moscou*, answers that to say anything about the subject would require a closer comparison with fossil plants. This he could not possibly make during his journey. Still, he points out how many plants in the lowlands and in the wild spurs of the highlands have quite special characters: it is sufficient to mention the plants with leather-like leaves, the Salsolaceæ without leaves, which recall the vegetation of Australia and Africa, or the Ericaceæ-like *Reaumuriacæ* of Jungaria. He considers, however, such observations "rather æsthetical," and not sufficiently conclusive; he likes better to collect the necessary material for ulterior work.

PROF. RAOUL PICTET, of the University of Geneva, communicates to a local journal a short memoir of his friend, Baron Thenard, who died at his Château of Talmay on August 8. The late Baron was the son of the illustrious chemist of the same name, and, like him, he devoted his life and his fortune to the service of science. The late M. Thenard was especially distinguished for his investigations in agricultural chemistry—investigations which obtained for him in 1865 admission to the French Institute. An extensive landowner in the Departments of the Côte d'Or and Saône-et-Loire, he paid great attention to the perfection of agricultural machinery and implements, to improved methods of husbandry, the discovery of more efficient fertilisers, and the introduction of new fruits and vegetables. In his laboratories at Paris and at Talmay Baron Thenard devoted himself with rare energy to the elaboration of new methods of organic analysis. Some of the substances he desired to examine he placed in closed circuits, full of pure oxygen, in order to measure how much of the gas was absorbed during the process of combustion, the circulation of the gas being actuated by mercury pumps of the Baron's own invention, which Prof. Pictet describes as singularly ingenious pieces of mechanism.

It is proposed to form, at the Academy of Sciences of St. Petersburg, a special Committee for the concentration of all observations on meteorology, magnetism, rainfall, and thunderstorms, which are now made in Russia, partly under the direction of the Central Physical Observatory, and, to a great extent, by the initiative of the Geographical Society, the Departments of Ways and Communications, Agriculture, and so on, or privately. The Committee will consist of members of the Academy of Sciences, the Geographical Society, and those Ministries which grant sums of money for meteorological observations.

THE last number of the *Isvestia* of the East Siberian branch of the Geographical Society (vol. xiv. fasc. 4 and 5) contains

some interesting notes on the paths that connect Verkhoyansk with Yakutsk, with two maps of the country, by M. Gorokhoff; a note on the Ike-Aral settlement in Transbaikalia, by M. Mikhailoff; and letters from the Polar meteorological station at Sagastyr. The last of these is dated November 25, 1883 and we notice with pleasure that the zeal of the scientific staff of the station continues unabated; the news that they have been allowed to stay for a second winter at the station has been received by them with great pleasure; and Dr. Bunge, already on his journey home, returned immediately from Bulun as soon as he met with the Cossack who brought a letter from the Geographical Society granting the necessary money for a second year's stay at the mouth of the Lena.

IT has been resolved, it seems, to drain the beautiful Merjelen Lake, seen by all tourists who climb the Eggishorn and visit the great Aletsch glacier. From time to time it breaks its icy barriers, leaps in a mad torrent into the bed of the Marsa and spreads terror and destruction in all the valley of the Upper Rhone. The Merjelen contains 10,000,000 cubic metres of water is 50 m. deep at the point where it is bounded by the Aletsch glacier, and 12·50 m. at the opposite extremity. The basin of the lake is 1500 m. long, its direction is from west to east, and at the eastern end is the overflow. It is here that the proposed operation will be effected. The opening, 540 m. long and 12·50 m. deep, will thus be at the back of the lake and its effect will be to lower its level by 12·50 m., and diminish its volume by about one-half, the present mean depth being some 25 m., and although, so say the engineers, the operation may not absolutely prevent future floods, they will be rendered thereby both much rarer and far less dangerous.

*La Lumière Électrique* has sent a scientific mission of six of its staff in order to report on the Exhibition of Philadelphia and the state of electrical industries in America.

AN Imperial decree, issued this month, interdicts the delivery from Russian circulating libraries to their subscribers of the scientific works of the following authors:—Agassiz, Büchner, Huxley, Lubbock, Lewes, Moleschott, Reclus, Adam Smith, Spencer, Vogt, and Zimmermann. The works of Charles Darwin have already been submitted to the same interdiction.

THE principal article in the current number of *Petermann's Mittheilungen* is on the Trans-Caspian and the neighbouring regions, based on the travels of Lessar. It deals with Atek, the roads from Saraks and Merv to Herat, including four days in Afghanistan, Meshed, the road from Saraks to Merv, with an account of the latter town, and Merv to Bokhara. The paper is accompanied by a map of Merv and the Russo-Persian frontier. Another paper, of present importance (also with a map) is one on the territory of the International Association on the Congo.

A CORRESPONDENT of the *Times* from Peking, writing or mining in China, refers to the various obstacles which have stood in the way of progress in this direction in the Middle Kingdom. First there is the mysterious but powerful *feng-shui*, or geomantic influences, an all-pervading superstition, but occasionally elastic, and yielding to expediency, as the spread of telegraphs in the country during the past two years has demonstrated. Then comes the innate suspicion and dislike of foreigners, by whom the mineral wealth of China has been explored, and the importance of working it demonstrated. But "the most efficient obstacle of all" is the ignorance of the officials of the application of science to industry. The long and absorbing devotion to Chinese literature which is necessary to obtain official employment renders any other study, even did the taste or the means of pursuing it exist, all but impossible. The rulers of China fear to avail themselves largely of the services of the "base mechanical" foreigner, unless as a humble instrument, which they cannot always be sure that

will consent to remain. Nevertheless marked advance has been made in certain directions. Apart from the employment of all the modern military and naval inventions, native-armed steamships have become common enough; the telegraphs are rapidly extending all over the country, and only last week a telegraph office was opened at Pekin itself. Railways are to be introduced gradually, and the correspondent narrates the story of an attempt to work coal-mines on Western methods. The Kaiping mines, which are specially referred to, have not been altogether a financial success, on account of the difficulties of transport, the necessity of constructing a rough canal for part of the way, and the refusal of the authorities to permit of the regular employment of steam locomotives between the mines and the nearest waterway. Still the experiment is stated to be full of hope, for the causes which have rendered it a loss to its promoters can be remedied, it is said, by a stroke of the pen.

A RECENT number of the *China Review* contains an article on the Chinese and Japanese plants found in Normandy. During a recent holiday in Europe the writer, M. Fauvel, was struck by the quantity of exotic and even sub-tropical plants cultivated there, and amused himself by searching for the Chinese and Japanese species. The district examined was chiefly that round Cherbourg. The paper describes first the trees and shrubs, which are in a majority, and then refers to the herbaceous flowers and plants, ornamental and useful. Among these were the *Camellia japonica*, the *Chamærops excelsa*, or Chinese palm, the deciduous magnolias of China, *Paulownia imperialis*, wistaria, the rhododendrons and azaleas of China and Japan, the Japanese quince (*Cydonia japonica*), and many others, all of which will be found noted in a paper which may be read with interest by many who take but a limited interest in botany.

DR. CHARLES CLAY contributes to the *Chemical News* of August 8 an interesting reminiscence of Dalton. Dr. Clay was a pupil of Dalton's, and he tells very graphically his adventures in search of four bottles of fire-damp, for which he had to proceed from Manchester to Oilham.

A GROTTO, from 8 to 10 metres high, has been discovered in a rock, washed by the sea, in the Morbihan, by M. Gaillard. He has since continued his researches, at low water, and found some human bones, ancient earthenware marked with allegorical figures, and coins believed to have been struck by the early Gauls.

THE National Electrical Commission, *Science* states, met in Philadelphia on August 7. It was decided that the Conference to be conducted by the Commission will be called for Monday, September 8, to be then continued from day to day, as may be found necessary. The invitations to the Conference will be confined to physicists of eminence, and to experts in the practical management of electrical appliances and apparatus. It is proposed to extend special invitations to prominent foreign visiting electricians. It was also decided to issue a circular inviting the conferees to submit a paper to be read before the Conference. It is not definitely known what subjects will be discussed at the Conference, but the following matters have been suggested: the sources of electrical energy; the theoretical conditions necessary to the most efficient construction of the dynamo-electric machine for the various purposes of practical work; the electrical transmission of energy; the systems of arc and incandescent lighting; the theory of the electric arc, storage batteries, electro-metallurgy; lighthouses for the coast; applications of electricity to military and mining engineering; lightning protection; induction in telephone lines, and the problem of long-distance telephoning; the question of underground wires; atmospheric electricity; earth-currents and terrestrial magnetism; photometry and standards for photometric measurements; the ratio of the electro-magnetic to the electro-static system of units, and the

electro-magnetic theory of light; and finally, on account of the pressing necessity for accurate and uniform electrical measurements, it is probable that the question of establishing a National Bureau of Physical Standards will receive proper attention.

THE additions to the Zoological Society's Gardens during the past week include a Gelada Baboon (*Theropithecus gelada* ♀) from the Province of Amara, Abyssinia, presented by H. E. Lidge, Mercha Workee, Abyssinian Envoy; a Red-crested Cardinal (*Parusaria cucullata*) from South America, presented by Mr. John W. Miers; an African Elephant (*Elephas africanus* ♂) from Abyssinia, deposited by Her Majesty the Queen; two Cape Hunting Dogs (*Lycæon pictus*) from South Africa, two Picui Doves (*Columbula picui*) from South America, deposited; a Common Cormorant (*Phalacrocorax carbo*), British, received in exchange.

OUR ASTRONOMICAL COLUMN

COMET 1884 b (BARNARD, JULY 16).—Herr Stechert of Kiel has ascertained that the apparent deviation of the orbit of this comet from a parabola, mentioned last week, is due to error in the telegraphed position on the night of discovery, and that observations between July 23 and August 10, at Algiers and Rome, are well represented by the following parabolic elements:—

Perihelion passage, 1884 August 18 <sup>h</sup> 18 <sup>m</sup> 26 <sup>s</sup> G. M. T.	
Longitude of perihelion ... ..	303 31 27 M. Eq.
"    ascending node ... ..	357 40 19 1884°
Inclination ... ..	6 52 12
Log. perihelion distance ... ..	0.140670
Motion—direct.	

Small inclination and direct motion have long been considered to favour periodicity, though we now have some striking exceptions. In the above orbit the comet, in approaching the sun, passes very near to the orbit of the planet Jupiter; thus, at a true anomaly of 240° 30', corresponding to heliocentric longitude 184°, the distance of the two orbits is less than 0.2 of the earth's mean distance from the sun, and the comet is, at this point of its track, 454 days before perihelion passage, or on the last occasion in May 1883, when the planet was far distant.

The following positions for midnight at Berlin have been calculated by Herr Stechert:—

	R.A.	N.P.D.	Log. distance from Earth
	h. m.		
Sept. 15 ... ..	19 21.4	119 23	9.8470
16 ... ..	— 25.4	119 3	
17 ... ..	— 29.3	118 43	9.8548
18 ... ..	— 33.2	118 22	
19 ... ..	— 37.1	118 1	9.8629
20 ... ..	— 40.9	117 40	
21 ... ..	— 44.7	117 19	9.8713
22 ... ..	— 48.5	116 57	
23 ... ..	19 52.2	116 35	9.8801

The above elements also give these positions:—

12h G.M.T.	R.A.	N.P.D.	Distance from Earth.	Sun.
	h. m.			
Oct. 20 ... ..	21 18.7	105 55	1.041	1.656
Nov. 19 ... ..	22 29.9	97 55	1.504	1.912

The intensity of light on October 20 is 0.34, that on November 19, 0.12, its value at discovery on July 16 being 1.16.

M. Perrotin has made the following observation:—

M.T. Nice	R.A.	N.P.D.
h. m. s.	h. m. s.	
August 15, 8 48 54 ... ..	17 13 6.79	126 28 28.4

He remarks: "La comète a l'aspect d'une nébulosité assez mal définée de 1' 30" de diamètre environ, présentant des granulations brillantes vers le centre."

KEPLER'S NOVA OF 1604.—Those who have taken interest in the actual configuration of stars near the place of the famous *Stella nova in pede Serpentarii* will be aware that Chacornac has a star of the tenth magnitude (or perhaps of the ninth, the symbol being a little ambiguous) in a position near that of the



star of 1604, where none has been since observed. It was of course desirable to clear up this difficulty, and Mr. Herbert Sadler appears to have done so effectually. He has remarked that in the part of the Chart No. 52, where the place of Kepler's star falls, the positions of a number of the brighter stars are incorrectly laid down for the professed epoch of the Chart, 1855 January 1, their right ascensions being uniformly in defect of the true ones; and he notes that, when the assigned place of Chacornac's star is corrected in right ascension to about the amount that several known stars in the vicinity require, it falls into the place of No. 16872 of Oeltzen's Argelander, so that, in Mr. Sadler's view, the stars are identical, and there can be no reasonable doubt that he is correct. It is very satisfactory to have eliminated the difficulty with regard to Chacornac's star, particularly as the place of Kepler's star can hardly be said to be comparable in accuracy with that of Tycho's star of 1572.

The following are places of three of Argelander's stars for 1855'0, on comparing which with the positions assigned on Chacornac's Chart No. 52, its distortion will be evident:—

	h.	m.	s.	N.P.D.
Oeltzen 16848 ... R.A.	17	21	19'6	112 49 47
" 16816 ... "	17	19	37'4	110 50 13
" 16782 ... "	17	18	3'3	111 16 54

**THE YALE COLLEGE OBSERVATORY, U.S.**—The fine heliometer of this Observatory is now in active charge of Dr. W. L. Elkin, who had given special study to the theory of this instrument at Strasburg, and subsequently had two years' valuable experience in the use of it, in conjunction with Dr. Gill, H.M. Astronomer at the Cape of Good Hope. From the Report to the Board of Managers in June last, it appears that the expenses attending the use of the heliometer have been guaranteed for a period of three years by ten subscribers; and Dr. Elkin, who took charge of it on January 15, is already able to report upon work accomplished, though time is necessarily occupied in the general investigations of the instrument, as scale determinations, &c. A triangulation of the Pleiades has been commenced, with the view to comparison with Bessel's measures of this group, made with the Königsberg heliometer nearly half a century ago, as well as with the later observations of M. Wolf at the Observatory of Paris; about one-third of the proposed measures had been completed before the stars were lost in the sun's rays in the spring, and it is hoped to complete the work during the last four months of the present year. A considerable amount of time has been devoted to determination of places of the moon relative to stars within measuring-distance of the heliometer, with the view to determining the parallactic inequality in the moon's motion, the deduction of which from meridian and other observations is, as Dr. Elkin remarks, attended with some difficulty. Measures of the diameter of Venus near her inferior conjunction have also been secured. There cannot be a doubt that, in Dr. Elkin's hands, most valuable results will accrue from the regular employment of the powerful measuring-instrument of Yale College Observatory. On the Board of Managers of the Institution we remark the well-known names of Profs. Elias Loomis and H. A. Newton.

**SOCIETIES AND ACADEMIES**  
PARIS

**Academy of Sciences, August 18.**—M. Rolland, President, in the chair.—Obituary discourses pronounced at the obsequies of M. Paul Thenard, by MM. Bouley and Fremy.—Observations of the small planets made with the great meridian instrument of the Paris Observatory during the second quarter of the present year, by M. Mouchez.—Essays in stellar photography, with a view to the construction of maps of the heavenly bodies, by MM. Paul and Prosper Henry, by M. Mouchez. The results so far obtained have been secured by means of an objective with a diameter of 0'16 m. and 2'10 m. focal distance. They represent on a surface of rather less than a square decimetre a section of the Milky Way of 3° of right ascension, and 2° declination, showing 1500 stars from the sixth to the twelfth magnitude. The images of these stars have a diameter nearly proportioned to their brilliancy, except the yellow stars, which appear somewhat fainter. These encouraging results have induced MM. Henry, who are skilful opticians as well as experienced observers, to undertake the construction of a much larger objective with a diameter of 0'34 m., specially adapted for photographing the celestial orbs.—Note on a new method of representing graphi-

cally the speed of railway trains, by M. Léon Lalanne.—Report on various communications relating to the cholera, by the Commissioners, MM. Vulpian, Marey, Richet, Bert, Pasteur, Bouley and Gosselin. Thirty fresh communications received by the Academy during the month of August have been examined with practically no results. Even Dr. Peyrussou's views regarding the efficacy of borax and boric acid are purely theoretic, unsupported by any practical tests.—Account of a new balloon capable of being guided in any direction and kept under control, by MM. Ch. Renard and A. Krebs. The authors claim to have solved the problem of aerial navigation by means of a new balloon of elongated form, and provided with a screw and helm, which was successfully tried at Chalais on August 9. After a trip of nearly five miles, it returned to the starting point, obeying the helm, and executing a series of manoeuvres with a precision comparable to that of a screw steamship in the water. Chief dimensions: length 50'42 m., diameter 8'40 m., volume 1864 m., total weight 2000 kilos.—Observations of the Barnard comet made at the Observatory of Nice, by M. Perrotin.—Observations on the spots and volcanic eruptions during the year 1883, by M. P. Tacchini.—Note on a fixed astronomical telescope, by M. G. Hermite.—Note on the freezing-point of saline solutions, by M. F. M. Raoult.—On the combinations of telluric acid with the salts of the bioxide of tellurium, by M. D. Klein.—Researches on the modifications produced in the nutrition of the nervous system by mania, lypemania, and epilepsy, by M. A. Mairet.—Researches on the microbe of typhoid fever in man; its cultivation, and inoculation of the virus in rabbits, guinea-pigs, poultry, pigeons, pigs, and other animals, by M. Tayon.—Note on the slow period of latent excitation in the muscles of invertebrate animals, by M. H. de Varigny.—Account of a new variety of Rhizopod found on the Archacon coast, south of Bordeaux, by M. J. Kunstler.—Note on a relation between the temperature of fusion of simple bodies and their atomic weights, by M. Chapuis. The same author presented a paper on the coincidence of seismic and meteorological phenomena with the return of the August meteoric showers.

**CONTENTS**

	PAGE
The "Encyclopædia Britannica" . . . . .	40
Letters to the Editor:—	
The Electric Light for Lighthouses.—J. Munro . . . . .	40
The Cholera Germ.—Henry B. Baker . . . . .	40
School Museums.—Rev. George Henslow; W. Hewitt . . . . .	40
The Permanency of Continents.—Rev. George Henslow . . . . .	40
Carnivorous Wasps.—Rev. George Henslow; Rev. W. Clement Ley; H. N. Dixon; William White; Thomas Edward; E. F. Bates . . . . .	40
Fireballs.—W. G. Smith . . . . .	40
A Cannibal Snake.—Dr. C. F. Crehore . . . . .	40
Water Bells. (Illustrated) . . . . .	40
Science and the Sandhurst Examinations . . . . .	40
The British Association:—	
Inaugural Address by the Right Hon. Lord Rayleigh, M.A., D.C.L., F.R.S., F.R.A.S., F.R.G.S., Professor of Experimental Physics in the University of Cambridge, President . . . . .	41
Section A—Mathematical and Physical Science—Opening Address by Prof. Sir William Thomson, M.A., LL.D., D.C.L., F.R.S.S.L. & E., F.R.A.S., President of the Section—"Steps towards a Kinetic Theory of Matter." (Illustrated) . . . . .	41
Section B—Chemical Science—Opening Address by Prof. Sir Henry Enfield Roscoe, Ph.D., LL.D., F.R.S., F.C.S., President of the Section . . . . .	42
Section D—Biology—Opening Address by H. N. Moseley, M.A., F.R.S., Linacre Professor of Human and Comparative Anatomy in the University of Oxford, President of the Section . . . . .	42
Notes . . . . .	42
Our Astronomical Column:—	
Comet 1884 b (Barnard, July 16) . . . . .	43
Kepler's Nova of 1604 . . . . .	43
The Yale College Observatory, U.S. . . . .	43
Societies and Academies . . . . .	43

THURSDAY, SEPTEMBER 4, 1884

## FUNGI AND BACTERIA

*Vergleichende Morphologie und Biologie der Pilze, Mycetozoen, und Bacterien.* By A. De Bary. (Leipzig: Engelmann, 1884.)

THOSE of us who have been awaiting the publication of a new edition of De Bary's "Morphologie und Physiologie der Pilze, Flechten, und Myxomyceten" of eighteen years ago, will be neither surprised nor disappointed to find that the author has felt compelled to change the title as well as to effect such important alterations in the text that the book is not only virtually but really a new one. This is, moreover, extremely satisfactory, since it shows that the province of mycology has been extended during the period named. How far this extension is due to the labours and influence of the writer of the book before us is well known to all botanists.

In some respects the general plan of the old book has been followed, and many of the woodcuts have been retained; but the large and at that time important section on the reproductive organs in the previous edition is no longer to be found as a separate part of the present book, the results of more recent investigations having completely altered the position of the question as to the sexual reproduction of the Fungi. This fact is of course also a motive in the very different views on classification held by the author now, as contrasted with those published in the earlier book. These and the addition of the Bacteria as an entirely independent group of organisms, are among the principal points of difference in the general plan of the book. That they are by no means the only changes in plan, however, is to be seen at a glance on comparing the two editions.

The present work is divided into three "Parts," devoted to the Fungi, the Mycetozoa (Myxomycetes), and the Bacteria respectively. Under the Fungi proper, there are three chapters devoted to "General Morphology," including Histology, the Segmentation of the Thallus, and the Morphology of the Spore; the latter being very fully treated of, and many new facts being added. The second part deals with the groups of Fungi themselves, and their evolution; the theoretical portions of Chapter IV. being extremely comprehensive and clear, and touching upon matters of the widest biological interest. Chapter V. deals with the various groups comparatively and in detail. Starting with the Peronosporæ, the author follows the series through the main Ascomycetous series to the Uredinæ, in conformity with his now well-known views on the classification, dealing by the way with those groups which diverge from the main series or are still doubtfully situated.

The third part of the main subject (Chapters VI. and VII.) is devoted to the physiology of the Fungi, including the phenomena of parasitism and the commensalism of the Lichens, and bringing us through by far the larger part of the book.

The *Mycetozoa* (Chapters VIII. and IX.) occupy nearly 40 pages of most interesting matter, including a discussion as to the position of these remarkable organisms, and an account of what is known as to their physiology.

The *Bacteria* or Schizomycetes are dealt with separately and in detail at the conclusion of the book. Chapter X. is devoted to their morphology, and discussions as to their position in the system, and the meaning of "species." A sharp comparison of the extreme views on this subject is dealt with shortly, and in the author's characteristic style. Probably the most fascinating chapter in the book (unless Chapter IV. be excepted) is the last one, dealing with the physiology and life-history of the Bacteria, and of course touching the subjects of pathology and adaptation to different media and conditions with a master hand; and it will be an enormous boon, and should be a stimulus, to have the facts as to the resistance of germs, conditions of development, &c., of these important organisms sifted by an author of such wide experience.

Enough has been said to show that the present book is rather to be considered as a new work than as a second edition of the "Morphologie und Physiologie der Pilze, &c." But it is not only in that so much new matter has been added and a different arrangement been found necessary that this book differs from the former one; the theoretical portions have also undergone changes even more striking and important than the statements of fact. To put the subject in the shortest possible form:—While the then recent discoveries of Pleomorphism and the reproductive organs by Tulasne and De Bary were leading mycologists to suspect that a reproductive process exists in the case of all the higher Fungi, the prominent doctrine, so to speak, in the older work was in accordance with the expectations which had been aroused. Nevertheless, no better monument to the sagacity of the author could perhaps be suggested than his careful statement of the case of the sexuality of the Ascomycetes, even in 1866.

It is well known now that the investigations of the last eighteen years have gone to show that not only do the reproductive organs gradually become simpler and finally disappear in the higher Fungi, but that the physiological processes intrusted to them fade away even earlier—the former depending on the latter, in fact. This doctrine of Apogamy, established by De Bary, of course profoundly affects the work before us. The whole subject of Pleomorphism is also now in a far better position, and we strongly recommend all young botanists to read and mark well the introduction (Chapter IV.) to the second section of this book, which contains much just and trenchant criticism on all these matters, and on past mistakes and future dangers connected with them. The notes on terminology should also be well pondered by the more reckless.

It would take too long to enter further into details as to the classification adopted. It may suffice to point out that the *Peronosporæ* (and *Ancylistæ* and *Monoblepharis*), *Saprolegnia*, *Zygomycetes*, and *Entomophthoræ* are treated as four groups, which, on account of their relations to the Algæ, may be comprehended as the *Phycomycetes*. The main line of the *Phycomycetes* leads us to the *Ascomycetes*, and, further, to the *Uredinæ*. The treatment of the enormous mass of *Ascomycetes* is masterly in the extreme, and testifies better than anything else to the progress made in the biology of these Fungi during the last twenty years. The groups mentioned are regarded as the "Ascomycetous series."

As diverging groups, or such the position of which is

still doubtful, De Bary classifies the *Chytridea*, and *Protomyces*, and *Ustilaginea*, all considered as allied phylogenetically with the *Phycomycetes*; and a series of doubtful *Ascomycetes* (e.g. Eidam's *Helicosporangium*; also *Exoascus*, *Saccharomyces*, &c.), obviously to be placed next the *Ascomycetes* proper. Finally, the huge group of the *Basidiomycetes*, which De Bary regards as connected with the *Uredineae*, though it is not an easy matter to satisfy one's self of the alliance.

The rigour with which the literature has been sifted is shown in the references given at the end of each section. There is no doubt that Prof. De Bary may be congratulated on once more having written a work which will be a monument to his skill and industry, and a boon to all biologists.

#### OUR BOOK SHELF

*A Monographic Revision and Synopsis of the Trichoptera of the European Fauna. First Additional Supplement (with Seven Plates). By Robert McLachlan, F.R.S., F.L.S., &c. (London: Van Voorst, 1884.)*

FOUR years ago, in the preface to his very important and elaborate "Monograph of European Trichoptera," Mr. McLachlan promised to continue from time to time the supplemental notices of which the necessity of the case had already caused two to be appended to the original work. The first of these has just (June) been published; it adds nearly fifty species to those described in the Monograph and its Supplements. Some new forms are noticed to which it has seemed right to assign the rank of varieties, and there is a great deal of additional information as to localities. While all the species in the original work have been passed under review, in one or two instances those belonging to some genera have been thoroughly revised. Very few new genera are indicated, and the author thinks the time has not yet arrived for a complete subdivision of some of the larger generic groups as now constituted. All but six of the additional species are from within the limits of Europe proper, proving how hazardous it would be to conjecture as yet as to the number forming part of the European fauna. While ready and liberal help has been afforded towards the work of this Supplement by many of the author's friends and correspondents, yet it is by one above all the others that the material for it has been accumulated; for to the labours of the Rev. A. E. Eaton in Italy, Portugal, Madeira, the Canary Islands, and elsewhere, the author stands indebted for more than three-fifths of the new species, and though Mr. Eaton is well known as an acute, indefatigable, and successful entomologist, does the remark press less home that "if a foreigner making short holiday tours through certain districts previously unexplored (so far as the Trichoptera are concerned) can produce such results, it is needless to call attention to what *might be done* by residents in the districts"?

Among the genera which have been revised we note *Sericostoma*, which it is now proposed to divide into two groups, *i.e.* (A) with the Maxillary palpi in the male very prominent and scarcely hairy; and (B) with the Maxillary palpi in the male slightly prominent and very hairy.

Additional and valuable information is given concerning the singular forms belonging to the genus *Helicopsyche*. The author now acknowledges three European species, while he seems to think that the number will yet be greatly increased. The three species at present stand as *H. speruta*, *H. lusitanica*, and *H. revelieri*. The last species equals *H. skuttleworthii*, and was bred in large numbers by M. Revelière, who found the larvæ in very great abundance in a stream near Porto Vecchio, Corsica. The imago is to be found all the year round, but it seems to

require a certain degree of warmth for its emergence, which is always effected in the daytime. The larvæ and pupæ can exist in a very scanty supply of moisture; indeed some specimens which were left untended for many days were found quite active though all the water had evaporated from them, and the sand in which they were was only moist. The building material of the helix-like cases is fine sand-grains; each case forms fully two and a half whorls; the cement-like substance used to bind the sand-grains together is often applied so thickly that the individual grains are inconspicuous.

In the genus *Setodes*, Mr. McLachlan has discovered a character in the posterior wings which (with others) enables the species of the genus as it now stands to arrange themselves into two sharply defined groups (which will be hereafter considered genera). This character is the presence or absence in the posterior wings of a fold above the apical fork known as No. 5. *S. punctata* and its allies belong to the group in which the fold is absent, while *S. lineiformis*, Curt., &c., belong to the group with the fold.

This "First Additional Supplement" is illustrated by seven plates engraved from the author's drawings in a very creditable manner by Mr. G. Jarman. As the necessities of the case arise, we are promised a "Second Additional Supplement," which will be as gladly welcomed by those taking an interest in this group of insects as the present one is sure to be.

#### LETTERS TO THE EDITOR

[The Editor does not hold himself responsible for opinions expressed by his correspondents. Neither can he undertake to return, or to correspond with the writers of, rejected manuscripts. No notice is taken of anonymous communications.]

[The Editor urgently requests correspondents to keep their letters as short as possible. The pressure on his space is so great that it is impossible otherwise to insure the appearance even of communications containing interesting and novel facts.]

#### Lœwy's New Telescope System

IN the June number of the *Bulletin Astronomique* there is an important article by M. Lœwy entitled "Description d'un nouveau Système de Téléscope," on which, with your permission, I would offer some remarks.

M. Lœwy gives the two possible dispositions or arrangements that allow the principle of the *equatorial condé* to be applied to the reflecting telescope. He assumes certain optical and mechanical conditions, and on these treats the question exhaustively, giving tables showing the different sizes of the mirrors required and other data obtained by the use of formulæ based on those conditions.

The practical difficulties are also dealt with and suggestions made for forms of mountings. There is also a suggestion of the MM. Henry to close the mirrors from the open air by means of a parallel plate of glass to protect them from the effects of dust, moisture, &c.

This subject has a particular interest for me (as I have no doubt it has also for many others), and I have considered for some time the mechanical difficulties from a different point of view from that of M. Lœwy, coming thereby to conclusions differing considerably from those given by him. There is, of course, much to be said on such a subject as this, involving as it does so many points that can be dealt with in so many different ways, and some of these I should much like to say more on by and by; but at this holiday time of year I will only offer the following observations:—

1. It is of the first importance to reduce as much as possible the distance ( $\delta$ ) between the middle mirror of either optical combination or disposition and the focal plane.

2. By placing the upper bearing of the polar axis below instead of above the cross tube of either disposition, all the mechanical conditions that M. Lœwy has used can be advantageously varied.

3. The use of the floating polar axis described by me in the May number of the *Monthly Notices* of the Royal Astronomical Society enables this to be done.

4. The shelter of the observer can then be quite detached from and independent of the telescope.

In the description of the floating polar axis referred to above, I mention its suitability for that disposition where one large and one small mirror is used.

My reason for not then mentioning the second disposition (that in which two large plane mirrors are used, one of these being perforated) to which this polar axis is most particularly adapted, was fear of stepping too far at once, as, apart from the additional difficulty of making a large plane perforated mirror, there seemed to me to be an element of risk and uncertainty in its use. After reading this article by M. Lœwy, I think there may not be much in my objections, but I cannot quite satisfy myself. In dealing with the support of the large plane mirror in the disposition that I allude to in the description of the polar axis, I contemplated such an arrangement for it as I have in use with my three-foot mirrors, this answering, as far as I have been able to see, perfectly, in eliminating flexure, and as the back of this large plane mirror would never wholly leave its supports, there would not be any fear of flexure here; the other mirrors offer no difficulty as they are practically as in an ordinary *Newtonian* telescope. The support of the large plane perforated mirror, when used for any latitude higher than 45°, is not easily obtained; it must rest on a rim touching the face all round, hence unless it could be hung up from the back in some way it might bend down and spoil the image.

It may be that the slight angle it would make would not bring in flexure of an injurious kind, and this could be determined by actual experiment beforehand, but at present it is an open question.

If it is not a difficulty, then I should agree with M. Lœwy that this is the best disposition for many reasons—it dispenses with the supports of the small mirror that cause diffraction rays, not objectionable to the observer except on bright objects, but very much so in a photograph, where they can impress themselves from an eighth or ninth magnitude star with any exposure that would be used for a nebula; it gives better support to the concave mirror; difficulties in connection with the reversal of the instrument do not come in with such force, and, most important of all, with such a polar axis as I have described, the focal plane might be kept very close behind the large perforated mirror, giving advantages of the greatest importance from many points of view.

The covering of the mirrors by a plate of glass has already been suggested and tried, but in a way that determined nothing. It is a capital thing to do; only experiment could really decide. Certainly flexure could be got over by air pressure, and it would be worth any trouble to get it, if not injurious to the image.

Ealing, August

A. AINSIE COMMON

### Earthquakes in Japan

In the one hundred and seventy-first volume of the "Konrui Shinko-Kushi," one of the oldest and finest works on Ancient Japan, there are tables giving the number, intensity, and remarkable characteristics of all the earthquakes which occurred in Japan between the years 416 and 886 A.D. Unfortunately, the few extant copies of this most important compilation are all more or less in a fragmentary condition. It is, however, evident from the context that the author intended to, or actually did, enumerate many more of these natural phenomena, and it is highly probable that many of his original notes have been lost with the rest; but even as it stands the work is of undoubted importance, now that the Seismological Society of Japan has been doing all in its power to bring forth the ancient records which refer to the great earthquakes of the past. As every one knows, Japan is the very hearth of earthquakes; in 1854 more than 60,000 people lost their lives in consequence of one of these great terrestrial catastrophes, and it has been calculated that from ten to twelve earthquakes, each lasting several seconds, occur every year, besides numerous others of too slight a nature to be worthy of remark.

The earthquakes mentioned in the work under consideration begin with that which took place in the fifth year after the coronation of Inkiyo Tenno (A.D. 416), and end with the one in the fifth year of Koko Tenno (A.D. 886). Earthquakes occurred during this period of 470 years on 640 days, but that by no means gives the probable total. It seems that those which are noted on the 640 days were all of sufficient importance to deserve particular mention. The great care taken by the compiler in

his tables is evident from the fact that the exact date and time of each earthquake is given. Kiyoto was then the capital of Japan, and most of the earthquakes mentioned took place in the then Imperial City, 626 out of the total 640. Those not felt in Kiyoto are spoken of only when unusually intense, in which case the exact locality and amount of damage caused are given. Quite recently the vernacular Japanese press, in consequence of some lately published returns bearing on the subject, has devoted considerable attention to investigating the annals of the "Konrui-Shinko-Kushi," in hopes of being able to ascertain if earthquakes of certain intensity recur at certain periods, in fact, they have attempted to prove that earthquakes run in well-defined cycles. This is by no means a novel nor even very modern idea. Wernich, in his "Geographische-medicinische Studien," says that severe earthquakes occur in Japan every twenty years. In a footnote he adds:—"I am unable to adduce any natural or physical proofs in behalf of this hypothesis. And yet the Japanese earthquakes can be very readily explained by the theory of 'periodical phenomena.' They are commonest at the times of the highest tides, and in the months of January, April, and October."

Whatever may be the truth of the suppositions and theories, the Japanese journals, both the scientific and the dailies, have gone to work by accepting the periodicity of these phenomena. Taking ten years as the divisor, they divide the time between A.D. 628 (when the records begin to be more trustworthy) and A.D. 886 into twenty-six periods. The following table is the result:—

Periods	Earthquake days	Periods	Earthquake days	Periods	Earthquake days
2	0	10	6	19	3
3	3	11	5	20	56
4	0	12	29	21	39
5	1	13	3	22	18
6	2	14	0	23	104
7	15	15	11	24	87
8	1	16	22	25	95
9	0	17	10	26	100
	3	18	9		

It is very evident from the foregoing that the records are far from being as exact as could be desired with regard to the earlier centuries, or else that the physical condition of the country in 886 was totally different from that of 628 A.D. But to return to the table, it will be seen that the intervals between the periods in which earthquakes were most frequent are as follows:—40 years between the 2nd and 6th periods, 60 years between the 6th and 12th, 40 years between the 12th and 16th, 40 years between the 16th and 20th, and 30 years between the 20th and 23rd. Acting on the supposition that one period of unusual frequency of earthquakes has been left unrecorded, the average length of the intervals is estimated at 35 years. Following the author's explanatory notes, a still more correct table can be deduced, by means of which the cycle of earthquake intensity is finally put at 33½ years. A further deduction is made that earthquakes of a disastrous nature occur once every 59 years, so the next great catastrophe may be expected in 1913.

As the notes of the compiler give the date of each earthquake between the above-mentioned years, it appears that earthquakes used formerly to be most frequent in August, most severe in May and November, and followed or preceded by violent hurricanes, electric storms, and the like in January; 55 per cent. of all Japanese earthquakes occurring during the warm season.

Yokohama

P. WARRINGTON EASTLAKE

### "Udschimya sericaria," Rond., a Fly Parasitic on the Silkworm

I HAVE been engaged during the past year in tracing the life-history of *Udschimya sericaria*, Rond., and have succeeded in making it out completely. I send you a short account of it, hoping that it may not be entirely uninteresting to your readers. As you are no doubt aware, in Japan and China the maggot of this fly does great damage every year to the larvæ and pupæ of the silkworm, sometimes 80 per cent. of the caterpillars and pupæ being killed. The knowledge of its life-history would therefore be of great economic interest as furnishing the scientific basis for guarding against this parasite. Strange as it may seem, no one has, however, until recently, made any systematic observations on the matter.

In 1874 my father, Mr. N. Sasaki, who was the first to study this insect, found its larva in the main trunk of the trachea of the silkworm, just inside the stigma, and finally concluded that the

maggot gained this place by entering through the stigma from outside.

My investigations extend from April 1883 to June of this year, and are briefly summed up as follows:—

*Udchimya sericaria* appears generally in the middle of April, and attains maturity in the beginning of May, at the time when mulberry-trees expand their spring leaves. The female flies, flying in bushes of mulberry-trees during the months of May and June, deposit their eggs on the under surface of the leaves in close contact with the mid-rib, or else with the fine ramified veins.

The eggs are nearly oval in shape, tapering at one end, and rounded at the other. They are very small in size, measuring 0·18 mm. in length, and 0·13 mm. in breadth, and generally convex on the upper and flat on the under surface. The upper convex surface, which is coloured blackish-brown, has a lustre, and is marked out into hexagonal areas; while the lower flat surface, which is coloured grayish-brown, lacks lustre, and is only faintly marked out into hexagonal areas. The whole egg is enveloped with a sticky substance, which fixes it firmly with its flat side on the under surface of the leaves.

When the leaves on which the eggs are thus deposited are given to the silkworms, they eat them whole along with the leaves, without crushing them at all. At one to six hours after the eggs are taken, they are hatched out near either end of the digestive canal, and a tiny white maggot comes into existence. After a while the maggot passes out of the alimentary canal through the mucous membrane, with the aid of its horny hooked tooth and of setæ provided on each segment, and enters directly into one of the nervous ganglia found just under the digestive canal. A thin transparent membrane which envelops the ganglion becomes a protecting sac, inside which the maggot lives, and takes nerve-cells as its food. As it grows in size, this sac gradually enlarges, and finally rupturing, the maggot passes out into the body-cavity. At this time it measures five to six millimetres in length.

The maggot now seeks the main stem of the trachea, which forms a kind of chamber just inside the stigma of the silkworm, and enters into it by making an opening with its hooked tooth. It now sticks its head out into the body-cavity of the silkworm through the opening by which it entered, and takes fat as its food. Its posterior end, which is provided with two large spiracles, is directed towards the stigma, and thus the maggot respire the air which passes in through the latter.

As the maggot grows, this newly-formed chamber in which it rests also becomes larger, and the opening through which the anterior end of the maggot is projected out into the body-cavity of the silkworm becomes wider and wider, until the chamber assumes the shape of a cup. Around this cup a large amount of fat is fixed by the maggot, probably with a watery fluid it secretes of alkaline reaction, and thus the wall of the cup increases in thickness and becomes very tough. The wall is always coloured dark brown, owing probably to the feces of the parasite and to the action of the secretion upon the fat in the wall of the cup. In this position the maggot attains maturity; it then crawls out through an opening it makes at any portion of the body of its host. If, however, the growth of the maggot has been slow, it may be found in the trachea of the silkworm after it has changed into a pupa.

In either case, whether the larvæ or the pupæ have the parasite in the trachea, the space around the stigma, inside which the maggot is lodged, is always marked with a large dark brown patch, so that the presence of the maggot is easily recognised by looking at the stigma.

If a larva or a pupa of the silkworm is once infested by this parasite, its fate is sealed, and the cocoons made by the infested caterpillars are usually thin, and of much less value.

Those maggots which become mature in the pupæ of the silkworm crawl out of the cocoon by making a round opening at one pole, and such perforated cocoons are entirely useless for reeling silk.

The mature free maggot, coloured light yellow, is very active, and searching for the corner of the case in which they are kept, or crawling deep into the ground, changes soon into a black, cylindrical pupa. There the pupa rests through the winter, and in the following spring a perfected fly hatches out by breaking open the pupa-case.

A detailed account with suggestions for the remedies will soon be published in a *Memoir* of the University of Tokio.

C. SASAKI

University of Tokio, July

### Singular Instance of Instinct

AMONG the insects very common to Victoria is one popularly known as the mason-fly. In form it is very like a gigantic hornet; the wings and legs are of an orange colour, as is also the abdomen, which is decorated with broad black stripes. It has a strange habit of building its nest, composed of tempered mud, in keyholes. Mr. Ellery, F.R.S., the Government Astronomer, tells me that this same fly often commences to build within the tubes of their astronomical instruments. The nest is rather peculiar. A layer of mud is first laid down, and a certain number of eggs are laid. Then follows another layer of mud; on this are deposited a number of young spiders, paralysed but not killed. Another layer of mud, more eggs, then mud, then spiders again, and so on, until the nest is complete. The spiders are evidently stored up as food for the grubs, as soon as hatched, an arrangement already known to naturalists. This fly has a very fierce aspect, and its nature evidently does not belie its looks. It flies about with great liveliness, and when alighting, its long black antennæ are kept in a state of constant motion. Its favourite food seems to be spiders, which it is in the habit of seeking for under the bark and in holes in the trunk of the Eucalyptus. In order to catch them it burrows under the loose bark, and in a few seconds generally issues forth again with some large or smaller prey between its mandibles. The enormous bulk of some of the victims does not appear to intimidate it in the least. Even the gigantic so-called tarantula (vulgarly triantelope) is fearlessly attacked. I was one day walking through a suburban park near Melbourne, and saw one of these flies suddenly pounce down on the back of a large tarantula some five inches in breadth, measuring from the ends of the legs. The huge arachnid succumbed at once. Resistance with an adversary in such a position was altogether out of the question, the only resource being to die, like Caesar, becomingly. I watched the fight, or rather the murder, for some minutes, and then touching the assailant with the point of my umbrella, drove it away. It only flew, however, to a short distance, and then returned, flying so viciously round that I fully expected I should be attacked. By flourishing the umbrella, however, I again drove it off, and it retired to a distance of about a hundred feet. I then left the spider, but afterwards went back, and found the mason-fly following up his victory as energetically as ever. I drove it away again, left the spot, and again returned to find the murderous work still going on. This was repeated some half a dozen times, and at last, taking out a book, I sat down on a seat resolving to see what would happen. The fly did not reappear for nearly a quarter of an hour, and I thought it had altogether departed. A small ditch ran beside the pathway, and, turning my eyes in that direction, I noticed the mason-fly peeping through some blades of grass growing on the edge. It was evidently waiting for me to leave the spot in order to secure the full advantages of its victory.

It may be mentioned that the tarantula is a great coward. Some of our large spiders, if placed on an ants' nest, will "run amuck" through the crowd, nipping with their immense mandibles scores of their assailants who may approach them. They will do this several times in succession, and generally get away. The tarantula, however, if placed in such a position, yields at once, and, gathering up its long legs, expires with all dignity. I have tried the experiment many times, when a run of six inches would have secured the freedom of the tarantula, but even in these cases no effort was ever made to escape. One species of spider, living under the bark of trees, the skin of the abdomen of which is very soft, often proves a match for the ants, not by fighting, but by stratagem. He plays his enemies a thoroughly Parthian trick, throwing out a number of webs, which completely entangle them. This same spider, if thrown into a pool of water, similarly throws out threads of web, and, these being wafted to the shore, and adhering to an overhanging branch, enable the spider to reach the land. THOMAS HARRISON

244, Victoria Parade, East Melbourne, Victoria, July 9

### Przevalsky's Horse

IT seems worth while to point out the close resemblance between the figure of this horse in NATURE for August 21 and those found incised on antlers in the cave of La Madelaine, copied in Dawkins' "Early Man." There is the same massive head, the same hog-mane, absence of forelock, pointed ears, short body, and powerful legs, while there seems even an indication that the long hairs of the tail spring first from the middle of that

organ. In that from Cresswell Crags, as well as those from La Madelaine, the jaw is heavier than in the recent specimen.  
Broseley, August 29

W. W. WATTS

#### "The Ores of Leadville"

MY attention has lately been drawn to a review in NATURE for April 17 of a work on "The Ores of Leadville and their Mode of Occurrence," by Mr. L. D. Ricketts, from which one would be led to suppose that all the facts mentioned were due to original investigation on the part of the author. Your reviewer does not state that which is acknowledged by the author himself, namely, that much of his information was obtained from the Report of the U.S. Geological Survey by Mr. S. F. Emmons, contained in the Second Annual Report, published a year previously.

A large atlas has lately been issued also by the U.S. Geological Survey completely illustrating the Leadville ore deposits, and an exhaustive monograph to accompany it is now in the printers' hands. I speak from an intimate knowledge of the subject, having taken part in the work, and should be much obliged by your inserting this correction without delay.

ERNEST JACOB,

Late Assistant Geologist U.S.G.S.

2, Beachfield Terrace, Penzance

#### AUSTRALIAN ORCHIDS

THE seventh and last part of vol. i. of Fitzgerald's "Australian Orchids," and the first part of vol. ii. have lately reached us. The testimony we bore to the value and merits of this work in our notice of part 5, vol. i. (NATURE, vol. xvii. p. 53) we can now repeat, and with emphasis, as we can base it on an examination of all the parts at present issued.

Mr. Fitzgerald is an ardent admirer and disciple of Darwin—indeed what true lover of orchids is not?—and his work is dedicated to his memory "as a token of the veneration in which he holds that great naturalist and fearless expounder of science." The synopsis shows that twenty-eight genera and 104 species are illustrated and described in vol. i., each part containing ten folio lithographic plates. The drawings and dissections leave nothing to be desired in point of fulness, completeness, and accuracy, the latter especially being far more numerous and varied than in any similar work we are acquainted with. There is one point on which those who are responsible for the nomenclature of Australian orchids are entitled to decided praise. All but one of the genera and 90 out of the 104 species in vol. i. bear really descriptive names, instead of being christened after "enterprising," or rather advertising, nurserymen or vanity-stricken cultivators, which is unfortunately the fate of most of the new orchids introduced into England. A large proportion of the orchids as yet described in this work are natives of New South Wales, but a few are contributed by Western Australia, Queensland, South Australia, and Tasmania. The enormous importance of insects to the maintenance of orchids is shown by the fact that, out of 104 species described in vol. i., ten only are self-fertilising. But the curious point is noted by the author that "self-fertilising species always produce a far greater proportion of seed." The difficulty with which some genera undergo fertilisation is illustrated by an instance given where a splendid plant of *Dendrobium Hillii* in the Sydney Botanic Gardens, freely open to insects, did not produce a single seed, though covered with about 40,000 flowers on 190 spikes! In another case mentioned by the author he found a small caterpillar on a flower of *Dendrobium speciosum*, which had partly eaten an adjoining flower. He marked the latter, and the flower so marked was the only one on the entire plant which produced seed. There is strong evidence that many species are dependent, not simply on insects, but on some particular, perhaps local, insect for fertilisation. *Sarcochilus parviflorus* often produces seed capsules in

its native habitat, the Blue Mountains; if removed to Sydney, it flowers well, but does not produce seed unless artificially fertilised. One question discussed by the author is the fertility of hybrid orchids. We believe that this question has been settled in English plant-houses, where hybrids have been proved to be fertile in the case of one genus (*Cypripedium*) at all events. This result is what Mr. Fitzgerald anticipates, on account of the facility with which species of the same genus may be cross-fertilised, however far apparently they may be removed from one another. As he says, "a repugnance to intermixture does not exist in this family as it does in others."

While terrestrial orchids are very numerous in Australia, epiphytal orchids are comparatively rare. The latter are more ordinarily denizens of the hot and moist forests of tropical or sub-tropical regions. Thus not more than one-fifth of the species illustrated in Mr. Fitzgerald's work are epiphytal, and these belong almost entirely to the genera *Sarcochilus* and *Dendrobium* the latter a genus of which there are probably two or three hundred species, mostly natives of Indo-Chinese regions, cultivated in this country. On the other hand, the author says:—"The centre of the terrestrial" (orchids) "may, I think, be placed in Sydney, where, within the radius of a mile, I have obtained 62 species of orchids, 57 of which were terrestrial—a number that could not, I believe, be equalled in any part of the world within a similar area."

The plates are accompanied by full descriptions giving curious and interesting details as to the methods of insect-fertilisation, and describing localities, surroundings, conditions of growth, &c. Notwithstanding the help derived from this source, Australian orchids have not, with some few exceptions, proved readily amenable to cultivation in this country. While it is comparatively easy to reproduce climates resembling those of the damp, shady, and hot valleys of the Amazon or of Burmah, or of the moist, cloud-covered, and cool slopes of the Andes or the Himalayas, it is very difficult to reproduce the dry, hot, and sunny conditions favourable to most of the terrestrial orchids of Australia. We shall therefore probably continue to know these for some time at least mainly from Mr. Fitzgerald's book. We doubt whether, excellent and obviously faithful as his drawings are, and carefully as they are coloured, the use of toned paper is judicious. It imparts a muddiness to the tints, as, for example, in the drawing of the beautiful *Dendrobium*, *Phalenopsis*, and *Superbiens*, part 7, vol. i., and part 1, vol. ii., where neither foliage nor flower have the clear bright colours natural to them.

Before concluding this notice of a work which devotes much attention to the curious and interesting study of orchid fertilisation, we might refer for a moment to the patience, care, and intelligence with which the raising of hybrid orchids is being prosecuted in this country, especially in the nursery of Messrs. James Veitch and Sons. In one genus, that of *Cypripedium*, the hybrids bids fair already to outnumber the known natural species, as well as to rival them in interest and beauty. The closely allied genera *Cattleya* and *Laelia*, which are distinguished only by the number of their pollen masses, have proved susceptible of cross-fertilisation, and have produced several intermediate hybrids of great beauty. It may well be said that patience is necessary for this work, for *Cattleya exoniensis*, the offspring of *Cattleya Mossiae* and *Laelia purpurata*, did not flower until seventeen years after the seed had germinated. Even now it is only propagated by subdivision. The union of the genera *Calanthe* and *Limatodes* was more speedily fruitful; and the beautiful *Calanthe Veitchii*, especially valuable horticulturally, from its winter-flowering habit, is known in most gardens.

Few who have devoted themselves to the study or to the cultivation of orchids have failed to become greatly interested in this remarkable family. Their singular

structure, their extraordinary variety and diversity, their beauty, form great attractions. To these may now be added the interest, indeed excitement, to be obtained by intelligent and judicious cross-fertilisation. Altogether we need not wonder that the cultivation of orchids is spreading rapidly among the garden-loving people of these isles. For they interest equally the man of science and the gardener. We trust that Mr. Fitzgerald may bring his labour of love to a successful termination, and that descriptions of the orchids of other parts of the world, equally complete, accurate, interesting, and intelligent, may be taken in hand by botanists equally competent and enthusiastic.

T. L.

### GRINNELL LAND

THE following is the *Times* report of the paper read by Lieut. Greely at the British Association on Tuesday on some of the results of his recent Arctic expedition:—

Lieut. Greely stated that the geographical work of the Lady Franklin Bay Expedition covers nearly 3° of latitude and over 40° of longitude. Starting from lat. 81° 44' N., long. 84° 45' W., Lieut. Lockwood reached, on May 18, 1882, on the north coast of Greenland, lat. 83° 24' N., long. 40° 46' W. From the same starting-point he reached to the south-west, in May 1883, in Greely Fjord, an inlet of the Western Polar Ocean, in lat. 80° 48' N., long. 78° 26' W. The journey to the northward resulted in an addition to our charts of a new coastline nearly 100 miles beyond the furthest point seen by Lieut. Beaumont of the Royal Navy. It also carried Greenland over forty miles northward, giving that continent a much greater extension in that direction than it had generally been credited with. The furthest point seen on the Greenland coast was estimated at about lat. 83° 35' N., long. 38° W. There were no indications that the furthest point seen was the northern termination of Greenland. The newly-discovered coast resembled in many respects that of Southern Greenland; the mainland was intersected by many deep fjords, with numerous outlying islands. The interior of the country, as seen from an elevation of some 2000 feet, consisted of confused masses of mountains, eternally snow-clad or covered with ice-caps. The fjords presented to the eye nothing but broad, level expanses of snow and ice, being devoid of any marked ice-foot, floebergs, pressed-up hummocks, or any other indications tending to prove their direct connection with the Spitzbergen Sea. In general, the immediate coast was high, rugged, and precipitous; the formation very like that around Discovery Harbour—schistose slate, with a sprinkling of quartz. The vegetation resembled closely that of Grinnell Land. Among the specimens brought back is the Arctic poppy. Several saxifrages were identified above the 83rd parallel. Traces of the Polar bear, lemming, and Arctic fox were seen. A hare and ptarmigan were killed at the furthest north, and the snow bunting was heard. A remarkable fact noted was the existence of a tidal crack—so called for lack of a better name—which extended from Cape Bryant along the entire coast, running across various fjords in a direct line from headland to headland, varying from one yard to several hundred yards in width. Inside the crack, rough hummocky ice was but rarely seen, while outside prevailed the palæocrystic ice, over which Commander Markham struggled so manfully and successfully in his wonderful journey of 1875, midway between Capes May and Britannia. A sounding was made, but no bottom was found at 800 feet. Apparently no current existed. It may be well to state that the latitude of the furthest northern point, Lockwood Island, was determined by a set of circum-meridian and sub-polar observations, which were reduced by the Gauss method. The latitude of Cape Britannia and several other points was

determined by circum-meridian observations. It affords me pleasure to testify to the accuracy of Lieut. Beaumont's maps; the only correction made places Cape Britannia a few miles south and Cape May a few miles west of their assigned positions. These points were located by Lieut. Beaumont from bearings. His comparative exactness was remarkable considering the disadvantages under which he laboured. The journeys made by Lieut. Lockwood and myself across Grinnell Land into its interior revealed striking and peculiar physical conditions which have been hitherto unsuspected. Between the heads of Archer and Greely Fjords, a distance of some seventy miles, stretches the perpendicular front of an immense ice-cap, which follows closely from east to west the 81st parallel. Its average height was not less than 150 feet. The undulations of the surface of the ice conformed closely to the configuration of the country, so that the variations in the thickness of the ice-cap were inconsiderable in about sixty miles. But two places were found where the slope and face were so modified as to render the ascent of the ice possible. This ice-cap, extending southward, covers Grinnell Land almost entirely from the 81st parallel to Hayes Sound, and from Kennedy Channel westward to Greely Fjord on the Polar Ocean. The glacier discharging into Dobbin Bay is but an offshoot of this ice-cap. Without doubt glaciers can be found at the head of every considerable valley debouching into Richardson, Scoresby, or other bays. Several valleys which were visited during the retreat southward displayed at their entrances evident signs of such occupancy in the past. In July I was fortunate enough to ascend Mount Arthur, the summit of which is 4500 feet above the sea. The day was very clear; to the northward of Garfield Range a similar ice-cap appeared to view, from which extensive glaciers projected through every mountain gap. One of these, Henrietta Nesmith Glacier, had been visited by me in the preceding April, and was found to have a perpendicular face of about 200 feet. It discharged into a small bay, part of Lake Hazen. Gilmar, Abbé, and other glaciers feed the streams which empty into that lake. Similarly glaciers were found at the head of the rivers discharging into St. Patrick and Lincoln Basins, Norris Bay, and Discovery Harbour. From these indications I estimate the northern ice-cap of Grinnell Land as not far from 6000 miles in area. This southern limit closely coincides with the 82nd parallel. The country between the 81st and 82nd parallels, extending from Kennedy and Robeson Channels to the Western Polar Ocean, was found in July entirely free from snow, except on the very backbone. In over 150 miles travel into the interior my foot never touched snow. Vegetation abounded, being exceedingly luxuriant as compared with Cape Hawkes, Cape Sabine, or other points further south visited by me. Dead willow was found in such abundance as to serve for fuel in more than one instance. Willow, saxifrages, grasses, and other plants grew in such profusion as to completely cover large tracts of ground. These valleys afford excellent pasturage for musk cattle, which feed towards the sea coast during summer, but withdraw to the interior as winter advances. I frequently noted evidences of recent elevation above the sea of the region now free from ice-cap. Such indications consisted of raised beaches, marine shells, and driftwood. At one place the trunks of two large coniferous trees were found in such a state of preservation as to allow of their use for fuel. It seems probable that these ice-caps were originally united. It is certain that both the northern and southern ice-caps have recently retreated, even if such a process is not going on now. Along the frontier of the southern ice were found many small glacial lakes and moraines. To the north, Lake Hazen for some fifty miles borders the ice-cap. In front of Henrietta Nesmith Glacier there were three parallel moraines. Between the face of the glacier

and the main lake at the junction of Lake Hazen and Ruggles River I discovered the remains of permanent Esquimaux huts. Many relics were obtained at that place and at various points along the southern shore of Lake Hazen, but no traces of any kind were found on the northern shore of the lake. It is perhaps worthy of remark that reindeer, which must have been plentiful in that country, have entirely disappeared, having either migrated or become extinct. In connection with the line of perpetual snow I may state that on Mount Arthur it was not far from 3500 feet above the sea. From barometrical measurements it appeared that the crest of Grinnell Land was above 2500 feet elevation in front of the southern ice-cap, 3000 feet near Mount Arthur.

#### THE BRITISH ASSOCIATION

SO far as reports have reached us, the Montreal meeting has been a brilliant success, at least from the social point of view. The enthusiasm of the reception by the Canadians could not have been greater, and that enthusiasm, we are glad to notice, has met with a cordial response from the 800 members of the Association who went to Montreal. From the ample reports in the *Times* it is evident that, notwithstanding the many outside attractions devised by the hosts of the Association, the work in the Sections has in quantity and quality been up to the average. The proceedings began on Tuesday week with an address from the Mayor and Corporation of Montreal, and on Wednesday the Governor-General, Lord Lansdowne, welcomed the Association in a warm speech, in which the right keynote was struck. "If," he said, "you selected within the British Colonial Empire a spot for your meeting, you could not have selected a colony which better deserved this distinction either in respect of warmth of affection for the mother country, or the desire of its inhabitants for the diffusion of knowledge and culture. In a young country such pursuits are conducted in the face of difficulties, competition with material activity necessarily absorbing the attention of a rapidly developing community. We may claim for Canada that she has done her best, and has spared no pains to provide for the interests of science in the future. She has scientific workers known and respected far beyond the bounds of their own nation." Lord Lansdowne spoke warmly of the honour conferred upon Principal Sir John Dawson, who is more responsible than any other single person for the Association's visit. "We regard," he said, "the knight-hood Her Majesty has bestowed upon him as an appropriate recognition of his distinguished services, and an opportune compliment to Canadian science. But the significance of this meeting is far greater than if measured merely by the addition it will make to the Empire's scientific wealth. When we find a society which for fifty years has not met outside the British Islands transferring its operations to the Dominion; when we see several hundred of the best-known Englishmen arriving here, mingling with our citizens and dispersing over this continent; when we see in Montreal the bearers of such names as Rayleigh, Playfair, Frankland, Sanderson, Thomson, Roscoe, Blanford, Moseley, Lefroy, Temple, Bramwell, Tylor, Galton, Harcourt, and Bonney, we feel one more step has been taken towards the establishment of that closer intimacy between the mother country and her offspring which both here and at home all good citizens of the Empire are determined to promote."

In introducing Lord Rayleigh as President, Sir William Thomson said:—

"It would have been a well-earned pleasure for my friend Prof. Cayley had he been able to visit Montreal, to introduce Lord Rayleigh to-night as his successor in the office of President of the British Association. Prof. Cayley has devoted his life to the advancement of pure

mathematics, and it is peculiarly appropriate that he should be followed in his honourable post by one who has made the brilliant applications of mathematical power to the discovery and illustration of natural phenomena with which Lord Rayleigh has enriched physical science. Lord Rayleigh's optical researches are of great value—notably his profound and searching mathematical investigation of the blue sky and the polarisation of light by reflection. His book on 'Sound' is the greatest and most important work which has yet appeared on the subject. His determination of the ohm, which constitutes the accurate foundation for the great modern science of electrical measurement, is of supreme importance not only in the scientific laboratory but in all practical applications of electricity, as in the telegraph cable factory and the signalling station, in electrical engineering works, in every practical application of electric light, electro-metallurgy, and the electrical transmission of power. With much pleasure I resign the chair for Prof. Cayley, and introduce Lord Rayleigh as President of the British Association."

The Royal Society of Canada presented an address of welcome to the Association, and the American Association sent a cordial invitation to the members to attend the meeting at Philadelphia. Over 200 were to go, leaving Montreal by special train this morning.

A brilliant reception was given on Thursday night by the Governors, Principal, and Professors of McGill University, and Saturday was devoted entirely to excursions. Prof. Lodge's lecture on "Dust" on Friday night was both scientific and practical, and appears to have been a great success. He did well to speak strongly to a practical people of the rewards of pure scientific research, though we trust that one result of the meeting will be to open the eyes of the Canadians to the utility of substantially encouraging such research.

One of the most notable incidents of the meeting seems to have been the reception given to Prof. Asa Gray in the Biological Section, where he read a paper on North American botany, one of the most remarkable papers, Prof. Moseley stated, ever read in that Section. When Prof. Gray rose to reply, he received a perfect ovation.

The Corporation of McGill University, in commemoration of the British Association meeting at Montreal, were to confer, at the closing meeting yesterday, the honorary degree of LL.D. upon the following prominent representatives of science: The President, Lord Rayleigh; the following Vice-Presidents: the Governor-General, Lord Lansdowne; Sir John A. Macdonald, Sir Lyon Playfair, and Prof. Frankland; the General Secretaries, Capt. Douglas Galton and Mr. A. G. Vernon Harcourt; the Secretary, Prof. Bonney; the Sectional Presidents, Sir William Thomson, Sir Henry Roscoe, Mr. W. T. Blanford, Prof. Moseley, General Sir J. H. Lefroy, Sir Richard Temple, Sir Frederick Bramwell, and Dr. E. B. Tylor; also upon Prof. Daniel Wilson, President of Toronto University and the leading Canadian archaeologist; Prof. Asa Gray of Harvard, the leading American botanist; and Prof. James Hall, the State Geologist of New York.

Lieut. Greely made his appearance in the Geographical Section on Tuesday, and gave a detailed account of the geographical and scientific results of his recent Arctic expedition. His paper, however, was no mere sensation; what he told the meeting of the condition of Grinnell Land is of real scientific value. On another page will be found the report of Lieut. Greely's paper.

One practical result of the Montreal meeting is that the Association will offer a gold medal in the Department of Applied Science in McGill University as a memento of the visit. Moreover, Mr. Blanford proposed in the Geological Section that as some return for the way in which they had been received the members should contribute for the formation of science scholarships in McGill College.



## SECTION C

## GEOLOGY

OPENING ADDRESS BY W. T. BLANFORD, F.R.S., SEC.G.S.,  
F.R.G.S., PRESIDENT OF THE SECTION

IN commencing an address to the Geological Section of the British Association on the first occasion on which that body has met outside of the British Islands I feel much difficulty. Amongst the eminent geologists who have filled the post which you have done me the honour of calling upon me to occupy for the present year there are several who would have been able, from their knowledge of both European and American geology, to treat with authority of the many points of interest elicited by comparison of geological phenomena on opposite sides of the Atlantic Ocean. My own experience has been chiefly derived from the distant continent of Asia, and I have not that intimate acquaintance with the geology of Europe, nor that knowledge of the progress of geological research in America, which would justify my entering upon any comparison of the two continents. It has, however, occurred to me that, amongst the questions of wide importance connected with the correlation of strata in distant parts of the world, there is one to which some interesting contributions have been made by the work of the Geological Survey of India, and by the geologists of Australia and South Africa, and that a short time might be profitably devoted to a consideration of a few remarkable exceptions to the rule that similarity of faunas and floras in fossiliferous formations throughout the surface of the world implies identity of geological age.

It has probably occurred to other geologists here present, as it has to myself, to be engaged in examining a country the geology of which was absolutely unknown, and to feel the satisfaction that attends the first discovery of a characteristic fossil form. A clue is at once afforded to the geology of the region; one horizon at least is believed to be determined, and from this horizon it is possible to work upwards and downwards until others are found.

It is, therefore, of especial importance to those engaged in geological exploration to satisfy themselves whether the conclusion is correct that identity, or close specific similarity, amongst fossil forms, is a proof that the beds containing them are of the same geological age. It has been pointed out by some of the most careful thinkers, and especially by Forbes and Huxley, that a species requires time to spread from one area to another, that, in numerous cases, a migratory specific form must flourish in the region to which it has migrated, after it has died out in its original birthplace; and that the presence of the same species in two deposits at distant localities may rather tend to indicate that both were not formed simultaneously. Huxley, as is well known, invented the term "homotaxis" to express the relations between such beds, and to avoid the possibly misleading expressions "geological synchronism," and "contemporaneous origin."

Despite such cautions, however, it still appears to be generally assumed by palæontologists that similarity between faunas and floras is evidence of their belonging to the same geological period; that the geological age of any formation, whether marine, fresh-water, or subaerial, can be determined by a comparison of its organic remains with those of other deposits, no matter how distant, of which the position in the geological sequence is ascertained: in short, that homotaxis of marine, fresh-water, and terrestrial forms implies geological synchronism.

That, as a general rule, homotaxis affords evidence that beds exhibiting it belong approximately to the same geological period appears supported by a large amount of evidence. But there are some startling exceptions. I propose to notice a few typical instances, several of them Indian, in which the system of determining the age of various formations by the fauna or flora has led to contradictory results, before attempting to show wherein the source of the error appears to lie. Nothing would be gained and much time would be lost by entering upon the details of all the cases known, even if I were able to give authentic particulars, which is doubtful. It will be sufficient to cite some characteristic examples, concerning the details of which satisfactory evidence is forthcoming.

**Pikermi Beds.**—There are but few fossiliferous deposits on the face of the earth that have attracted more attention than the Pikermi beds of Greece. In one of the most classical and famous sites of the world, a few miles east of Athens, just where

The mountains look on Marathon.  
And Marathon looks on the sea.

some red, silty beds occur, abounding in vertebrate remains.

Some of the bones were described by Wagner and others, but for a complete account of the fauna we are indebted to Prof. Albert Gaudry, who has himself collected by far the greater portion of the remains hitherto procured. The following is a list of the genera determined; it is unnecessary to give the specific names:—

## MAMMALIA.

PRIMATES.—*Mesopithecus*, 1 sp.

CARNIVORA.—*Simocyon*, 1; *Mustela*, 1; *Promephitis*, 1; *Ictitherium*, 3; *Hyæna*, 1; *Lepthyæna*, 1; *Hyænictis*, 1; *Felis*, 4; *Machærodus*, 1.

PROBOSCIDEA.—*Mastodon*, 2; *Dinotherium*, 1.

UNGULATA.—*Chalicotherium*, 1; *Rhinoceros*, 3; *Acrotherium*, 1; *Leptodon*, 1; *Hipparion*, 1; *Sus*, 1; *Camelopardalis*, 1; *Helladotherium*, 1; *Orasius*, 1; *Palaotragus*, 1; *Palaoryx*, 2; *Tragocerus*, 2; *Palaoceros*, 1; *Antilocas* (?), 1; *Gazella*, 1; *Antelope*, 3; *Dremotherium*, 2.

RODENTIA.—*Hystrix*, 1.

EDENTATA.—*Ancylotherium*, 1.

## AVES.

*Phasianus*, 1; *Gallus*, 1; *Gen. gallinac. indet.*, 1; *Grus*, 1; *Gen. riconidar. indet.*, 1.

## REPTILIA.

*Testudo*, 1; *Varanus*, 1.

Of Mammalia alone there are known from this deposit 31 genera, of which 22 are extinct, and 35 species.

Now, this fauna is almost invariably in European works quoted as Miocene. Of the species found no less than 14—*Simocyon diaphorus*, *Ictitherium robustum*, *I. hipparionum*, *Hyæna eximia*, *Hyænictis græca*, *Machærodus cultridens*, *Mastodon turicensis*, *Dinotherium giganteum*, *Rhinoceros schliermacheri*, *Hipparion gracile*, *Sus crymanthus*, *Helladotherium duvernoyi*, *Tragocerus amaltheus*, and *Gazella brevicornis*—are met with in other European deposits assigned to the Miocene period. It is true that one of these deposits at least—that of Eppelsheim—has been shown on stratigraphical grounds to be much more probably Pliocene than Miocene, and the position of other deposits has been determined by the kind of argument which, as I shall show, has proved misleading in the case of Pikermi itself. Nevertheless so general is the consensus of opinion amongst palæontologists, that the beds with *Hipparion* at Pikerui and elsewhere are quoted as especially included in the Miocene system by the French Committee of the International Geological Congress. Amongst English writers the Miocene age of the Pikermi beds appears generally admitted, as by Mr. Wallace (*Geographical Distribution of Animals*, i. p. 115), Prof. Boyd Dawkins (*Q. J. G. S.*, 1880, p. 389), Mr. E. T. Newton (*Q. J. G. S.*, 1884, pp. 284, 287, &c.), and many others. Prof. Gaudry himself is much more cautious; he classes the fauna as intermediate between Pliocene and Miocene, and only relegates it to Upper Miocene because that is the position assigned by other palæontologists to beds containing remains of *Hipparion*. However, in his subsequent works Prof. Gaudry has classed the Pikermi fauna as Miocene.

Now, the lowest of the beds with the vertebrate fauna at Pikerui were by Prof. Gaudry himself found to be interstratified with a band of gray conglomerate containing four characteristic marine Pliocene Mollusca—*Pecten benedictus*, Lam.; *Spondylus gaderopus*, L.; *Ostrea lamellosa*, Brocchi; and *O. undata*, Lam. It should be remembered that the Pliocene fauna of the Mediterranean area is the richest and most typical in Europe, and is as well known as any geological fauna in the world. It should also be remembered that the Pliocene beds are well developed in Greece at other localities besides Pikerui. Prof. Gaudry especially points out that the vertebrate remains, supposed to be those of Miocene animals, are deposited in a stratum overlying a marine bed of undoubted Pliocene age, and he proposes the following hypothesis to account for the presence of Miocene fossils in a Pliocene stratum. The remains found at Pikerui are, he thinks, those of animals that inhabited the extensive plains which in Miocene times extended over a considerable proportion of the area now occupied by the Eastern Mediterranean, and which united Greece to Asia; the plains were broken up by the dislocations that took place at the close of the Miocene period, and the animals escaped to the mountains, where they died for want of space and of food. Their bones were subsequently washed down by the streams from the hills and buried in the Pliocene deposits of Pikerui.

Prof. Gaudry evidently has no very profound faith in this hypothesis, and it is unnecessary to refute it at length. One fact is sufficient to show that it is untenable. However sudden may have been the cataclysm that is supposed to have broken up the Miocene plains of Attica, a very long period, measured in years, must have elapsed before the Pliocene marine fauna could have established itself. Now, the bones of mammals exposed on the surface decay rapidly; the teeth break up, the bones become brittle. It is doubtful if bones that had been exposed for only five or six years would be washed down by a stream without being broken into fragments; the teeth especially would split to pieces. The condition of the Pikermi fossils proves, I think, that they must have been buried very soon after the animals died, that they were not exposed on the surface for any length of time, and that they could not have been washed out of an earlier formation, and it appears to me incredible that the Pikermi mammals were not contemporary with the Pliocene Mollusca that occur in the same beds. In short, I cannot but conclude that the Pikermi mammals were Pliocene and not Miocene.

This view is entirely in accordance with the opinions of Theodor Fuchs (*Denkschr. K. Acad. Wiss. Wien*, 1877, xxxvii, 2<sup>e</sup> Abth. p. 1). He has given a good account of the geology of various places in Greece, and amongst others of Pikermi. He found, again, the conglomerate with Pliocene marine Mollusca interstratified with the basal portion of the mammaliferous beds, and he concludes (*l.c.* p. 30), that not only is it clear that these mammaliferous beds are of Pliocene age, but that a comparison of their geological position with that of the marine strata of the Piræus proves that the Pikermi beds occupy a very high position in the Pliocene, and are probably the highest portion of the system as developed in the neighbourhood.

Fuchs also shows that the principal Pliocene mammaliferous beds are of later date than the typical Pliocene (sub-Apennine) beds of Italy, and that some Mammalia found associated with the latter comprise forms identical with those of the Pikermi beds. In subsequent papers on the age of the beds containing *Hipparion* the same writer shows reasons for classing these strata in Italy, France (Vaucluse), and Germany as intermediate between Miocene and Pliocene. This leaves the difficulty unsolved, for he had shown the Pikermi beds to be high in the Pliocene system. They rest unconformably upon certain fresh-water limestones, clays, &c., containing plants and Mollusca, and classed by Gaudry as Miocene, but by Fuchs as Pliocene. Thus by both writers mammaliferous beds of Pikermi are referred to a considerably later geological horizon than those containing identical species in other parts of Europe.

It would require too much time to enter into the still more difficult question of the various plant-bearing beds in different parts of Europe and in Greenland containing a flora classed by Heer and others as Miocene. Gaudry has given reasons for considering the Greenland beds Eocene; Fuchs, as just stated, is of opinion that the Greek beds are Pliocene. One point should be noted, that the more northern flora is considered older than the more southern, and it will be remarked that the same observation applies to the supposed Upper Miocene fauna of France and Germany and the Pikermi fauna of Greece.

*Siwalik*.—The next instance which I shall describe is another of the most important fossil mammalian faunas of the Old World, that found in the Upper Tertiary beds that fringe the Himalayas on the south. The name applied to this fauna is taken from one of the localities in which it was first found, the Siwalik (correctly, I believe, Shib-wala) hills, between the Deyra Dun and the plains north by east of Delhi. Bones of Siwalik Mammalia are found, however, throughout a considerable area of the Northern Punjab.

The Siwalik fauna has been worked out, chiefly by Falconer and Lydekker, the last-named being still engaged in describing the species. The following is a list of the genera found in the true Siwalik beds:—

## MAMMALIA.

- PRIMATES.—*Palaopithecus*, 1 sp.; *Macacus*, 2; *Semnopithecus*, 1; *Cynopithecus*, 2.  
 CARNIVORA.—*Mustela*, 1; *Mellivora*, 2; *Mellivoredon*, 1; *Lutra*, 3; *Hyanodon*, 1; *Ursus*, 1; *Hyanarctus*, 3; *Canis*, 2; *Viverra*, 2; *Hyæna*, 5; *Lephyæna*, 1; *Æluropsis*, 1; *Ælurogale*, 1; *Felis*, 5; *Machærodus*, 2.  
 PROBOSCIDEA.—*Elephas*, 6 (*Eulephas*, 1; *Loxodon*, 1; *Stegodon*, 4); *Mastodon*, 5.

<sup>1</sup> Lydekker, *J. A. S. B.* 1880, pt. 2, p. 34; *Palaontologia Indica*, ser. x. vols. i. ii. iii. <sup>2</sup> *Records Geol. Surv. India*, 1883, p. 81. I am indebted to Mr. Lydekker for some unpublished additions.

- UNGULATA.—*Chalicotherium*, 1; *Rhinoceros*, 3; *Equus*, 1; *Hipparion*, 2; *Hippopotamus*, 1; *Tetracometon*, 1; *Sus*, 5; *Hippohyus*, 1; *Sanitherium*, 1; *Merycopotamus*, 1; *Cervus*, 3; *Dorcatherium*, 2; *Tragulus*, 1; *Propalæcomeryx*, 1; *Camelopardalis*, 1; *Helladotherium*, 1; *Hydasphitherium*, 2; *Sivatherium*, 1; *Alcephalus*, 1; *Gazella*, 1; *Antelope*, 2; *Oreas* (?), 1; *Palaoryx* (?), 1; *Portax*, 1; *Hemibos*, 3; *Lepobos*, 1; *Bubalus*, 2; *Bison*, 1; *Bos*, 3; *Bucapra*, 1; *Capra*, 2; *Ovis*, 1; *Camelus*, 1.

RODENTIA.—*Mus*, 1; *Rhizomys*, 1; *Hystrix*, 1; *Lepus*, 1.

## AVES.

- Graulus*, 1; *Pelecanus*, 2; *Megalascelornis*, 1; *Argala*, 1; *Struthio*, 1; *Dromæus*, 1.

## REPTILIA.

CROCODYLIA.—*Crocodylus*, 1; *Gharialis*, 3.

LACERTILIA.—*Varanus*, 1.

CHELONIA.—*Colossochelys*, 1; *Testudo*, 1; *Bellia*, 2; *Damonina*, 1; *Emys*, 1; *Cauloia*, 1; *Pangshura*, 1; *Emyda*, 1; *Trionyx*, 1.

## PISCES.

*Bagarius*, 1.

Now, until the last few years, this fauna was classed as Miocene by European paleontologists as unhesitatingly as the Pikermi fauna still is, and in the majority of European geological works, despite the unanimous opinion of all the geologists who are acquainted with the sub-Himalayan beds, the Siwalik fauna is still called Miocene. The geologists of the Indian Survey, however, class the fossiliferous Siwaliks as Pliocene, on both geological and biological grounds. With regard to the latter, not only does the fauna comprise a large number of existing genera of mammals, such as *Macacus*, *Semnopithecus*, *Ursus*, *Elephas* (*Eulephas*), *Equus*, *Hippopotamus*, *Camelopardalis*, *Bos*, *Hystrix*, *Mus*, and especially *Mellivora*, *Mela*, *Capra*, *Ovis*, *Camelus*, and *Rhizomys*, but three out of six or seven clearly-determined species of reptiles, viz. — *Crocodylus palustris*, *Gharialis gangeticus*, and *Pangshura tectoni* — are living forms now inhabiting Northern India, whilst all the known land and fresh water Mollusca, with one possible exception, are recent species.

These data, however, although very important and very cogent, belong to a class of facts that have led, I believe, in other cases to erroneous conclusions. The geological evidence is far more satisfactory, and it is not liable to the same objection.

The whole Siwalik fauna, as given above, has been obtained from the upper bed of a great sequence or system. Beneath the fossiliferous strata at the base of the North-West Himalaya there is an immense thickness, amounting in places to many thousands of feet, of sandstones, clays, and other beds, from none of which recognisable fossils have been procured. The first beds of known age that are met with below the mammaliferous Siwaliks are marine rocks belonging to the Eocene system.

But as we pass from the Himalayas to the south-west, along the western frontier of India in the Punjab, and onwards to the south in Sind, the same Siwalik system can be traced almost without interruption, and in the latter-named country the lower fossiliferous strata become intercalated with fossiliferous beds. In Sind the upper Siwaliks no longer yield any vertebrate remains that can be identified, but far below the horizon of the Siwalik fauna a few bones have been found, and the following mammals have been identified (*Pal. Ind.*, ser. x.; *Rec. Geol. Surv. Ind.*, 1883, pp. 82, &c.)—

CARNIVORA.—*Amphipyon palæindicus*.

PROBOSCIDEA.—*Mastodon latidens*, *M. permensis*, *M. sulciferi*, *M. pandionis*, *M. angustidens*, *Dinotherium indicum*, *D. sindiense*, *D. pentapotamice*.

UNGULATA.—*Rhinoceros siwalensis*, var. *intermedius*, *Acerotherium permense*, *A. blanfordi*, *Sus hysudricus*, *Hyotherium sindiense*, *Anthracootherium siliestense*, *A. hypopotamoides*, *Hypopotamus palæindicus*, *H. giganteus*, *Hemimeryx blanfordi*, *Sivameryx sindiensis*, *Agriocherus* sp., *Dorcatherium majus*, *D. minus*.

EDENTATA.—*Manis* (?) *sindiensis*.

Although about one-third of the species above named have been found also in the upper Siwalik beds of the Punjab, it is unnecessary to point out in detail why the lower Siwalik fauna is clearly by far the older of the two. The absence of such living genera as *Elephas*, *Bos*, *Equus*, &c., and the presence of

so many typically Middle Tertiary forms, such as *Dinotherium*, *Anthracoherium*, and *Hypopotamus*, shows a great change. The Mollusca tell the same tale. All the forms known from the upper Siwaliks, with one exception, are recent species of land and fresh-water shells now living in the area. Of seven fresh-water Mollusca (*Mem. Geol. Surv. Ind.* vol. xx. pt. 2, p. 129) found associated with the lower Siwaliks none appears to be identical with any living species, and only two are allied, one closely, the other more remotely, to forms now met with in Burmah, 30° of longitude further east.

Before proceeding with the argument, it is as well to call attention to the very important fact just mentioned. It has been asserted over and over again that species of *Mammalia* are peculiarly short lived, far more so than those of *Mollusca*. In this case, so far as the evidence extends at present, one-third of the species of *Mammalia* survived the changes that took place, whereas not a single mollusk is found both in the upper and lower Siwaliks. It should be remembered that the recent molluscan river fauna of this part of India is very poor in species, and that we probably know a considerable proportion of that existing in Siwalik times.

The geological age of the lower Siwalik beds of Sind is shown by their passing downwards into marine fossiliferous beds, known as the Gáj group, of Miocene age, the following being the section of Tertiary strata exposed in the hills west of the Indus:—

	Ft.	
SIWALIK OF MANCHER	Upper . . . . . 5000 unfossiliferous . . . . .	Pliocene
	Lower . . . . . 3000 to 5000 fossiliferous . . . . .	Upper Miocene or Lower Pliocene
(Gáj) . . . . .	1700 to 1500 fossiliferous . . . . .	Miocene
NAHI	Upper . . . . . 4000 to 6000 unfossiliferous . . . . .	Lower Miocene
	Lower . . . . . 100 to 1500 fossiliferous . . . . .	Oligocene
KHIRTHAR	Upper . . . . . 500 to 3000 fossiliferous . . . . .	Eocene
	Lower . . . . . 6000 fossiliferous . . . . .	

Clearly the lower Siwaliks of Sind cannot be older than Upper Miocene; therefore the upper Siwaliks, which are shown by both biological and geological evidence to be of much later date, must be Pliocene.

**Gondwána System of India.**—In the peninsula of India there is a remarkable deficiency of marine formations. Except in the neighbourhood of the coast or of the Indus Valley there is, with one exception (some Cretaceous rocks in the Nerbudda Valley), not a single marine deposit known south of the great Gangetic plain. But in Bengal and Central India, over extensive tracts of country, a great sequence of fresh-water beds, probably of fluvial origin, is found, to which the name of Gondwána System has been applied. The uppermost beds of this system, in Cutch to the westward, and near the mouth of the Godávari to the eastward, are interstratified with marine beds containing fossils of the highest Jurassic (Portlandian and Tithonian) types.

The Gondwána system is a true system in the sense that all the series comprised are closely connected with each other by both biological and physical characters, but it represents in all probability a much longer period of geological time than do any of the typical European systems. The highest members, as already stated, are interstratified with marine beds containing uppermost Jurassic fossils. The age of the lowest members is less definitely determined, and has been by different writers classed in various series from Middle Carboniferous to Middle Jurassic. The Gondwána beds from top to bottom are of unusual interest on account of the extraordinary conflict of palæontological evidence that they present.

The subdivisions of the Gondwána system are numerous, and in the upper portions especially the series and stages are different in almost every tract where the rocks are found. The following are the subdivisions of most importance on account of their fauna and flora, or of their geological relations:—

Upper Gondwána . . . . .	{ Cutch and Jabalpur Kota-Maleri Rájmahál Panchet	
Lower Gondwána . . . . .	{ Damuda . . . . .	{ Rániganj and Kámthi Barákar
	{ Karharbári Tálchir	

The upper Gondwánas, where best developed, attain a thickness of 11,000 feet, and the lower of 13,000 ft.

The Tálchir and Barákar subdivisions are far more generally present than any of the others.

**Tálchir.**—The Tálchir beds consist of fine silty shales and fine soft sandstone. Very few fossils have been found in them, and

these few recur almost without exception in the Karharbári stage. The Tálchirs are principally remarkable for the frequent occurrence of large boulders, chiefly of metamorphic rocks. These boulders are sometimes of large size, 6 feet or more across, 3 to 4 feet being a common diameter; all are rounded, and they are generally embedded in fine silt.

**Karharbári.**—The Karharbári beds are found in but few localities. They contain some coal-seams, and the following plants have been met with (*Feistmantel, Palæontologia Indica*, ser. xii. vol. iii.):—

- CONIFERÆ.—*Euryphyllum*, 1 sp.; *Volzia*, 1; *Albertia*, 1; *Samaropsis*, 1.
- CYCADEACEÆ.—*Glossozamites*, 1; *Noeggerathiopsis*, 1.
- FILICES.—*Neuropteris*, 1; *Glossopteris*, 4; *Gangamopteris*, 4; *Sagenopteris*, 1.
- EQUISETACEÆ.—*Schizoneura*, 2; *Vertebraria*, 1.

The most abundant form is a *Gangamopteris*. The *Volzia* (*V. heterophylla*) is a characteristic Lower Triassic (Bunter) form in Europe. The *Neuropteris* and *Albertia* are also nearly related to Lower Triassic forms. The species of *Gangamopteris*, *Glossopteris*, *Vertebraria*, and *Noeggerathiopsis* are allied to forms found in Australian strata.

**Damuda.**—The Damuda series consists of sandstones and shales with coal-beds; the floras of the different subdivisions present but few differences, and the following is the list of plants found (*Pal. Ind.* ser. ii. xi. xii. vol. iii.):—

- CONIFERÆ.—*Rhipidopsis*, 1 sp.; *Volzia*, 1; *Samaropsis*, 1; *Cyclophyta*, 1.
- CYCADEACEÆ.—*Pterophyllum*, 2; *Anomozamites*, 1; *Noeggerathiopsis*, 3.
- FILICES.—*Sphenopteris*, 1; *Dicksonia*, 1; *Alethopteris*, 4; *Pecopteris*, 1; *Merianopteris*, 1; *Macroteneopteris*, 2; *Palæmittaria*, 1; *Angiopteridium*, 2; *Glossopteris*, 19; *Gangamopteris*, 7; *Belemnopteris*, 1; *Anthrophyopsis*, 1; *Dactylopteridium*, 1; *Sigenopteris*, 4; *Actinopteris*, 1.
- EQUISETACEÆ.—*Schizoneura*, 1; *Phyllothecca*, 3; *Trisygia*, 1; *Vertebraria*, 1.

The only remains of animals hitherto recorded are an *Estheria* and two Labyrinthodonts, *Brachyops laticeps* and an undescribed form formerly referred to *Archegosaurius*. The only European genus allied to *Brachyops* is of Oolitic age.

The most abundant of the above-named fossils are *Glossopteris* and *Vertebraria*. With the exception of *Noeggerathiopsis* all the cycads and conifers are of excessive rarity. More than one-half of the species known are ferns with simple undivided fronds and anastomosing venation.

For many years European palæontologists generally classed this flora as Jurassic.<sup>1</sup> This was the view accepted by De Zigno and Schimper, and, though with more hesitation, by Bunbury. The species of *Phyllothecca*, *Alethopteris* (or *Pecopteris*), and *Glossopteris* (allied to *Sagenopteris*) were considered to exhibit marked Jurassic affinities. It was generally admitted that the Damuda flora resembles that of the Australian Coal-Measures (to which I shall refer presently) more than it does that from any known European formation; but the Australian plants were also classed as Jurassic. There is no reason for supposing that the more recent discoveries of Damuda plants would have modified this view; the identification of such forms as true *Sagenopteris* and the cycads *Pterophyllum* and *Anomozamites* would assuredly have been held to confirm the Jurassic age of the beds. So far as European fossil plants are concerned, the Damuda flora resembles that of the Middle or Lower Jurassics more than any other.

One form, it is true, the *Schizoneura*, is closely allied to *S. paradoxa* from the Bunter or Lower Trias of Europe. Other plants have Rhætic affinities. But the connections with the Triassic flora do not seem nearly equal to those shown with Jurassic plants, and the reason that the Damuda flora has been classed as probably Triassic must be sought in the impossibility of considering it newer (*Feistmantel, Pal. Ind.* ser. xii. vol. iii. pp. 57, 129, &c.), if the next overlying stage is classed as Upper Trias or Rhætic, and in the close affinity with the underlying Karharbári beds, which contain several Lower Triassic types.

**Panchet.**—The uppermost series of the lower Gondwánas consists chiefly of sandstone, and fossils are rare. The most in-

<sup>1</sup> De Zigno, *Flora Fossilis Form. Ool.* pp. 90, 53; Schimper, *Traité de Paléontologie végétale*, i. p. 645; Bunbury, *C. J. G. S.* 1861, xvii. p. 350.

teresting are remains of *Reptilia* and *Amphibia*. The following is a list of the fossil animals and plants corrected to the present time:—

## ANIMALS.

## REPTILIA.

DINOSAURIA.—*Ancistrodon*, 1 sp.  
DICYNODONTIA.—*Dicynodon* (*Ptychognathus*), 2.

## AMPHIBIA.

LABYRINTHODONTIA.—*Gonioelyptus*, 2; *Glyptognathus*, 1;  
*Pachygonia*, 1.

## CRUSTACEA.

*Estheria*, 1.

## PLANTS.

CONIFERÆ.—*Samaropsis*, 1.  
FILICES.—*Pecopteris*, 1; *Cyclopteris*, 1; *Thinnfeldia*, 1; *Oleandridium*, 1; *Glossopteris*, 3.  
EQUISETACEÆ.—*Schizoneura*, 1.

The *Schizoneura* and the three species of *Glossopteris* are considered the same as Damuda forms. But with them are found two European Rhætic species, *Pecopteris concinna* and *Cyclopteris pachyrachis*. The *Oleandridium* is also closely allied to a European Rhætic form, and may be identical. The flora may thus be classed as typically Rhætic.

All the genera of *Labyrinthodonts* named are peculiar; their nearest European allies are chiefly Triassic. *Dicynodontia* are only known with certainty from India and South Africa, but some forms believed to be nearly allied have been described from the Ural mountains (Huxley, *Q. J. G. S.* xxvii. p. 48.). These fossils were obtained from rocks now referred to the Permian (Twelvetrees, *Q. J. G. S.* xxxviii. p. 500).

*Upper Gondwanas*.—The different series of the lower Gondwanas are found in the same area, resting one upon the other, so that the sequence is determined geologically. This is not the case with the upper Gondwana groups; their most fossiliferous representatives are found in different parts of the country, and the relations to each other are mainly inferred from palæobotanical data. Although, therefore, it is probable that the Rājmahāls are older than the Cutch and Jabalpur beds, and that the Kota-Maleri strata are of intermediate age, it is quite possible that two or more of these series may have been contemporaneously formed in regions with a different flora.

*Rājmahāl*.—The comparatively rich flora of the lowest upper Gondwana series is contained in beds interstratified with basaltic lava-flows of the fissure-eruption type. The following are the genera (*Pal. Ind.* ser. ii.; Feistmantel, *Rec. G. S. I.* ix. p. 39) of plants found:—

CONIFERÆ.—*Palissya*, 2 sp.; *Cunninghamites*, 1; *Chirolepis*, 2; *Aracurites*, 1; *Echinostrobus*, 1.  
CYCADACEÆ.—*Pterophyllum*, 9; *Philoophyllum*, 1; *Otozamites*, 3; *Zamites*, 1; *Dictyozamites*, 1; *Cycadites*, 2; *Williamsonia*, 2; *Cycadinocarpus*, 1.  
FILICES.—*Eremopteris*, 2; *Davalluoides*, 1; *Dicksonia*, 1; *Hymenophyllites*, 1; *Cyclopteris*, 1; *Thinnfeldia*, 1; *Gleichenia*, 1; *Alethopteris*, 1; *Asplenites*, 1; *Pecopteris*, 1; *Macroteniopteris*, 4; *Angiopteridium*, 3; *Damocopsis*, 1; *Rhizomopteris*, 1.  
EQUISETACEÆ.—*Equisetum*, 1.

The marked change from the lower Gondwana floras is visible at a glance; not a single species is common to both, most of the genera are distinct, and the difference is even greater when the commonest plants are compared. In the lower Gondwanas the prevalent forms are *Equisetacea* and ferns of the *Glossopteris* type, whilst in the Rājmahāl flora cycads are by far more abundant than any other plants. The whole assemblage, moreover, is more nearly allied than are any of those in the lower Gondwana beds to European Mesozoic floras.

Of the Rājmahāl plants (Feistmantel, *Pal. Ind.* ser. ii. pp. 143, 187; *Manual Geol. Ind.* p. 145) about fifteen are allied to Rhætic European forms, three to Liassic or Lower Jurassic (two of these having also Rhætic affinities), and six to Middle Jurassic (two having Rhætic relations as well. The flora must therefore as a whole on purely palæontological grounds be classed as Rhætic.

*Kota-Maleri*.—The deposits belonging to this series are found in the Godāvāri valley at a considerable distance from the Rājmahāl hills in Bengal, the locality for the Rājmahāl flora. Both Rājmahāl and Kota-Maleri beds overlie rocks of the Damuda

series. It is not quite clear whether the Kota beds, which contain fish, insects, and crustaceans, and the Maleri beds, in which remains of fish, reptiles, and plants are found, are interstratified, or whether the Kota beds overlie those of Maleri. That the two are closely connected is generally admitted.

From the Maleri beds the following remains have been collected:—

## ANIMALS.

REPTILIA.—*Hyperodapedon*, 1 sp.; *Parasuchus*, 1.  
PISCES.—*Ceratodus*, 3.

## PLANTS.

CONIFERÆ.—*Palissya*, 2; *Chirolepis*, 1; *Aracurites*, 1.  
CYCADACEÆ.—*Philoophyllum*, 1; *Cycadites*, 1.  
FILICES.—*Angiopteridium*, 1.

From the Kota fresh-water limestone nine species of ganoid fish—viz. five of *Lepidotus*, three of *Tetragonolepis*, and one of *Dapedius*—have been described. An *Estheria*, a *Candona*, and some insects have also been found. The fish (*Pal. Ind.* ser. iv. pt. 2) are Liassic forms.

The Reptilia of the Maleri beds are, on the other hand, Triassic<sup>1</sup> and closely allied to Keuper forms. *Ceratodus* is chiefly Triassic (Keuper and Rhætic). The plants show relations with both the Rājmahāl and Jabalpur floras, and, as the palæontological relations to beds in the same country are considered far higher in importance than those to deposits in distant regions, the Kota-Maleri beds are classed as intermediate between the Rājmahāl and Jabalpur epochs.

*Cutch and Jabalpur*.—Jabalpur beds are found in Central India to the south of the Nerbudda Valley, and form the highest true Gondwana beds. The Cutch beds, as already mentioned, are found interstratified with marine deposits of uppermost Jurassic age far to the westward, a little east of the mouths of the River Indus. The similarity of the plant-remains in the two series has caused them to be classed together, but it is not certain that they are really of contemporaneous origin.

The following is a list of the Jabalpur plants (*Pal. Ind.* ser. xi. pt. 2):—

CONIFERÆ.—*Palissya*, 2 sp.; *Aracurites*, 1; *Echinostrobus*, 2; *Brachyphyllum*, 1; *Taxites*, 1; *Gingko*, 1; *Phanicoopsis*, 1; *Czekanowskia*, 1.  
CYCADACEÆ.—*Pterophyllum*, 1; *Philoophyllum*, 2; *Podozamites*, 3; *Otozamites*, 4; *Williamsonia*, 1; *Cycadites*, 1.  
FILICES.—*Sphenopteris*, 1; *Dicksonia*, 1; *Alethopteris*, 3; *Macroteniopteris*, 1; *Glossopteris*, 1; *Sagenopteris*, 1.

Of these thirty species nine are regarded either as identical with forms found in the Middle Jurassic (Lower Oolitic) of England, or as closely allied.

The Cutch plants belong to the following genera (*Pal. Ind.* ser. xi. pt. 1):—

CONIFERÆ.—*Palissya*, 3 sp.; *Pachyphyllum*, 1; *Echinostrobus*, 1; *Aracurites*, 1.  
CYCADACEÆ.—*Philoophyllum*, 3; *Otozamites*, 3; *Cycadites*, 1; *Williamsonia*, 1; *Cycadolepis*, 1.  
FILICES.—*Oleandridium*, 1; *Teniopteris*, 1; *Alethopteris*, 1; *Pecopteris*, 1; *Pachypteris*, 2; *Actinopteris*, 1.

Of the twenty-two species enumerated, four are identified with specific forms found in the Middle Jurassic of Yorkshire, and seven others are closely allied. The Cutch and Jabalpur beds, in short, are intimately related with European fossil floras, whilst the associations of Indian fossil plants found in the Rājmahāl, Damuda, and Karharbāri beds have no such close connection with Western types.

One interesting fact should be mentioned. The Cutch flora occurs in the upper part of the Umia beds, the lower beds of which contain *Cephalopoda* of Portlandian and Tithonian forms. In a lower subdivision of the Cutch Jurassic rocks, the Katrol group, shown by numerous Ammonites to be allied to Kimmeridge and upper Oxford beds of Western Europe, four species of plants have been found, of which three are met with in the Umia beds, and the fourth, an English Oolitic form, in the Jabalpur series. This evidence seems in favour of the view that the flora underwent change more slowly than the marine fauna.

It will be as well, before leaving the subject of the Gondwana groups, to show in a tabular form the geological age assigned to the flora and fauna of each separately, on the evidence afforded

<sup>1</sup> *Q. J. G. S.* 1859, pp. 138, 159, &c.; 1875, p. 427; *Pal. Ind.* ser. iv. pt. 2; *Man. Geol. Ind.* p. 151.

by comparison with the plants and animals known from European formations.

		Plants	Animals
Upper Gondwana	Cutch . . . . .	Middle Jurassic.	Uppermost Jurassic ? Neocomian (marine)
	Jabalpur . . . . .	Middle Jurassic.	Lower Jurassic (Liassic)
	Kota Maleri . . . . .	Middle or Lower Jurassic	Triassic
Lower Gondwana	Rajmahal . . . . .	Rhætic . . . . .	—
	Panchet . . . . .	Rhætic . . . . .	Triassic or Permian
	Damuda . . . . .	Middle Jurassic.	Middle Jurassic
	Karharbari, Talchir	Lower Triassic .	—

*Flora of Tonquin.*—Quite recently M. Zeiller has described a series of plants from some coal-bearing beds in Tonquin (*Bull. Soc. Géol. ser. iii. vol. xi. p. 456*). This flora is very extraordinary in every respect. It consists of twenty-two species, and contains only two peculiar forms; ten, or nearly one-half, are European species found in the Lower Lias or Rhætic; whilst of the remaining ten, five are Damuda forms *Noeggerathiopsis hislopi*, *Macroamopteris feddeni*, *Palaevittaria kurzi*, *Glossopteris browniana*, and *Phyllothea indica*, one species being common to the Newcastle beds and Carboniferous flora of Australia, and two others closely allied to the forms there occurring. The other five are said to be Rajmahal forms, four *Triniopteris* or *Angiopteridium* and an *Otozamites*. M. Zeiller unhesitatingly classes the Tonquin beds as Rhætic. It is most singular that these coal-beds, although more distant from Europe by 18° of longitude than either the Damuda or Rajmahal beds of India, contain a larger proportion of European fossil species than any known Indian plant-beds; whilst the association in the same strata of upper and lower Gondwana forms, if well ascertained, shows how hopeless is the attempt to classify these deposits by plant evidence alone.

*Australian Coal-Measures and Associated Beds.*—In the notice of the lower Gondwana floras of India it was observed that there was a great resemblance between some of them and those found in certain beds of Australia. These latter present even a more remarkable instance of homotaxial perversity than do the Indian rocks. The Australian plant-bearing beds are found in Eastern and Southern Australia, Queensland, and Tasmania. For a knowledge of the geology of the country we are chiefly indebted to the writings of the late Mr. Clarke,<sup>1</sup> whilst the flora has been worked out by McCoy, Dana, Carruthers, and Feistmantel, the latter having recently published a much more complete account than was previously available (*Palaontographica. Pal. u. mes. Flora des östl. Australien, 1878-79*).

The following are the fresh-water or subaerial beds of Australia, according to the latest classification:—

6. Clarence River beds, New South Wales (Mesozoic carbonaceous of Queensland, Victoria, and Tasmania).
5. Wianamatta beds, N.S. Wales.
4. Hawkesbury beds, N. S. Wales (Bacchus Marsh sandstones, Victoria).
3. Newcastle beds, N.S. Wales.
2. Lower Coal-Measures with marine layers interstratified, N.S. Wales.
1. Lower Carboniferous beds, N.S. Wales.

To a still lower horizon probably belong some beds in Queensland, containing *Lepidodendron nothum* and *Cyclostigma*. They are considered Devonian by Carruthers, and there are some ancient plant-beds in Victoria that may be of the same period.

1. *Lower Carboniferous Beds.*—These underlie the beds with a Carboniferous marine fauna. The localities given are Smith's Creek, near Stroud, Port Stephens, and Arowa. The following plants are enumerated:—

- LYCOPODIACEÆ.—*Cyclostigma*, 1 sp.; *Lepidodendron*, 2 or 3; *Knorria*, 1.  
 FILICES.—*Rhacopteris*, 4; *Archæopteris*, 2 (?); *Glossopteris*, 1.  
 EQUISETACEÆ.—*Calamites*, 2; *Sphenophyllum*, 1.

This flora contains several species identical with those in the Lower Carboniferous (Bernerian) of Europe, corresponding to the mountain limestone. The agreement both in homotaxis and position is the more remarkable because of the startling contrast

<sup>1</sup> Q. J. G. S. 1861, p. 354, and *Remarks on the Sedimentary Formations of New South Wales*, 1878, besides numerous other works.

in the next stage. The only peculiarity is the presence of a *Glossopteris*. This comes from a different locality—Arowa—from most of the fossils, and the species is identical with one found in a much higher series. Under these circumstances it is impossible to feel satisfied that the specimen was really from this horizon. The evidence is not so clear as is desirable.

2. *Lower Coal Measures with Marine Beds.*—The following plants are recorded:—

- CYCADEACEÆ.—*Noeggerathiopsis*, 1 sp.  
 FILICES.—*Glossopteris*, 4.  
 EQUISETACEÆ.—*Annularia*, 1; *Phyllothea*, 1.

In the marine beds, which are interstratified, are found Lower Carboniferous (mountain limestone) marine fossils in abundance, such as *Orthoceras*, *Spirifer*, *Fenestella*, *Conularia*, &c. The plants belong to forms declared to be typically Jurassic by palæontologists. As the interstratification of the marine and plant-bearing beds has been repeatedly questioned by palæontologists, it is necessary to point out that the geological evidence brought forward by Mr. Clarke is of the clearest and most convincing character, that this evidence has been confirmed by all the geologists who are acquainted with the country, and has only been doubted by those who have never been near the place.

3. *Newcastle Beds.*—By all previous observers in the field these had been united to the preceding and the flora declared to be the same. Dr. Feistmantel has, however, pointed out important differences. Unfortunately, as he has been unable to examine the beds, it still remains uncertain whether the distinction, which has been overlooked by all the field geologists, is quite so great as it appears from the list of fossils given. The following is the flora:—

- CONIFERÆ.—*Brachyphyllum*, 1 sp.  
 CYCADEACEÆ.—*Zeugophyllites*, 1; *Noeggerathiopsis*, 3.  
 FILICES.—*Sphenopteris*, 4; *Glossopteris*, 8; *Gangamopteris*, 2; *Caulopteris* (?), 1.  
 EQUISETACEÆ.—*Phyllothea*, 1; *Vertebraria*, 1.

The only animal known from the beds is a heterocercal ganoid fish, *Urotheues australis*, a form with Upper Paleozoic affinities.

It will be noticed that the difference from the flora of the underlying beds associated with marine strata is chiefly specific, and by no means indicative of great difference of age, though the only species considered as common to the two by Dr. Feistmantel is *Glossopteris browniana*, found also in the Damuda series of India, in Tonquin, and in South Africa.

The plant fossils of the Newcastle beds and of the underlying series with marine fossils are those which exhibit so remarkable a similarity to the flora of the Indian lower Gondwanas, and especially to the Damudas. The same genera of plants, especially *Noeggerathiopsis*, *Glossopteris*, *Phyllothea*, *Vertebraria*, prevail in both.

But the lower beds of Australia, to judge by the marine fauna, are of Lower Carboniferous age, and it is impossible to suppose that the Newcastle beds are of very much later date. They are said to be conformable to the lower beds with marine fossils, and even to pass into them, and they should probably, if the lower beds are Lower Carboniferous, be classed as Middle or Upper Carboniferous. Thus if the evidence of marine faunas be accepted as decisive, the Damuda beds of India are homotaxially related to Jurassic strata in Europe and to Carboniferous in Australia.

But the Australian Newcastle flora has been quite as positively classed as Jurassic by European palæobotanists as that of the Damudas. It would be easy to quote a long list of authorities—McCoy, De Zigno, Saporta, Schimper, Carruthers, and others—in support of the Jurassic age of the Australian beds. For years the testimony of Australian geologists was rejected, and doubts thrown upon their observations. There is, so far as I know, no case in the whole history of palæontology in which the conflict of palæontological evidence has been so remarkably displayed.

4. *Hawkesbury Beds.*—The fauna and flora are poor. Only two fish, *Clithrolepis granulatus* and *Mysilepis clarki*, and one plant, *Thinnfeldia odontopteroides*, are known, and of the three forms two recur in the Wianamatta beds.

An important character of the Hawkesbury beds, to which further reference will be made presently, is the occurrence of transported boulders (Wilkinson, quoted by Feistmantel, *Re. Géol. Surv. Ind.* 1880, p. 257), apparently brought thither by the action of ice.

Similar boulders have been observed in certain sandstones in

Victoria known as the Bacchus Marsh beds. From these beds species of *Gangamopteris* have been described by McCoy. *Gangamopteris*, it should be recollected, is a genus of ferns closely allied to *Glossopteris*, and abundant in the Damuda and still more so in the Karharbári beds of the lower Gondwáns in India.

5. *Wianamatta Beds*.—These are the highest portion of the whole system in New South Wales. They contain the following organic remains:—

ANIMALS.

PISCES.—*Palæoniscus antipoleus*, *Clithrolepis granulatus*.

PLANTS.

FILICES.—*Thinnfeldia* (*Peopteris*) *odontopteroides*, *Odontopteris microphylla*, *Pecopteris tenuifolia*, *Teniopteris wianamatta*.

EQUISETACEÆ.—*Phyllothea hookeri*.

The fish from the Wianamatta, Hawkesbury, and Newcastle beds, four in number, were considered as a whole by Sir P. Egerton to be most nearly allied to the Permian fauna of Europe.

The Wianamatta plants, like those in the lower beds, are classed as Jurassic.

6. *Higher Mesozoic Beds*.—These, which do not appear to have been traced into connection with the Wianamatta and Hawkesbury beds, occur in widely separated localities, from Queensland to Tasmania. The correlation of these widely scattered deposits, and the assignment of them collectively to a position above that of the Wianamatta beds, appear solely founded upon the fossil flora, and it would be satisfactory to have in addition some geological evidence or some palæontological data derived from marine fossils. The Queensland flora is said to occur in beds overlying marine strata of Middle Jurassic age.

The following plants are recorded from these higher beds:—

CYCADACEÆ.—*Zamites* (*Podozamites*), 3 sp.; *Otozamites*, 1.  
 FILICES.—*Sphenopteris*, 1; *Thinnfeldia*, 1; *Cyclopteris*, 1; *Alchopteris*, 1; *Teniopteris*, 1; *Sagenopteris*, 1.  
 EQUISETACEÆ.—*Phyllothea*, 1.

Tabulating, as in the case of the Indian Gondwána system, the age of the different Australian subdivisions as determined by their fossil plants and animals on purely palæontological grounds, we have the following result:—

	Plants	Animals
6. Higher Mesozoic beds	Jurassic	Jurassic (marine)
5. Wianamatta beds	Jurassic	Permian
4. Hawkesbury beds	Jurassic	Permian
3. Newcastle beds	Jurassic	Permian
2. Lower Coal-Measures	Jurassic	Lower Carboniferous (marine)
1. Lower Carboniferous beds	Lower Carboniferous	—

*South Africa*.—In connection with the later Palæozoic and older Mesozoic rocks of Australia and India, it is of importance to mention briefly the corresponding fresh-water or subaerial formations of Southern Africa, although in that country there are not such marked discrepancies in the palæontological evidence, perhaps because the relations of the beds with remains of animals to the plant-bearing strata are less clearly known. It will be sufficient to notice some of the most prominent peculiarities of these formations here, as I hope that a fuller account will be given to the section by Prof. Rupert Jones, who has made an especial study of South African geology.

In the interior of South Africa, occupying an immense tract in the northern parts of Cape Colony, the Orange Free State, Transvaal, and the deserts to the westward of the last two, there is a great system of sandstone and shales with some coal-beds generally known as the Karoo formation. The sequence of subdivisions is the following (*Q. J. G. S.* xxiii. 1867, p. 142):—

Stormberg beds, about 1800 feet thick
Beaufort " " 1700 " "
Koonap " " 1500 " "

The beds are but little disturbed in general, and form great plateaux. They rest partly on Palæozoic rocks (Carboniferous or Devonian), partly on gneissic formations. As in Australia, the underlying Palæozoic rocks contain a flora allied to the Carboniferous flora of Europe.

At the base of the Karoo formation are certain shales with coal, known as the Ecça beds, and remarkable for containing a great boulder-bed, the Ecça or Dwyka conglomerate (*Sutherland, Q. J. G. S.* xxvi. p. 514), like that in the Tálchir beds in India and the Hawkesbury sandstone in Australia, the boulders, precisely as in the Tálchir beds, being embedded in fine compact silt or sandstone, which in both countries has been mistaken for a volcanic rock. The Ecça beds are said to contain *Glossopteris* and some other plants, but the accounts are as yet somewhat imperfect. The whole Karoo system, according to the latest accounts, rests unconformably on the Ecça beds, whilst the Ecça beds are conformable to the underlying Palæozoic strata.

Unfortunately, although a considerable number of animals and a few plants have been described from the "Karoo formation," it is but rarely that the precise subdivision from which the remains were brought has been clearly known.

The known species of plants are very few in number: *Glossopteris brauniana*, and two other species of *Glossopteris* (one classed by Tate as *Dictyopteris*, *Q. J. G. S.* xxiii. p. 141) *Rubidgea*, a fern nearly akin to *Gangamopteris* and *Glossopteris*, and a *Phyllothea*-like stem are recorded, without any certain horizon, but probably from the Beaufort beds. There is no doubt as to the close similarity of these plants to those of the Damudas of India and the Newcastle beds of Australia.

From the Stormberg beds there are reported *Pecopteris* or *Thinnfeldia odontopteroides*, *Cyclopteris emata*, and *Teniopteris dauntieri* (Dunn, "Report on Stormberg Coal-Field," *Geol. Mag.* 1876, p. 552), three of the most characteristic fossils of the uppermost plant-beds in Australia, and all found in the upper Jurassic Queensland beds.

The animals found in the Karoo beds (Owen, "Cat. Foss. Rept. S. Africa, Brit. Mus. 1876," &c.) are more numerous by far than the plants. The greater portion have been secured from the Beaufort beds. They comprise numerous genera of dicynodont, theriodont, and dinosaurian reptiles, two or three genera of labyrinthodont amphibians, some fish allied to *Palæoniscus* and *Amblypterus*, and one mammal, *Tritylodon*. Of the above the *Tritylodon* and some reptilian and fish remains are said to be from the Stormberg beds.

*Tritylodon* is most nearly related to a Rhaetic European mammal. The relations of the reptiles called *Theriodontia* by Sir R. Owen are not clearly defined, but representatives of them and of the *Dicynodontia* as already noticed are said to be found in the Permian of Russia. The *Glossopteris* and its associates may of course be classed as Carboniferous or Jurassic, according to taste. Neither the fauna nor flora show sufficiently close relations to those of any European beds for any safe conclusions as to age, even if homotaxis and synchronism be considered identical. On the other hand, there are remarkable points of agreement with the faunas and floras of the Indian and Australian rocks.

Away from the typical Karoo area on the coast south of Natal there is found a series of beds, partly marine, sometimes called the Uitenhage (*Q. J. G. S.* xvii. p. 144) series. A few cycads (*Otozamites*, *Podozamites*, *Pterophyllum*), a conifer, and ferns (*Pecopteris* or *Alchopteris*, *Sphenopteris*, *Cyclopteris*) are quoted from them, and three or four of the forms are closely allied identical with species found in the Rájmahál beds of India.

It was at first supposed that the plant-bearing beds were lower in position than those containing marine fossils, and the whole of the Uitenhage series was considered as of later age than the Karoo beds. The marine beds were considered Middle Jurassic. Subsequently, however, Stow (*Q. J. G. S.* xxvii. p. 479) showed conclusively that a portion of the marine beds, judging by their fossils, are of uppermost Jurassic or even Neocomian age, and also that the relation of the plant-bearing beds to the marine strata are far less simple than was supposed (*loc. cit.* p. 505, 511, 513, &c.). Indeed, to judge from Stow's account, it is by no means clear that a portion of the wood-bed series or saliferous series, to which the plant-beds belong, is not higher in position than the marine Jurassic strata.

There is a very extraordinary similarity between the geology of the southern part of Africa and that of the peninsula of India. In both countries a thick fresh-water formation, without any marine beds intercalated, occupies a large area of the interior of the country, whilst on the coast some marine Jurassic and Cretaceous rocks are found, the former in association with beds containing plants. The coincidence is not even confined to sedimentary beds. As in India so in South Africa, the uppermost inland Mesozoic fresh-water beds are capped by volcanic rocks.

It has been assumed, but not apparently on any clear evidence,

that the marine coast-beds and the associated plant-beds are in Africa much newer than the inland sandstone formation, but it is not impossible that the relations may really be the same as in India, and that the Stormberg beds of the inland formation may be the equivalents of the Upper Jurassic or even the Cretaceous marine beds on the coast. The discovery of plants identical with those of the Jurassic (probably Upper Jurassic) beds of Queensland in the Stormberg series may of course be taken for what it is worth; it is of quite as much importance in indicating the age of the rocks as the occurrence of dicynodont reptiles in the Permian of Russia and in the lower Gondwanas of India.

Altogether there is quite sufficient probability that the upper Karoo or Stormberg beds are of later age than Triassic to justify the protest which I made last year against a skull being described from these beds as that of a "Triassic" mammal (*Q. J. G. S.* xl. p. 146). The practice, so common amongst palaeontologists, of positively asserting as a known fact the geological age of organisms from beds of which the geological position is not clearly determined is very much to be deprecated.

I have called attention to the occurrence of boulders in the Tálchir beds in India, the Ecca beds of South Africa, and the Bacchus Marsh sandstones and Hawkesbury beds of Australia. The idea has occurred quite independently to several different observers that each of these remarkable formations affords evidence of glacial action; and although, in the case of India especially, the geographical position of the boulder-bed within the tropics seemed for a long time to render the notion of ice action too improbable to be accepted, further evidence has so far confirmed the view as to cause it to be generally received. Even before the Australian boulder-deposits had been observed, it was suggested that the Tálchir beds and Ecca conglomerate might be contemporaneous (*Q. J. G. S.* xxxi. p. 528), and that the evidence in favour of a Glacial epoch having left its traces in the Permian beds of England (*Q. J. G. S.* xi. p. 185) might possibly indicate that the Indian and South African boulder-beds are of the same geological epoch. The discovery of two similar deposits in Australia adds to the probability that all may have resulted from the same cause and may record contemporaneous phenomena. It would be very unwise to insist too much on the coincidence.

It would be easy to call attention to further examples of discrepancies in palaeontological evidence, but I should weary you and nothing would be attained by going through instance after instance of deposits in distant parts of the world, the age of which has been solely determined by the examination of a few fossil forms of land and fresh-water animals and plants. I have, therefore, only taken a few with the details of which I have had occasion to become acquainted. In some of the most important cases I have mentioned, such as those of the Pikermi and Siwalik faunas, the Cutch (Umia beds) flora, and that in the lower Coal-Measures of Australia, the conflict is between the evidence of the marine and terrestrial organisms. Manifestly one or the other of these leads to erroneous conclusions.

The general opinion of geologists is in favour of accepting the evidence of marine organisms. The reason is not far to seek. So far as I am aware no case is known where such an anomaly as that displayed in the Gondwanas of India has been detected amongst marine formations of which the sequence was unquestioned. In the Gondwanas we have a Rhetic flora overlying a Jurassic flora, and a Triassic fauna above both. In Australia we find a Jurassic flora associated with a Carboniferous marine fauna, and overlaid by a Permian fresh-water fauna. The only similar case amongst marine strata is that of the well-known colonies of the late M. Barrande in Bohemia, and in this instance the intercalation of strata containing later forms amongst beds with older types is disputed, whilst the difference in age between the faunas represented is not to be compared to that between Triassic and Jurassic.

There is, however, another and an even stronger reason for accepting the evidence of marine instead of that afforded by terrestrial and fresh-water animals and plants. If we compare the distribution of the two at the present day, we shall find a very striking difference, and it is possible that this difference may afford a clue to the conditions that prevailed in past times.

Wanderers into what they fancy unexplored tracts in palaeontology are very likely to find Prof. Huxley's footprints on the path they are following. I have had occasion to turn to a paper of his on *Hyperodopalon* (*Q. J. G. S.* xxv. p. 150), that

very curious reptile already mentioned, of which the remains occur both in Great Britain and in India, and I find the following remarks, which appear so exactly to express a portion of the view to which I wish to call your attention, that I trust I may be excused for quoting them. Prof. Huxley writes:—

"It does not appear to me that there is any necessary relation between the fauna of a given land and that of the seas of its shores. The land-fauna of Britain and Japan are wonderfully similar; their marine fauna are in several ways different. Identical marine shells are collected on the Mozambique coast and in the easternmost islands of the Pacific; whilst the fauna of the lands which lie within the same range of longitude are extraordinarily different. What now happens geographically to provinces in space is good evidence as to what, in former times, may have happened to provinces in time; and an essentially identical land-fauna may have been contemporary with several successive marine fauna.

"At present our knowledge of the terrestrial fauna of past epochs is so slight that no practical difficulty arises from using, as we do, sea-reckoning for land-time. But I think it highly probable that sooner or later the inhabitants of the land will be found to have a history of their own."

When these words were written more than twenty-four years ago, scarcely one of the geological details to which I have called your attention was known. I need not point out how wonderful a commentary such details have afforded to Prof. Huxley's views.

I have no desire to quote authority. I fear that in the facts I have been laying before you my quotations of the most authoritative writers have been made less for the purpose of showing reverence than of expressing scepticism. My reason for calling attention to Prof. Huxley's views is different. I entirely agree with them; but there is, I think, something to be added to them. There is, I believe, an additional distinction between land and marine faunas that requires notice, and this distinction is one of very great importance and interest. It appears to me that at the present day the difference between the land-faunas of different parts of the world is so vastly greater than that between the marine faunas that, if both were found fossilised, whilst there would be but little difficulty in recognising different marine deposits as of like age from their organic remains, terrestrial and fresh-water beds would in all probability be referred to widely differing epochs, and that some would be more probably classed with those of a past period than with others of the present time.

I had proposed to enter at some length into this subject, and to attempt a sketch of the present state of our knowledge concerning the distribution of terrestrial and marine faunas and floras. But I found that it was impossible to do justice to the question without making this address far longer than is desirable, and I have already taken up more time than I ought to have done. I can therefore only treat the subjects very briefly.

As you are doubtless aware, the most important work upon the distribution of terrestrial animals yet published is that of Mr. Wallace. He divides the earth's surface into six regions—Palæarctic, Ethiopian, Oriental, Australian, Neotropical, and Nearctic. Some naturalists, with whom I am disposed to agree, consider Madagascar and the adjacent islands a seventh region, and it is possible that one or two other additions might be made.

These regions are essentially founded on the distribution of *Vertebrata*, especially mammals and birds, and the following table, taken from Wallace's list, shows the percentage of peculiar families of *Vertebrata* and peculiar genera of *Mammalia* in each region, *Mammalia* being selected as being more characteristic than birds, and better known than reptiles, amphibians, or fishes:—

Regions	Total Families of Vertebrates	Har-likes	of Peculi Families	Total Genera of Mammia	Peculia Genera of Mammal
PALÆARCTIC . . . . .	137	3	22	100	37
ETHIOPIAN . . . . .	175	23	131	142	90
ORIENTAL . . . . .	163	12	74	118	54
AUSTRALIAN . . . . .	142	30	211	70	45
NEOTROPICAL . . . . .	168	45	208	131	103
NEARCTIC . . . . .	191	12	99	74	24

The marine mammals and reptiles are too few in number to

be compared with the land-fauna, but whales, porpoises, seals, sirenians, turtles, and sea-snakes are for the most part widely diffused. The best class of the Vertebrata for comparison is that of the fishes, and some details taken by Wallace from Günther's "British Museum Catalogue" are very important. The whole class is divided into 116 families, of which 29 are exclusively confined to fresh water, whilst 80 are typically marine. Of these 80 no less than 50 are universally, or almost universally, distributed, whilst many others have a very wide range. Four families are confined to the Atlantic and 13 to the Pacific Ocean, whilst a few more are exclusively southern or northern. About 63 are found in both the Atlantic and Pacific.

Now, of the 29 fresh-water families, 15, or more than one-half, are confined each to a single region, 0 are found each in two regions, 2 in three regions, and the same number in four; one only (*Cyprinidae*) is found in five regions, whilst not one is met with in all six. It is impossible to conceive a greater contrast: 50 marine families, or 62.5 per cent., have a world-wide distribution, whilst not a single fresh-water family has an equally extended range, and more than one-half are confined each to a single region.

The regions adopted by Wallace, as already stated, are founded on the *Vertebrata*; he considers, however, that the distribution of the invertebrates is similar. So far as the terrestrial Mollusca are concerned, I am inclined to dissent from this view. But for one circumstance, the Mollusca would afford an admirable test of the theory that marine types—species, genera, and families—are much more widely spread than terrestrial. I am assured that this is the case, but the difficulty of proving it arises from the fact that the classification of pulmonate terrestrial Mollusca, as adopted by naturalists generally, is so artificial as to be worthless. Genera like *Helix*, *Bulimus*, *Achatina*, *Pupa*, *Vitrina*, as usually adopted, are not real genera, but associations of species united by characters of no systematic importance, and the attempts that have hitherto been made at a natural classification have chiefly been founded on the shells, the animals not being sufficiently known for their affinities, in a very large number of cases, to be accurately determined. Of late years, however, more attention has been devoted to the soft parts of land mollusks, and in Dr. Paul Fischer's "Manuel de Conchyliologie" now being published, classification of the Pulmonate Gasteropoda is given, which, although still imperfect for want of additional information, is a great improvement upon any previously available. In this work the first 13 families of the *Pulmonata Geophila* comprise all the non-operculate land Mollusca, or snails and slugs, and these 13 families contain 82 genera thus distributed:—

Peculiar to one of Wallace's land regions . . . . .	54
Found in more than one, but not in both America and the Eastern Hemisphere . . . . .	
Common to both hemispheres . . . . .	16

The last 16, however, include *Limax*, *Vitrina*, *Helix*, *Pupa*, *Cerithio*, and some other genera which certainly need further repartition. The operculated land-shells belonging to a distinct sub-order, or order, and closely allied to the ordinary Prosobranchiate Gasteropoda, are better classified, the shells in their case affording good characters. They comprise four well-marked families (*Helicinidae*, *Cyclostomidae*, *Cyclophoridae*, and *Diplommatinidae*), besides others less well marked or but doubtfully terrestrial. Not one of the families named is generally distributed, and the genera are for the most part restricted to one or two regions. The portion of Dr. Fischer's manual relating to these Mollusca is unpublished, and the latest general account available is that of Pfeiffer, published in 1876 (*Monographia Pneumonoporum Vivantium*, Supp. iii.). From this monograph I take the following details of distribution. The number of genera enumerated is 64 (including *Proserpinidae*).

Peculiar to one of Wallace's land regions . . . . .	48
Found in more than one, but not in both America and the Eastern Hemisphere . . . . .	8
Common to both hemispheres . . . . .	8

It is the distribution of the terrestrial operculate Mollusca which induces me to suspect that the distribution of land Mollusca differs from that of land vertebrates. One instance I may give. There is nowhere a better-marked limit to two vertebrate faunas than that known as Wallace's line separating the Australian and Oriental regions, and running through the Malay peninsula between Java, Sumatra, and Borneo on the one hand, and Papua with the neighbouring groups on the other. There is in the two regions a very great difference in the vertebrate genera, and a

considerable replacement of families. The Oriental *Vertebrata* contain far more genera and families common to Africa than to Australia. Now, the operculate land-shells known from New Guinea and Northern Australia belong to such genera as *Cyclophorus*, *Cyclopus*, *Leptopoma*, *Pupinella*, *Pupina*, *Diplommatina*, and *Helicina*, all found in the Oriental region, and mostly characteristic of it, whilst the only peculiar types known are *Leuptychia*, closely allied to *Leptopoma*, from New Guinea, and *Heterocypus*, apparently related to the Indian *Cyathopoma*, from New Caledonia. Farther east, in Polynesia, there are some very remarkable and peculiar types of land-shells, such as *Achatina*, but these do not extend to Australia or Papua. On the other hand, scarcely a single Oriental genus extends to Africa, the terrestrial molluscan fauna of which continent differs far more from that of the Oriental region than the latter does from that of tropical Australia.

The same is the case with plants. In an important work lately published by Dr. O. Drude of Dresden, the tropics of the Old World are divided into three distinct regions:—(1) tropical Africa; (2) the East African islands, Madagascar, &c.; (3) India, South-Eastern Asia, the Malay Archipelago, Northern Australia, and Polynesia.

A very large proportion of the families and even of the genera of marine Mollusca are almost of world-wide distribution, and even of the tropical and sub-tropical genera the majority are found in all the warmer seas. I have no recent details for the whole of the marine Mollusca, but a very fair comparison with the data already given for land-shells may be obtained from the first twenty-five families of Prosobranchiate Gasteropoda, all that are hitherto published in Fischer's manual. These twenty-five families include *Conidae*, *Olividae*, *Volutidae*, *Buccinidae*, *Muricidae*, *Cypridae*, *Strombidae*, *Cerithiidae*, *Planorbidae*, and their allies, and contain 116 living marine genera, the known range of which is the following:—

Found only in the Atlantic Ocean . . . . .	15
Found only in the Pacific or Indian Ocean, or both . . . . .	28
Found only in Arctic or Antarctic Seas, or in both . . . . .	12
	55
Found in the warmer parts of all oceans . . . . .	34
Widely, and for the most part universally, distributed . . . . .	27
	61

That is, 52.6 per cent. are found in both hemispheres, whilst only 19.5 per cent. of the inoperculate, and 12.5 per cent. of the operculate land Mollusca, have a similar distribution. This, however, only an imperfect test of the difference, which is really much greater than these numbers named imply by themselves.

Some genera of fresh-water Mollusca, as *Unio*, *Anodon*, *Cyclus*, *Lymnaea*, *Planorbis*, *Palaudina*, and *Rhythinia*, are very widely spread, but a much larger number are restricted. Thus, if *Unio* and *Anodon* are extensively distributed, all allied fresh-water genera, like *Monocodonta*, *Mycetopus*, *Iridina*, *Spatha*, *Castalia*, *Aithya*, and *Mülleria*, inhabit one or two regions at the most. The same result is not found from taking an equally important group of marine Mollusca, such as *Veneridae* or *Caraiidae*.

Throughout the marine Invertebrata, so far as I know, the same rule holds good: a few generic types are restricted to particular seas; the majority are found in suitable habitats throughout a large portion of the globe. The marine provinces that have been hitherto distinguished, as may be seen by referring to those in Woodward's "Manual of the Mollusca," or Forbes and Godwin-Austen's "Natural History of the European Seas," or Fischer's "Manuel de Conchyliologie," or Agassiz' "Revision of the Echini," are founded on specific distinctions, whilst the terrestrial regions are based on generic differences, and often on the presence or absence of even larger groups than genera.

Botany offers a still more remarkable example. I have just referred to Dr. Oscar Drude's work (*Petermann's Mittheilungen, Ergänzungsheft, No. 74, "Die Florenreiche der Erde"*), published within the last few months, on the distribution of plants. Dr. Drude divides the surface of the globe into four groups of floral regions (*Florenreichsgruppe*), and these again into floral regions (*Florenreiche*), fifteen in number, which are again divided into sub-regions (*Gebiete*). The first group of floral regions is the oceanic, comprising all the marine vegetation of the world;



and so uniform is this throughout that no separate regions can be established, so that there is but one oceanic to contrast with fourteen terrestrial regions.

It is impossible to enter further into this subject now, and I can only allude to the evidence in favour of the existence of land-regions in past times. It is scarcely necessary to remind you of the proofs already accumulated of differences between the fauna of distant countries in Tertiary times. The Eocene, Miocene, and Pliocene Vertebrata of North America differ quite as much from those of Europe in the same periods as do the genera of the present day; and there was as much distinction between the Mammalia of the Himalayas and of Greece when the Siwalik and Pikermi faunas were living as there is now. In Mesozoic times we have similar evidence. The reptiles of the American Jurassic deposits present wide differences from those of the European beds of that age, and the South African reptilian types of the Karoo beds are barely represented elsewhere. But there is no reason for supposing that the limits or relations of the zoological and botanical regions in past times were the same as they now are. It is quite certain indeed that the distribution of land-areas, whether the great oceanic tract has remained unchanged in its general outlines or not, has undergone enormous variations, and the migration of the terrestrial fauna and flora must have been dependent upon the presence or absence of land communication between different continental tracts; in other words, the terrestrial regions of past epochs, although just as clearly marked as those of the present day, were very differently distributed. The remarkable resemblance of the floras in the Karoo beds of South Africa, the Damuda of India, and the Coal-Measures of Australia, and the wide difference of all from any European fossil flora, is a good example of the former distribution of life; whilst it is scarcely necessary to observe that the present Neotropical and Australian mammals resemble those of the same countries in the later Tertiary times much more than they do the living Mammalia of other regions, and that the Australian mammal fauna is in all probability more nearly allied to the forms of life inhabiting Europe in the Mesozoic era than to any European types of later date. If the existing mammals of Australia had all become extinct, a deposit containing their bones would probably have been classed as Mesozoic.

The belief in the former universality of faunas and floras is very much connected with the idea once generally prevalent, and still far from obsolete, that the temperature of the earth's surface was formerly uniform, and that at all events until early or even Middle Tertiary times the Poles were as warm as the Equator, and both enjoyed a constant tropical climate. The want of glacial evidence from past times in Spitzbergen and Greenland, where a temperature capable of supporting arboreal vegetation has certainly prevailed during several geological periods, is counterbalanced by the gradually accumulating proof of Lower Mesozoic or Upper Palaeozoic Glacial epochs in South Africa, Australia, and, strangest of all, in India. Even during those periods of the earth's history where there is reason to believe that the temperature in high latitudes was higher than it now is, evidence of distinct zones of climate has been observed, and quite recently Dr. Neumayr,<sup>1</sup> of Vienna, has shown that the distribution of Cretaceous and Jurassic *Cephalopoda* throughout the earth's surface proves that during those periods the warmer and cooler zones of the world existed in the same manner as at present, and that they affected the distribution of marine life as they do now.

The idea that marine and terrestrial faunas and floras were similar throughout the world's surface in past times is so ingrained in palaeontological science that it will require many years yet before the fallacy of the assumption is generally admitted. No circumstance has contributed more widely to the belief than the supposed universal diffusion of the Carboniferous flora. The evidence that the plants which prevailed in the Coal-Measures of Europe were replaced by totally different forms in Australia, despite the closest similarity in the marine inhabitants of the two areas at the period, will probably go far to give the death-blow to an hypothesis that rests upon no solid ground of observation. In a vast number of instances it has been assumed that similarity between fossil terrestrial faunas and floras proves identity of geological age, and, by arguing in a vicious circle, the occurrence of similar types assumed without sufficient proof to belong to the same geological period has been

alleged as evidence of the existence of similar forms in distant countries at the same time.

In the preceding remarks it may perhaps have surprised some of my auditory that I have scarcely alluded to any American formations, and especially that I have not mentioned so well-known and interesting a case of conflicting palaeontological evidence as that of the Laramie group. My reason is simply that there are probably many here who are personally acquainted with the geology of the American Cretaceous and Tertiary beds, and who are far better able to judge than I am of the evidence as a whole. To all who are studying such questions in America I think it will be more useful to give the details of similar geological puzzles from the Eastern Hemisphere than to attempt an imperfect analysis of difficult problems in the great Western continent.

Perhaps it may be useful, considering the length to which this address has extended, to recapitulate the principal facts I have endeavoured to bring before you. These are—

1. That the geological age assigned on homotaxial grounds to the Pikermi and Siwalik mammalian faunas is inconsistent with the evidence afforded by the associated marine deposits.
2. The age similarly assigned on the same data to the different series of the Gondwana system of India is a mass of contradictions: beds with a Triassic fauna overlying others with Rhatic or Jurassic floras.
3. The geological position assigned on similar evidence to certain Australian beds is equally contradictory, a Jurassic flora being of the same age as a Carboniferous marine fauna.
4. The same is probably the case with the terrestrial and fresh-water faunas and floras of South Africa.
5. In instances of conflicting evidence between terrestrial or fresh-water faunas and floras on one side, and marine faunas on the other, the geological age indicated by the latter is probably correct, because the contradictions which prevail between the evidence afforded by successive terrestrial and fresh-water beds are unknown in marine deposits, because the succession of terrestrial animals and plants in time has been different from the succession of marine life, and because in all past times the differences between the faunas and floras of distant lands have probably been, as they now are, vastly greater than the differences between the animals and plants inhabiting the different seas and oceans.
6. The geological age attributed to fossil terrestrial faunas and floras in distant countries on account of the relations of such faunas and floras to those found in European beds has proved erroneous in so large a number of cases that no similar determinations should be accepted unless accompanied by evidence from marine beds. It is probable in many cases—perhaps in the majority—where the age of beds has been determined solely by the comparison of land or fresh-water animals or plants with those found in distant parts of the globe, that such determinations are incorrect.

## SECTION II

### ANTHROPOLOGY

OPENING ADDRESS BY EDWARD B. TYLOR, D.C.L., F.R.S.,  
PRESIDENT OF THE SECTION

OUR newly-constituted Section of Anthropology, now promoted from the lower rank of a Department of Biology, holds its first meeting under remarkable circumstances. Here in America one of the great problems of race and civilisation comes into closer view than in Europe. In England anthropologists infer from stone arrow-heads and hatchet-blades, laid up in burial-mounds or scattered over the sites of vanished villages, that Stone Age tribes once dwelt in the land; but what they were like in feature and complexion, what languages they spoke, what social laws and religion they lived under, are questions where speculation has but little guidance from fact. It is very different when under our feet in Montreal are found relics of a people who formerly dwelt here, Stone Age people, as their implements show, though not unskilled in barbaric arts, as is seen by the ornamentation of their earthen pots and tobacco-pipes, made familiar by the publications of Principal Dawson. As we all know, the record of Jacques Cartier, published in the sixteenth century collection of Ramusio, proves by text and drawing that here stood the famous palisaded town of Hochelaga. Its inhabitants, as his vocabulary shows, belonged to the group of tribes whose word for 5 is *wisk*—that is to say, they were of

<sup>1</sup> Ueber klimatische Zonen während der Juras und Kreidezeit," *Denkschr. Math. Nat. Cl. Akad. Wiss. Wien*, vol. xlviii, 1883.

the Iroquois stock. Much as Canada has changed since then, we can still study among the settled Iroquois the type of a race lately in the Stone Age, still trace remnants and records of their peculiar social institutions, and still hear spoken their language of strange vocabulary and unfamiliar structure. Peculiar importance is given to Canadian anthropology by the presence of such local American types of man, representatives of a stage of culture long passed away in Europe. Nor does this by any means oust from the Canadian mind the interest of the ordinary problems of European anthropology. The complex succession of races which make up the pedigree of the modern Englishman and Frenchman, where the descendants perhaps of palæolithic, and certainly of neolithic, man have blended with invading Keltic, Roman, Teutonic-Scandinavian peoples—all this is the inheritance of settlers in America as much as of their kinsfolk who have stayed in Europe. In the present scientific visit of the Old to the New World, I propose to touch on some prominent questions of anthropology with special reference to their American aspects. Inasmuch as in an introductory address the practice of the Association tends to make arguments unanswerable, it will be desirable for me to suggest rather than dogmatise, leaving the detailed treatment of the topics raised to come in the more specialised papers and discussions which form the current business of the Section.

The term *prehistoric*, invaluable to anthropologists since Prof. Daniel Wilson introduced it more than thirty years ago, stretches back from times just outside the range of written history into the remotest ages where human remains or relics, or other more indirect evidence, justifies the opinion that man existed. Far back in these prehistoric periods, the problem of Quaternary man turns on the presence of his rude stone implements in the drift gravels and in caves, associated with the remains of what may be called for shortness the mammoth-fauna. Not to recapitulate details which have been set down in a hundred books, the point to be insisted on is how, in the experience of those who, like myself, have followed them since the time of Boucher de Perthes, the effect of a quarter of a century's research and criticism has been to give Quaternary man a more and more real position. The clumsy flint pick and its contemporary mammoth-tooth have become stock articles in museums, and every year adds new localities where palæolithic implements are found of the types catalogued years ago by Evans, and in beds agreeing with the sections drawn years ago by Prestwich. It is generally admitted that about the close of the Glacial period savage man killed the huge maned elephants, or fled from the great lions and tigers, on what was then forest-clad valley bottom, in ages before the later waterflow had cut out the present wide valleys 50 or 100 feet or more lower, leaving the remains of the ancient drift-beds exposed high on what are now the slopes. To fix our ideas on the picture of an actual locality, we may fancy ourselves standing with Mr. Spurrell on the old sandy beach of the Thames near Crayford, 35 feet above where the river now flows two miles away in the valley. Here we are on the very workshop-floor where palæolithic man sat chipping at the blocks of flint which had fallen out of the chalk cliff above his head. There lie the broken remains of his blocks, the flint chips he knocked off, and which can be fitted back into their places, the striking-stones with which the flaking was done; and with these the splintered bones of mammoth and tichorhine rhinoceros, possibly remains of meals. Moreover, as if to point the contrast between the rude palæolithic man who worked these coarse blocks, and apparently never troubled himself to seek for better material, the modern visitor sees within fifty yards of the spot the bottle-shaped pits dug out in later ages by neolithic man through the soil to a depth in the chalk where a layer of good workable flint supplied him with the material for his neat flakes and trimly-chipped arrow-heads. The evidence of caverns such as those of Devonshire and Perigord, with their revelations of early European life and art, has been supplemented by many new explorations, without shaking the conclusion arrived at as to the age known as the reindeer period of the northern half of Europe, when the mammoth and cave-bear and their contemporary mammals had not yet disappeared, but the close of the Glacial period was merging into the times when in England and France savages hunted the reindeer for food as the Arctic tribes of America do still. Human remains of these early periods are still scarce and unsatisfactory for determining race-types. Among the latest finds is part of a skull from the loess, at Podbaba, near Prague, with prominent brow-ridges, though less remarkable in this way than the celebrated Neanderthal skull. It remains the prevailing opinion of

anatomists that these very ancient skulls are not apt to show extreme lowness of type, but to be higher in the scale than, for instance, the Tasmanian. The evidence increases as to the wide range of palæolithic man. He extended far into Asia, where his characteristic rude stone implements are plentifully found in the caves of Syria and the foot-hills of Madras. The question which this Section may have especial means of dealing with is whether man likewise inhabited America with the great extinct animals of the Quaternary period, if not even earlier.

Among the statements brought forward as to this subject, a few are mere fictions, while others, though entirely genuine, are surrounded with doubts, making it difficult to use them for anthropological purposes. We shall not discuss the sandalled human giants, whose footprints, 20 inches long, are declared to have been found with the footprints of mammoths, among whom they walked, at Carson, Nevada. There is something picturesque in the idea of a man in a past geological period finding on the Pampas the body of a glyptodon, scooping out its flesh, setting up its carapace on the ground like a monstrous dish-cover, and digging himself a burrow to live in underneath this animal roof; but geologists have not accepted the account. Even in the case of so well-known an explorer as the late Dr. Lund, opinions are still divided as to whether his human skulls from the caves of Brazil are really contemporary with the bones of megatherium and the fossil horse. One of the latest judgments has been favourable: Quatrefages not only looks upon the cave-skulls as of high antiquity, but regards their owners as representing the ancestors of the living Indians. The high and narrow dimensions of the ancient and modern skulls are given in the "Crania Ethnica," and whatever a similarity of proportions between them may prove, it certainly exists. Dr. Koch's celebrated flint arrow-head, recorded to have been found under the leg-bones of a mastodon in Missouri, is still to be seen, and has all the appearance of a modern Indian weapon, which raises doubt of its being really of the mastodon period. This antecedent improbability of remote geological age is felt still more strongly to attach to the stone pestles and mortars, &c., brought forward by Mr. J. D. Whitney, of the California Geological Survey, as found by miners in the gold-bearing gravels. On the one hand, these elaborate articles of stone-work are the very characteristic objects of the Indian graves of the district, and on the other the theory that the auriferous gravels capped by lava-flows are of Tertiary age is absolutely denied by geologists such as M. Jules Marcou in his article on "The Geology of California" (*Bull. Soc. Géol. de France*, 1883). It is to be hoped that the Section may have the opportunity of discussing Dr. C. C. Abbott's implements from Trenton, New Jersey. The turtle back cells, as they are called from their flat and convex sides, are rudely chipped from pebbles of the hard argillite out of the boulder-bed, but the question is as to the position of the sand and gravel in which they are found in the bluffs high above the present Delaware River. The first opinion came to, that the makers of the implements inhabited America not merely after but during the great Ice Age, has been modified by further examination, especially by the report of Mr. H. Carvill Lewis, who considers the implement-bearing bed not to have been deposited by a river which flowed over the top of the boulder-bed, but that, at a later period than this would involve, the Delaware had cut a channel through the boulder-bed, and that a subsequent glacier-flood threw down sand and gravel in this cutting at a considerable height above the existing river, burying therein the rude stone implements of an Esquimaux race then inhabiting the country. Belt, Wilson, and Putnam have written on this question, which I will not pursue further, except by pointing out that the evidence from the bluffs of the Delaware must not be taken by itself, but in connection with that from the terraces high above the James River, near Richmond, where Mr. C. M. Wallace has likewise reported the finding of rude stone instruments, to which must be added other finds from Guanajuato, Rio Juchipila, and other Mexican localities.

This leads at once into the interesting argument how far any existing people are the descendants and representatives of man of the Post-Glacial period. The problem whether the present Esquimaux are such a remnant of an early race is one which Prof. Boyd Dawkins has long worked at, and will, I trust, bring forward with full detail in this appropriate place. Since he stated this view in his work on "Cave-Hunting," it has continually been cited, whether by way of affirmation or denial, but always with that gain to the subject which arises from a theory based on distinct facts. May I take occasion here to mention

as preliminary the question, Were the natives met with by the Scandinavian seafarers of the eleventh century Esquimaux, and whereabouts on the coast were they actually found? It may be to Canadians a curious subject of contemplation how about that time of history Scandinavia stretched out its hands at once to their old and their new home. When the race of bold sea-rovers who ruled Normandy and invaded England turned their prows into the northern and western sea, they passed from Iceland to yet more inclement Greenland, and thence, according to Icelandic records, which are too consistent to be refused belief as to main facts, they sailed some way down the American coast. But where are we to look for the most southerly points which the Sagas mention as reached in Vineland? Where was Keelness, where Thorvald's ship ran aground, and Cross-ness, where he was buried, when he died by the *skráling's* arrow? Rafn, in the "*Antiquitates Americanae*," confidently maps out these places about the promontory of Cape Cod, in Massachusetts, and this has been repeated since from book to book. I must plead guilty to having cited Rafn's map before now, but when with reference to the present meeting I consulted our learned editor of Scandinavian records at Oxford, Mr. Gudbrand Vigfusson, and afterwards went through the original passages in the Sagas with Mr. York Powell, I am bound to say that the voyages of the Northmen ought to be reduced to more moderate limits. It appears that they crossed from Greenland to Labrador (Helluland), and thence sailing more or less south and west, in two stretches of two days each they came to a place near where wild grapes grew, whence they called the country Vineland. This would, therefore, seem to have been somewhere about the Gulf of St. Lawrence, and it would be an interesting object for a yachting cruise to try down from the east coast of Labrador a fair four days' sail of a Viking ship, and identify, if possible, the sound between the island and the ness, the river running out of the lake into the sea, the long stretches of sand, and the other local features mentioned in the Sagas. While this is in the printers' hands, I hear that a paper somewhat to this same effect may come before the Geographical Section, but the matter concerns us here as bearing on the southern limit of the Esquimaux. The *skrálings* who came on the sea in skin canoes (*hu-thkeipr*), and hurled their spears with slings (*valsöngva*), seem by these very facts to have been probably Esquimaux, and the mention of their being swarthy, with great eyes and broad cheeks, agrees tolerably with this. The statement usually made that the word *skráling* meant "dwarf" would, if correct, have settled the question; but, unfortunately, there is no real warrant for this etymology. If we may take it that Esquimaux 800 years ago, before they had ever found their way to Greenland, were hunting seals on the coast of Newfoundland, and cariboo in the forest, their life need not have been very unlike what it is now in their Arctic home. Some day, perhaps, the St. Lawrence and Newfoundland shores will be searched for relics of Esquimaux life, as has been done with such success in the Aleutian Islands by Mr. W. H. Dall, though on this side of the continent we can hardly expect to find, as he does, traces of long residence, and rise from a still lower condition.

Surveying now the vast series of so-called native, or indigenous, tribes of North and South America, we may admit that the fundamental notion on which American anthropology has to be treated is its relation to Asiatic. This kind of research is, as we know, quite old, but the recent advances of zoology and geology have given it new breadth as well as facility. The theories which account for the wide-lying American tribes, disconnected by language as they are, as all descended from ancestors who came by sea in boats, or across Behring's Straits on the ice, may be felt somewhat to strain the probabilities of migration, and are likely to be remodelled under the information now supplied by geology as to the distribution of animals. It has become a familiar fact that the Equidae, or horse-like animals, belong even more remarkably to the New than to the Old World. There was plainly land-connection between America and Asia for the horses whose remains are fossil in America to have been genetically connected with the horses re-introduced from Europe. The deer may have passed from the Old World into North America in the Pliocene period; and the opinion is strongly held that the camels came the other way, originating in America and spreading thence into Asia and Africa. The mammoth and the reindeer did not cross over a few thousand years ago by Behring's Straits, for they had been since Pleistocene times spread over the north of what was then one continent. To realise this ancient land-connection of Asia and

America, this "Tertiary-bridge," to use Prof. Marsh's expression, it is instructive to look at Mr. Wallace's chart of the present soundings, observing that an elevation of under 200 feet would make Behring's Straits land, while moderately shallow sea extends southward to about the line of the Aleutian Islands, below which comes the plunge into the ocean depths. If, then, we are to consider America as having received its human population by ordinary migration of successive tribes along this highway, the importance is obvious of deciding how old man is in America, and how long the continent remained united with Asia, as well as how these two difficult questions are bound up together in their bearing on anthropology. Leaving them to be settled by more competent judges, I will only point out that the theory of northern migration on dry land is after all only a revival of an old opinion which came naturally to Acosta in the sixteenth century, because Behring's Straits were not yet known of, and was held by Buffon in the eighteenth, because the zoological conditions compelled him to suppose that Behring's Straits had not always been there. Such a theory, whatever the exact shape it may take, seems wanted for the explanation of that most obvious fact of anthropology, the analogy of the indigenes of America with Asiatics, and more especially with East and North Asiatics or Mongoloids. This broad race-generalisation has thrust itself on every observer, and each has an instance to mention. My own particular instance is derived from inspection of a party of Botocudo Indians lately exhibited in London, who in proper clothing could have passed without question as Tibetans or Siamese. Now when ethnologists like Dr. Pickering remark on the South Asiatic appearance of Californian tribes, it is open to them to argue that Japanese sailors of junks wrecked on the coast may have founded families there. But the Botocudos are far south and on the other side of the Andes, rude dwellers in the forests of Brazil, and yet they exhibit in an extreme form the Mongoloid character which makes America to the anthropologist part and parcel of Asia. Looked at in this light, there is something suggestive in our still giving to the natives of America the name of Indians; the idea of Columbus that the Caribs were Asiatics was not so absurd after all.

It is perhaps hardly needful now to protest against stretching the generalisation of American uniformity too far, and taking literally Humboldt's saying that he who has seen one American has seen all. The common character of American tribes, from Hudson's Bay to Tierra del Fuego, though more homogeneous than on any other tract of the world of similar extent, admits of wide subvariation. How to distinguish and measure this subvariation is a problem in which anthropology has only reached unsatisfactory results. The broad distinctions which are plainly seen are also those which are readily defined, such as the shape of the nose, curve of the lips, or the projection of the cheek-bones. But all who have compared such American races as Aztecs and Ojibwas must be sensible of extreme difficulty in measuring the proportions of an average facial type. The attempt to give in a single pair of portraits a generalised national type has been tried—for instance, in the St. Petersburg set of models of races at the Exhibition of 1862. But done merely by eye, as they were, they were not so good as well-chosen individual portraits. It would be most desirable that Mr. Francis Galton's method of photographs superposed so as to combine a group of individuals into one generalised portrait, should have a thorough trial on groups of Iroquois, Aztecs, Caribs, and other tribes who are so far homogeneous in feature as to lend themselves to form an abstract portrait. A set of American races thus "Galtonised" (if I may coin the term) would very likely be so distinctive as to be accepted in anthropology. Craniological measurement has been largely applied in America, but unfortunately it was set wrong for years by the same misleading tendency to find a uniformity not really existent. Those who wish to judge Morton's dictum applied to the Scioto Mound skull, "the perfect type of Indian conformation, to which the skulls of all the tribes from Cape Horn to Canada more or less approximate," will find facts to the contrary set forth in Chap. XX. of Wilson's "*Prehistoric Man*," and in Quatrefages and Hany, "*Crania Ethnica*." American crania really differ so much that the hypothesis of successive migrations has been brought in to account for the brachycephalic skulls of the mound-builders as compared with living Indians of the district. Among minor race-divisions, as one of the best established may be mentioned that which in this district brings the Algonquin and Iroquois together into the dolichocephalic division;

yet even here some divide the Algonquins into two groups by their varying breadth of skull. What may be the interpretation of the cranial evidence as bearing on the American problem it would be premature to say; at present all that can be done is to systematise facts. It is undisputed that the Esquimaux in their complexion, hair, and features approximate to the Mongoloid type of North Asia; but when it comes to cranial measurement the Esquimaux, with their narrower skulls, whose proportion of breadth to length is only 75 to 80, are far from conforming to the broad-skulled type of North Asiatic Mongoloids, whose average index is toward 85. Of this divergence I have no explanation to offer; it illustrates the difficulties which have to be met by a young and imperfect science.

To clear the obscurity of race-problems, as viewed from the anatomical standing point, we naturally seek the help of language. Of late years the anthropology of the Old World has had ever-increasing help from comparative philology. In such investigations, when the philologist seeks a connection between the languages of distant regions, he endeavours to establish both a common stock of words and a common grammatical structure. For instance, this most perfect proof of connection has been lately adduced by Mr. R. H. Codrington in support of the view that the Melanesians and Polynesians, much as they differ in skin and hair, speak languages which belong to a common stock. A more adventurous theory is that of Lenormant and Sayce, that the old Chaldean language is connected with the Tatar group; yet even here there is an *a priori* case based at once on analogies of dictionary and grammar. The comparative method becomes much weaker when few or no words can be claimed as similar, and the whole burden of proof has to be borne by similar modes of word-formation and syntax, as, for example, in the researches of Aymonier and Keane tending to trace the Malay group of languages into connection with the Khmer or Cambodian. Within America the philologist uses with success the strong method of combined dictionary and grammar in order to define his great language-groups, such as the Algonquin, extending from Hudson's Bay to Virginia, the Athabascan, from Hudson's Bay to New Mexico, both crossing Canada in their vast range. But attempts to trace analogies between lists of words in Asiatic and American languages, though they may have shown some similarities deserving further inquiry, have hardly proved an amount of correspondence beyond what chance coincidence would be capable of producing. Thus when it comes to judging of affinities between the great American language-families, or of any of them, with the Asiatic, there is only the weaker method of structure to fall back on. Here the Esquimaux analogy seems to be with North Asiatic languages. It would be defined as agglutinative-suffixing, or, to put the definition practically, an Esquimaux word of however portentous length, is treated by looking out in the dictionary the first syllable or two, which will be the root, the rest being a string of modifying suffixes. The Esquimaux thus presents in an exaggerated form the characteristic structure of the vast Ural-Altaic or Turanian group of Asiatic languages. In studying American languages as a whole, the first step is to discard the generalisation of Duponceau as to the American languages from Greenland to Cape Horn being united together, and distinguished from those of other parts of the world by a common character of polysynthetism, or combining whole sentences into words. The real divergences of structure in American language-families are brought clearly into view in the two dissertations of M. Lucien Adam, which are the most valuable papers of the Congrès International des Americanistes. Making special examination of sixteen languages of North and South America, Adam considers these to belong to a number of independent or irreducible families, as they would have been, he says, "had there been primitively several human couples." It may be worth suggesting, however, that the task of the philologist is to exhaust every possibility of discovering connections between languages before falling back on the extreme hypothesis of independent origins. These American language-families have grammatical tendencies in common, which suggest original relationship, and in some of these even correspond with languages of other regions in a way which may indicate connection rather than chance. For instance, the distinction of gender, not by sex as male and female, but by life as animate and inanimate, is familiar in the Algonquin group; in Cree *muskasin* = shoe (moccasin) makes its plural *mushkesinô*, while *eskwayû* = woman (squaw) makes its plural *eskwayumk*. Now, this kind of gender is not peculiar to America, but appears in South-East Asia, as for instance in the Kol lan-

guages of Bengal. In that Asiatic district also appears the habit of infixing, that is, of modifying roots or words by the insertion of a letter or syllable, somewhat as the Dakota language inserts a pronoun within the verb-root itself, or as that remarkable language, the Chocta, alters its verbs by insertions of a still more violent character. Again, the distinction between the inclusive and exclusive pronoun *we*, according as it means "You and I" or "they and I," &c. (the want of which is perhaps a defect in English), is as familiar to the Maori as to the Ojibwa. Whether the languages of the American tribes be regarded as derived from Asia or as separate developments, their long existence on the American continent seems unquestionable. Had they been the tongues of tribes come within a short time by Behring's Straits, we should have expected them to show clear connection with the tongues of their kindred left behind in Asia, just as the Lapp in Europe, whose ancestors have been separated for thousands of years from the ancestors of the Ostyak or the Turk, still shows in his speech the traces of their remote kinship. The problem how tribes so similar in physical type and culture as the Algonquins, Iroquois, Sioux, and Athabascans, should adjoin one another, yet speaking languages so separate, is only soluble by influences which have had a long period of time to work in.

The comparison of peoples according to their social framework of family and tribe has been assuming more and more importance since it was brought forward by Bachofen, McLennan, and Morgan. One of its broadest distinctions comes into view within the Dominion of Canada. The Esquimaux are patriarchal, the father being head of the family, and descent and inheritance following the male line. But the Indian tribes further south are largely matriarchal, reckoning descent not on the father's but the mother's side. In fact, it was through becoming an adopted Iroquois that Morgan became aware of this system, so foreign to European ideas, and which he supposed at first to be an isolated peculiarity. No less a person than Herodotus had fallen into the same mistake over 2000 years ago, when he thought the Lykians, in taking their names from their mothers, were unlike all other men. It is now, however, an accepted matter of anthropology that in Herodotus's time nations of the civilised world had passed through this matriarchal stage, as appears from the survivals of it retained in the midst of their newer patriarchal institutions. For instance, among the Arabs to this day, strongly patriarchal as their society is in most respects, there survives that most matriarchal idea that one's nearest relative is not one's father but one's maternal uncle; he is bound to his sister's children by a "closer and holier tie" than paternity, as Tacitus says of the same conception among the ancient Germans. Obviously great interest attaches to any accounts of existing tribes which preserve for us the explanation of such social phenomena. Some of the most instructive of these are too new to have yet found their way into our treatises on early institutions; they are accounts lately published by Dutch officials among the non-Islamised clans of Sumatra and Java. G. A. Wilken, "Over de Verwantschap en het Huwelijks en Erfrecht bij de Volken van den Indischen Archipel," summarises the account put on record by Van Hasselt as to the life of the Malays of the Padang Highlands of Mid-Sumatra, who are known to represent an early Malay population. Among these people not only kinship but habitation follows absolutely the female line, so that the numerous dwellers in one great house are all connected by descent from one mother, one generation above another, children, then mothers and maternal uncles and aunts, then grandmothers and maternal great-uncles and great-aunts, &c. There are in each district several *suku* or mother-clans, between persons born in which marriage is forbidden. Here then appear the two well-known rules of female descent and exogamy, but now we come into view of the remarkable state of society that, though marriage exists, it does not form the household. The woman remains in the maternal house she was born in, and the man remains in his; his position is that of an authorised visitor; if he will, he may come over and help her in the rice-field, but he need not; over the children he has no control whatever, and were he to presume to order or chastise them, their natural guardian, the mother's brother (*mamak*), would resent it as an affront. The law of female descent and its connected rules have as yet been mostly studied among the native Americans and Australians, where they have evidently undergone much modification. Thus 150 years ago Father Lafitau mentions that the husband and wife, while in fact moving into one another's hut, or setting up a new one, still kept up the matriarchal idea by the fiction that neither he nor she quitted

their own maternal house. But in the Sumatra district just referred to, the matriarchal system may still be seen in actual existence, in a most extreme and probably early form. If, led by such new evidence, we look at the map of the world from this point of view, there discloses itself a remarkable fact of social geography. It is seen that matriarchal exogamous society, that is, society with female descent and prohibition of marriage within the clan, does not crop up here and there, as if it were an isolated invention, but characterises a whole vast region of the world. If the Malay district be taken as a centre, the system of intermarrying mother-clans may be followed westward into Asia, among the Garos and other hill-tribes of India. Eastward from the Indian Archipelago it pervades the Melanesian islands, with remains in Polynesia; it prevails widely in Australia, and stretches north and south in the Americas. This immense district represents an area of lower culture, where matriarchalism has only in places yielded to the patriarchal system, which develops with the idea of property, and which, in the other and more civilised half of the globe, has carried all before it, only showing in isolated spots and by relics of custom the former existence of matriarchal society. Such a geographical view of the matriarchal region makes intelligible facts which while not thus seen together were most puzzling. When years ago Sir George Grey studied the customs of the Australians, it seemed to him a singular coincidence that a man whose maternal family name was Kangaroo might not marry a woman of the same name, just as if he had been a Huron of the Bear or Turtle totem, prohibited accordingly from taking a wife of the same. But when we have the facts more completely before us, Australia and Canada are seen to be only the far ends of a world-district pervaded by these ideas, and the problem becomes such a one as naturalists are quite accustomed to. Though Montreal and Melbourne are far apart, it may be that in prehistoric times they were both connected with Asia by lines of social institution as real as those which modern times connect them through Europe. Though it is only of late that this problem of ancient society has received the attention it deserves, it is but fair to mention how long ago its scientific study began in the part of the world where we are assembled. Father Lafitau, whose "*Mœurs des Sauvages Américains*" was published in 1724, carefully describes among the Iroquois and Hurons the system of kinship to which Morgan has since given the name of "classificatory," where the mother's sisters are reckoned as mothers, and so on. It is remarkable to find this acute Jesuit missionary already pointing out how the idea of the husband being an intruder in his wife's house bears on the pretence of surreptitiousness in marriage among the Spartans. He even rationally interprets in this way a custom which to us seems fantastic, but which is a most serious observance among rude tribes widely spread over the world. A usual form of this custom is that the husband and his parents-in-law, especially his mother-in-law, consider it shameful to speak to or look at one another, hiding themselves or getting out of the way, at least in pretence, if they meet. The comic absurdity of these scenes, such as Tanner describes among the Assiniboins, disappears if they are to be understood as a legal ceremony, implying that the husband has nothing to do with his wife's family. To this part of the world also belongs a word which has been more effective than any treatise in bringing the matriarchal system of society into notice. This is the term *totem*, introduced by Schoolcraft to describe the mother-clans of the Algonquins, named "Wolf," "Bear," &c. Unluckily the word is wrongly made. Prof. Max Müller has lately called attention to the remark of the Canadian philologist Father Cuoq (N. O. Ancien Missionnaire), that the word is properly *otem*, meaning "family mark," possessive *otem*, and with the personal pronoun *nind otem*, "my family mark," *kut otem*, "thy family mark." It may be seen in Schoolcraft's own sketch of Algonquin grammar how he erroneously made from these a word *totem*, and the question ought perhaps to be gone into in this Section, whether the term had best be kept up or amended, or a new term substituted. It is quite worth while to discuss the name, considering what an important question of anthropology is involved in the institution it expresses. In this region there were found Iroquois, Algonquins, Dakotas, separate in language, and yet whose social life was regulated by the matriarchal totem structure. May it not be inferred from such a state of things that social institutions form a deeper-lying element in man than language or even physical race-type? This is a problem which presents itself for serious discussion when the evidence can be brought more completely together.

It is obvious that in this speculation, as in other problems now presenting themselves in anthropology, the question of the antiquity of man lies at the basis. Of late no great progress has been made toward fixing a scale of calculation of the human period, but the arguments as to time required for alterations in valley-levels, changes of fauna, evolution of races, languages, and culture, seem to converge more conclusively than ever toward a human period short indeed as a fraction of geological time, but long as compared with historical or chronological time. While, however, it is felt that length of time need not debar the anthropologist from hypotheses of development and migration, there is more caution as to assumptions of millions of years where no arithmetical basis exists, and less tendency to treat everything prehistoric as necessarily of extreme antiquity, such as, for instance, the Swiss lake-dwellings and the Central American temples. There are certain problems of American anthropology which are not the less interesting for involving no considerations of high antiquity; indeed they have the advantage of being within the check of history, though not themselves belonging to it.

Humboldt's argument as to traces of Asiatic influence in Mexico is one of these. The four ages in the Aztec picture-writings, ending with catastrophes of the four elements, earth, fire, air, water, compared by him with the same scheme among the Banyans of Surat, is a strong piece of evidence which would become yet stronger if the Hindoo book could be found from which the account is declared to have been taken. Not less cogent is his comparison of the zodiacs or calendar-cycles of Mexico and Central America with those of Eastern Asia, such as that by which the Japanese reckon the Sixty-year cycle by combining the elements seriatim with the twelve animals, Mouse, Bull, Tiger, Hare, &c.; the present year is, I suppose, the second water-ape year, and the time of day is the goat-hour. Humboldt's case may be reinforced by the consideration of the magical employment of these zodiacs in the Old and New World. The description of a Mexican astrologer, sent for to make the arrangements for a marriage by comparing the zodiac animals of the birthdays of bride and bridegroom, might have been written almost exactly of the modern Kalnuk; and in fact it seems connected in origin with similar rules in our own books of astrology. Magic is of great value in thus tracing communication, direct or indirect, between distant nations. The power of lasting and travelling which it possesses may be instanced by the rock-pictures from the sacred Roches Percées of Manitoba, sketched by Dr. Dawson, and published in his father's volume on "Fossil Man," with the proper caution that the pictures, or some of them, may be modern. Besides the rude pictures of deer and Indians and their huts, one sees with surprise a pentagram more neatly drawn than that defective one which let Mephistopheles pass Faust's threshold, though it kept the demon in when he had got there. Whether the Indians of Manitoba learnt the magic figure from the white man, or whether the white man did it himself in jest, it proves a line of intercourse stretching back 2500 years to the time when it was first drawn as a geometrical diagram of the school of Pythagoras. To return to Humboldt's argument, if there was communication from Asia to Mexico before the Spanish Conquest, it ought to have brought other things, and no things travel more easily than games. I noticed some years ago that the Aztecs are described by the old Spanish writers as playing a game called *patolli*, where they moved stones on the squares of a cross-shaped mat, according to the throws of beans marked on one side. The description minutely corresponds with the Hindoo game of *pachisi*, played in like manner with cowries instead of beans; this game, which is an early variety of backgammon, is well known in Asia, whence it seems to have found its way into America. From Mexico it passed into Sonora and Zacatecas, much broken down, but retaining its name, and it may be traced still further into the game of plumbstones among the Iroquois and other tribes. Now, if the probability be granted that these various American notions came from Asia, their importation would not have to do with any remotely ancient connection between the two continents. The Hindoo element-catastrophes, the East Asiatic zodiac-calendars, the game of backgammon, seem none of them extremely old, and it may not be a thousand years since they reached America. These are cases in which we may reasonably suppose communication by seafarers, perhaps even in some of those junks which are brought across so often by the ocean-current and wrecked on the Californian coast. In connection with ideas borrowed from Asia there arises the question, How did the Mexicans and

Peruvians become possessed of bronze? Seeing how imperfectly it had established itself, not even dispossessing the stone implements, I have long believed it to be an Asiatic importation of no great antiquity, and it is with great satisfaction that I find such an authority on prehistoric archaeology as Prof. Worsaae comparing the bronze implements in China and Japan with those of Mexico and Peru, and declaring emphatically his opinion that bronze was a modern novelty introduced into America. While these items of Asiatic culture in America are so localised as to agree best with the hypothesis of communication far south across the Pacific, there are others which agree best with the routes far north. A remarkable piece of evidence pointed out by General Pitt-Rivers is the geographical distribution of the Tatar or composite bow, which in construction is unlike the long-bow, being made of several pieces spliced together, and which is bent backwards to string it. This distinctly Asiatic form may be followed across the region of Behring's Straits into America among the Esquimaux and northern Indians, so that it can hardly be doubted that its coming into America was by a northern line of migration. This important movement in culture may have taken place in remotely ancient times.

A brief account may now be given of the present state of information as to movements of civilisation within the double continent of America. Conspicuous among these is what may be called the northward drift of civilisation which comes well into view in the evidence of botanists as to cultivated plants. Maize, though allied to, and probably genetically connected with, an Old World graminaceous family, is distinctly American, and is believed by De Candolle to have been brought into cultivation in Peru, whence it was carried from tribe to tribe up into the north. To see how closely the two continents are connected in civilisation, one need only look at the distribution on both of maize, tobacco, and cacao. It is admitted as probable that from the Mexican and Central American region agriculture travelled northward, and became established among the native tribes. This direction may be clearly traced in a sketch of their agriculture, such as is given in Mr. Lucien Carr's paper on the "Mounds of the Mississippi Valley." The same staple cultivation passed on from place to place, maize, haricots, pumpkins, for food, and tobacco for luxury. Agriculture among the Indians of the great lakes is plainly seen to have been an imported craft by the way in which it had spread to some tribes but not to others. The distribution of the potter's art is similarly partial, some tribes making good earthen vessels, while others still boiled meat in its own skin with hot stones, so that it may well be supposed that the arts of growing corn and making the earthen pot to boil the hominy came together from the more civilised nations of the south. With this northward drift of civilisation other facts harmonise. The researches of Buschmann, published by the Berlin Academy, show how Aztec words have become embedded in the languages of Sonora, New Mexico, and up the western side of the continent, which could not have spread there without Mexican intercourse extending far north-west. This indeed has left many traces still discernible in the industrial and decorative arts of the Pueblo Indians. Along the courses of this northward drift of culture remain two remarkable series of structures probably connected with it. The Casas Grandes, the fortified communal barracks (if I may so call them) which provided house-room for hundreds of families, excited the astonishment of the early Spanish explorers, but are only beginning to be thoroughly described now that such districts as the Taos Valley have come within reach by the railroads across to the Pacific. The accounts of these village-forts and their inhabitants, drawn up by Major J. W. Powell, of the Bureau of Ethnology, and Mr. Putnam of the Peabody Museum, disclose the old communistic society surviving in modern times, in instructive comment on the philosophers who are seeking to return to it. It would be premature in the present state of information to decide whether Mr. J. L. Morgan, in his work on the "Houses and House-life of the American Aborigines," has realised the conditions of the problem. It is plausible to suppose with him a connection between the communal dwellings of the American Indians, such as the Iroquois long-house with its many family hearths, with the more solid buildings inhabited on a similar social principle by tribes such as the Zúñis of New Mexico. Morgan was so much a man of genius, that his speculations, even when at variance with the general view of the facts, are always suggestive. This is the case with his attempt to account for the organisation of the Aztec State as a highly-developed Indian tribal community, and even to explain the many-roomed stone palaces, as they are called, of Central

America, as being huge communal dwellings like those of the Pueblo Indians. I will not go further into the subject here, hoping that it may be debated in the Section by those far better acquainted with the evidence. I need not, for the same reason, do much more than mention the mound-builders, nor enter largely on the literature which has grown up about them since the publication of the works of Squier and Davis. Now that the idea of their being a separate race of high antiquity has died out, and their earthworks with the implements and ornaments found among them are brought into comparison with those of other tribes of the country, they have settled into representatives of one of the most notable stages of the northward drift of culture among the indigenes of America.

Concluding this long survey, we come to the practical question how the stimulus of the present meeting may be used to promote anthropology in Canada. It is not as if the work were new here; indeed some of its best evidence has been gathered on this ground from the days of the French missionaries of the seventeenth century. Naturally, in this part of the country, the rudimentary stages of thought then to be found among the Indians have mostly disappeared. For instance, in the native conceptions of souls and spirits the crudest animistic ideas were in full force. Dreams were looked on as real events, and the phantom of a living or a dead man seen in a dream was considered to be that man's personality and life, that is, his soul. Beyond this, by logical extension of the same train of thought, every animal or plant or object, inasmuch as its phantom could be seen away from its material body in dreams or visions, was held to have a soul. No one ever found this primitive conception in more perfect form than Father L'Allemand, who describes, in the "Relations des Jésuites" (1626), how, when the Indians buried kettles and furs with the dead, the bodies of these things remained, but the souls of them went to the dead men who used them. So Father Le Jeune describes the souls, not only of men and animals, but of hatchets and kettles, crossing the water to the Great Village out in the sunset. The genuineness of this idea of object-souls is proved by other independent explorers finding them elsewhere in the world. Two of the accounts most closely tallying with the American come from the Rev. Dr. Mason, in Burmah, and the Rev. J. Williams, in Fiji. That is to say, the most characteristic development of early animism belongs to the same region as the most characteristic development of matriarchal society, extending from South-East Asia into Melanesia and Polynesia, and North and South America. Every one who studies the history of human thought must see the value of such facts as these, and the importance of gathering them up among the rude tribes who preserve them, before they pass into a new stage of culture. All who have read Mr. Hale's studies on the Hiawatha legend and other Indian folk-lore, must admit that the native traditions, with their fragments of real history, and their incidental touches of native religion, ought never to be left to die out unrecorded. In the Dominion, especially in its outlying districts toward the Arctic region and over the Rocky Mountains, there is an enormous mass of anthropological material of high value to be collected, but this collection must be done within the next generation, or there will be little left to collect. The small group of Canadian anthropologists, able and energetic as they are, can manage and control this work, but cannot do it all themselves. What is wanted is a Canadian Anthropological Society with a stronger organisation than yet exists, able to arrange explorations in promising districts, to circulate questions and requirements among the proper people in the proper places, and to lay a new burden on the shoulders of the already hard-worked professional men and other educated settlers through the newly-opened country, by making them investigators of local anthropology. The Canadian Government, which has well deserved the high reputation it holds throughout the world for wisdom and liberality in dealing with the native tribes, may reasonably be asked to support more thorough exploration, and collection and publication of the results, in friendly rivalry with the United States Government, which has in this way fully acknowledged the obligation of making the colonisation of new lands not only promotive of national wealth but serviceable to science. It is not for me to do more here, and now, than to suggest practical steps towards this end. My laying before the Section so diffusive a sketch of the problems of anthropology as they present themselves in the Dominion has been with the underlying intention of calling public notice to the important scientific work now standing ready to Canadian hands; the undertaking of which it is to be hoped will be one outcome of this visit of the British Association to Montreal.

COMETS<sup>1</sup>

FOR several months past I have anxiously considered how I could best discharge the honourable duty which has been intrusted to me this evening. I have to deliver an astronomical discourse, and to do my very utmost to make that discourse adequate to the subject, adequate to this large and cultivated audience, and adequate to the memorable occasion on which the British Association has first crossed the Atlantic Ocean.

I propose to address you this evening on the subject of comets, but it will be readily understood that, of a subject so vast and so elaborate, only a slender proportion can be comprised within a single lecture. The first question to be decided was how to select from the vast mass of materials those which would be most suitable for our discussion this evening. To describe the natural history of comets with any approach to completeness would be a very tedious, indeed almost an endless, task. We must rather select those episodes in the history which have especially added to our knowledge, and enabled us to obtain a rational view of the whole subject. Does not Longfellow tell us how impossible it would have been for him to portray the fortunes of Evangeline throughout every detail? He has only disclosed to us the picturesque and eventful phases of that history. May I be permitted to say that I desire to treat my subject in a similar manner, and while concentrating my attention on the really important matters I shall yet follow the wanderers' footsteps, "not through each devious path, each changeful year of existence."

In pursuance of this scheme I shall at a single blow lop off all the earlier parts of the history. The great primitive discoveries of the character of comets and of their movements must be entirely omitted. The splendid researches of Sir Isaac Newton, and the classical achievement of Halley, are among this class. They are no doubt familiar to every cultivated mind, for they belong to that wondrous alliance between mathematics and astronomy which imparts a thrill of pleasure to the generous intellect. They are not for our discussion to-night.

I shall only address you upon the more recent acquisitions to our knowledge of comets, and in order to give definiteness to our programme, I shall select a certain epoch not yet twenty years old, which is to bound our retrospect into time past. There is a special appropriateness in the choice of the year 1866 as a starting point for the modern history of comets. A very memorable occurrence in that year attracted universal attention, and threw much and quite unexpected light on the nature of comets. The review of the subject given in this lecture will extend from the year 1866 to the present time. But even in this restricted interval it will not be practicable for me to give anything like an exhaustive account of the different researches that have been made. Every astronomical journal teems with observations of comets. Every year brings us one, or two, or three, or more comets; organised efforts are made to observe these comets to the utmost, and each season has its own harvest of discoveries. Amid this host of claimants for our attention we must wend our way this evening, glancing at some discoveries, according to others such notice as their importance may merit, but reserving special attention for the three monumental achievements in the modern history of comets. These are, firstly, the determination of the connection between comets and shooting stars; secondly, the spectroscopic researches on comets; and thirdly, the investigations of the tails of comets. The first of these subjects must be for ever associated with the name of Professor Schiaparelli, the second with the name of Dr. Huggins, the third with the name of Professor Bredichin.

It was long ago remarked by Kepler, in language of splendid exaggeration, that there were as many comets in the heavens as there were fishes in the ocean. There are comets large and comets small, comets with one tail, comets with two tails, and comets without any tail at all. Comets appear at uncertain and irregular intervals, they are not confined to any special part of the heavens. A comet may be first discovered in one constellation, and after a journey across the heavens it may sink to invisibility in any other constellation. A comet is sometimes only seen for days or for weeks, but sometimes it remains visible for months or even for years. The features of the comet itself are also in a course of incessant transformation during its visit. Its size and its shape are not constant. The interval of a few days, or sometimes of even a few hours, suffices to work wondrous changes in a body almost spiritual in its texture.

Amid all these elements of confusion where are we to seek for

<sup>1</sup> Lecture by Prof. R. S. Ball, Astronomer-Royal for Ireland, at the Montreal meeting of the British Association.

the law and the order which really underlie the phenomena? There is law and there is order. Each one of the myriad comets pursues a definite high-road through space. It is in the province of the mathematician and the astronomer to ascertain by their joint labours what the path is for each comet. The astronomer directs his telescope to the comet, and he reads from the graduated circles attached to his telescope the precise point in the heavens where the comet is located. He repeats this observation a few nights later, he does it a third time, and his work is done. All the mathematician absolutely requires is to know the place of the comet accurately on three nights. He will no doubt be glad to accept further observations; they will help to eliminate the errors inseparable from such labours; they will enable him to obtain three places of the comet purged from all sources of uncertainty. The comet is then within his toils. He can determine the route which the comet is pursuing. He can by his calculations follow the comet in its movements through the profundity of space far beyond the penetration of the telescope. The telescope only watches the comet during a brief portion of its career, but the subtle eye of the mathematician seldom loses sight of a comet once detected. He watches it recede to its greatest distance; he knows when the comet begins to return; he sees how it gradually approaches the sun. He assigns the spot on the heavens where the comet is first to appear, and he tells the day and sometimes even the hour when the telescope will welcome the wanderer's return.

It has long been known that the highway of each comet is one of those graceful curves known to geometers as conic sections. The comets which appear only once sweep through our system in a curve which cannot be distinguished from a perfect parabola. The small but exceedingly interesting class of comets which return periodically revolve in the most beautiful of all curves—the ellipse. The supreme law of gravitation has ordained that the comets must follow a conic section whereof the sun lies at one of the foci. But subject to this imperative restriction the orbit of a comet may have every degree of variety. A comet may revolve in a path so small that it only requires three years to complete a revolution. Another comet moving in a much longer ellipse will require seventy-five years. There may be every intermediate gradation, and there are some cometary orbits so vast that the mighty journey cannot be accomplished in less than thousands of years, while there are others whose orbits stretch out to a distance so stupendous that we fail to follow them in their wanderings. The ellipses seem to be utterly interminable, and in the language of mathematics we say that the orbit is parabolic.

In order to enunciate the first of the great modern discoveries which we are to consider to-night, it is necessary to associate with each comet a certain particular elliptic path lying in a particular plane with a particular position in that plane, and with a particular magnitude. The comet is, in fact, to be identified by its path as its only permanent characteristic, for, though the comets may exist in myriads, yet no two comets follow the same course through space: such a contingency is too remote to be worthy of serious contemplation; it is, in fact, infinitely improbable.

There is not, I believe, a greater surprise in the whole of modern astronomy than the discovery of a myriad of small bodies stealthily accompanying a comet in its mighty journey, and the surprise is all the greater when we consider that in another aspect we have been long familiar with these small bodies, and we have called them shooting stars or luminous meteors. It was Schiaparelli who first demonstrated, in 1866, the wholly unlooked-for connection between the showers of shooting stars and the movements of comets.

Every one is familiar with the very beautiful spectacle of a shooting star, which is seen to flash into the air and vanish in a streak of splendour. These little bodies were long an enigma in astronomy, but they have gradually been subordinated to law and order. It has been found that the sun which controls the mighty Jupiter does not disdain to guide with equal care the tiny shooting stars, and their movements are now tolerably well known. The received doctrine about the shooting stars has stood the severest test known to science—that is, the test of fulfilled prediction. The first great prediction in this refined branch of astronomy was made about twenty years ago. It was foretold that a splendid shower of shooting stars would occur on the night of November 12th, 1866. All the world knows how triumphantly this prediction was fulfilled.

If I may be permitted, I would wish to narrate in a few words my own experience of that ever-memorable night. The details of that majestic spectacle have been engraved on my memory.

I have had the good fortune to see other striking astronomical phenomena. The first was the glorious comet of 1858, the last was the transit of Venus in 1882; but I have no hesitation in saying that no phenomenon I have ever seen in the heavens, and no spectacle that I have ever witnessed on the earth, has impressed me so deeply and so profoundly as the great shower of shooting stars in 1866.

I was at that time astronomer to the late Earl of Rosse, at Parsonstown, and in the autumn of the year I attended my first meeting of the British Association at Nottingham. From the lips of my esteemed friend, Mr. James Glaisher, I learned that a great shooting star shower was to be anticipated on the 12th of November. The prediction could not be put forward with all the confidence that we have when the almanac foretells an eclipse. It was rather a venture, by which an important theory was to be put to a severe test.

On the ever-memorable night I was occupied as usual in observing nebulae with the present Earl of Rosse at the great reflecting telescope. In the early part of the evening the sky was clear, and the night was dark; but no unusual phenomenon occurred until about ten o'clock. I was at that moment watching a nebula at the eye-piece, when I was startled by an exclamation from the assistant by my side. I looked up just in time to see a superb shooting star stream across the heavens. Soon came another star, and then another, and then in twos and in threes. We saw at once that the prediction was about to be verified. We ceased the observations with the telescope and ascended to the top of the wall, which forms one of the supports of the great telescope. This position commanded an extensive view of the heavens, and from it Lord Rosse and myself, on a beautiful starlight night, witnessed that gorgeous display of celestial fireworks which has given fresh impetus to astronomy.

It was not merely the incredible number of the shooting stars that was remarkable. They came no doubt in thousands which no man could number, but what was especially to be noticed was the intrinsic brilliancy of each individual star. There were innumerable meteors that night any one of which would have elicited a note of admiration on any ordinary occasion. As the night wore on and the constellation of Leo climbed up from the east, then the display exhibited a very interesting and characteristic feature, for, as each shooting star was projected across the sky, the track which it followed was invariably directed from the constellation of Leo, nay, even from a particular point in that constellation. So marked a property of the shower suggests an appropriate name, and accordingly this particular group of shooting stars bears the not unpleasing name of the "Leonids."

It is easy to demonstrate that the apparent radiation of the meteors from a point is only the effect of perspective. They are really moving in parallel lines. Those parallel lines have a vanishing point, and that point is the radiant in the constellation of Leo. As we stood on the walls of the great telescope we saw the true character of the radiant most beautifully demonstrated. Those meteors which appeared close to the radiant pursued a track which was greatly foreshortened. A few that were actually at the radiant, or very close to it, had no visible track at all, they merely shone like a very rapidly variable star, which rose from invisibility to brilliancy, and then again declined to evanescence, all within the space of a very few seconds. In these exceptional cases we viewed the track of the stars "end on." They were, in fact, coming straight at us, but fortunately there was a kindly screen which shielded the earth that night from the awful meteoric tempest. Each one of those meteors hurries along with a velocity truly appalling; it is more than a hundred times swifter than the swiftest bullet that was ever fired from a rifle. It is really the demoniacal impetuosity of this velocity which is the source of the earth's safety. The meteor moving freely through space suddenly plunges into our atmosphere. Instantly a gigantic resisting force is aroused. The velocity of the meteor is checked, and the energy stored in that velocity is transformed into heat. That heat is enough to raise the body red hot, to raise it white hot, nay, even to drive the solid mass into a streak of harmless vapour. Of all the countless myriads of shooting stars which went to their destruction on that night, not one single particle has ever been recovered. These facts, when placed in the crucible of the mathematician, conduct him to a solution of the problem as to the nature of the great shooting star shower. It is to be remembered that the law of gravitation determines the movements of these bodies. The meteor, ere its disastrous collision with our atmosphere, must have

been traversing the solitudes of space in an elliptic path with the sun in one of the foci. This is as true of a meteor the size of a grain of sand as it is of the earth or the planet Jupiter. The astronomer then approaches the question with the knowledge that the orbit of the meteors is an ellipse (or at all events one of the conic sections), but what the particular ellipse is must be decided by an appeal to the actual observations. The facts are simple enough: we note in the first place that the shower took place on the 12th of November, but on the 12th of November in each year, or on any other fixed date, the earth is always at a particular point of its annual journey round the sun. The stream of meteors must therefore pass through that particular point of space, and hence the search for the orbit is narrowed, for only ellipses which pass through this particular point can fulfil the conditions of the question. Another clue is afforded by the position of that point in Leo from which all the meteors seemed to radiate. The mathematician sees how to fit the ellipse so that it shall give the proper radiant. And now the question has been narrowed almost to the last point. One more appeal to observation and the ellipse will be absolutely known. All we must now learn is how long the swarm of meteors takes to complete the circuit of its mighty path. To answer this question profound historical research has been made by Prof. Newton, and a mathematical research has been made which has given additional lustre even to the name of Adams. The great showers of meteors have been shown to have occurred at intervals for the last 1,000 years. The earliest record was in the year 002, on the occasion of the death of the Moorish king Ibrahim bin-Ahmad. An old chronicle describes how the event was solemnised in the heavens no less than on the earth; he tells us how "that night there were seen as it were lances, an infinite number of stars which scattered themselves like rain to right and left, and that year was called the year of the stars." We now know that this exhibition was not, as the old chronicler thought, a miraculous compliment to the memory of the deceased prince, it was really only a shower of the Leonids, such a shower as appears every thirty-three years, such a shower as appeared in 1866, such a shower as may be anticipated in the year 1899.

By these researches the path followed by the Leonids has been completely determined. The plane of the ellipse, and every circumstance of its position, and its proportions have been reduced to numerical accuracy. The shoal of meteors pursue their path unseen by any astronomer, but the mathematician knows precisely where they are at this moment, and at every moment.

This point being gained a great discovery was made by Schiaparelli in 1866. About that time a comet was seen, this comet was duly observed, and the path which it followed was computed. There was nothing very remarkable about the comet, and it would not now be much remembered save for one most extraordinary circumstance which Schiaparelli was the first to proclaim. Like the shoal of meteors this comet also revolves in an elliptic path around the sun. This is a mere consequence of the law of gravitation and calls for no remark, but the fact that the two ellipses lie in the same plane is a very remarkable coincidence which could not be overlooked. When we further come to see that the two ellipses are of the same size and shape, when we see that they are placed in the same position, when we see, in fact, that the ellipse which is the orbit of the shooting stars is identical with the orbit of the comet, then we have obtained a result which ranks as one of the most striking astronomical discoveries that this century has witnessed.

The Leonids therefore travel through space precisely in the track of the comet of 1866. The question at once arises of the relation of the shoal of meteors to the comet. Is the shoal of meteors one thing and the comet another thing, and do both these things happen to be travelling in the same orbit without any necessary connection, or are we to suppose that the two objects, if not actually identical, are at all events very intimately connected? These are problems which, in the present state of our knowledge, it seems difficult to solve. I shall only lay down one or two principles which may help us to form a conclusion.

Whatever be the nature of comets, or the materials of which they are composed; whether they be faint or bright, large or small, periodic or parabolic; one fact is certain, their masses are all extremely small in comparison with their great dimensions. I shall indeed, at a later part of this lecture, show that comets seem to be almost imponderable when compared with the great masses of the sun and of the planets. The great bulk of a comet necessarily implies that many parts of it are at a considerable distance from its centre of mass. Hence for a double reason the



coherence of the parts of a comet arising from their mutual gravitation is an extremely feeble force. Each particle of the comet is directly solicited by the sun to pursue a path of its own, and if the forces of coherence be not adequate to overcome this tendency the comet must undergo a gradual degradation into separate parts. As the periodic time of the orbit of each part will vary, it will follow that the comet will be spread out in fragments along its path. It would seem that these small fragments constitute the meteors.

It is often supposed that meteorites, or solid bodies which actually tumble down on the earth, are connected with shooting stars, and hence it has been asserted, and even by very good authority, that meteorites are connected with comets, if not actually parts of comets. I merely mention this view for the purpose of saying that to me it seems quite unsupported by the facts. There is no reliable evidence, or indeed no evidence at all, that meteorites are connected with the periodic showers of shooting stars which alone are connected with the comets. This would not be the occasion to discuss the interesting question as to the origin of meteorites, but all the available facts seem to me to point to an origin on some body far more closely resembling a planet than a comet.

It is now about sixteen years since Dr. Huggins first turned his spectroscope upon these bodies, and showed that certain lines in the spectra of the comet of 1868 were identical with certain of the lines of carbon. Since then many comets have been observed and much valuable spectroscopic work has been done. This has been so often and so fully discussed that I do not now propose to dwell on the subject at length. It is, however, quite impossible to avoid a brief reference to one of the latest efforts of Dr. Huggins' marvellous skill. He has succeeded in inducing a comet to depict with absolute fidelity its spectrum on the photographic plate. That photograph has not only shown the lines which could be seen with the spectroscope, but it has also exhibited many other lines in the invisible part of the spectrum. The discussion of this photograph and of the bright lines and the dark lines it contains is full of interest, though here I shall only remark that it contains convincing evidence of the presence of carbon in this comet.

That a comet's tail should be directed away from the sun is a very remarkable and characteristic feature of this group of bodies. At the first glance it seems at variance with every received doctrine of astronomy. The great law of Nature which regulates the movements of the heavenly bodies is the law of attraction. The very movement of a comet in an elliptic path around the sun is in itself a demonstration that the comet is attracted by the sun.

While the comet as a whole is amenable to the law of gravitation, it is obvious that the materials, whatever they may be, which constitute the tail of the comet must be repelled by some force of an exceptional character. This force must sometimes be of very great intensity. Cases are not wanting where a comet, after darting in close to the sun, has actually whirled round the sun with the stupendous velocity of 300 miles a second, and in a few hours has commenced its outward journey. During this appalling swoop what has been the conduct of the tail of the comet? It seems necessary to believe that at the commencement the tail was streaming away for millions of miles on one side of the sun, while in a few hours the tail has gone completely round, so as to be extending for millions of miles in the opposite direction. No known laws of mechanics allow us to believe that the *same* tail is seen under circumstances so diverse. We are compelled to believe that the tail is constantly dissipated and constantly renewed. It would, in fact, seem that the tail of a comet was in some respects like the column of smoke ascending from a chimney—the column remains, but the particles of which that column consists are in perpetual transition.

In the study of this subject we have to make use of the interesting labours of Prof. Bredichin of Moscow. This accomplished astronomer has devoted himself for many years to the collection and to the discussion of all the known phenomena of comets' tails, and he has succeeded, I believe, in taking a considerable step in the solution of the problems involved. In the first place he has shown that there are different types of comets, and he has proceeded to classify them. There are, first of all, the comets with very long and very straight tails, such, for instance, as the comet of 1874, and many others. The next class included the tails of a scimitar shape. These are often of very great splendour, though not so long or so straight as those of the first type. The great comet of 1858 may be cited as an

illustration of this class. The third and last class of comets' tails are very short and curved. It is to be observed that these tails sometimes exist in combination, so that a comet is often decorated with two tails of different types.

Once the form of the tail has been laid down, and the perihelion distance of the comet given, then the investigation of the forces adequate to the production of that tail is a problem admitting of numerical solution. It can be demonstrated that the straightest tail that ever streamed from a comet could be produced by a repulsive force not more than twelve times as great as the intensity of gravitation at the same distance. This number twelve will be the characteristic of tails of the first type. The tails of the second type vary within certain limits, but speaking generally, the repulsive force adequate to their production need not be more than about equal to the force of gravitation itself. The tails of the third type would be explained if the repulsive force were only the fifth part of gravity.

The next question that arises is as to the physical explanation of the repulsive force which produces these tails. We have to find this force of three different intensities, one about twelve times as great as gravity, one about equal to gravity, and one about a fifth of gravity. Before we postulate the existence of a new force of some unknown character, it is surely our duty to inquire whether there may not be some force already known which is competent to produce the phenomena. The best known repulsive force is of course that with which every one is familiar in connection with electricity. Electricity attracts electricity of an opposite type, while it repels that of the same type. We are also aware that in some mysterious manner the sun is connected with electricity. We know that the phenomena of terrestrial magnetism are connected with solar phenomena, and hence we are tempted to inquire whether the electricity of the sun may not offer an adequate explanation of the phenomenon of the comet's tail.

Let us suppose that the sun is attracting a distant body by virtue of gravitation, and at the same time repelling that body in virtue of the fact that the sun and the body are both charged with electricity of the same name. When the attracted body is one of large dimensions, the attraction will vastly exceed the repulsion, and indeed the latter may be entirely neglected in most cases. There is, however, a radical difference between the nature of the electrical forces and the nature of the gravitational forces. The latter are proportional to the masses of the attracting bodies, while the electrical forces are proportional to their surfaces. The mass varies as the cube of the linear measurements, while the surface only varies as the square. The relative efficiency of the electric repulsion in comparison with the gravitational attraction increases as the radius of the particle decreases. It must thus necessarily follow that no matter how great may be the preponderance of the power of gravitation on masses of finite dimensions, yet it must always be possible, other things being equal, to have a particle so small that the electrical repulsion shall exceed in any required ratio the intensity of the attraction of gravitation.

As the comet draws near the sun, the heat it experiences increases, so that the materials of the comet begin to dilate, and to be driven off into a vaporous condition. The matter is thus resolved into a state of extreme subdivision. These separate particles are charged with an electricity similar to that of the sun, and in virtue of their minuteness the intensity of that repulsion has become sufficient to sweep off the particles in a stream, and thus generate the tail.

Such is the modern view of the formation of comets' tails. Professor Bredichin has given good reasons for thinking that we can even discover the special ingredients which enter into the formation of each of the three types of tail. It seems, from the molecular nature of hydrogen, that this element is especially suitable for the tails of the first type. The tails of the second type seem to arise from some substances possessing the properties of hydrocarbons, while the tails of the third type contain some elements which seem to have a high atomic weight. The theory of Professor Bredichin is well illustrated by the comet of 1858. This comet, besides the majestic curved tail, the object of so much admiration, had a pair of long, faint, slender tails, streaming straight from the head. These two objects were doubtless the edges of a conical tail of the first type, too faint to be visible throughout its entire extent. The great tail was one of the second type.

We have many reasons for believing that the masses of comets are very much less than the masses of the planets. We

might indeed almost conclude that the masses of the comets are inappreciable. Let us briefly indicate the grounds for this important conclusion.

The sun and the planets form a system characterised by perfect order and symmetry. We have the sun in the centre. We have all the great planets moving round the sun in the same direction. They all move nearly in circles, and all these circles lie nearly in the same plane. This organisation is a necessary *modus vivendi* among the bodies of our system. Each planet acts and reacts upon all the other planets, but, owing to the circumstances of their movements, their irregularities are but small, and the permanence of the system is insured. Alter that system to any extent, merely reverse for example the direction in which one of the planets is moving, and the whole compromise is destroyed. The actions and reactions, instead of being quickly balanced, will go on accumulating, and the seeds of confusion and ultimate dissolution have been sown. But we have in our system thousands of comets which repudiate all the regulations by which the planetary convention is restrained. Comets come in what direction they please, they move in every plane but the right one, and their orbits are not in the least like circles. The very fact that our earth continues to revolve around the sun so as to be a fit abode for life, is a proof that comets cannot have any considerable mass. If comets had mass then organic disease would be introduced into the solar system which must ultimately prove fatal.

Science has gradually dissipated the fears which once invested comets: they are interesting and beautiful visitors which come to please and to instruct, never to threaten or to destroy.

#### NOTES

THE autumn Congress of the Sanitary Institute of Great Britain will be held this year at Dublin, and the programme of the proceedings has been issued. The President of the Congress is Sir Robert Rawlinson, C.B., who will open the Congress with an inaugural address on Tuesday the 30th inst., and the proceedings will last until October 4. The Congress is divided into three sections—the first, "Sanitary Science and Preventive Medicine"; the second, "Engineering and Architecture"; and the third, "Chemistry, Meteorology, and Geology." Of the first section, the president is the Registrar-General for Ireland, Mr. Thomas W. Grimshaw, M.A., M.D. In the section of "Engineering and Architecture," the president is the Engineering Inspector of the Local Government Board for Ireland, Mr. C. D. Cotton, C.E.; and the president of the section of "Chemistry, Meteorology, and Geology" is Mr. C. A. Cameron, M.D., the City Analyst and Superintendent Medical Officer of Health for Dublin. The sectional meetings and the general meetings will be held at Trinity College, where the opening address will be delivered on Tuesday evening by Sir Robert Rawlinson. On Wednesday morning the actual work of the Congress will commence with the address of the president of the first section, and the remainder of the day will be taken up with the reading of papers and their discussion, while a *conversazione* will be held in the evening. The business of the second section will be taken on Thursday, October 2, and in the evening a lecture will be delivered to the Congress by Dr. Alfred Carpenter on "Education by Proverb in Sanitary Work." On Friday, after the third section, the closing general meeting of the Congress will be held. Arrangements for excursions will be made for the Saturday.

THE fifth International Congress of Hygiene, which has concluded its session at the Hague, is reported to have been highly successful; it was decided to accept the invitation from Vienna for 1886.

It is reported that Mr. Melville, chief engineer of the *Jennette* Expedition, will command a Polar expedition which it is said will start next autumn to attempt to reach the Pole *via* Franz Josef Land. It is stated that Mr. Cyrus Field and the New York Yacht Club will each furnish one-half the cost of the expedition.

IN the course of the present month a geographical professorship will be established at each of the Russian universities. In Germany, fourteen out of twenty-one universities have a chair of this sort.

A VERY favourable Report has been issued of the second year of the College Hall of Residence for Women Students. That such an institution was wanted is shown by the fact that last autumn another house had to be added in order to meet the number of applications from students. The Hall is already almost self-supporting, and in another year will probably be entirely so; and it is hoped that this will encourage friends to assist the Committee in paying off the 1000*l.* they had to borrow in order to extend the premises. Subscriptions and donations may be sent to Mrs. Edward H. Busk, 44, Gordon Square, W.C.

THE Geographical Society have received a letter from Mr. H. H. Johnston, who has been sent out to explore and collect plants on Mount Kilimanjaro. It is dated June 18, from "Uvura, in Chagga, altitude 5000 feet." "For nearly a week now," Mr. Johnston says, "I have been settled on Kilimanjaro, camped on one of the loveliest sites in the world. Above me towers into the deep blue heaven the snowy head of Kibô, around me are green hills and forest-clad ravines in whose profound depths great cascades of water leap from rock to rock and splash the fronds of luxuriant ferns; before me lies spread out a vast blue plain—'all the world,' as my host, the chief Mandara, proudly says, and my view southward is only bounded by the distant horizon. Perched as I am up here on the shoulder of a great buttress of the mountain, I seem to be on a level with the uppermost flight of the vultures, who hardly ever soar higher, and who poise themselves and wheel in circles over the awful depths at my feet. When the first cares of my installation are over, I am going to set to work on a picture such as I see before me, and call the view 'à vol de vautour.'"

THE difference between the temperatures of places in America and those of places in similar latitudes in Europe is already well known, but it would hardly be expected to be so great as it actually was in January of this year. That month was a mild one all over Europe, but in the United States, especially in the eastern part, it was extremely cold. Thus, in Nashville and Knoxville, in the same latitude as Malta, the thermometer marked 26°·7 C. and 23°·3 C. of cold, while in Malta it was only 5°·9 below zero. At Indianapolis and Columbus it was 31°·7 C. and 28°·9 C. respectively below zero, while at Madrid, in the same latitude, the maximum was 9° below zero. The average temperature of the month in the States was 3° C. to 5° C. beyond the normal average.

THE experiment of MM. Renard and Krebs in balloon steering at Meudon, of which so much has recently been heard, formed the subject of a paper read before the Academy of Sciences on the 18th ultimo. The solution of the problem of aerial navigation was first attempted in 1855 by M. Giffard, who employed steam, then in 1872 by M. de Lóane, and finally by M. Tissandier, who was the first to apply electricity. The conditions which MM. Renard and Krebs studied to fulfil were steadiness of the path obtained by the shape of the balloon, and the arrangement of the rudder; the diminution of resistance while travelling by the proportion of the dimensions—bringing together the centres of traction and resistance; and finally, to attain a speed capable of resisting the winds prevailing in France during the greater part of the year. The paper then enters into details of the construction, and of the journey, during which the writers claim they were able to manœuvre the balloon as easily and effectively as a ship is put through its evolutions.

WE have recently received from various scientific societies in the United States their late publications. The contents of these

are too numerous and too varied to be noticed now in any but the most general way. The New York Academy of Sciences appears to lead them all in the number and importance of the papers read before it, in every conceivable department of science. The Philological Society of Washington sends us vol. vi. of its *Bulletin*, containing the President's address (on "The Three Methods of Evolution"), as well as the abstracts of a large number of papers. This Society appears to work in conjunction with the Smithsonian Institution. The last number of the *Bulletin of the Buffalo Society of Natural Sciences* is almost wholly occupied with an elaborate paper on the plants of Buffalo and its vicinity, by Mr. Day, the present instalment being occupied by the Cryptogams. The toilers in the vineyard of science in the United States are evidently numerous and enthusiastic, and they have provided themselves with ample means of giving their results to the world.

THE last numbers of the "Encyclopædie der Naturwissenschaften" (Breslau, Eduard Trewendt) are Part 1, No. 37, and Part 2, Nos. 21 and 22. The first forms the continuation of the "Handwörterbuch der Zoologie, Anthropologie, und Ethnologie," and numbers among its writers Shellwall, Reichenow, Pfeffer, Martens, Jäger, Röckl, and others. Among the articles in the present instalment are the pacing of horses, by Prof. Röckl; the brain, by Mojżisowicz; and on the geographical distribution of animals, by Dr. Reichenow. No. 21 of Part 2 continues the section on mineralogy, geology, and palæontology, and contains articles on islands, by Von Lasaulx; the Jura system, the formation of coal in the different geological epochs, and cryptogams, by Dr. Rolle. No. 22 belongs to the chemical section.

DURING the last fifty years several attempts have been made to form oyster banks in the Baltic. The first attempt was made about forty years ago, when a quantity of European oysters were laid down, but it proved a failure, and the oysters soon died. In recent years, however, experiments have been made with the American oyster (*Ostrea virginiana*), which, according to the researches of Prof. Möbius is a different variety of the European. The idea of laying down American oysters in the Little Belt was due to Mr. Meyer, an engineer of Hadersleben, who formed a company for the purpose of carrying it out, to which the Prussian Government granted a concession for forty years to form oyster banks up to lat. 55° N. In the autumn of 1879 Mr. Meyer went to the United States, whence he brought back to Hadersleben a million and a half small and half a million large oysters, which were laid down in ten different places from the Danish frontier to the southern part of the Als Sound. Recent examinations of these spots have shown varying results. In some there are only a few oysters left, and in others considerable quantities. Where seaweed is very plentiful the oysters have died. The best result was found on the south-east coast of Als. During the present summer fresh attempts at oyster-hatching are to be made in these parts, and the German Fishery Association has granted Prof. Möbius a sum of about fifty pounds towards expenses. On the west coast of Norway, too, strenuous efforts have been made in recent years to improve the oyster fisheries there, which were formerly very important. Several companies have been formed for acquiring old banks and restocking them. In some places the results have been very satisfactory.

THE Tung Wen, or Foreign Language College at Peking, is about to issue a large work on Anatomy by Dr. Dudgeon of that place. It is said to contain prefaces, in the usual Oriental manner, from several of the highest officials at the capital. The work has over 500 cuts made at the Government expense. A large work on Physiology is also ready for the press; while Dr. Dudgeon has ready for the English press a little work on the diet, dress, and dwellings of the Chinese in relation to health.

IT is known that the Boyle-Marriott law is true only within certain limits, and that a gas submitted to great pressures, as well as to very low ones, ceases to obey it; the product received by multiplying its volume by its elasticity ceases to be a constant, and decreases under very low pressures: the elasticity decreases at a higher rate than the density of the gas, and to express the relations between the two, a more complicated formula must be resorted to. Another source of complication is due again to the condensation of the gases on the solid surfaces of the recipients, and if this cause be taken into account, the measured elasticities must be lower than the true ones, and in the rarefied gases the ratio between elasticity and density must increase with the increase of elasticity at a higher rate than would result from Prof. Mendeléeff's observations. Such was the idea that guided M. Kraevitch in a series of experiments he undertook a few years ago, with M. Petersen, in order to eliminate the influence of the condensation. These experiments being not sufficiently accurate, M. Kraevitch has now undertaken a new series of researches based on the rate of sound in different gases. They were carried on in tubes of very different lengths and diameters, and it appears from a preliminary communication, now published in the *Journal of the Russian Chemical Society* (vol. xvi. fasc. 6), that the air, when rarefied, does not obey at all the Boyle-Marriott law. The researches carried on on this principle promise to be, on the whole, very interesting, and may lead to conclusions of some value.

A SHOCK of earthquake occurred at Réunion on August 7 at midnight. The oscillation was from east to west, and was preceded by a loud report, like an explosion. No damage was done.

THE additions to the Zoological Society's Gardens during the past week include a Vervet Monkey (*Cercopithecus lalandii* ♀) from South Africa, presented by Major Newson D. Garrick; a Moustache Monkey (*Cercopithecus cephus* ♂) from West Africa, presented by Mr. G. A. Broderick; a Rhesus Monkey (*Macacus rhesus* ♂) from India, presented by Mr. H. Johnson; a Macaque Monkey (*Macacus cynomolgus*) from India, presented by the Rev. Walter Hudson; a Squirrel Monkey (*Chrysothrix sciurea*) from Brazil, presented by Mrs. J. M. A. King; a Himalayan Bear (*Ursus tibetanus*) from North India, presented by Mr. Percy H. Cooper; a Red and Yellow Macaw (*Ara chloroptera*) from South America, presented by Mr. P. J. Prior; a Common Cuckoo (*Cuculus canorus*), British, presented by Mrs. William Smith; a Sharp-nosed Crocodile (*Crocodilus acutus*) from Central America, a Hawk-billed Turtle (*Chelone imbricata*) from the West Indies, presented by the Rev. W. T. Lax; two Spotted Slow-worms (*Acontias meleagris*) from South Africa, presented by the Rev. G. H. R. Fisk, C.M.Z.S.; a Common Slow-worm (*Anguis fragilis*), British, presented by Mr. H. Scherren; a Ludio Monkey (*Cercopithecus ludio*) from West Africa, a Kit Fox (*Canis velox*) from North America, a Banded Acarari (*Pteroglossus torquatus*) from Central America, an Ethiopian Wart Hog (*Phacochoerus aethiopicus*) from South-East Africa, a Tiger Bittern (*Tigrisoma brasiliensis*) from Brazil, a Common Boa (*Boa constrictor*) from South America, an Indian Eryx (*Eryx johni*) from India, purchased.

#### OUR ASTRONOMICAL COLUMN

COMET 1884 *b*.—M. Trépiéd further writes with respect to his observations of the comet discovered by Mr. Barnard:—"I hope you will favourably receive some remarks on the subject of your last article on the Barnard Comet. You say that it would not be prudent to pronounce upon the nature of the orbit on account of the uncertainty which seems to attach to the observations at Algiers. There was in fact an error committed on the first day, in the identification of the star of comparison, but that error was rectified almost immediately, and I am able to state

that the verification to which I subsequently submitted that star (B.A.C. 5457) leaves no doubt as to the legitimacy of the identification. But I wish especially to remark that amongst the published orbits is one in which the observations at Algiers have had no part; it is that calculated by Chandler on the observations of July 16, 21, and 28." M. Trépied suggests that the conjecture of Prof. Weiss as to the nature of the orbit rested not only on the differences in the mean place, but on the agreement of his own elements with those of Chandler. We are now aware, however, as was mentioned last week, that the apparent deviation from parabolic motion was caused by error in the position published for the night of discovery, and that M. Trépied's observations (the comparison star having been identified) prove very exact. The doubt we expressed was occasioned by the large corrections given in the circular of the *Astronomische Nachrichten*.

**BRORSÉN'S COMET OF SHORT PERIOD.**—The following positions of this comet are deduced upon the same assumption with respect to the epoch of perihelion passage as those lately given for the period of absence of moonlight in August:—

12h. G.M.T.	R.A.		Decl.	Distance from	
	h.	m.		Earth	Sun
Sept. 15	10	26.6	+13 37	1.416	0.590
17	10	40.0	13 28	1.436	0.593
19	10	53.3	13 15	1.455	0.598
21	11	6.3	12 58	1.475	0.606
23	11	19.1	12 37	1.496	0.617
25	11	31.7	+12 12	1.518	0.630

An acceleration of four days in the time of arrival at perihelion would cause the following differences in the comet's geocentric position:—

On Sept. 15	In R.A.	m.	In Decl.
15	+16.9		+31
23	+15.3		+1

The intensity of light on September 15 is 1.43, and the comet would rise about 2h. 8m. before the sun. It should be sought for as soon as the moon is off the morning sky.

M. Trépied writes on August 26 that he had commenced a search for the comet according to the places given in *NATURE*. "Malheureusement," he says, "à Algiers le temps qui peut être consacré à la recherche est très-court, car le crépuscule arrive presque immédiatement. Néanmoins je n'ai pas encore perdu tout espoir."

**THE CAPE HELIOMETER.**—The Treasury have granted Dr. Gill's application for a heliometer of large size for the Royal Observatory at the Cape of Good Hope, and a contract has been entered into with the Messrs. Repsold of Hamburg. The instrument will be of seven inches aperture, and is to be completed by the end of 1886, at an expense of 2700l.

### SCIENTIFIC SERIALS

*The American Journal of Science*, August 1884.—Contributions to meteorology: reduction of barometric observations to sea-level (continued), by Prof. Elias Loomis. The author considers that it is quite useless to seek for a formula exactly representing the barometric reduction to sea-level at all pressures and temperatures, unless the irregular movements in the upper and lower strata of the atmosphere be taken into account. But these movements are greatly modified by the obstruction of the mountains upon which the observations are made, and therefore vary with the locality; hence he concludes that such an attempt seems a hopeless undertaking.—Notes on the rock and ore deposits in the vicinity of Notre Dame Bay in Newfoundland, by I. E. Wadsworth. The districts examined were chiefly various points between Exploits Burnt Island and Betts Cove, which yielded basalt, diorite, porodite, andesite (?), porphyrite, and gillite, variously impregnated with chalcopyrite, malachite, and copper. But none of the ores were found associated with serpentine, which was nowhere seen except in small quantity at Betts Cove.—On the origin of bitumens, by S. F. Peckham. The author deals with the views of those who regard bitumens (pitch, asphalt, naphtha, petroleum, &c.) either as indigenous to the rocks in which they are found, as the product of chemical action, or as a distillate produced by natural causes. He is on the whole inclined to regard these substances as distillations from animal and vegetable organic remains, and argues that if they are the result of a purely chemical process we should not expect to find Paleozoic petroleum of a composition corresponding with

the simple animal and vegetable organisms that flourished at that period, and Tertiary petroleum containing nitrogen unstable, and corresponding with the decomposition-products of more highly organised beings; but we should expect to find a general uniformity in the character of the substance wherever found all over the earth. On the other hand, if petroleum is the product of metamorphism, its formation is coexistent only with that of metamorphic action, which does not seem to have prevailed on a large scale during recent geological periods. Hence on this hypothesis its production must be considered as practically ended.—On the measurement of rapidly alternating electric currents with the galvanometer, by L. M. Cheesman.—Note on some specimens of nickel ore from Churchill County, Nevada, by Spencer B. Newberry. The analysis of these samples gave:—

NiO	...	...	33.71 per cent.
As <sub>2</sub> O <sub>3</sub>	...	...	36.44 "
H <sub>2</sub> O	...	...	24.77 "

From the extraordinary purity and richness of these ores, the author considers it probable that the Nevada mines, which run 6000 feet north-east and south-west to the Carson Desert, will eventually become a chief source of the world's supply of this valuable metal.—On the formation of gorges and waterfalls, by W. Morris Davis. The author considers that, although the Colorado Cañon, the greatest gorge in the world, was formed by rapid downward erosion following the rapid elevation of the plateau, most falls and ravines result from the local displacement of streams by blockades of glacial drift, or by temporary obstruction from the glacial sheet itself.—On the influence of light on the electrical resistances of metals, by Arthur E. Bostwick. From a series of experiments with various metals, the author concludes that, if light causes any diminution in the electrical resistance of metals, it probably does not exceed a few thousandths of one per cent.—Note on the rare mineral vanalinite occurring in the Black Prince Mine, Pinal County, Arizona, by Francis Hayes Blake.—Remarks on the united metatarsal bones of the Ceratosaurus, an already described new Dinosaurian, by Prof. O. C. Marsh. The author points out that all known adult birds, living and extinct, with perhaps the single exception of Archaeopteryx, have the tarsal bones firmly united, whereas all the Dinosaurian, except Ceratosaurus, have these bones separate. The exception in each case brings the two classes near together at this point, and their close affinity has now been clearly demonstrated.

*Bulletin de l'Académie Royale de Belgique*, May 1884.—Observations on the shooting-stars made at the Royal Observatory of Brussels on August 9-11, 1883, by L. Niesten.—Description of the effects of a stroke of lightning on the new Palace of Justice, Brussels.—Memoir on the process of segmentation in the Ascidiæ, and its relations with the organisation of the larvæ (two plates), by Edouard van Beneden and Charles Julin.—Some arithmetical theorems, by E. Catalan.—Researches on the absolute power of the muscles in the invertebrates, second part: absolute power of the flexor muscles of the pinchers in the decapod crustaceans (one plate), by Felix Plateau.—Exact dates of the birth and death of Wenceslas Coebergher, by Auguste Castan.—Essay on freedom of conscience in Athens, by M. A. Wagener.—Theories of Plato and Aristotle on the social question, by Ch. Loomans.—Memoir on the best means of improving the moral, intellectual, and physical state of the working classes, by Joseph Danby.

### SOCIETIES AND ACADEMIES

#### SYDNEY

**Royal Society of New South Wales**, July 2.—H. C. Russell, B.A., F.R.A.S., President, in the chair.—Six new members were elected, fifty-four donations received, and the following papers read:—Notes on gold, viz. (1) a remarkable occurrence of nearly pure gold in Queensland, being 99.7 of gold, the rest copper, with a trace of iron, found in quartz and stalactites of brown hæmatite; (2) preparation of pure gold; (3) volatilisation of gold, by A. Leibius, Ph.D., M.A.—Notes on minerals new to New South Wales, by Prof. Liversidge, F.R.S., accompanied by specimens. Remarkable concretions of friable iron pyrites containing septa of quartz, resembling in appearance the well-known "septaria" of the London Clay, large crystals of axinite, idocrase in association with grossularite from Nundle, tourmaline in large prisms resembling the celebrated Bovey Tracey forms, Scheelite, molybdenum ochre, antimonite containing native gold from near Armidale, and allophane, serving as a

matrix for native copper, Islayney.—On the oven-mounds of the aborigines in Victoria, by the Rev. Peter MacPherson, M.A. The situations, sizes, and structure (internal and external) of these aboriginal relics were considered, and measurements given. The cooking oven, or smaller portion of the mound, was specially investigated. Besides the more common contents, namely, ashes, charcoal, and stones, human remains were sometimes found. Where no timber existed, a kind of turf and coarse grass were used as fuel. Circles of stones girdling the mound were described. So far as appeared, no very high antiquity was required to account for the mounds.—Mr. W. Neill exhibited some very rich specimens of gold in quartz and mispickel from the new mine Wahaup, East Ballarat.

PARIS

**Academy of Sciences, August 25.**—M. Rolland, President, in the chair.—Remarks on aerial navigation, in connection with the experimental trip made on August 9 by Capt. Renard and Krebs with their new balloon, by M. Dupuy de Lome. The author regards the experiment as so far highly satisfactory, and announces that it will be soon renewed with a screw machine possessing double the motive power of the first, and calculated to travel in any direction with an average speed of fifteen miles an hour. It is further pointed out that the balloon is constructed on the principles expounded in a memoir addressed by the author to the Academy of Sciences and dated February 2, 1872.—Contributions to the study of algebraic equations: (1) general considerations, binomial and trinomial equations, by M. de Jonquières.—On the process of cold hammering, and the variation in the limit of elasticity in metals and other solid substances, by M. Tresca.—Researches in organic botany; studies on the formation and presence of nitrates in plants; methods of analysis, by MM. Berthelot and G. André. An account is here given of the authors' attempt at a complete analysis of a vegetable organism with a view to determining the chemical equation during its development from the fertilised germ to its fructification and reproduction. Experiments were also made for the purpose of varying the physiological conditions of vegetable growth, and for these various objects ten botanical species, including six varieties of the *Amaranthus* were subjected to a methodical and comparative study during the season of 1883.—Note on astronomical measurements and especially on the choice of a common meridian, by M. A. d'Abbadie. The author pronounces in favour of the west coast of Flores, one of the Azores, for the chief meridian, or else for its anti-meridian, should the latter be preferred. He also proposes the adoption of a unit of 10,000 kilometres for the measurement of celestial spaces, this unit to be called a *mégiste* (*μεγίστος*).—A study of the sphincters of the cardiac and other veins, with remarks on their hermetic occlusion during the presystole state, by M. P. Durozier.—Note on the inequality in the distribution of the solar temperature according to latitude and the activity of the phosphore, by P. Lamey.—Observations of the new planet Palisa 239 made at the Paris Observatory (equatorial of the West Tower), by M. G. Bigourdan.—Observations of the Barnard comet and of the new planet Palisa 238, by M. Perrotin.—Remarks on the universal hour, and on the formula—

$$\text{Universal time} = \text{local time} + (12\text{h.} + \text{longitude}),$$

where the longitude is reckoned eastwards from oh. to 24h., by M. Caspari.—Description of a thermo regulator of simple construction intended also to serve as a registering thermometer (two illustrations), by M. E. H. von Baumhauer.—Researches on the infra red spectra of emission of metallic vapours, by M. Henri Becquerel. The paper is accompanied by a table of the wave-lengths of the most intense rays, bands, or groups of rays characterising the spectra of the vapours of potassium, sodium, strontium, calcium, zinc, aluminium, cadmium, lead, silver, tin, and some other metals.—Determination of the indices of refraction by linear measurements, by M. Ch. V. Zenger.—On the quality of the various farinas obtained by different processes of grinding, by M. Aimé Girard.—Note on the poisonous properties of urea, determined by a series of experiments made on frogs, guinea-pigs, rabbits, and pigeons, by MM. Gréhan and Quinquaud. The experiments consisted in subcutaneous injections of aqueous solutions of pure urea, the doses being gradually increased, and invariably terminating in tetanic convulsions and death. The convulsions resembled those produced by strychnine, and were followed by death in the course of from one to ten hours.—Remarks on the action of high pressure on the pheno-

mena of putrefaction and on the vitality of minute organisms in fresh and salt water, by M. A. Certes. The object of M. Certes' studies was to determine the processes and the conditions under which organic matter is reduced to the inorganic state at the bottom of the sea. Experiments were also incidentally made with the bacteria of charbon, which preserved their vitality and virulence under a pressure of 600 atmospheres, maintained for a period of twenty-four hours.—Remarks on the action of lesions of the rachidian bulb on the digestive functions, by MM. Couty, Guimaraes, and Niobey.—Experiments made to determine the loss of nitrogen during the fermentation of farmyard manure, by M. Ch. Brame.—On the dehiscence of the anthers in phanerogamous plants, by M. Leclerc du Sablon.—Report on the present state of the Krakatoa volcano, by MM. Bréon and Korthals. The report embodies an account not only of Krakatoa, but also of all the surrounding districts, which were wasted by the eruption of August 26, 1883. Some successful photographs were taken, including the only exact profiles hitherto obtained of Krakatoa.

VIENNA

**Imperial Academy of Sciences, June 19.**—R. Herth, researches on hemialbumose or propeptone.—R. Scharitzer, on the minerals and rocks of Jan Mayen.—F. Bayer, on the extremities of a young *Hætertia*.—K. Natterer, on the opposition of hydric chloride to dichlorocrotonaldehyde.—L. Tausch, on some *Conchylia* from the fauna of Lake Tanganyika (Central Africa), and their allied fossils.  
July 3.—E. Marenzeller, on Southern Japanese Annelids; description of species of the genera *Ampharetea*, *Terebellacea*, *Subellacea*, and *Serpulacea*.—F. Bertolasi, on the applicability of Wittstein's and Kinkelin's formulae to volumetric calculations.—S. Bernheimer, contribution to a knowledge of the nerve-fibre layer of the human retina.—A. Nalepa, preliminary communication on the anatomy of *Tyroglyphus*.—T. Habernann, on acetonydroquinone.—T. Zehenter, on the action of phenol and sulphuric acid on hippuric acid.—E. von Oppolzer, determination of the length of the pendulum at the Vienna Observatory. M. Pernter, contributions to a knowledge of the winds in the upper strata of the air.  
July 10.—T. Iersch, researches on chelidonic acid.—A. Lieben and A. Häntinger, on chelidonic acid.—F. Spitzer and T. Kachler, on camphoronic acid.—H. Molisch, on aerotropism of roots.—I. von Oppolzer, determination of the force of gravity while using two Repsold's pendulums of different weights.

CONTENTS

	PAGE
<b>Fungi and Bacteria</b> . . . . .	435
<b>Our Book Shelf:—</b>	
McLachlan's "Monographic Revision and Synopsis of the Trichoptera of the European Fauna" . . . . .	436
<b>Letters to the Editor:—</b>	
Lewy's New Telescope System.—A. Ainslie Compton . . . . .	438
Earthquakes in Japan.—F. Warrington Eastlake . . . . .	438
" <i>Udchimyia sericaria</i> ," Rond., a Fly Parasitic on the Silkworm.—C. Sasaki . . . . .	438
Singular Instance of Instinct.—Thomas Harrison . . . . .	438
Prezavsky's Horse.—W. W. Watts . . . . .	438
"The Ore of Leadville."—Ernest Jacob . . . . .	437
<b>Australian Orchids</b> . . . . .	438
<b>Grinnell Land</b> . . . . .	438
<b>The British Association:—</b>	
Section C—Geology—Opening Address by W. T. Blanford, F.R.S., Sec. G.S., F.R.G.S., President of the Section . . . . .	438
Section H—Anthropology—Opening Address by Edward B. Tylor, D.C.L., F.R.S. President of the Section . . . . .	438
"Comets"—Lecture by Prof. R. S. Ball, Astronomer-Royal for Ireland . . . . .	438
<b>Notes</b> . . . . .	
<b>Our Astronomical Column:—</b>	
Comet 1884 b . . . . .	438
Brorsen's Comet of Short Period . . . . .	438
The Cape Heliometer . . . . .	438
<b>Scientific Serials</b> . . . . .	
<b>Societies and Academies</b> . . . . .	

THURSDAY, SEPTEMBER 11, 1884

## DESCRIPTIVE MINERALOGY

*Text-Book of Descriptive Mineralogy.* By Hilary Bauerman, F.G.S. 8vo; pp. vi. 399; 237 figures. (London: Longmans, Green, and Co., 1884.)

THIS is the companion volume to the "Systematic Mineralogy," by the same author, published in 1881. As far as space admits Mr. Bauerman endeavours to describe all the more important mineral species. His remarks about the names of minerals and their derivations are well chosen; and both mining students and teachers of mineralogy should note the following paragraph:—"In the case of minerals worked as metallic ores, the ordinary commercial names should always be used where possible. Thus for all purposes copper pyrites, tinstone, and zinc blende are preferable to chalcopryrite, cassiterite, and sphalerite."

The classification adopted by the author "is in the main similar to that of Rammelsberg's 'Mineral-Chemie.'" Each description gives the form, the structure, the composition, and chemical characteristics, and concludes with the occurrence and distribution of the mineral. The crystallographic form is indicated both by Miller's notation and that of Naumann; and the figures of crystals are from the excellent wood blocks used originally for Brooke and Miller's "Mineralogy."

As might be expected from the author's wide experience as a traveller, the parts relating to occurrence are generally quite as complete as is compatible with the size of the volume: but strange to say, under the head of copper pyrites, the author omits all mention of the great mines of the provinces of Huelva in Spain, and Alemtejo in Portugal. It is true that they are not forgotten by him when speaking of iron pyrites; but Rio Tinto, which produces more copper than any other mine in the world, surely deserves notice quite as much as Devon Great Consols, Mellanear, or South Caradon. We must here correct an error of the author, who places Buitron in Portugal, whereas it is in Spain; and the great Portuguese mine is at San Domingos, not at Pomaron, which is simply the port of shipment, about eleven miles from the actual workings.

The author's acquaintance with Cornwall is not so exact as might be expected, for we find him making the statement that "in Cornwall" the tourmaline "is almost invariably known by the old German miners' name of *Schorl*"; in reality the Cornish term is *Cockle*. Fluor is omitted from the list of minerals associated with tinstone, and it is by no means so certain, as the author thinks, that kaolin has been produced by the action of atmospheric agencies upon the felspars of granite. There is, on the contrary, much to be said for the theory that the decomposing agents came from below. The remark that copper pyrites has been found in Dolcoath and neighbouring mines "in zones alternating in depth with tin ore," would lead one to suppose that there were several copper ore zones in the mines, which is not the case. The published section of Dolcoath shows only one copper zone, including, roughly speaking, the upper half of the workings, and one

tin zone, comprising the lower half. No doubt tin ore was obtained also from the *gossan* or ferruginous capping of the vein, and it might therefore be said that there were two tin zones with an intermediate copper zone, but this is not what is stated by the author. Under pyrites we read:—"In Cornwall the common term is Mundick, the varieties being distinguished as sulphur, copper, or arsenical mundic, according to the prevailing constituents." Does the author mean by this that a Cornish miner would call copper pyrites "copper mundic"? If so, he is surely mistaken.

We regret that there are occasional errors of spelling in the names of minerals and places. Thus "Freieslebenite" appears several times without the second "e," though it stands correct in the Index, and "Meconite" might puzzle the novice who had never heard of Meionite. However these are slight blemishes, and both they and the few other mistakes can easily be corrected in a second edition, which no doubt will be required, as Mr. Bauerman's manual is clear, compact, and handy, and is likely to be a favourite with students of mineralogy.

## THE MOSSES OF NORTH AMERICA

*Manual of the Mosses of North America.* By Leo Lesquereux and Thos. James. 8vo, pp. 447, with Six Plates Illustrative of the Genera. (Boston: S. E. Cassino and Co.; London: Trübner and Co. 1884.)

WE have much pleasure in calling the attention of bryologists on this side of the Atlantic to this excellent handbook of the "Mosses of North America." Many contributors have aided in its preparation, and a series of unfortunate disasters have delayed its publication at least ten years beyond what was expected, a delay which, however, has brought with it the compensation of greater completeness. Its foundation was laid by W. S. Sullivant, who contributed to the first edition of Gray's "Manual of the Plants of the Northern United States" in 1848 a synopsis of the mosses then known within the same territory, which were not more than about 200 species. In the second edition of the "Manual," published in 1856, the number of species was doubled, and five plates were given to show the essential characters of the genera. Of both these two treatises a few separate copies were also struck off. At that time there were four excellent bryologists resident in the country who were working actively—Sullivant, Lesquereux, Austin, and James—so that rapid progress was made. When the third edition of the "Manual" was issued, it was planned that Sullivant, in cooperation with Lesquereux, who worked at mosses with Schimper before he emigrated to America, where he has done such excellent work in fossil botany, should undertake an improved handbook of the mosses as a separate publication. Sullivant died in the spring of 1873 without this being carried into effect. His collection of specimens, drawings, and manuscript notes was bequeathed to the herbarium of Harvard University, which under the charge of Prof. Gray has for many years been the main centre for botanical work in the United States. It was planned that Mr. T. P. James, who belonged to Philadelphia, but who removed to live at Cam-

bridge, and who was excellently qualified for the task, should take Sullivant's place in the undertaking, but he died in 1882, and Lesquereux, in old age with his sight failing, was again left alone. The book might have altogether collapsed if it had not been for the kind intervention of Dr. Sereno Watson, who now has charge of the Harvard Herbarium, and who, although not specially a bryologist, has taken upon himself the needful critical and editorial labour that was required to complete it.

The book as now published includes all the mosses which are known on the North American continent within the limits of the United States and northwards. There is already a "Manual of the Mosses of Tropical America," by Mitten, in the twelfth volume of the *Journal* of the Linnean Society, and there are special monographs by Bescherelle on the mosses of Mexico and the West Indies. Sullivant has published figures of most of the endemic types, and Drummond, Austin and Sullivant and Lesquereux have issued extensive sets of dried specimens with numbers and printed labels. In the present work 900 species are included. A very large proportion of them are European, and as the close identity of the moss-flora of the temperate zone in the two continents is so interesting and important from a geographical point of view, we should have been glad if the example of Dr. Gray in marking those species which are common to Europe and America had been followed. Of the six plates five are those which were sketched out by Sullivant, and the sixth is devoted mainly to the sections of Hypnum. The classification does not differ materially from that of Bruch and Schimper, familiar to us in England from being used in Wilson's "Bryologia." The definitions of species and genera are commendably full and clear, and in not establishing or admitting species upon a slender foundation of differential character, the authors have followed the excellent example that has made Dr. Gray's manual, which has now reached its fifth edition, one of the most popular and practically useful of botanical handbooks.

At the end there is a useful glossary of the technical terms used in the descriptions. As it is such a good and cheap book and includes such a large proportion of the British species, it is well worthy of the attention of our home collectors.

J. G. BAKER

### LETTERS TO THE EDITOR

[The Editor does not hold himself responsible for opinions expressed by his correspondents. Neither can he undertake to return, or to correspond with the writers of, rejected manuscripts. No notice is taken of anonymous communications.]

[The Editor urgently requests correspondents to keep their letters as short as possible. The pressure on his space is so great that it is impossible otherwise to insure the appearance even of communications containing interesting and novel facts.]

#### The Diffusion of Species

DURING a recent cruise among the Hebrides two circumstances came before me, both of which are of some interest in natural history—one of them illustrating the curious conditions attending the diffusion of species, and the other illustrating the not less curious conditions affecting the multiplication of particular species in particular seasons.

The celebrated Island of Iona is separated from the nearest part of the Isle of Mull by a sound which is three-quarters of a mile wide. It is the channel of very strong tidal currents, and

when the winds blow in certain directions a heavy sea runs through it. This sound has been an effectual isolator of Iona from the access of several species common in Mull. Among others are to be numbered snakes and other reptiles. Tradition ascribes the immunity of the sacred isle to the blessing of St. Columba. Certainly it has been complete. Yet, strange to say, this immunity has been this year endangered. During the late very hot August an adder attempted the passage to Iona, and was in the act of effecting a successful landing, when, fortunately, it was seen by a boy and a girl who were occupied among the stones on the sea-shore. The adder was tired by its long swim, and the boy killed it without difficulty by stamping on its head. This is surely a very curious case of migration; and it is difficult to conceive the impulse under which the snake committed itself to the tides and currents of a channel so broad and dangerous. The hot weather of this year has no doubt developed in all reptiles an abnormal activity; and I saw a youth in Mull who had recently very nearly lost his life from the bite of an adder. The description given me of his condition for many hours brought home to my mind almost for the first time that we have in our own island a veritable member of the terrible "Thanatophidia." But it seems quite unaccountable why such a reptile should have attempted to cross the Sound of Iona.

The other circumstance to which I have referred is the marvellous development of the Salpidae this year in the Hebridean seas. I have cruised on those seas every year for fifteen years regularly, and I have been often on the look-out for these curious organisms; yet I have never seen them at all except once, and then only rarely and locally. Whereas this year the water was laden with them almost everywhere, and in some places it was rendered almost foul with their enormous quantity. In the Sound of Iona my tow-net was soon half filled with them; and the long chains of beautiful pattern which passed under the yacht lent an additional charm to the exquisite colour of that pure oceanic water. In the Sound of Raasay, near Portree, the number was still greater. But the maximum development appeared in Loch Scavaig, where, as far down as the eye could reach, there was nothing to be seen but Salpae in every variety of concatenation and decatenation—long chains, short chains, and countless myriads of separated individuals—making the whole sea little more than a thick soup of Salpae.

On being placed in a glass of water the muscular contractions of their bodies were beautifully exhibited, and their darting movements were very striking. Their exquisite crystalline material allowed every detail of structure to be seen; and on being placed in numbers in a bucket of water, and on being stirred at night, their phosphorescence was brilliant.

I should be glad to know from any of your correspondents whether there is any explanation of this exceptional development of these creatures.

ARGYLL.

Inveraray, September 6

#### Meteor, Moon, and Sun-Shine

DESCENDING the Calton Hill from the Royal Observatory on Tuesday night, I was much struck with the appearance, though momentary only, of a fine meteor of Venus-like brightness, passing in a short course from south-east to north-east nearly horizontally, and at a height of about half a degree above the Pleiades, at 3 minutes past 12 G.M.T. The yellowness of the meteor's light was very conspicuous, contrasted with the blueness of the faint stars and of the sky about them in that direction, shimmering in pale blue reflected moonlight; and seemed to speak of abundance of sodium, as well as a low temperature of incandescence, in that particular meteor.

But very different was the colour in the opposite quarter of the sky, or just west of south, where the moon, within a day of the full, was shining brilliantly, in white light immediately around and above it, but producing between it and the horizon, and for a considerable distance on either side, exactly and most perceptibly that faintly claret-coloured haze, which I have been remarking about and beneath the sun all this year. Precisely too as with the sun, the colour was shown on this occasion with the moon to be in the very highest regions of the atmosphere by any cumulus clouds, at heights of 3000 or 4000 feet, that floated past, being pre-eminent on that warm-coloured backing, by the pearly whiteness of their lights and blueness of their shadows. So far quite agreeably with Mr. Backhouse's recent and very interesting letter in NATURE (p. 359), stating that he had

found a solar dust-halo, with effects like the above, more and more visible the higher he ascended amongst the Alps.

That such appearances were produced by solid particles in a cold state, and not by any new gas introduced into the atmosphere, seems to be borne out by three sets of rather extensive solar spectroscopings which I have lately carried out; for while these does not seem to be a single new line amongst the thousands of old ones, so far as I have yet examined the observations, there is only too abundant evidence of a continued dulling of the light of the sun's continuous spectrum all along its range.

This effect is of course more conspicuous in the faint regions at either end than in the bright middle, and would appear to be testified to undeniably by the following differential observation, viz. that with a prismatic apparatus, wherewith I could see lines in the bright regions, say of B, C, and D, rather better than I could with somewhat similar, but darker, prisms in 1877.—I could not see Brewster's line Y and its companion groups in the very faint ultra-red so well as I did then; and could not see the further-away line X at all, though in 1877 it was not only clear enough, but far fainter lines on either side of it were visible and micrometrically measurable. Neither in 1884 have I been able with the same eye and instrument to see anything at the violet end of the spectrum of the grand banded lines H and K, though they formed a daily subject of observation in 1877.

In 1856 I remarkably appreciated that an ascent to 11,000 feet of altitude on the Peak of Teneriffe enabled H and K to be seen with peculiar distinctness and fine resolution of much of their haze at lower levels into sharp lines; but would that have been equally the case this year, when the inhabited regions of the earth, and the lower clouds too, are covered in by a widespread blanket of dust in most anomalous extent and density?

C. PIAZZI SMYTH

Astronomer-Royal for Scotland

15, Royal Terrace, Edinburgh, September 6

#### Pons' Comet- Pink Glow

THIS comet was visible here up to the beginning of June. I saw it on fourteen nights in April and eighteen in May, including the last eleven nights of the latter month. It could be seen with an opera-glass up to April 3; my last sight of it was with a 4-inch telescope on June 1, or rather at 12.30 a.m. of June 2 (= June 1d. 1h. G.M.T.). On April 24, and again and particularly on May 24 it seemed to me to have become suddenly fainter, though there seemed nothing in the state of the sky to account for it; indeed, on the last-named night I have noted, "sky very clear." Up to at least May 28 its motion in two or three hours could be plainly seen. On that night, though "very diffused and faint," it was visible before the moon had set. It had not, I think, on June 2 reached the *minimum visibile*, but as I had no ephemeris subsequent to that (to the middle of April) given in NATURE, it would have been quite useless to have looked for it again after the moon had passed.

I may add that the "pink glows" have not yet left us; on the last two evenings (July 1 and 2), which were clear, they were very distinct.

A. S. ATKINSON

Nelson, N.Z., July 3

#### Alternation of Generations in Salpa

WHILE we are indebted to Prof. W. K. Brooks for having enunciated his views on this subject clearly in NATURE for August 14 (p. 367), I should like to point out that the misquotations which he has called attention to in an article of mine published in May (p. 67) do not invalidate the strength of the counter-arguments, although I must apologise for their having been allowed to appear.

He does not acknowledge that the question at issue is one not of fact but of the explanation of accepted fact, i.e. it is a question of theory. Undoubtedly an egg migrates from the body of the solitary Salpa to that of the chain form, but Kowalevsky, who himself describes this, does not agree with Prof. Brooks' conclusion drawn therefrom.

Prof. Brooks pointed out at greater length than I did that the

hermaphroditic

productive cell becomes marked out earlier and earlier, until in Salpa it is fully developed in the body of the geminating individual. Then, instead of showing by his nomenclature that

Salpa is the end of a series, he prefers to break loose from any attempt at continuity and to call the solitary Salpa a true female.

I, however, prefer to follow in the steps of Prof. Moseley, who says of similar changes in the Hydromedusæ, that "it would lead to great confusion if the old way of regarding the matter was upset. The past history of the gonophores must be taken into account, and the fact that the sexual elements, though now developed at a greater or less distance in many species, formerly undoubtedly originated within the gonophore."

As Prof. Brooks does not use language in this way, it is not remarkable that he criticises me for using the term "hydroid" in regard to *Cunina* at a stage comparable to the hydriform and geminating person of a Sertularian, although I pointed out that it is a *Medusa* in both generations.

The fault of Prof. Brooks' argument is that he is not consistent. He says: "Very many chain *Salpæ* are produced at one time. As these have no power to reproduce by budding, they have *lost their ovaries*, although each of them when it is born contains, like the bud of *Pyrosoma*, a single unfertilised egg."

If this means that the egg is the sole remnant of the ovary, it admits all that I contend for; but if, on the other hand, it means that in a less modified condition these must have an ovary proper to the bud as well as the ovum received from the solitary *Salpa*, it follows that *Salpa* cannot be differentiated from a form like *Pyrosoma*, where there is, so to speak, a migrating ovary, but no trace of ovary independently formed in the bud. The second ovary described by Salensky cannot be a trace of this, for it is simply another ovum with follicular covering precisely like the first.

R. N. GOODMAN

St. John's College, Cambridge

#### Forked Lightning

BY papers received by last mail I see that Mr. W. C. Gurley claims to have shown, by photographing a flash of lightning, that the ordinary notion of *forked* lightning must be given up. I do not know whether this conclusion has been drawn from the photograph of a single flash or not, but you will see from the enclosed photographs that the conclusion is an entirely false one. An examination of my photographs will show that all the flashes except one had the zigzag form, and that some of them are magnificently forked. They resemble very closely the photographs of sparks from a Holtz electrical machine, taken by Mr. A. Matheson in Prof. Tait's laboratory, and published in vol. xxvii. Part 3, of the *Transactions* of the Royal Society of Edinburgh. The amount of detail shown in the photograph of the tree illuminated by the flash gives one a very good idea of the brightness, when we consider that exposure cannot have exceeded the millionth part of a second. I may add that my first photograph was taken on October 16, 1883, and was circulated amongst friends immediately afterwards.

C. MICHEL SMITH

Madras Christian College, Madras, August 9

#### Sun-Glows

AS one of the first to draw attention in the *St. James's Gazette* of October 1, and November 9, 1883, and many subsequent occasions, to those strange phenomena about the sun last autumn, will you kindly allow me space in your valuable columns to ask how it is possible to refer such effects any longer (as Mr. Backhouse does in your paper of August 14, p. 359) to volcanic dust from, I presume, the Krakatoa eruption, when we know now that in south latitudes these phenomena were observed by Mr. Neison of the Natal Observatory as early as the spring of 1883? He says that "they increased in intensity from February until June, when they were strongly marked." I have watched the sky as an artist (out of London) for quite forty years, and feel sure that this corona, or blanching of the sun, has been a more persistent feature of late years than formerly. It is still there, and may be seen without leaving England, or even London in clear weather, by looking for it from about an hour to half an hour before or after sunset and sunrise. The last very mild winter and the preceding one could have had no connection with the Krakatoa eruption, and I think that we must now seek for an explanation of the present and past atmospheric phenomena in some increase of solar energy, and consequent lifting of vapour higher than usual.

ROBERT LESLIE

6, Moira Place, Southampton, August 24



### Fireballs

IN addition to the occurrences recently recorded in your columns, it may be well to quote a further observation communicated in a letter, by Lady Borthwick, to the *Morning Post* for August 16, dated from Derculich, Ballinlaig, Perthshire, from which I extract the following particulars:—

As several curious phenomena of a like kind had been described as having occurred in Edinburgh during a terrific thunderstorm on Tuesday, August 12, the writer proceeds to detail what had been witnessed by herself and some others in her neighbourhood. The storm began at 10 o'clock in the morning and continued with unabated violence till past 10 at night. It appeared to be at its height from about 3 till 7 p.m., when as many as three flashes of lightning occurred to one peal of thunder. In many cases they were of a vivid pink colour. At about 6 o'clock a loud noise was heard, unlike any preceding it: "the heavens seemed to open, and there issued from the clouds what appeared like a ball of fire, about the size of a man's head, which exploded with a terrific crash, emitting quantities of sparks." It then appeared to descend at a distance of not more than twenty yards from the house. Mr. J. K. Laughton, commenting upon the phenomenon in the next issue, states that "ball lightning" is not solid, but yet in "passing along the surface of soft land it ploughs it up in a way that no cannon ball could do," and refers to an instance of this mentioned by Scott in his "Elementary Meteorology."

At a recent meeting of the Paris Academy of Sciences, M. Gaston Planté illustrated some remarks upon globular electric bolts by producing artificially effects analogous to those of fireballs, and it would be interesting to know more respecting their nature. As they appear to occur only very occasionally, on account of the rare conditions of the atmosphere producing them, it is certainly advisable to collect all the evidence respecting them that is obtainable. By such means it may in the course of time become possible for those who are competent to deal with the facts, to arrive at some definite conclusions concerning this little understood phenomenon. WM. WHITE

September 2

### Deep-Sea Corals

PROF. H. N. MOSELEY, F.R.S., in his masterly address to the Biological Section of the British Association at Montreal, dealt, amongst other matters, with the zoological position of the remarkable genera of deep-sea corals named *Guynia, nobis*, and *Haplophyllia* and *Duncania*, of Pourtales. He states that he has found, after examining sections of the last-named genus, that the soft parts indicate that it and the others are *Hæactinia*, and have the construction of *Caryophyllia* and of all other corals of that group. These genera were placed amongst the Rugosa, the first-mentioned by myself fourteen years since, and the others by Pourtales later on. On April 3 of the present year I read a communication to the Linnean Society, entitled "A Revision of the Families and Genera of the Madreporaria," and this revision is published. As Prof. Moseley left England before I could send him a copy, he and some other naturalists who study the corals will be perhaps interested by knowing that I have placed those genera where Prof. Moseley has located them subsequently. They form an alliance in the family Turbinolidae, and I was led to alter the classificatory position on account of a careful examination of the hard parts.

August 30

P. MARTIN DUNCAN

### Iridescent Lunar Halos

ON the evening of July 4, from 5.30 p.m. to 7 p.m., the moon, eleven days old, was surrounded with a series of extraordinary halos consisting of a succession of concentric rings; fine, clear starlight; very light airs from south-west and west-south-west; thermometer, 42°.

At 5.30, very light fleecy scud from south-west, the moon surrounded with a halo of about three times its diameter, of dullish white within a ring of orange; rapid changes ensued: the moon appeared within an opaque circle intensely white, surrounded with chromatic rings in the following order—yellow, orange, red, indigo, a broad ring of blue, yellow, orange, red, indigo, deep blue, bordered by a faint ring of orange. At this time the moon appeared as a bright boss on a many-coloured shield; changes rapidly followed: at 5.35 the rings were as follows—white, yellow, orange, red, indigo, blue, yellow, orange; for

some moments the outer ring of orange became blurred, the broad ring of blue very deep and beautiful; at 5.50 all of the halo had disappeared; sky clear, bright starlight all round, except where a few light fleecy clouds lay to the north-east. At 6.10 light scud from south-west; at 6.12 halo again formed, as follows—white, yellow, orange; in a few moments were added red, indigo, blue, orange; soon a mass of whitish scud, light and fleecy, seemed to gather round the moon widely, in a huge irregular oval, changing almost to a circle with uneven edges. At 6.20 the halo had disappeared; then came a bow-shaped yellowish coloration on the south-west of the moon, changing instantly to orange, red, indigo, faint indistinct orange; at 6.22 all clear again; at 6.29 bright almost dazzling rays immediately surrounded or jettied from the moon. At 6.30, north of the moon, orange appeared on some light scud; soon changes again took place: immediately on the edge the moon, where the rays were so brilliant, was now very dark with jagged edges within an intensely white ring, surrounded with a series of sharply-defined chromatic rings in the order they appeared at 5.35. At 6.35 another mass of whitish scud widely surrounded the moon as before described; at 6.48 all clear again; instantly after an orange patch appeared on scud to the north; at 6.56 orange on east; at 7 p.m. all was again clear; rays as dazzling as at an earlier period; temperature sensibly lower; frost at night. T. H. POTTS

Ohinitahi, N.Z., July 5

### Sextants

IN your review of the "Encyclopædia Britannica" published last week I notice that reference is made to an article on navigation by Capt. Moriarty, and attention is called to the very serious error in sextants arising from false centering. Having had some experience in the examination of these instruments, I can practically testify to this most important defect. Only a week or so since two sextants were received here for trial, one of which belonged to a captain of the mercantile marine. In both instances, although the mirrors and shades were good, yet the arc error due to false centering was excessively large, increasing from 0° to +7° at 60°, while at 90° it amounted to 10°. Surely this must be a serious matter to navigators, but, as you point out, for the small fee of five shillings persons ordering a sextant may direct the maker to send it to the Observatory, where suitable apparatus is arranged not only for examining the arc but also the mirrors and shades. It is only fair, however, to say that when instruments are sent direct from the makers we do not often have occasion to reject one. Indeed, superior sextants by first-class makers rarely have an error exceeding 1° of arc, and often not more than 30", but how few these are in comparison with the hundreds of inferior instruments that pass into the hands of the public without being tested. T. W. BAKER

The Kew Observatory, Richmond, September 2

### Electrical Rainbow

I WAS one of a deputation of River Tyne Commissioners who visited the South Foreland, to see the experimental lights now on trial there, on Saturday night, August 30. We were walking across the fields from the lights towards the observing hut No. 2, a distance of about a mile and a half. There was a fog more or less, and a shower of rain as we were approaching the hut, and every time the electric light from A tower revolved, a rainbow, very like a faint lunar bow, made its appearance. I could not see any prismatic colour, and the bow was only produced by the large electric light, with carbons of 1½ inch in diameter. There was no bow visible from the old light, which has carbons of about ¾ inch square, and none from either the gas or oil lights. I was informed that this was the first time such a phenomenon had been observed. R. S. NEWALL

Ferndene, September 3

### Rainbow on Spray

A CURIOUS appearance, which I have never observed before, was visible here for a few minutes this forenoon. Large breakers were rolling in to the bay, and their fronts (covered with foam) were brilliantly white in the sunshine. But, as each passed a particular spot, directly opposite to the sun, the spray blown back from its crest took a bright reddish-brown colour. This was the color of the primary rainbow. When observed from a

more elevated point, the apparent colour of the spray became bluish.

G. H.

September 5

#### Circular Rainbow seen from a Hill-top

NOTICING a communication in NATURE (p. 361) regarding the phenomenon of a circular rainbow, I thought it worth while to mention a case which lately came under my observation. Standing on a point of rock just opposite the beautiful falls of Montmorenci, Quebec, I was surprised to see a rainbow in the form of a circle passing through my feet. The spray from the falls was being blown into a deep cove in front of me, and the sun was high in the heavens behind. The primary was well defined and very beautiful; the secondary was faint. I understand that the conditions for seeing this circular rainbow are not often favourable at Montmorenci; still it may not be amiss to advise intending visitors *not* to stop at the bottom of the steps which lead down below the falls, but to clamber over the rocks as near the water as possible.

W. L. GOODWIN

Montreal, August 28

#### Intelligence in Frogs

A FRIEND in Scotland has a small lake in his grounds, which are surrounded by a high wall. At the bottom of the lake is a sluice by which the water can be let off into a burn below the grounds. A few weeks ago the lady of the house was walking down the road outside the wall towards the burn when, to her astonishment, she met a multitude of frogs making their way up the road, which makes a considerable detour, to the gate leading into the grounds. On inquiry she found that the lake had that morning been emptied through the sluice, and it was plain that these were frogs which, having been carried down with the water to the burn, were now making their way back to their old home. By what instinct did they know that the long road led to the point from which the short one had started?

B. W. S.

September 3

#### THE TEMPERATURE OF THE SOLAR SURFACE

THE power developed by the sun motor, recorded in NATURE, vol. xxix, p. 217, has established relations between diffusion and energy of solar radiation which prove that the temperature of the surface of the sun is extremely high. I have, therefore, during the summer solstice of 1884, carried out an experimental investigation for the purpose of demonstrating the temperature of the solar surface corresponding with the temperature transmitted to the sun motor. Referring to the illustrations previously published, it will be seen that the cylindrical heater of the sun motor, constructed solely for the purpose of generating steam or expanding air, is not well adapted for an exact determination of the amount of surface exposed to the action of the reflected solar rays. It will be perceived on inspection that only part of the bottom of the cylindrical heater of the motor is acted upon by the reflected rays, and that their density diminishes *gradually* towards the sides of the vessel; also that owing to the imperfections of the surface of the reflecting plates the exact course of the terminal rays cannot be defined. Consequently, the most important point in the investigation, namely, the area acted upon by the reflected radiant heat, cannot be accurately determined. I have accordingly constructed an instrument of large dimensions, a polygonal reflector (see Fig. 1), composed of a series of inclined mirrors, and provided with a central heater of conical form, acted upon by the reflected radiation in such a manner that each point of its surface receives an equal amount of radiant heat in a given time. The said reflector is contained within two regular polygonal planes twelve inches apart, each having ninety-six sides, the perimeter of the upper plane corresponding with a circle of eight feet diameter, that of the lower plane being six feet. The corresponding sides of these planes are connected by flat taper mirrors composed of thin glass silvered on the out-

side. When the reflector faces the sun at right angles, each mirror intercepts a pencil of rays of 32.61 square inches section, hence the entire reflecting surface receives the radiant heat of an annular sunbeam of  $32.61 \times 96 = 3130$  square inches section. It should be observed that the area thus stated is 0.011 less than the total foreshortened superficies of the ninety-six mirrors if sufficiently wide to come in perfect contact at the vertices. Fig. 2 represents a transverse section of the instrument as it appears when facing the sun; the direct and reflected rays being indicated by dotted lines. The reflector and conical heater are sustained by a flat hub and eight radial spokes bent upwards towards the ends at an angle of 45°. The hub and spokes are supported by a vertical pivot, by means of which the operator is enabled to follow the diurnal motion of the sun, while a horizontal axle, secured to the upper end of the pivot, and held by appropriate bearings under the hub, enables him to regulate the inclination to correspond with the altitude of the luminary. The heater is composed of rolled plate iron 0.017 inch thick, and provided with head and bottom formed of non-conducting materials. By means of a screw-plug passing through the bottom and entering the face of the hub the heater may be applied and removed in the course of five minutes, an important fact, as will be seen hereafter. It is scarcely necessary to state that the proportion of the ends of the conical heater should correspond with the perimeters of the reflector, hence the diameter of the upper end, at the intersection of the polygonal plane, should be to that of the lower end as 8 to 6, in order that every part may be acted upon by reflected rays of equal density. This condition being fulfilled, the temperature communicated will be perfectly uniform. A short tube passes through the upper head of the heater, through which a thermometer is inserted for measuring the internal temperature. The stem being somewhat less than the bore of the tube, a small opening is formed by which the necessary equilibrium of pressure will be established with the external atmosphere. It should be mentioned that the indications of the thermometer during the experiment have been remarkably prompt, the bulb being subjected to the joint influence of radiation and convection.

The foregoing particulars, it will be found, furnish all necessary data for determining with absolute precision the *diffusion* of rays acting on the central vessel of the solar pyrometer. But the determination of temperature which uninterrupted solar radiation is capable of transmitting to the polygonal reflector calls for a correct knowledge of atmospheric absorption. Besides, an accurate estimate of the loss of radiant heat attending the reflection of the rays by the mirrors is indispensable. Let us consider these points separately.

*Atmospheric Absorption.*—The principal object of conducting the investigation during the summer solstice has been the facilities afforded for determining atmospheric absorption, the sun's zenith distance at noon being only 17° 12' at New York. The retardation of the sun's rays in passing through a clear atmosphere obviously depends on the depth penetrated; hence—neglecting the curvature of the atmospheric limit—the retardation will be as the secants of the zenith distances. Accordingly, an observation of the temperature produced by solar radiation at a zenith distance whose secant is *twice* that of the secant of 17° 12', viz. 61° 28', determines the minimum atmospheric absorption at New York. The result of observations conducted during a series of years shows that the maximum solar intensity at 17° 12' reaches 66° 2 F., while at a zenith distance of 61° 28' it is 52° 5 F.; hence, minimum atmospheric absorption at New York, during the summer solstice, is  $66^{\circ} 2 - 52^{\circ} 5 = 13^{\circ} 7$  F., or  $\frac{13.7}{66.2} = 0.207$  of the sun's radiant energy where the rays enter the terrestrial atmosphere.

In order to determine the loss of energy attending the

reflection of the rays by the diagonal mirrors, I have constructed a special apparatus, which by means of a parallax mechanism faces the sun at right angles during observations. It consists principally of two small mirrors, manufactured of the same materials as the reflector, placed diagonally at right angles to each other; a thermometer being applied between the two, whose stem points towards the sun. The direct solar rays entering through perforations of an appropriate shade, and reflected by the inclined mirrors, act simultaneously on opposite sides of the

bulb. The mean result of repeated trials, all differing but slightly, show that the energy of the direct solar rays acting on the polygonal reflector is reduced 0.235 before reaching the heater.

In accordance with the previous article, the investigation has been based on the assumption that, *the temperatures produced by radiant heat at given distances from its source are inversely as the diffusion of the rays at those distances. In other words, the temperature produced by solar radiation is as the density of the rays.*

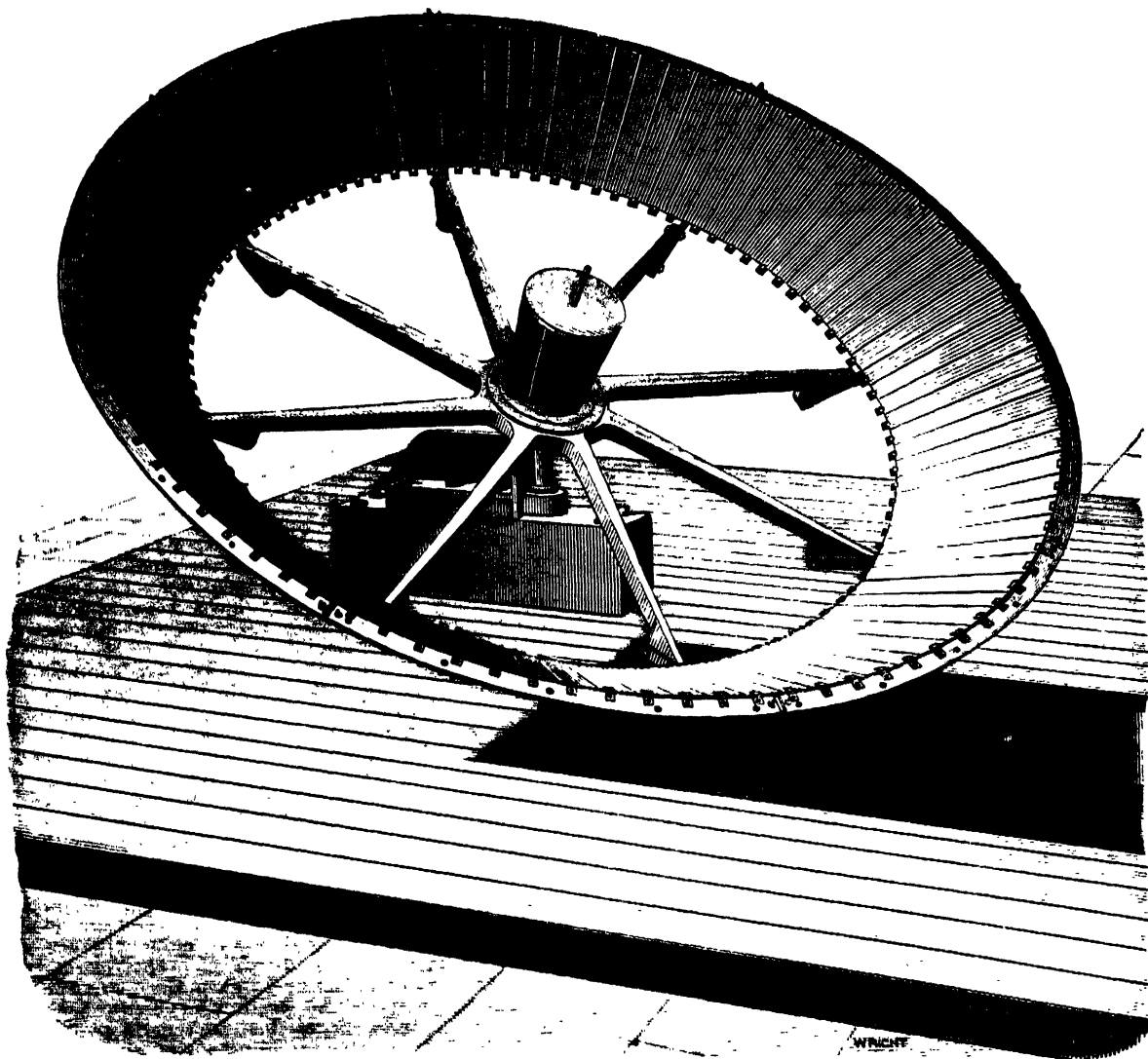

Captain Ericsson's Solar Pyrometer, erected at New York, 1884.

It will be remembered that Sir Isaac Newton, in estimating the temperature to which the comet of 1680 was subjected when nearest to the sun, based his calculations on the result of his practical observations that the maximum temperature produced by solar radiation was one-third of that of boiling water. Modern research shows that the observer of 1680 underrated solar intensity only 5° for the latitude of London. The distance of the comet from the centre of the sun being to the distance of the

earth from the same as 6 to 1000, the author of the "Principia" asserted that the density of the rays was as  $1000^2$  to  $6^2 = 28,000$  to 1: hence the comet was subjected to a temperature of  $28,000 \times \frac{180^\circ}{3} = 1,680,000^\circ$ , an intensity exactly "2000 times greater than that of red-hot iron" at a temperature of  $840^\circ$ . The distance of the comet from the solar surface being equal to one-third of the sun's radius, it will be seen that, in accordance with

the Newtonian doctrine, the temperature to which it was subjected indicated a solar intensity of  $\frac{4^2 \times 1,680,000}{3^2} = 2,986,000^\circ \text{F.}$

The writer has established the correctness of the assumption that "the temperature is as the density of the rays," by showing practically that the *diminution* of solar temperature (for corresponding zenith distances) when the earth is in aphelion corresponds with the increased diffusion of the rays consequent on increased distance from the sun. This practical demonstration, however, has been questioned on the insufficient ground that "the eccentricity of the earth's orbit is too small and the temperature produced by solar radiation too low" to furnish a safe basis for computations of solar temperature.

In order to meet the objection that the diffusion of the rays in aphelion do not differ sufficiently, the solar pyrometer has been so arranged that the density, *i.e.* the diffusion of the reflected rays, can be changed from a ratio of 1 in 5040 to that of 1 in 10,241. This has been effected by employing heaters respectively 10 inches and 20 inches in diameter. With reference to the "low" solar temperature pointed out, it will be perceived that

the adopted expedient of increasing the density of the rays without raising the temperature by *converging* radiation, removes the objection urged.

Agreeably to the dimensions already specified, the area of the 10-inch heater acted upon by the reflected solar rays is 331.65 square inches, the area of the 20-inch heater being 673.9 square inches. The section of the annular sunbeam whose direct rays act upon the polygonal reflector is 3130 square inches, as before stated.

Regarding the diffusion of the solar rays during the investigation, the following demonstration will be readily understood. The area of a sphere whose radius is equal to the earth's distance from the sun in aphelion being to the sun's area as 2181<sup>2</sup> to 1, while the reflector of the solar pyrometer intercepts a sunbeam of 3130 square inches section, it follows that the reflector will receive the radiant heat developed by  $\frac{3130}{2181^2} = 0.0658$  square inch of the solar surface. Hence, as the 10-inch heater presents an area of 331.65 square inches, we establish the fact that the reflected solar rays, acting on the same, are *diffused* in the ratio of 331.65 to 0.0658, or  $\frac{331.65}{0.0658} = 5040$  to 1; the

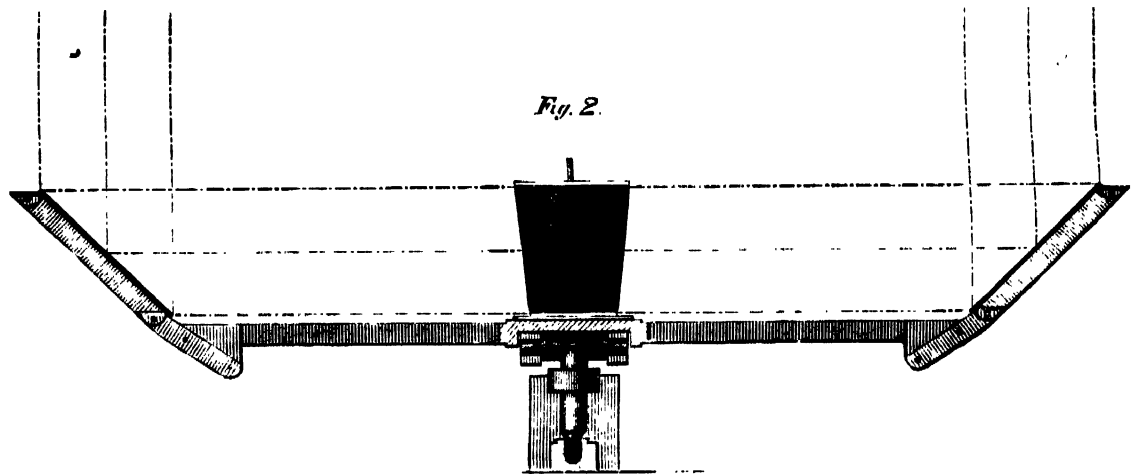

diffusion of the rays acting on the 20 inch heater being as 673.9 to 0.0658, or  $\frac{673.9}{0.0658} = 10,241$  to 1.

The atmospheric conditions having proved unfavourable during the investigation, maximum solar temperature was not recorded. Accordingly, the heaters of the solar pyrometer did not reach maximum temperature, the highest indication by the thermometer of the small heater being 336.5, that of the large one being 200.5 above the surrounding air. No compensation will, however, be introduced on account of deficient solar heat, the intention being to base the computation of solar temperature solely on the result of observations conducted at New York during the summer solstice of 1884. It will be noticed that the temperature of the large heater is proportionally higher than that of the small heater, a fact showing that the latter, owing to its higher temperature, loses more heat by radiation and convection than the former. Besides, the rate of cooling of heated bodies increases more rapidly than the augmentation of temperature.

The loss occasioned by the imperfect reflection of the mirrors, as before stated, is 0.235 of the energy transmitted by the direct solar rays acting on the polygonal reflector, hence the temperature which the solar rays are capable of imparting to the large heater will be  $200.5 \times 1.235 = 247.617$ ; but the energy of the solar rays acting on the

reflector is reduced 0.207 by atmospheric absorption, consequently the ultimate temperature which the sun's radiant energy is capable of imparting to the heater is  $1.207 \times 247.617 = 298.87^\circ \text{F.}$  It is hardly necessary to observe that this temperature (developed by solar radiation diffused fully ten-thousandfold) must be regarded as an *actual* temperature, since a perfectly transparent atmosphere, and a reflector capable of transmitting the whole energy of the sun's rays to the heater, would produce the same.

The result of the experimental investigation carried out during the summer solstice of 1884 may be thus briefly stated. The diffusion of the solar rays acting on the 20-inch heater being in the ratio of 1 to 10,241, the temperature of the solar surface cannot be less than  $298.87 \times 10,241 = 3,060,727^\circ \text{F.}$  This underrated computation must be accepted unless it can be shown that the temperature produced by radiant heat is not inversely as the diffusion of the rays. Physicists who question the existence of such high solar temperature should bear in mind that in consequence of the great attraction of the solar mass, hydrogen on the sun's surface raised to a temperature of 4000° C., will be nearly twice as heavy as hydrogen on the surface of the earth at ordinary atmospheric temperatures; and that, owing to the immense depth of the solar atmosphere, its density would be so enormous at the stated

low temperature that the observed rapid movements within the solar envelope could not possibly take place. It scarcely needs demonstration to prove that extreme tenuity can alone account for the extraordinary velocities recorded by observers of solar phenomena. But *extreme tenuity* is incompatible with low temperature and the pressure produced by an atmospheric column probably exceeding 50,000 miles in height subjected to the sun's powerful attraction, diminished only one-fourth at the stated elevation. These facts warrant the conclusion that the high temperature established by our investigation is requisite to prevent undue density of the solar atmosphere.

It is not intended at present to discuss the necessity of tenuity with reference to the functions of the sun as a radiator; yet it will be proper to observe that on merely dynamical grounds the enormous density of the solar envelope which would result from low temperature, presents an unanswerable objection to the assumption of Pouillet, Vicaire, Sainte-Claire Deville, and other eminent savants, that the temperature of the solar surface does not reach 3000° C.

J. ERICSSON

### THE BRITISH ASSOCIATION

HOSTS and guests have been abundantly satisfied with the results of the Canadian Meeting of the British Association. The Canadians have done their very utmost for their guests, and the latter appear to have responded heartily. There have been, to judge from the very full reports in the *Times*, some notable incidents in connection with the meeting, which will no doubt be fully noticed in the reports from our Special Correspondents, which we hope to receive in time for next week's number.

The General Committee met on Wednesday, with Lord Rayleigh in the chair. The aggregate membership was reported as 1773, of whom 558 were old and 1215 new. The following are the grants of money that have been made:—

Mathematical Section.—Meteorological observations near Chepstow, 25*l.*; synoptic charts of the Indian Ocean, 50*l.*; reduction of tidal observations, 10*l.*; calculation of mathematical tables, 100*l.*; meteorological observations on Ben Nevis, 50*l.*; solar radiation, 20*l.*; meteoric dust, 70*l.*

Chemical Section.—Vapour pressures and refractive indices of salt solutions, 25*l.*; chemical nomenclature, 5*l.*; physical constants of solutions, 20*l.*

Geological Section.—Volcanic phenomena of Vesuvius, 25*l.*; Raygill fissure, 15*l.*; earthquake phenomena of Japan, 75*l.*; fossil Phyllopora of the Palaeozoic rocks, 25*l.*; fossil plants of British Tertiary and Secondary beds, 50*l.*; *Geological Record*, 50*l.*; erosion of sea-coasts, 10*l.*; circulation of underground waters, 10*l.*

Biological Section.—Table at Naples Zoological Station, 100*l.*; *Zoological Record*, 100*l.*; migration of birds, 30*l.*; exploring Kilimanjaro and adjoining mountains of Equatorial Africa, 25*l.*; recent Polyzoa, 10*l.*; marine biological station at Granton, 100*l.*; biological stations on coast of United Kingdom, 150*l.*

Geographical Section.—Exploring New Guinea, 200*l.*; exploring Mount Roraima, 100*l.*

Mechanical Section.—Patent legislation, 5*l.*

Anthropological Section.—Investigating the characteristic physical and other features of north-west tribes of Canada, 50*l.*; physical characteristics of the races in the British Isles, 10*l.* Total, 1525*l.*

In the case of the following Committees no money grants were voted:—Committees on practical standards for use in electrical measurements, for promoting tidal observations in Canada, for calculating tables of fundamental variations of algebraic forms, for securing harmonic analysis in reducing tidal observations, for com-

paring and reducing magnetic observations, for investigating the rate of increase of underground temperatures, for securing an international geological map of Europe, for reporting on erratic blocks of England, Wales, and Ireland, for examining marine life on coasts and rivers of North America, for survey of Palestine, and for science teaching in elementary schools. A vote was passed that the Council be recommended to request the Admiralty to adopt an harmonic analysis for the reduction of tidal observations. This is already being done in Germany, France, India, and elsewhere. A letter was read on the subject prepared by Sir William Thomson and Prof. G. H. Darwin to send to the Admiralty. The Council was also recommended to request the Canadian Government to adopt measures for investigating the physical character, languages, social and artistic condition of the native tribes of the Dominion. Various American members having suggested that an International Scientific Congress be formed, this subject was referred to the Committee by several Sections.

The General Committee adjourned to meet in London on November 11.

The closing meeting of the Association was held in Queen's Hall the same afternoon. There was a large attendance, Lord Rayleigh being in the chair. Admiral Ommanney, the acting treasurer, announced the membership, and also the total receipts, which have been about 1800*l.* The suggestion as to an International Scientific Congress was received with applause.

The Corporation and Faculty of McGill University were on the platform, and Sir William Dawson, the Principal, after a brief preliminary address, conferred the honorary degree of LL.D. upon the leading members of the Association, whose names have already been given. As the diplomas were delivered, warm applause greeted each recipient.

Lord Rayleigh thanked the University for the honours conferred and also for the splendid hospitality given to the Association, the recollection of which they would retain during the remainder of their lives. He said that no previous meeting had been so well provided with meeting-rooms as the University furnished. As a slight token of acknowledgment for Montreal's reception, the Association had provided a gold medal and endowment for McGill University, although he felt they could never fully appreciate the generosity of their hosts.

Sir Richard Temple moved, and Prof. Boyd Dawkins seconded, a resolution expressing cordial sympathy with the popular movement set on foot in Montreal to establish a public library worthy of the great city to properly mark the occasion of the first meeting of the British Association in Canada. Both made brief addresses, urging the members to aid the project. Sir William Thomson spoke in its advocacy, saying that a good library would be of vast importance to Montreal and to this portion of North America, that it would be an excellent basis for the subsequent establishment of a good scientific school. He urged the members to give liberal subscriptions. The resolution was adopted amid applause.

Sir Lyon Playfair moved, and General Lefroy seconded, a resolution of cordial thanks to the Dominion Government for the aid, support, and sympathy shown in promoting the Montreal meeting of the British Association, and for the warm interest felt in its success, which was adopted. Mr. J. White, a member of the Canadian House of Commons, responded for the Dominion Government.

Sir William Thomson moved, and Sir Frederick Bramwell seconded, a resolution of thanks to the McGill University, the Corporation of Montreal and its citizens, with a long list of other bodies who aided in promoting the objects of the meeting. Sir James Ferrier responded, saying, in the course of a felicitous address, that already the projected public library had been fairly started by a

proposed gift to McGill College for this purpose, by a benevolent gentleman of Montreal, of \$50,000.

Other votes of thanks were passed to railway, steamer, and telegraph companies, and others who have aided the meeting. Mr. Hugh M'Lennan and Mr. Andrew Robertson responded for them.

The final vote of thanks to the President was moved by Prof. Daniel Wilson and seconded by Prof. Robert Ball and Sir William Dawson. After a brief appropriate reply by Lord Rayleigh, the British Association adjourned, to meet at Aberdeen in 1885.

About 300 British and Canadian members of the Association have arrived in Philadelphia from Montreal to attend the meetings of the American Association for the Advancement of Science. A local hospitality committee received them at the railway stations, providing homes for them with citizens or in hotels. They were formally welcomed to Philadelphia at a large meeting at the Academy of Music on Friday night. Mr. John Welsh, formerly Minister to England, delivered an address as chairman of the local committees, and Provost Pepper, of the University of Pennsylvania, made a special address of welcome, to which Prof. Robert S. Ball replied for the British Association. A members' promenade reception and banquet followed. The British guests were given excursions on Saturday to the Atlantic sea-coast resorts near Philadelphia; also by the Pennsylvania Railroad to Cresson, at the summit of the Alleghany Mountains; also by the Reading Railroad through the anthracite coal regions of Pennsylvania.

The American Association has appointed a Committee to confer with a similar Committee of the British Association relative to arranging for the proposed International Scientific Congress referred to in the closing proceedings of the British Association at Montreal.

## SECTION E GEOGRAPHY

OPENING ADDRESS BY GENERAL SIR J. H. LEFROY, R.A.,  
C.B., K.C.M.G., F.R.S., F.S.A., V.P.R.G.S., PRESIDENT  
OF THE SECTION

MAN'S acquaintance with the planet he inhabits, with the earth which he is to replenish and to subdue, has been a thing of growth so slow, and is yet so imperfect, that we may look to a far distant day for an approach to a full knowledge of the marvels it offers, and the provision it contains for his well-being. He has seen, as we now generally believe, in silent operation, the balanced forces which have replaced the glacier by the forest and the field; which have carved out our present delights of hill and dale in many lands, and clothed them with beauty; and it may be that changes as great will pass over the face of the earth before the last page of its history is written in the books of eternity. But it is no longer before unobservant eyes that the procession of ages passes. Geography records the onward march of human families; often by names which survive them it rears enduring monuments to great discoverers, leaders, and sufferers; it is an indispensable minister to our every-day wants and inquiries; but beyond this it satisfies one of the most widely diffused and instinctive cravings of the human intelligence, one which from childhood to maturity, from maturity to old age, invests books of travels with an interest belonging to no other class of literature. If "the proper study of mankind is man," where else can we learn so much about him, or be presented with such perplexing problems, such diversity in unity, such almost incredible contrasts in the uses of that noble reason, that Godlike apprehension, which our great poet attributes to him? or see the "beauty of the world, the paragon of animals" (*Hamlet*, Act. ii. Sc. 2) in conditions so unlike his birthright? Geography, then, is far from being justly regarded as a dry record of details which we scarcely care to know, and of statistics which are often out of date.

It is scarcely necessary to do more than allude here to the intimate relations between geography and geology. The changes on the earth's surface effected within historical times by the operation of geological causes, and enumerated in geological

books, are far more numerous and generally distributed than most persons are aware of; and they are by no means confined to sea-coasts, although the presence of a natural datum in the level of the sea makes them more observed there. A recent German writer, Dr. Hahn, has enumerated ninety-six more or less extensive tracts known to be rising or sinking. We owe to Mr. R. A. Peacock the accumulation of abundant evidence that the island of Jersey had no existence in Ptolemy's time, and probably was not wholly cut off from the Continent before the fourth or fifth century. Mr. A. Howarth has collected similar proofs as to the Arctic regions; and every fresh discovery adds to the number. Thus the gallant, ill-fated De Long, a name not to be mentioned without homage to heroic courage and almost superhuman endurance, found evidence that Bennett Island has risen a hundred feet in quite recent times. Nordenskjöld found the remains of whales, evidently killed by the early Dutch fishers, on elevated terraces of Martin's Island. The recent conclusion of Prof. Hull, that the land between Suez and the Bitter Lakes has risen since the Exodus, throws fresh light on the Mosaic account of that great event; and to go still further south, we learn from the Indian Survey that it is "almost certain" that the mean sea-level at Madras is a foot lower, *i.e.* the land a foot higher, than it was sixty years ago. If I do not refer to the changes on the west side of Hudson's Bay, for a distance of at least six hundred miles, it is only because I presume that the researches of Dr. Robert Bell are too well known here to require it. Any of my hearers who may have visited Bermuda are aware that so gently has that island subsided, that great hangings of stalactite, unbroken, may be found dipping many feet into the sea, or, at all events, into salt-water pools standing at the same level, and we have no reason to suppose the sinking to have come to an end. We learn from the Chinese annals that the so-called Hot Lake Issyk-kul, of Turkestan, was formed by some convulsion of nature about 160 years ago (*Proc. R.G.S.* vol. xviii. p. 250), and there seems no good reason to reject the Japanese legend that Fusi-yama itself was suddenly thrown up in the third century before our era (*u.c.* 286). These are but illustrations of the assertion I began with, that geography and geology are very nearly connected, and it would be equally easy to show on how many points we touch the domain of botany and natural history. The flight of birds has often guided navigators to undiscovered lands. Nordenskjöld went so far as to infer the existence of "vast tracts, with high mountains, with valleys filled with glaciers, and with precipitous peaks," between Wrangel Land and the American shores of the Polar Sea, from no other sign than the multitudes of birds winging their way northward in the spring of 1879, from the *Vega's* winter quarters. The walrus-hunters of Spitzbergen drew the same conclusion in a previous voyage from the flight of birds towards the Pole from the European side. Certainly no traveller in the more northern latitudes of this continent in the autumn, can fail to reflect on the ceaseless circulation of the tide of life in the beautiful harmony of Nature, where he finds that he can scarcely raise his eyes from his book at any moment, or direct them to any quarter of the heavens, without seeing countless numbers of wild fowl, guided by unerring instinct, directing their timely flight towards the milder climates of the South.

To address you on the subject of geography, and omit mention of the progress made within these very few years in our knowledge of the geography of this Dominion, might indeed appear an unaccountable, if not an unpardonable, oversight; nevertheless, I propose to touch upon it but briefly, for two reasons: first, I said nearly all I have to say upon a similar occasion four years ago; secondly and chiefly, because I hope that some of those adventurous and scientific travellers who have been engaged in pushing the explorations of the Geological Survey and of the Canada Pacific Railway into unknown regions will have reserved some communications for this Section. Canada comprises within its limits two spots of a physical interest not surpassed by any others on the globe. I mean the pole of vertical magnetic attraction, commonly called the magnetic pole; and the focus of greatest magnetic force, also often, but incorrectly, called a pole. The first of these, discovered by Ross in 1835, was revisited in May 1847 by officers of the Franklin Expedition, whose observations have perished, and was again reached or very nearly so by McClintock in 1859, and by Schwatka in 1879; neither of these explorers, however, was equipped for observation. The utmost interest attaches to the question whether the magnetic pole has shifted its position in fifty years, and although I am far from rating the difficulty lightly, it is probably approachable overland, without the great cost of an Arctic expedition. The

second; has never been visited at all, although Dr. R. Bell, in his exploration of Lake Nipigon, was within 200 miles of it, and the distance is about the same from the Rat Portage. It is in the neighbourhood of Cat Lake. Here then we have objects worthy of a scientific ambition and of the energies of this young country, but requiring liberal expenditure and well-planned efforts, continued steadily, at least in the case of the first, for, perhaps, three or four years. Of objects more exclusively geographical, to which it may be hoped that this meeting may give a stimulus, I am inclined to give a prominent place to the exploration of that immense tract of seventy or eighty thousand square miles, lying east of the Athabasca River, which is still nearly a blank on our maps, and in connection with such future exploration I cannot omit to mention that monument of philological research, the "Dictionary of the Languages of the native Chipewyans, Hare Indians, and Loucheux," lately published by the Rev. E. Petitot. The lexicon is preceded by an introduction, giving the result of many years' study among these people of the legends or traditions by which they account for their own origin. M. Petitot, who formerly was unconvinced of their remote Asiatic parentage, now finds abundant proof of it. But perhaps his most interesting conclusion is that in these living languages of the extreme north, we have not only the language of the *Nabajos*, one of the Apache tribes of Mexico, which has been remarked as linguistically distinct from the others, but also the primitive Aztec tongue, closely resembling the language of the Incas, the Quichoa, still spoken in South America. I need not say how greatly these relations, if sustained by the conclusions of other students, are calculated to throw light upon the profoundly interesting question of the peopling of America.

This is perhaps a proper occasion to allude to a novel theory proposed about two years ago, with high official countenance, upon a subject which will never cease to have interest, and perhaps never be placed quite beyond dispute. I mean the landfall, as it is technically called, of Columbus, in 1492. The late Captain G. V. Fox, of the Admiralty, Washington, argued in a carefully-prepared work, that Atwood's Key, erroneously called Samana on many charts, is the original Guanahari of Columbus, renamed by him S. Salvador, also that Crooked Island and Acklin Island are the Maria de la Concepcion of Columbus and the true Samana of succeeding navigators in the sixteenth century. The last supposition is unquestionably correct. Crooked, Acklin, and Fortune Islands, which from the narrowness of the channels dividing them may have been, and very probably were, united four centuries ago, are plainly the Samana of the Dutch charts of the seventeenth century, and are so named on the excellent chart engraved in 1775 for Bryan Edwards's "History of the West Indies," but the view that Atwood's Key is identical with Guanahari is original, and is neither borne out by any old chart, nor by Columbus's description. This small island is conspicuously wanting in the one physical feature by which Guanahari is to be identified "*una laguna en medio muy grande*." There is no lake or lagoon in it, nor does its distance from Samana tally at all with such slender particulars as have been left us by Columbus respecting his proceedings. The name S. Salvador has attached, not to Atwood's Key, but to Cat Island, one of the Bahamas; it is true that modern research has shifted it, but only to the next island, and on very good grounds. Cat Island is not *muy llana*, very level; on the contrary, it is the most hilly of all the Bahamas, and it has no lake or lagoon. Watling Island, a little to the south-east of Cat Island, and now generally recognised as the true Guanahari or S. Salvador, is very level; it has a large lagoon, it satisfies history as to the proceedings of Columbus for the two days following his discovery, by being very near the numerous islands of Exuma Sound, and I think few impartial persons can doubt the justice of the conclusion of the late Admiral Becher and of Mr. Major as to its identity; there are difficulties in the interpretation of Columbus's log on any hypothesis, but there is one little "undesigned coincidence" which to my mind goes far to carry conviction. Columbus, when he sighted land, was greatly in want of water, and he continued cruising about among the small islands in search of it for some days. Clearly, therefore, the *laguna* on Guanahari was not a fresh-water lake; nor is the lagoon on Watling Island fresh water, and so it exactly meets the case.

The report of Lieut. Raymond P. Rodgers, of the United States Navy, on the state of the Canal Works at Panama so lately as January 25 last, which has doubtless been eagerly read by many present, leaves me little to say on that great enterprise. Perhaps the following official returns of the amount of excavation

effected in cubic metres (a cubic metre is 1'308 cubic yards) will enable the audience to realise its progress:—

		Total excavated	In each month
1883	October ... ..	2,042,034 ... ..	
1883	November ... ..	2,375,534 ... ..	333,300
1883	December ... ..	2,760,534 ... ..	385,000
1884	January ... ..	3,340,534 ... ..	580,000
1884	February ... ..	3,974,191 ... ..	633,657
1884	March ... ..	4,590,022 ... ..	615,831

The total quantity of excavation to be done in a length of 46.6 miles is estimated at 100,000,000 cubic metres, but the rapid augmentation of quantity shows that the limit has not been attained. This is no place to speak of the stimulus given by this great work to mechanical invention or the gigantic power of the machines employed, which will probably receive attention in another Section, but I may mention the two great problems which still await solution. The first is how to deal with the waters of the River Chagres; the second is how to manage a cutting nearly 400 feet deep (110 m. to 120 m.). The Chagres is a river as large as the Seine, but subject to great fluctuations of volume; it cuts the line of the canal nearly at right angles, and for obvious reasons it is impossible to let it flow into it. It is proposed to arrest the stream by an enormous dyke at Gamboa, near the divide. It will cross a valley between two hills, and be 1050 yards long at the bottom, 2110 yards at the top, 110 yards thick at the base, and 147 feet in greatest height. Out of the reservoir so constructed it is proposed to lead the overflow by two artificial channels, partly utilising the old bed. The cutting will be nearly 500 feet wide at the top (150 m.), with the sides at a slope of  $\frac{1}{2}$ . It is proposed to attack it by gangs or parties working on twelve different levels at the same time, one each side of the summit, dividing the width at each level into five parallel sections. Thus there will be 120 gangs at work together, and it is confidently hoped that the whole will be really finished in 1888, the date long since assigned for its completion by M. de Lesseps. There is practically no other project now competing with it: for the proposed routes by the Isthmus of Tehuantepec, the Atrato, and San Blas, may be regarded as almost universally given up; both the latter would involve the construction of ship tunnels on a scale to daunt the boldest engineer. The so-called Caledonia route has not stood the test of examination. There remains but the Nicaragua route, and this, while practicable enough, has failed to attract capitalists, and is envied by political and other difficulties, which would leave it, if completed, under many disadvantages as compared with its rival. Among the latter must be named the necessity for rising by locks to the level of the Lake of Nicaragua (108 feet).

It is very tempting to speculate on the probable consequences of bringing the Hispano-Indian Republics bordering on the Pacific into such early contact with the energies of the Old World, but these speculations belong to politics rather than geography; moral transformations, we know, are not effected so easily as the conquest over physical difficulties.

Sir J. H. Lefroy then alluded at some length to recent progress in African exploration; then turning to Central Asia he went on:—

The Russian project for diverting the Oxus or Amu Darya from the Sea of Aral into the Caspian, remains under investigation. We learn from the lively account of Mr. George Kennan, a recent American traveller, that there is more than one motive for undertaking this great work, if it shall prove practicable. He states that the lowering of the level of the Caspian Sea, in consequence of the great evaporation from its surface, is occasioning the Russian Government great anxiety, that the level is steadily but slowly falling, notwithstanding the enormous quantity of water poured in by the Volga, the Ural, and other rivers. In fact, Col. Venukof says that the Caspian is drying up fast, and that the fresh-water seals, which form so curious a feature of its fauna, are fast diminishing in number. At first view there would not appear great difficulty in restoring water communication, the point where the river would be diverted being about 216 feet above the Caspian; but accurate levelling has shown considerable depressions in the intervening tract. As the question is one of great geographical interest we may devote a few minutes to it. It is not to be doubted that the Oxus, or a branch of it, once flowed into the Caspian Sea. Prof. R. Lenz, of the Russian Académie Impériale des Sciences, sums up his investigation of ancient authorities by affirming that there is no satisfactory evidence of its ever having done so before the year 1300;

passages which have been quoted from Arab writers of the ninth century only prove, in his opinion, that they did not discriminate between the Caspian Sea and the Sea of Aral. There is evidence that in the thirteenth and fourteenth centuries the river bifurcated, and one branch found its way to the Caspian, but probably ceased to do so in the sixteenth century. This agrees with Turcoman traditions. Even so late as 1869 the waters of the Oxus reached Lake Sara Kamysh, 80 or 90 miles from their channel, in a great flood, as happened also in 1850, but Sara Kamysh is now some 49 feet lower than the Caspian, and before they could proceed further an immense basin must be filled. The difficulties then of the restoration by artificial means of a communication which natural causes have cut off, are (a) the disappearance of the old bed, which cannot be traced at all over part of the way; (b) the possibility that further natural changes, such as have taken place on the Syr-Daria, may defeat the object; (c) the immense expenditure under any circumstances necessary, the distance being about 350 miles, which would be out of all proportion to any immediate commercial benefit to be expected. We may very safely conclude that the thing will not be done, nor is it at all probable that Russian finances will permit the alternative proposal of cutting a purely artificial canal by the shortest line, at an estimated expense of 15,000,000 to 20,000,000 roubles.

We have had, I think, no news of the intrepid Russian traveller, Col. Prjevalsky, who started from Kiahkta on November 20, of later date than January 20, when he had reached Alashan, north of the Great Wall. He had for the third time crossed the great Desert of Gobi, where he experienced a temperature below the freezing-point of mercury, and was to start for Lake Kuku-nor (+ 10,500 feet) the following day, thence to proceed to Tsaidam, where he proposed to form a depot of stores and provisions, and, leaving some of his party here, to endeavour to reach the sources of the Yang-tse-kiang, or Yellow River. It was his intention to devote the early part of the present summer to exploration of the Sefani country, situated between Kuku-nor to the north and Batan to the south—a country likely to yield an abundant harvest of novelty in natural history—afterwards to transfer his party to Hast, in Western Tsaidam, which may be reached next spring. From this point the expedition will endeavour first to explore Northern Thibet, which is his main object, in the direction of Lhasa and Lake Tengri-nor, and then returning northward, cross the Thibet plateau by new routes to Lake Lob-nor. After the re-assembly of the expedition at this point, it will probably regain Russian territory at Issyk-kul. Col. Prjevalsky is accompanied by two officers, an interpreter, and an escort of twenty Cossacks.

As you are aware, we have been chiefly indebted to natives of India for several years past for our knowledge of the regions beyond the British boundary. Mr. McNair, of the Indian Survey Department, who received the Murchison premium of this year, is the first European who has ever penetrated so far as Chitral, which is only 200 miles from Peshawur. In various disguises, however, natives, carefully instructed, have penetrated the neighbouring but unneighbourly regions of Afghanistan, Kashmir, Turkestan, Nepal, Thibet—in almost every direction—and these achievements were crowned by one of them, known as A-k, reaching Saitu or Sachu, in Mongolia, in 1882, and thence returning in safety to India, after an absence of four years. His route took him to Darchendo or Tachialo (lat. 31°), the most westerly point reached by the late Capt. W. J. Gill, R.E., in 1877, and thus connects the explorations of that accomplished and lamented traveller with Central Asia. A-k has brought fresh evidence that the Sanpoo and the Brahmapootra are one; the quite modern opinion that the former flows into the Irrawaddy being shown to be groundless. After draining the northern slopes of the Himalayas, the Brahmapootra makes a loop round their eastern flanks where it has been called the Dehang, and thence, as everybody knows, flows westerly to join the Ganges; the maps have been shown in this instance to be right. The travels of these native explorers, their stratagems and their disguises, their hazards and sufferings, their frequent hair-breadth escapes, are teeming with excitement. One of them describes a portion of his track at the back of Mount Everest, as carried for a third of a mile along the face of a precipice at a height of 1500 feet above the Bhotia-kosi River, upon iron pegs let into the face of the rock, the path being formed by bars of iron and slabs of stone stretching from peg to peg, in no place more than 18 inches, and often not more than

9 inches, wide. Nevertheless this path is constantly used by men carrying burdens.

One of the finest feats of mountaineering on record was performed last year by Mr. W. W. Graham, who reached an elevation of 23,500 feet in the Himalayas, about 2900 feet above the summit of Chimborazo, whose ascent by Mr. Whymper in 1880 marked an epoch in these exploits. Mr. Graham was accompanied by an officer of the Swiss army, an experienced mountaineer, and by a professional Swiss guide. They ascended Kabru, a mountain visible from Darjeeling, lying to the west of Kanchinjunga, whose summit still defies the strength of man.

And here I may refer to that great work, the Trigonometrical Survey of India. The primary triangulation, commenced in the year 1800, is practically completed, although a little work remains to extend it to Ceylon on one side and to Siam on the other. Much secondary triangulation remains to be executed, but chiefly outside the limits of India proper. The Pisgah views, by which some of the loftiest mountains in the world have been fixed in position, so netimes from points in the nearest Himalayas, 120 miles distant, only serve to arouse a warmer desire for unrestrained access. The belief long entertained that a summit loftier than Mount Everest exists in Thibet is by no means extinct, but it is possible that the snowy peak intended may prove eventually to be the Mount Everest itself of the original Survey. Still, however, science, in spite of fanatical obstruction, makes sure advances. The extraordinary learning and research by which Sir H. Rawlinson was enabled a few years since to expose a series of mystifications or falsifications relating to the Upper Oxus, which had been received on high geographical authority, can never be forgotten. That river has now been traced from its sources in the Panjab, chiefly by native explorers, and to them we may be said to be indebted for all we know of Nepal, from which Europeans are as jealously excluded as they are from the wildest Central Asian Khanate, although Nepal is not so far from Calcutta as Kingston is from Quebec.

Carrying their instruments to the most remote and inaccessible places, and among the most primitive hill tribes, the narrative reports of the officers of the Indian Survey are full of ethnographic and other curious information. Take for example the account given by Mr. G. A. McGill, in 1882, of the Bishnoies of Rajputana, a class of people, he says, who live by themselves, and are seldom to be found in the same village with the other castes. "These people hold sacred everything animate and inanimate, carrying this belief so far that they never even cut down a green tree; they also do all in their power to prevent others from doing the same, and this is why they live apart from other people, so as not to witness the taking of life. The Bishnoies, unlike the rest of the inhabitants, strictly avoid drink, smoking, and eating opium; this being prohibited to them by their religion. They are also stringently enjoined to monogamy and to the performance of regular ablutions daily. Under all these circumstances, and as may be expected, the Bishnoies are a well-to-do community, but are abhorred by the other people, especially as by their domestic and frugal habits they soon get rich, and are the owners of the best lands in the country."

In one particular the experience of the Indian Survey carries a lesson to this country. "A constantly growing demand," says Gen. Walker, "has risen of late years for new surveys on a large scale, in supersession of the small-scale surveys which were executed a generation or more ago. . . . The so-called topographical surveys of those days were in reality geographical reconnaissances sufficient for all the requirements of the Indian atlas, and for general reproduction on small scales, but not for purposes which demand accurate delineation of minute detail." We have in the Canadian North-West a region which has not yet passed beyond the preliminary stage, and it would probably be possible to save much future expenditure by timely adoption of the more rigorous system. There is perhaps no region on the globe which offers conditions more favourable for geodesy than the long stretch of the western plains, or where the highest problems are more likely to present themselves in relation to the form and density of the earth. The American surveyors have already measured a trigonometrical base of about 1086 miles in the Sacramento Valley, the longest I believe as yet measured in any country (the Yolo Base) and reported to be one of the most accurate.

The President then referred to Australian exploration, the International Polar Expeditions, deep-sea research, and railway extension, and concluded as follows:—



I have now touched lightly upon all the points which appear to me to be most noticeable in the recent progress of geographical science; but before I resume my seat I cannot deny myself the pleasure of alluding to that important measure of social reform, so simple in its application, so scientific in its basis, for which you are indebted to the perseverance and enthusiasm of my friend Mr. Sandford Fleming, C.E. I mean, of course, the agreement to refer local time on this continent to a succession of first meridians, one hour apart. There are many red-letter days in the almanac of less importance than that memorable November 18, 1883, which saw this system adopted, whether we consider its educational tendency or its influence on the future intercourse of unborn millions. It is a somewhat memorable evidence also that agreement upon questions of general concern is not that unattainable thing which we are apt to consider it. The next step will not be long delayed; that is the agreement of the civilised world to use one first meridian—Paris, Ferrol, Washington, Rio de Janeiro, gracefully, as I venture to hope, giving that precedence to Greenwich which is demanded by the fact that an overwhelming proportion of the existing nautical charts of all nations, and of maps and atlases in most of them, already refer their longitudes to that meridian; no other change would be so easy or so little felt.

## SECTION G

## MECHANICAL SCIENCE

OPENING ADDRESS BY SIR F. J. BRAMWELL, F.R.S.,  
V.P. INST. C.E., PRESIDENT OF THE SECTION

In a family of seven children there are two who are of paramount importance: the eldest, at the one end of the scale, important because he is the heir, the first-born; and at the other end of the scale, the little Benjamin, important because he is the last, the youngest, and the dearest. The position of little Benjamin is not, perhaps, quite as honourable as that of the heir, and not, when the family breaks up, by any means as good; but while the family holds together, Benjamin receives an amount of attention and consideration that does not fall to the lot of any one of the intermediates, not even to the heir himself. But there is one risk about Benjamin's position, a risk that cannot appertain to the post of the first-born; little Benjamin may be deposed by the advent of a lesser Benjamin than himself, whereas the first-born becomes (if possible) still more the first-born for each addition to the family. Perhaps some of you may say, Be it so; but what has this to do with the address of the President of Section G? Those who make this inquiry, however, certainly have not present to their minds the change that has this year taken place. Up to and including the Southport meeting, Section G was the little Benjamin among the seven sons of the B.A. (I will not waste your time by giving the name of the Association in full, nor will I affront you by using an abbreviation which is occasionally improperly applied), but at Montreal appears Section H, and G becomes relegated among those uninteresting members of the family who are neither the important head nor the cherished tail. I grieve for Benjamin, and I think the present occasion an apt one for magnifying Section G. Apt for two reasons: the foregoing one, that H has deposed it from its position; the other, that we are meeting in Montreal—and in reference to this latter reason let me ask, Is it not the fact that to the labours of the men who have been, or are (or ought to be) members of Section G is due the possibility of the meeting taking place on this side of the Atlantic?

At our jubilee meeting at York, I called the attention of the Section to the fact that in 1831, when the Association first met in that city, they arrived there laboriously by the stage-coach, and that practically the Manchester and Liverpool, the Stockton and Darlington, and some few others, were the only railways then in existence. I also called their attention to the fact that in 1831 there were but very few steamers. I find the total number registered in the United Kingdom in that year was only 447. If under this condition of things the proposition had been made in 1832 at Oxford, as it was made in 1882 at Southampton, that the next meeting but one of the Association should take place in Montreal, the extreme probability is that the proposer would have been safely lodged in a lunatic asylum for suggesting that that which might have involved a six-weeks' voyage out, and a four-weeks' voyage back, could ever be seriously entertained. Further, to give once more the hackneyed quotation, some few years after this, *i.e.* in 1836, Dr. Lardner established, to his own satisfaction

conclusively, that no vessel could ever steam across the Atlantic, the whole way—a striking instance of the mistakes made by scientific speculation—a branch of science widely differing in the value of its results from those branches which deal with absolute demonstration. Undeterred, however, by such adverse opinion, the engineers "kept on pegging away," experimenting, improving, and progressing, until the scientific speculation was met with the hard fact of the Atlantic voyage steamed the whole way by the *Sirius* and by the *Great Western* in 1838. The impossible was proved to be the possible, and from that day to this the advancement of steam ocean navigation has continued. The six-weeks' voyage, sailing westward, of the year 1831, has become converted into but little over six days. And thus it is that that which would have been a mad proposition in the year 1832 became a perfectly rational one in 1882; and the deliberations of the General Committee on the proposition were not directed as to whether it would be possible to convey the members with certainty, expedition, and economy across the Atlantic, but as to whether it was expedient or not on general grounds to hold for the first time a meeting of the British Association elsewhere than in some city of the United Kingdom. I say again that the possibility of such a meeting is absolutely due to the engineer, and that therefore, on this ground, the present is an appropriate occasion to magnify G, the Mechanical Section of this Association.

It is true that the man who looks only at that which is on the surface may say, "You arrogate too much to yourselves. You ignore (to which I say, Heaven forbid!) the skill and daring of your sailors. You ignore commercial enterprise. You ignore the development of iron and steel manufacture, which have enabled you to build the steamers of the present day. You ignore the increased output of the best steam coal in the world, and you attribute the whole result to the engineer." Such an objector would be in the condition of that man who, in answer to George Stephenson's question, "What is causing that railway train to move?" said, "Why, I suppose the coal that is burning in the locomotive;" and who was met by that grand and comprehensive answer, that it was the "Sun," for the coals were a consequence, and not a first cause. Similarly I venture to say that the mechanical engineer may lay claim to be the central source which has vivified and given rise to the improvements in the manufacture of iron and steel, in the construction of engines, and in the development of our collieries.

There are those I know who object that Section G deals too little with pure science, too much with its applications. It may be, as the members of Section G might retort, that it is possible to attend so much to pure science as to get into the unchecked region of scientific speculation, and that, had the members of Section G been debarred from the application of science, the speculation of Dr. Lardner might to the present day have been accepted as fact.

I have quoted it before, but it has so important a bearing on this point, and comes from a man of such high authority, that I cannot refrain from once more giving you Dr. Tyndall's views on this question:—

"The knowledge of Nature and the progressive mastery over the powers of Nature imply the interaction of two things—namely, thought conceived and thought executed; the conceptions of the brain, and the realisation of those conceptions by the hand. The history of the human intellect hardly furnishes a more striking illustration of this interaction of thought and fact than that furnished by the Association of Physics and Engineering. Take for instance the case of steam. Without knowing its properties, the thought of applying steam could not have arisen, hence the first step was physical examination. But that examination suggested practice, and the steam-engine at last saw the light; thus experimental physics was the seedling from which the steam-engine sprang. But the matter did not end here; the positions of debtor and creditor were soon reversed, for the stupendous operations of the steam-engine forced men of thoughtful philosophic minds to inquire into the origin of the power of steam. Guess succeeded guess, inspiration succeeded inspiration; the ever-present fact of our railways, and our power-looms, and our steamships gave the mind no rest until it had answered the question, How are heat and steam, its instruments, related to mechanical power? Had the works of the engineer not preceded the work of the natural philosopher, this question would never have been asked with the emphasis, nor pursued with the vigour, nor answered with the success, which have attended it. It was the intellectual activity excited by the work which the civil engineers of England had accom-

plished that gave to philosophy the theory of the conservation of energy, including the dynamical theory of heat. . . . The engineering genius of the future is certain to derive from this theory strength and guidance. Thus necessarily has thought originated fact, and fact originated thought. In the development of science these two powers are coequal; each in turn ceasing to be a consequence, and becoming a creative cause. The Atlantic cable also had its small beginnings in the laboratory of the physical inquirer. Here, as before, experimental physics led the way to engineering facts of astounding magnitude and skill. But here also the positions of debtor and creditor have been reversed, for the work of the engineer has caused the physical inquirer to pursue his investigations with a thoroughness and vigour, and has given to those investigations a scope and magnitude, which, without the practical stimulus, would have been impossible. The consequence is that the practical realisation of sending electric messages along the bottom of the Atlantic has been an immense augmentation of our knowledge regarding electricity itself. Thus does the human intelligence oscillate between sound theory and sound practice, gaining by every contact with each an accession of strength. These two things are the soul and body of science. Sever sound theory from sound practice, and both die of atrophy. The one becomes a ghost and the other becomes a corpse."

I think all men, even although they be followers of science in its purest and most abstract form, must agree that these words are words of sound sense, well worthy of being borne in mind and of being acted on, and will, therefore, concur in the propriety of Section G dealing with engineering subjects generally as well as with abstract mechanical science. Once admitting this, I may ask—certain what the answer must be—whether there is any body of men who more appreciate and make greater use of the applications of pure science than do the members of this Section. Surely every one must agree that we engineers are those who make the greatest practical use not only of the science of mechanics but of the researches and discoveries of the members of the other Sections of this Association.

Section A, *Mathematical and Physical Science*. The connection between this Section and Section G is most intimate. With any ordinary man I should have referred, in proof of this intimate connection, to the fact that the President of A this year is a member of the Council of the Institution of Civil Engineers, but when I remind you that it is Sir William Thomson who fills this double office, you will see that no deduction such as I have hinted at can be drawn from its dual functions, because the remarkable extent and veracity of his attainments qualify him for so many offices, that he mere fact of his holding some one double position is no certain evidence of the intimate connection between the two. But setting aside this fact of the occupancy of the chair of A by a civil engineer, let us remember that the accomplished engineer of the present day must be one well grounded in thermal science, a electrical science, and for some branches of the profession in the sciences relating to the production of light, in optical science, and in acoustics; while, in other branches, meteorological science, photometrical science, and tidal laws are all-important. Without a knowledge of thermal laws, the engineer engaged in the construction of heat-motors, whether they be the steam-engine, the gas-engine, or the hot-air engine, or engines depending upon the expansion and contraction under changes of temperature of fluids or of solids, will find himself groping in the dark; he will not even understand the value of his own experiments, and therefore will be unable to deduce laws from them; and if he makes any progress at all, it will not guide him with certainty to further development, and it may be that he will waste time and money in the endeavour to obtain results which a knowledge of thermal science would have shown him were impossible. Furnished, however, with this knowledge, the engineer, starting with the mechanical equivalent of heat, knowing the utmost that is to be attained, and starting with the knowledge of the calorific effect of different fuels, is enabled to compare the results that he obtains with the maximum, and to ascertain how far the one falls short of the other; he sees even at the present day that the difference is deplorably large, but he further sees in the case of the steam-engine, that which the pure scientist would not so readily appreciate, and that is, how a great part of this loss is due to the inability of materials to resist temperature and pressure beyond certain comparatively low limits; and he thus perceives that unless some hitherto wholly unsuspected, and apparently impossible, improvement in these respects should be made,

practically speaking the maximum of useful effect must be far below that which pure science would say was possible. Nevertheless, he knows that within the practical limits great improvements can be made; he can draw up a debtor and creditor account, as Dr. Russell and myself have done, and as has been done by Mr. William Anderson, the engineer, in the admirable lecture he gave at the Institution of Civil Engineers in December last, on "The Generation of Steam and the Thermodynamic Principles involved." Furnished with such an account the engineer is able to say, in the language of commerce, I am debtor to the fuel for so many heat-units, how, on the credit side of my account, do I discharge that debt? Usefully I have done so much work, converted that much heat into energy. Uselessly I have raised the air needed for combustion from the temperature of the atmosphere to that of the gases escaping by the chimney; and he sets himself to consider whether some portion of the heat cannot be abstracted from these gases and be transmitted to the incoming air. As was first pointed out by Mr. Anderson, he will have to say a portion of the heat has been converted into energy in displacing the atmosphere, and that, so far as the gaseous products of the coal are concerned, must, I fear, be put up with. He will say, I have allowed more air than was needed for combustion to pass through the fuel, and I did it to prevent another source of loss—the waste which occurs when the combustion is imperfect; and he will begin to direct his attention to the use of gaseous or of liquid fuel, or of solid fuel reduced to fine dust, as by Crampton's process, as in these conditions the supply may be made continuous and uniform, and the introduction of air may be easily regulated with the greatest nicety. He will say, I am obliged to put among my credits—loss of heat by convection and radiation, loss by carrying particles of water over with the steam, loss by condensation within the cylinder, loss by strangulation in valves and passages, loss by excessive friction or by leakage; and he will as steadily apply himself to the extinction or the diminution of all such causes of loss as a prudent Chancellor of the Exchequer would watch and cut down every unproductive and unnecessary expenditure. It is due to the guidance of such considerations as these that the scientific engineer has been enabled to bring down the consumption of fuel in the steam-engine, even in marine engines such as those which propelled the ship that brought us here, to less than one-half of that which it was but a few years back. It is true that the daily consumption may not have been reduced, that it may be even greater, but if so it arises from this, that the travelling public will have high speed, and at present the engineer, in his capacity of naval architect, has not seen how—notwithstanding the great improvements that have been made in the forms of vessels—to obtain high speed without a large expenditure of power. I anticipate, from the application of thermal science to practical engineering, that great results are before us in those heat-motors, such as the gas-engine, where the heat is developed in the engine itself. Passing away from heat-motors, and considering heat as applied to metallurgy, from the time of the hot blast to the regenerative furnace, it is due to the application of science by the engineer that the economy of the hot blast was originated, and that it has been developed by the labours of Lowthian Bell, Cowper, and Cochrane. Equally due to this application are the results obtained in the regenerative furnace, in the dust furnace of Crampton, and in the employment of liquid fuel, and also in operations connected with the rarer metals, the oxygen furnace, and the atmospheric gas furnace, and, in its incipient stage, the electrical furnace. To a right knowledge of the laws of heat and to their application by the engineer, must be attributed the success that has attended the air-refrigerating machines, by the aid of which fresh meat is, at the end of a long voyage, delivered in a perfect condition; and to this application we owe the economic distillation of sea-water by repeated ebullitions and condensations at successively decreasing temperatures, thus converting the brine that caused the Ancient Mariner to exclaim, "Water, water everywhere, nor any drop to drink," into the purest of potable waters, and thereby rendering the sailor independent of fresh-water storage.

With respect to the application by the engineer of electrical science, it is within the present generation that electricity has passed from the state of a somewhat neglected scientific abstraction into practical use: first, by the establishment of the land telegraph, then by the development into the submarine cable, by means of which any one of us visitors here in Canada may be in instant communication with his own country, and may be so without a selfish exclusive occupation of the cable, for once more the application of science has solved that apparently impossible

problem of employing a single wire to be at one and the same time the transmitter of multiple electric messages, and messages in opposite directions. Then, thanks to the application of Faraday's great discovery of induced electricity, there has been, during the last quarter of a century, the progressive development of the dynamo machine, whereby the energy of ordinary motors, such as steam-engines, is converted into electrical energy, competent to deposit metals, to (as has already been said) fuse them, to light not only isolated buildings but extensive areas of towns and cities, and to transmit power to a distance, whether for manufacturing purposes or for the railway or tramcar; and thus the miracle is performed of converting a waterfall into a source of light, as at Sir William Armstrong's house, or into the origin of power for a railway, as at the Giant's Causeway. To the application of electrical science is due the self-exciting of the dynamos and the construction of secondary batteries, enabling a development of electricity to be continued for many hours. In the United Kingdom general electric lighting, that is to say, the lighting of large sections of a town from a central station, has been stopped by the most unwise, because most unjust, conditions imposed by the Government General Electric Lighting Act of 1882. A new and meritorious industry, which should have been granted the same privileges as are accorded to other industrial undertakings needing Parliamentary powers, was subjected to this most unjust condition: that at the end of twenty-one years the public authority of the town or place lighted should have the option of buying the undertaking for the then value of the mere materials, and that, if the authority did not choose to purchase (for it was not bound to buy), at every subsequent five-year period this option should re-arise; that is to say, that a new undertaking, which would require years for its general acceptance (for the public is slow to take up a novelty), was, after the experimental and non-paying stage had been passed, to be practically forthwith taken away for a mere fraction of the capital that had been outlaid if the undertaking paid, but was not to be taken away if it did not pay. Such, in spite of the teaching of Section F, is the condition to which our Government has arrived in respect of economic science. The next electrical matter I have to touch upon, that of the telephone and microphone, with which will for ever be associated the names of Graham-Bell, Edison, and Hughes, has, as regards the public use of the telephone, been all but similarly treated in the United Kingdom. It has been declared to be within the telegraphic monopoly given by Parliament to the Post Office nine years before the telephone was invented, and the power to use it depends entirely upon the grace and favour of the Post Office, a grace and favour not always accorded; and even when accorded, coupled with limitations as to distance, and coupled with a condition of payment of 10 per cent. of the gross receipts by the companies to the Post Office as a royalty; and all this because Government has become a trader in electrical intelligence, and fears the competition of the telephone with its telegraphs.

No one in the ship-loving countries of England, Canada, and the United States can refrain from feeling the warmest interest in all connected with navigation, and we know how frequently, alas! the prosperous voyage across the wide and fathomless ocean ends in shipwreck and disaster when the wished-for shore is approached, and when the sea is comparatively shallow. Except for the chance of collision, there is in a staunch ship little danger in the open ocean, but on nearing the shore, not only is the liability to collision increased, but shoals and sunken rocks render navigation perilous, and it is on the excellence of the lighthouses and lightships that (coupled with soundings) the sailor relies. These structures and appliances are confided to the engineer, and to be efficient they require him to be able to apply the teachings of Section A in optical science, and in the case of fogs, or as regards buoys at night-time, the science of sound. I parenthetically alluded to soundings as one (indeed a principal one) of the safeguards of ships when approaching shore. It is important in these days of high speed that these should be made with ease and without the necessity of stopping the ship, or even of diminishing its velocity. Sir William Thomson, by the application of the science of pneumatics, has enabled this to be done. Again, most important is it that the compass, amidst all the difficulties attendant upon its being situated on an iron or steel structure, should be trustworthy. And here Sir William has applied the science of magnetism in his improved compass to the practical purposes of navigation.

To go to another important branch of engineering—water-supply. The engineer dealing with a district to be fed from the surface will find himself very deficient if he have not the power

of applying the science of meteorology to the work that he has in hand; he must know, not the average rainfall, for that is of but little use to him, but the maximum, and, most important of all, the minimum, rainfall over a consecutive period of years: the maximum, so that he may provide sufficient channels and by-washes for floods; the minimum, so as to provide sufficient storage. He must know what are the losses by evaporation, what are the chances of frost interfering with his filters and with his distributive plant.

Coming to the mathematical side of Section A—whether we consider the naval architect preparing his design of a vessel to cleave the waves with the least resistance at the highest speed, or whether we consider the unparalleled series of experiments of that most able Associate of Naval Architects, the late William Froude, carried out as they were by means of models which were admirable in their material, their mode of manufacture with absolute accuracy to the desired shape, and their mode of traction and of record, we must see that both architect and experimenter should be able to apply mathematical science to their work, and that it is in the highest degree desirable that they should possess, as Froude did, those most excellent gifts, science and practical knowledge.

Again, the mathematical side of Section A has to be applied by engineers when considering the strength and proportion of boilers, ships, bridges, girders, viaducts, retaining walls, and in short the whole of the work with which an engineer is intrusted. Notable instances of great bridges will occur to all our minds, especially meeting as we are in this continent of grand streams, Fads' St. Louis Bridge, Roebing's Niagara Bridge, and his and his sons' East River Bridge, Gzowski's International Bridge, and, going back to our own land, Fowler and Baker's Bridge over the Forth.

Passing from Section A to Section B, there is evidently so much overlapping of these Sections that a good deal that I have said in reference to Section A might properly have been reserved for Section B. The preparation from the ore of the various metals is in truth a branch of engineering; but to enable this to be accomplished with certainty, with economy, involving the not throwing away of that which is called the waste product but which is frequently a valuable material, it is essential that the engineer and the chemist should either be combined in one and the same person, or should go hand in hand. In the manufacture of pig iron it is absolutely necessary that the chemical constituents of the ore, the fuel, and the flux should be thoroughly understood, and that the excellence of the process followed should be tested by an analysis of the slag. For want of this chemical knowledge, thousands upon thousands of tons of bad pig iron have been made, and thousands upon thousands of tons were formerly left in the issuing slag. Similar remarks apply to the production of lead and of copper from the ores, and still more do they apply to that great metallurgical manufacture of the last few years—"steel." In the outset steel was distrusted, because of the uncertainty of its behaviour, but the application of chemical science now enables the manufacturer to produce with precision the material required to fulfil the physical tests imposed by the engineer.

Reverting to the water engineer, the chemist and the microscopist have their sciences applied to ascertain the purity of the intended source, and, as in the case of Clarke's beautiful process, by the application of chemistry, water owing its hardness to that common cause, carbonate of lime, is rendered as soft as the water from the mountain lake. Taking that other branch of engineering commonly coupled with water, viz. the supply of gas, the engineer is helpless without the application of chemistry. From the examination of the coal to be used to the testing of the gas to be supplied, there is not one stage where chemical science is not necessary. The consumer requires gas which shall be as nearly as possible a pure hydrocarbon of high illuminating power, and it might well have been that a person to whom was delivered the crude gas as it issued from the retort would have said, "Certain things may be separated out more or less, but to practise on a wholesale scale the delicate operations which will be needed to cleanse the illuminating gas from its multifarious accompanying impurities is a hopeless undertaking, and must be so, if for no other reason than this—the excessive cost that would be entailed." But what are the facts? Although I for one do not like to sit in a room where gas is burnt, unless special provision is made for taking away the products of combustion, the engineer of the present day, thanks to the application of chemical science, delivers gas to the consumer in a state of comparative purity (although it may have been made from impure

coal) which but a few years ago would have been deemed impossible; and so far is this improvement from being attended with extra cost, that the residual products not now uncommonly all but pay the whole cost of the coal, and in some rare instances even leave a slight profit to go towards the charge of labour. Again, it is by the application of chemical science in the dynamite and the gun-cotton of the present day that the engineer is enabled to prepare submarine foundations, to blast away shoals, and to drive tunnels through rock of a character that cannot be dealt with by mere cutting machines. Equally to the application of chemistry is it due that there are hopes, by the employment of lime cartridges, of breaking down coal without that risk of igniting fire-damp which is attendant upon the use of gunpowder. I need hardly observe that much more might most pertinently be said on the way in which the engineer applies chemical science. In fact, those ways are so multifarious that a volume might be written upon them, but I must pass on and ask you to consider how the engineer applies geological science, the science treated by Section C.

I have already spoken of the engineer supplying towns by water collected from the surface; even he, however, must have a knowledge of geology, for without it he will not know what places are apt for the huge reservoirs he constructs, nor where he can in safety make his enormous embankments. In this continent of vast lakes one feels it must excite a sensation of the ridiculous when a "Welsh lake" is spoken of, but I must ask you to believe you are in Lilliput, and to imagine that the "Bala Pond" of 1100 acres in extent, is really "Bala Lake," as it is called. Within a few miles of that, our friends at the other end of the Atlantic steam ferry, the inhabitants of Liverpool, are now constructing under the engineering and advice of Mr. Hawksley, a waterworks which will involve the formation, I believe one may say the re-formation, of a lake, practically the same area as that of Bala, of some 80 feet in depth, and containing between the overflow and the point of lowest discharge nearly twelve thousand million gallons. This lake will be made by the throwing from side to side of the valley of a solid stone bank, 100 feet above the ground, 140 feet above the deepest part of the foundations, and 113 feet thick at its thickest part. Contrasted with Lake Superior this new lake will be small, a thing demanding a microscope even, but the bursting of the wall would liberate a body of water sufficient to carry death and ruin throughout a considerable district. It is, therefore, in the highest degree important that whether he be constructing the solid stone wall, or the more common earthen embankment with a puddle trench, the engineer should so apply geological science as to insure the safety of his work. But in those cases where the waterworks engineer has to derive the supply from underground sources, the application of this science is still more necessary; he must know whether he is likely to find a water-bearing stratification at all—if so, where it receives the rain from heaven, and the extent of the area which receives it; in what direction the water travels through it, what is the varying height of water in the different parts of the stratification giving the "head" to produce that travel; how far this height is likely to be affected by the pumping of the desired quantity; whether, if near the outflow into the sea, the pumping is likely to reverse the direction of the current, and to bring back brackish water, and whether the rocks are of such a character as to be liable to yield a water impregnated with iron or with lime, and whether these water-bearing rocks are accessible from the surface without the execution of costly and laborious work in passing through overlying stratifications of an unfit or it may be even of a dangerous character. It need hardly be said that the engineer when engaged in metalliferous mining, or in the extraction of coal or of petroleum, unless he applies the science of Section C, is but a haphazard explorer whose work is more likely to end in disaster than in success. Again, the engineer, when laying out a railway, has to consider the geological features of the country in determining the angles of his cuttings, and to determine where it becomes more economical to tunnel than to cut. Indeed, without the application of that science to engineering there are some enterprises on the feasibility of which the engineer would not be able to pronounce an opinion—a notable instance, the Channel Tunnel. The engineers, of whom I am one, said there is a material, the compact non-water-bearing grey chalk, which we have at a convenient depth on the English side and, is of all materials the most suitable; if that exist the whole way across, success is certain. Then came geological science, and that told the engineer that in France the same material existed; that it ex-

isted in the same position in relation to other stratifications as it existed in England; that the line of outcrop of the gault lying below it had been checked across; and that taken together these indications enabled a confident opinion to be expressed that it was all but certain this grey chalk stratification did prevail from side to side. The engineers believed it, an intelligent section of the public believed it, and came forward with their money; large sums were expended in England and in France on the faith of the repeated declaration of the English Government (of both sides of politics), that so long as the nation was not called on to contribute towards the cost of the work, it would hail with satisfaction the improved means of communication between England and the Continent; the experimental works were carried on from both sides with the happiest results, and then, when success appeared certain, the whole work was stopped by the incredible suggestion that in the event of a war the soldiers of England, and the science of England, could not defend a couple of rat-holes, holes 14 feet in diameter and 20 miles long, situated far below the surface of the sea, having a rapid dip from the shore to a low point, gradually rising from there to the centre of the length of the tunnel, so that the English end could be flooded with sea-water in twenty-five minutes up to the soffit of the arch at the dip; and in consequence of this incredible and much-to-be-ashamed-of scare it is due that one of the finest instances of civil engineering work in connection with the science of geology, and as I believe one of the most useful works that has ever been proposed, has been put a stop to.

To come to Section D, the botanical side of it is interesting to the engineer as instructing him in the locality and quality of the various woods that he occasionally uses in his work. With regard to that most important part of the work of D, which relates to "germs" and their influence upon health, the engineer deals with it thus far: he bears in mind that the water-supply must be pure, and that the building must be ventilated, and that excreta must be removed without causing contamination; thus the waterworks engineer, the warming and ventilating engineer, and the sewage engineer can (and do) all of them profit by the labours of Section D, and can by their works assist in giving practical value to the pure science of that section.

Section E, *Geography*. Probably in these days, when our kingdom at home and the old countries near us are all but full of the works of the engineer, there are few who take a greater interest in geography than he does, and I am quite sure there are none who make a more useful application of geographical knowledge for the benefit of mankind at large than does the engineer. Almost at the outset of this address I claimed to magnify Section G, on the ground that without the aid of its members we should not have had that practical lesson in geography which we have received by our visit here, a lesson that no doubt will be continued and amplified by many of us before we return to our homes. Whether it be by the ocean steamer or by the railway train, the enterprising geographical explorer is carried to or through countries which now, thanks to the engineer, are well known and settled, up to the beginning of the unknown and not settled; and thus his labours are lightened, he consumes his energies only upon his true work, brings back his report, which is, as I have said, studied by the engineer with a view to still further development, and thus, turn by turn, the geographer and the engineer carry civilisation over the face of the world.

Now to come to Section F, which treats of Economic Science. The matters with which this Section deals—birth-rate, death-rate, the increase or the diminution of populations, the development of particular industries in different localities, the varying rates of wages, the extent and nature of taxation, the cost of production, the cost of transport, the statistics of railway and of marine disasters, the consumption of fuel, and many matters which come within the purview of F, are of importance to the engineer. Guided by the information given him by the labours of this Section, he comes to the conclusion that a work having a particular object in view should or should not be undertaken. With the information derived from the past he judges of the future; he sees what provision should be made for prospective increase of population or of industries; he sees the chances of the commercial success of an undertaking or of its failure, and he advises accordingly.

I do not propose to say anything about Section H, for I have dealt with it as being still included within D.

I trust I have now established the proposition with which I set out, viz. that not only is Section G the Section of Mechanical Science, but it is emphatically the Section of all others that applies in engineering to the uses of man the several sciences

appertaining to the other Sections: an application most important in the progress of the world, and an application not to be lightly regarded, even by the strictest votaries of pure science, for it would be vain to hope that pure science would continue to be pursued if from time to time its discoveries were not brought into practical use.

Under ordinary circumstances I should have closed my address at this point, but there is a subject which at this, the first meeting of Section G after the meeting at Southport, must be touched upon. It is one of so sad a character that I have avoided all allusion to it until this the very last moment, but now I am compelled to grapple with it.

In the course of this address I have had occasion to mention several names of eminent men, many of them happily still with us, some of them passed away; but I doubt not you have been struck by the absence of one name, which of all others demands mention when considering physical science, and still more does it come vividly before us when considering the application of science to industrial purposes. I am sure I need not tell you that this name, which I can hardly trust myself to speak, is that of our dear friend William Siemens, whose contributions to science, and whose ability in the application of science, have for years enriched the transactions of this Section, and of Sections A and B, for in him were combined the mechanic, the physicist, and the chemist.

But a brief year has elapsed since he quitted the Presidential chair of the Association, and, with us at Southport, was taking his accustomed part in the work of this and of other Sections, apparently in good health, and with a reasonable prospect of being further useful to science for many valuable years to come. But it was not to be; he is lost to us, and in losing him we are deprived of a man whose electrical work has been second to none, whose thermic work has been second to none, and whose enlarged views justified him in embarking in scientific speculations of the grandest and most profound character. Whether or not his theory of the conservation of the energy of the sun shall prove to be correct, it cannot be denied that it was a bold and original conception, and one thoroughly well reasoned out from first to last.

I feel that, were I to attempt anything like the barest summary of his discoveries and inventions, I should set myself a task which could not have been fulfilled had I devoted the whole of the time I had at my command to the purpose. I had indeed thought of making his work the subject of my address, but I felt that his loss was so recent that I could not trust myself to attempt it. There is no need for me to dwell further upon this most painful topic. He was known to you all, he was honoured and loved by you all, and by every member of this Association he had so faithfully served, and over which he had so ably presided; and he enjoyed the respect and esteem of the best intelligence of England, the land of his adoption; of the Continent, his birthplace; and of Canada, and of the United States, whose populations are always ready to appreciate scientific talent and the resulting industrial progress. It is not too much to say that few more gifted men have ever lived, and that with all his ability and talent he combined a simplicity, a modesty, and an affectionate disposition that endeared him to all.

I am sorry to conclude my address to you in this mournful strain. I have endeavoured to confine my allusions to our dear friend within the narrowest limits, but if I have overstepped these I trust you will forgive me, remembering that "out of the fulness of the heart the mouth speaketh."

### NOTES

WE announce with great regret the death, yesterday, at the age of eighty-three years, of Mr. George Bentham, F.R.S., F.L.S., the eminent botanist.

THE Committee which has been formed for the erection of a statue to the late Jean Baptiste Dumas at his native town, Alais (Gard), is an extensive one. The president is M. Pasteur, and the vice-presidents MM. J. Bertrand, F. de Lesscps, and Cauvet. The members of the Committee include all the names of scientific note in France. Among the foreign members are well-known men of all nationalities; the English members being Sir William Thomson, Dr. W. De La Rue, Prof. Williamson, and Dr. Frankland. There is besides a local Committee at Alais. With such powerful and wide support the monument is sure to be

worthy of Dumas' reputation. Subscriptions should be sent to M. E. Maindrin, Palais de l'Institut de France, Paris.

THE National Electrical Conference, convened by the U.S. Congress in connection with the Electrical Exhibition, began its sessions in Philadelphia on Monday. Addresses were made by the President of the Conference, Prof. Rowland of the Johns Hopkins University, Baltimore; also by Sir William Thomson, the Vice-President. The practical work of the Conference began on Tuesday afternoon with a discussion on the work of the United States Signal Office in relation to electrical observation. The Conference will hereafter discuss the necessity for a national bureau of electrical standards, the adoption of an international system of electrical units, and the theory of dynamo-electric machines. Prof. George Forbes of London delivered a lecture on dynamo-electric machinery on Tuesday evening.

THE Iron and Steel Institute holds its annual meeting this year at Chester on September 23 and three following days. Among the papers and subjects for discussion are the following:—On the geology of Cheshire, by Mr. Aubrey Strahan, of H.M. Geological Survey, London; on improvements in the Siemens regenerative gas furnace, by Mr. Frederick Siemens, C.E., London; on recent improvements in the method of the manufacture of open-hearth steel, by Mr. James Riley, Glasgow, Member of Council; on a new form of regenerative furnace, by Mr. F. W. Dick, Glasgow; on the manufacture of crucible steel, by Mr. Henry Seebohm, Sheffield; on the recovery of by-products from coal, more especially in connection with the coking and iron industries, by Mr. Watson Smith, Owens College, Manchester; on the most recent results obtained in Germany in utilising the by-products from Otto and other coke ovens, by Dr. C. Otto, Dalhausen; on the North-Eastern Steel Company's Works at Middlesbrough, and their products, by Mr. Arthur Cooper, Middlesbrough; on the spectroscopic examination of the vapours evolved on heating iron, &c., at atmospheric pressure, by Mr. John Parry, Ebbw Vale.

THE museum recently opened at Newcastle-on-Tyne by the Prince of Wales is a very fine building indeed, and of course is quite unconnected with the public library. The building contains the collections of the well-known Natural History Society of Northumberland, Durham, and Newcastle-on-Tyne, and will cost 42,000*l.* Of this 38,000*l.* have been raised by public subscription.

THE preliminary programme of the Central Institution for Technical Education has been issued. The object of the Central Institution, it states, is to give to London a College for the higher technical education, in which advanced instruction shall be provided in those kinds of knowledge which bear upon the different branches of industry, whether manufactures or arts. The Institution is intended to afford practical scientific and artistic instruction which shall qualify persons to become (1) technical teachers; (2) mechanical, civil, electrical, chemical, and sanitary engineers, architects, builders, and decorative artists; (3) principals, superintendents, and managers of manufacturing works. The main purpose of the instruction to be given in this Institution will be to point out the application of different branches of science to various manufacturing industries; and in this respect the teaching will differ from that given in the Universities and in other institutions in which science is taught rather for its own sake than with the view to its industrial application. The courses of instruction will be arranged to suit the requirements of (1) persons who are training to become technical teachers; (2) persons who are preparing to enter some industrial or professional career; (3) persons who desire to attend special courses, with the view of acquainting themselves with the scientific principles underlying their work. Students intending to go through the complete course of technical instruction with the view of subse-

quently obtaining a diploma, will be required to pass an entrance or matriculation examination, which will include mathematics, pure and applied, chemistry, physics, drawing, and French or German. On the results of the examination the following scholarships will be awarded to students who are prepared to attend the complete course of instruction in any one department, provided that the merits and circumstances of the candidate justify the Committee in making the award:—(1) The Cloth-workers' Scholarship of 60*l.* a year, tenable for two years and renewable for a third year, entitling the successful candidate to free education. (2) The Siemens Scholarship of 50*l.* a year for three years, founded by Lady Siemens in memory of her husband, the late Sir William Siemens, LL.D., F.R.S. This Scholarship will be competed for in October 1885. (3) The Royal Albany Scholarship of 50*l.* a year for three years, founded by the Corporation of London in memory of the late Prince Leopold, Duke of Albany. (4) Two Mitchell Scholarships of 30*l.* a year for two years, one with and one without free education, to be awarded to candidates who have attended a public elementary school within the City of London, or whose parents are or have been resident or engaged in some trade or occupation within the City of London. The Siemens Medal, founded by Lady Siemens in memory of her husband, the late Sir William Siemens, LL.D., F.R.S., will be annually awarded to the student of greatest merit in the department of electrical engineering. The professors in charge of the several departments are:—Chemistry, Prof. H. E. Armstrong, Ph.D., F.R.S.; Engineering, Prof. W. C. Unwin, B.Sc., M.Inst.C.E.; Mechanics and Mathematics, Prof. O. Henrici, Ph.D., F.R.S. Physics, Prof. W. E. Ayrton, F.R.S., A.M.Inst.C.E.

THE Paris *Journal Officiel* announces the formation of a Commission to investigate all matters connected with mines and mining in Tonquin and Annam. It is composed of various officials of experience in Indo-China, and their instructions are to draw up the programme of work to be executed by the mining party which is about to be sent out from France, and to draw up a draft agreement regulating the management and working of mines in conformity with the treaty of June last with Annam.

A SUBJECT which, according to the *Japan Mail*, is engaging the attention of native scientific men in Japan is the method of translating or transferring into Japanese the technical terms of European science. Hitherto Chinese words and characters have been employed for this purpose; in many cases the translations existed, in Chinese, and were simply adopted by the Japanese—such as the equivalents for telegraph and railway appliances, but in the great majority of cases a process of manufacture had to be resorted to. Given the sound of the technical term and its meaning, the problem was to find among existing Chinese characters one, two, or three, which suited one or other of these best; and thus a new word was formed. The scientific journal of Tokio attacks this system, saying that, whatever may be said on the score of the unity and adaptability of Chinese in transcribing technical terms, the clumsy and complex graphic system renders it unsuitable for youthful students, as the difficulty of committing to memory so many hundreds or thousands of arbitrary characters is still greater than the pursuit of a scientific or technical course of study. Prof. Yatabe, of the Tokio University, lays special stress on the use of the original foreign technical terms, instead of translating them into Chinese. In a lecture on the subject, this gentleman told the pupils of a normal school near Tokio that, in order to comprehend the scientific achievements of Europe, it was necessary to be conversant with one or more European languages, for, seen through the medium of the Chinese tongue, science lost much of its simplicity, and was at best but clumsily reproduced. Another native Professor of the University argued in a similar strain.

The knowledge of some European language was, he said, essential, not only on account of the closer relations now existing between Japan and the West, but also because the study of the technical sciences would thereby be made materially easier than at present. Whatever might be the use of Chinese as a philosophical language, it was certainly most unsatisfactory as a vehicle for the reproduction of Western sciences.

M. F. A. FOREL communicates to the *Journal Suisse* an interesting account of the discovery of the relics of the "Hôtel des Neuchâtelois," an extemporised fastness on the glacier of the Lower Aar, occupied by Agassiz and his scientific friends from 1840 to 1843, while they were investigating the theory of glaciers and the Glacial period in the immediate vicinity of glaciers. Herr Ritter, from Leipzig, recently on a tour through the region of the Unteraar, found there a block of stone bearing the names of Stengel, Otz, and Martins, with the dates 1844 and 1845. In 1840 Agassiz and his friends, coming across an enormous block of micaceous schist, supported by other rocks, and forming a natural shelter, on the median moraine of the glacier, at the junction of the Lauteraar and Finsteraar, proceeded to complete the cabin thus prepared for them by running up some walls of dry stones. In his "Excursions et Séjours dans les Alpes," Desor gives a lively picture of the enthusiastic scientific life led by Agassiz and his zealous fellow-students of Nature in that simple yet elevated hall of science to which they gave the name of Hôtel des Neuchâtelois during the three years 1840 to 1843. The block, naturally friable, showed, as early as 1841, numerous fissures, and in 1844 split into two pieces. Since then the frost has rent it up into a heap of debris, and it is three pieces of this which have just been identified. They are a blackish micaceous schist of very fine grain. The piece highest situated bears several inscriptions of the colour of minium, but these are mostly illegible, and M. Forel could only make out "1848" thrice repeated, and "Vogt," the present Professor at Geneva; 23 m. lower down is the stone discovered by Herr Ritter, bearing in very legible capitals the inscriptions "STENGEI." (student of engineering under Osterwald), "1844"; "OTZ" (Engineer at Neuchâtel), "1845"; "CH. MARTINS" (Professor at Montpelier), with other letters which are indecipherable. There is also to be read on it "No. 2," a mark which confirms M. Forel's conclusion as to the connection of the stone with the Hotel, Agassiz having caused certain stones to be distinguished by certain numbers, and their position to be taken by Engineer Wild, the block of the Hôtel der Neuchâtel being distinguished by the number "2"; 55 m. lower still is the third stone with the inscription: "SOLLIOZ AUGUSTE, 1842; LIEUTENANT GUNTREN," and a few more words hardly comprehensible. These three blocks are now no longer, as in 1840, at the summit of the moraine, but have been slipping down the incline on the side of the Lauteraar, which merges in the glacial ravine, watered by a beautiful stream. Comparing the position of the Hôtel des Neuchâtelois, as given by Agassiz (797 m. from the promontory of Abschwung), and as seen in Wild and Stengel's beautiful map of the glacier on the scale of 1 : 10,000, with the position which it now occupies, M. Forel calculates that the block must have glided a distance of 2400 m. from 1840 to 1884, or 55 m. a year. For the easier identification of the three blocks of stone by later explorers, M. Forel has inscribed on them, in fresh red colour, his own name and that of Herr Ritter, with the date 1884.

THE Institution of Civil Engineers send us the lengthy and valuable memoir of the late Sir William Siemens, presented to the Institution by Dr. William Pole. After a few words on the incidents of his life, Dr. Pole abandons any attempt at chronological arrangement as impossible because of Sir William Siemens' 'extraordinary faculty of devoting his attention to many different

lines of thought, and many different subjects of investigation, at one and the same period"; and accordingly his labours are classified under these heads:—(1) Heat and its applications, particularly to metallurgy; (2) Electrical science and practice; and (3) Miscellaneous engineering, mechanical, and scientific matters not included under the former heads. Dr. Pole then goes over the whole of Sir William Siemens's scientific labours in these fields, and, as might have been expected, produces the fullest and most valuable memoir of this distinguished member of "the creators of the age of steel" which has yet appeared.

THE "Year-Book of the Scientific and Learned Societies of Great Britain and Ireland," published by Messrs. Griffin and Co., will be found useful, and doubtless will be improved from year to year. The societies are arranged in fourteen sections, according to the field they occupy, with a fifteenth section, including some of the leading foreign societies. The compilers might certainly have avoided putting the Royal Society and the Royal Institution side by side, as if they had anything in common.

MR. W. M. MASKELL, F.R.M.S., continues his notes on the *Coccide* of New Zealand, and has sent us a lengthy continuation of his former papers, extracted from the *Transactions of the New Zealand Institute*, vol. xvi. That country seems to be especially rich in "scale-insects," and in Mr. Maskell they find an able student of their modes of life and characteristics. Especially curious is the species described as *Rhizococcus fossor*, the female of which does not cover herself with a sac or "scale," but sinks herself bodily in a circular pit in the substance of the leaf, and there lays her eggs; the species feeds on *Santolium cunninghamii* in the North Island. *Iconya parchasi*—a near relative of the "pou à poche blanche" (*I. sacchari*), so destructive in Mauritius, and which has probably been introduced into Queensland and elsewhere—seems to be spreading rapidly, and to be doing much damage, not only to cultivated trees and shrubs, but also to the native forests. Before carrying into effect the radical remedy of cutting down and destroying the infected trees, we would recommend Mr. Maskell to try an application of kerosene, which has certainly proved useful in the case of *Coccide* on oranges in America. The weak point of these papers consists in the extreme roughness of the plates; they may be characteristic so far as they go, but a few coarse scratches scarcely sufficiently represent hairs, neither does an open network of crossed lines indicate a solid and probably concave surface.

THE *Kavkaz* newspaper mentions a bolide that was seen on August 3 at Kazakh, in the district of Elizabethpol. It had the shape of a blue globe which broke into two globes of the same colour, and disappeared in the direction of the Caucasus Chain.

WE regret to learn of the death at Montreal, from typhoid fever, of Mr. Walter R. Browne, well known as a writer on the scientific aspects of engineering. Mr. Browne had gone to Montreal to attend the British Association meeting.

THE dangers to public health which lurk in out-of-the-way places appear inexhaustible. This time the danger comes from the matter which collects on coins which have been a long time in circulation, and to which we have already referred. M. Reinsch of Erlangen has devoted much study to this matter, and has investigated old and recent coins of all metals from all the European States. Everywhere he has found micro-organisms of Algae and Bacteria. Scraping away the matter which accumulates in the interstices of the relief with a needle, and placing it in a drop of distilled water under a microscope of 250 to 300 diameters, he found fragments of textile fibres, numerous starchy granules, especially of the starch of wheat, globules of grease, some unicellular Algae, &c. But when a microscope of greater power was used Bacteria were found among this detritus. There

were long Bacteria with a vibratory or spiral movement, as well as those of a globular shape. Sometimes both forms were found on one coin; but as a rule each form was found separately. When a little glycerine or iodine was introduced into the preparation these ceased their movements. Among the Algae two kinds were of most frequent occurrence, viz. a small *Chroococcus* and a small unicellular one resembling the *Palmellis*. They were collected in little spherical colonies of four, eight, or a dozen at a time, and were found only on old coins; recent ones contained only the Bacteria. A recent writer in *Science et Nature* refers to this discovery as of great importance from a hygienic point of view.

AT numerous places in Lower Austria several shocks of earthquake were felt on Tuesday last week. The duration of the shocks was from four to nine seconds each.

AT the last meeting of the Seismological Society of Japan, a paper (which is printed in the *Japan Gazette*) was read by Mr. E. Kuipping on the meteorology of Japan. It was based on data obtained from twenty-three meteorological stations in Japan during the year 1883, the extreme positions being Kagoshima and Nagasaki in the south, and Sapporo and Nemoro in Yezo in the north. Interesting comparisons are instituted between the variations in temperature and pressure at different times of the year and in different parts of Japan, and similar variations in Europe.

THE additions to the Zoological Society's Gardens during the past week include two Ring-tailed Lemurs (*Lemur catta* ♂ & ♀) from Madagascar, presented by Mr. Charles Stewart; a Common Marmoset (*Callorhina jacchus*) from Brazil, presented by Mr. J. Henderson; two Peba Armadillos (*Tatusia peba*) from South America, presented by Mr. Frank Parish, F.Z.S.; a Wood Owl (*Syrnium aluco*), British, presented by Mr. J. Baldwin; two Smooth Snakes (*Coronella levis*) from Hampshire, presented by Mr. W. H. B. Pain; seven Common Crowned Pigeons (*Goura coronata*) from New Guinea, a Victoria Crowned Pigeon (*Goura victoria*) from the Island of Jobie, two Brazilian Hangnests (*Icterus jamaicai*) from Brazil, deposited; a Gray-cheeked Monkey (*Cercopithecus albigena*) from West Africa, purchased; a Prairie Wolf (*Canis latrans*) from Kansas, U.S.A., received on approval; a Vulpine Phalanger (*Phalangerista vulbina*), born in the Gardens.

#### GEOGRAPHICAL NOTES

THE present number of the *Bulletin de la Société de Géographie* commences with a paper by M. Duveyrier, on the geographical extent of the Mussulman confraternity of Senoussi. This sect, which is distinguished by its austere and fanatical tenets, arose forty-six years ago under an Algerian, and appears to have in a greater or less degree permeated the Mohammedan world, and acquired vast political importance. It flourishes especially in Northern Africa, reaching as far south as Timbuctoo. The details of its precise extent and the nature of its activity are given in the paper. The second paper, which is not signed, records a French hydrographical mission to the coast of Morocco by the French officer M. Vincendon-Dumoulin in 1854. The most interesting part of the paper is the introduction, in which the writer discusses the necessity of having a dictionary of geographical etymology; that is, a work which will explain as far as possible the origin and meaning of geographical names, not only from a philological but also an historical point of view. The names, he says, which, for example, Stanley and De Brazza are giving their settlements in Africa, are explicable now, when everybody knows why Leopoldville is so called; but it may be different fifty years hence. But who knows, he inquires, that the territory called Adélie in the Polar Ocean was so called after the wife of Admiral Dumont d'Urville, or that the capes known as Jagersschmidt and Cotelle were named after the members of the hydrographical expedition to Morocco, which the paper then goes on to describe? From the report of a Committee of the Society appointed for the purpose, we see that three

gold medals for geographical work have been awarded this year. The first was granted to M. Alphonse Milne-Edwards for his submarine investigations; the second to M. Thouar for his journey to the Grand Chaco in search of the survivors of the Crevaux Mission; and the third to M. Charnay for his explorations and archæological discoveries in Yucatan. The last paper in the number is composed of a series of extracts from the letters of Abbé Desgodins on the boundary region between Thibet, Burmah, Assam, and China.

THE Danish gunboat *Fylla* returned from the Arctic regions to Orkney last week, having been sent out by the Danish Government on an exploring and surveying expedition. She has had a most satisfactory voyage, occupying nearly four months, and extending along the whole coast of Greenland to 70° N. lat. Her work included a scientific exploration of the inland glaciers in that country, and dredging, trawling, and meteorological observations there and in Davis Straits, Baffin's Bay, and Disco Bay. Many hitherto unknown specimens were brought up by the dredging, the greatest depth being 900 fathoms. Valuable collections have been brought home by the ship in all the scientific sections. The members of the expedition speak in high terms of their collections, which include a meteoric stone estimated to weigh about 2000 lb.

LIEUT. GREELY, in connection with his paper at the British Association, took occasion to say that the fact that had surprised him was the discovery that when the tide was flowing from the North Pole it was found by his observations that the water was warmer than when flowing in the opposite direction. He took trouble to have an elaborate set of observations showing this wonderful phenomenon prepared, which would be eventually published. To him the peculiarities were unexplainable.

A CORRESPONDENT of the *Standard* writes:—"On July 26 the lighthouse-keeper at Cape Reykjanes, the south-west point of Iceland, on scanning the sea with his glass, saw what he at first took for a very large ship, but which a closer inspection showed to be a new island. It had the form of a rounded flattened cone, was of considerable size, and lay, according to his estimate, about fourteen miles north-west of the volcanic island Eldey, or the Mealsack (Melsekken), which lies eight miles off Reykjanes to the south-west. Several earthquake shocks had been felt during the preceding days, and they have since occurred at intervals, but no other volcanic manifestations heralded or attended the rise of the island from the deep. Owing to the danger of approaching the island in an open boat, no one has as yet attempted to land on it. The light-keeper has observed it from day to day when not prevented by foggy weather, and reports no change in its appearance save that a large part of one side of the cone appears to have slipped or fallen down into the sea. From time to time since the colonisation of Iceland, volcanic islands have sprung up out of the waves in the neighbourhood of Reykjanes, only to disappear again after a brief period. In the end of last century an island arose at or near the same place as the present one occupies, and was taken possession of by the Danes, under the name of Nvæ (New Island), but as it consisted only of loose volcanic ash and pumice the action of the waves speedily broke it down, and after little more than a month it disappeared as mysteriously as it had arisen."

OUR ASTRONOMICAL COLUMN

VARIABLE STARS.—Several papers upon these interesting objects have lately appeared in the publications of scientific bodies:—

(1) "A Catalogue of known Variable Stars, with Notes," by Mr. J. E. Gore, in the *Proceedings of the Royal Irish Academy*, vol. iv. Mr. Gore has brought together particulars relating to about 190 stars, including their positions for 1880, the limits of magnitude, mean periods, and epochs of maximum and minimum, for the most part taken from Schönfeld's Catalogue of 1875; indeed, this Catalogue is the source of much of the information contained in Mr. Gore's paper. His summary will be very useful to those who are entering upon the study of the variable stars; some corrections are needed, but they are not of very much importance. Observations by himself of several of the stars are added in the notes following the Catalogue, and others by various observers made since Schönfeld's last Catalogue was published. The positions as printed have a lame

appearance, from being given to seconds of time in right ascension and to seconds in declination: if the right ascension of an object is assigned to the nearest second of time, the more legitimate expression of the declination is to the nearest tenth of a minute. The reference to the fancied identity of "the Biblical star of the Magi" with Tycho's celebrated star of 1572 seems out of place.

(2) "Recent Observations of Variable Stars," presented by Prof. Pickering to the American Academy of Arts and Sciences. The author had previously issued a pamphlet and a circular from the Harvard College Observatory, in the hope of promoting a more systematic observation of the variable stars, and in response has received communications from a number of observers who have expressed their willingness to join in his scheme of observations. In the paper in question Prof. Pickering has brought together the results of observations of variable stars for 1883, so far as he had them at hand, to show the nature of the information which he desires to obtain in order to be in a position to issue a further circular early in 1885. It should be mentioned that Mr. S. C. Chandler is preparing a bibliography of the variables, which will eventually furnish the means of forming a catalogue of all the stars now known to be in a state of change, to a much more reliable extent than hitherto; such a work cannot fail to be of vast assistance to any one desirous of looking up the history of particular stars, which is now an operation attended with much trouble and uncertainty. With regard to his next circular, Prof. Pickering hopes that observers of variable stars, whether professional or amateur, will be generally disposed to furnish information on the following subjects—(a) the method of observation, if photometric, some account of the instrument, and the manner of using it; if not photometric, whether the observations are made by Argelander's method, or by direct estimation of magnitude; (b) stars observed in 1884, with the number of nights on which each was observed; (c) the time and form of publication contemplated by the observer; (d) plans for 1885, naming the stars selected and the number of nights on which it is proposed to observe them. This information it is desired to receive at Harvard College Observatory by February 1, 1885, as well as any material which may be useful towards making the table for 1883 more complete. Prof. Pickering's first table gives the positions of the variable stars for 1875, with the limits of magnitude and the periods; also the discoverer and year of discovery, with references to observations made in the years 1880-83. In a second table is a list of suspected variables extracted from Mr. Chandler's unpublished catalogue.

3. The Rev. T. E. Espin publishes in the *Transactions of the Liverpool Astronomical Society* "A Catalogue of the Magnitudes of 500 Stars in Auriga, Gemini, and Leo Minor," which have been determined from photographs taken by means of the equatorial stellar camera at the Society's Observatory. The apparatus was placed at the disposal of the Society by Mr. Howard Grubb. The magnitudes determined from the photographs are entirely based on those of Argelander. It is stated that the deduced magnitudes of 341 stars out of the 500 agree within 0.4 m. with those of Argelander, while in twenty-five cases the differences exceed a whole magnitude. The nebulae M 35 and 51 have been photographed after exposures of 2h. 55m. and 2h. 0m. respectively, as also the cluster Presepe, of which the photographs show the smallest of Argelander's stars, and some which do not occur in the *Durchmusterung*. Two stars are noted as presenting indications of variability: viz. 41, 1222 in Auriga, which was 8.6 m. on March 19, but was not found on a plate taken a few nights afterwards; and 33, 1895 in Leo Minor. Mr. Espin concludes with the remark, "The difficulty of reducing the stars to Argelander's scale is complicated, from the fact that near the *minimum visibile* the bluer stars alone are photographed, the yellowish ones disappearing."

COMET 1884 b (BARNARD).—The following positions for Berlin midnight have been calculated by Herr Stechert from his elements (NATURE, p. 431).

	R.A.	Decl.	Distance from Earth	Light
	h. m.			
Sept. 15 ...	19 21.4	... -29 23	... 0.703	... 0.76
17 ...	19 29.3	... 28 43	...	...
19 ...	19 37.1	... 28 1	... 0.729	... 0.69
21 ...	19 44.7	... 27 19	...	...
23 ...	19 52.2	... 26 35	... 0.759	... 0.62
25 ...	19 59.5	... 25 52	...	...
27 ...	20 6.7	... -25 8	... 0.792	... 0.55



THE MOVEMENTS OF THE EARTH<sup>1</sup>

## VI.

WE have now to consider some of the results of these Movements of the Earth—first round its own axis, its rotation; then round the sun, its revolution—which we have been considering, results to which of course a general interest attaches, and which there will be no difficulty in showing are of very great importance to us. Occasion was taken to point out that the different appearance presented by the sun and the stars was simply due to the fact that the sun was very near to us whilst the stars were very distant, the one, a sun which happens to be near to us, the others, also suns, but happening to be very far removed from us. Now suppose we have a globe in which we have an electric light, to represent the sun, and a little globe to represent the earth, then it will be obvious that that part of the earth which is turned towards the lamp will be bathed in light, while that half which is turned from it will be in darkness, being, so to speak, only under the light of the distant stars. This shows us the reason for that great difference which we call day and night, and we can quite understand how it is that we get the apparent rise of the sun which occurs when the part of the globe on which we live is carried from the darkness into the light, and sunset which of course occurs when the globe is being carried by its rotation from the light into the darkness. This phenomenon of day and night is thus one of the most obvious results of the rotatory movement of the earth, and one which might have been dismissed in two words had we so chosen, but we will dwell



49.—Diagram showing how the difference between the lengths of the sidereal and mean day rises.

upon it for a few moments, because this fundamental difference between day and night furnishes us with a reason why we should discard that sidereal time to which up to the present reference has alone been made.

Fig. 49 will show how it is that under the circumstances in which we thus find ourselves, a new kind of time must take the place of sidereal time. In this diagram we have the earth represented at two positions in its orbit, 1 and 2. It travels in this orbit in the direction of the arrows, rotating on its axis the while in the direction also indicated by arrows. Now let us consider the start-point 1, and suppose that when the earth occupies this position a particular star is on the meridian at midnight. The earth it will be remembered rotates in twenty-four sidereal hours; it will therefore take twelve hours to turn half round, so that if we consider the sun to be directly opposite the star which is south at midnight it is obvious that they are twelve hours apart. Now consider the earth at position 2. Then remembering this fundamental fact, that the distance of the stars is so enormous that a string stretched from the observer to the star at one point of the earth's orbit would be practically parallel to a string stretched to the same star from any other part of the orbit; it is obvious that the star will have the same right ascension in both positions of the earth, and the line pointing to the star will be practically in the same direction. But the sun will no longer lie along the prolongation of the line joining

<sup>1</sup> Continued from p. 256.

earth and star as it did at 1, for in consequence of the earth's revolution round the sun we shall get a gradually increasing angle as the earth in its orbital course gets farther and farther from its initial position at 1. Now it is obvious if we are going to have our time regulated by the sun instead of by the stars—and that is what we must do for the purposes of civil life—we shall have to arrange our clock so that when we pass from 1 to 2 it must, if it showed 12 o'clock when the sun was due south in the former position, show 12 o'clock also when the sun is due south in the latter position. If this be so, and we have this angle made by the line joining sun and earth and star, we shall have to make our sun-clock go more slowly than our sidereal clock, for the reason that the sidereal clock will have gone round once in less time than the earth will have got round to the same place with regard to the sun. But if we choose, and we do choose, to say that we will have twenty-four hours from sun-southing to sun-southing, then these twenty-four hours and necessarily also their minutes and seconds, will be longer than the hours, minutes, and seconds of sidereal time. Let us take another illustration. Consider the case of the earth in three different positions, represented by three globes round a central lamp. Then suppose that in each of these globes a wire is put to represent the direction in which the transit instrument points at Greenwich when the same star is observed at three consecutive intervals of twenty-four hours of sidereal time. These three wires should therefore be placed parallel to each other. Now let us take the electric lamp to represent the sun, then we shall find that, when the transit instrument on each of the earths

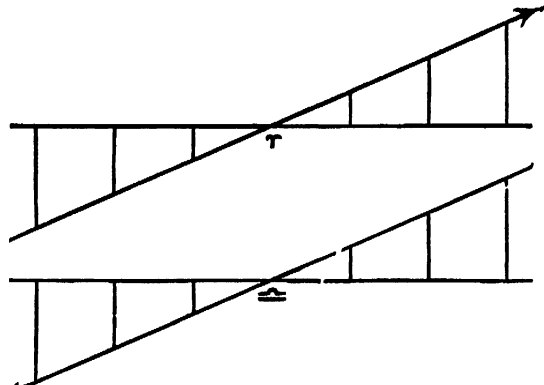

Fig. 50.—Diagram showing how the sun's apparent motion along the inclined lines representing the ecliptic in the direction indicated by the arrow-heads is represented by a smaller amount when referred to the earth's equator (the horizontal lines in the figure) at the spring (T) and autumn (E) equinoxes.

is brought round to point at the sun, the three wires which represent the instruments will not be parallel to each other but at some angle. At first sight it might seem that we could easily get a sun-time to replace the star-time, but unfortunately when we go a little deeper into it we find, as we often do in other cases, that it is not quite so easy—and for two reasons. We found, it will be remembered, when we came to consider the form of the earth's orbit, that it was not quite circular, that it was in fact what is called an ellipse, and that the radius vector, *i.e.* the imaginary line joining the centres of the sun and earth did not sweep through equal arcs in equal times but through equal areas, so that, if we want to invent a clock which will show twenty-four hours from the time of sun-southing one day to the time of sun-southing the next, that clock will require to be regulated differently for every day in the year, because the greater or less part of its orbit moved over by the earth will cause the greater or less angle between the lines joining sun, earth, and star.

That I hope is clear. Thus then there is good reason why this arrangement of having a sun-time from noon to noon will not work. We should have to regulate our clock for every day in the year, or rather for every two opposite days. But there is another matter. We are now in full presence of the fact that the equator of the earth is inclined at an angle of about  $23\frac{1}{2}^\circ$  to the plane of the ecliptic. Fig. 50 will perhaps enable us to understand this matter more easily. Let the horizontal lines represent the plane of the equator and the inclined lines the

plane of the ecliptic. Now our clock and all measurements of time must depend upon the earth's rotation, the plane of which always remains parallel to itself, and we have seen that our start-point for geocentric and heliocentric longitude depended upon the fact that at a certain point in its revolution the earth passed through a node, and that the node at which the sun with its apparent motion crossed the equator northward was called the ascending node. In the diagram this is represented by  $\tau$  in the upper figure, and the descending node is indicated by  $\triangle$  in the lower figure. It will be seen that if we have equal intervals along the ecliptic the motion along the equator is represented by bases of successive triangles, of which the hypotenuses lie along the ecliptic. Now the hypotenuse must be

55

by the fact that the two motions of the earth—its axial rotation and yearly revolution—take place in different planes. How are these difficulties got over? They are got over by pretending a sun, as a child would say. Astronomers pretend that there is a sun moving along the equator, or, in other words, they pretend that the earth's movement of revolution takes place in the same plane as its movement of rotation. It is further imagined that this imaginary sun travels at precisely that rate which it would if the average of all its rates along the ecliptic during a year were taken, so that we get something like this (see Fig. 52); first of all we have the curve  $B B B B$ , which shows the variation which would take place providing we only had to deal with the obliquity of the ecliptic. Where that curve crosses the horizontal line, we get at those moments (if we disregard the elliptic motion) the same time shown by the mean sun as we should get if the true sun had been taken; it will be seen this occurs four times during the year—on March 20, June 21, September 23, and December 22. Then there is another curve,  $C C C C$ , which represents another relation between the mean sun and the true sun. Providing that the two planes were coincident, and that the movement of the earth under these conditions were exactly the same as under the present conditions, namely, that she moved in an ellipse and that the radius vector swept over equal areas in equal times, then we should have the true and mean sun coincident on December 31 and July 1 only. Then the algebraic mean of these two curves,  $B B B B$  and  $C C C C$ , is taken, and we get as a result the lower curve  $D D D D$ , which is a compound of the two other curves, and as the result it will be seen that where we get the curve  $C$ , giving us a difference of nearly five minutes, and the curve  $B$ , giving a difference of about nine minutes in the same direction, we have a very great departure between the motions of the real and mean suns. Above and below the datum line, which is marked zero, we have 5, 10, and 15, which represent the difference in minutes at which the southings of our real and fictitious suns really take place. Early in the month of February we have a difference of very nearly fifteen minutes between the two suns, and it is at this time of the year of course that the sun dial is most in error. At other points where the effect of curve  $B$  is to cause a great difference, the effect of curve  $C$  will be to minimise that difference, and so in the compound curve  $D$  the difference is very slight. About the middle of June we get them together, then towards the end of July we get another separation, and about November 1 we come

FIG. 51.—Diagram showing how the sun's apparent motion along the ecliptic, now parallel with the earth's equator (the central line of the figure) at the summer ( $\odot$ ) and winter ( $\ominus$ ) solstices, is represented by equal intervals along the equator.

greater than the base, so that we have at the ascending node the motion of a body along the ecliptic represented only by the base of a triangle of which the motion itself represents the hypotenuse; and the same thing happens in the opposite manner at the descending node; whereas if we take the other positions shown in Fig. 51, for a short time at all events the motion will be parallel, and motion along the ecliptic will be represented by an equal amount along the equator.

These then are the difficulties we have to face when we come to fix our sun-time, first, the unequal velocity of the earth round the sun; and secondly, those variations which are brought about

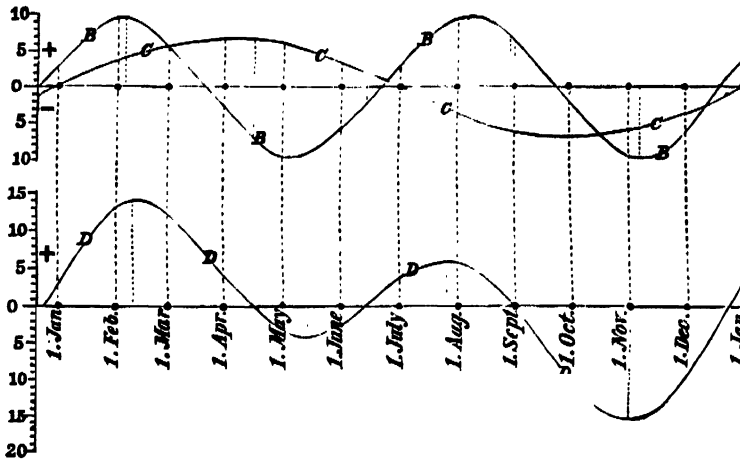

FIG. 52.—Diagram showing how the equation of time (curve  $D D D D$ ) results from the combination of curve  $B B B B$  representing the variation due to the obliquity of the ecliptic, and curve  $C C C C$  representing the difference between the mean and true suns.

to another difference even greater than that in February. In this way a correction has been introduced, which is known as the "equation of time," and this added to the motion of the true sun, or added to that of our imaginary sun, brings them together, and by this means the mean sun is kept as nearly as possible to the average position of the true sun throughout the year. Another diagram (Fig. 53) will enable us to understand some of the considerations which have brought this about. Let  $F$  represent the position of the sun in one of the foci of the ellipse,  $P \epsilon A$ , round which the earth is supposed to be travelling. Now while we have the real radius vector going from  $P$  to  $\epsilon$ , with its

unequal motion along the orbit, we have a fictitious radius vector going with absolute constancy along the circle. We get what is called the true anomaly in the angle  $P F \epsilon$ , and the mean anomaly in  $P F \epsilon'$ , and the difference  $\epsilon F \epsilon'$  is called the equation of the centre. This equation helps us to determine those curves to which reference has been made, and the chief object in calling attention to this diagram is to explain the meaning of the term anomalistic year, which it will be necessary to introduce presently. It has already been said that it is imperative, if we are to gain any advantage from it, that real sun-time and apparent sun-time should never be widely separated, because if so we might have

contented ourselves simply with sidereal time, which would have at least the advantage of being constant, so that it is most necessary if any benefit is to be derived from this mean sun of ours that it should not differ very much from the true sun. The longitude of our mean sun is therefore made equal to the mean longitude of the true sun. This having been premised, the terms "mean time" and "mean noon" will now be clear without any explanation. "Greenwich mean time" of course means time referred to the meridian of Greenwich.

We thus finally discard our sidereal time, and replace it by mean solar time so arranged that the maximum departure of this from true solar time shall be fifteen minutes in the month of February and fifteen minutes at the beginning of November. We have seen that the sidereal day is shorter than a solar day, and that consequently the hours, minutes, and seconds which

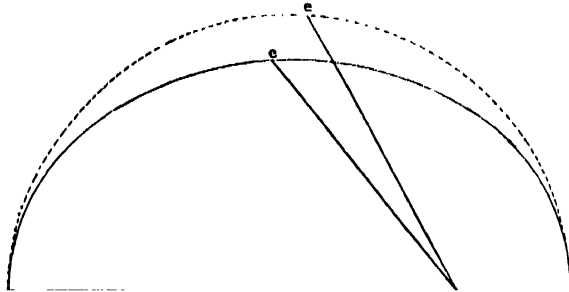

FIG. 53.—Diagram explaining mean anomaly and true anomaly.

make up the sidereal day must be shorter than those which form the solar day. The relation between the seconds of solar and sidereal time may be thus shown.

One sidereal second =  $\cdot 9973$  of a mean time second.

One mean-time second =  $1\cdot 0027$  of a sidereal second.

We have now got the results of the earth's revolution combined with its rotation, so far as day and night, considered in their more general aspects, are concerned; but we have not done with day and night yet. When we were considering the question of the inclination of the earth's axis, we went so far as to say that it was inclined  $23\frac{1}{2}^{\circ}$  to the plane of the ecliptic, and that it always remained practically parallel to itself. Now suppose we arrange four globes in a circle, to represent the earth in different parts of its orbit, and we have in the centre an electric lamp to represent the sun. Then, if the earth's axis is thus inclined to its path round the sun, and always remains parallel to itself, it will be seen that at one position the north pole will be all in the light of the electric lamp (which represents the sun) during the entire revolution of the earth on its axis.

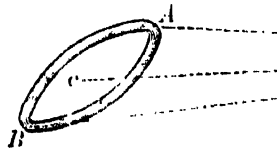

FIG. 54.—The attraction of the sun on the earth's equatorial protuberance.

ject, yet the earth's rotation may be used to bring in the dimensions of the body on which we dwell in just the same way as the velocity of light was used to refer to the dimensions of its orbit.

We need not, however, consider the question in detail, but we may state that the earth is a globe of something like 8000 miles in diameter, the equatorial diameter being longer than the diameter from pole to pole by some twenty-six miles, so that we have, as it were, round the equator a ring of matter some thirteen miles thick and eight thousand in diameter. Now this ring of matter, this equatorial protuberance, is presented to the sun at an angle to the line joining the centres of the sun and earth, as shown in Fig. 54, and the sun's attraction upon it can be resolved into two forces, one parallel to the line joining the centres of the sun and earth, and the other at right angles to this direction; and if we consider what will be the effect of this

At the point opposite this the reverse happens, for during the entire rotation of the earth the north pole will be in the dark. At the two remaining points the pole will be just on the boundary of light and darkness. We need not consider the case of the south pole; there exactly the reverse will happen to what occurs at the north pole—when the north pole is always in the light, the south pole will be always in the dark, and *vice versa*, as may be seen by looking at the globes. Now it should be clear that the fact of the earth's axis being inclined to its path causes different lengths of day and night throughout the year. It is simply that, and nothing else. At the poles, which, as we have seen, are sometimes entirely in the light and sometimes altogether in the dark, there will be six months of this light and six months of darkness. At the equator it will be readily understood the days and nights will be of twelve hours' duration at whatever part of her orbit the earth may be. If you take those positions of the earth where the boundary of light and darkness passes through both the poles, it is perfectly clear that the days and nights are of equal length all over the world, and a line drawn from those points through the sun is therefore called the "line of equinoxes." These points are respectively at the ascending and descending nodes of the orbit. The two other points where the North Pole is most in the light or in the dark during the whole of a rotation are known as the solstices, because it is at these times that the sun for some days appears to attain the same height at noon.

To sum up then, it will be seen that the earth's rotation and the earth's revolution, in conjunction with the important fact of the non-coincidence of the planes in which they take place, give us not only our days and our nights, but cause the lengths of them in different latitudes to vary throughout the year. We have in this inclination of these planes to each other, too, the cause of the seasons, because when the northern hemisphere of the earth has been for a long time in that position with the sun longest above the horizon, the temperature will be very different to what it is when the earth is in the other position. In the former position we have summer in the northern hemisphere, in the latter winter. The conditions of life at two such points in the orbit will be vastly different. At the equator, where the days and nights are always of equal length, the course of nature will be very uniform. As the equator is receded from and the poles are approached, this uniformity begins to disappear until, as has been said, at the pole six months of perpetual daylight alternate with six months when there is no sun.

But even now when we have got our day and our year, we have not got all.

It must next be pointed out that, whilst the axis of the earth may be said to remain practically parallel to itself, yet that it does not absolutely remain so.

As a result of this and of the earth's movement round the sun, we get a very important outcome. Although the consideration of the dimensions of the earth has scarcely come within our sub-

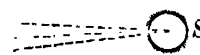

latter force upon such a ring, we can easily understand that it will result in an alteration of the inclination of the ring. In an arrangement for showing the effect of this attraction, the ring of matter on which the sun acts may be represented by an iron ring attached to a spinning top, and the resolved portion of the sun's pull may be imitated by the attraction of a magnet held in a nearly vertical position. As the ring rotates, the attraction of the magnet draws the ring out of the horizontal, and the poles revolve in a circle. This is what takes place with the earth's axis; hence it is not true to say that it always remains parallel to itself. This revolution is always slowly going on, being completed in a period of about 25,000 of our years. In consequence of this motion, what happens is this: the line of equinoxes which is at right angles to the line of solstices is constantly changing its position along the earth's orbit, producing what is called the precession of

the equinoxes. We have to consider, therefore, not merely the sidereal year, the time between which the earth is at one point with reference to the sun and a star, and the time when it is at that same point again; we have not merely to consider the fact that this line of solstices, with its conjoined line of equinoxes, varies with regard to what is called the apse line, that is, the line joining the perihelion and aphelion points of the orbit, or the axis-major of the ellipse—but we get from this another year which is called the tropical year, which, like our mean time, is the one most used, because it brings the year into relation with our seasons. Now that we have got our mean time and know exactly how and why we have got it, we may express the sidereal year in mean time, and say that it consists of 365·256 solar days. The tropical year—the time which elapses between two successive passages through the vernal equinox—is shorter than the sidereal one, owing to the precession along the orbit of the equinoctial points, and consist of 365·242 mean solar days, and the difference between the lengths of this and the sidereal year will of course give the annual amount of precession which takes place. Anomalistic year is the term applied to the period which elapses between two successive passages through the perihelion or aphelion points of the orbit; and as these points have a forward motion along the orbit, this year is longer than the sidereal one, being 365·259 mean solar days.

We may give the exact lengths of these years in days, hours, minutes, and seconds as follows:—

	Mean solar tin	
	d.	h.
Mean sidereal year ... ..	365	6 9 9·6
Mean tropical year ... ..	365	5 48 46·054440
Mean anomalistic year ... ..	365	6 13 49·3

The Movements of the Earth are so important to us, and so interesting in themselves, that it is not possible in six lectures to exhaust all that may be said about them or learned from them. I trust however that I have left no point of the first importance untouched. The moral of these lectures is that astronomy has appealed to physics, and has not appealed in vain, for the demonstration of the physical reality of the movements in question.

J. NORMAN LOCKYER

#### THE FRENCH ASSOCIATION FOR THE PROGRESS OF SCIENCE

THIS Association began its meetings at Blois on September 3. The financial situation of the Association is very prosperous indeed; the capital has amounted to 20,000*l.*; but the sum spent in scientific researches amounts to only 300*l.*

The President of the Association for this year is M. Bouquet de la Grye, and his inaugural address consisted of a sketch of the history of oceanic hydrography. He dealt with the difficulty of the determinations made on the bottom of the sea, and insisted on a new idea of his own. He believes that the level of the sea presents considerable variations owing to the quantity of salt contained in the water. He says that the level of the Mediterranean ought not to be so high as the level of the ocean owing to the greater quantity of salt and consequently of density. A diminution of temperature produces the same effects as enlarging the density; so an increase of the temperature of the German Ocean would produce a flood on the Belgian, Dutch, German, and French coasts, and bring the sea to Paris.

Dr. Grimaux, a pupil of the late M. Wurtz, delivered a speech on the illustrious Academicians who have died during the past year, among whom Dumas and Wurtz have unquestionably the foremost place.

It is probable that this year the long-hoped-for fusion with the Association Scientifique de France, established by Leverrier, and presided over by Milne-Edwards, will take place, and the two Associations amalgamated in one will take a new start.

One of the principal objects of the present sitting has been the examination of the Thenay geological strata, where Abbé Bourgeois thinks he has discovered Tertiary man. The principal French geologists have arrived in Blois for the excursions. There are very few foreigners at the meeting.

#### TRAINING IN NAVAL ARCHITECTURE<sup>1</sup>

AT Govan, the great shipbuilding suburb of Glasgow, on the 4th inst., Prof. F. Elgar, of Glasgow University, addressed the students attending the Science and Art Classes upon the

<sup>1</sup> Communicated by Prof. Elgar.

above subject. In the course of his address Prof. Elgar said:—

"All of the students who attend the classes in naval architecture and engineering here are probably much better acquainted with the practical and experimental aspects of the work they are engaged in than they are with the science which underlies it; and their present object is the very vital and praiseworthy one of acquiring such scientific and technical knowledge as will enable them to apply sound principles to the performance of their work, and to assist them in dealing intelligently and successfully with the many difficult and novel questions which are constantly obstructing and puzzling them. There are no branches of mechanical art in which sound scientific knowledge is more essential and useful, or in which it is more necessary for theory and practice to go hand-in-hand together, than those of shipbuilding and engineering. A modern steamer is so complex a machine that no attempts to construct one without calling in the aid of science in some form—either directly or by copying what others have learned by it to do—could possibly end in anything but disastrous failure. Try to imagine a man who had never heard or read of any of the teachings of science attempting to construct a modern steamship—a man who did not know even of the proposition, said to have been demonstrated by Archimedes, that a floating body displaces a volume of water whose weight is equal to its own weight; and who was ignorant of the wonderful discoveries that have been made of the laws by which heat generated by the combustion of coal is converted into mechanical work through the agencies of the boiler and steam-engine. It only requires to state the matter in this bald form in order to show how hopelessly impossible and absurd such an attempt would be, and how vitally dependent shipbuilding and engineering are upon the past achievements and present teachings of science. On the other hand, the highest scientific talent the world has yet produced would be equally unable to arrive at a successful result simply by means of pure theory, however advanced, and by strict *a priori* methods. The course you are pursuing, and which I trust you will not depart from, is the one best calculated to insure for you the greatest success in your work and advancement in your various positions in life; and as in the daily practice of your profession you are perforce kept well abreast of the practical and experimental sides of your work I would now urge you, in the strongest manner possible, to cultivate most diligently and thoroughly a knowledge of the science and of those natural laws upon which the efficiency and success of your efforts depend. Whatever may be the character of your daily work, whether you are employed as engineers, draughtsmen, or mechanics—and I am very pleased to know that there are working mechanics who attend these classes, and who are among the most earnest, intelligent, and capable of the students—never rest satisfied till you know the meaning of all that you do and why you do it. Do not be content with merely learning methods of setting off work and performing calculations, or with copying processes you may have seen others employ. The man who merely does as he sees others do, without very well comprehending why they do it, and who works strictly by rule and line, looking to custom as the supreme authority, will never improve or advance himself, nor be of much real use in such times as these; nor will he find much interest in his work.

<sup>2</sup> Custom, which all mankind to slavery brings,  
That dull excuse for doing silly things."

Never look to custom as being a sufficient authority for anything, however respectable its antiquity may have made it; but be determined to understand for yourselves whether or not it is based upon sound and intelligible principles. Although we are now meeting under the auspices of the Young Men's Christian Association, I can safely recommend you to indulge freely a spirit of scepticism in this particular department of the Association's work. The region of science and of the pure intellect is not one in which you should be content to accept the mere authority of any one as final, or to test any question except by the standard of your own reason. Do not be too eager to believe that anything you are told is correct until you are able to prove it for yourselves, and till you no longer feel any ignorance or doubt in the matter. The necessity for combining wide scientific knowledge and sound theory with practical experience, in the carrying on of shipbuilding and engineering operations, is daily becoming more and more pressing. If you tried to avoid it you could not. In this age of keen competition and rapid development, increasing demands are made upon all who are engaged in these important.

industries. Every success that is achieved by the most advanced and sensational productions creates a demand for still further progress; and in meeting these demands, in the future, the race will be to the swift and the battle to the strong. The speed and the strength that you require in order to enable you to hold your own in this contest are speed and strength of intellect. In other words, you require your intelligence to be cultivated and well informed, and to be made prompt and active, by means of scientific culture; and it is necessary for you to acquire such a firm and comprehensive grasp of sound theoretical principles as will enable you to rely safely upon your own powers of judgment, and to act in difficult cases with certainty and precision. Not only does modern competition ever demand more from you in the way of technical knowledge, skill, and resource, but it also shortens the time at your disposal for supplying it. The huge and complicated engineering structures of the present day, such as are constructed in this district, have to be completed in as short a time as the much simpler and smaller ones of a generation ago. You have thus not only much more to think about in building a ship, and problems of greater number and difficulty to solve than used to be the case, but you have only the same time in which to do it all. You cannot afford to delay the progress of construction for the purpose of trying experiments or brooding over any difficulties you may meet with. It is necessary to decide promptly each question as it arises, and you have to qualify yourselves for doing that. The naval architect and engineer of the present day requires to supplement his practical knowledge by a close and systematic study of various branches of science. An enumeration of some of the chief of them will be sufficient to show how great are the demands thus made upon him. There are the laws upon which the flotation and stability of ships, and their behaviour among waves, depend, those which determine the structural strength of a vessel, and its relation to the forces which may be brought to bear upon her by her own weight and that of her cargo, when she is floating upon a changing wave-surface; the difficult problems connected with the resistance of a ship to motion through the water, the power requisite to drive her at a given speed, and the manner in which this is affected by her outward form and proportions. Then there is the wide field of thermal science, and its application to the means by which the conversion of heat into mechanical work effected through the agencies of the boilers, cylinders, condenser, and mechanism of the engines; together with the action of the propeller, and the principles upon which its efficiency depends. No man has ever yet succeeded in completely mastering these difficult and complicated problems; and it is perhaps not possible for many of you to advance very far towards their solution. Still it must be borne in mind that it is only by studying the sciences which bear upon them that any real or substantial progress can be effected; and although finality may be unattainable, great advances are possible, and are constantly being made. Hardly a year passes without something considerable being done to improve our knowledge of those natural laws upon which the safety and efficiency of ships at sea depend. There is probably no district in this country which has benefited more in the past than Govan by scientific progress and great mechanical skill in shipbuilding and engineering, or whose prosperity in the future is more dependent upon it. Govan has been placed among the foremost of shipbuilding communities by means of great scientific and practical talent, industry, and enterprise; and it rests with many whom I now see before me to maintain it in the honourable and distinguished position to which it has been raised. The names of Napier and Elder, not to mention others, are alone sufficient to give prestige to any engineering locality; and they insure for Govan a high place in all future records of scientific, mechanical, and industrial progress. Upon you rests the responsibility of worthily walking in the footsteps of those and others among your distinguished men, and of striving to keep erect in this district the noble edifice they have reared."

## SOCIETIES AND ACADEMIES

### PARIS

**Academy of Sciences, September 1.**—M. Rolland, President, in the chair.—Some remarks on the subject of the theory of the figure of the planets, by M. F. Tisserand. The author's calculations and estimates of their present form are based on the assumption that the celestial bodies were originally in the fluid state, subject only to the mutual attraction of their constituent

elements, and endowed with a rotatory movement with very slight angular velocity. Their outer surface would thus be somewhat that of a revolving ellipsoid.—Researches on the general development of vegetation in an annual plant: functions of the hydrocarbon elements, by MM. Berthelot and André.—Note on the general resolution of the linear equation in matrices of any order, by Prof. Sylvester.—Remarks on the attempts made at various times to solve the problem of aerial navigation, by M. Laussedat. The author supplies a rapid sketch of the progress of aerostatics in connection with the Commission lately appointed by the Academy to examine the claims of priority of various inventors. He considers that General Meunier was the first to introduce the elongated shape of the balloon, the screw as the propelling agent, and the principle of the "ballonnet" or air-bag, rediscovered by M. Dupuy de Lôme. M. Conté is credited with great improvements in the construction of spherical balloons, and M. Alcan is stated to have anticipated M. H. Giffard by several years in the application of steam to aerial navigation.—Comparison between the coloured electro-chemical and thermal rings of Nobili and others, by M. C. Decharme.—Observations of the planet 240 discovered at the Observatory of Marseilles on August 27, 1884, by M. Borrelly.—Determination of the wave-lengths of the chief rays and bands of the infra-red solar spectrum, by M. Henri Becquerel. Tabulated results are given for the chief bands in millionths of millimetres.—Remarks on the formation and development of the nervous cellules in the spinal marrow of mammals, by M. W. Vignal.—Note on the recent luminous phenomena observed around the sun in Switzerland (second communication), by M. F. A. Forel. A second trip to the Alps, undertaken towards the end of August, enables the author to confirm and complete the details already communicated to the Academy. Aeronauts are invited to study some of these light-effects, and especially the red corona round the sun, scarcely perceptible from the plains and low elevations, but perfectly visible at altitudes of from 3000 to 6000 feet above the sea level.—Account of the optical telegraph recently established between the islands of Mauritius and Réunion, by M. Bridet. The telegraph set up on Lacroix Peak in Réunion and Vert Peak in Mauritius was completed on the night of July 12-13, when messages were freely exchanged between the two islands.

## CONTENTS

	PAGE
<b>Descriptive Mineralogy</b> . . . . .	461
<b>The Mosses of North America.</b> By J. G. Baker, F.R.S. . . . .	461
<b>Letters to the Editor:—</b>	
The Diffusion of Species.—The Duke of Argyll . . . . .	462
Meteor- Moon- and Sun-Shine.—Prof. C. Piazzi Smyth, Astronomer-Royal for Scotland . . . . .	462
Pons' Comet—Pink Glow.—A. S. Atkinson . . . . .	463
Alternation of Generations in Salpa.—R. N. Goodman . . . . .	463
Forked Lightning.—Rev. Dr. C. Michie Smith . . . . .	463
Sun-Glows.—Robert Leslie . . . . .	463
Fireballs.—Wm. White . . . . .	464
Deep-Sea Corals.—Prof. P. Martin Duncan, F.R.S. . . . .	464
Iridescent Lunar Halos.—T. H. Potts . . . . .	464
Sextants.—T. W. Baker . . . . .	464
Electrical Rainbow.—R. S. Newall, F.R.S. . . . .	464
Rainbow on Spray.—G. H. . . . .	464
Circular Rainbow seen from a Hill-top.—W. L. Goodwin . . . . .	465
Intelligence in Frogs.—B. W. S. . . . .	465
<b>The Temperature of the Solar Surface.</b> By Capt. J. Ericsson. (Illustrated) . . . . .	465
<b>The British Association:—</b>	
Section F.—Geography—Opening Address by General Sir J. H. Lefroy, R.A., C.B., K.C.M.G., F.R.S., F.S.A., V.P.R.G.S., President of the Section . . . . .	469
Section G.—Mechanical Science—Opening Address by Sir F. J. Bramwell, F.R.S., V.P.Inst.C.E., President of the Section . . . . .	472
<b>Notes</b> . . . . .	476
<b>Geographical Notes</b> . . . . .	478
<b>Our Astronomical Column</b>	
Variable Stars . . . . .	479
Comet 1884 $\delta$ (Barnard) . . . . .	479
<b>The Movements of the Earth, VI.</b> By J. Norman Lockyer, F.R.S. (Illustrated) . . . . .	480
<b>The French Association for the Progress of Science Training in Naval Architecture.</b> By Prof. Elgar . . . . .	483
<b>Societies and Academies</b> . . . . .	484

# NATURE

THURSDAY, SEPTEMBER 18, 1884

## THE ZOOLOGICAL COLLECTIONS OF H.M.S. "ALERT"

*Report on the Zoological Collections made in the Indo-Pacific Ocean during the Voyage of H.M.S. "Alert," 1881-82. (London: Printed by Order of the Trustees of the British Museum, 1884.)*

WE need only remind our readers that the *Alert*, under the command of Capt. Sir George Nares, and his successor, Capt. J. Maclear, made a voyage of survey which lasted during the years 1878-82, that the principal parts of the survey were carried on (1) in the region of the southern extremity of the American continent; (2) in that of the coasts of North-Eastern Australia and Torres Straits; and (3) among the groups of Oceanic Islands in the Western Indian Ocean situated between Madagascar and the Seychelles. Dr. Coppinger was the surgeon on board, and it will be always to his credit that while ever attentive to his official duties he succeeded in making and sending home immense collections of marine animals taken by him at the several stations. Those collected off the South-Eastern American continent were reported on in a series of papers published in the *Proceedings* of the Zoological Society for 1881, and were presented to the British Museum. Those from the two other regions were also deposited in the British Museum and reported on by the officers of the Zoological Department, but these reports were, both in their extent and importance, far beyond the scope of any periodical publication, and at the suggestion of Dr. Günther, the Keeper of the Zoological Department, the trustees have published the full account in the form of a separate volume. Irrespective of a number of specimens set aside as duplicates, not less than 3700, referable to 1300 species, were incorporated in the national collection, and of these more than one-third were new additions, if not to science at any rate to the Museum. Well may Dr. Günther write that these "pages are by themselves a lasting testimony to the great service rendered by Dr. Coppinger to the National Museum and to the cause of science."

The exigencies of the service prevented any deep dredgings, so that though many interesting discoveries were made in the western parts of the Indian Ocean, the depths of this region are still waiting to be explored. The account of the collections made at Melanesia form the first 482 pages of this volume. The Vertebrates are reported on by Mr. Oldfield Thomas, Mr. R. Bowdler Sharpe, and Dr. Günther. They call for no special notice; but Dr. Günther takes the opportunity afforded him by the examination of several well-preserved specimens of Branchiostoma in Dr. Coppinger's collection to give a revision of the known species. While at one time inclined to agree with J. Müller that there were no specific differences between Brazilian and European specimens, and even considering specimens from Indian and Australian localities to be referable to the one species, Dr. Günther has now convinced himself that this view is incorrect, and that Sundevall was quite

right in drawing attention to the number of myocommas as an excellent taxonomic character. The number can be ascertained even in specimens in an indifferent state of preservation, and varies very little; whilst the extent in depth and length of the delicate fin which surrounds the posterior part of the tail is a much less reliable character, subject to much alteration by the spirit unless great care is taken in the preservation of the specimens. The species may be briefly enumerated as (1) *B. elongatum*, Sund., Peru; (2) *B. bassanum*, G., Bass Straits; (3) *B. belcheri*, Gray, Borneo and Torres Straits; (4) *B. caribæum*, Sund., Rio de Janeiro; (5) *B. lanceolatum*, Pallas, Europe, Atlantic coast of North America; and (6) *B. culltellum*, Peters, Moreton Bay and Thursday Island. A species of this genus is common on the sandy shores of Mahé, one of the Seychelles, but does not appear to have been dredged by Dr. Coppinger.

Mr. Edgar Smith's Report on the Mollusca forms quite a monograph of this group as found in North and North-Eastern Australia: many new species are described, and most of them are figured. The Echinoderms are described by F. Jeffrey Bell. "Though there are no new Echinoidea, there are some very precious series of some species, *Muretia planulata* being notably well represented": 22 species are catalogued. Thirty-one species of Asteroidea are enumerated, 4 being new; and 26 species of Ophiuroidea, four of which are new, and a new genus, Ophiopinax, is established for *Pectinura stellata* of Lyman. Of the Holothuroidea 19 species are mentioned, and 6 are described as new, and figured. As to the Crinoidea, the author acknowledges the help he received from P. H. Carpenter, and details 27 or 28 species. "The proportion of undescribed to described species is no doubt appalling." Of 15 species of Antedon, 12 are described as new; and of 12 species of Actinometra, 4 are described as new, and 2 are recorded for the first time on the manuscript names of Herbert Carpenter, to be more particularly described in his forthcoming Report on the Comatulæ of the *Challenger*.

The Crustacea, reported on by Mr. E. J. Miers, chiefly collected "on the north-western, northern, and north-eastern coasts of Australia, are very numerous, and are interesting not only on account of the large number of new or rare species obtained, but also on account of the careful manner in which, in nearly every instance, the nature of the sea-bottom and the depth of water, &c., were recorded;" 203 species are enumerated, and 45 are described for the first time. The depths seem to have been from off shore to 30 fathoms. Eighteen plates of figures accompany this part of the Catalogue.

The collections of Alcyonaria and Sponges made by Dr. Coppinger are described by Mr. Stuart O. Ridley, whose reports are very welcome additions to our knowledge of these forms. Although not containing deep-sea forms, these collections give a good general insight into the character of the fauna of the shallow waters of the north east and north-western coasts of Australia. The almost absence of forms of Pennatulidæ—only 2 species are recorded, one very young, and the other very imperfect—is hardly to be accounted for by the fact that no greater depth than 36 fathoms was reached with the dredge, as the Pennatulids are by no means exclusively deep-sea forms. Of the fixed forms 36 species are referred to, of which 12

are described as new. The occurrence of two kinds of polyps differing chiefly in size is noted in a new species of *Melitodes*. The Sponge collection was large, comprising over 300 specimens, representing 110 species, besides 7 distinct varieties, of which more than half were well preserved in spirits; a large proportion—42—were new. More than one-sixth belonged to the *Ceratosa*, 86 to the *Silicea*, with no representatives of the sub-order *Hexactinellida*, and there were but three species of *Calcarea*. The author deserves great credit for the painstaking way in which he has described every form, so that no doubt might remain as to its character; and where there was the slightest doubt of the form being a new species he has refrained from possibly adding to an already over-burdened synonymy.

The description of the collections from the Western Indian Ocean forms the second part of this volume, and occupies about 150 pages. The reporters are the same as in the previous part. Among the birds, Mr. Sharpe describes a new Turtle Dove (*Turtur coppingeri*) from the Glorioso Islands. Mr. Edgar Smith's list of Mollusca "may be regarded as an appendix to E. von Martens's work on the Mollusca of the Mauritius and the Seychelles"; of the 121 species noted, between 40 and 50 do not occur in Möbius's work, and the majority of them, as might be expected, are well-known forms." Thirteen new species are described and figured.

Forty-eight species of Echinoderms are tabulated by Mr. F. Jeffrey Bell. The only object of special interest is a remarkable new Ophiurid, for which a new genus, *Neoplax*, has been established; *N. ophiodes* was found at Darros Island, Amirante Group.

The collection of Crustacea, described by Mr. E. J. Miers, though less numerous in species and less interesting than those obtained on the Australian coasts, contains a large number of rare and undescribed forms, partly owing to the fact that the groups of islands known as the Amirante, Providence, and Glorioso Groups have hitherto been unknown to the carcinologist; 104 species and varieties are enumerated from the African sub-region, of which 16 species are described as new. A useful table showing the distribution of the species on the East Coast of Africa and islands adjacent is appended to this Report.

Mr. C. O. Waterhouse describes a new beetle (*Cratopus adspersus*) from Eagle Island (Amirante), and Mr. A. G. Butler a new moth (*Driopeia lactea*) from Providence Island (Mascarines).

The series of Alcyonaria and Sponges, as before, are described by Mr. Stuart O. Ridley. The collection of Alcyonarians made was small, not, we should imagine, because the dredgings were limited to depths not exceeding 30 fathoms, but to the difficulties of collecting on and under coral reefs. Probably the same difficulty was in the way of a collection of Zoantharia being made, though notably species abound all around these Western Indian Ocean Islands. Of the 6 species of Alcyonaria, 2 are noted as new. The collection of Sponges was more important, containing as it did 56 species, of which 21 are described as new. In a survey of the species the author notes that, "notwithstanding the large proportion of new specific forms, there is a comparative scarcity of forms showing marked distinctive characters of generic

importance which are not also to be found in the more familiar Atlantic fauna." Indeed this western part of the Indian Ocean may be considered, so far as the Sponge fauna goes, as transitional between Australia, South-West Africa, and the Mediterranean.

#### LETTERS TO THE EDITOR

[The Editor does not hold himself responsible for opinions expressed by his correspondents. Neither can he undertake to return, or to correspond with the writers of, rejected manuscripts. No notice is taken of anonymous communications.]

[The Editor urgently requests correspondents to keep their letters as short as possible. The pressure on his space is so great that it is impossible otherwise to insure the appearance even of communications containing interesting and novel facts.]

#### The Flow of Streams

THE inclosed notes by my friend Mr. George Maw of Ben-thall Hall will no doubt interest some of your readers. They were communicated by me to Sir Wm. Thomson, who made the following remarks upon them:—"Mr. Maw's notes are extremely interesting. I lately observed similar phenomena in the streams flowing from the pools on the Burbo Bank near Liverpool. You ought to send them to NATURE."

DEAR MR. SMITH,—As I know you have been making observations on river currents and the effect of friction on the motion and passage of streams, I cannot resist sending you the accompanying notes on a very curious case we met with near the Lake of Thun. It is an extreme illustration of the action of gravitation and friction working, as it were in opposition. I have often observed something of the same kind before, but never so well marked. Looking up the stream from the lake, the effect was just like a long ladder of low waves approaching you, each separately breaking over a low fall into the lake.

Believe me very truly yours,

GEORGE MAW

Hotel and Pension Ober, Interlaken, June 29

Notes on a Pulsating or Intermittent Stream at Merligen, on the Lake of Thun

The intermittent flow of streams familiar to us, from the rapid pulsation of the cataract to the slower rise and fall at regular intervals of less precipitous streams, is strikingly illustrated in a mountain stream flowing into the Lake of Thun, near Merligen. The lower part of its course over a small talus or sloping delta has been artificially banked up as a straight channel 15 feet wide, evenly paved and walled with stone. The lower part has an inclination of about one in twelve, and the upper part towards the mountain gorge a slope of about one in nine. It flows directly

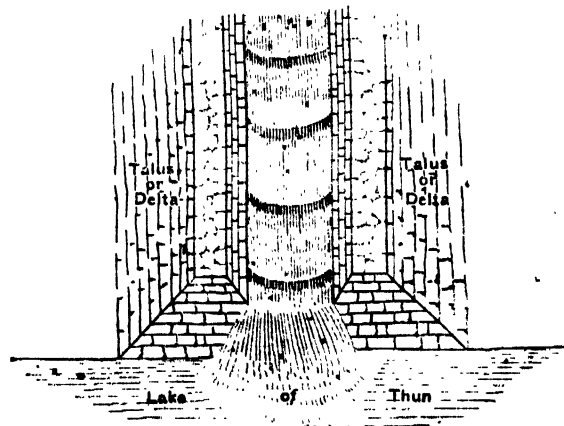

into the lake, and, viewed from the lake, presents a remarkable appearance.

The fall into the lake pulsates at intervals of  $3\frac{1}{2}$  seconds by a sudden increase of volume, and the stream above, flowing over

the level paved bed presents the appearance of a ladder of low advancing waves occurring at regular intervals of about 40 feet over the lower slope of one in twelve, and at less regular intervals of about 12 feet over the steeper slope of one in nine.

Of the motion of the stream over the lower slope of one in twelve the following particulars were noticed:—

A floating body travels at the rate of 9½ feet per second, but this does not represent the speed of any part of the water.

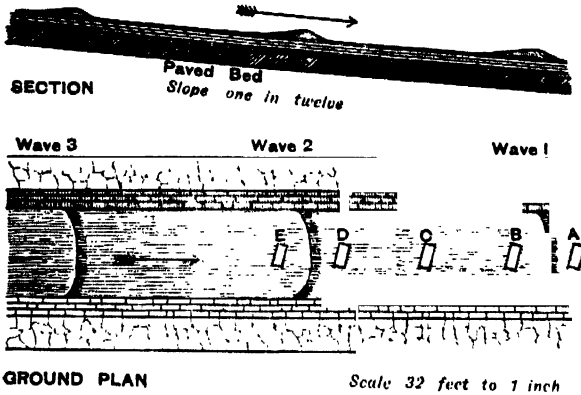

The wave-heads advanced at the rate of 13 feet a second, and the intervening stretches of stiller water (as nearly as I could judge) at about 6 feet a second. It is evident that the upper and lower currents are travelling at different rates—the bottom current retarded by friction, the surface current advanced over it by gravitation, accumulating at intervals of about 40 feet into wave-heads of a semicircular form, the sides being bent back by latent friction.

The motion of a floating body in the stream of advancing waves is very peculiar. A piece of wood thrown in at A, just in front of the advancing wave, No. 1, is for a moment carried forward by it, but the slower lower stratum gains the mastery, and the wave advances in front of the wood, which is successively found at B, C, D, E, &c. *relatively* to the advancing wave-heads, the floating wood recedes up the stream, though actually advancing at a rate between that of the upper and under or ground current.

The waves occur at intervals of about 40 feet, and occupy a trifle over 3 seconds in passing over the space that separates them.

Of the motion of the stream over the steeper slope of about one in nine, the following particulars were noticed:—

A floating body travels at the rate of 12½ feet per second. The wave-heads were less clearly defined than on the less steep

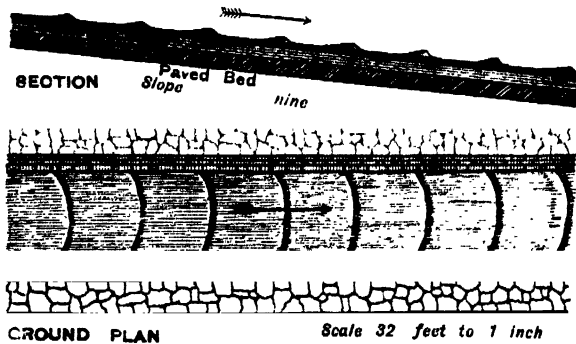

incline, and it was difficult to accurately measure their rate of advance, but as in the other case they rapidly overshot a floating piece of wood. They occur at much shorter intervals (about 12 feet) than on the less steep incline.

GEORGE MAW

Interlaken, June 28

I may mention that my observations referred to by Mr. Maw were made upon the current of the River Severn with a view to

explain the cause why the men who navigate the barges, in descending this river by the force of the current only are enabled to steer with a moderate degree of effectiveness. The power results from the different velocities of the current at and beneath the surface. A little below the surface, roughly speaking at about one-fifth of the actual depth, the current seems to have its maximum velocity, and consequently the hull of the vessel floating down the stream is immersed in water flowing more rapidly than that at the surface, on which the rudder for the most part acts.

I was enabled to demonstrate this fact by the following simple experiment. Having noticed that leaves of trees, after lying for some time on the ground and nearly saturated with water, become almost of the same, and after a longer time of greater, specific gravity than water, it occurred to me that such leaves, while in the first-named stage, would show what I desired to know, namely, the relative velocities of the stream at different levels below its surface. Two straight bars of wood, each about thirteen or fourteen feet long, were tied together at one end, between the two the foot-stalks of a number of poplar leaves were inserted (this kind was chosen because of the length of the footstalk for insertion between the bars, and its brightness of colour rendering it more visible in the depth of the water); the bars were charged with the leaves at intervals of about three inches, and then, choosing a place where the river was of suitable depth, the bars charged with leaves were plunged into the water, the connected ends touching the ground. The water was so clear that every leaf remained visible; then I opened the ends of the bars at the surface, and was gratified by seeing every leaf floating away and preserving as to depth very nearly the same relative position. Floating with the stream in my boat, I soon saw those nearest the bottom gradually lagging behind, and still more was I gratified when, after proceeding about forty yards, the leaves that were about two feet below the surface had distanced those at the surface in an unmistakable manner by at least three feet, the current being about four feet per second. The whole series forming a curve as is here shown.

Greatly pleased with this first experiment, I was not satisfied till I had repeated it again and again, not only on that occasion, but when the wind was blowing down the river, and therefore should have accelerated the leaf at the surface, which it undoubtedly did; but only the leaf on the surface, and that to a much smaller degree than I expected, and it left unaffected all that were beneath. A calm day is the best for this experiment, because the ripple renders it difficult to see below the surface. The water must of course be clear, a condition with which we are much favoured in this river. Mr. Maw's observations of the different velocities of the pieces of wood and the wave heads are quite in harmony with mine; the depth of the water in the stream at Merlign would be only a few inches, and pieces of wood were immersed so deeply that they would be more affected by the retarded current four-fifths below than by that one-fifth at the surface.

J. P. G. SMITH

Sweyne Cliff, Coalport, Shropshire

### Ocean Swells

THE late melancholy accident in Fingal's Cave, Staffa, by which three lives were lost, when several visitors to the island were washed off the railed ledge by a large wave which suddenly and unexpectedly broke into the cave, leads me to submit the following account of a somewhat similar wave and on the same part of the coast.

On the 4th inst. I took a small 5-ton sailing-boat from Oban to the Island of Lismore. We had a steady south-west breeze, going there with an even slight swell in the more open part, coming up the Firth of Lorne from the Atlantic. On our return the wind dropped to a dead calm and shifted to the south-eastward, so that to get back we took to the oars, the water becoming perfectly smooth as we neared Kerrera (between 5 and half-past 5 o'clock), when, standing at the bow, and looking seaward, I was surprised to see a broad wave or long swell coming from the south-westward, followed by two minor undulations. They



passed the boat, which rose and fell to them as they swept on. Ahead was the small island near the north-west entrance to Oban Harbour; Kerrera Island was close on the right or star-board bow. The sea was so calm, there was no sign of wash on either shore. As the wave rolled in I watched it, and after a few seconds the white line of surf became visible and the noise of the same following told of its breaking on the rocks with some violence. It was not the wash of any steamer, as the boatman at first unthinkingly surmised, for in the first place it was too broad a dome of water, many of our boat's lengths, into which the few short waves even of the largest steamers could not resolve themselves; secondly, there was no steamer in sight, nor had any lately gone by, save the Duke of Argyll's steam yacht, which had passed near us more than half an hour previously.

Such a wave could not have originated in the narrow channel between Mull and the mainland, but must have come in from the Atlantic, and had its origin, I imagine, in some far distant submarine disturbance. I have seen a report in the papers of an earthquake in Jersey, and I am informed by some friends lately returned from Cornwall (near St. Michael's Mount), that on August 26, about 4 p.m., when watching a seine net being pulled ashore, a wave larger than usual—described as a long black line, seen for a long time—rolled in. Perhaps others may have noted similar waves at other parts of the coast, and been able to record the exact time.

I. H. GODWIN-AUSTEN

Deepdale, Reigate, September 9

### Salmon-Breeding

ON August 28 an examination was made by Lord Lauderdale's fish-rearing ponds at Howietoun into the condition of the young salmon and hybrid Salmonidæ, and with the following interesting results:—

A hybrid was taken from Pond No. 3 which measured 6.5 inches in length; it was one of about 190, all much the same size, which were raised from the eggs of the Lochleven trout fertilised from the milt of the American char, *Salmo fontinalis*, on November 15, 1882. The specimen was a male with the milt nearly fully developed; the fish would evidently have bred this winter.

A hybrid was removed from Pond No. 4 which measured 7.5 inches in length; it was one of about 90, and raised from the ova of the American char milted from a Scotch char from Loch Rannock on November 15, 1882. It also was a male with the milt as fully developed as in the preceding hybrid.

Segregation in these ponds has been most rigidly carried out, and the results show that trout and char, or two species of char, will interbreed and give fertile offspring. A few more months will decide whether the females are as forward as the males, and whether the milt itself is prolific or not so; also to what extent hybrids will interbreed.

A hybrid was removed from the Octagon Pond at Craigend which measured 6.5 inches in length; it was one of 212, and raised from the ova of the Lochleven trout, fertilised by salmon milt on December 24, 1881. It was a barren female; whether any will be fertile time will show.

A grilse was taken from the salmon pond at Howietoun which measured fourteen inches in length; there are a large number, but they are in too deep water to count. These fish were raised from the ova and milt of pure salmon taken from the Teith in December, 1880. The specimen was a female, with the ova well advanced, being 0.1 inch in diameter, and would have bred this season. This fish was well nourished, with eleven rows of scales between the adipose dorsal and the lateral line, and sixty caecal appendages. This solves the question that our salmon may not only be reared in a healthy state in suitable ponds of fresh water, but also, if properly cared for, will breed without descending to the sea. Last year the milt of the pars from this pond were successfully used for breeding purposes.

FRANCIS DAY

### Hydrodictyon in the Eastern Counties

It may interest some of your readers to know that *Hydrodictyon uriculatum* (Roth), reckoned by Dillwyn among the rarest of the fresh-water Algae, and now generally described as confined to the ditches and pools of the Midland and Southern Counties of England (W. J. Hooker, 1833; Harvey, 1841; Hassall, 1845; and Griffith's "Micrographical Dictionary," 1883), can again be claimed as an inhabitant of the Eastern

Counties. A few days ago I found a fine and well-grown specimen in the river just above the well known sluice at Downer.

In the earlier half of the present century Cambridge seems to have been the centre for its distribution. Dillwyn, in 1809, relates that he received his specimen from the pool of the old Botanic Garden. Harvey, in 1841, says that he has fine specimens from Prof. Henslow, gathered in a pond in the Botanic Garden at Cambridge, where the plant has existed for many years. Hassall, in 1845, repeats Harvey's words, again on the authority of Prof. Henslow. Since that time it appears to have become completely extinct in this neighbourhood. The Curator tells me that two or three years back an attempt was made to introduce it into the pond of the new Botanic Garden, but without success. It is, I think, therefore worthy of record that this remarkable plant, so interesting to the biologist, has been lately discovered, apparently naturalised, at the bottom of the Ten Mile River, about twenty yards from the tidal waters of the Ouse.

The reappearance of *Hydrodictyon* on the fens round Cambridge is also interesting from the hope it inspires that, owing to the increased facilities for investigation now afforded by the University, further light may be thrown upon its singular cycle of development which, notwithstanding the labours of Areschoug, Cohn, Pringsheim, and others, must be said to be still somewhat obscure.

J. C. SAUNDERS

Downing College, Cambridge, September 4

### The Sky-Glows

THE sun-glow phenomena have entered upon such a fresh phase that I venture to send some extracts from my notes. It is not simply a renewal of the sunsets of last season, although that in itself will doubtless seem remarkable to those who have not noticed the almost constant occurrence of the "day glows" throughout the summer; the chief point is the radiating character.

September 11.—Glow 6.50 p.m. At 7 a vertical bar 2° to 3° across at base, to altitude 20°. Another at angle 45° to north; at 7.3 a third at angle 30° to north. The three faded at 7.5, 7.7, and 7.10.

September 12.—Sun seen to set by 6.20. At 6.35 ruddy tint above earth shadow in east; gone at 6.45. 6.50, fine glow from north-west to south-west, up to 30°; 6.55, very fine, up to 35°; much purple. Gradual change to low orange glow by 7.4, this fading by degrees, but partial return at 7.9; little left at 7.19.

September 13 (sunrise).—4.57 a.m., lovely orange glow and reflection in west. Cirri bright. 5.0, pink shot up vertically (in inverted pyramid) to height of Jupiter. 5.05, bar at angle of 45° to north. 5.5, whole north-east to south east suffused, broken by dark bars, four to north, five to south, radiating from sun. Central mass now 5° to 10° above Jupiter. Cirri now dark at east, but slight tint near Venus (these proved to be higher and more feathery, the others about 7° or 8° above east by north, approaching to cirro-strati). 5.7, now five bars to north, seven to south. Light wider spread, now to level of Venus (roughly measured as 35°). Soon traces even to 45°. Bars very marked; one from east-north-east reaches north-north-east, at altitude about 22°. Low cirri now re-lit. 5.15, whole mass now barred; nine to north, and two new ones to south of centre, but lower part to south now gone. Cloud over Venus now re-lit. 5.20, going to west window find marked counter-glow, also barred, radiating from perspective just like bands of cirrus, yet marvellously clear sky. Four dark bands to south, five to north, wider than those seen in east, and definition much less distinct. Rosy tints now gone. A ruddy tinge almost from south to north above earth-shadow, except just south of due west, whence rose a broad dark vertical bar. Faint cirri to south now lit up. 5.28, bars to north and south still visible, and no glow above earth-shadow at anti-solar point. Glow lasting at 5.30. Cirri in east quite dark again, but the cirri near Venus and to south white. Former now in vertical lines, but upper edges blown in wisps towards north. 5.40, stratus low in east by south. A greenish cast given to Venus and Jupiter when the glow strongest. Rosy glow at times noticed during the day. Sun rose about 5.50.

Sun set before 6.20.—6.35, ruddy tinge along east horizon, keeping above earth-shadow as it ascends. 6.45, cirro-stratus 5° to 10° above horizon, due west again lit up bright (first at 6.30) for two or three minutes, quickly followed by rosy glow in clear sky, and three central bands, divided by narrow dark bars,

and corresponding to the single mass on the 11th. 6.53, seven bands to south, a fine trio at an angle of  $45^\circ$ , five to north, much less distinct. No sign now of counter-glow. 6.55, orange next horizon; bars to south as bright as the vertical mass. 6.58, all fading; at no time reached beyond  $25^\circ$  altitude. 7.1, only the bases left of five bars to south, three vertical, and three to north. Positions show well the place of the sun below the horizon. 7.3, rose tints quite gone; none of last night's purple at all. 7.6, the cirro-stratus again tinged at edges. 7.9, as orange fades, last vestige of bars goes; stratus forming; the cirro-stratus still lit up. Sky very clear for York; none of the hazy clouds which accompanied the glows last season. 7.15, still red tinge along horizon.

September 14, morning, 5.7.—Find sky bright on waking; rose above, orange to greenish, yellow below; orange most marked, but rose wider spread, involving Venus, which, with Jupiter and moon, showed complementary effect. Only one dark bar, low down to north. Coloured area increased up to 5.15; fairly bright at 5.20; perceptible at 5.25. Counter-glow very marked at 5.20, massed above earth-shadow at anti-solar point, just where, yesterday, there was no uddy tinge. No cirri about, only light scud low down to east, from north to south. Very clear.

This evening (14th) scud covered the sky a little before 7, and, so far as I know, nothing special was observable. Is it possible that the bars were due to shadows thrown by cirri below the horizon?

J. EDMUND CLARK

Bootham, York, September 14

THE following observations of the warm, yellow circle about the sun, unusual colours of sky and cloud, &c., may interest some of your readers just now. The beautiful, warm, yellow solar halo, silvery white within, was seen on the following dates, usually a little before, during, or after sunset:—May 18, 19, 24; June 11, 25, 26, 27; August 14, 19, 24, 27, 29; September 1, 3, 4, 5. On two occasions, in cloudless sky, the halo was visible from noon to sunset. Unusual and beautiful colours were seen near the sun on August 24, at 3 p.m., September 1, 3, and 5. The colours were first noticed at 2 p.m., November 26, 1883. The extraordinary sunsets began here in November 1883; the dates are as follows:—

1883.—November 6, 14, 25, 28; December 1, 3, 4, 5, 11, 15, 16, 17, 18, 19, 22.

1884.—January 5, 11, 15; February 15, 24.

The colours at sunrise were very fine on November 4, 29, and December 4, 9, 19, 1883; January 12 and February 9, 1884.

J. GLEDHILL

Mr. Edward Crossley's Observatory, Bermerside,  
Halifax, September 10

EVEN last evening the glow was very marked. At 5.6 a belt of orange-colour lay on the horizon near the point of sunset, having a breadth of  $4^\circ$ . From this base shot up the bluish-white cone, while on each side (south-west and north-west and skirting the horizon) the sky had a smoky-brown aspect. The whole was overtopped by an arch of a pale smoky-pink hue, the outer circumference of which reached an altitude of about  $30^\circ$  as measured from the horizon. At 5.8 the bluish-white cone had become more intense, and the eastern sky was of a pale green. At 5.12 the bluish-white cone, with brown sides and orange base, was very distinct. At 5.14 I noted a long ellipse of intensely blue sky, the meridian forming its major diameter. On each side, west and east, were areas of bluish-white, the latter apparently being a reflection of the former, and having a base on the eastern horizon of dull greenish-brown. At 5.21 I examined the sunset sky with the spectroscope. The low sun-band was becoming dark; the merest possible vapour shading appeared, detached, to the left of D, the little "c" lines were clear, and B (dry gas) intense. At 5.31 the low sun-band had become much deeper. By 5.38 a secondary glow had appeared: pale lemon extended for some  $7^\circ$ , overtopped for the next  $20^\circ$  by an intense smoky-pink, the opposite sky being a dull green, while that immediately above the horizon south-west and north was brown, and the landscape was tinted with a warm glow. The little "a" band was now intense, so also was the low sun-band, and all trace of vapour effects to the left of D had vanished. At 5.43 the glow was "settling down" and had a total extension of some  $14^\circ$ ,  $7^\circ$  of orange and  $7^\circ$  of green. The whole thing finished off with a belt of pale sea-green about  $10^\circ$  in diameter shortly after 6 o'clock.

I have taken a great number of observations *in re* since my arrival in Australia last December, and am now collating them in accordance with the request of the Editor of NATURE (vol. xxix. p. 157). In a word, I am at present strongly in favour of the volcanic hypothesis, and claim to have sufficiently shown in a paper recently delivered before the Royal Society of South Australia that the relatively high pressure prevailing over the low pressure of Southern Asia at the time of the eruption prevented the dust from reaching India, so as to produce the effects of the "glow," until the lapse of a fortnight, and that the dust travelled westwards and southwards aided by the rapid equatorial rotation of the earth and the vertical distribution of pressure in oceanic regions south of the Line.

CLEMENT L. WRAGGE

Torrens Observatory, near Adelaide, July 31

P.S.—I have repeatedly observed the "glow" in broad daylight, and it is now (noon) visible as a bluish-white glare.—C. L. W.

LAST year, when staying at this place, I was much struck by the clearness of the air, the deep blue of the sky, and steadiness of the stars. Moreover I used to notice on every clear day that the highest cirri, when near the sun, exhibited very beautiful spectrum colours. They did not behave as I have seen them behave once or twice in England, viz. take up all the colours in regular succession as their angular distance from the sun altered; but each cloud exhibited the colours in an apparently irregular manner that reminded one of the appearance of mother-of-pearl. This year it seems to me that the air is of a less deep blue, and on every clear day there has been a very marked reddish glow all round the sun. This red glow in the midst of what would otherwise be a pure blue sky has been very noticeable. It has nearly, though not quite, "swamped" the diffraction colours spoken of as so remarkable last year. W. LARDEN

Avolla, Sion, Canton Valais, Switzerland (about 6500 feet)

### Pipe-Clay

I WAS forcibly struck the other day by the analogy between the beds of plastic clay (called here pipe-clay) which are everywhere met with interstratified with the different drifts of wash-dirt, river-sand, &c., in the tin-mines about this country, and what was then to be seen in our own mine here. The mine had been under water for about a month. On pumping the water out, we discovered a layer of particularly fine, soft mud, four inches in depth, of about the consistency of cream. It is evident that any animal or vegetable substance dropping into this layer would sink through it and rest on the bottom. The pipe-clay contains no fossils except portions of trees which rest on the bed beneath it. Now, from the evidence before me here, I am led to the conclusion that the beds of pipe-clay were formed under like circumstances as these. The old torrents which brought the drift down from the mountains were undoubtedly continually changing their paths as they traversed the valleys, being dammed by accumulations of timber and boulders, thus causing the diversified and mixed-up appearance of the beds, some of them containing huge trees and heavy stones: these are the beds which contain the richest deposits of tin ores, others being beds of fine quartz sand, with beds of materials graduated between the two descriptions, and the beds of pipe-clay interspersed. These last vary considerably in depth. I have seen them all thicknesses between one inch and twenty feet.

The beds containing heavy materials were undoubtedly brought down by tremendous torrents caused by heavy rain-falls; the lighter materials by the shrunken torrents during dry seasons, or from a diversion of the course of the main stream. If this is the case—and it seems to me most probable—I think that it is a fair deduction to say that the pipe-clay was deposited in ponds left by the decreasing torrents in their periodically-used channels, which ponds would probably be perfectly still water, and favourable for such a deposit, in the same way as this mine was in a position favourable for the deposit of four inches of slimy mud in a month. I am at a loss to account for the fact that these beds (of finer materials) do not contain any animal remains. The heavy beds contain very much heavy timber, but of course all smaller and more delicate animal or vegetable remains would be smashed up here: this does not, however, apply to the other beds, if my theory is correct, and yet no

fossils are to be found here, nor can I hear of any having been found elsewhere.

With reference to the suggestion of the Rev. J. E. Tenison-Woods (*NATURE*, May 22, p. 76), that the tin is probably derived from below the gneissose formation and above the granite, this seems to me a most probable conclusion, although I have seen no more of the clay-slate than water-worn blocks mixed with the blocks of quartzose granite in this mine; but I do not feel quite certain that the so called laterite is derived from this clay-slate formation, as it contains very much quartz sand, and, so far as I have seen here, nothing that resembles a sand resultant from the decomposition of the clay-slate.

I was over in Kintaah the other day, and heard of a hot spring at a village called Sempan, near Ipoh; there are, I believe, several others about in the peninsula, and I understand that sulphuric acid is emitted from the bottom of some of the mines at Lahot, especially M. De la Croix'. These are the only signs of volcanic action since the granite that I have heard of or seen.

In conclusion I cannot help indorsing the Rev Tenison-Woods' opinion that there are great quantities of tin here only waiting to be worked.

A. HALE

Ulu Bakow, Perak River, July 25

### Repulsion

SIR W. THOMSON, in his address at Montreal, asks: "May it not be that there is no such thing as repulsion, and that it is solely by inertia that what seems to be repulsion is produced?" And he proceeds to illustrate this by the case of two mutually attracting bodies approaching, then dashing past one another in sharply concave curves round their common centre of gravity, and so flying asunder again. He adds that this idea was suggested to him thirty-five years ago by an observation of Sir H. Davy. And I think one may gather that his impression is that it is one that has not presented itself to other minds in the interval.

I cannot but think that such an idea must have been "in the air," among mathematicians, from the time when first any similarity was thought of between the action of molecules and masses. At any rate, I certainly never read Davy at first hand, and yet, in 1874, I published an "Elementary Exposition of the Doctrine of Energy," intended for schools (which I fear fell dead from the press), and in a section on "Molecular Theories" I wrote as follows:—

"Two bodies subject only to their mutual attraction, if their motions at any one moment are not in the same straight line will never come in contact. . . . The orbit may be like a comet's, very nearly a straight line in the greater part of it, turning sharp round at each extremity, . . . at the nearest with enormous impetus. This shows that what we call elasticity in a mass may, wholly or in part [this was meant to exclude the case of *direct* collision, as to which Sir W. Thomson also enters a  *caveat* ], be the result of attractive force combined with motion. A blow given on the surface of the solid mass drives the particles inwards; but the result may be a pirouette round some of their inner neighbours, and an equally strong outward impetus driving back the hammer with an energy proportionate to that which it had given."

My intention in that section was to excite thought in school teachers and apprehensive and energetic scholars; but I did not imagine I was starting a novelty. He who propounds a working hypothesis of molecular action in which this idea plays a part will have the whole credit.

D. D. HEATH

Kitlands, Dorking

### Fellow-Feeling in House-Flies and Swallows

THE moral feelings of animals being as interesting as their intelligence, perhaps the readers of *NATURE* would care to hear of a curious instance that I just now witnessed of fellow-feeling in the common house-fly. A number of them had collected in the top of a window, and I was about to open it to let them out, when I saw a wasp seize one, as I have seen many seized this year, but never before, though I have often seen them feed greedily on maimed bees. The wasp was about to sever the head from the body of his victim, when a fly—by no means a large one—flung itself violently against the captured one, trying apparently to knock it away from the wasp; it did not attack the wasp. This was done again and again, whether by the same fly or another I could not tell, the action was so rapid; at

last the body of the fly was knocked away, but the wasp retained the head and devoured it. It then grasped another, and again a fly dashed at it, and another, and another, though they were all evidently afraid of the wasp; and no wonder; it seemed very fierce and hungry. The action of the flies was quite unmistakable. I called another person to watch it with me, and she was as much surprised as I was, and inclined to kill the wasp; but I thought we could spare a few flies, notwithstanding this unexpected discovery of fine feeling in them, and I would not let her disturb the balance of Nature.

I was once a delighted witness of a still more curious instance of fellow-feeling in some young swallows. Six of them were sitting on a low roof, and were being fed by the old bird, who flew by from time to time, and put something into one or two of the open beaks. Each time, as soon as they saw the parent coming, which was some time before I did, they all stood up, whirring their wings and chattering; all, that is, except the last but one, and that seemed to be weak and unable to rise, and so got nothing. At last the two that flanked it, after a great deal of chattering over it, managed to raise it up by putting their beaks under its little white bosom; and then and there the dear little brotherly things wedged it up between them with the prettiest air of compassion and patronage, so that it had a fair chance with the others. And it seemed quite a chance which was fed, yet all sat down apparently perfectly contented and good-humoured afterwards. It was a pretty sight, and I was grieved when, some boys coming by, they took to flight.

Sidmouth, September 13

J. M. H.

### Rainbow on Spray

THE appearance noticed by "G. H." in last week's *NATURE* (p. 464) is a well-known sight at sea under certain conditions. I first saw it from the deck of the Anchor Line s.s. *Bolivia*, about two hundred miles east of Cape Cod. It lasted for half an hour between 10 and 11 a.m. The sea was going down after heavy weather: the sun was shining brightly in a clear blue sky, with light, fleecy clouds scudding along. A fresh westerly breeze cut the tops off the rollers and cast the spray high in the air. When the procession of waves passed through an area more or less opposite to the sun, their crests took up beautiful rainbows; there were thousands of them, and as the steamer rolled and pitched, the changing angle caused the spray on some waves to take more of one or other primary colour, seeming now blue, now red, and again yellow golden.

Leeds, September 13

FRANK E. CANE

### JAPANESE EDUCATION

THE Japanese Government, having decided to take a more prominent part in the Health Exhibition than they did last year in the Fisheries—due, we believe, in the latter instance to the fact that they had a Fisheries Exhibition of their own in Tokio at the same time—have appointed a Commission to superintend the Japanese Section, among the members of which is Mr. S. Tegima, the Curator of the Tokio Educational Museum, who has been specially appointed to superintend the Educational Section. To accompany the exhibit in this Section the Government have published a little hand-book, which has been reproduced in the *China Telegraph*, and which contains the most exhaustive account of modern Japanese education, its system, and results, that we have seen in any European language. The Annual Report of the Minister of Education is little more than a mass of statistics; the number of children attending primary, secondary, &c., schools for some years past is carefully given, but we are left to guess at the subjects taught and the course of instruction in these establishments. We are not grumbling at the Report on this ground; it is what it professes to be; we merely desire to point out the special interest of the present little work. The Japanese can look back with pride on a large—a very large—portion of the national work of the past fifteen years; and in education, whatever it may have been in other departments, there has never been the slightest faltering or doubt as to the wisdom of extending the benefits of an improved system to every village and hamlet in the Em-

pire. And perhaps the statesmen who have steadily pursued their policy in this respect when the cry for economy, even at the expense of efficiency, was rising round them, have their reward even now. A Minister of State who recently visited Europe, talking to an English friend of the future of his country, stated that in Japan they trusted to their system of popular education acting on the intelligence of their people to prevent the spread of revolutionary doctrines; the schoolmaster was abroad in the land, and its rulers could rest safe from that danger at least.

The Education Department in Japan is one of the ten principal offices of State, its head ranking as a first-class Minister. It has the usual staff of Vice-Ministers and Secretaries, who carry on the business, and from time to time visit and inspect the various districts. All the local governors are, in educational matters, directly under the control of the Minister. The salaries of professors range from about 1000*l.* per annum (foreigners probably) to 250*l.*, and those of teachers from 100*l.* to 30*l.* The latter are, we believe, considerably higher in proportion than those of Board-school teachers in this country. School text-books are chosen with great care, and by the Department itself; indeed almost all the books are compiled and published by the Government. In the capital two establishments have been organised in the interest of education—one a library where works in all languages are collected, and placed, under certain slight restrictions, at the disposal of the public; the other the educational museum, in which objects necessary to general education are collected for the benefit of those engaged in it. The rules by which all schools are governed, whether they are local, general, or private, appear ultimately to come under the notice of the Minister of Education for his approval, so that the administration is a highly centralised one. An important feature of the work is the number of students sent abroad by one or other of the Departments of State. The Education Department has sent fifty in the past seven years, and there are at present twenty-two abroad, of whom seventeen are in Germany, one in Austria, two in England, one in France, and one in America. All these are graduates of the Tokio University, who were specially selected by the Minister of Education for the purpose of being sent abroad. The great preponderance of these in Germany is remarkable, and would appear to show that the Japanese are inclined to discard English and American educational institutions (which have had their day in Japanese estimation) for those of Germany. On the other hand, it may be that those are mostly medical students, who have from the beginning been sent to German Universities. Before coming to the various classes of schools, the statistics had perhaps better be given. The following are for 1882, the details for 1883 not being yet forthcoming:—

	Number	Professors and Teachers	Pupil-
Elementary schools	28,908	76,769	2,616,879
High schools	173	934	12,315
Normal schools	71	602	5,275
Universities	2	135	2,035
Technical schools	98	975	8,829
Other schools	1,026	2,598	72,260

Of the 2,616,879 pupils at the elementary schools, only 733,691 are girls. Nearly the whole of these schools are maintained by the various local Governments, *i.e.* out of local, not Imperial, taxes. The whole system is administered under a code first promulgated in 1872, re-issued in an improved shape in 1879, and again revised in 1881.

The lowest schools of all are the Kindergarten, where children under school age are taught for three years reading, writing, ciphering, embroidery, paper-plaiting, drawing, &c. The next grade is the elementary schools, where a general education is given, and at which attendance is compulsory. The district for such a school varies with

the population and resources; but theoretically, and as a rule in practice, one exists in every ward and in every village. The course of these schools is divided into lower, intermediate, and higher grades. The lower grade course comprises the elements of morals, reading, writing, arithmetic, singing, and gymnastics; the intermediate, besides these, includes geography, history, drawing, physics, and natural history; while the higher grade adds chemistry, geometry, physiology, and political economy. Teachers receive certificates either for a certain class of schools or for a special subject from the normal schools, or from the local inspectorates. Committees or Boards, similar apparently to our School-Boards, are formed in each district, but their functions are limited to seeing to the attendance of the children, and they seem to have no power over the finances of the school. The next grade of schools is the "middle schools," organised in each district according to the local conditions and demands. Their object is to give higher instruction in the ordinary branches of study, so as to prepare students for liberal pursuits or for the more advanced schools. In addition to the subjects already specified, we find the middle-school course including elementary mathematics, natural science, geology, Japanese law, and one European language. To provide a model for these schools, the Minister of Education established a middle school at Osaka, to which reference can be made. There is only one University, that of Tokio, with four departments, law, science, literature, and medicine. Nothing need be said of this, as it is organised in the usual way. There are two preparatory schools for it, and the department of science appears to be well equipped with astronomical and meteorological observatories, botanical gardens, and museums.

In addition to these, which may be called the ordinary educational institutions, there are special colleges attached, or under the control of certain Departments. Such are the Military Academy, the Engineering College, the Training Schools for the Navy and Army, the School of Marine Engineering, of Forestry, Law, Telegraphy, &c. The normal schools for the training of teachers should also be noticed. They are established in almost every district, and now number seventy-six. The Government has provided two model normal schools in Tokio, one for male teachers, the other for females, and it is worth noticing that the latter was opened by the Empress herself. There are two schools of agriculture, one near Tokio, the other at Sapporo in Yezo. In the former the students are instructed in the science of agriculture, in veterinary science and agricultural chemistry, while in the latter stock-rearing and cultivation are taught.

These appear to be the chief features of the Report, and it is much to be wished that the compilers had given some information regarding the part played by Europeans in Japanese education. A comparative statement of the number of Europeans employed in the Department or in local schools eight or ten years ago, and now how far the posts they occupied have been abolished, or occupied by Japanese found suitable for the work, would have been interesting.

#### BRITISH BIRDS AT THE NATURAL HISTORY MUSEUM

VISITORS to the new Natural History Museum can scarcely have failed to notice the many improvements which have been made in the re-arrangement of the zoological collections since their removal from Bloomsbury to South Kensington. Not only is there greater space now available for exhibiting the contents of each gallery, but a large proportion of new specimens have been introduced into the cases.

It is of course not to be expected that stuffed animals, however well preserved, will last for ever, and some of the

specimens in the national collection are considerably more than a hundred years old. A certain amount of "weeding out" from time to time is consequently unavoidable, and is by no means so easy a process as might be supposed. The preservation of "types," that is, of the original specimens from which the species were first described, has very properly been considered of great importance; they have been withdrawn from exhibition and exposure to light, and relegated to the study series; but old and badly-mounted specimens of no historical value have been discarded, and their places filled with recently-obtained fresh examples of the same species, preserved and mounted with all the skill which modern taxidermists have been able to bestow upon them.

The Osteological, Cetacean, and Coral Galleries contain collections which were but incompletely represented in the exhibition rooms of the old building, and in fact, offer to the visitor entirely new exhibitions, of which those who have been engaged in their formation and arrangement may well be proud. None of these, however, appeal by their direct instructiveness to the British public, or are appreciated by them so much as the series of groups of British birds illustrating their mode of nidification, which is placed on the right and left of the central hall.

Here the visitor finds a collection of British birds, in which each species is separately represented by a pair of old birds in the plumage peculiar to the breeding season, with its nest and eggs, not merely in a natural position, but in the actual position in which they were found; the arboreal birds being placed on the identical branches which they themselves selected for nidification, the ground breeders remaining on the actual patch of ground, whether grass-grown or heather-clad, in which they had designed to rear their young.

It is needless to enlarge upon the advantage to be derived from a lesson thus accurately imparted, or upon the excellent opportunity thus afforded for comparing the variation in structure of nests built by birds belonging to different orders and families. As an aid, also, to the identification of the owner of a nest unknown to the finder, the series is a useful one, and will become more so as the collection is extended, for the process of forming and preparing such a collection must be slow. It is nearly four years ago since Dr. Günther commenced its formation, and without the aid of ardent lovers of nature like Lord Lovat, Mr. T. Harcourt Powell, Mr. D. Parker, Colonel Irby, and especially Lord Walsingham, it would have been impossible for him to have made this series, as it is, one of the most instructive attractions of the Natural History Museum. As for ornithologists, it is difficult to say where the interest ceases.

Not very long since Mr. H. Seebohm gave a lecture at the Zoological Gardens on "Birds' Nests," and could he have pointed to these beautifully-mounted cases at South Kensington, he would have had the most appropriate illustrations possible to his discourse.

From an attentive study of the subject he considered that nests might be roughly grouped into five classes, according as the birds which owned them relied for the safety of their eggs: (1) on the concealed position of the nest; (2) upon the inaccessible position of the nest; (3) upon the protective colour of the eggs; (4) upon the protective colour of the sitting hen; (5) upon their own ability, either singly, in pairs, or in colonies to defend their eggs.

Illustrations of all these five classes (and Mr. Seebohm might have added a sixth, viz. contrivances employed for concealing the eggs on the bird leaving its nest) may be seen in the British Museum cases, and furnish as good a basis as any for studying the series.

Starting from the entrance to the Mammalia Gallery, and proceeding towards the staircase, we at once come upon several cases of birds which rely for the safety of

their eggs upon the concealed position of the nest. Here we find a pair of dippers with their nest of green moss most skilfully constructed and domed, placed just under a moss-grown stump overhanging the water. Patches of the same moss around and about the stump deceive the eye and render detection of the nest very difficult, unless the bird is seen to leave or enter it. A section of the nest, represented by an illustration, shows a curious feature in its construction. It is not only cup-shaped and domed, but the front edge of the cup curls over towards the centre of the nest, as if to protect the pure white eggs from any drip or spray from the stream in whose banks the nest is placed.

Close to this group we find two cases of woodpeckers, the green woodpecker or "yaffle" and the greater spotted woodpecker, both of which deposit their white eggs in the hole of a tree, the aperture of which as a rule is only just large enough to admit the bird, and consequently the nest, composed of dry chips and bits of bark, is well concealed. But the woodpeckers might, with almost equal propriety, be placed amongst those birds which rely for the safety of their eggs on the inaccessible position of their nest.

It has been stated that as a general rule all eggs which are deposited in holes or in well-roofed nests are white, and certainly we have illustrations of this in the case of the dipper, woodpecker, owl, kingfisher, swift, sandmartin, and other birds; but, on the other hand, the jackdaw, nuthatch, tree-creeper, and various kinds of titmouse, all breed in holes and yet lay coloured eggs; while the pigeons, doves, grebes, and waterfowl lay white eggs in open nests; so that no precise rule can be laid down on this head.

Almost all the small passerine birds may be said to rely for the safety of their eggs on the concealed position of the nest; hence it is difficult to name any without giving a long list of names. In the Natural History Museum series the following examples may be noted:—The yellowhammer, with its nest of dry grass placed in a clump of dead furze, whereby a contrast of colour is avoided which might lead to the detection of the nest; the meadow pipit, with its nest concealed in meadow grass; the reed bunting, with its nest placed low down, to escape observation, in a clump of rushes. Were this nest placed higher up in a plant of such open growth, it would be sure to attract attention. In like manner the linnet and Dartford warbler in furze, the skylark, yellow wagtail, and whinchat in meadow grass, all furnish illustrations of variety in the art of concealment as practised by the tiny architects.

Amongst birds which rely for safety on the inaccessible position of their nest may be mentioned the hawks and owls, raven, chough, kingfisher, sandmartin, moorhen, coot, and grebe. There are few eggs more difficult to take than those of the peregrine falcon, raven, and chough, from the habit of these birds to nest in precipitous cliffs; the kingfisher and sandmartin, breeding in holes which sometimes extend several feet into a bank, and often not in a direct line, evidently imagine themselves safe from molestation; while moorhens, coots, and grebes, making slovenly-constructed nests upon soft, treacherous ground, or amongst sedges, flags, and other water plants which are unapproachable without the aid of a boat, afford another instance of how the same object may be achieved by a different method. One cannot fail to note that the more slovenly the nest of these water-birds the more likely is it to escape detection, for, were it well shaped and neat in appearance, its very neatness amidst a mass of wind-strewn rushes or tangled growth of water-weeds would be sure to attract attention towards it.

To give instances of birds which rely for safety on the protective colour of their eggs, we might mention the nightjar, peewit, stonecurlew, snipe, woodcock, ringed

plover, oystercatcher, the various species of tern or sea-swallow, and, generally speaking, all those birds which habitually deposit their eggs upon the ground, with little or no vestige of a nest.

Only those who have sought for and found the eggs of the peewit, stonecurlew, ringed plover, and oystercatcher can have any true idea of the remarkable approximation in the colour of the eggs to the ground whereon they are laid, the two first-named resembling the small clods and stones upon the fallows where they are found, the two last-named counterfeiting the freckled, water-worn pebbles of the beach.

Many of the above-named species and others are

already represented in the Museum series. The group of the ring plover with the newly-hatched young hiding between, and scarcely distinguishable from the pebbles, is charming by its simplicity; whilst the bit of Scotch moor with the woodcock's nest will arrest the attention of every sportsman whose personal experience of this bird has been limited to a glimpse of it in the shooting season.

If we look around the collection for instances of species which rely for the safety of their eggs on the protective colour of the sitting hen, we shall find excellent illustrations in the case of the pheasant and grouse, two of the most life-like groups in the series. In the former



Grebes and Nest

case we seem to have a little bit carved out, as it were, and carried away from an English wood in spring-time—primroses, bluebells, and all!

It is probable that in this same class we must include all the game birds, a large number of the passerine birds (excepting those in which, as in the tits, wagtails, pipits, larks, and some of the warblers, the sexes are alike in plumage), the woodcocks, snipe, and ducks. But of these, as will appear from our previous remarks, the passerine birds would as well rely for safety on the concealed position of the nest, and the woodcock and snipe, on the protective colour of their eggs.

In a notable essay entitled "A Theory of Birds' Nests," published some years ago, Mr. A. R. Wallace, amongst

other ingenious propositions, attempted to establish the rule that, in all cases where the hen bird is brightly coloured like the male (as in the kingfishers, woodpeckers, tits, &c.) nidification takes place either in a hole or in a roofed nest; while in cases where the sexes differ in plumage, and the hen bird is of a dull colour (as in the pheasants, for example), the nest is open and the sitting bird exposed to view.

This theory, though at first sight plausible, is really untenable; for the exceptions which may be brought forward in both classes are as numerous as the cases cited in support of it. On reflection it is apparent that jays, orioles, and pigeons (many tropical species of which are brilliantly coloured), according to Mr. Wallace, ought to

be found huddled in holes or in roofed nests, their eggs concealed from view; but, on the contrary, they build open nests, some of them, as with the pigeons, being very clumsy and conspicuous structures. On the other hand, birds like the creeper, nuthatch, wren, willow wren, and chiffchaff, with the hen birds of sombre colours, would be expected, on Mr. Wallace's theory, to build open cup-shaped nests wherein the sitting bird would be exposed to view; but the two first-named breed in holes of trees, and the others all construct domed nests. It would be easy to take exception to other propositions made by Mr. Wallace, and generally to combat his ingenious theory; but such is not our object here. We have referred to his essay rather for the purpose of redirecting attention to it in connection with the admirable series of birds' nests in the collection under notice which furnishes the reader with illustrations to many of Mr. Wallace's remarks.

As to the birds which rely for the safety of their eggs on their own ability to defend them, whether singly or in pairs or colonies, familiar examples occur to us in the partridge, peewit, and black-headed gull. There must be few observant naturalists who have walked abroad in the nesting time and have not witnessed and admired the extraordinary efforts made by some or all of these birds to decoy the intruder away from their eggs or young by feigning lameness, or to frighten him away from the spot by boldly dashing at his head with loud reiterated cries.

The group, of which an engraving is here given from a careful sketch by Mr. Charles Whympster, represents a pair of little grebes, or dabchicks as they are provincially called, at a pond-side, with their characteristic nest of weeds. The hen bird is just leaving the nest to join her mate, having hastily covered her white eggs to conceal them.

The taxidermist, it will be observed, in this case has been obliged to show them partially uncovered, in order to explain what otherwise might remain unsuspected by those who are unfamiliar with the habits of these interesting birds.

## NOTES

THE Queen has been pleased to confer the dignity of a Knight of the United Kingdom on John William Dawson, LL.D., C.M.G., Principal and Vice-Chancellor of the McGill University, Montreal, in the Dominion of Canada.

THE death is announced of Dr. J. J. Woodward, surgeon, United States Army, the well-known microscopist, whose admirable photo-micrographs, produced during his official connection with the Army Medical Museum, Washington, have given the pre-eminence to America for this branch of scientific microscopy.

THE Electrical Conference at Philadelphia has adopted resolutions that steps should be taken to legalise in America the ohm adopted by the Paris Conference, as also the ampere and volt, as electrical standards of measure. It was proposed by Mr. W. H. Preece that the Committee should consider the adoption of the English watt as a unit of power; this was also adopted.

PROF. ROBERT S. BALL lectured in Philadelphia on Wednesday night last week on the distances of the stars. He had a large audience at the Academy of Music.

THE first aerial voyage in England having taken place from the Honourable Artillery Company's ground at Finsbury on September 15, 1784, in the presence of the Prince of Wales, afterwards George IV., preparations were made to fittingly celebrate the 100th anniversary of the event, which occurred on Monday. A committee successfully perfected the arrangements for the ascent of three huge balloons from the grounds at the

rear of the Finsbury Arsenal, between 3 and 4 o'clock after 2 in the afternoon, just a century before, General Lussell, the secretary to the Neapolitan Ambassador in London, started upon the first aerial voyage performed in this country, and ultimately descended, at 20 minutes past 4, in safety in a meadow at Standon, near Ware, Hertfordshire. In the Long Room, Col. Beaumont, R.E., presiding, M. W. de Fonvielle, editor of *La Lumière Électrique*, delivered an address, in which he described the improvements made in the construction and the gear of balloons during the past century, particularly alluding to the improvements effected by the late Mr. Green, the inventor of the cone anchor, which had been the means of saving the lives of so many aeronauts when they drifted out to sea, and had been rescued by passing vessels. He spoke hopefully and sanguinely of the ultimate success of the efforts now being made by gallant French officers to steer balloons by the medium of electric currents.

A SECOND ascent was made on Friday at Meudon in Capt. Renard's new balloon, but this time without the success which attended the former experiment. There was a good breeze. On the previous occasion, it will be remembered, there was only a slight breeze. After resisting the wind and remaining stationary, or nearly so, for a few minutes, the balloon was carried in the direction of Versailles, and, on one of the batteries ceasing to work, descended near Versailles. From there the balloon had to be dragged back to Meudon. The inventors assert that, but for the accident to the battery, they would have returned to Meudon in the teeth of the wind.

M. REGNARD has made a series of experiments on living organisms under high pressures. Yeast was found to be latent after having been subjected to a pressure of 1000 atmospheres for one hour; an hour later it began to ferment in sweetened water. Starch was transformed to sugar by saliva at 1000 atmospheres. At 600 atmospheres *Algæ* were able to decompose carbonic acid in sunlight, but they died and began to putrefy after four days. Cress-seed after ten minutes' exposure to 1000 atmospheres were swollen with water, and after a week began to sprout. At 600 atmospheres Infusoria and mollusks, &c., were rendered morbid and latent, but when removed returned to their natural state. Fishes without bladders can stand 100 atmospheres, at 200 they seem asleep, at 300 they die, and at 400 they die and remain rigid even whilst putrefying.

WE observe that among the three recipients of the gold medals awarded by the University of Christiania is Prof. G. A. Gulberg.

A NEW enemy to the beetroot plantations has appeared in Scania (Sweden) in the shape of the spinach-fly (*Anthomyia spinarum*). It has previously been known as an enemy to spinach, but this year it has also attacked the beetroot plants. Dr. Holmgren believes that its appearance is only periodical.

ALTHOUGH a great deal has been done in Norway and Switzerland to examine and measure the glaciers in those countries, comparatively little has been done in Sweden in this respect. During the last couple of years, however, a glacialist, Dr. F. Svenonius, has been engaged in studying and measuring some of the glaciers in Norrland, and we now learn from the report of this gentleman that there are about a hundred glaciers in Sweden, but that they are very small, the whole covering altogether only nine square miles (Swedish). The area had previously been estimated at thirty square miles.

THE Corporation of Southampton have unanimously resolved to support the movement commenced by the Council of the Hartley Institution a short time ago, in favour of a revised Geological Survey of Hampshire and the Isle of Wight on the maps of the 6-inch scale. The Southampton Town Council will

It is stated that Mr. Gamel of Copenhagen has offered to send his steamship the *Dijmphna* on a second expedition to the Arctic regions *via* Franz Josef Land, subject to the condition that the Danish Government will, as a moral acknowledgment of their interest in the Expedition, grant a certain sum of money, however small, towards the Expedition, under Lieut. Hovgaard of the Royal Danish Navy.

THE present number of the *Proceedings* of the Natural History Society of Newport (R.I.) contains several papers on the geology of Rhode Island, and one on its birds. There are, in addition, papers on Mount Tacoma in Washington Territory, by Mr. Bailey Willis; on the migration of birds, by Mr. Taylor; and an account of a journey in North-Western Wyoming, by Mr. Wilson. Several of these papers are accompanied by maps or other illustrations; but unfortunately in most cases only abstracts of the papers are given, while in others we get only the titles.

"CONTRIBUTIONS to the Descriptive and Systematic Coleopterology of North America," Part i., is the title of a paper of 10 pages with one plate of details, by Thos. L. Casey, Lieutenant of Engineers, U.S.A. In it are described about sixty new species and some new genera. Lieut. Casey is, we think, a *debutant* in North American systematic entomology, which sustained so severe a loss lately in the death of LeConte; his descriptions appear to be carefully and minutely drawn up, and from his few introductory remarks he seems to be animated by the true scientific spirit, for he says of them: "If they even serve to identify the species, they may be considered to have done their duty."

It is known that Clymenias, so widely spread in the Devonian deposits of Western Europe, have not yet been found in Russia—with the exception, perhaps, of the *Clymenia undulata* in the hills of Kielce in Poland. Now, Prof. Karpinsky has discovered remains of this Cephalopod on the Asiatic slope of the Ural, near Verkne-uralsk (*Izvestia* of the Russian Geological Committee, 1884, No. 4). The Uralian fossil is very much like *Clymenia annulata*, Münster, and the few differences render it more like *Clymenia nodosa*, Münster, which is considered by Keyser and Gümbel merely as a variety of the foregoing. Another *Clymenia*, also found in the same locality, but in a worse state of preservation, seems to belong to *C. striata*. This discovery, while establishing one more feature in common for the Russian and West European Devonian, at the same time widens very much the area of distribution of the Clymenias, formerly so strictly limited to Western Europe.

A NOTE on a possible source of error in photographing blood corpuscles, by Mr. G. St. Clair, F.G.S., communicated to the Birmingham Philosophical Society, is a fruitless attempt to explain as an optical illusion Dr. Norris's asserted discovery by the aid of photography of a third kind of corpuscle in mammalian blood. The author invokes the principle of the formation of images by the passage of light through small apertures, and conceives that Dr. Norris's "colourless disks" are merely images of the end of the microscope tube or the aperture of the eyepiece, and he seems to have taken some pains to obtain such images by placing under the microscope a slide thickly strewn with small steel disks, and receiving the light on a screen beyond the eyepiece. Had he attempted to focus these ghosts and the real images of the disks *at the same time*, or considered a little more closely the elementary optical principles involved, we venture to say the note would never have been written.

qualities assigned to each year, month, and day, each of which is represented by one of twelve letters of the syllabary, seem to have some resemblance to the characters of the corresponding calendar animals—tiger, hare, dragon, serpent, &c. From the five syllabary letters corresponding to the year and month of conception, and the year, month, and day of birth, the chief points of a person's character are made out—the most important determining factors being the year of birth and month of conception. Then come to be considered the effect of the stars which are supposed to rule the years, months, and days. For each year there are nine stars, which have their special qualities; and each man's life is to be ruled by one of them. From the mutual relation of these stars, the life relations of two given people can be made out. One very important application of the system amongst the Japanese is the comparison of the ruling stars of two who are contemplating marriage. Similarly, as each instant of time is ruled by a star, it can be determined whether a given year, month, or day will be lucky or unlucky to a certain individual. The method of divination thus described was illustrated by examples, the author having worked out the horoscopes of Cromwell, Carlyle, Bismarck, Napoleon, and other historical characters. From the discussion which followed, it appears that this elaborate system can be traced back to the earliest period of recorded time in China. It is the so-called system of philosophy embodied in the "Yiking," the oldest of all Chinese books, and if it should turn out, as is contended by some eminent Chinese scholars, that this work is not Chinese in its origin, but Accadian, then Japanese divination would be a Western product.

THE *Japan Gazette* reviews a publication by the native Professor of Botany in the University of Tokio, entitled "Nomenclature of Japanese Plants in Latin, Japanese, and Chinese." The list, it appears, does not include all the plants indigenous to Japan, while it includes many which are in no sense Japanese. It is inferior to Franchet and Savatier's "Enumeratio Plantarum Japonicarum," for while the latter gives more than 2700 distinct species of indigenous flowering plants and ferns, the consecutive numbering in the native work only runs up to 2406, and this includes, besides many foreign plants, numerous mere varieties of species, to each of which a separate number has been appropriated. The author, Mr. Matsumura, is said to contemplate the publication of a more elaborate work.

THE additions to the Zoological Society's Gardens during the past week include a Purple-faced Monkey (*Semnopithecus leucoprymnus*) from Ceylon, two Laughing Kingfishers (*Dacelo g<sup>2</sup> antea*) from Australia, presented by Mr. D. Palgrave Turner; a Lesser White-nosed Monkey (*Cercopithecus petaurista*) from West Africa, presented by Mrs. E. A. Alldridge; a Cape Hunting Dog (*Lycan pictus*) from the South-West Coast of Africa, presented by Capt. J. Grant Elliott; a Tigrine Cat (*Felis tigrina*), two King-tailed Coatis (*Nasua rufa*) from Brazil, presented by Mr. James Meldrum; a Herring Gull (*Larus argentatus*), British, presented by Miss J. Dunford; a Yellow-fronted Amazon (*Chrysotis ochrocephala*) from Guiana, presented by Mrs. Frank Wilson; three Violaceous Night Herons (*Nycticorax violaceus*) from South America, presented by Mr. A. Boon; two Yellow-winged Sugar Birds (*Careba cyanea* ♂ & ♀) from Brazil, presented by Mr. P. A. Fraser; a Tuberculated Iguana (*Iguana tuberculata*) from Brazil, presented by Mr. J. H. Leech; a Brown Capuchin (*Cebus fatuellus*), a Weeper Capuchin (*Cebus capucinus*) from Brazil, a Malbrouck Monkey (*Cercopithecus*



*cynomorus*) from West Africa, two Victoria Crowned Pigeons (*Goura victoria*) from the Island of Jobie, deposited; three Ruddy Flamingoes (*Phaenicopterus ruber*) from North America, purchased; two Ring-tailed Lemurs (*Lemur catta*), a Great Kangaroo (*Macropus giganteus* ♂), born in the Gardens.

### OUR ASTRONOMICAL COLUMN

**ASTRONOMICAL PHOTOGRAPHY.**—M. Mouchez, the Director of the Observatory of Paris, has communicated to the Academy of Sciences a brief account of some experimental attempts to photograph very small stars, which have been lately made at that establishment. The ecliptical star-charts, commenced by Chacornac, but interrupted in their formation by his decease, were taken up by MM. Paul and Prosper Henry in 1872. These charts include all stars to the thirteenth magnitude; thirty-six of the entire number of seventy-two required for the whole ecliptical zone were completed by Chacornac; these contain 60,000 stars; while sixteen more, containing 36,000 stars, have been constructed by MM. Henry, who will shortly finish four others, with 15,000 stars. But they now find themselves in face of a difficulty which can hardly be overcome by the ordinary process of charting. The condensation of stars in those regions where the Galaxy traverses the ecliptic is so great as apparently to defy an accurate and complete representation of their stellar contents, on the methods adopted for the greater part of the zone, notwithstanding all the experience and well-known skill of the observers.

They have accordingly had recourse to photography, and their first attempts with a provisional apparatus have succeeded so well that there is every reason to expect by this means a solution of the difficulty in question. On plates covering an extent of 3° in right ascension and 2° in declination, obtained with an objective of 0.16 m. diameter and 2.10 m. focal distance, achromatized for the chemical rays—which M. Mouchez exhibited to the Academy—there are shown some 1500 stars from the sixth to the twelfth magnitude, *i.e.* to the limit of visibility of an objective of that size; the images of the stars have diameters nearly proportional to their brightness, except in the case of the yellow stars, which come out somewhat fainter. These encouraging results have led MM. Henry to commence the construction of a large objective of 0.34 m. diameter, which will be mounted by M. Gautier, and it is anticipated that with this instrument, in the course of an hour, a chart of the stars, to the twelfth magnitude at least, and probably to the thirteenth or fourteenth, of the same dimensions as one of the published charts, will be obtained; a work which would otherwise require many months of assiduous labour.

**THE BRITISH ASSOCIATION CATALOGUE OF STARS.**—In a book-list circulated during the last week by a Dresden firm, a copy of this Catalogue has a price of 200 marks (10*l.*) attached, excused by the addition, "Aeusserst selten." As regards star-places the volume is out of date, and the same may be said of the so-called constants for reduction of mean to apparent positions, if any degree of accuracy be required; but it is nevertheless still sought after, especially by those who are commencing the study of astronomy, as will be well known to every one who has any pretence to be considered a practical authority; and it must be admitted that, for purposes of identification and for synonyms in some of the principal older catalogues, the B.A.C. has still its uses. The question arises, whether there would not be a considerable demand for a new general Catalogue of the principal stars, or of stars to the limit of naked-eye vision, brought up from the best authorities to, say, the epoch 1900, but unencumbered with the reduction-quantities, which would materially diminish the expense of formation. A Catalogue of this description, we take it, is not likely to be again provided from the funds of such a body as the British Association, and perhaps the most feasible method of producing it would be by way of subscription. One difficulty would no doubt consist in securing a supervisor of the plan and formation of the work;—perhaps few competent persons could be named who have the leisure which Baily fortunately possessed, and to which we owe not only the B.A.C. but the Catalogues of Lalande and Lacaille.

**THE COMET 1884b.**—Prof. Krueger's telegram to Melbourne led to the observation of this comet, both by Mr. Ellery and Mr. Tebbutt on July 24. Mr. Tebbutt sends us several letters which he has addressed to the *Sydney Morning Herald*.

## THE BRITISH ASSOCIATION

### REPORTS

*Report of the Committee, consisting of Dr. Gladstone, F.R.S. (Secretary), Mr. William Shaen, Mr. Stephen Bourne, Miss Lydia Becker, Sir John Lubbock, Bart., M.P., F.R.S., Dr. H. W. Crosskey, Sir Henry E. Roscoe, F.R.S., Mr. James Heywood, F.R.S., and Prof. N. Sory Maskelyne, M.P., F.R.S., for the Purpose of Continuing the Inquiries relating to the Teaching of Science in Elementary Schools.*—Since the reappointment of your Committee at Southport no legislation affecting the teaching of science in elementary schools has taken place, and it is yet too early to estimate the whole influence of the Education Code of 1882 in that respect. Some indications, however, have been gathered from the Blue-book and from some of the large Boards. The first effect of the change of Code upon the teaching of science is shown in the return of the Education Department for this year; but as the tabulated statements only extend to August 31, 1883, they contain merely the results of those examinations that were made of schools which came under the new Code between April 1 and August 1, 1882, or about 28 per cent. of the whole. The following conclusions may be drawn: (1) Elementary science was taken up by scarcely any schools examined during these months, the number of departments that took it up as the second class subject being only 15, while 3988 took up geography, 1644 (girls) needlework, and 114 history. It must be remembered that geography is more scientific than it was before, but needlework is rapidly displacing it in girls' schools. (2) The exclusion of the Fourth Standard from instruction in specific subjects has reduced the number of scholars so taught by 56.6 per cent.; but the remaining 43.4 per cent., that is to say, the children in Standards V., VI., and VII., do receive a larger proportion of scientific teaching. The actual number of children examined during these four months in the mathematical and scientific specific subjects is given in Column I. of the following table; Column II. gives the estimated number who would have been examined under the old Code; Column III. the number of those who would have been above Standard IV.

Subject	Col. I.	Col. II.	Col. III.
Algebra ... ..	8,256	1,847	799
Euclid and Mensuration ...	604		
Mechanics, Scheme A ...	635	1,393	603
"    Scheme B ... ..	—		
Animal Physiology ... ..	7,078	8,537	3,696
Botany ... ..	1,020	642	278
Agriculture (principles of)...	422	—	—
Chemistry ... ..	368	—	—
Sound, Light, and Heat ...	196	—	—
Magnetism and Electricity...	1,133	—	—
Domestic Economy ... ..	6,090	16,890	7,232
Totals ... ..	25,802	29,309	12,608

Comparing Columns I. and II., it will be seen that the actual number examined in these subjects is not much less than would have been examined under the old Code, when the Fourth Standard was included; but the number of girls who have taken up domestic economy is 10,800 less. If we compare Column I. with Column III., which embraces the same Standards, it appears that double the number of children have passed in these mathematical and scientific subjects. This is, no doubt, mainly due to the fact that English literature and physical geography are removed to the category of class subjects. The great gain has evidently been to the study of algebra, that subject and Euclid being taken up by about eleven times as many as previously took up mathematics. Animal physiology and botany have also largely increased. Mechanics is about the same, while of the new subjects magnetism and electricity has proved itself the favourite, while agriculture, chemistry, and sound, light, and heat follow in order. The only subject that has actually lost ground is domestic economy, which is no longer obligatory in girls' schools if a specific subject is taken. The following table gives the number of passes in specific subjects made by the London School Board children in 1881-82, and in 1883-84. The second column gives the estimated number of those that were made in Standards above IV., corresponding to Column III. in the previous table.

Subject	1882-8a		1883-84
	Standard IV. and upwards	Over Standard IV.	
Algebra ... ..	...	...	3,113
Euclid and Mensuration ... ..	213	101	139
Mechanics ... ..	48	23	165
Animal Physiology ... ..	8,667	4,094	5,657
Botany ... ..	534	252	686
Agriculture (principles of) ... ..	—	—	299
Chemistry ... ..	—	—	198
Sound, Light, and Heat ... ..	—	—	179
Magnetism and Electricity ... ..	—	—	825
Domestic Economy ... ..	9,597	4,533	3,478
<b>Totals</b> ... ..	<b>19,059</b>	<b>9,003</b>	<b>14,739</b>

The following information has been furnished from the Manchester School Board:—

I. Class subjects.

Departments	1882				1883-84			
	Gram-mar	Geo-graphy	Needle-work	Histo-ry	Eng-lish	Geo-graphy	Needle-work	
Boys ... ..	26	24	—	1	31	30	—	—
Girls ... ..	26	11	8	1	28	4	23	—
Junior ... ..	13	10	—	—	21	13	—	3
Mixed ... ..	4	—	1	—	4	—	—	3
<b>Totals</b> ... ..	<b>69</b>	<b>45</b>	<b>9</b>	<b>2</b>	<b>84</b>	<b>47</b>		

Historical and geographical readers are provided in every department, and even though the subject be not taken for the Government examination the children are always questioned on the matter of the reading-books by the Board's Inspector.

II. Specific subjects (scientific).

Subject	Departments			
	1882		1884	
Algebra ... ..	Boys	Girls	Boys	Girls
Euclid and Mensuration ... ..	4	—	13	1
Mechanics ... ..	3	—	1	—
Animal Physiology ... ..	2	—	2	—
Botany ... ..	1	—	—	3
Domestic Economy ... ..	—	10	—	2
<b>Totals</b> ... ..	<b>10</b>	<b>10</b>	<b>17</b>	<b>6</b>

III. Science teaching under the Science and Art Department is given as follows:—

Subject	Departments	
	Boys	Girls
Mathematics ... ..	3	2
Physiology ... ..	1	1
Chemistry ... ..	3	2
Sound, Light, and Heat ... ..	2	2
Magnetism ... ..	2	2
<b>Totals</b> ... ..	<b>11</b>	<b>9</b>

The Brighton School Board had the following number of children studying the specific subjects during the quarter ending March 25, 1884:—

	Boys	Girls
Algebra ... ..	285	—
Euclid and Mensuration ... ..	13	—
Animal Physiology ... ..	292	6
Magnetism and Electricity ... ..	149	—
Domestic Economy ... ..	—	261

As to class subjects, the ten boys' departments all take up geography as the second, the number of children under instruction being 2879; while only one girls' department, with 119 children, takes geography for the Government examination, though it is taught in most of the others through reading lessons. The other nine girls' departments, with 2339 children, take needlework as the second class subject. At the Southport meeting a recommendation was passed that this Committee "be requested to consider the desirableness of making representations to the Lords of the Committee of Her Majesty's Privy Council on Education in favour of aid being extended towards the fitting up of workshops in connection with elementary day schools or evening classes, and of making grants on the results of practical

instruction in such workshops under suitable direction, and, if necessary, to communicate with the Council." As it was believed that the second Report of the Royal Commissioners on Technical Instruction would have an important bearing upon this question, the Committee was not called together till the publication of that Report. It was not issued till May, and it then appeared that, in addition to a very large amount of valuable information, the Royal Commissioners had recommended, among other things:— "(b) That there be only two class subjects instead of three in the lower division of elementary schools, and that the object lessons for teaching elementary science shall include the subject of geography." "(d) That proficiency in the use of tools for working in wood and iron be paid for as a specific subject, arrangements being made for the work being done, so far as practicable, out of school hours. That special grants be made to schools in aid of collections of natural objects, casts, drawings, &c., suitable for school museums." With reference to recommendation (b) your Committee, without expressing any opinion as to the desirability of forming one subject out of geography and elementary science, consider that, if this change be effected, the two class subjects which will then represent literature and science should stand upon an equal footing. This would be in accordance with the resolution of the Council passed on December 5, 1881, in considering the recommendations of your Committee in regard to the proposals for the new Code. At present, if only one class subject is taken, the Code requires that it should be "English" (grammar and literature); but many managers or teachers might prefer taking science. With respect to recommendation (d) your Committee thoroughly approve of the proposals, which, if carried out, would realise the wish expressed in the reference to them from the Southport meeting. They have not, however, thought it necessary to communicate at once with the Council, as there is no immediate legislation in prospect, and the meeting at Montreal might like to give further instructions on the subject. The name of Prof. N. Story Maskelyne, M.P., has been replaced on the Committee.

Report of the Committee, consisting of Sir Joseph Hooker, Dr. Günther, Mr. Howard Saunders, and Mr. P. L. Sclater (Secretary), appointed for the Purpose of Exploring Kilimanjaro and the Adjoining Mountains of Eastern Equatorial Africa.— (1) The Committee have the satisfaction of announcing that they have made arrangements with Mr. H. H. Johnston (who has recently returned from the Congo) to undertake an exploration of Kilimanjaro, and that he is probably by this time encamped upon that mountain. (2) The Committee have arranged with Mr. Johnston to undertake the cost of the expedition for 1000l., without reference to personal remuneration. It is believed that the necessary expenditure will not be covered by this sum, but Mr. Johnston has agreed to make good any deficiency. (3) Towards this sum of 1000l. the Committee have appropriated a sum of 500l. granted to them by the Association at their last meeting at Southport. The Committee have also received from the Government Grant Committee of the Royal Society two sums of 250l. each, so that the whole sum of 1000l. required for the expedition is already available. (4) But looking forward to the risks of African travel, and to the expenditure likely to be incurred on the transport to this country, and on the working out of the collections obtained by Mr. Johnston, the Committee trust that a further sum of 50l. may be placed at their disposal. (5) A copy of part of Mr. Johnston's last letter to the Secretary of the Committee, containing an account of the progress of the expedition, is annexed to this Report.

Extracts from a letter from Mr. Johnston to Mr. Sclater, dated British Residency, Zanzibar, May 13, 1884:—"At last my expedition, thanks to the help of Sir John Kirk, is organised and ready to start. I have engaged thirty-two men here (at Zanzibar), and have sent them off to Mombasa in a dhow to await my coming. I myself leave to day for Mombasa in the mail. At Mombasa, through the Consul (Capt. Gissing), I have engaged sixty more men, for it will need nearly a hundred porters to carry my goods and baggage to Chagga. I hope to leave Mombasa in a fortnight's time. I anticipate three weeks' easy travel to Kilimanjaro, and, as far as it is possible to foretell aught in Africa, no serious difficulties seem to stand in my way. The expedition, however, will prove much more costly than I had anticipated. . . . However, I think I shall be able to make both ends meet for six months on Kilimanjaro, and if I stay longer, or make a dash at Kenia, it will be on my own account. I shall probably make Taita or Teita (*vide map*) a half-way house, and go backwards and forwards with collections and

goods. I shall try to forward collections addressed to you by *every mail* if feasible. Then, if you judge of the value, and estimate that my share of the collections will realise a good amount, it will induce me to devote more time to the country. My health, notwithstanding a much more trying climate than I have yet met with in Africa, has been very good, and I have not known an hour's illness or indisposition. Sir John Kirk has shown me the utmost kindness and hospitality, and his help and his influence have smoothed away many difficulties. The expedition promises most favourably, as the present condition of the countries to be traversed is good and peaceful, food abundant, and provisions cheap. . . . I have obtained the services of three of Dr. Fischer's bird-skinners, and have got one botanical collector, trained under Sir John Kirk, and acquainted with the mysteries of 'soldering' and preserving in spirit. I have sent for rectified spirit from Bombay, and in the interval am using trade gin. The Sultan has given me three kegs of gunpowder to give as presents to chiefs, and has also furnished me with letters of introduction. I am in excellent condition, and start to-day on my journey in the best spirits and with the strongest hopes of its success."

*Report of the Committee, consisting of Mr. James N. Shoolbred (Secretary) and Sir William Thomson, appointed for the Purpose of Reducing, and Tabulating the Tidal Observations in the English Channel made with the Dover Tide-Gauge, and of Connecting them with Observations made on the French Coast.*—The Committee beg to report that the tidal curves of the self-registering tide-gauge at Dover for the years 1880, 1881, 1882, and 1883, have been kindly placed at their disposal by the Board of Trade, for reduction and tabulation; and that the Belgian Government have been good enough to present to the Committee copies of the tidal curves at Ostend during the same period of four years. The reduction and tabulation of the high and low water registers of these two sets of tidal curves has progressed satisfactorily, and will be shortly completed. It is hoped also that a like reduction will be soon commenced with other self-registering tidal curves during the same period at several other points, both on the English and the French coasts. The Committee request to be allowed to transmit to the Board of Trade and to the Belgian Government respectively, the thanks of the Association for their assistance and donations in furtherance of this inquiry. The Committee request to be re-appointed, with a grant of 10*l.* to defray the expenses of reduction, &c.

*Report of the Committee, consisting of Prof. Balfour Stewart (Secretary), Prof. Stokes, Mr. G. Johnstone Stoney, Prof. Roscoe, Prof. Schuster, Capt. Abney, and Mr. G. J. Symons, appointed for the Purpose of Considering the Best Methods of Recording the Direct Intensity of Solar Radiation.*—This Committee, acting on a suggestion made by Gen. Strachey, have chiefly devoted their attention to the subject of a self-recording actinometer. The self-recording actinometer of Mr. Winstanley would not be suitable, because it is influenced by radiation from all quarters. Other actinometers require manipulation on the part of the observer which would make it almost impossible to make them self-recording. It was suggested by Prof. Balfour Stewart that a modification of his actinometer might be adapted to self-registration by taking for the quantity to be observed, not the rise of temperature of the inclosed thermometer after exposure for a given time, but the excess of its temperature when continuously exposed over the temperature of the envelope. After making some calculations as to the behaviour of such an instrument, Prof. Stokes came to the following conclusions:—(1) The inclosure should be of such a nature as to change its temperature very slowly, and of such a material that the various portions of the interior should be at the same moment of the same uniform temperature. For this purpose an arrangement somewhat similar to that used in Prof. Stewart's actinometer is suggested; the outside to consist of polished metallic plates, then a layer of some non-conducting substance, such as felt, then a thick copper interior which need not be polished. Into this copper is to be inserted a thermometer which will give the temperature of the copper interior from moment to moment.

"This is the case at present, but there would not be any great difficulty in modifying it so as to act as required. It is quite a matter worth consideration whether a differential air-thermometer would not be very suitable, one bulb silvered and the other blackened or of green glass, as I suggested to the Meteorological Council some years back. By this means only one reading would be necessary, whilst in the plan suggested two would have to be recorded, and the measurements would be more difficult." (Note by Capt. Abney.)

(2) In the middle of the inclosure is to be placed the thermometer, upon which the heat of the sun is made to fall by means of a hole in the inclosure, either with or without a lens. This thermometer should be so constructed as to be readily susceptible to solar influences. It is proposed to make it of green glass (a good absorber and radiator), and to give it a flattened surface in the direction perpendicular to the light from the hole. Such an instrument should be so adjusted as to receive the sun's light continuously through the hole, and the objects of record would be the simultaneous heights of the two thermometers, the one giving the temperature of the inclosure, and the other of the central thermometer. There are two conceivable methods by which the necessary adjustment with regard to the sun's light might be secured, namely, (a) the inclosure might be subject to an equatorial motion so as to follow the sun, or (b) the inclosure might be kept at rest and the solar rays kept upon the hole by a heliostat. Capt. Abney is of opinion that the latter arrangement is, mechanically, much preferable to the former. As the direction of the earth's axis may be chosen as that into which the sun's light is to be reflected, a heliostat of a very simple construction will suffice; and as the angle of incidence on the mirror of such a heliostat changes only very slowly with the season, there is no difficulty in applying the small correction required for the change in the intensity of the reflected heat consequent on the change in the angle of incidence. It is assumed that the mirror of the heliostat is a speculum. It has been remarked by Gen. Strachey that some such instrument as this now suggested, even if not made self-recording, would have the advantage of giving an observation without the objectionable necessity of putting the light on for a given time, and then shutting it off, operations only suitable for trained observers. We think that it would be desirable to construct an inclosure with its two thermometers such as herein recorded. In all probability the loan of a heliostat and of an actinometer might be obtained. By aid of the heliostat the sun's light might be kept continuously upon the hole of the inclosure. The two thermometers would be read, and the results compared with the simultaneous reading of an ordinary actinometer. By such means it is believed that the best method of constructing such an instrument and observing with it might be found. We would therefore ask for a continuance of our Committee, with the sum of 30*l.* to be placed at our disposal for the purpose herein specified.

*Report of the Committee, consisting of Mr. Schaler, Mr. Howard Saunders, and Mr. Taisleton Dyer (Secretary), appointed for the Purpose of Investigating the Natural History of Timor Laut.*—Since our last report was presented to the Association, Mr. Forbes's botanical collection—which, from the result of an unfortunate fire in the drying-house in which the Herbarium had to be prepared, was very small, as he deplures—has been handed over to the Royal Herbarium at Kew. Of this collection Sir Joseph Hooker, at a meeting of the Royal Geographical Society on January 28, 1884, made the following remarks:—"From that time [of the appearance of Prof. Decaisne's 'Flora Timoriensis'] to this, the limits of the Australian flora, so long supposed to have been circumscribed with exactitude, have never been laid down, though it has been enormously enlarged to the north by the inclusion of the great island of Papua, which is to a great extent Australian in its biology, and by that of sundry other islets to the north-east and north-west. It is under this point of view that Mr. Forbes's collections are so important. It is true that for the most part they consist of what are generally known as *cor-Island* plants. . . . But besides this there are some peculiar forms, and there are two plants of extraordinary interest which I would simply instance as being typical—one of the new Hebridean and one of the Australian flora. It so happened that these two plants belonged to unispecific genera. . . . The existence of these plants pointed to some old communication between these particular islands." No detailed account of the ethnographical collection has yet been published; but as the collection has been deposited in the British Museum, a description of the Timor Laut objects will doubtless appear in the Catalogue of the Ethnological Department, while the more interesting will be figured in Mr. Forbes's forthcoming volume. At the last meeting of the Association at Southport, Dr. J. G. Garson ("Report," p. 566) read a short account of the crania (now in the British Museum) brought from Larat by Mr. Forbes, which has been published in *extenso* in the *Journal of the Anthropological Institute*, vol. xiii., and which concludes with the following remarks on the relation of the inhabitants of

Timor Laut to those of adjacent countries:—"That the skulls just described are not those of a pure race is very evident. Two very distinct types can be made out, namely, the brachycephalic and the dolichocephalic, the former greatly predominating in number. Both from the information Mr. Forbes has given us as to their appearance, and from the skulls themselves, there is no difficulty in recognising a strong Malay element in the population. The male skull No. 4, and the female No. 6, are typically Malayan in their characters, especially in possessing large, open, rounded orbits, and smooth forehead, the superciliary ridges and glabella being almost entirely absent. The other brachycephalic skulls, though not presenting such a striking affinity, agree more or less with this type, but give evidence of mixed characters. The dolichocephalic skull is, on the other hand, markedly of the Papuan type, and corresponds so closely as to be undistinguishable from two crania obtained twenty miles inland from Port Moresby, New Guinea, in the College of Surgeons' Museum, also from another from the Solomon Islands. Along with this form of skull, Mr. Forbes informs me, is associated frizzly hair and dark skin. The examination of the cranial characters of the inhabitants of Timor Laut, as illustrated by the skulls before us, shows that the peopling of this island is no exception to what is usually found in the various groups of islands in the Polynesian Archipelago. From its close proximity to New Guinea, perhaps more of the Papuan element might have been expected." In addition, the *Coleoptera* sent home have been examined and described in a recent paper by Mr. C. O. Waterhouse, published in the Zoological Society's *Proceedings*. The number of species collected was twenty-nine; of these the following deserve special notice on account of their geographical distribution:—*Diaphanes rugosus*, a new genus and species of *Staphylinidae* known from Java; *Cyphogastera angulicollis*, only previously known from Banda; *C. splendens*, a new species allied to the preceding; *Archetypus rugosus*, belonging to a genus of Longicorns, of which there was only one species previously known, which species occurs in Waigiou, Dorey, and Aru; *Nemophas forbesii*, a new Longicorn nearly allied to *N. grayi* from Amboina. Further, a new species of ground thrush (*Geothlypis machiki*) has been described by Mr. Forbes from additional specimens brought home by himself on his return. So that our knowledge of the avifauna of this region has been increased by the addition of twenty-four new species, entirely collected on the few square acres to which the inter-tribal wars of the natives restricted Mr. Forbes's operations. At the presentation of our last report, Mr. Forbes, who had just returned to England, gave a short description of the region visited by him; but at the meeting of the Royal Geographical Society, to which we have referred above, he gave a more detailed account, which has been published, illustrated by a map, in their *Proceedings* for March, embodying the geographical observations made by him. The collections of Fishes, Crustacea, and Hydrozoa, though containing much that was of interest, added few species that were new to science. A statement in our last report, on p. 227, that "the total expense of Mr. Forbes's expedition has amounted to 300*l.*" ought perhaps to be corrected, as we understand from Mr. Forbes that the total cost was more than double this sum.

*Report of the Committee, consisting of Mr. John Cordaux (Secretary), Prof. Newton, Mr. J. A. Harvie-Brown, Mr. William Eagle Clark, Mr. R. M. Barrington, and Mr. A. G. Moore, reappointed at Southport for the Purpose of Obtaining (with the Consent of the Master and Brethren of the Trinity House and the Commissioners of Northern and Irish Lights) Observations on the Migrations of Birds at Lighthouses and Light-vessels, and of reporting on the same.*—The General Report<sup>1</sup> of the Committee, of which this is an abstract, comprises observations taken at lighthouses and light-vessels, as well as at several land stations, on the east coast of England, the east and west coasts of Scotland, the coasts of Ireland, also the Channel Islands, Orkney and Shetland Isles, the Hebrides, Faroes, Iceland and Heligoland, and one Baltic station on the coast of Zealand, for which the Committee is again indebted to Prof. Lutken of Copenhagen. Altogether 158 stations have been supplied with schedules and letters of instruction for registering observations, and returns have been received from 102. The best thanks of the Committee are due to their numerous observers for the generally careful and painstaking manner in which they have filled up the schedules, and the very intelligent interest taken by them in the inquiry.

<sup>1</sup> "Report on the Migration of Birds in the Spring and Autumn of 1883." (West, Newman, and Co., 54, Hatton Garden, London, E.C.)

Special thanks must be accorded to Messrs. H. Gätke, Heligoland; H. C. Müller, Faroe; and M. Thorlacius, Skykkeholm, Iceland, for the notes sent in from their respective stations; also to Mr. J. H. Gurney, for having commenced on the south-east coast of England a similar system of inquiry, which, for a first trial, has worked well. In all doubtful cases of identity, where birds are killed against the lantern, a wing is cut off, and a label, with the date, attached. These have been forwarded in batches to Mr. Gurney for identification, and with most satisfactory results. The Committee regret that for the second year in succession they have received no report from the west coast of England. A late member of the Committee, Mr. Philip M. C. Kermode, having failed to make any returns, or to send the collected schedules, although repeatedly requested, to Mr. W. E. Clarke, who had undertaken the work of tabulating and reporting on the same, provision has been made by the Committee for supplying the deficiency in any subsequent years. The observations taken on the east coast of Great Britain in 1883 have been such as generally to confirm the conclusions arrived at in former reports, having reference to direction of flight and lines of migration. The winter of 1883-4 has been exceptionally mild, and there has been an almost entire absence of severe frosts and lasting snow-storms; the prevailing winds in the autumn, west and south-west, such as observation shows are most favourable for migrants crossing the North Sea and continuing their journey inland. Winds from opposite quarters to these tire out the birds and cause them to drop directly they reach land. Our land stations report a great scarcity both of land and sea birds; this has not, however, been the case at sea stations—that is, light-vessels moored off the coast at distances varying from five to fifty miles. Here the stream of migration, so far from showing any abatement, has flown steadily on in a full tide; and, if we judge from the well-filled schedules which have been returned, there has been a considerable increase in the visible migration, due perhaps in some measure to increased interest and improved observation. Mr. William Stock, of the Outer Dowsing light-vessel, remarks that he had never before seen so many birds pass that station; the rush, also, across and past Heligoland in the autumn was enormous. Migration is more marked, as well as concentrated, there, than at any station on the English coast. There was a great movement of various species passing forward on August 6 and 7, and again on the 14th, and more pronounced still on the 21st and 22nd, and on August 20 a similar movement was noticed at the Isle of May, at the mouth of the Firth of Forth. It was not, however, until September 21 and the two following days that the first great rush occurred on the English east coast, and a similar great movement or rush is indicated, at the same date, in Mr. Gätke's notes, as well as from the most distant of the lightships. The prevailing winds over the North Sea on September 21 were moderate north-easterly and easterly off the coasts of Denmark and Holland, blowing strong easterly on the coast north of the Humber, with southerly and south-westerly off the south-east coast, producing cross-currents over the North Sea. Whatever was the impulse, atmospheric or otherwise, which induced such a vast rush of various species at this time, it was one which acted alike, and with precisely the same impulse, on the sea-eagle and the tiny goldcrest. The second great rush was on October 12 and 13, a similar movement being recorded at Heligoland. Then, again, from the 27th to the 31st, and somewhat less through the first week in November, the passage across Heligoland, as well as the rush on our east coast, was enormous. Speaking of the nights from the 27th to the 31st inclusive, Mr. Gätke says:—"This was the first move by the million; for four nights there has been a gigantic feathery tide running." During this time there were variable winds over the North Sea, but generally easterly and south-easterly on the Continent, strong west winds and squalls prevailing generally on November 5 and 6. Again, with the outburst of some severe weather in the first week in December, a considerable local movement is indicated along the coast from north to south, culminating in the enormous rush of snow-buntings into Lincolnshire about the end of the first week in that month. A careful perusal of the report will show how generally the rushes across Heligoland correlate with those on the east coast of England, although not always confined to identical species. A somewhat remarkable and very anomalous movement of migrants is recorded from light-vessels of the Lincolnshire and Norfolk coasts in the spring of 1883. In February, March, April, and May, birds passing the Leman and Ower, Llyn Wells, Outer Dowsing, Newarp and the Cockle light-

vessels, were, as a rule, coming from easterly and passing in westerly directions. The entries show a great immigration of our ordinary autumn migrants from the east in the spring months, and on exactly the same lines and directions as are travelled by the same species in autumn. Had this movement been observed at one station only, we might perhaps have been induced to doubt the accuracy of the return, but the fact of five light-vessels, having no communication with each other, reporting the same circumstances, proves the correctness of the observations. On the east coast of Scotland Mr. J. A. Harvie-Brown says that the autumn migration of 1883 was pronounced, culminating in a grand rush from October 28 to November 3. The heaviest rush of birds, as compared with other years, was observed at the Isle of May on October 13 and 14. This was with a south wind, although as a rule it is a south-east wind at that point which brings the greatest flights. In the autumn of 1882, on the east coast of Scotland, the bulk of immigrants are recorded at the southern stations; in 1883 these conditions were reversed, the bulk being recorded from northern stations. On the east coast of England, in 1883, birds appear to have been very equally distributed over the whole coast-line. It will be gathered from the General Report that the dates of the rushes on the east coast of Scotland were slightly later than those on the east coast of England, and that the migrations past the more northerly stations in Scotland were in proportion later than in the south, and also that the dates of the heaviest rushes on the east coast agree fairly with the dates from the west coast. From the coasts of Ireland Messrs. A. G. More and R. M. Barrington report a decided improvement in filling up the schedules, in some cases three or four being returned from the same station. Forty-two stations were supplied with schedules in the spring of 1883, and thirty-five in the autumn of the same year, returns coming in from thirty-four, one only failing. The number of migrants in the autumn seems to have been more than usual. A great rush of thrushes (including, probably, redwings), black-birds, and starlings, took place at the south-eastern and southern stations between October 25 and November 2—dates which agree with the great rush on the east coast of England. The migration was particularly marked at the Tuskar Rock, off the Wexford coast, which is proving itself the best Irish station, and no doubt marks the line of the chief passage from the British coast. The bulk of the immigrants appear to arrive on the south-eastern coast of Ireland, excepting such birds as the bernicle-goose and snow-bunting, which are mainly recorded from north-western stations, and rarely entered in schedules from the east or south coast. An interesting feature this year is the occurrence of several examples of the Greenland falcon on the west coast, no less than eight having been shot at various points from Donegal to Cork, and one Iceland falcon at Westport. Independent of the ordinary notes on migration, the general remarks of the light-keepers with reference to the nesting of sea-fowl on the islands or outlying skerries are of great interest, and no matter what results are arrived at from this special inquiry, it is satisfactory to be in correspondence with such a number of observers at isolated spots around the coast, and the information supplied cannot fail to be of much interest to future compilers. An interesting feature of the autumn migration is the occurrence of a flight of the blue-throated warbler (*Cyanocitta stercorata*). A single adult with bright-blue breast was observed at the Isle of May on the night of September 2-3. On the east coast of England twelve were obtained, all being birds of the year, and of these nine on the coast of Norfolk, besides about twenty others seen by competent observers. Very few goldcrests, compared with the enormous flights of the previous autumn, have appeared, and the same scarcity is observable in the Heligoland returns. Curiously enough, the hedge-sparrow (*Accentor modularis*), which migrated in immense numbers in the same autumn, has been almost entirely absent. About half a dozen are recorded at Heligoland, none on the east coast of England. Of the enormous immigration which crosses our east coast in the autumn, either to winter in these islands or merely on passage across them, a small proportion only appear to return by the same routes. Spring returns from lighthouses and light-vessels show that birds then move on the same lines as in the autumn, but in the reverse direction. These return travellers do not, however, represent anything like a tithe of the visible immigrants which, week after week and month by month, in the autumn, move in one broad stream on to the east coast. What is called the "first flight" of the woodcock arrived on the Yorkshire, Lin-

colnshire, and Norfolk coasts on the night of October 21. The "great flight," or rush, which covered the whole of the east coast from the Farne Islands to Yarmouth was on the nights of the 28th and 29th. These two periods correlate with the principal flights of woodcock across Heligoland. But few woodcock were recorded from stations on the east coast of Scotland, although at the Bell Rock Lighthouse, on the night from October 31 to November 1, Mr. Jack reports an enormous rush of various species, commencing at 7 p.m. Immense numbers were killed, pitching into the sea. "What we thought were woodcocks struck with great force; birds continued flying within the influence of the rays of light till the first streak of day, continually striking hard all night; we believe a great number of woodcocks struck and fell into the sea." Mr. Harvie-Brown records a very great spring migration of woodcock which appear to have crossed Scotland between the Clyde and the Forth on March 9, 10, 11, and 12, 1884. These were observed to be the small red Scandinavian bird, which are quite unmistakable and distinct from British-bred birds. The occurrence of *Locustella fluviatilis* at the Stevns Lighthouse at the entrance of the Oresund in Zealand is interesting, as it is the first recorded Danish example of this species. Altogether there has been a very marked absence on our British coasts of rare and casual visitants. The roller (*Coracias garrula*) occurred in October in two localities—one in Lincolnshire, the other in Suffolk. Two examples of the sooty shearwater (*Puffinus griseus*) were obtained in Bridlington Bay about the end of September. The island of Heligoland retains its pre-eminence as the casual resting-place of rare wanderers from other lands; and Mr. Gätke's list for 1883 includes *Turdus varius*, *Pratincola rubicola*, var. *indica*, *Phylloscopus superciliosus*, *Hypolais pallida*, *Motacilla citreola*, *Anthus cervinus*, *A. richardi*, *Oriolus galbula*, *Lanius major*, *Muscicapa parva*, *Linota exilipes*, *Emberiza melanocephala*, *E. cirius*, *E. rustica*, *E. pusilla*, *Pastor sœsus*, and *Xema sabini*. It is well known that large numbers of European birds, presumably driven out of their course, are seen during the autumn migration far out over the Atlantic, alighting on the ocean-going steamers. It is proposed by Mr. Harvie-Brown to supply schedules to the principal lines of ocean steam-vessels for the better recording of these occurrences. It must be borne in mind that the immense and constantly-increasing traffic which in these days bridges the Atlantic and unites the Old and New Worlds, offers unusual chances for birds to break their flight, and ultimately, perhaps, to reach the American coast. In the comparatively narrow seas between the European continent and Great Britain birds are frequently noted as alighting on the rigging of vessels and light-ships, roosting in the rigging during the night, to resume their flight at the first streak of dawn. It is a matter of congratulation that our American and Canadian fellow-workers have instituted a similar system of observation on the migration of birds. At the first Congress of the American Ornithologists' Union, held at New York City, September 26 to 28, 1883, a Committee on the Migration of Birds was appointed. It is intended to investigate this in all its bearings and to the fullest possible extent, not only in the accumulation of records of the times of arrival and departure of the different species, but to embrace the collection of all data that may aid in determining the causes which influence migration from season to season. Your Committee respectfully request their reappointment, and trust that the Association will enable them to continue the collection of facts.

*Tenth Report of the Committee, consisting of Prof. E. Hull, the Rev. H. W. Crosskey, and Messrs. James Glaisher, H. Marten, E. B. Marten, G. H. Morton, W. Pengelly, James Plant, I. Roberts, Thos. S. Stooke, G. J. Symons, W. Topley, E. Wethered, W. Whitaker, and C. E. De Rance (Secretary and Reporter), appointed for the Purpose of Investigating the Circulation of Underground Waters in the Permeable Formations of England and Wales, and the Quantity and Character of the Water Supplied to Various Towns and Districts from those Formations. Drawn up by C. E. De Rance.*—The Chairman and Secretary of your Committee are both unavoidably obliged to be absent from the Montreal meeting, which is a source of regret to themselves; the more so that, this being the case, it has been thought advisable to delay presenting their final Report on the Circulation of Underground Waters in South Britain until next year, when the Committee will have been twelve years in existence. During these years particulars have been collected

of the sections passed through by a very large number of wells and borings; a daily record has been obtained of the height at which water stands in many of these wells; investigations have been carried out as to the quantity of water held by a cubic foot of various rocks, by Mr. Wethered; and as to the filtering power of sandstones, and the influence of barometric pressure and lunar changes on the height of underground waters, by Mr. I. Roberts. During the present year the attention of the Committee has been directed to the remarkable influence of the earthquake which visited the East and East-Central Counties of England in March last, in raising the levels of the water in the wells of Colchester and elsewhere. More detailed information is still required as to the proportion of actual rainfall absorbed by various soils, over extended periods representing typical dry and wet years. Information on these heads and on other points of general interest bearing on the percolation of underground waters, referring to observations made in Canada or the United States, would be gladly welcomed by the Committee, and would be incorporated in their eleventh and final Report to be presented next year. Your Committee seek reappointment, but do not require a grant, as they have forms of inquiry on hand, and did not require to expend the whole of the grant of last year, a portion of which only has been drawn.

*Appendix—Copy of Questions.*—1. *Position* of well or shaft with which you are acquainted. 1a. State *date* at which the well or shaft was originally sunk. Has it been deepened since by sinking or boring? and when? 2. Approximate *height* of the surface of the ground above Ordnance Datum (mean sea-level). 3. *Depth* from the surface to bottom of shaft or well, with diameter. *Depth* from surface to bottom of bore-hole, with diameter. 3a. *Depth* from the surface to the horizontal drift-ways, if any. What is their length and number? 4. *Height* below the surface at which water stands *before* and *after* pumping. Number of hours elapsing before ordinary level is restored after pumping. 4a. *Height* below the surface at which the water stood when the well was first sunk, and height at which it stands now when not pumped. 5. *Quantity* capable of being pumped in gallons per day of twenty-four hours. Average quantity daily pumped. 6. Does the *water-level* vary at different seasons of the year, and to what extent? Has it diminished during the last ten years? 7. Is the ordinary *water-level* ever affected by local rains, and, if so, in how short a time? And how does it stand in regard to the level of the water in the neighbouring streams, or sea? 8. *Analysis* of the water, if any. Does the water possess any marked *peculiarity*? 9. *Section*, with nature of the rock passed through, including cover of Drift, if any, with *thickness*. 9a. In which of the above rocks were springs of water intercepted? 10. Does the cover of Drift over the rock contain *surface springs*? 11. If so, are these *land springs* kept entirely *out* of the well? 12. Are any large *faults* known to exist close to the well? 13. Were any *brine springs* passed through in making the well? 14. Are there any *salt springs* in the neighbourhood? 15. Have any wells or borings been discontinued in your neighbourhood in consequence of the water being more or less *brackish*? If so, please give section in reply to query No. 9. 16. Kindly give any further information you can.

#### PENDING PROBLEMS OF ASTRONOMY<sup>1</sup>

THIRTY-SIX years ago this very month, in this city, and near the place where we are now assembled, the American Association for the Advancement of Science was organised, and held its first meeting. Now, for the first time, it revisits its honoured birthplace.

Few of those present this evening were, I suppose, in attendance upon that first meeting. Here and there, among the members of the Association, I see, indeed, the venerable faces of one and another, who, at that time in the flush and vigour of early manhood, participated in its proceedings and discussions; and there are others, who, as boys or youths, looked on in silence, and listening to the words of Agassiz and Peirce, of Bache and Henry, and the Rogers brothers and their associates, drank in that inspiring love of truth and science which ever since has guided and impelled their lives. Probably enough, too, there may be among our hosts in the audience a few who remember that occasion, and were present as spectators.

<sup>1</sup> Address to the American Association for the Advancement of Science at Philadelphia, September 5, by Prof. C. A. Young, Professor of Astronomy at Princeton, retiring President of the Association. We are indebted to the courtesy of the editor of *Science* for an early copy of Prof. Young's address.

But, substantially, we who meet here to-day are a new generation, more numerous certainly, and in some respects unquestionably better equipped for our work, than our predecessors were, though we might not care to challenge comparisons as regards native ability, or clearness of insight, or lofty purpose.

And the face of science has greatly changed in the meantime; as much, perhaps, as this great city and the nation. One might almost say, that, since 1848, "all things have become new" in the scientific world. There is a new mathematics and a new astronomy, a new chemistry and a new electricity, a new geology and a new biology. Great voices have spoken, and have transformed the world of thought and research as much as the material products of science have altered the aspects of external life. The telegraph and dynamo-machine have not more changed the conditions of business and industry than the speculations of Darwin and Helmholtz and their compeers have affected those of philosophy and science.

But, although this return to our birthplace suggests retrospections and comparisons which might profitably occupy our attention for even a much longer time than this evening's session, I prefer, on the whole, to take a different course; looking forwards rather than backwards, and confining myself mainly to topics which lie along the pathway of my own line of work.

The voyager upon the Inland Sea of Japan sees continually rising before him new islands and mountains of that fairy-land. Some come out suddenly from behind nearer rocks or islets, which long concealed the greater things beyond; and some are veiled in clouds which give no hint of what they hide, until a breeze rolls back the curtain; some, and the greatest of them all, are first seen as the minutest specks upon the horizon, and grow slowly to their final grandeur. Even before they reach the horizon line, while yet invisible, they sometimes intimate their presence by signs in sky and air; so slight, indeed, that only the practised eye of the skilful sailor can detect them, though quite obvious to him.

Somewhat so, as we look forward into the future of a science, we see new problems and great subjects presenting themselves. Some are imminent and in the way,—they must be dealt with at once, before further progress can be made; others are more remotely interesting in various degrees; and some, as yet, are mere suggestions, almost too misty and indefinite for steady contemplation.

With your permission, I propose this evening to consider some of the pending problems of astronomy,—those which seem to be most pressing, and most urgently require solution as a condition of advance; and those which appear in themselves most interesting, or likely to be fruitful, from a philosophic point of view.

Taking first those that lie nearest, we have the questions which relate to the dimensions and figure of the earth, the uniformity of its diurnal rotation, and the constancy of its poles and axis.

I think the impression prevails that we already know the earth's dimensions with an accuracy even greater than that required by any astronomical demands. I certainly had that impression myself not long ago, and was a little startled on being told by the superintendent of our "Nautical Almanac" that the remaining uncertainty was still sufficient to produce serious embarrassment in the reduction and comparison of certain lunar observations. The length of the line joining, say, the Naval Observatory at Washington with the Royal Observatory at the Cape of Good Hope is doubtful—not to the extent of only a few hundred feet, as commonly supposed, but the uncertainty amounts to some thousands of feet, and may possibly be a mile or more, probably not less than a ten-thousandth of the whole distance; and the *direction* of the line is uncertain in about the same degree. Of course, on those portions of either continent which have been directly connected with each other by geodetic triangulations, no corresponding uncertainty obtains; and as time goes on, and these surveys are extended, the form and dimensions of each continuous land-surface will become more and more perfectly determined. But at present we have no satisfactory means of obtaining the desired accuracy in the relative position of places separated by oceans, so that they cannot be connected by chains of triangulation. Astronomical determinations of latitude and longitude do not meet the case; since, in the last analysis, they only give at any selected station the *direction of gravity* relative to the axis of the earth, and some fixed meridian plane, and do not furnish any *linear* measurement or dimension.

Of course, if the surface of the earth were an exact spheroid, and if there were no irregular attractions due to mountains and valleys and the varying density of strata, the difficulty could be

ually avoided; but, as the matter stands, it looks as if nothing short of a complete geodesic triangulation of the whole earth would ever answer the purpose,—a triangulation covering Asia and Africa, as well as Europe, and brought into America by way of Siberia and Behring's Straits.

It is indeed theoretically possible, and just conceivable, that the problem may some day be reversed, and that the geodesist may come to owe some of his most important data to the observers of the lunar motions. When the relative position of two or more remote observatories shall have been precisely determined by triangulation (for instance, Greenwich, Madras, and the Cape of Good Hope), and when, by improved methods, and observations made at these fundamental stations, the moon's position and motion relative to them shall have been determined with an accuracy much exceeding anything now attainable, then by similar observations, made simultaneously at any station in this hemisphere, it will be theoretically possible to determine the position of this station, and so, by way of the moon, to bridge the ocean, and ascertain how other stations are related to those which were taken as primary. I do not, of course, mean to imply that, in the present state of observational astronomy, any such procedure would lead to results of much value; but, before the Asiatic triangulation meets the American at Behring's Straits, it is not unlikely that the accuracy of lunar observations will be greatly increased.

The present uncertainty as to the earth's dimensions is not, however, a sensible embarrassment to astronomers, except in dealing with the moon, especially in attempting to employ observations made at remote and ocean-separated stations for the determination of her parallax.

As to the form of the earth, it seems pretty evident that before long it will be wise to give up further attempts to determine exactly what spheroid or ellipsoid most nearly corresponds to the actual figure of the earth, since every new continental survey will require a modification of the elements of this spheroid in order to take account of the new data. It will be better to assume some closely approximate spheroid as a finality; its elements to be for ever retained unchanged, while the deviations of the actual surface from this ideal standard will be the subject of continued investigation and measurement.

A more important and anxious question of the modern astronomer is, whether is the earth's rotation uniform, and, if not, in what way and to what extent does it vary? The importance, of course, lies in the fact that this rotation furnishes our fundamental measure and unit of time.

Up to a comparatively recent date, there has not been reason to suspect this unit of any variation sufficient to be detected by human observation. It has long been perceived, of course, that any changes in the earth's form or dimensions must alter the length of the day. The displacement of the surface or strata by earthquakes or by more gradual elevation and subsidence, the transportation of matter towards or from the equator by rivers or ocean-currents, the accumulation or removal of ice in the Polar regions or on mountain-tops,—any such causes must necessarily produce a real effect. So, also, must the friction of tides and trade-winds. But it has been supposed that these effects were so minute, and to such an extent mutually compensatory, as to be quite beyond the reach of observation; nor is it yet certain that they are not. All that can be said is, that it is now beginning to be *questionable* whether they are or are not.

The reason for suspecting perceptible variation in the earth's revolution, lies mainly in certain unexplained irregularities in the apparent motions of the moon. She alone, of all the heavenly bodies, changes her place in the sky so rapidly that minute inaccuracies of a second or two in the time of observation would lead to sensible discrepancies in the observed position; an error of one second, in the time, corresponding to about half a second in her place,—a quantity minute, certainly, but perfectly observable. No other heavenly body has an apparent movement anywhere nearly as rapid, excepting only the inner satellite of Mars; and this body is so minute that its accurate observation is impracticable, except with the largest telescopes, and at the times when Mars is unusually near the earth.

Now, of late, the motions of the moon have been very carefully investigated, both theoretically and observationally; and, in spite of everything, there remain discrepancies which defy explanation. We are compelled to admit one of three things,—either the lunar theory is in some degree mathematically incomplete, and fails to represent accurately the gravitational action of the earth and sun, and other known heavenly bodies,

her movements; or some unknown force other than the gravitational attractions of these bodies is operating in the case; or else, finally, the earth's rotational motion is more or less irregular, and so affects the time-reckoning, and confounds prediction.

If the last is really the case, it is in some sense a most discouraging fact, necessarily putting a limit to the accuracy of all prediction, unless some other unchanging and convenient measure of time shall be found to replace the "day" and "second."

The question at once presents itself, How can the constancy of the day be tested? The lunar motions furnish grounds of suspicion, but nothing more; since it is at least as likely that the mathematical theory is minutely incorrect or incomplete as that the day is sensibly variable.

Up to the present time the most effective tests suggested are from the transits of Mercury and from the eclipses of Jupiter's satellites. On the whole, the result of Prof. Newcomb's elaborate and exhaustive investigation of all the observed transits, together with all the available eclipses and occultations of stars, tends rather to establish the sensible constancy of the day, and to make it pretty certain (to use his own language) that "inequalities in the lunar motions, not accounted for by the theory of gravitation, really exist, and in such a way that the mean motion of the moon between 1800 and 1875 was really less (*i.e.* slower) than between 1720 and 1800." Until lately, the observations of Jupiter's satellites have not been made with sufficient accuracy to be of any use in settling so delicate a question; but at present the observation of their eclipses is being carried on at Cambridge, Mass., and elsewhere, by methods that promise a great increase of accuracy over anything preceding. Of course, no *sp.edy* solution of the problem is possible through such observations, and their result will not be so free from mathematical complications as desirable,—complications arising from the mutual action of the satellites, and the ellipsoidal form of the planet. On account of its freedom from all sensible disturbances, the remote and lonely satellite of Neptune may possibly some time contribute useful data to the problem.

We have not time, and it lies outside my present scope, to discuss whether, and, if so, how, it may be possible to find a unit of time (and length) which shall be independent of the earth's conditions and dimensions (free from all *local considerations*), cosmical, and as applicable in the planetary system of the remotest star as in our own. At present we can postpone its consideration; but the time must unquestionably come when the accuracy of scientific observation will be so far increased that the irregularities of the earth's rotation, produced by the causes alluded to a few minutes ago, will protrude, and become intolerable. Then a new unit of time will have to be found for scientific purposes, founded, perhaps, as has been already suggested by many physicists, upon the vibrations or motion of light, or upon some other physical action which pervades the universe.

Another problem of terrestrial astronomy relates to the constancy of the position of the earth's axis in the globe. Just as displacements of matter upon the surface or in the interior of the earth would produce changes in the time of rotation, so also would they cause corresponding alterations in the position of the axis and in the places of the poles,—changes certainly very minute. The only question is, whether they are so minute as to defy detection. It is easy to see that any such displacements of the earth's axis will be indicated by changes in the *latitudes* of our observatories. If, for instance, the Pole were moved a hundred feet from its present position, towards the continent of Europe, the latitudes of European observatories would be increased about one second, while in Asia and America the effects would be trifling.

The only observational evidence of such movements of the Pole, which thus far amounts to anything, is found in the results obtained by Nyren in reducing the determinations of the latitude of Pulkowa, made with the great vertical circle, during the last twenty-five years. They seem to show a slow, steady diminution of the latitude of this Observatory, amounting to about a second in a century; as if the North Pole were drifting away, and increasing its distance from Pulkowa at the rate of about one foot a year.

The Greenwich and Paris observations do not show any such result; but they are not conclusive, on account of the difference of longitude, to say nothing of their inferior precision. The question is certainly a doubtful one; but it is considered of so

similar instruments, in the same manner, and reduced by the same methods and formulæ. So far as possible, the same observers are to be retained through a series of years, and are frequently to change stations when practicable, so as to eliminate personal equations. The main difficulty of the problem lies, of course, in the minuteness of the effect to be detected; and the only hope of success lies in the most scrupulous care and precision in all the operations involved.

Other problems, relating to the rigidity of the earth and its internal constitution and temperature, have, indeed, astronomical bearings, and may be reached to some extent by astronomical methods and considerations; but they lie on the border of our science, and time forbids anything more than their mere mention here.

If we consider, next, the problems set us by the moon, we find them numerous, important, and difficult. A portion of them are purely mathematical, relating to her orbital motion; while others are physical, and have to do with her surface, atmosphere, heat, &c.

As has been already intimated, the lunar theory is not in a satisfactory state. I do not mean, of course, that the moon's deviations from the predicted path are gross and palpable,—such, for instance, as could be perceived by the unaided eye (this I say for the benefit of those who otherwise might not understand how small a matter sets astronomers grumbling),—but they are large enough to be easily observable, and even obtrusive, amounting to several seconds of arc, or miles of space. As we have seen, the attempt to account for them by the irregularity of the earth's rotation has apparently failed; and we are driven to the conclusion, either that other forces than gravitation are operative upon the lunar motions, or else (what is far more probable, considering the past history of theoretical astronomy) that the mathematical theory is somewhere at fault.

To one looking at the matter a little from the outside, it seems as if that which is most needed just now, in order to secure the advance of science in many directions, is a new, more comprehensive, and more manageable solution of the fundamental equations of motion under attraction. Far be it from me to cry out against those mathematicians who delight themselves in transcendental and  $n$ -dimensional spaces, and revel in the theory of numbers,—we all know how unexpectedly discoveries and new ideas belonging to one field of science find use and application in widely different regions,—but I own I feel much more interest in the study of the theory of functions and differential equations, and expect more aid for astronomy from it.

The problem of any number of bodies, moving under their mutual attraction, according to the Newtonian laws, stands, from a physical point of view, on precisely the same footing as that of *two* bodies. Given the masses, and the positions and velocities corresponding to any moment of time, then the whole configuration of the system for all time, past and future (abstracting outside forces, of course), is absolutely determinate, and amenable to calculation. But while, in the case of *two* bodies, the calculation is easy and feasible, by methods known for two hundred years, our analysis has not yet mastered the general problem for more than two. In special instances, by computations, tedious, indirect, and approximate, we can, indeed, carry our prediction forward over long periods, or indicate past conditions with any required degree of accuracy; but a general and universally practicable solution is yet wanting. The difficulties in the way are purely mathematical: a step needs to be taken, corresponding in importance to the introduction of the circular functions into trigonometry, the invention of logarithms, or the discovery of the calculus. The problem confronts the astronomer on a hundred different roads; and, until it is overcome, progress in these directions must be slow and painful. One could not truly say, perhaps, that the lunar theory must, in the meanwhile, remain quite at a standstill: labour expended in the old ways, upon the extension and development of existing methods, may not be fruitless, and may, perhaps, after a while, effect the reconciliation of prediction and observation far beyond the present limits of accuracy. But if we only had the mathematical powers we long for, the progress would be a flying: we should fly, where now we crawl.

simply reflected sunlight and sun-heat, and that the temperature of the lunar surface nowhere rises as high as the freezing-point of water, or even of mercury. At the same time, some astronomers of reputation are not disposed to admit such an upsetting of long-received ideas; and it is quite certain that, in the course of the next few years, the subject will be carefully and variously investigated.

Closely connected with this is the problem of a lunar atmosphere—if, indeed, she has any.

Then there is the very interesting discussion concerning changes upon the moon's surface. Considering the difference between our modern telescopes and those employed fifty or a hundred years ago, I think it still far from certain that the differences between the representations of earlier and later observers necessarily imply any real alterations. But they, no doubt, render it considerably *probable* that such alterations have occurred, and are still in progress; and they justify a persistent, careful, minute, and thorough study of the details of the lunar surface with powerful instruments: especially do they inculcate the value of large-scale photographs, which can be preserved for future comparison as unimpeachable witnesses.

I will not leave the moon without a word in respect to the remarkable speculations of Prof. George Darwin concerning the tidal evolution of our satellite. Without necessarily admitting all the numerical results as to her age and her past and future history, one may certainly say that he has given a most plausible and satisfactory explanation of the manner in which the present state of things might have come about through the operation of causes known and recognised, has opened a new field of research, and shown the way to new dominions. The introduction of the doctrine of the conservation of energy, as a means of establishing the conditions of motion and configuration in an astronomical system, is a very important step.

In the planetary system we meet, in the main, the same problems as those that relate to the moon, with a few cases of special interest.

For the most part, the accordance between theory and observation in the motions of the larger planets is as close as could be expected. The labours of Leverrier, Hill, Newcomb, and others, have so nearly cleared the field, that it seems likely that several decades will be needed to develop discrepancies sufficient to furnish any important corrections to our present tables. Leverrier himself, however, indicated one striking and significant exception to the general tractableness of the planets. Mercury, the nearest to the sun, and the one, therefore, which ought to be the best behaved of all, is rebellious to a certain extent: the perihelion of its orbit moves around the sun more rapidly than can be explained by the action of the other known planets. The evidence to this effect has been continually accumulating ever since Leverrier first announced the fact, some thirty years ago; and the recent investigation by Prof. Newcomb, of the whole series of observed transits, puts the thing beyond question. Leverrier's own belief (in which he died) was that the effect is due to an unknown planet or planets between Mercury and the sun; but, as things now stand, we think that any candid investigator must admit that the probability of the existence of any such body or bodies of considerable dimensions is vanishingly small. We do not forget the numerous instances of round spots seen on the solar disk, nor the eclipses of Watson, Swift, Trouvelot, and others; but the demonstrated possibility of error or mistake in all these cases, and the tremendous array of negative evidence from the most trustworthy observers, with the best equipment and opportunity, makes it little short of certain that there is no Vulcan in the planetary system.

A ring of meteoric matter between the planet and the sun might account for the motion of the perihelion; but, as Newcomb has suggested, such a ring would also disturb the nodes of Mercury's orbit.

It has been surmised that the cause may be something in the distribution of matter within the solar globe, or some variation in gravitation from the exact law of the inverse square, or some supplementary electric or magnetic action of the sun, or some special effect of the solar radiation, sensible on account of the



planet's proximity, or something peculiar to the region in which the planet moves; but as yet no satisfactory explanation has been established.

Speaking of unknown planets, we are rather reluctantly obliged to admit that it is a part of our scientific duty as astronomers to continue to search for the remaining asteroids; at least, I suppose so, although the family has already become embarrassingly large. Still I think we are likely to learn as much about the constitution, genesis, and history of the solar system from these little flying rocks as from their larger relatives; and the theory of perturbations will be forced to rapid growth in dealing with the effects of Jupiter and Saturn upon their motions.

Nor is it unlikely that some day the searcher for these insignificant little vagabonds may be rewarded by the discovery of some great world, as yet unknown, slow moving in the outer desolation beyond the remotest of the present planetary family. Some configurations in certain cometary orbits, and some almost evanescent peculiarities in Neptune's motions, have been thought to point to the existence of such a world; and there is no evidence, nor even a presumption, against it.

Mercury as yet defies all our attempts to ascertain the length of its day, and the character and condition of its surface. Apparently the instruments and methods now at command are insufficient to cope with the difficulties of the problem; and it is not easy to say how it can be successfully attacked.

With Venus, the earth's twin sister, the state of things is a little better: we do already know, with some degree of approximation, her period of rotation; and the observations of the last few months bid fair, if followed up, to determine the position of her poles, and possibly to give us some knowledge of her mountains, continents, and seas.

It would be rash to say of Mars that we have reached the limit of possible knowledge as regards a planet's surface; but the main facts are now determined, and we have a rather surprising amount of supposed knowledge regarding its geography. By "supposed" I mean merely to insinuate a modest doubt whether some of the map-makers have not gone into a little more elaborate detail than the circumstances warrant. At any rate, while the "areographies" agree very well with each other in respect to the planet's more important features, they differ widely and irreconcilably in minor points.

As regards the physical features of the asteroids, we at present know practically nothing: the field is absolutely open. Whether it is worth anything may be a question; and yet, if one could reach it, I am persuaded that a knowledge of the substance, form, density, rotation, temperature, and other physical characteristics, of one of these little orphans would throw vivid light on the nature and behaviour of inter-planetary space, and would be of great use in establishing the physical theory of the solar system.

The planet Jupiter, lordliest of them all, still, as from the first, presents problems of the highest importance and interest. A sort of connecting-link between suns and planets, it seems as if, perhaps, we might find, in the beautiful and varied phenomena he exhibits, a kind of halfway house between familiar terrestrial facts and solar mysteries. It seems quite certain that no analogies drawn from the earth and the earth's atmosphere alone will explain the strange things seen upon his disk, some of which, especially the anomalous differences observed between the rotation periods derived from the observation of markings in different latitudes, are very similar to what we find upon the sun. "The great red spot" which has just disappeared, after challenging for several years our best endeavours to understand and explain it, still, I think, remains as much a mystery as ever,—a mystery probably hiding within itself the master-key to the constitution of the great orb of whose inmost nature it was an outward and most characteristic expression. The same characteristics are also probably manifested in other less conspicuous but equally curious and interesting markings on the varied and ever-changing countenance of this planet; so that, like the moon, it will well repay the most minute and assiduous study.

Its satellite system also deserves careful observation, especially in respect to the eclipses which occur; since we find in them a measure of the time required for light to cross the orbit of the earth, and so of the solar parallax, and also because, as has been already mentioned, they furnish a test of the constancy of the earth's rotation. The photometric method of observing these eclipses, first instituted by Prof. Pickering at Cambridge in 1878, and since re-invented by Cornu in Paris, has already much increased the precision of the results.

With reference to the mathematical theory of the motion of

these satellites, the same remarks apply as to the planetary theory. As yet nothing appears in the problem to be beyond the power and scope of existing methods, when carried out with the necessary care and prolixity; but a new and more compendious method is most desirable.

The problems of Saturn are much the same as those of Jupiter, excepting that the surface and atmospheric phenomena are less striking, and more difficult of observation. But we have, in addition, the wonderful rings, unique in the heavens, the loveliest of all telescopic objects, the type and pattern, I suppose, of world-making, in actual progress before our eyes. There seems to be continually accumulating evidence from the observations of Struve, Dawes, Henry, and others, that these whirling clouds are changing in their dimensions and in the density of their different parts; and it is certainly the duty of every one who has a good telescope, a sharp eye, and a chastened imagination, to watch them carefully, and set down exactly what he sees. It may well be that even a few decades will develop most important and instructive phenomena in this gauzy girdle of old Chronos. Great care, however, is needed in order not to mistake fancies and illusions for solid facts. Not a few anomalous appearances have been described and commented on, which failed to be recognised by more cautious observers with less vivid imaginations, more trustworthy eyes, and better telescopes.

The outer planets, Uranus and Neptune, until recently, have defied all attempts to study their surface and physical characteristics. Their own motions and those of their satellites, have been well worked out; but it remains to discuss their rotation, topography, and atmospheric peculiarities. So remote are they, and so faintly illuminated, that the task seems almost hopeless; and yet, within the last year or two, some of our great telescopes have revealed faint and evanescent markings upon Uranus, which may in time lead to some further knowledge of that far-off relative. It may, perhaps, be that some great telescope of the future will give us some such views of Neptune as we now get of Jupiter.

There is a special reason for attempts to determine the rotation periods of the planets, in the fact that there is very possibly some connection between these periods on the one hand, and, on the other, the planets' distances from the sun, their diameters and masses. More than thirty years ago, Prof. Kirkwood supposed that he had discovered the relation in the analogy which bears his name. The materials for testing and establishing it were then, however, insufficient, and still remain so, leaving far too many of the data uncertain and arbitrary. Could such a relation be discovered, it could hardly fail to have a most important significance with respect to theories of the origin and development of the planetary system.

The great problem of the absolute dimensions of our system is, of course, commanded by the special problem of the solar parallax; and this remains a problem still. Constant errors of one kind or another, the origin of which is still obscure, seem to affect the different methods of solution. Thus, while experiments upon the velocity of light and heliometric measurements of the displacements of Mars among the stars agree remarkably in assigning a smaller parallax (and greater distance of the sun) than seems to be indicated by the observations of the late transits of Venus, and by methods founded on the lunar motions, on the other hand, the meridian observations of Mars all point to a larger parallax and smaller distance. While still disposed to put more confidence in the methods first named, I, for one, must admit that the margin of probable error seems to me to have been rather increased than diminished by the latest published results deduced from the transits. I do not feel so confident of the correctness of the value  $8''.80$  for the solar parallax as I did three years ago. In its very nature, this problem is one, however, that astronomers can never have done with. So fundamental is it, that the time will never come when they can properly give up the attempt to increase the precision of their determination, and to test the received value by every new method that may be found.

The problems presented by the sun alone might themselves well occupy more than the time at our disposal this evening. Its mass, dimensions, and motions, as a whole, are, indeed, pretty well determined and understood; but when we come to questions relating to its constitution, the cause and nature of the appearances presented upon its surface, the periodicity of its spots, its temperature, and the maintenance of its heat, the extent of its atmosphere, and the nature of the corona, we find the most radical differences of opinion.

The difficulties of all solar problems are, of course, greatly

enhanced by the enormous difference between solar conditions and the conditions attainable in our laboratories. We often reach, indeed, similarity sufficient to establish a bond of connection, and to afford a basis for speculation; but the dissimilarity remains so great as to render quantitative calculations unsafe, and make positive conclusions more or less insecure. We can pretty confidently infer the presence of iron and hydrogen and other elements in the sun by appearances which we can reproduce upon the earth; but we cannot safely apply empirical formulæ (like that of Dulong and Petit, for instance), deduced from terrestrial experiments, to determine solar temperatures: such a proceeding is an unsound and unwarrantable extrapolation, likely to lead to widely erroneous conclusions.

For my own part, I feel satisfied as to the substantial correctness of the generally received theory of the sun's constitution, which regards this body as a great ball of intensely heated vapours and gases, clothed outwardly with a coat of dazzling clouds formed by the condensation of the less volatile substances into drops and crystals like rain and snow. Yet it must be acknowledged that this hypothesis is called in question by high authorities, who maintain, with Kirchoff and Zöllner, that the visible photosphere is no mere layer of clouds, but either a solid crust, or a liquid ocean of molten metals; and there may be some who continue to hold the view of the elder Herschel (still quoted as authoritative in numerous school-books), that the central core of the sun is a solid and even habitable globe, having the outer surface of its atmosphere covered with a sheet of flame maintained by some action of the matter diffused in the space through which the system is rushing. We must admit that the question of the sun's constitution is not yet beyond debate.

And not only the constitution of the sun itself, but the nature and condition of the matter composing it, is open to question. Have we to do with iron and sodium and hydrogen as we know them on the earth, or are the solar substances in some different and more elemental state?

However confident many of us may be as to the general theory of the constitution of the sun, very few, I imagine, would maintain that the full explanation of sun-spots and their behaviour has yet been reached. We meet continually with phenomena, which, if not really contradictory to prevalent ideas, at least do not find in them an easy explanation.

So far as mere visual appearances are concerned, I think it must be conceded that the most natural conception is that of a dark chip or scale thrown up from beneath, like scum in a cauldron, and floating, partly submerged, in the blazing flames of the photosphere which overhang its edges, and bridge across it, and cover it with filmy veils, until at last it settles down again and disappears. It hardly *looks* like a mere hollow filled with cooler vapour, nor is its appearance that of a cyclone seen from above. But then, on the other hand, its spectrum under high dispersion is very peculiar, not at all that of a solid, heated slag, but it is made up of countless fine dark lines, packed almost in contact, showing, however, here and there, a bright line, or at least an interspace where the rank is broken by an interval wider than that which elsewhere separates the elementary lines,—a spectrum which, so far as I know, has not yet found an analogue in any laboratory experiment. It seems, however, to belong to the type of absorption spectra, and to indicate, as the accepted theory requires, that the spot is dark in consequence of *loss* of light, and not from any original defect of luminosity. Here, certainly, are problems that require solution.

The problem of the sun's peculiar rotation and equatorial acceleration appears to me a most important one, and still unsolved. Probably its solution depends in some way upon a correct understanding of the exchanges of matter going on between the interior and the surface of the fluid, cooling globe. It is a significant fact (already alluded to) that a similar relation appears to hold upon the disk of Jupiter, the bright spots near the equator of the planet completing their rotation about five minutes more quickly than the great red spot which was forty degrees from the equator. It is hardly necessary to say that an astronomer, watching our terrestrial clouds from some external station (on the moon, for instance), would observe just the reverse. Equatorial clouds would complete their revolution *more* slowly than those in our own latitude. Our storms travel towards the east, while the volcanic dust from Krakatoa moved swiftly west. We may at least conjecture that the difference between different planets somehow turns upon the question whether the body whose atmospheric currents we observe is receiving more heat from without than it is throwing off itself.

Whatever may be the true explanation of this peculiarity in the motion of sun-spots, it will, when reached, probably carry with it the solution of many other mysteries, and will arbitrate conclusively between rival hypotheses.

The periodicity of the sun-spots suggests a number of important and interesting problems, relating, on the one hand, to its mysterious cause, and, on the other, to the possible effects of this periodicity upon the earth and its inhabitants. I am no "sun-spottist" myself, and am more than sceptical whether the terrestrial influence of sun-spots amounts to anything worth speaking of, except in the direction of magnetism. But all must concede, I think, that this is by no means yet demonstrated (it is not easy to prove a negative); and there certainly are facts and presumptions enough tending the other way to warrant more extended investigation of the subject. The investigation is embarrassed by the circumstance, pointed out by Dr. Gould, that the effects of sun-spot periodicity, if they exist at all (as he maintains they do), are likely to be quite different in different portions of the earth. The influence of changes in the amount of the solar radiation will, he says, be first and chiefly felt in alterations and deflections of the prevailing winds, thus varying the *distribution* of heat and rain upon the surface of the earth without necessarily much changing its *absolute amount*. In some regions it may, therefore, be warmer and drier during a sun-spot maximum, while in adjoining countries it is the reverse.

There can be no question that it is now one of the most important and pressing problems of observational astronomy to devise apparatus and methods delicate enough to enable the student to follow promptly and accurately the presumable changes in the daily, even the hourly, amounts of the solar radiation. It might, perhaps, be possible with existing instruments to obtain results of extreme value from observations kept up with persistence and scrupulous care for several years at the top of some rainless mountain, if such can be found; but the undertaking would be a difficult and serious affair, quite beyond any private means.

Related to this subject is the problem of the connection between the activity of the solar surface and magnetic disturbances on the earth,—a connection unquestionable as matter of fact, but at present unexplained as matter of theory. It may have something to do with the remarkable prominence of iron in the list of solar materials; or the explanation may, perhaps, be found in the mechanism by means of which the radiations of light and heat traverse inter-planetary space, preventing itself ultimately as a corollary of the perfected electro-magnetic theory of light.

The chromosphere and prominences present several problems of interest. One of the most fruitful of them relates to the spectroscopic phenomena at the base of the chromosphere, and especially to the strange differences in the behaviour of different spectrum-lines, which, according to terrestrial observations, are due to the same material. Of two lines (of iron, for instance) side by side in the spectrum, one will glow and blaze, while the other will sulk in imperturbable darkness; one will be distorted and shattered, presumably by the swift motion of the iron vapour to which it is due, while the other stands stiff and straight.

Evidently there is some deep lying cause for such differences; and as yet no satisfactory explanation appears to me to have been reached, though much ingenious speculation has been expended upon it. Mr. Lockyer's bold and fertile hypothesis, already alluded to, that at solar and stellar temperatures our elements are decomposed into others more elemental yet, seems to have failed of demonstration thus far, and rather to have lost ground of late; and yet one is almost tempted to say, "It *ought* to be true," and to add that there is more than a possibility that its essential truth will be established some time in the future.

Probably all that can be safely said at present is, that the spectrum of a metallic vapour (iron, for instance, as before) depends not only upon the chemical element concerned, but also upon its physical conditions; so that, at different levels in the solar atmosphere, the spectrum of the iron will differ greatly as regards the relative conspicuousness of different lines; and so it will happen, that, whenever any mass of iron vapour is suffering disturbance, those lines only which particularly characterise the spectrum of iron in that special state will be distorted or reversed, while all their sisters will remain serene.

The problem of the solar corona is at present receiving much attention. The most recent investigations respecting it—those of Mr. Huggins and Prof. Hastings—end in directions

which appear to be diametrically opposite. Dr. Huggins considers that he has succeeded in photographing the corona in full sunshine, and so in establishing its objective reality as an immense solar appendage, sub-permanent in form, and rotating with the globe to which it is attached. One may call it "an atmosphere," if the word is not to be too rigidly interpreted. I am bound to say that plates which he has obtained do really show just such appearances as would be produced by such a solar appendage, though they are very faint and ghost-like. I may add further, that, from a letter from Dr. Huggins, recently received, I learn that he has been prevented from obtaining any similar plates in England this summer by the atmospheric haze, but that Dr. Woods, who has been provided with a similar apparatus, and sent to the Riffelberg in Switzerland, writes that he has "an assured success."

Our American astronomer, on the other hand, at the last eclipse (in the Pacific Ocean), observed certain phenomena which seem to confirm a theory he had formulated some time ago, and to indicate that the lovely apparition is an apparition only, a purely optical effect due to the *diffraction* (not *refraction*, nor reflection either) of light at the edge of the moon—no more a solar appendage than a rainbow or a mock sun. There are mathematical considerations connected with the theory which may prove decisive when the paper of its ingenious and able proposer comes to be published in full. In the meantime it must be frankly conceded that the observations made by him are very awkward to explain on any other hypothesis.

Whatever may be the result, the investigation of the status and possible extent of a nebulous envelope around a sun or a star is unquestionably a problem of very great interest and importance. We shall be compelled, I believe, as in the case of comets, to recognise other forces than gravity, heat, and ordinary gaseous elasticity, as concerned in the phenomena. As regards the actual existence of an extensive gaseous envelope around the sun, I may add that other appearances than those seen at an eclipse seem to demonstrate it beyond question,—phenomena such as the original formation of clouds of incandescent hydrogen at high elevations, and the forms and motions of the loftiest prominences.

But of all solar problems, the one which excites the deepest and most general interest is that relating to the solar heat, its maintenance and its duration. For my own part, I find no fault with the solution proposed by Helmholtz, who accounts for it mainly by the slow contraction of the solar sphere. The only objection of much force is that it apparently limits the past duration of the solar system to a period not much exceeding some twenty millions of years, and many of our geological friends protest against so scanty an allowance. The same theory would give us, perhaps, half as much time for our remaining lifetime; but this is no objection, since I perceive no reason to doubt the final cessation of the sun's activity, and the consequent death of the system. But while this hypothesis seems fairly to meet the requirements of the case, and to be a necessary consequence of the best knowledge we can obtain as to the genesis of our system and the constitution of the sun itself, it must, of course, be conceded that it does not yet admit of any observational verification. No measurements within our power can test it, so far as we can see at present.

It may be admitted, too, that much can be said in favour of other theories; such as the one which attributes the solar heat to the impact of meteoric matter, and that other most interesting and ingenious theory of the late Sir William Siemens.

As regards the former, however, I see no escape from the conclusion, that, if it were exclusively true, the earth ought to be receiving, as was pointed out by the late Prof. Peirce, as much heat from meteors as from the sun. This would require the fall of a quantity of meteoric matter, more than sixty million times as much as the best estimates make our present supply, and such as could not escape the most casual observation, since it would amount to more than a hundred and fifty<sup>1</sup> tons a day on every square mile.

<sup>1</sup> In an article on astronomical collisions, published in the *North American Review* about a year ago, I wrongly stated the amount at fifty tons. There was some fatality connected with my calculations for that article. I gave the amount of heat due to the five hundred tons of meteoric matter which is supposed to fall daily on the earth with an average velocity of fifteen miles per second as fifty-three calories annually per square metre,—a quantity two thousand times too great. Probably the error would have been noticed if even the number given had not been so small, compared with the solar heat, as fully to justify my argument, which is only strengthened by the correction. I owe the correction to Prof. LeConte of California, who called my attention to the errors.<sup>2</sup>

As regards the theory of Siemens, the matter has been, of late, so thoroughly discussed, that we probably need spend no time upon it here. To say nothing as to the difficulties connected with the establishment of such a far-reaching vortex as it demands, nor of the fact that the temperature of the sun's surface appears to be above that of the dissociation point of carbon compounds, and hence above their highest heat of combustion, it seems certainly demonstrated that matter of the necessary density could not exist in inter-planetary space without seriously affecting the planetary motions by its gravitating action as well as by its direct resistance; nor could the stellar radiations reach us, as they do, through a medium capable of taking up and utilising the rays of the sun in the way this theory supposes.

And yet I imagine that there is a very general sympathy with the feeling that led to the proposal of the theory,—an uncomfortable di-satisfaction with received theories, because they admit that the greater part of the sun's radiant energy is, speaking from a scientific point of view, simply wasted. Nothing like a millionth part of the sky, as seen from the sun, is occupied, so far as we can make out, by objects upon which its rays can fall: the rest is vacancy. If the sun sends out rays in all directions alike, not one of them in a million finds a target, or accomplishes any useful work, unless there is in space some medium to utilise the rays, or unknown worlds, of which we have no cognisance, beyond the stars.

Now, for my own part, I am very little troubled by accusations of wastefulness against Nature, or by demands for theories which will show what the human mind can recognise as "use" for all energy expended. Where I can perceive such use, I recognise it with reverence and gratitude, I hope; but the failure to recognise it in other cases creates in my mind no presumption against the wisdom of Nature, or against the correctness of an hypothesis otherwise satisfactory. It merely suggests human limitations and ignorance. How can one without sight understand what a telescope is good for?

At the same time, perhaps we assume with a little too much confidence that, in free space, radiation does take place equally in all directions. Of course, if the received views as to the nature and conduct of the hypothetical "ether" are correct, there is no possibility of questioning the assumption; but, as Sir John Herschel and others have pointed out, the properties which must be ascribed to this "ether," to fit it for its various functions, are so surprising and almost inconceivable, that one may be pardoned for some reserve in accepting it as a finality. At any rate, as a fact, the question is continually started (the idea has been brought out repeatedly, in some cases by men of real and recognised scientific and philosophic attainment), whether the constitution of things may not be such that radiation and transfer of energy can take place only between ponderable masses; and that, too, without the expenditure of energy upon the transmitting-agent (if such exist) along the line of transmission, even *in transitu*. If this were the case, then the sun would send out its energy only to planets and meteors and sister-stars, wasting none in empty space; and so its loss of heat would be enormously diminished, and the time-scale of the life of the planetary system would be correspondingly extended. So far as I know, no one has ever yet been able to indicate any kind of medium or mechanism by which vibrations, such as we know to constitute the radiant energy of light and heat, can be transmitted at all from sun to planet under such restrictions. Still one ought not to be too positive in assertions as to the real condition and occupancy of so-called vacant space. The "ether" is a good working hypothesis, but hardly more as yet.

I need not add that a most interesting and as yet inaccessible problem, connected with the preceding, is that of the mechanism of gravitation, and, indeed, of all forces that seem to act at a distance; as, for that matter, in the last analysis, *all* forces do. If there really be an "ether," then it would seem that somehow all attractions and repulsions of ponderable matter must be due to its action. Challis's investigations and conclusions as to the effect of hydrodynamic actions in such a medium do not seem to have commanded general acceptance; and the field still lies open for one who will show how gravitation and other forces can be correlated with each other through the ether.

Meteors and comets, seeming to belong neither to the solar system nor to the stellar universe, present a crowd of problems as difficult as they are interesting. Much has undoubtedly been gained during the last few decades; but in some respects that which has been learned has only deepened the mystery.

The problem of the origin of comets has been supposed to be solved to a certain extent by the researches of Schiaparelli, Heis,

Prof. Newton, and others, who consider them to be strangers coming in from outer space, sometimes "captured" by planets, and forced into elliptic orbits, so as to become periodic in their motion. Certainly this theory has strong supports and great authority, and probably it meets the conditions better than any other yet proposed. But the objections are really great, if not insuperable,—the fact that we have so few, if any, comets moving in hyperbolic orbits, as comets met by the sun would be expected to move; that there seems to be so little relation between the direction of the major axis of cometary orbits and the direction of the solar motion in space; and especially the fact, pointed out and insisted upon by Mr. Proctor in a recent article, that the direction of a comet's natural parabolic orbit to the observed elliptic one, by planetary action, implies a reduction of the comet's velocity greater than can be reasonably explained. If, for instance, Bror-en's comet (which has a mean distance from the sun a little more than three times that of the earth) was really once a parabolic comet, and was diverted into its present path by the attraction of Jupiter, as generally admitted, it must have had its velocity reduced from about eleven miles a second to five. Now, it is very difficult, if not out of the question, to imagine any possible configuration of the two bodies and their orbits which could result in so great a change. While I am by no means prepared to indorse as conclusive all the reasoning in the article referred to, and should be very far from ready to accept the author's alternative theory (that the periodic comets have been ejected from the planets, and so are not their captives, but their children), I still feel that the difficulty urged against the received theory is very real, and not to be evaded, though it may possibly be overcome by future research.

Still more problematical is the constitution of these strange objects of such enormous volume and inconceivable tenuity, self-luminous and transparent, yet reflecting light, the seat of forces and phenomena unparalleled in all our other experience. Hardly a topic relating to their appearance and behaviour can be named which does not contain an unsolved problem. The varying density, polarisation, and spectroscopic character of their light; the configurations of the nucleus and its surrounding nebulosity; and especially the phenomena of jets, envelopes, and tail,—all demand careful observation and thorough discussion.

I think it may be regarded as certain that the explanation of these phenomena when finally reached, if that time ever comes, will carry with it, and be based upon, an enormous increase in our knowledge as to the condition, contents, and temperature of inter-planetary space, and the behaviour of matter when reduced to lowest terms of density and temperature.

Time forbids any adequate discussion of the numerous problems of stellar astronomy. One work, in its very nature incessant and interminable, consists, of course, in the continual observation and cataloguing of the places of the stars, with ever-increasing precision. These star-places form the scaffold and framework of all other astronomical investigations involving the motions of the heavenly bodies: they are the reference-points and bench-marks of the universe. Ultimately, too, the comparison of catalogues of different dates will reveal the paths and motions of all the members of the starry host, and bring out the real orbit of the sun and his attendant planets.

Meanwhile, micrometric observations are in order, upon the individual stars in different clusters, to ascertain the motions which occur in such a case; and the mathematician is called upon again to solve the problem of such movement.

Now, too, since the recent work of Gill and Elkin in South Africa, and of Struve, Hall, and others, elsewhere, upon stellar parallaxes, new hopes arise that we may soon come to some wider knowledge of the subject; that, instead of a dozen or so parallaxes of doubtful precision, we may get a hundred or more relating to stars of widely different brightness and motion, and be enabled to reach some trustworthy generalisations as to the constitution and dimensions of the stellar universe, and the actual rates of stellar and solar motion in space.

Most interesting, also, are the studies now so vigorously prosecuted by Prof. Pickering in this country, and many others elsewhere, upon the brightness of the stars, and the annual variations in this brightness. Since 1875, stellar photometry is become almost a new science.

Then there are more than a myriad of double and multiple stars to watch, and their orbits to be determined; and the nebulae claim keen attention, since some of them appear to be changing form and brightness, and are likely to reveal to us some wonderful secrets in the embryology of worlds.

Each star also presents a subject for spectroscopic study; for

although, for the most part, the stars may be grouped into a very few classes from the spectroscopic point of view, yet, in detail, the spectra of objects belonging to the same group differ considerably and significantly, almost as much as human faces do.

For such investigations, new instruments are needed, of unexampled powers and accuracy, some for angular measurement, some for mere power of seeing. Photography comes continually more and more to the front; and the idea sometimes suggests itself that by and by the human eye will hardly be trusted any longer for observations of precision, but will be superseded by an honest, unprejudiced, and unimaginative plate and camera. The time is not yet, however, most certainly. Indeed, it can never come at all, as relates to certain observations; since the human eye and mind together integrate, so to speak, the impressions of many separate and selected moments into one general view, while the camera can only give a brutal copy of an unselected state of things, with all its atmospheric and other imperfections.

New methods are also needed, I think (they are unquestionably possible), for freeing time-observations from the errors of personal equation; and increased precision is demanded, and is being progressively attained, in the prevention or elimination of instrumental errors, due to differences of temperature, to mechanical strains, and to inaccuracies of construction. Astronomers are now coming to the investigation of quantities so minute that they would be completely masked by errors of observation that formerly were usual and tolerable. The science has reached a stage, where, as was indicated at the beginning of this address, it has to confront and deal with the possible unsteadiness of the earth's rotation, and the instability of its axis. The astronomer has now to reverse the old maxim of the courts: for him, and most emphatically at present, *De minimis curat lex*. Residuals and minute discrepancies are the seeds of future knowledge, and the very foundations of new laws.

And now, in closing this hurried and inadequate, but I fear rather tedious, review of the chief problems that are at present occupying the astronomer, what answer can we give to him who insists, *Cui bono?* and requires a reason for the enthusiasm that makes the votaries of our science so ardent and tireless in its pursuit? Evidently very few of the questions which have been presented have much to do directly with the material welfare of the human race. It may possibly turn out, perhaps, that the investigation of the solar radiation, and the behaviour of sun-spots, may lead to some better understanding of terrestrial meteorology, and so aid agricultural operations and navigation. I do not say it will be so,—in fact, I hardly expect it,—but I am not sure it will not. Possibly, too, some few other astronomical investigations may facilitate the determination of latitudes and longitudes, and so help exploration and commerce; but, with a few exceptions, it must be admitted that modern astronomical investigations have not the slightest immediate commercial value.

Now, I am not one of those who despise a scientific truth or principle because it admits of an available application to the affairs of what is called "practical life," and so is worth something to the community in dollars and cents: its commercial value is—just what it is—to be accepted gratefully.

Indirectly, however, almost all scientific truth has real commercial value, because "knowledge is power," and because (I quote it not irreverently) "the truth shall make you free,"—any truth, and to some extent; that is to say, the intelligent and intellectually cultivated will generally obtain a more comfortable livelihood, and do it more easily, than the stupid and the ignorant. Intelligence and brains are most powerful allies of strength and hands in the struggle for existence; and so, on purely economical grounds, all kinds of science are worthy of cultivation.

But I should be ashamed to rest on this lower ground: the highest value of scientific truth is not economic, but different and more noble; and, to a certain and great degree, its truest worth is more as an object of pursuit than of possession. The "practical life"—the eating and the drinking, the clothing and the sheltering—comes first, of course, and is the necessary foundation of anything higher; but it is not the whole or the best or the most of life. Apart from all spiritual and religious considerations, which lie on one side of our relation: in this Association, there can be no need, before this audience, to plead the higher rank of the intellectual, æsthetic, and moral life above the material, or to argue that the pabulum of the mind is worth

as much as food for the body. Now, I am sure I can safely assert that, in the investigation and discovery of the secrets and mysteries of the heavens, the human intellect finds most invigorating exercise, and most nourishing and growth-making aliment. What other scientific facts and conceptions are more effective in producing a modest, sober, truthful, and ennobling estimate of man's just place in Nature, both of his puny insignificance, regarded as a physical object, and his towering spirit, in some sense comprehending the universe itself, and so akin to the divine?

A nation bound to the dust, and near to starving, needs first, most certainly, the trades and occupations that will feed and clothe it. When bodily comfort has been achieved, then higher needs and wants appear; and then science, for truth's own sake, comes to be loved and honoured along with poetry and art, leading men into a larger, higher, and nobler life.

### SCIENTIFIC SERIALS

THE *Journal of the Franklin Institute* for July contains:—How to determine the grade of expansion and the size of a steam-engine which is to perform a given duty with the least total expenditure of money per working hour, by L. D'Auria.—Present state of the subject: "Heat of combustion of coal," by Chief Engineer Isherwood, U.S.N. (with figures and tables).—New York to Chicago in seventeen hours, by W. Barnett Le Van (4 diagrams).—Electro-dynamics, by John W. Nystrom.—A short paper criticising Moncel's formulæ in "Electricity as a Motive Power."—The ellipticity of planets, by Pliny Earle Chase, LL.D.—The discharge of turbine water-wheels, by J. P. Frizell (with tables).—The iridium industry, by Wm. L. Dudley (illustrated).—Physical and chemical tests of steel for boiler and ship plates for the U.S. Government cruisers, by Pedro G. Salom (5 pages of tables).—To tell iron from steel in small pieces (translated from Dingler's *Polytechnisches Journal*, by W. F. Worthington, U.S.N.—Report on the trial of the "City of Fall River," by J. E. Sague, M.E., and J. B. Adger, M.E.—Correspondence.—Book Notices.—Franklin Institute.—Items.—Low temperatures.—Ventilation of sewers.—Marsant's safety lamp.

*Rivista Scientifico-Industriale*, June and July.—Exposition of a new theory on the formation of hailstones; experiments on their artificial production, by Prof. Giovanni Luvini.—Remarks on radiant heat in connection with the second law of thermodynamics, by Prof. Adolfo Bartoli.—On the various hypotheses hitherto proposed to harmonise the results of the theory of radiation with the second law of thermodynamics, by the same author.—On Lambert's thermo-hygroscope, by the Editor.—Researches on the persistence of life and the vital functions in insects after decapitation, by Dante Roster.

*Bulletin de l'Académie Royale de Belgique*, June 7.—Obituary notice of M. F. Duprez, by M. Van der Mensbrugge.—A contribution to the study of drinking-waters, and especially of those supplied to the city of Louvain, by M. Blas.—Researches on the germination of linseed and sweet almonds, by M. A. Jorissen.—On the Marine Station at Edinburgh, by MM. Van Beneden and Renard.—Note on a flint instrument discovered in the Quaternary alluvia of Hainaut in association with the remains of the mammoth, rhinoceros, and horse, by F. L. Cornet.—Discourse pronounced at the obsequies of M. Louis Hymans, by M. Wagener.—On gymnastic exercises in the Belgian educational establishments, by M. Vincent de Block.—On the poetical works of Jean d'Outremeuse, by M. Stanislas Bormans.

*Archives des Sciences physiques et naturelles (de Genève)*, 3<sup>e</sup> période, tomes ix. and x., 1883.—On electrolytic condensers, by C. E. Guillaume.—The determination of the absolute capacity of some condensers in electro-magnetic units, by M. Schneebeli.—On the theory of atmospheric absorption of solar radiation, by J. Maurer.—Note on cometary refraction, by G. Cellérier.—Researches on the absorption of ultra-violet rays by various bodies, by J. L. Soret.—Remarkable movements which sometimes follow the fall of hailstones and sleet, by D. Colladon.—Theory of dynamo-electric machinery, by R. Clausius.—Adjustment of resistance coils, by S. P. Thompson.

### SOCIETIES AND ACADEMIES

#### PARIS

Academy of Sciences, September 8.—M. Rolland, President, in the chair.—The sitting was opened by the President

with a few remarks on the ninety-ninth anniversary of M. Chevreul, *doyen* of the Academy.—Researches on the general development of vegetation in an annual plant (continued): nitrous elements and mineral constituents, by MM. Berthelot and André.—Note on the general resolution of the linear equation in matrices of any order, by Prof. Sylvester.—Remarks on balloon steering, by M. Duroy de Bruignac. The author considers that the experiment of August 9 at Chalais introduces a new phase of aerial navigation; and that the problem hitherto regarded as hopeless may soon be completely solved. It must, however, always remain of difficult application, the results depending on two essential conditions: that is, the necessity of increasing the propelling power and of diminishing the resistance of the air. A simple calculation shows that this resistance is in proportion to the cube of the sine in the angle of incidence of the prevailing atmospheric current. Hence for the small angles, which are rightly preferred, we get a variation of from 2° to 4° double or treble, or thereabouts, a tremendous obstacle, which has to be overcome.—Observations of the new Borely planet 240, made at the Observatory of Algiers, by M. Ch. Trépied.—Observations of the solar spots and faculæ made at the Observatory of the Collegio Romano during the second quarter of the present year, by M. Tacchini.—A new contribution to the question of the origin of the phosphates of lime in the South-West of France, by M. Dieulafait. The author refers these formations to the action of saline waters during the Tertiary epoch, analogous to if not identical with those of the lagoons at the present time. The saline and concentrated waters of these lagoons, which certainly existed in Tertiary times, played a double part in the production of the natural phosphates of lime. In the first place they attacked the limestone rocks far more actively than ordinary water could have done; and then they contribute directly phosphoric acid, which is still being deposited in the shallow lagoons of the Rhone delta.—Experiments made for the purpose of testing the influence of pulps and other artificially prepared foods on cow's milk, by MM. A. Andouard and V. Dezaunay. These experiments, carried on during the years 1883 and 1884, tended to show that the prepared foods acted injuriously on the milk, but increased the quantity of butter without affecting its quality.—On the solar coronas recently observed in Switzerland, at Nice, and elsewhere, by M. L. Thollon. From a comparative study of the different accounts received of these phenomena, the author concludes that they are not merely halos, but true coronas, that is, an effect of diffraction produced either by fine dust or by light particles of moisture present in the elevated regions of the atmosphere.—Description of a meteor observed at the Trocadéro Observatory on the night of September 5, by M. L. Jaubert.

### CONTENTS

	PAGE
The Zoological Collections of H.M.S. "Alert" . . . . .	485
Letters to the Editor:—	
The Flow of Streams.—George Maw; J. P. G. Smith. (Illustrated) . . . . .	486
Ocean Swells.—Col. H. H. Godwin-Austen . . . . .	487
Salmon-Breeding.—Francis Day . . . . .	488
Hydrodictyon in the Eastern Counties.—Rev. J. C. Saunders . . . . .	—
The Sky-Glows.—J. Edmund Clark; J. Gledhill; Clement L. Wragge; W. Larden . . . . .	488
Pipe-Clay.—A. Hale . . . . .	489
Repulsion.—D. D. Heath . . . . .	490
Fellow-Feeling in House-Flies and Swallows.—J. M. H. . . . .	490
Rainbow on Spray.—Frank E. Cane . . . . .	490
Japanese Education . . . . .	490
British Birds at the Natural History Museum. (Illustrated) . . . . .	491
Notes . . . . .	494
Our Astronomical Column:—	
Astronomical Photography . . . . .	496
The British Association Catalogue of Stars . . . . .	496
The Comet 1884 <sup>b</sup> . . . . .	496
The British Association:—	
Reports . . . . .	496
Pending Problems of Astronomy. By Prof. C. A. Young . . . . .	501
Scientific Serials . . . . .	508
Societies and Academies . . . . .	508

THURSDAY, SEPTEMBER 25, 1884

MODERN STEAM PRACTICE AND  
ENGINEERING

*Modern Steam Practice and Engineering.* By John G. Winton, assisted by W. J. Millar, C.E. (London: Blackie and Sons, 1883.)

THE want has long been felt by those employed in the engineering works of this country of a book which shall serve as a guide to the various operations in the workshop, giving a practical yet concise description of the various methods employed, and the reason for using every particular method. In some works we find the business conducted in an old-fashioned stereotyped way, and in others all the latest improvements are introduced. The number of workmen who can give the real reason for using any particular method is very small, the reason generally given being, "The work has always been done that way?" It is here where the apprentice finds one of the many difficulties he has to overcome; he can see the work done, but cannot fathom the reason for doing it any particular way; his foreman perhaps being too busy to help him, he has to do the best he can.

The volume before us will go a long way towards solving this difficulty. The author, being a practical man, treats the subject in a thoroughly practical way, using the technical language of the shops, thereby making the various descriptions and plates throughout the volume exceedingly clear. At the same time the higher principles involved in the various machines described are not overlooked, so that it is also a valuable book of reference in the drawing office, as well as a useful companion to those who have charge of men engaged in the various branches of mechanical engineering. For students attending the workshops and classes of the various engineering colleges it will be found to be very useful, giving as it does a practical description of the work, and helping considerably to get that knowledge which can alone be got in the workshops of the country.

The book is divided into five sections, subdivided into chapters.

Section I. is on the boiler and steam, commencing with a short chapter on coal and coal-mining. The author gives a short account of the troubles of the miner, and tells us of the methods in use for lining the shafts. Ventilation is dealt with; the various exhaust fans are next mentioned, with an illustration of the gimbal fan; then the author goes on to the usual methods for getting the coal. The chapter is a very appropriate commencement to the volume, although it gives a rather short account of the coal-mining industry.

We then come to a long chapter on stationary boilers, giving a good description of the various types in use. We miss the Lancashire boiler, with its two flues and conical water-tubes, from the illustrations. The author discusses the strength of riveted joints, giving the results of some experiments. We should have liked to find here a short account of the important researches on the strength of riveted joints carried out by Prof. Kennedy at the Engineering Schools of Uni-

versity College, London. The strength of cylindrical boilers is gone into fully, the various strains tending to rupture the plates are pointed out, and tables are given showing the proper thickness of plates for the different diameters. It is impossible here to give anything like a complete *résumé* of this chapter, no pains having been spared to get together as much information as possible; the author has succeeded in making it one of the most useful chapters in the work. He goes on to the foundations and settings for the different types of boiler, giving an account of the dimensions for the chimney. Smoke prevention is discussed, the conclusion at which the author arrives being thus stated: "We unhesitatingly give as our opinion that unless the attendant sees that the furnace is kept in proper trim, firing with the least quantity of coal, oftentimes replenished, all the refinements for the prevention of smoke will not attain the desired object, for careful firing is the main secret to arrive at."

Boilers for marine purposes are dealt with in a similar manner, the various types being discussed and illustrated. The arrangement of boilers for ships of war is gone into, high-pressure boilers having a fair share of the text. The proportions of marine boilers are treated, and suitable rules given for calculating the various dimensions, the chapter concluding with an illustration of the boilers of the s.s. *Parisian*, of the Allan Line of Atlantic steamers.

After showing the various methods for superheating and drying the steam by means of superheaters, both tubular and cylindrical, the author explains the methods of manufacture of boilers, more especially the best arrangement of plates and angle iron, and the staying of flat surfaces. We agree with the author when he says that this subject closely affects the interests of steam users, and the extract from a report of the National Boiler Insurance Company is well worth studying. Section I. concludes with the regulation and expansion of steam. The action of the slide valve is thoroughly explained, and the benefits derived from lap and lead pointed out. The different arrangements of the link motion are illustrated and clearly explained, then equilibrium slide valves are discussed and the arrangements clearly illustrated. The action of the indicator and the mode of driving the roller cylinder is shown; some very good examples of indicator diagrams taken from simple and compound engines are given; the section closing with a short chapter on the expansion of steam, with tables of hyperbolic logarithms, and the properties of saturated steam at different pressures.

Section II. is entirely devoted to stationary engines, commencing with the Cornish pumping-engine, afterwards dealing with the several different types of pumping-engines,—as pumping-engines for water-works, drainage works, and general purposes. The reader will here grasp the immense amount of trouble the author has taken to get all the information together, down to the smallest detail; each class of engine being well illustrated, its leading features pointed out, and the explanations of the different parts being very clear. Nor are the underground appliances overlooked, the pumps, valves and other parts in connection with the gear are thoroughly described and illustrated.

Pumping-engines for water-works are very similar

to those used for draining mines. We have several good examples; the description of the Tottenham pumping-engines is very interesting; and we have another example in the engines of the Berwick-on-Tweed Waterworks.

Of pumping-engines for drainage purposes, the London drainage system furnishes perhaps the best possible example; the Abbey Mills pumping-station with its eight engines giving an aggregate of 1140 horse-power, capable of dealing with 15,000 cubic feet of sewage per minute, lifting it 36 feet high; the Deptford pumping-station, with a horse-power of 500, lifting 10,000 cubic feet of sewage per minute to a height of 18 feet. The pumping-engines at Crossness are also described, having a collective horse-power of 500, dealing with 10,000 cubic feet of sewage per minute, with a varying lift of from 10 to 30 feet according to circumstances.

After a short account of an arrangement of centrifugal pumping machinery, the author deals with winding engines, giving a clear description of this class, and as an example we have a full-page engraving of an engine for the Benhar Coal Company, by Messrs. Gibb and Hogg, Airdrie.

The various types of blowing-engines are described; afterwards rolling-mill engines, having as examples some engines erected at the Dowlais Ironworks, and compound reversing rail-mill engines at the Hallside Steel-works, near Glasgow: these latter are shown in a full-page engraving and are fully described in the text.

Under water-pressure engines we find the accumulator and charging pumps illustrated, the hydraulic crane, and the usual hydraulic machinery for dock gates is described, the section concluding with an account of the hydraulic machinery for warehousing grain at the Liverpool Docks and a full-page engraving of hydraulic machine tools, designed by Mr. R. H. Tweddell.

In Section III. we have the marine engine thoroughly and completely explained. We here see what a tremendous advance has been made in the science of marine engine building, the engines of the latest additions to our mercantile navy being nearly theoretically perfect as far as the economical consumption of steam is concerned, and the proportions of the different parts more in accordance with the individual strains they have to withstand. The author treats the subject fully, each part and detail being illustrated, and reasons given for any peculiarity of construction in the engines described; he then goes on to screw propellers, and kindred appliances, the section concluding with a full-page engraving of the compound engines of the steam-ships *Scrvia* and *Parisian*, the descriptions being very clear and to the point. Rules for the horizontal marine engine finish the section.

Perhaps the locomotive engine, which is treated in Section IV., has advanced by greater strides than any other machine within the last twenty years, the reasons being that the traffic on the railways has got heavier, competition has forced the companies to run the trains at higher speeds, at the same time that the vehicles composing the trains have increased both in size and weight.

This increase means that the engine must have a higher tractive power, which can only be got by increasing the weight on the driving-wheels; larger cylinders must be used, and consequently a larger boiler and fire-box for the

increased consumption of steam. As an example of an express passenger locomotive of the present day, we may take the engines designed by Mr. Stirling for the Great Northern Railway, having driving-wheels 8 feet in diameter, cylinders 18 inches in diameter with a stroke of 2 feet 4 inches. Compare these engines with one built fifteen or twenty years ago, and the marvellous change will be at once apparent.

The author commences the section with a variety of fire-boxes designed to consume the smoke when burning coal, some being very complicated. All locomotives of the present day burn coal, and from the very complicated fire-boxes illustrated, the fire-box has resolved itself into a perfectly plain box, having a brick arch, to mix the products of combustion previous to their passage through the tubes. This when fired properly is quite capable of consuming all the volatile hydrocarbons in the coal without the formation of any smoke.

The illustrations in the earlier part of the section are somewhat old-fashioned; the one showing the stays inside a locomotive boiler might have been of more recent design. We remember having seen a boiler of the same type on a locomotive built in 1847. With this as the only drawback, the section treats the subject in a clear and practical way; we do not know of any work in which one can find so much information.

In the description of the American locomotive, one finds many arrangements which look strange to those accustomed to English practice, but we cannot notice any peculiarity which we think could be adopted in this country with advantage. After a short account of the different classes of automatic continuous brakes, in which the Westinghouse and vacuum automatic brakes are discussed, we have some very good examples of the latest locomotive practice of this country. The engraving showing the vertical and horizontal sections of a bogie passenger engine, for the Caledonian Railway, is very clear, and the description good. Afterwards we find engines for the Great Northern, London and North-Western, and North British Railways thoroughly and clearly discussed, the general constructions being explained. The section concludes with a specification for a bogie locomotive, designed by Mr. William Kirtley for the London, Chatham, and Dover Railway, and a set of rules are compiled for the construction of locomotives.

In Section V. there is a very interesting and useful account of the construction of iron ships. The section of necessity treats the subject generally, the scope of iron shipbuilding being so large. The transverse and longitudinal methods of construction are explained, an account is given of the late Mr. William Froude's experiments with ship models, and as an example of recent practice we have the longitudinal section and deck plans of the s.s. *Orient*, with a concise description of her construction; afterwards the rigging is explained, with illustrations of the sparring and sail plan of a full-rigged ship. Then comes a short account of armoured war-ships, with a description of H.M.S. *Polyphemus*, the section concluding with dredgers, and examples of specifications for iron ships to Lloyd's rules.

Under the head of engineering works, the author gives a description of floating docks, the construction of iron roofs, the construction of, and strain on, wrought-iron

girders. There is a very clear analysis of the strains on the struts and ties in the lattice girder; the construction and sectional area of each strut and tie is worked out; next the suspension bridge is discussed, the general construction being explained.

The last few subjects treated in the volume include the fire-engine and gas-engine, with several other short accounts of the newest inventions, concluding with a chapter on the strength of materials.

In the publishers' preface we read that the present work is intended to furnish a reliable guide to practical engineers and others connected with the engine-shop and building-yard. This end has been most satisfactorily accomplished, and both authors and publishers may be congratulated on having placed before the public a most useful book; the printing is exceedingly clear, and the illustrations in the text good; the separate series of engraved plates add much to the value of the volume, without which many long descriptions would have been necessary. The book deserves a place in every technical library in the country. Those learning any branch of mechanical engineering will do well to study it, for it is one of the few really practical works published.

#### OUR BOOK SHELF

*Catalogue and Handbook of the Archaeological Collections in the Indian Museum.* Part II. By John Anderson. (Calcutta.)

WE have already drawn attention to the first part of this excellent Catalogue, which thoroughly fulfils its promise of being not only an exhaustive list of the valuable objects in the Indian Museum, but a scholarly guide to them as well. The second part is occupied with Buddhist, Jain, Brahminical, and Mohammedan sculptures, and with the collections from Southern India, Persia, and other parts of the East. Appendixes have been added at the end of the book, including two by Prof. Warden and Mr. Growse. The work will be of great value to students of Indian archaeology, and more especially to those who are devoting themselves to Buddhistic research. The Indian Museum is naturally a storehouse of antiquities throwing light on the past history of India and its relations with the West, and these have now been brought to the knowledge of scholars in a thoroughly satisfactory way.

#### LETTERS TO THE EDITOR

[The Editor does not hold himself responsible for opinions expressed by his correspondents. Neither can he undertake to return, or to correspond with the writers of, rejected manuscripts. No notice is taken of anonymous communications.]

[The Editor urgently requests correspondents to keep their letters as short as possible. The pressure on his space is so great that it is impossible otherwise to insure the appearance even of communications containing interesting and novel facts.]

#### Barnard's Comet

LAST night (September 22) this comet was well seen in the 3-foot telescope. It was large (at least 4' over), brighter to the middle, but without nucleus; a position was measured from a faint star involved in the light of the head. At 8h. 20m. the position by circle reading was a 19h. 45m. 50s., and 117° 16' 30" N. P. D. A. A. COMMON

Ealing, September 23

#### The Krakatoa Eruption

By this morning's post I have received, in a rather round-about way from India, a translation of a Dutch account of the Krakatoa eruption, which, if you have not had it already, seems

to contain some interesting variations on, or additions to, the mass of matter that you have already printed on that subject. Indeed the only postscript that could now be well added to it is the comfortable and encouraging discovery of the late French scientific expedition to the effect that the eruption is now positively over. The Batavians, as you are probably aware, feared that another eruption was preparing, in consequence of the immense number of stones still being ejected and clouds of smoke emitted. But the French *savants* discovered that no stones were being thrown up, only immense quantities of them tumbling down the mountain's sides; and this because the material, of which those new sides of the mountain are now composed, is so extraordinarily friable that the heat of the sun each day breaks them up, and the quiet force of gravitation brings the pieces galloping down the steep slopes, and plunging at last into the sea, to the danger of passing vessels,—but only by day, and when the sun is shining, for at night everything is quiet; and if by day and night a cloud forms above the mountain-top, it is neither smoke nor gaseous emanation, but merely the infinitely fine powdery matter of the broken-up and rolling stones of the day rising into the air and moving along with its currents up along the slopes which have been warmed by the sun.

C. PIAZZI-SMYTH

15, Royal Terrace, Edinburgh, September 15

#### The Sky-Glows

I WAS not aware before reading Mr. Leslie's letter in NATURE of the 11th inst. (p. 463) that any of the phenomena supposed to be connected with the volcanic dust had been seen before the eruption of Krakatoa in May 1883. Would the whole text of the description of those seen in February 1883 in Natal, from which Mr. Leslie gives a quotation, indicate them to be exactly similar to those seen since the great eruption? Where can a description of them be found?

The remarkable sunsets reported as seen in Mauritius after May 1883 and before the great eruption of Krakatoa, were by some attributed to the earlier volcanic disturbance, while others have expressed doubts whether they were really similar to those so generally noticed last autumn and winter.

It was not in the least the purpose of my former letter to imply the necessity of visiting a mountainous country to see the red corona round the sun; I am aware it is still plainly visible in England, and do not doubt even in London in fairly clear weather, having observed it when there in May last, not only within an hour of sunset or sunrise, but at all times of the day. But I wished to draw your readers' attention to the fact that this corona is much better seen in the clearer air at great altitudes, where also it is not necessary, as in England, that the sun be hidden by a cloud for it to be well seen.

I had not seen it stated before that the phenomena have been visible in England for years past. There is much more to be seen than a "blanching of the sun," as Mr. Leslie calls it, so that perhaps we are not both discussing the same phenomenon. Besides the bluish or greenish light immediately round the sun, which is not very striking, there is a broad red or brown band beyond, which is so. Has this been seen in England previous to last November? It has been habitual for me to scan the neighbourhood of the sun for halos during twenty-five years, and I never observed it previously to the date mentioned. It is true that the circumstances favourable for producing halos are unfavourable for seeing the red ring; nevertheless, since the latter first appeared in November I have not unfrequently seen it at the same time with a halo. It is also true that I saw portions of this red ring some days before I recognised them as a new phenomenon, but then they were only visible in gaps between clouds, so that I took them to be on thin cloud, and simply examples of the nacreous hues of thin films; any large extent of sky would probably have enabled me to perceive their true character. It is therefore very difficult for me to believe that the corona was visible in this country much, if at all, before last November.

Whether the phenomenon is ordinarily noticeable in volcanic countries I have not learnt; information from observers in such places would be of much value towards the elucidation of this interesting question. I gather from Prof. G. H. Stone's statement (NATURE, vol. xxix. p. 404) that a somewhat similar appearance is commonly visible in Colorado, where it may perhaps be attributed to the higher layers of dust of that very dusty region.

T. W. BACKHOUSE

Sunderland, September 20



THE glowing sunsets having reappeared, though far less brilliant than in November and December last, I send you a list of the most remarkable of them which have been noticed at Clairvaux, in the Department of Aube. They appeared with the same features as have been so often described in NATURE, and were especially glowing on the following days:—November 25, 27, 28; December 12; January 7, 12; August 6, 22 (feeble, sky not quite bright), and 23 (more brilliant); September 10 (feeble, bright sky, beautiful pink coloration in the east) and 17 (bright sky, bright pink coloration one hour after sunset). When the sky is bright, the rise of the moon is preceded, for nearly one hour, by a bright illumination of the sky.

Clairvaux, Aube

P. K.

FOR the last four evenings, the 15th, 16th, 17th, and 18th, and again to-night, the colour of the sky from 20 to 25 minutes after sunset has taken that deep magenta glow looking very like the effect of a great fire, only lighter in tone. Last night, the 18th, this lasted until after 7 o'clock, and stars were then shining through it as they do through an aurora.

The reappearance of these glows was to be expected, as the haze and ruddy glow about the sun by day has, so far as I have been able to see, never really been long absent since attention was first drawn to it last autumn. I have now received a letter from Sydney, dated July 24, in which the writer says: "Since we have been in the Southern Hemisphere the sunsets have certainly had more striking colours, and on many occasions I have seen that peculiar magenta or mauve tint in the sky like aurora, only bluer in colour, while the sky has been very white just before sundown." The writer of the above is used to the look of the sun and sky, being an officer on board a mail steamer. I had suspected that absence of colour more or less in the sunsets here during our summer might be owing to the position of the sun rather than to any diminution in the quantity of vapour in the higher atmosphere, and had asked the writer of the above to note as he went south, in their winter, whether there was any increase in the colour of the after-glows, &c., being led to think this might be the case from reading the report of Mr. Neison, Director of the Natal Observatory, in which he speaks of having "first observed these phenomena in February 1883, from which time they increased in intensity until June, after which there was an interruption until the month of August." This led me to expect a return of strongly marked colour in our after-glows in autumn, increasing probably in intensity and duration during our winter months, when the weather is clear enough to see the sky.

ROBT. LESLIE

Moira Place, Southampton, September 19

### The Diffusion of Species

THE vast and altogether exceptional assemblage of Salpæ mentioned in NATURE (September 11, p. 462) by the Duke of Argyll as having been observed by him whilst recently cruising in the Hebridean seas, was due, in all probability, to the extension in a north-easterly direction of the ordinary surface-current of the Atlantic, or to an unusually long continuance of steady south-westerly wind, the effect of which would be to drive the superficial water of the Atlantic before it to the British coasts, and, with the water, the enormous multitudes of Salpæ which are occasionally to be met with in the latitude of the Canaries and Cape Verd Islands.<sup>1</sup>

During voyages to and from Bengal, *viâ* the Cape, in the good old days of sailing vessels, I repeatedly came across vast aggregations of these creatures, my attention having been specially called to them whilst engaged as I generally was for many hours by night as well as by day, in using a towing net from the stern ports for the capture of natural history specimens.

On my last voyage from Bengal in 1857 the ship sailed through some fifty or sixty miles of what the Duke aptly describes as Salpæ soup, and which looked exactly like boiled tapioca. The quantity of Salpæ present in a bucket of the sea-water was, at least, equal in volume to the volume of water, but then the bodies of the Salpæ themselves consist in reality of more than 90 per cent. of water. On the occasion referred to, almost the entire mass consisted of a small species of Salpæ about an inch in length, but nevertheless large enough to render the bright

<sup>1</sup> As is well known, vast assemblages of Salpæ and kindred forms constantly occur at the surface in Arctic and Subarctic seas during the prevalence of moderate weather.

yellow digestive cavity of each, which is about the size of the smallest pin's head, distinctly visible. This was invariably full of certain species of oceanic diatoms the endochrome of which imparted the yellow colour. It is worthy of remark that in the case of the Salpæ, as well as many other organisms holding a yet lower position in the animal scale, there undoubtedly exists a selective power which enables them to pick out certain kinds of food in the midst of a superabundance of different kinds.

In the tropical Atlantic and Indian Oceans also I have seen, during calms, immense numbers (though not to be compared with the gatherings of the smaller Salpæ) of the larger chain Salpæ. These sometimes attain a length of from 8 to 10 inches, and have stomachs as large as a good-sized marble or hazel-nut.

But the most interesting assemblage of the lower forms of pelagic life was noticed by me about 200 miles from Ceylon, during a dead calm of four days' duration, when the sea was as smooth as a mirror, and undisturbed save by its never-ceasing majestic swell. Deep down, as far as the eye could penetrate, were to be seen numbers of brightly coloured water-snakes, delicately tinted "Venus's girdles," "Velella," and countless multitudes of those more minute living things which, though barely visible as mere specks to the unaided vision, are full of beauty and interest when observed under the microscope. Such a calm is a veritable pandemonium to the "skipper,"—to the naturalist it is a paradise.

G. C. WALLICH

September 14

I AM specially interested in the Duke of Argyll's letter on the above subject (p. 462), being a resident during nearly half the year in the most southern of the Hebrides. His Grace is so competent a naturalist, and so accurate an observer, that I assume at once he had evidence which satisfied himself that an adder swam from Mull to Iona. Still I must be pardoned if I say that your readers have not been supplied with the proofs which have satisfied his Grace. A boy and girl in Iona, who, I presume, had never seen an adder in their lives, killed a creature in the sea there. Might it not have been an eel?

As regards distribution of species I may mention the following. In this island (Islay) we have multitudes of *stoats* but not a single *weasel*, while I am informed on trustworthy authority that in the neighbouring island of Colonsay there are many *weasels* but not a single *stoat*.

R. SCOT SKIRVING

Sunderland House, Islay, September 18

### Shifting of the Earth's Axis

IN the very interesting address of Prof. Young (NATURE, September 18, p. 501) he refers to the variability of the earth's axis, and states that a change of 1" per century has been detected at Pulkowa, but that "the Greenwich and Paris observations do not show any such result." Now only last year, in the "Pyramids and Temples of Gizeh," I had (p. 126) noted that the Greenwich observations *did* appear to show a change, and that a change of the same amount and same direction as is stated by Prof. Young for Pulkowa; the observations of this century showing a decrease of 1" of latitude per century, or with those of Maskelyne a decrease of 1"·38 per century.

This change I adduced as corroborating the result shown by four very accurate orientations of the earliest buildings, the Gizeh pyramids. These structures, whose errors are but a few seconds of angle, agree in standing as much as 4' or 5' to the west of the present north. This would imply a change of about 5" or 6" per century in the direction of long. 120°; a result quite comparable to the motion of 1" or 1"·4 per century in long. 0° and 30°. Such a change might be effected by causes which are beyond our observation; as, for instance, unbalanced ocean circulation equal to a ring of water only 4 square miles in section moving at a mile an hour across the poles. If this motion of 6" per century in long. 120° is still in action, we might now expect to find a change of about 5" in the meridian determined at the beginning of the Ordnance Survey, a ground of observation which should not be neglected.

W. M. FLINDERS PETRIE

Bromley, Kent

### Salmon-Breeding

MR. FRANCIS DAY's interesting communication last week (p. 488) on this subject is likely to attract more attention from biologists and pisciculturists than any other recently-ascertained fact in the natural history of the Salmonidæ, and it opens the large ques-

tion how the migratory instinct became established in certain members of the family, when it appears not to be physiologically indispensable to them. At the period of migration, when the smolts are fit to go to the sea, they evince, I believe, the utmost restlessness (like all migratory animals), and frequently leap out of the fresh water in which they are confined, and die on the banks. This has taken place year after year in the nursery ponds on the Plenty River, Tasmania, where it was first placed beyond question that a migratory salmonid could remain and breed perfectly freely year after year in fresh water. On January 20, 1866, Mr. J. A. Youl, C.M.G., sent out to Tasmania a consignment of salmon, salmon-trout, and brown trout (*S. fario Ansonii*). On June 25, 1869, several parrs of the salmon-trout, then weighing in some instances more than a pound, were busy nesting, the result being that many thousands of fry from their ova were subsequently sent to stock other rivers. The imprisoned salmon-trout have continued to breed for several years in succession, but there has been noticed in them a tendency to become sterile as they grow older. There is also some reason to believe that *Salmo salar* has bred in the ponds on the Plenty. Two young specimens which, from certain circumstances, the Commissioners believed to be true salmon, were sent to Dr. Günther for examination, with full information as to their origin and history; and he, while expressing his reluctance to give a decided opinion, stated that they "presented all the anatomical characters of *S. salar*." Full details of the breeding in fresh water of *S. trutta* will be found in "The Acclimatisation of the Salmonidae at the Antipodes—its History and Results." ARTHUR NICOLS

#### A Sea Monster

A FRIEND of mine, Capt. W. Hopkins, of the schooner *Mary Ogilvie*, who has just returned from a voyage all round Australia, has given me the following information, which I forward you for publication, not so much because of its interesting character, but in order that other travellers may throw some light upon the character of the animal, which, if an Octopus, must be of much larger dimensions than those usually met with. On June 15, when in S. lat. 21° 37' and E. long. 113° 49', about five miles off the Exmouth Gulf on the western coast of the continent, he saw an immense creature which he took to be a species of Octopus. His attention was drawn to it by a perfect cloud of sea birds, and at first he naturally thought it must be a dead carcass. On approaching it, however, he found it was alive, and sluggishly disporting itself. In shape it was like a violin, but of immense size, with some six feelers about the greater diameters of the violin. It lay almost flat upon the water, was of a dark gray above and lighter gray below, and was continually elevating one of its feelers, apparently twice the thickness of a man's arm, to a height of from six to eight feet. It appeared to be vomiting, and as the birds were evidently feeding, that accounted for their presence in such numbers. Its size was so great that, had it grasped the vessel, it could easily have capsize it. The captain therefore got out of the way as quickly as possible, and without making definite measurements; but a large whale in the vicinity looked quite diminutive. It is a pity that something more exact as to size is not available, but I think the description is sufficient to convey an idea of the nature of the monster. All along the northern and western coasts of the continent vast shoals of pumice, in portions varying in size from ordinary gravel to about a foot in diameter, and completely covered with barnacles, were passed through.

Sydney, N.S.W., August 4

ALFRED MORRIS

#### Hail

WILL any of your readers kindly oblige me with particulars of the formation of a hailstone, and the effect produced upon it by falling through the air. How does it become frozen? increase in size? and what are the conditions for its increase? up to what point in its passage does it increase? what effect has temperature upon it in its downward career? after a certain point in its fall should it not theoretically decrease in size? does it do so actually? how is it that larger stones generally fall in tropical or hot climates during thunderstorms than we witness during our English winters? Does a raindrop increase in size as it nears the earth? If so, please give reasons. A. D.

Lisbon, September 1

[The best account of the formation of hail is given in Ferrel's

"Meteorological Researches for the Use of the Coast Pilot," Part II. p. 85, a brief *résumé* of which is given in the "Encyclopædia Britannica," article *Meteorology*, p. 132.—En.]

#### THE "COMMA-SHAPED BACILLUS," ALLEGED TO BE THE CAUSE OF CHOLERA<sup>1</sup>

WITH a view of studying the phase which the cholera question has now entered upon, in consequence of the publication of the results of the investigations of the German Cholera Commission in Egypt and India, I availed myself of the opportunity which the present vacation at the Army Medical School afforded of proceeding to Marseilles, where the disease has been prevalent since the end of June. Sir Joseph Fayrer was so kind as to enlist for me the valuable assistance of Dr. Le Roy de Méricourt, Médecin en Chef of the French Navy, who in various ways did his utmost to further my wishes. Dr. Marroin, the Chief of the Sanitary Department in Marseilles, was so good as to introduce me to the authorities of the Pharo Hospital, where the cholera cases are treated, and where, with the permission of the principal medical officer, Dr. Trastour, I was able to renew my acquaintance with the disease, and to collect material for studying afresh the microscopy of the intestinal discharges.

Before, however, referring to the results of my own observations, it will be convenient to epitomise the published history of the German Commission; to point out the salient features of the results of their investigations in Egypt and in India; and to make a few brief comments on such of the circumstances and conclusions as appear to call for notice. Shortly after the arrival of the Commission in Egypt, Dr. Robert Koch reported, on behalf of himself and his colleagues, that no special micro-parasites had been discovered in the blood, the lungs, the spleen, the kidneys, or in the liver in cholera, but that the intestinal mucous membrane was permeated by certain Bacilli which nearly resembled in size and form the Bacilli found in glanders. As is well known, these Bacilli are straight, and are, in fact, uncommonly like the ordinary microphytes associated with decay. Dr. Koch also states in connection with this subject that he had, previous to proceeding to Egypt, found similar Bacilli in the intestinal mucous membrane of four natives of India, but that he had then looked upon them as due to merely *post mortem* changes. When he came to Egypt, however, and found these same Bacilli in the intestines of perfectly fresh cases, he felt that an important link was furnished towards establishing the identity of the disease in Egypt with Indian cholera.

It is highly probable that the specimens from India which Dr. Koch had examined were those which were sent, at the request of the Imperial Health Department in Berlin, by the Sanitary Commissioner with the Government of India. These consisted of numerous dry cover-glass specimens of blood which I had collected from several cholera patients, and of portions of the viscera of four natives who had died of the disease. All these were examined by me before they were despatched, and portions of each were reserved for further study. I had heard nothing further of them, but the publication of the remarks above referred to in Dr. Koch's Report of September 17, 1883, from Alexandria, recalled them to my mind, and I was glad to infer that my own negative results had been confirmed in Berlin. As already observed, no importance had been originally attached to the organisms which were present in the intestinal mucosa. During the last six months I have examined hundreds of stained microtome-sections of these four, and of other specimens of cholera intestines in my possession, and have found that, when the mucosa is infiltrated with

<sup>1</sup> A Memorandum by Surgeon-Major Timothy Richards Lewis, M.B., Assistant Professor of Pathology, Army Medical School. Communicated by the Director-General, Army Medical Department.

microphytes at all, they are either Micrococci, Bacteria, or long-oval, and straight Bacilli.

In the Report of the Commission, dated Calcutta, February 2, 1884, Dr. Koch, however, announces for the first time that the specific Bacillus of cholera is curved or comma-shaped, and not straight; so that apparently it had become necessary to abandon the microbe first fixed upon. Assuming that the four specimens from natives of India which had been examined by Dr. Koch were those which passed through my hands, the evidence they furnish seems to be in accordance with this view, as in not one of them have I been able to detect any invasion by unmistakable "commas," though at least one of the specimens may fairly be characterised as abundantly infiltrated (in the manner described by Dr. Koch) by straight (and as I prefer to call them) putrefactive Bacilli. Judging from my own experience, therefore, any extensive infiltration of the intestinal mucous membrane in cholera by comma-shaped Bacilli must be exceedingly rare; and this, I believe, is likewise the experience of the members of the late French Cholera Commission, M.M. Straus, Roux, and Nocard, whose acquaintance I had the pleasure of making at M. Pasteur's laboratory on my return through Paris.

Whilst at Marseilles I had, as already stated, opportunities of observing numerous specimens of choleraic excreta, and found that comma-shaped Bacilli were, more or less conspicuously, present in all of them, though in some instances more than one slide had to be examined before any could be satisfactorily detected. It may also be mentioned that some of the discharges in which these organisms were present manifested an acid reaction when tested with litmus paper. As Dr. Koch himself remarks, the proportion which the comma-shaped Bacilli bear to other organisms in the dejecta varies greatly. In some instances only one or two specimens are to be found in the field of the microscope, while in others they are very numerous, and Drs. Nicati and Rietsch (who are at present engaged in the study of the disease at Marseilles) were so kind as to show me a specimen of choleraic material they had obtained from the small intestine, in which the "commas" existed almost to the exclusion of all other organisms. This is a condition, however, which, I understand, is exceedingly rare. On the other hand, I have seen samples of choleraic dejecta in which totally different organisms prevailed to a like exclusion of others; and in one instance at Marseilles spirilla of various sizes and forms were the most conspicuous of the micro-organisms present. So far, therefore, the selection of the comma-shaped Bacilli as the *materies morbi* of cholera appears to be entirely arbitrary.

Dr. Koch and his colleagues have adduced no evidence to show that they are more pernicious than any other microbe; indeed, as a matter of fact, the sole argument of any weight which has been brought forward in favour of the comma-shaped Bacillus being the cause of cholera, is the circumstance that it is more or less prevalent in every case of the disease, and that the German Commission had not succeeded in finding it in any other. With regard to the suggestion that the cholera process may in some way favour the growth of these Bacilli, and that these are not necessarily the cause of the disease, Dr. Koch remarks, in the Report from Calcutta above cited, that such a view is untenable, inasmuch as it would have to be assumed "that the alimentary canal of a person stricken with cholera must have already contained these particular Bacteria; and, seeing that they have invariably been found in a comparatively large number of cases of the disease both in Egypt and India—two wholly separate countries—it would be necessary to assume, further, that every individual must harbour them in his system. This, however, cannot be the case, because, as already stated, the comma-like Bacilli are never found except in cases of cholera."

Had Dr. Koch and his colleagues submitted the secretions of the mouth and fauces—the very commencement of the alimentary canal—to a careful microscopic examination of the same kind as that to which they have submitted the alvine discharges, I feel persuaded that such a sentence as the foregoing would not have been written, seeing that comma-like Bacilli, identical in size, form, and in their reaction with aniline dyes, with those found in choleraic dejecta, are ordinarily present in the mouth of perfectly healthy persons.<sup>1</sup>

There is no difficulty in putting this statement to the test; and to any one acquainted with the methods ordinarily adopted for staining and mounting fungal organisms of this character, no special directions need be given. The procedure followed by me to demonstrate these "commas" in the saliva is precisely that adopted for finding them in the dejections. A little saliva should be placed on a cover-glass (preferably in the morning before the teeth are brushed) and allowed to dry thoroughly, either spontaneously or aided by a gentle heat. The dry films thus obtained should be floated for a minute or two with one or other of the ordinary solutions of aniline dyes adopted for such purposes, such, for example, as fuchsine, gentian-violet, or methylene blue. The cover should then be gently rinsed with distilled water, and the film re-dried thoroughly. The preparation may now be mounted in dammar varnish or Canada balsam dissolved in benzol, and should be examined under a 1/12th or 1/16th of an inch oil-immersion lens.

As in choleraic discharges so in the saliva the number of comma-shaped Bacilli will be found to vary greatly in different persons, and at different times in the same person. Sometimes only one or two "commas" will be seen in the field, at others a dozen may be counted, and, occasionally, little colony-groups of them may be found scattered here and there throughout the slide.

It may be remarked in passing, and as bearing upon what has been already said regarding the general absence of comma-shaped Bacteria from the intestinal mucosa itself, that they do not appear to manifest any special tendency for attacking the decaying epithelial scales of the mouth, but that, on the contrary, they are for the most

<sup>1</sup> Since this Memorandum was submitted, I have observed that Dr. Koch states, in his recent address on the subject, that, after his return to Berlin he had examined, amongst other things, the secretions of the mouth for comma-shaped Bacilli, but had found none; and, further, that he had consulted persons of much experience in bacterial researches as to whether they had ever seen such organisms, and was told that they had not.

It may be of assistance to future observers if I give the dimensions of half-a-dozen comma-shaped Bacilli as found in each of the following:—(a) In the alvine discharges of three cholera-affected persons; (b) in the small intestine of a person who had died of the disease and in whom they existed almost to the exclusion of other organisms; (c) in a cultivation of them in Agar-Agar jelly; and (d) in the secretions of the mouth of three healthy persons, ranging from four to fifty years of age. The measurements were made (with the valuable assistance of Mr. Arthur E. Brown, B.Sc. Lond.) under a magnifying power of 1000 diameters—a Powell and Lealand's 1/10th of an inch oil-immersion lens, with a wide angle condenser, being used.

LENGTH AND WIDTH (IN MICRO-MILLIMETRES\*) OF COMMA-SHAPED BACILLI IN CHOLERAIC MATERIAL

No.	Alvine discharges			Intestinal contents (autopsy)	Cultivation in Agar-Agar jelly
	I.	II.	III.		
1.	2.4 x 0.40	2.0 x 0.60	1.1 x 0.25	2.0 x 0.40	1.6 x 0.40
2.	2.6 x 0.40	2.5 x 0.65	1.8 x 0.35	1.2 x 0.40	1.4 x 0.60
3.	0.8 x 0.50	3.2 x 0.70	2.0 x 0.60	1.5 x 0.45	1.8 x 0.50
4.	2.2 x 0.45	3.0 x 0.70	3.0 x 0.70	1.3 x 0.60	2.0 x 0.50
5.	2.8 x 0.35†	2.5 x 0.60	2.2 x 0.50	2.1 x 0.50	2.6 x 0.45†
6.	1.5 x 0.35	2.0 x 0.50	1.6 x 0.40	1.2 x 0.50	1.1 x 0.35

LENGTH AND WIDTH (IN MICRO-MILLIMETRES\*) OF COMMA-SHAPED BACILLI IN SECRETIONS OF THE MOUTH IN HEALTH

Nos.	I.		II.		III.	
	μ	μ	μ	μ	μ	μ
1.	2.0	0.50	1.4	0.35	1.5	0.50
2.	1.3	0.35	2.0	0.40	1.3	0.50
3.	1.6	0.40	1.7	0.40	1.0	0.30
4.	1.2	0.35†	1.3	0.45	1.2	0.40
5.	2.2	0.65	2.1	0.50	2.1	0.50
6.	2.0	0.40	2.8	0.40†	1.4	0.55

\* One micro-millimetre (μ) = 1/1000 millimetre (= 1/25,000").  
† S-shaped comma-bacilli.

part found free in the fluid, the epithelium being studded with other bacterial forms.

Persons who have not been in the habit of examining dried saliva-films will probably be surprised at the number and variety of the organisms which are, more or less, constantly to be found in the mouth; and especially at the number of spirilla with which the fluid is generally crowded.

The alvine discharges in cholera sometimes swarm with precisely similar spiral organisms, and, indeed, as has long been known, the fluid exuded into the intestines in this disease is peculiarly suitable for the growth of these and allied microbes. But, so far as my own experience—dating from 1869—of the microscopic examination of such a fluid goes, all the microphytes ordinarily found in it are likewise to be found, to a greater or less extent, in the secretions of the mouth and fauces of unaffected persons. And with reference to the comma-like Bacilli found in cholera, to which such virulent properties have been ascribed, I shall continue to regard them as identical in their nature with those ordinarily present in the saliva until it has been clearly demonstrated that they are physiologically different.

Pathological Laboratory, Netley, September 1

#### FORESTS IN COBURG, GERMANY, AND RUSSIA

A BLUE-BOOK under the title of "Reports by Her Majesty's Representatives abroad on the Cultivation of Woods and Forests in the Countries in which they reside," has just been published by Messrs. Harrison & Sons. These Reports are of an extremely interesting character, and we gladly draw attention to them, appearing as they do at an opportune moment before the close of the Forestry Exhibition at Edinburgh.

The Reports come from Coburg and Gotha, Germany, Norway, Russia, and Sweden, and in the form of an appendix is a *précis* by Dr. Lyons, M.P., of the Reports on Forestry of the United States Department of Agriculture. In each one of these Reports much valuable information is given and information of a very varied character. Thus in the first we are told that the forests in Gotha consist of 85 per cent. of pine and 15 per cent. of other wood. The principal timber-trees are pine and beech, whereas the remaining sorts of wood, namely Scotch fir, spruce, larch, oak, maple, ash, birch, and elm are found only in small quantities or mixed with the other species. The period during which the different woods are gradually brought into use is such that pine forests and mixed forests shall yield as large an amount as possible of saleable timber, whilst in the beech woods the greatest amount of wood as fuel is sought without allowing the trees to attain an age at which they would no longer pay the interest on the value of the soil. Pine and beech wood in higher situations are, according to these principles, usually cultivated and worked in cycles of one hundred years, while spruce on the lower heights and in the plains are worked on an eighty years' cycle. The woods for protection on the high grounds are subject to especial treatment, as no clear fellings take place, and care is taken to leave standing groups of foliage trees equally distributed over the whole surface. The usual rules followed are: early felling of the trees in a cycle of eighty years, leaving occasional large shelter trees, and utilising the undergrowth for purposes of renewal. The administration of the Domain forests in the Duchy of Coburg is carried on on scientific principles, and consists of regular felling at stated periods over certain areas; pine timber trees are usually cut every ninety years, while oak, ash, beech, birch, &c., are not cut till after 120 years' growth.

The Report on the general administration of Prussian

State Forests treats of their organisation, expenditure, and results, and points to the desirability of introducing others than indigenous trees into the forests. On the subject of education in forestry it is stated that the School of Forestry at Eberswalde completed in June 1880 the fiftieth year of its existence, and had at that period in all nearly 1600 pupils. There is also a School of Forestry at Münden, and the half-yearly attendance at both schools showed in 1878 an average of 148 pupils, whereas in 1880 the number had increased to 210. The attendance was therefore largely on the increase, and it was then proposed to give voluntary education in these matters to the "Jäger Bataillon" of the army. This plan has, according to latest accounts, been attended with so much success that the education has become obligatory, and forms a regular portion of their service.

From Russia a very elaborate Report treats, amongst other things, of the various kinds of trees found in Russia, with notes on their distribution, and some interesting facts on the consumption of wood and the uses to which it is put, showing that house and ship building consume a very large proportion, and that the minor industries when put together form a not unimportant total. After showing the extensive destruction of forests that has been going on in different parts of Russia for some years past, the Report considers the question of plantations along railways, the object of which is to protect the track from snowdrifts, and a list of the best trees and shrubs for this purpose is given. On the subject of tree-planting on the steppes of South Russia, it is stated that Count Kisseleff, when travelling through several provinces in 1840, found, much to his surprise, amongst the German colonists not only good kitchen gardens but also flourishing plantations of forest trees. The colonists had been obliged on every plot of land to plant a certain number of trees. The first experiences, however, were so severe that many of the colonists preferred to return to Germany; those that remained were forced to plant their allotments with trees which, with infinite trouble, they succeeded in doing, and these plantations are now a great ornament to the steppes, and from a climatic as well as an agricultural point of view have been of great importance to the colonists, and have laid the foundation of the planting which is now carried out on the steppes in a scientific manner. A forestry school was established, but closed in 1866, and the allowances for planting which had been granted were reduced to a minimum. Since that, however, matters have been put on a more satisfactory footing, and planting is conducted in a systematic manner.

#### STONE HATCHETS IN CHINA

LITTLE has yet been done to illustrate the Stone Age in China, and this is very likely to be true for some time to come from the fact that the people of the country worked in metals four thousand years ago.

To begin with the Han dynasty, B.C. 206 to A.D. 220, one chief source of revenue was iron in those days, and Shansi had grown rich and powerful because of her iron foundries. The correct Confucianists objected to the spirit of gain-seeking which they saw showing itself in the expansion of trade. In the reign of Chauti, B.C. 80, a book was written on the salt and iron duties, which was a record of the views then maintained by the purists of the Confucian school in contrast with those of the political economists of that day. The advantages of the encouragement of trade were detailed in full, and the sympathy of the modern reader goes with the economists, who saw that the strength and prosperity of the country must be increased by developing her resources. The country was then old, and the stone hatchet period must be sought much earlier. The same state of things existed in the time of Kwan chung, B.C. 700. Living before Confucius,

he could, as Minister of the Tsi kingdom, encourage trade without opposition from the literary class. His book speaks of the trade then existing between the different parts of China and the outside countries, and mentions gold as a product of the Ju and Han Rivers. Pearls come from the south; jade comes from Tartary; white ring plates come from the Kwun lun Mountain. Money was threefold. Pearls and jade were money of the first class. Gold was money of the second class. Knife money and cloth were money of the third class. This being the state of things at the beginning of the seventh century before Christ, the stone hatchet period must be sought farther back. It is said of the Emperor Cheng Tang, B.C. 1766, that he coined gold; and of the Emperor Shun, B.C. 2255, that he hid gold in the earth to check the covetous spirit of the people. In the book of history is recorded the tribute which was offered to the Emperor from various parts of China in the time of Yü, B.C. 2205. All the common metals were included among the articles offered.

Recently a stone hatchet was found near Kalgan in a mound forty feet high. The mound belongs to a large collection of graves, large and small, about seven miles east of the city Yü cheu, and 110 miles west of Peking. An ancient wall, nearly round, twenty feet high and about eight miles in circuit, is still in existence there. The mound in which the hatchet was found is in the line of this wall—that is, the wall runs north-west and south-east from it. Hence the wall-builders did not regard the mound as sacred, for it would not in that case have been made to serve the purpose of a wall to their city on the south-west side.

There is another large mound known as the grave of Tai wang. It is a little to the east of the centre of the inclosed space once a city, and the principal road runs through the city by this mound from east to west. Rev. Mark Williams of Kalgan, who found the hatchet, and was the first foreigner to draw attention to the old city, was struck with the general resemblance of the mounds, the wall, and the hatchet to what he is familiar with in Ohio. So close was the similarity that it seemed to him to require that the same class of persons who made the one should have made the other.

A Chinese archaeological work of the seventeenth century, "Fang yü kl yau," mentions the city but not the mounds. The city, it says, was built in the reign of Han kau tsu, B.C. 206 to 194. Han kau tsu gave to his brother Hl the title and principality of Tai wang, and this was his residential city. The traces remain (it is added in this book) of nine gates. A river from the north enters the wall in the west, proceeds to the south-east, and from thence flows to the Tsz River. This prince was attacked by the Hlung Nu Tartars, and they must have taken the city, for he fled to his brother in Shensi, and was degraded to a lower title of nobility for cowardice shown on this occasion. Before this, in the interval between the fall of the Tsin dynasty and the establishment of the Han, there had been two other persons who had been styled Tai wang. Hiang yü, who took the capital of the Tsin dynasty and burnt its palaces, resolved to restore the feudal system and made several kings.

Chiu hie was one of these, but he removed shortly after to a different locality. After this there was another occupant of this principality, Chen yü. He was appointed by the ruler of Chau. But soon Liew pang subdued all China, and everything was changed. Besides these persons there is mentioned in the year B.C. 457 another Tai wang. The account which speaks of him is in the "Shih kl," chapter xliii., where the author is relating the fortunes of the house of Chau. The elder sister of the Prince of Chau was the wife of Tai wang. While brother and sister were in mourning for their father, the former invited Tai wang, his brother-in-law, to a feast, and directed the cooks to attack and kill him with their copper ladles, which they had first used in presenting food to him. The widow

afterwards committed suicide with her hair-pin. The object of the ruler of Chau in the murder was to obtain the dominions of the Tai wang for himself. The people of the locality, adds the historian, pitied the unhappy queen, and after her death named the mountain where this event took place "the hill of the suicide with a hair-pin," *mo kè chi shan*. When the Prince of Chau had effected the murder, another work adds, he sent a messenger to his sister to say, "To feel indifference for a husband's death because it was caused by a brother would not be kindness. To hate a brother for a husband's death would not be right." After hearing this speech she committed suicide, and the envoy at once followed her example and put an end to himself. The feelings of the people were much stirred by these events, and it seems likely that one of the large mounds would be raised to the assassinated Tai wang. This however is not certain, and the number, names, and dates of other persons who bore the title are now beyond the reach of investigation.

Several pieces of broken pottery were found by Mr. Williams in the neighbourhood of the mound, and their pattern is different from modern crockery ware. The small mounds are in groups chiefly outside the wall, and seem to be all placed irregularly. The hatchet is about five inches long, and is made of a black stone not heavy when held in the hand. It resembles in shape those preserved in Ohio museums.

On the whole, as the reader of this account will agree, the highest of the two large mounds is most likely the tomb of the prince assassinated, in the manner here described, in the year B.C. 457. The village in the centre, and the large mound second in size near it, popularly called Tai wang, probably indicate that a later personage was buried there.

I should add to this statement that there is in Kwan chung a passage in the twenty-fourth chapter which is as follows:—"Hwan kung, ruler of Tsi, asked Kwan chung, 'What produce is there in the Tai country?' The philosopher replied, 'White fox-skins. They are, however, dear to buy. They appear in the sixth month, when the yang principle changes to yin. If you, the ruler of Tsi, offer to buy them at a high price, the people of the Tai kingdom will at once, from the hope of gain, go out in force to hunt for them. Tsi keeps its gold and waits. While the Tai people are hunting in the wilds and off their guard, their enemies on the north, the Lai ti, will attack them, and in this case the Tai country will fall to Tsi.' The ruler of Tsi adopted this plan for obtaining possession of Tai, and sent envoys with money to negotiate for white fox-skins. The King of Tai, hearing what they desired, said to his chief councillor, 'The money offered to us by Tsi is the very thing for want of which we are not equal to the Lai ti people. It is fortunate that this proposal is made to us.' He then ordered his people to go out hunting for white fox-skins. During twenty-four months they searched without finding any. The Lai ti people learned that the Tai kingdom was not in a state of defence, and attacked its northern frontier. The Tai wang in great fear gathered his troops and posted them above a defile called the valley of Tai. The invasion proceeded, and the Tai wang took his soldiers with him and submitted to Tsi. So in less than three years Tai submitted to Tsi without its being necessary to spend any money on the purchase of the skins which Kwan chung praised."

This passage must by fair criticism be ascribed not to Kwan chung himself but to some unknown author of the age of the contending States three or four centuries later. There was no Tai kingdom in the time of Kwan chung, and invention of this sort was common in the period of the contending States. Kwan chung had ascribed to him many expedients of statecraft which never occurred to him, and this of the fox-skins was amongst them.

## NOTES

M. JANSSEN has been appointed by the Paris Academy of Sciences to represent the French Government in the Congress which is to be held at Washington to determine the choice of the first geographical meridian. It is just to state that the original idea of a universal first meridian belongs to France, and that as far back as 1632 a decree signed by Louis XIII. and proposed by Cardinal Richelieu established a universal meridian on the island of Ferro. This meridian was ultimately abandoned by Cassini to gratify Louis XIV.'s pride, and the Paris one was retained by the Metric Commission in 1793 under the pretence that an arc of this meridian had been measured for determining the length of the unit of measure.

WE regret to announce the death of Dr. Heinrich Schellen, formerly director of the Cologne Realschule, and author of two well-known works, "Der electromagnetische Telegraph" and "Die Spektralanalyse." Besides these, Dr. Schellen published a book on arithmetic, an excellent German version of Padre Secchi's great work on the sun, and various other works on physical subjects. It was under his directorship and by his efforts that the Cologne School was raised from the rank of "Bürgerschule" to that of "Realschule erster Ordnung," and that it attained the high reputation it now enjoys. He died in Cologne in the first week of September, aged sixty-six years.

WE regret to announce the death of M. Jean Augustin Barral, the Perpetual Secretary of the French Société d'Agriculture, and the chief editor of *L'Agriculture*, a periodical of large circulation, and which, of all the Continental agricultural papers, was the most intensely devoted to the adaptation of English principles of rural economy to French conditions. M. Barral was born in Metz in 1820, and was a pupil of the Polytechnic School, where he was a *repeiteur* of chemistry for some time. He became most intimately connected with Bixio, the editor of *Maison Rustique*. Bixio and Barral made two daring aeronautical ascents from the Observatory grounds in 1850, when they ascended to an altitude of 18,000 feet, a height unsurpassed except by Glaisher and Tissandier. When Arago died he selected M. Barral, who had acted as his secretary for a long period, to publish his works. The Barral edition contains twelve large octavo volumes, exclusive of the "Astronomie Populaire," which fills four other volumes, and has been translated into almost every language. M. Barral edited the *Revue Horticole* and the *Journal d'Agriculture Pratique* for many years; it was on the occasion of the death of his friend Bixio that he resigned and started *L'Agriculture*, of which he was not only the editor but also the proprietor. He edited for ten years the *Revue de la Presse Scientifique*, an influential paper whose publication was stopped after a brilliant existence of eight years. M. Barral was a very popular character, much appreciated in Paris, where his loss will be heavily felt. Besides his editorial work he has written some popular works on scientific topics, and he leaves a number of academical essays, of which some have been edited under the form of pamphlets.

THE death is announced at Meran of Dr. Settari, one of the authorities on Lepidoptera.

A WARSAW correspondent informs us that on the 16th inst. there died in that city Jakób Natanson, formerly Professor of Chemistry in the principal school there. The late Prof. Natanson prepared carbamide synthetically by the action of ammonia gas on phosgene ( $\text{COCl}_2$ ) in 1856. Prof. Natanson wrote many scientific papers in the Polish language; the most valuable are a textbook of chemistry ("Krótki myślad chemii orgańniej") and a

treatise on organic chemistry. He also improved the methods of determining the density of vapours.

MESSRS. CASSELL AND CO. announce the forthcoming publication of "A History of British Fossil Reptiles," with 268 plates, by Sir Richard Owen, K.C.B. The edition, it is stated, consists of 170 copies only (each copy being signed by Prof. Owen), and no further number can be produced, as the plates from which the illustrations have been printed have been destroyed.

THE German Association of Naturalists and Physicians met last week at Magdeburg.

THE French Association for the Advancement of Science has decided that its next meeting will be held at Nancy. The President of this session, which promises to be most interesting, will be M. Friedel, member of the Academy of Sciences and Professor of Chemistry at the Sorbonne. The general secretary will be M. Collignon, Professor of Mechanics to the École des Ponts and author of the text-book on mechanics used in almost every French academy.

THE autumnal meeting of the Iron and Steel Institute was opened at Chester on Tuesday, when Dr. Percy, F.R.S., was elected President.

THE Social Science Congress has been meeting at Birmingham during the past week. In the Education Department Mr. Oscar Browning was President, and in his inaugural address he contrasted the ardent desire for a University education displayed by the Germans, who were content to beg to obtain it, with the apathy displayed in England. Our primary education was organised in a manner which became more effective every year. A complete system of University education which should lead the best scholars from the primary school to the University, and which should educate the bulk of the middle class, could not be said to exist. This was a crying want; it paralysed the activity of England in many directions, and the want could not be adequately supplied without the initiative of the State. On the Continent there might be too much theory and too little practice, but in England we had suffered until lately from having no theoretical training at all. He advocated such a technical education as that by which the Continent had progressed so much during the last half-century. Contrasting Germany and England he showed how a youth naturally fitted for an academic career could, however poor, by State aid go to the German University, while he had no such sure road in England. The best means by which this deficiency in our national life could be supplied, he thought, would be, first, by putting ourselves on an equality with other nations by determining that in every town in England of a certain size there should be at least one State school, where, for a very moderate charge, an education of the classical type should be given equal to the best which the country could supply, and that by the side of this, either in the same school or in a separate establishment, according to the population of the town, there should be facilities for passing a curriculum of modern education which should fit a man either for a commercial or for a scientific career. It could not be hoped that such schools would be self-supporting, and the time would come when the amount contributed by the Budget to national education would mark the national prosperity.—In a paper in the same Section, Dr. H. W. Crosskey said that in order that science may be effectively taught in public elementary schools, it must be taught experimentally. Actual demonstrations must accompany the lessons at every stage. It must be taught systematically and continuously. The "getting up" of some branch of science during three or four months as a "specific subject" is of little use. Special science demonstrators must be appointed. No man can be a good demonstrator who does not devote to the work the greater part of his daily

life. The ordinary master of a school has many duties to discharge. He cannot by any possibility give any sufficient proportion of his time to the art and practice of scientific demonstration. By the peripatetic system experimental lessons can be given at every school, by a trained man of science, at a moderate cost. A central laboratory is erected in which experiments are prepared. The demonstrator visits each school in succession, the apparatus being brought by a hand-cart from the laboratory. The results actually attained in Birmingham were described. It was argued that experimental teaching gives the death-blow to cram, and that the elements of ordinary education are better mastered when the intellectual life of the scholars is aroused by science. The arrangements of the peripatetic system will suffice until the Sixth Standard is passed; but special provision must be made for those lads who can remain a year or two longer at school, and whose future employments render the extension of their scientific training desirable. To meet the wants of this class, a school has been opened as an experiment in New Bridge Street, Birmingham, in premises belonging to the Chairman of the Board (Mr. George Dixon), who, at the cost of more than 2000*l.*, has adapted them for the purpose, and placed them rent free at the service of the Board. It is specially intended for scholars who will have to become working-men, but whose parents can keep them at school after they have passed the Sixth Standard, and the fee (3*l.* a week) is adapted to their means. There is a special master for chemistry and metallurgy, another master for mechanics and physics, a drawing-master, and a mathematical master, a highly-qualified scientific man being placed at the head. Workshop instruction is provided, and includes a knowledge of the chief wood tools, and the properties of materials, while it supplements the mechanical drawing of the schoolroom, and it is an aid to the study of theoretical mechanics. The course of instruction is arranged to extend over two years. It is not an attempt to benefit a few picked scholars, or to provide a higher-grade school for those able to pay high fees, but it is a continuation of the science training given by means of the peripatetic method in every ordinary elementary school under the Board.

THE Americans are not content with an Electrical Exhibition at Philadelphia; we see that there is to be another at Boston this year, opening on November 24 and closing on January 5, 1885. Space and power to be found free, but there is an entrance fee of ten dollars. The object of the Exhibition is stated to be "to show the rapid advancement that has been made in electricity, its methods and appliances, and all its possibilities and probabilities."

WE are requested to announce that the Fifth Annual Cryptogamic Meeting of the Essex Field Club will be held on Friday and Saturday, October 3 and 4, in Epping Forest. The meeting will be under the direction of Dr. Cooke, Dr. H. J. Wharton, Mr. Worthington Smith, Rev. Canon Du Port, Rev. J. M. Crombie, Prof. Boulger, Mr. David Houston, Mr. F. J. Hanbury, Mr. Henry Groves, Mr. W. W. Reeves, Dr. Spurrell, and other well-known botanists. Those wishing to attend the meeting should apply for programmes and tickets to the Honorary Secretary, Buckhurst Hill, Essex.

WE stated some months ago that Capt. Scheele of the Swedish trading barque *Monarch*, before leaving Sweden for Melbourne, had asked the Zoological Museum at Upsala to lend him the necessary apparatus, vessels, &c., for deep-sea researches, with which request the Museum gladly complied. The results appear to have been so fruitful, that the *New York Herald* and the *Sun*, on the vessel recently arriving in New York, sent representatives on board, and devoted a great deal of space to descriptions of the collection made by "the intelligent Swedish seaman." The collection is, it is

stated, very rich, filling two hundred vessels, and contains many new varieties. It will be forwarded to Upsala, while Capt. Scheele proceeds with his scientific researches during a voyage to the West Indies.

ONE of the most remarkable articles of export ever despatched for scientific purposes from any country is without doubt the consignment which has just left Norway for Germany. It is no less than fifty-two skeletons of Lapps, which have during the summer been unearthed at Utsjok in Russian Lapland, and which an enterprising dealer of Vardö has sold to various museums and societies on the Continent at the price of 6*l.* a piece. Two of the skeletons are those of children, the rest those of adults.

THE Berlin Academy of Sciences has commissioned Dr. Georg Volkens, a young botanist, to proceed to the sulphur-baths of Heluan, which are situated some 20 kilometres west of Cairo, in order to make a thorough investigation of the anatomy of desert plants, and microscopical researches concerning the growth of these plants.

UP to the present the North Cape on Mager Oe was considered to be the northernmost point of Europe. Capt. Sørensen, however, has recently found that Cape Knivskjaerodden, on the same island and west of the North Cape, lies 30" to the north of the latter; 30" of arc would correspond to about 926 metres. The latitudes found by Capt. Sørensen for the two capes are 71° 10' 15" N. for the North Cape, and 71° 10' 45" N. for Cape Knivskjaerodden.

A SEVERE earthquake occurred at Windsor, Ontario, at a quarter to three on the afternoon of September 19. Shocks were felt at twenty minutes past two at Grasslake, Michigan, where some school children fainted with alarm, and at Toledo, Ohio, and neighbouring towns. The shocks lasted fifteen seconds, and in some instances buildings rocked and their contents were displaced.

MM. D. TOMMASI AND RADIQUET have brought out a new battery with two carbon electrodes. The positive electrode consists of a carbon plate placed at the bottom of a porcelain vessel and covered with peroxide of lead, the negative electrode consists of a carbon plate containing on its upper surface platinised coke. The two plates are separated by a sheet of parchment paper. The liquid used is a saturated solution of common salt, which must not completely cover the upper plate. The E.M.F. on closed circuit is 0.6 volts.

IN a paper on "Electric Lighthouses" M. De Meritens gives some very interesting figures in comparing oil and electricity as illuminants. The figures, he states, are taken from two memoirs by M. Allard. As an example, the light at Dunkirk, obtained from mineral oil, is 6,250 candles, which in weather of mean transparency is seen for 53 km.; if this be compared with an electric light of 125,000 candles, it is found that the electric light is seen for 75.4 km. Thus, an increase in the illuminating power of twenty times only increases the penetrative distance 22 km. or 42 per cent. If we now take a less transparent state, the ratio is reduced to an increase from 24 to 32 km. or 34 per cent. Or, lastly, in very foggy weather the distances are 3.7 and 4.6 km., showing an increase of 24 per cent. From these general figures M. Allard has calculated that in foggy weather in the Channel the luminous intensity with oil of 6250 carrels is 3.805 km.; then, if this be increased to an oil illumination of 125,000 carrels, the luminous intensity of 4.740 km. Now, comparing this with an electric light of 125,000 carrels, he finds the luminous distance to be 4.696, or the penetrating power of the electric light is less than 1 per cent. less than mineral oil, whilst its cost, as computed by both English and French engineers, is from four to six times less than that of oil.

THERE is unfortunately now no doubt that Phylloxera has begun to appear in Rhenish Prussia. The districts of Heimersheim and Lohrsdorf in the valley of the Ahr are hopelessly infected and considered lost. Every effort is being made to prevent the pest from spreading.

THE Japanese appear to be determined to render themselves, as far as possible, independent of foreign countries. They have, says the *Pharmaceutical Journal*, established in Tokio a factory for the production of pharmaceutical chemicals on a large scale. A company with a capital of about 40,000*l.* has been formed for this purpose. Of this amount the Government has contributed one-half free of interest for twenty years, besides making a free grant of land and erecting the necessary buildings. A similar company is taking up the utilisation of the waste *saké* from the native breweries in the manufacture of alcohol, and the manufacture of bleaching-powder on a large scale has been commenced. Whether with the object of "protecting" the first of these enterprises or not does not appear, but we learn from the same authority that an increased tax has been placed in Japan on imported patent medicines, and the nature of the articles to which this has been extended is stated to have largely affected the import of some chemicals into that country. Santonin, which was at one time much in request among the Japanese, decreased 20,000 ounces in import last year, although the price was lower; on the other hand, the consumption of quinine showed an increase.

IN a paper read before the Vaudois Society of Natural Sciences, M. Schnetzler explained the results of his studies on the colour of flowers. He argues that only one colouring substance exists in plants, and that the various colours of flowers are only due to the modifications made in this substance by the acids or alkalis contained in the plants themselves.

A VICTORY has been gained by Van Rysselberghe in Belgium by the solution of the problem of transmitting a telegraphic and a telephonic message along the same wire at the same time. A trial of this has been made at the Antwerp Universal Exhibition, where concerts held in important towns in Belgium were heard; the transmission being made with ordinary instruments along ordinary telegraph lines and with earth returns.

M. COLLADON has observed a curious phenomenon connected with hailstones. He observed, on some occasions, that two or three seconds after they had fallen they sprung into the air again, to a height of 0.25 m. or 0.30 m., as if they had been struck upwards by the earth.

THE additions to the Zoological Society's Gardens during the past week include a Green Monkey (*Cercopithecus callitrichus* ♂), a Ludio Monkey (*Cercopithecus ludio*) from West Africa, presented by Mr. A. Bowden; an Australian Fruit Bat (*Pteropus poliocephalus*) from Australia, presented by Capt. C. D. Long; a Tawny Owl (*Sy nium aluco*), British, presented by Miss H. Freeman; a Coypu Rat (*Myopotamus coypus*) from South America, presented by Mr. Frank Parish, F.Z.S.; two Black-billed Tree Ducks (*Dendrocygna arborea*) from Antigua, West Indies, presented by Mr. C. Arthur Shand; a Blackcap (*Sylvia atricapilla*), British, presented by Mr. H. Keilich; a Spanish Terrapin (*Chrysemys leprosa*), South European, presented by Master A. Brierly; a Horned Lizard (*Phrynosoma cornutum*) from California, presented by Mr. Alfred K. Wallace, F.Z.S.; an Indian Python (*Python molurus*) from Ceylon, presented by Mr. A. A. Dalmege, F.R.G.S.; a Bonnet Monkey (*Macacus sinicus*) from India, two North African Jackals (*Canis anthus*) from Spain, deposited; two Half-collared Turtle Doves (*Turtur semitorquatus*), two Triangular-spotted Pigeons (*Columba guinea*), two Bronze-spotted Doves (*Chalcopelia chalcospilos*), four Harlequin Quails (*Coturnix histriónica*), an Allen's Porphyrio (*Hydro nia*

*alleni*) from West Africa, received on approval; a Levaillant's Cynictis (*Cynictis penicillata*), three Long-fronted Gerbilles (*Gerbillus longifrons*), born in the Gardens.

OUR ASTRONOMICAL COLUMN

THE FIGURE OF URANUS.—In a note communicated to the Reale Accademia dei Lincei, Prof. Millosevich collects the measures of Uranus which have been made by various observers, and adds the results of several series made by himself at the Observatory of the Collegio Romano. While the recent measures of Schiaparelli at Milan are in accordance with those of Madler at Dorpat, as regards a very sensible ellipticity, most observers have failed to recognise, or at least have not referred to, any measurable quantity, amongst them Engelmann, Vogel, Lassell, Marth, and Kaiser. It is a point which might be expected to be readily settled if large telescopes were brought to bear upon it, and particularly if the double-image principle of measurement were employed.

THE LUNAR ECLIPSE ON OCTOBER 4.—During this eclipse the moon will be in a somewhat bare part of the sky, and with one exception no star brighter than the tenth magnitude will be occulted while she is immersed in the earth's dark shadow, or between 0*h.* 16*m.* and 10*h.* 48*m.* One of the tenth magnitude, of which an accurate position is given in vol. vi. of the Bonn Observations disappears at 9*h.* 33*m.* 35*s.* and reappears at 10*h.* 37*m.* 54*s.*, the angles being respectively 137° and 271°; No. 800 of Weisse's Bessel, 0*h.* R.A., disappears at 10*h.* 35*m.* 24*s.* at 100", but does not reappear till 11*h.* 45*m.* 35*s.* (308") when the moon will have begun to emerge from the shadow; this star is estimated 9 m. by Bessel. The times are for Greenwich.

OLBERS' COMET OF 1815.—In Nos. 2613 14 of the *Astronomische Nachrichten* Prof. Krueger has printed the sweeping-ephemerides for this comet calculated by Herr Ginzl of Vienna, at least between the dates October 1 and January 1. Although the epoch of perihelion passage directly resulting from the computation of the perturbations during the present revolution does not fall before December 1886, the discussion of the observations in 1815 left an uncertainty of ± 1.6 year in the time of revolution at the instant of perihelion passage in that year, and it may be well to commence a search for the comet forthwith; it is to be remarked, however, that, should it reach perihelion in midwinter in these latitudes, it is not likely to pass unobserved, the intensity of light b a high north declination

THE COMET OF 1729.—"La Comète de 1729 est de toutes les comètes, observées jusqu'en 1780, celle qui a été vue à la plus grande distance du Soleil et de la Terre," writes Pingré in his "Cométographie." Upwards of a century has since elapsed, and yet no comet observed in the meantime has had a perihelion distance at all approaching that of the comet discovered by Père Sarabat at Nîmes on July 31, 1729. The comet was seen until the end of January following, and was observed by Cassini until the 18th of that month. From some of his observations newly reduced, Burckhardt calculated both parabolic and hyperbolic orbits which were first published in the *Connaissance des Temps* for 1821. Recently, employing Burckhardt's reductions of Cassini's observations on September 3, November 10, and January 16, Mr. Hind has found the following parabolic elements:—

Perihelion passage, 1729, June 16 <sup>h</sup> 15 <sup>m</sup> 42 <sup>s</sup> M. T. at Paris			
Longitude of perihelion	... ..	321 2 46.1	} Mean
ascending node	... ..	310 37 8.3	
Inclination	... ..	77 4 6.0	} Equinox
Logarithm of perihelion distance..	...	0.607513	
Motion—direct			

By which the middle observation is represented within 16" in longitude and 10" in latitude. The distances from the earth and sun at the times of the three observations are:—

1729 Sept. 3	.. From Sun, 4' 107	.. From Earth, 3' 142
Nov. 10	.. " 4' 240	.. " 4' 339
1730 Jan. 16	.. " 4' 439	.. " 5' 132

The distance in perihelion is 4.05, the earth's mean distance from the sun being taken as unity. The comet of 1747 had a perihelion distance of 2.198, which is the nearest approach to that of the comet of 1729; it was a very exceptional and extraordinary body.



### CONSTITUTION AND ORIGIN OF THE GROUP B OF THE SOLAR SPECTRUM<sup>1</sup>

WHEN a single prism spectroscope is directed towards the sun at the moment when it is in the neighbourhood of the zenith, we perceive near C, at about a fourth of the distance separating it from the extreme red, a strong black line, which Fraunhofer has named B. Under a more powerful instrument of five or six prisms this line becomes a very black broad band, separated from the region of C by what may be described as almost an empty space, the lines which do exist in it being few and faint. On the other side this band is followed by well-marked lines, which appear to be very regularly spaced, and the first of which show some indications of being double. Father Secchi had vainly attempted to resolve the band B; on this subject he writes:—

“Certain bands which in ordinary instruments seem to be stumped consist in reality of numerous perfectly distinct lines, as is seen in a spectroscope possessing great dispersive power; but some of them are really massed towards the edge, and there it is impossible to separate them, however powerful the instrument employed. We may cite as an example the lines of the group B” (*Le Soleil*, vol. i. ed. 1875, p. 235).

The statement of the learned physicist shows that, at the

time he wrote the above, spectroscopic apparatus had not been brought to very great perfection or power. In point of fact the dispersion of eight or ten prisms suffices to show that the band B is really formed of a large number of distinct lines. With my highly-dispersive instrument it becomes resolved in a truly marvellous manner. The seventeen lines composing it are distinguished with the greatest clearness, and may be very exactly measured. Those following it on the red side are all broadly doubled, presenting in their regularity a very remarkable appearance.

In 1878 Messrs. Piazz-Smyth and Langley succeeded for the first time and almost simultaneously in resolving this group. Piazz-Smyth, working with prisms, obtained only an incomplete resolution, whereas, by means of Rutherford's excellent appliances Langley not only separated all the lines, but also determined their wave-lengths. Being unaware of the work of these physicists, I fancied I had been the first to obtain these results in 1879, when making the first essays with my highly-dispersive apparatus. The sulphide of carbon compound prisms, which M. Laurent had just made, were merely mounted on a drawing-board, were badly regulated, badly sheltered from variations of temperature, and could not yield the results that I now obtain. The drawing which on that occasion I published in the *Comptes Rendus* is incomplete and inaccurate. That

#### Solar Spectrum—Region B, by M. L. Thollon.

Position of the lines.				
Mean aspect of region B when the sun is 80° from the zenith.		60°	“	moist weather.
“	“	60°	“	dry
Non-telluric lines.	Spectrum of region B as it would appear if observed outside the atmosphere.			

which accompanies this article has been made with the greatest care and to a scale on which the errors of position can scarcely exceed 1/10 mm. It is more complete than any I have yet seen.

The explanations given at the foot of my design enable us to recognise at a glance: (1) the metallic lines, (2) the telluric lines produced by the variable element of the atmosphere (beyond all doubt aqueous vapour); (3) the telluric lines proceeding from the constant elements (oxygen, nitrogen, carbonic acid). The group is thus seen to consist of a pencil of seventeen rays, constituting properly speaking Fraunhofer's B-band; of a system of twelve couples with intervals increasing regularly from right to left, whereas the distance of the constituents diminishes with equal regularity in the opposite direction; lastly, of a somewhat important group belonging to the vapour of water, the whole interspersed with a few weak metallic lines.

When we survey the solar spectrum given by my apparatus, beginning with the violet, and when we behold the thousands of lines composing it distributed in all the regions without any apparent kind of order, on arriving at the group B we feel, as Mr. Langley remarks, the same impression as does a traveller lost in a virgin forest when he suddenly finds himself in the presence of a perfectly straight avenue of trees planted with mathematical regularity. It should be added that A at the

<sup>1</sup> Paper by M. L. Thollon in *Bulletin Astronomique*, May 1884.

extreme red, and a comprised between C and D are identically constituted. If they attract less attention it is because A is nearly at the limit of the field of vision, while the regularity of a is disguised by a large number of lines foreign to its origin. Beyond these three cases chance alone seems to have presided over the distribution of lines throughout the whole spectrum.

But the interest attaching to these groups is due not only to their remarkable appearance, but also and especially to the question of their origin. In what regions are produced the absorptions which give them birth? In the solar atmosphere, in the terrestrial atmosphere, or in some medium comprised between the sun and the earth? Do these absorptions proceed from a common element, and if so what is its nature? The most contradictory answers have been given to these various questions, which have already long since been asked.

To speak only of B, after his memorable experience of La Villette in 1866, M. Janssen asserted that this group was at least to a great extent due to aqueous vapour. The little sketch published by him in the *Annales de Chimie et de Physique* series, vol. xxiv. p. 217 in fact shows, facing B, bands of absorption due to the vapour of water, and corresponding exactly to the spectral bands yielded by the setting sun in region. On the other hand, Ångström, who had devoted much study to the question, tells us that at the low temperature of 27° C.,

when the other telluric lines had almost entirely disappeared, he saw B perfectly distinct. At a like zenith distance from the sun this group seemed to him even blacker and more intense than usual. Hence his inference that it could not proceed from the vapour of water. This eminent physicist, a thoroughly convinced partisan of spectral unity for the simple gases, had ascertained that in the spectrum of atmospheric emission there was no trace of any ray or band corresponding to B. It followed for him that the air could not absorb radiations it was incapable of emitting. If therefore this group, variable like the other telluric rays, could be attributed neither to aqueous vapour, to nitrogen, nor to the oxygen of the air, from what element did it derive its origin? Ångström spoke of carbonic acid, but perhaps without believing in it. He seemed deeply interested in Tyndall's experiments on the absorbing power of gases by heat. We know that this skilful investigator had found that the coefficients of absorption of oxygen and nitrogen by no means corresponded with the coefficient of absorption of the air. The difference he attributed to some unknown element sufficiently rarefied to escape our analyses, and endowed with immense absorbing power. Ångström had probably this unknown element in his mind, but he remained uncertain to the last.

The great authority of the Swedish physicist could not fail to have its influence on the judgment of those approaching the question after him. Captain Abney, who has so greatly distinguished himself by his remarkable scientific labours, asserts in NATURE (October 12, 1882, p. 585) that the groups A and B cannot be regarded as telluric, but as proceeding from a medium lying between the sun and the earth. Piazzi Smyth, who had at first looked on B as telluric, seems to have finally adopted Captain Abney's views, and is disposed to think that B as well as A may after all be the product of some interplanetary medium. In his opinion the recent theories of Siemens seem to confirm his view of the case.

The attention that I have for several years paid to the portion of the solar spectrum stretching from A to b has naturally led me to deal with this subject. Here is the method by which I succeeded in separating and classifying the spectral lines. After certain preliminary measures taken with the greatest care to determine their exact position, each region of the spectrum is drawn on two maps. The first is intended to reproduce the appearance of this region when the sun is at 60° from the zenith, the second when at 80°. These distances have been chosen in such a way that in the latitude of Nice the observations may be continued throughout the year. When the weather seems favourable at the hour when the sun is in the desired position, the intensity of each line is marked on the map itself with all possible exactness, the hygrometric state of the air being indicated each time. The process is slow, delicate, and laborious, but the result is certain. After I have thus made eight or ten series of observations on each drawing, they are carefully examined, and the indications relative to any given line enable me confidently to decide:—(1) whether it is not metallic; (2) whether a telluric line belongs to a constant or to a variable atmospheric element. By this method I have been able to satisfy myself that A, B, and a are telluric groups due to the constant elements of the air. *At the same distance from the zenith they have always the same intensity.* I refer of course only to the main groups in each of them, and to the couples following them on the least refrangible side.

It remained to determine exactly to what atmospheric element the groups in question were to be attributed. M. Egoroff, Professor of Physics at the University of Warsaw, has recently succeeded in solving the problem. He had for several years ardently devoted himself to this inquiry, and in 1882 we jointly made a series of experiments on the subject in the Paris Observatory. A pencil of electric light directed from Mount Valérien on the Observatory, distant to km., gave us the spectrum of the telluric rays all but complete. There was no difficulty in distinguishing A, B, and a, which are so easily recognised. Capt. Abney has questioned the results obtained by us. Yet they are incontestable, and in any case the experiment can be easily repeated.

At last, after these preliminary studies, M. Egoroff, operating directly on oxygen closely compressed in a metallic tube, and traversed lengthwise by a pencil of strong light, has obtained the groups A and B. The thickness of the oxygen thus traversed was doubtless insufficient for the production of a. But however this be, it may now be confidently asserted that these three, which are of such remarkable appearance, and which so

closely resemble each other, have their origin in the absorption due specially to atmospheric oxygen.

I need not dwell upon the importance of this result; but how is it to be reconciled with the observations of Messrs. Janssen, Ångström and Piazzi Smyth? To judge from the sketch contained in the *Annales*, and above referred to, M. Janssen must have seen in the spectrum of aqueous vapour bands corresponding to those of the solar spectrum in the region of B. One of them even coincides exactly with the chief member of the group. According to my own observations, to produce this effect the vapour of water would have to yield at this point a non-resolvable band, which would simply obscure the intervals between the lines, as is seen in the spectrum 1 of my drawing. This observation should then vary according to the hygrometric state of the air, and not, as it has always seemed to me, according to the height of the sun. Or else this band is not represented in the exact position it ought to occupy, and should be shifted more to the left, where in fact are found many lines of the vapour of water constituting an important group (see plate).

If, on the other hand, Ångström saw B more intense at a temperature of 27° C., it was doubtless owing to a simple effect of contrast. The other telluric lines being greatly weakened, those that retain their intensity must naturally appear blacker. Such an effect is frequently produced in the course of my observations, and against it I have to be constantly on my guard. And now how can we explain why the spectrum of absorption of the oxygen differs so much from its spectrum of emission? The lack of sufficient data renders all explanation impossible; but the certainty of the fact obliges us to conclude that cold has not the same properties as incandescent oxygen, and allows us to suspect that it may be the same with all gases.

In asserting that A and even B do not really vary in intensity when the sun approaches the horizon, such an eminent observer as Piazzi Smyth would have greatly surprised professional spectroscopists, were they not aware how difficult and delicate a matter is the management of an apparatus of highly dispersive power. Let but the luminous pencil be badly adjusted, the prisms less than faultlessly regulated, the slightest cloudiness settle on the surfaces, the images, especially in the extreme red, will at once appear as if drowned in the diffused light, which obscures the most evident effects and even disfigures their essential characters. Strange phenomena are often produced, the causes of which it seems impossible to discover, and which easily give rise to illusions. But when we work under favourable conditions with a well-designed and well-constructed apparatus, it becomes superabundantly evident that A and B vary considerably in intensity according to the height of the sun, and are certainly telluric.

During the total eclipse of 1882, both M. Trépid and myself fancied we observed on the edge of the lunar disk a notable strengthening of the rays of the B group. If Captain Abney's theory could have been confirmed, it would have certainly added great weight to our observations, and for my own part I should have felt highly satisfied at the result. Unfortunately, the atmosphere of oxygen which should now be attributed to the moon in order to produce the observed effects, seems scarcely reconcilable with the absence of refraction in the luminous rays striking the edge of our satellite. I greatly fear the results obtained in Egypt are one of those illusions, of which nearly all spectroscopists have been more or less the victims.

It would now be important to ascertain whether the nitrogen and carbonic acid of the air may not be represented by any line or any group in the solar spectrum. The study I am at present engaged in, according to the above described method, will not fail, I trust, to yield precise results on this important point. Hitherto, apart from the oxygen groups, I have discovered no line that may be confidently attributed to the constant elements of the atmosphere. Hence it is desirable to await the result of my researches before giving effect to the project adopted by M. Bischoffsheim to establish on Mont Gross metallic tubes of considerable length, in which the spectra of absorption of gases may be studied on a grand scale.

#### THE MIGRATIONS OF "SALMO SALAR" (L.) IN THE BALTIC

THE following statement gives further details supplementary to our recent article on this subject:—

Since the earliest times salmon have been caught in the Finnish rivers which had in their mouths or entrails hooks

of a peculiar shape entirely unknown in Finland. Such hooks have been found in salmon taken in all Swedish and Finnish rivers falling into the Gulf of Bothnia. At one of the salmon fisheries in the Uleå River, for instance, where the fish is sold cleaned, twenty-five such hooks, all of brass, were collected last summer and handed to me. With a few exceptions the hooks are of one kind, viz. made of brass wire 2 to 2.5 mm. thick, a little compressed in the hook itself, while the length varies from 9.5 to 11.5 cm. Most of the hooks are 10.5 cm. in length, and the width of the bend 2.5 to 3.5 cm. Generally a bit of line 1 to 2 mm. thick, made of flax, hangs to the hook, while, when the line is long enough, a lead, conical in shape and 10 to 20 gm. in weight, is found on the same. Sometimes Latin characters are engraved on the lead, as, for instance, in one taken in the above-mentioned river last summer, which had on it "C" and "K" on each side. I am of opinion that all the hooks which have passed through my hands are of the same type and manufacture.

As it is of great practical value to discover whence these peculiar brass hooks have come, I have given considerable attention to the question, the result of which is that I have come to the conclusion that they were brought from the north coast of Germany, where they are used for salmon-fishing in the winter. Great fisheries are carried on along this coast in a depth of 30 to 60 m. and 10 to 30 km. from the shore, as far as, and probably beyond, the Russian frontier. The lines used are very like those used on the south coast of Sweden, but the hooks and leads are quite different. Prof. Benecke, of Königsberg, to whom I sent a hook taken from a salmon in the Uleå River, asserts too that these have come from the shores of Prussia and Pomerania. As hooks of this kind are not used in any other part of the Baltic or outside of it, it is evident that the salmon must have brought these from the above-mentioned places to the shores of the Gulf of Bothnia.

It is, on the other hand, but seldom that hooks of iron and tin are found in salmon in our rivers, which is caused, I believe, by the circumstance that the Scandinavians use far stronger lines for salmon-fishing than the Germans. I have, however, two in my possession which are of the exact kind used by fishermen in the sea about Bornholm and the south-east coast of Sweden.

Besides the above-mentioned kinds of hooks I have obtained a very peculiar one taken from a salmon off the town of Kristinestad. It is 4 cm. long, of hammered thick brass wire, and of a very uncommon shape, and through two holes fastened to two double-twined brass wires 40 cm. long, and 1 mm. thick. I do not know from what part of the Baltic this strange hook hails, but I believe from the Russian shore of the same.

The discovery of hooks of a foreign shape in salmon in the northern rivers of Sweden and Finland was made about 200 years ago, as may be seen in the journals of the Swedish Academy of Sciences of the seventeenth century, and even at that date their remarkable shape and manufacture attracted attention.

The relatively great number of brass hooks found in salmon taken in the rivers around the Gulf of Bothnia demonstrates beyond doubt that the fish, after visiting the coast of Northern Germany, return to the northernmost shores of Sweden and Finland, while some have visited the southern part of Sweden on their way north, as the iron hooks clearly indicate. If it is true, as is generally believed, that the salmon returns for spawning to the rivers of its birth, we may with equal force assume that the great takes of young salmon on the southern coast of Sweden and the shores of Baltic Germany during recent years is due to the rigid closing in of the rivers of Northern Sweden and Finland, whence they migrate south. During the last fifteen years, since when closing began in the Finnish rivers, the takes of young salmon—from 1 lb. to 2 lb. in weight—in nets about Bornholm and on the shores of Germany, have fabulously increased, and my opinion is that these fisheries are of such a destructive nature to this noble fish in Sweden and Finland that some arrangement ought to be made between the Baltic Powers to put a stop to the same.

By marking the salmon in England and Scotland, pisciculturists have come to the conclusion that varieties of salmon during their stay in salt water visit preferably certain parts of the coast for their food; thus, according to the late Frank Buckland, the shores around Yarmouth are the favourite haunts of the "bull-trout" of certain English and Scottish rivers. The great student of the salmon fisheries of Scotland, particularly those of the River Tweed, David Milne Holme, relates as an example of how quickly fish of the salmon kind can travel to a favourite

feeding-ground, that a "bull-trout" marked with a silver thread with an inscription in the River Tweed, on March 29, 1852, was taken, on April 2, near Yarmouth, having thus accomplished a distance of nearly 300 miles in four days. Another fish was marked in the same river on March 10, 1880, and was caught at Yarmouth on May 5, having taken fifty-five days for the journey.

As the salmon, *Salmo salar*, according to the experience gained in Scotland, prefers sandy feeding-grounds during its stay in salt water, and as the bottom of the Baltic on the coast between Memel and Rügen, at Bornholm and South-East Sweden, is sand at a certain depth, where its favourite food is found, the cause of the migrations of the salmon in the Baltic southwards may be accounted for, while their return to the northern rivers of Sweden and Finland in the spring is unquestionably due to their breeding-instincts.

Helsingfors

AND. JOH. MALMGREN

## THE BRITISH ASSOCIATION REPORTS

*Report of the Committee, consisting of Major-Gen. Sir A. Clark, R.F., C.B., Sir J. N. Douglass, Capt. Sir F. J. O. Evans, R.N., K.C.B., F.R.S., Capt. J. Parsons, R.N., Prof. J. Prestwich, F.R.S., Capt. W. J. L. Wharton, R.N., Messrs. E. Easton, R. B. Grantham, J. B. Redman, J. S. Valentin, L. F. Vernon-Harcourt, W. Whitaker, and J. W. Woodall, with C. E. De Rance and W. Topley as Secretaries, appointed for the Purpose of Inquiring into the Rate of Erosion of the Sea-coasts of England and Wales, and the Influence of the Artificial Abstraction of Shingle or other Material on that Action. Drawn up by C. E. De Rance and W. Topley.*—The importance of the subject referred to this Committee for investigation is universally admitted, and the urgent need for inquiry is apparent to all who have any acquaintance with the changes which are in progress around our coasts. The subject is a large one, and can only be successfully attacked by many observers, working with a common purpose and upon some uniform plan. The Committee has been enlarged by the addition of some members who, by official position or special studies, are well able to assist in the work. In order fully to appreciate the influence, direct or indirect, of human agency in modifying the coast-line, it is necessary to be well acquainted with the natural conditions which prevail in the places referred to. The main features as regards most of the east and south-east coasts of England are well known; but even here there are probably local peculiarities not recorded in published works. Of the west coasts much less is known. It has therefore been thought desirable to ask for information upon many elementary points which, at first sight, do not appear necessary for the inquiry with which this Committee is intrusted. A shingle-beach is the natural protection of a coast; the erosion of a sea-cliff which has a bank of shingle in front of it is a very slow process. But if the shingle be removed the erosion goes on rapidly. This removal may take place in various ways. Changes in the natural distribution of the shingle may take place, the reasons for which are not always at present understood; upon this point we hope to obtain much information. More often, however, the movement is directly due to artificial causes. As a rule, the shingle travels along the shore in definite directions. If by any means the shingle is arrested at any one spot, the coast-line beyond that is left more or less bare of shingle. In the majority of cases such arresting of shingle is caused by building out "groynes," or by the construction of piers and harbour-mouths which act as large groynes. Ordinary groynes are built for the purpose of stopping the travelling of the shingle at certain places, with the object of preventing the loss of land by coast-erosion at those places. They are often built with a reckless disregard of the consequences which must necessarily follow to the coast thus robbed of its natural supply of shingle. Sometimes, however, the groynes fail in the purpose for which they are intended—by collecting an insufficient amount of shingle, by collecting it in the wrong places, or from other causes. These, again, are points upon which much valuable information may be obtained. Sometimes the decrease of shingle is due to a quantity being taken away from the beach for ballast, building, road-making, or other purposes. Solid rocks, or numerous large boulders, occurring between tide-marks, are also important protectors of the coast-line. In some cases these have been removed, and the waves have thus obtained a greater power over the land. To investigate these various points

is the main object of the Committee. A large amount of information is already in hand, much of which has been supplied by Mr. J. B. Redman, who for many years has devoted special attention to this subject. Mr. R. B. Grantham has also made important contributions respecting parts of the south-eastern coasts. But this information necessarily consists largely of local details, and it has been thought better to defer the publication of this for another year. Meanwhile the information referring to special districts will be made more complete, and general deduction may be more safely made. As far as possible the information obtained will be recorded upon the six-inch maps of the Ordnance Survey. These give with great accuracy the condition of the coast, and the position of every groyne, at the time when the survey was made.

Appended is a copy of the questions circulated. The Committee will be glad of assistance, from those whose local knowledge enables them to answer the questions, respecting any part of the coast-line of England and Wales. Copies of the forms for answering the questions can be had on application to the Secretaries.

*Appendix—Copy of Questions.*—1. What part of the English or Welsh coast do you know well? 2. What is the nature of that coast? (a) if cliffy, of what are the cliffs composed? (b) what are the heights of the cliff above H.W.M.? Greatest, average, least. 3. What is the direction of the coast-line? 4. What is the prevailing wind? 5. What wind is the most important—(a) in raising high waves? (b) in piling up shingle? (c) in the travelling of shingle? 6. What is the set of the tidal currents? 7. What is the range of tide? Vertical in feet, width in yards between high and low water, at spring tide, and at neap tide. 8. Does the area covered by the tide consist of bare rock, shingle, sand, or mud? (a) its mean and greatest breadth; (b) its distribution with respect to tide-mark; (c) the direction in which it travels; (d) the greatest size of the pebbles; (e) whether the shingle forms one continuous slope, or whether there is a "spring full" and "neap full," if the latter, state their heights above the respective tide-marks. 10. Is the shingle accumulating or diminishing, and at what rate? 11. If diminishing, is this due partly or entirely to artificial abstraction (see No. 13)? 12. If groynes are employed to arrest the travel of the shingle, state—(a) their direction with respect to the shoreline at that point; (b) their length; (c) their distance apart; (d) their height—(1) when built, (2) to leeward above the shingle, (3) to windward above the shingle; (e) the material of which they are built; (f) the influence which they exert. 13. If shingle, sand, or rock is being artificially removed, state—(a) from what part of the foreshore (with respect to the tidal range) the material is mainly taken; (b) for what purpose; (c) by whom—private individuals, local authorities, public companies; (d) whether half-tide reefs had, before such removal, acted as natural breakwaters. 14. Is the coast being worn back by the sea? If so, state—(a) at what special points or districts; (b) the nature and height of the cliffs at those places; (c) at what rate the erosion now takes place; (d) what data there may be for determining the rate from early maps or other documents; (e) is such loss confined to areas bare of shingle? 15. Is the bareness of shingle at any of these places due to artificial causes? (a) by abstraction of shingle; (b) by the erection of groynes, and the arresting of shingle elsewhere. 16. Apart from the increase of land by increase of shingle, is any land being gained from the sea? If so, state—(a) from what cause, as embanking salt-marsh or tidal foreshore; (b) the area so regained, and from what date. 17. Are there "dunes" of blown sand in your district? If so, state—(a) the name by which they are locally known; (b) their mean and greatest height; (c) their relation to river mouths and to areas of shingle; (d) if they are now increasing; (e) if they blow over the land, or are prevented from doing so by "bent grass" or other vegetation, or by water channels. 18. Mention any reports, papers, maps, or newspaper articles that have appeared upon this question bearing upon your district (copies will be thankfully received by the Secretaries). 19. Remarks bearing on the subject that may not seem covered by the foregoing questions. [N.B.—Answers to the foregoing questions will in most cases be rendered more precise and valuable by sketches illustrating the points referred to.]

by J. T. Bottomley.—In the course of a series of experiments on the heating of conductors by the electric current, which were carried on during the past winter, I obtained a considerable number of results which both gave me the means of calculating the emissivity for heat in absolute measure of various surfaces under different circumstances, and also caused me to undertake a number of special experiments on the subject. These experiments are still in progress, and I am making preparation for a more extended and complete series; but a brief notice of some of the results already arrived at may not be without interest to the British Association.

The experiments were made on wires of various sizes, some of them covered and some of them bare, cooling in air at ordinary temperatures, and at normal and also at very much reduced pressures.

The mode of experimenting was as follows;—

A current passing through a wire generates heat, the amount of which is given by Joule's well-known law—

$$H = C^2 R / J \dots \dots \dots (1)$$

where  $C$  is the current,  $R$  the electrical resistance,  $J$  Joule's equivalent, and  $H$  the quantity of heat generated per unit of time; each being reckoned in C.G.S. units. Let  $l$  be the length of the wire,  $d$  its diameter, and  $\sigma_t$  the specific resistance of the material at temperature  $t^\circ$  (at which temperature let us suppose that the wire in the given external conditions is maintained by the current). Then

$$R = \frac{\sigma_t l}{\frac{1}{4} \pi d^2} = \frac{4 \sigma_t l}{\pi d^2}$$

Hence from (1)—

$$H = \frac{C^2}{J} \cdot \frac{4 \sigma_t l}{\pi d^2} \dots \dots \dots (2)$$

Consider, now, that the wire suspended in the air is losing heat by its surface, and let us suppose that it neither loses nor gains heat by its ends. Let  $H'$  be the quantity lost by emission from the surface per unit of time. Let  $e$  be the emissivity, or quantity of heat lost per unit time per unit area of the cooling surface per unit difference of temperatures between the cooling surface and the surroundings; and  $t^\circ$  being, as has been said above, the temperature of the wire, let  $\theta$  be the temperature of the surroundings. Then

$$H' = \pi d l \cdot e \cdot (t - \theta) \dots \dots \dots (3)$$

But when the wire has acquired a permanent temperature, with the current flowing through it, there is as much heat being lost at the sides as is being generated by the current. In this case  $H = H'$ ; and we obtain the expression for  $e$ —

$$e = \frac{4 C^2 \sigma_t}{J \pi^2 d^2 (t - \theta)} \dots \dots \dots (4)$$

My experiments consist in measuring the strength of the current and the temperature of the wire, the latter being effected by measuring the electric resistance of a known length of the wire while the current is flowing through it, and hence inferring the temperature. These being known, and likewise the temperature of the surroundings, we have all the data for finding  $e$ , the emissivity of the surface in absolute measure. The experiments of Mr. D. Macfarlane giving emissivities in absolute measure are well known, and are of undoubted accuracy. They were communicated to the Royal Society (*Proc. Roy. Soc.*, 1872, p. 93); and the results are quoted in Prof. Everett's "Units and Physical Constants" (chap. ix. § 137). These experiments were made with a copper globe about 4 cm. in diameter, suspended in a cylindrical chamber, with top and bottom, about 60 cm. in diameter, and 60 cm. high. The results may be briefly summed up as follows:—

Macfarlane finds an emissivity of about 1/4000th of the thermal unit C.G.S. per square centimetre per second per degree of difference of temperatures between cooling body and surroundings for a polished surface, with an excess of temperature of a little more than 60° C.; and, for a blackened surface, the same emissivity with an excess of 5° C. or under.

Using round wires of small diameter (0.85 mm. and under), and with the surfaces either brightly polished or in common dull condition of a wire fresh from the maker, I have found a much larger emissivity than 1/4000. I have obtained different values of  $e$  for wires of different sizes, varying from 1/2000 down to 1/400, which was obtained with a wire of 0.40 mm. diameter, and with an excess of temperature of 24° C. It seems to be shown by all the experiments I have made that, other things being the same, the smaller the wire the greater the emissivity.

SECTION A—MATHEMATICAL AND PHYSICAL SCIENCE

On Loss of Heat by Radiation and Convection as affected by the Dimensions of the Cooling Body; and on Cooling in Vacuum,

To do away with the part of the emissivity which is due to convection and conduction by the air, I have commenced experiments on loss of heat by small wires in the nearly perfect vacuum afforded by the modern mercurial air-pump. This part of the subject was experimented on long ago by Dulong and Petit, and within the last few years by Winkelman and Kundt and Warburg; lastly, and much more perfectly, by Mr. Crookes (*Proc. Roy. Soc.*, vol. xxxi. p. 239), though in no case, I believe, were the emissivities in absolute measure determined. The conclusion come to by all these experimenters is the same, namely, that there is a decrease of emissivity due to lowering of the air-pressure, this decrease being very small for a reduction down to one-half or one-third of the ordinary atmospheric pressure, but becoming very great as the vacuum approaches completeness.

The very interesting experiments of Mr. Crookes seem to show that, even with the high vacuum which he obtained, the effect of the residual gas in carrying off heat from the cooling body was far from being annulled.

The following table shows the emissivity of a copper wire with bright surface half a metre long, 0.40 mm. in diameter, and sealed into a glass tube about 1.5 cm. in internal diameter:—

Current amperes	Pressure, 760 millims.		Pressure, 380 millims.		Pressure, 180 millims.		Emissivity
	4.7	1822	4.5	1784	5.5	12176	
22.5	1/2034		21.5	1/1996	23.5	1/2174	17
56	1/2114		58	1/2180	55	1/2082	68
							1/6443
							1/5620
							1/4606

The following table may also be found interesting. It shows the emissivity in absolute measure of some materials commonly used as insulating coverings for wires.

Specifying number B.W.G. and nature of covering	Length of wire, Centims.	Resistance of 100 centims. B.A. units	Diameter of wire in millims.	Diameter of covered wire, outside measurement	1 - θ	Emissivity
No. 22, silk-covered ...	100	.0395	.76	.06		0.001323
No. 26, cotton-covered ...	100	.094	.50	.88		0.001385
No. 26, silk-covered ...	100	.1115	.45	.57	9.8	0.002020
No. 22, gutta-percha ...	100	.0455	.72	1.67		0.000854
No. 22, tinned, gutta- percha-covered, and double cotton cover- ed outside	100	.0432	.73	1.86		0.000759

*On Some Phenomena Connected with Iron and other Metals in the Solid and Molten States, with Notes of Experiments*, by W. J. Millar, C. E., Sec. Inst. Engineers and Shipbuilders in Scotland. —1. *Object of Paper.*—Results of experiments by the author with various metals, such as cast-iron, gun-metal, phosphor-bronze, lead, copper, and type-metal. The object being to determine the cause of the well-known phenomena of the flotation of cold cast-iron on molten cast-iron, and as to whether any expansion took place upon solidification in the metals above noted. 2. Notes of some of the experiments from which the author concludes that the cause of flotation of the solid metal on liquid metal of the same kind is *buoyancy*, due to expansion suddenly set up in the immersed pieces, and that this expansion was found by careful measurement to be at least equal to the shrinkage or total decrease in length of the piece from white hot solid to finally cooled down solid. Further, that the expansion observed is obtained within much lower limits of temperature than the shrinkage; as the pieces, which were in all cases removed from the molten metal, immediately on appearing floating hardly showed redness, and when broken it was found that the crystalline character of the metal remained. 3. Notes of experiments made by gradually heating pieces of cast-iron—the results of all these experiments leading the author to conclude that the rate of expansion in cast-iron is at first much more rapid at low

Temperature probably much too low. The wire, sagging down, touched the inside of the glass tube in several points.

temperature than afterwards at high temperature. 4. From experiments carried on with pieces of lead and copper and type-metal, it was found that if any flotation occurred it was only with small light pieces—heavy pieces sinking and remaining at bottom of ladle. Gun-metal and phosphor-bronze behaved like cast-iron. 5. Consideration of the peculiar appearance, or “break,” observed on the surface of molten cast-iron, the figures presenting a geometrical pattern, like interlacing circles or stars. The author believes that this appearance is due to cracks forming upon the rapidly forming skin—these cracks taking more or less a circular form from the convex forms into which the various parts of the surface are thrown, due to the bubbling up of gas or air. This appearance is limited to cast-iron, and experienced observers can tell the quality of the iron from the form of pattern or figures showing on the molten surface. 6. From observation and experiments carried out from time to time, the author concludes that no perceptible increase of volume of the metals noted occurs at the moment of solidification; at least when free from air or gas confined within the casting.

*On a Gyrostatic Working Model of the Magnetic Compass*, by Sir William Thomson.—In my communication to the British Association at Southport, I explained several methods for overcoming the difficulties which had rendered nugatory, I think, all previous attempts to realise Foucault's beautiful idea of covering with perfect definiteness the earth's rotational motion by means of the gyroscope. One of these, which I had actually myself put in practice with partially satisfactory results, was a

*Gyrostatic Balance for Measuring the Vertical Component of the Earth's Rotation.*

It consisted of one of my gyrostats supported on knife-edge<sup>s</sup> attached to its containing case, with their line perpendicular to the axis of the interior fly-wheel and above the centre of gravity of the fly-wheel and framework by an exceedingly small height, when the framework is held with the axis of the fly-wheel and the line of knife-edges both horizontal, and the knife-edges downwards in proper position for performing their function. The apparatus, when supported on its knife-edges with the fly-wheel not spinning, may be dealt with as the beam of an ordinary balance. Let now the framework bear two small knife-edges, or knife-edged holes, like those of the beam of an ordinary balance, giving bearing-points for weights in a line, cutting the line of the knife-edges as nearly as possible, and of course (unless there is reason to the contrary in the shape of the framework) approximately perpendicular to this line, and, for convenience of putting on and off weights, hang, as in an ordinary balance, two very light pans by hooks on these edges in the usual way. Now, with the fly-wheel not running, adjust by weights in the pans if necessary, so that the framework rests in equilibrium in a certain marked position with the axis of rotation inclined slightly to the horizontal, in order that the axis of the fly-wheel, whether spinning or at rest, may always slip down so as to press on one and not on the other of the two end plates belonging to its two ends. Now, unhook the pans and take away the gyrostat and spin it; replace it on its knife-edges, hang on the two pans, and find the weight required to balance it in the marked position with the fly-wheel now rotating rapidly. This weight, by an obvious formula which was placed before the Section at Southport, gives an accurate measure of the vertical component of the earth's rotation.<sup>2</sup>

*Gyrostatic Model of the Dipping Needle*

I also showed at Southport that the gyrostatic balance described above, if modified by fixing the knife-edges, with their line passing as accurately as possible through the centre of gravity of the fly-wheel and framework, and with the faces of the knives so placed that they shall perform their function properly when the axis of the fly-wheel is parallel to the earth's axis of rotation, and the rotation of the fly-wheel in the same direction as the earth's, will act just as does an ordinary magnetic dipping needle; but showing latitude instead of dip, and dipping the south end of the axis downwards instead of the end that is

<sup>1</sup> No report of this communication has, so far as I know, hitherto appeared in print.

<sup>2</sup> The formula is

$$fw = \frac{1}{2} W A^2 \omega \sin I;$$

where  $w$  denotes the balancing weight;  $fw$  the force of gravity upon it;  $A$  the arm on which this force acts;  $W$  the weight of the fly-wheel;  $A$  its radius of gyration;  $\omega$  its angular velocity;  $\gamma$  the earth's angular velocity; and  $I$  the latitude of the place.

towards the north as does the magnetic dipping needle. Thus, if the bearing of the knife-edges be placed east and west, the gyrostat will balance with its axis parallel to the earth's axis, and therefore dipping with its south end downwards in northern latitudes and its north end downwards in southern latitudes. If displaced from this position and left to itself, it will oscillate according to precisely the same law as that by which the magnetic needle oscillates. If the bearings be turned round in azimuth, the position of equilibrium will follow the same law as does that of a magnetic dipping needle similarly dealt with. Thus, if the line of knife-edges be north and south, the gyrostat will balance with the axis of the fly-wheel vertical, and if displaced from this position will oscillate still according to the same law; but with directive couple equal to the sine of the latitude into the directive couple experienced when the line of knife-edges is east and west. Thus this piece of apparatus gives us the means of definitely measuring the direction of the earth's rotation, and the angular velocity of the rotation. These experiments will, I believe, be very easily performed, although I have not myself hitherto found time to try them.

*Gyrostatic Model of a Magnetic Compass*

At Southport I showed that a gyrostat supported frictionlessly on a fixed vertical axis, with the axis of the fly-wheel horizontal or nearly so, will act just as does the magnetic compass, but with reference to "astronomical north" (that is to say, rotational north) instead of "magnetic north." I also showed a method of mounting a gyrostat so as to leave it free to turn round a truly vertical axis, impeded by so little of frictional influence as not to prevent the realisation of the idea. The method, however, promised to be somewhat troublesome, and I have since found that the object of producing a gyrostatic model of the magnetic compass may, with a very remarkable dynamical modification, be much more simply attained by merely suspending the gyrostat by a very long, fine wire, or even by floating it with sufficient stability on a properly planned floater. To investigate the theory of this arrangement let us first suppose a gyrostat, with the axis of its fly-wheel horizontal, to be hung by a very fine wire attached to its framework at a point, as far as can conveniently be arranged for, above the centre of gravity of fly-wheel and framework, and let the upper end of the wire be attached to a torsion head, capable of being turned round a fixed vertical axis as in a Coulomb's torsion balance. First, for simplicity, let us suppose the earth to be not rotating. The fly-wheel being set into rapid rotation, let the gyrostat be hung by the wire, and after being steadied as carefully as possible by hand, let it be left to itself. If it be observed to commence turning azimuthally in either direction, check this motion by the torsion head; that is to say, turn the torsion head gently in a direction opposite to the observed azimuthal motion until this motion ceases. Then do nothing to the torsion head, and observe if a reverse azimuthal motion supervenes. If it does, check this motion also by opposing it by torsion, but more gently than before. Go on until when the torsion head is left untouched the gyrostat remains at rest. The process gone through will have been undistinguishable from what would have had to be performed if, instead of the gyrostat with its rotating fly-wheel, a rigid body of the same weight, but with much greater moment of inertia about the vertical axis, had been in its place. The formula for the augmented moment of inertia is as follows. Denote by—

- W, the whole suspended weight of fly-wheel and framework;
- K, the radius of gyration round the vertical through the centre of gravity of the whole mass regarded for a moment as one rigid body;
- w, the mass of the fly-wheel;
- k, the radius of gyration of the fly-wheel;
- a, the distance of the point of attachment of the wire above the centre of gravity of fly-wheel and framework;
- g, the force of gravity on unit mass;
- ω, the angular velocity of the fly-wheel; the virtual moment of inertia round a vertical axis is

$$WK^2 \left( 1 + \frac{w^2 k^4 \omega^2}{W^2 K^2 a g} \right) \quad (1)$$

The proof is very easy. Here it is. Denote by—

- φ, the angle between a fixed vertical plane and the vertical plane containing the axle of the fly-wheel at any time t;
- θ, the angle (supposed to be infinitely small and in the plane of φ), at which the line a is inclined to the vertical at time t;

H, the moment of the torque round the vertical axis exerted by the bearing wire on the suspended fly-wheel and framework.

By the law of generation of moment of momentum round an axis perpendicular to the axis of rotation requisite to turn the axis of rotation with an angular velocity  $d\phi/dt$ , we have

$$wk^2\omega \frac{d\phi}{dt} = gWa\theta \quad \dots \dots \dots (2)$$

because  $gWa\theta$  is the moment of the couple in the vertical plane through the axis by which the angular motion  $d\phi/dt$  in the horizontal plane is produced. Again, by the same principle of generation of moment of momentum taken in connection with the elementary principle of acceleration of angular velocity, we have

$$wk^2\omega \frac{d\theta}{dt} + WK^2 \frac{d^2\phi}{dt^2} = H \quad \dots \dots \dots (3)$$

Eliminating θ between these equations we find

$$\left( \frac{w^2 k^4 \omega^2}{gWa} + WK^2 \right) \frac{d^2\phi}{dt^2} = H \quad \dots \dots (4)$$

which proves that the action of H in generating azimuthal motion is the same as it would be if a single rigid body of moment of inertia given by the formula (1), as said above, were substituted for the gyrostat. Now to realise the gyrostatic model compass: arrange a gyrostat according to the preceding description with a very fine steel bearing wire, not less than 5 or 10 metres long (the longer the better; the loftiest sufficiently sheltered inclosure conveniently available should be chosen for the experiment). Proceed precisely as above to bring the gyrostat to rest by aid of the torsion head, attached to a beam of the roof or other convenient support sharing the earth's actual rotation. Suppose for a moment the locality of the experiment to be either the North or South Pole, the operation to be performed to bring the gyrostat to rest will not be discoverably different from what it was, as we first imagined it when the earth was supposed to be not rotating. The only difference will be that, when the gyrostat hangs at rest, relatively to the earth, θ will have a very small constant value; so small that the inclination of a to the vertical will be quite imperceptible, unless a were made so exceedingly small that the arrangement should give the result, to discover which was the object of the gyrostatic model balance described above; that is to say, to discover the vertical component of the earth's rotation. In reality we have made a as large as we conveniently can; and its inclination to the vertical will therefore be very small, when the moment of the tension of the wire round a horizontal axis perpendicular to the axis of rotation of the fly-wheel is just sufficient to cause the axis of the fly-wheel to turn round with the earth. Let now the locality be anywhere except at the North or South Pole; and now, instead of bringing the gyrostat to rest at random in any position, bring it to rest by successive trials in a position in which, judging by the torsion head and the position of the gyrostat, we see that there is no torsion of the wire. In this position the axis of the gyrostat will be in the north and south line, and, the equilibrium being stable, the direction of rotation of the fly-wheel must be the same as that of the component rotation of the earth round the north and south horizontal line, unless (which is a case to be avoided in practice) the torsional rigidity of the wire is so great as to convert into stability the instability which, with zero torsional rigidity, the rotational influence would produce in respect to the equilibrium of the gyrostat with its axis reversed from the position of gyrostatic stability. It may be remarked, however, that even though the torsional rigidity were so great that there were two stable positions with no twist, the position of gyrostatic unstable equilibrium made stable by torsion would not be that arrived at: the position of stable gyrostatic equilibrium, rendered more stable by torsion, would be the position arrived at, by the natural process of turning the torsion head always in the direction of finding by trial a position of stable equilibrium with the wire untwisted by manipulation of the torsion head. Now by manipulating the torsion head bring the gyrostat into equilibrium with its axis inclined at any angle, φ, to that position in which the bearing wire is untwisted; it will be found that the torque required to balance it in any oblique position will be proportional to the sin φ. The chief difficulty in realising this description results from the great augmentation of virtual moment of inertia, represented by the formula (1) above. The paper at present communicated to the Section contains calculations on this subject, which

throw light on many of the practical difficulties hitherto felt in any method of carrying out gyrostatic investigation of the earth's rotation, and which have led the author to fall back upon the method described by him at Southport, of which the essential characteristic is to constrain the frame of the gyrostat in such a manner as to leave it just one degree of freedom to move. The paper concludes with the description of a simplified manner of realising this condition for a gyrostatic compass—that is to say, a gyrostat free to rotate about an axis either rigorously or very approximately vertical.

#### SECTION C—GEOLOGY

*On Ice-Age Theories*, by Rev. E. Hill, M.A., F.G.S., Tutor of St. John's College, Cambridge.—On the Montreal Mountain, in the neighbouring quarries, at the mouth of the Saguenay River, and more or less everywhere over all Canada and all the north and north-west of this continent, are seen phenomena which imply a former vastly extended action of ice. The like are found over Europe and Asia, thus completely encircling the Pole. Many theories have been propounded to account for these facts. It is proposed to pass these before you in review. Any explanation ought to account not only for cold greater than the present, but for accumulations of snow and ice. A kindred phenomenon is the greater size of the Antarctic ice-cap. The supposed interglacial warm periods, and the unquestioned luxuriance of Miocene vegetation in Greenland, ought also to find their causes in any thoroughly satisfactory theory. The theories which have been propounded fall into three groups, as Cosmical, Terrestrial, and Astronomical (or Periodical). The Cosmical theories are Poisson's Cold-Space theory—incomprehensible; and the Cold-Sun theory of S. V. Wood and others—lacking any evidence. The Terrestrial theories are numerous. Lyell's suggestion of Polar-continent and Equatorial-ocean is opposed by evidence that continents and oceans lay on much the same areas as now. The contrary view, Polar-ocean and Equatorial-land, would deserve consideration but for the same opposing evidence. The elevation view (Dana, Wallace), which alleges greater altitude of mountain-chains, disagrees with the strong evidence for land-depression during the period. The submergence view of Dr. Dawson agrees with this evidence, but requires elucidation. Alteration of ocean-currents (Gunn, J. S. Gaidner) is a most powerful agency, but would act locally rather than universally round the Pole. Alteration of prevalent winds, hitherto worked out by no one, deserves attentive consideration. Conditions are conceivable which would produce over an area winds from cold quarters almost permanently. However, this seems open to the same objection as the preceding theory. Last come the Astronomical or Periodical theories. A tilt of the earth's axis was suggested by Belt, but suggested as owing to causes which are wholly insufficient. Tilting from astronomical agencies is slight, though its action would be in the direction required. Herschel suggested the Eccentricity theory, but abandoned it. Adhémar's Precession theory, as explained by himself, involved an absolute fallacy. The celebrated view of Dr. Croll combines the Precession and Eccentricity theories into one. It exactly agrees with the Antarctic greater extension of ice, and provides an explanation of interglacial warm periods. The great difficulty in its way is to see how a mere difference in distribution through the year of an unchanged total heat receipt can produce consequences so vast. The laws of radiation explain but a very minute part, the laws of evaporation perhaps rather more; but, so far as can at present be seen, both together are inadequate. Another serious objection is that the theory seems to require the climate of the northern hemisphere to be now in a state of change for the better, of which at present there appears no evidence. Dr. Croll's elaborate explanations of the reaction of one effect upon another—logs, deflection of currents, and the like—have no special connection with his own theory. They would act in all cases, and support all theories equally. The arguments, if admitted, would only prove that the earth's climates are in a state of highly unstable equilibrium, in which a slight cause may produce an enormous change. Nor are his arguments universally admitted. In conclusion, Dr. Croll's theory seems inadequate: alteration of currents and winds are the most powerful causes suggested hitherto: further investigations ought to be made as to the nature and extent of the last series of changes in the outlines of the continents of the globe.

*What is a Mineral Vein or Lode?* by C. Le Neve Foster, B.A., D.Sc., F.G.S., H.M. Inspector of Mines.—The author

quoted briefly the definitions of a mineral vein given by Werner, Carne, Von Cotta, Grimm, Von Groddeck, Geikie, Sandberger, and Serlo, who, in common with most geologists, have looked upon mineral veins as "the contents of fissures." While admitting that a very large number of veins may be so described, the author contended that the exceptions are sufficiently important and numerous to warrant a change in the definition. He is of opinion that many of the principal and most productive tin-lodes in Cornwall are simply tabular masses of altered granite adjacent to fissures; and he brought forward the opinions of other geologists to show that certain veins in the English Lake district, the Tyrol, Nova Scotia, Nevada, Colorado, California, and Australia, are not filled-up fissures. In conclusion, he proposed the following definition: "A mineral vein or lode is a tabular mineral mass formed, more or less entirely, subsequently to the inclosing rocks."

*The Acadian Basin in American Geology*, by L. W. Bailey, Geological Survey of Canada.—The Acadian Basin, embracing the region bordering on and including the Gulf of St. Lawrence, together with the provinces of New Brunswick, Nova Scotia, Newfoundland, and Prince Edward Island, constitutes one of the natural physical divisions of the continent of North America, and exhibits many marked peculiarities of climate and floral and faunal distribution. In its geological structure, and in the history which this reveals, its individuality is not less clearly marked, being often in strong contrast with that of other portions of the continent farther west; and in some periods and features even exhibiting a closer relationship with the geology of Europe. In the present paper, the facts bearing upon this individuality are summarised and discussed; including the consideration of the varying land-surfaces of Acadia in different eras, the time and nature of its physical movements, its climate, and its life. A review of recent progress in the investigation of its geological structure is also given.

*Upon the Improbability of the Theory that former Glacial Periods in the Northern Hemisphere were due to Eccentricity of the Earth's Orbit, and to its Winter Perihelion in the North*, by W. F. Stanley, F.G.S., F.R.Met.S.—The theory of Dr. Croll, accepted by many geologists, is that former glacial periods in the northern hemisphere were due to greater eccentricity of the earth's orbit, and to this hemisphere being at the time of glaciation in winter perihelion. This theory is supported upon conditions that are stated to rule approximately at the present time in the southern hemisphere, which is assumed to be the colder. Recent researches by Ferrel and Dr. Hann, with the aid of temperature observations taken by the recent Transit of Venus expeditions, have shown that the mean temperature of the southern hemisphere is equal to, if not higher than the northern, the proportions being 15.4 southern and 15.3 northern. The conditions that rule in the south at the present time are a limited frozen area about the South Pole, not exceeding the sixtieth parallel of latitude; whereas in the north frozen ground in certain districts, as in Siberia and North-Western Canada, extends beyond the fiftieth parallel; therefore by comparison the north, as regards the latitude in which Great Britain is situated, is at present the most glaciated hemisphere. As it is very difficult to conceive that the earth had at any former period a lower initial temperature, or that the sun possessed less heating power, glaciation in the north could never have depended upon the conditions argued in Dr. Croll's theory. The author suggested that glaciation within latitudes between 40° to 60° was probably at all periods a local phenomenon depending upon the direction taken by aerial and oceanic currents; as, for instance, Greenland is at present glaciated, Norway has a mild climate in the same latitude, the one being situated in the predominating northern Atlantic currents, the other in the southern. Certain physical changes suggested in the distribution of land would reverse these conditions and render Greenland the warmer climate, Norway the colder.

*On the Occurrence of the Norwegian "Apatitlinger" in Canada, with a few Notes on the Microscopic Characters of some Laurentian Amphibolites*, by Frank D. Adams, M.Ap.Sc., Assistant Chemist and Lithologist to the Geological Survey of Canada.—The paper first gives a short account of the investigations which have been made on this amphibole-scapolite rock in Norway, where all the principal deposits of apatite either traverse it or occur in its immediate vicinity. The deposits of apatite in Canada generally occur associated with some variety of highly pyroxenic rock, often holding orthoclase and quartz. The "Apatitlinger" has, however, recently been found in the

vicinity of the town of Arnprior on the River Ottawa. It closely resembles the Norwegian rock, both in external appearance and in its microscopic characters, containing hornblende, scapolite, and pyroxene as essential constituents. A number of amphibolites in the Museum of the Geological Survey of Canada, which resemble this rock in appearance, have been sliced and examined with the microscope, and one of them found to contain scapolite in large amount. It was collected at Mazinaw Lake, in the township of Abinger, and is from the same belt of hornblende rocks as that in which Arnprior is situated. The paper closes with a short account of some of these amphibolites.

*The Geological Age of the Acadian Fauna*, by G. F. Matthew, A.M., F.R.S.C.—In this sketch an attempt is made, by comparison with the Cambrian fauna of other countries, and especially of Wales, to fix more exactly than has hitherto been done the position of the assemblage of organisms found near the base of the St. John group. The trilobites are taken as a criterion for this purpose. A brief statement of the position and thickness of the beds is given, showing the relation of the fauna to the formation as a whole. It is shown that the genera and species of the Acadian trilobites do not agree with those of the Menevian, in the restricted application of that term now in vogue; the great *Paradoxides* with short cyclobes, and the genera *Anoplopus*, *Agraulos* (= *Arionellus*), *Erinnys*, and *Holcephalum* being, so far as known, absent from it. On the other hand, it shows very close relationships in its genera to the Solva group fauna, especially in the following species:—

Solva Group	Acadian Fauna
<i>Conocoryphe solvensis</i> , Hicks	<i>Ctenocephalus matthewi</i> , Hartt sp.
<i>Conocoryphe hufi</i> , Hicks	<i>Conocoryphe elegans</i> , Hartt sp.
<i>Paradoxides harknessi</i> , Hicks	<i>Paradoxides clemencis</i> , Matthew

As bearing on the question of the age of the Acadian fauna, the development of the cyclobe in *Paradoxides* is referred to, and it is shown that while in the Cambrian rocks of Wales the length of the cyclobe is in direct relation to the age of the strata, the *Paradoxides* of the Acadian fauna, having continuous or nearly continuous cyclobes, are more primitive in their facies than those of the Menevian, and agree with the species found in the Solva group. The family of *Conocoryphida*, restricting the name to such species as those described by Corda under *Conocoryphe* and *Ctenocephalus*, are a marked feature of this early fauna; and *Conocoryphe* has a characteristic suture not observed in the Menevian genera. The Acadian *Ctenocephalus* also differs in this respect from the Bohemian species.

*On the More Ancient Land Floras of the Old and New Worlds*, by Principal Dawson, LL.D., F.R.S.—In the Laurentian period vegetable life is probably indicated, on both sides of the Atlantic, by the deposits of graphite found in certain horizons. There is good evidence of the existence of land at the time when these graphitic beds were deposited, but no direct evidence as yet of land plants. The carbon of these beds might have been wholly from subaquatic vegetation; but there is no certainty that it may not have been in part of terrestrial origin, and there are perhaps some chemical arguments in favour of this. The solution of the question depends on the possible discovery of unaltered Laurentian sediments. The Silurian land flora, so far as known, is meagre. The fact that *Eopteris* has been found to be merely a film of pyrite deprives us of the ferns. There remain some verticillately-leaved plants allied to *Annularia*, the humble Acrogens of the genus *Psilophyton*, and the somewhat enigmatical plants of the genera *Pachytheca*, *Prototaxites*, and *Berwynia*, with some uncertain Lycopods. We have thus at least forerunners of the families of the *Arterophyllitaceae*, the *Lycopodiaceae*, and the *Coniferae*. The comparison of the rich Devonian or Erian flora of the two sides of the Atlantic is very interesting. On both continents it presents three phases—those of the Lower, Middle, and Upper Erian—and there is a remarkable correspondence of these in countries so wide apart as Scotland, Belgium, Canada, Brazil, and Australia. Examples of this were given in the Rhizocarps, at this period very important, in the Lycopods, the Equisetaceae, the Ferns, and the Conifers. The number of coniferous trees belonging to *Dadoxylon* and allied genera, and the abundance of ferns, often arborescent, were especial features in the Middle and Later Erian. The flora of the Erian age culminated and then diminished. In like manner that of the succeeding Carboniferous period had a small commencement quite distinct in its species from the Erian; it culminated in the rich vegetation of the true coal formation, which was remarkably similar over the whole world, presenting,

however, some curious local differences and dividing lines which are beginning to become more manifest as discovery proceeds. In the Upper Carboniferous the flora diminishes in richness, and the Permian age is, so far as known, one of decadence rather than of new forms. Great progress has recently been made by Williamson and others in unravelling the affinities of the coal-formation plants, and we are on the eve of great discoveries in this field. Throughout the Silurian the conditions do not seem to have been eminently favourable to plants, but the few forms known indicate two types of Acrogens, and one leading to the Gymnosperms, and there is no reason to doubt the existence of insular land richly clothed at least with the few forms of vegetation known to have existed. In the Erian and Carboniferous there seem to have been two great waves of plant-life, proceeding over the continents from the north, and separated by an interval of comparative sterility. But no very material advance was made in them, so that the flora of the whole Palaeozoic period presents a great unity and even monotony of forms, and is very distinct from that of succeeding times. Still the leading families of the *Rhizocarpaceae*, *Equisetaceae*, *Lycopodiaceae*, *Filices*, and *Coniferae*, established in Palaeozoic times, still remain; and the changes which have occurred consist mainly in the degradation of the three first-named families, and in the introduction of new types of Gymnosperms and Phanogams. These changes, delayed and scarcely perceptible in the Permian and Early Mesozoic, seem to have been greatly accelerated in the Later Mesozoic.

*On the Structure of English and American Carboniferous Coals*, by Edward Wethered, F.G.S., F.C.S.—The author had examined several seams of coal from England and America. He pointed out that they were not always made up of one continuous bed of coal, but often comprised several distinct beds. In the case of the well-known Welsh "four-feet" seam there were four distinct strata of coals, separated by clay beds of a few inches thick. In the case of the "splint coal" from Whitehill Colliery, near Edinburgh, the seam presented three clearly-defined beds of coal, but these were not separated by partings of any kind. With a view of testing the "Spore theory" of the origin of coal, as propounded by Prof. Huxley, the author had obtained a portion of the "better-bed" seam intact for a thickness of 10 inches from the top. He had examined this inch by inch, by preparing thirty-three microscopic sections. At the top were 3½ inches of dull lustrous coal, termed "laminated coal." This the author found to be practically a mass of macrospores and microspores. Below this there was a change in the character of the seam. Spores became less numerous; in places they were scarce, the mass being made up of vegetable tissue and a substance to which the author gives the term "hydrocarbon." He did not, therefore, support Prof. Huxley in saying that the "better-bed" coal was "simply the sporangia and spore-cases of plants." The assertion would, however, apply to the first 3½ inches of the seam. The "splint coal" from Whitehill Colliery was a better example of a spore coal than the "better-bed." The bottom stratum was 4 inches thick, and presented a dull lustre, with thin bright layers traversing at intervals. The dull portion was a mass of spores and spore-cases, but these did not enter the bright layers. A vertical section cutting a bright layer, bounded on either side by dull lustrous coal, showed plenty of spores in the dull coal, but in the bright not one was detected. The second bed in this seam was 1 foot thick; it was of a brighter lustre than the 4 inches below, but two layers could be distinctly made out, one more lustrous than the other. In the duller of the two, spores were found, which, however, were less numerous than in the bed below, and were also of a different variety. In the bright layers the spores were absent. The top bed of the seam was also 1 foot thick, and might be defined as a mass of spores, chiefly microspores, except in the bright layers. The American coals examined were collected by the author from the Warrior Coalfields of Alabama, and from near Pittsburg, Pennsylvania. The same structural affinities were noticed as in the English coals, and the author therefore came to the conclusion that the English and American Carboniferous coals had a common origin. The spores in the coal from both countries were closely allied. Some microspores from Alabama were identical with those which occur in the lower bed of the Welsh "four-feet" seam. A feature in spores obtained from all the coals was the triradiate markings which they exhibited. Whether this was to be regarded as superficial or not, it was very characteristic of them, and was therefore to be considered in attempting to ally them with modern vegetation. The



author regarded peat in the light of post-Tertiary coal; lignite as peat in a transition state to coal; and coal as the remains of Carboniferous bogs. The author referred to the practical application of a knowledge of the microscopic structure of coal, as enabling an expert to judge of the nature of a coal from an examination of it with a pocket lens.

*Points of Dissimilarity and Resemblance between Acadian and Scottish Glacial Beds*, by Ralph Richardson, F.R.S.E., V.P. G.S. Edinb.—Mr. Richardson said that, in his "Acadian Geology," Principal Dawson gave the following as a typical section of the superficial geology of Acadia—that is, Nova Scotia, New Brunswick, and Prince Edward Island—and as, in some respects, also applicable to Canada and Maine, viz.: At the bottom, peaty deposits; then unstratified Boulder Clay; then stratified Leda Clay, indicating deep water; and, lastly, gravel and sand beds, the Saxicava sand indicating shallow water. Mr. Richardson pointed out wherein such a section differed from and resembled the glacial beds of Scotland. He said the latter showed no such orderly arrangement as the Acadian, and could not, as a rule, be divided into deep and shallow water-beds. The marine shells in the Scottish beds are all mixed up together, regardless, as a rule, of the province—whether Arctic or British, or both—to which they properly belong, regardless of the depths which they usually tenant, and regardless of the deposit (whether clay, gravel, or sand) in which they are now found fossil. They are likewise met with at all heights, from the level of the sea to more than 500 feet above it. No system of dispersion of boulder-erratics from definite centres in Scotland seems as yet ascertained. The peaty deposits, occurring in Principal Dawson's section below the Boulder Clay or till, occur in Scotland above it. With regard to points of resemblance, the facies of the shells in Acadia and Scotland is similar, being of the Arctic and British-Arctic type. Again, both in Acadia and Scotland, all the fossiliferous glacial beds occur above the unstratified Boulder Clay or till. Mr. Richardson cited various Scottish sections to prove this, and remarked that the belief in earlier and later Boulder Clays is of long standing in Scotland. He concluded by pointing out that, in their cardinal features, the Acadian and Scottish glacial beds seemed to coincide. In both Acadia and Scotland that great mass of unstratified clay known as till existed; and doubtless the geologists of the New World were, like those of the Old, puzzled to account for its origin with certainty and satisfaction. The question was left unsolved by the meeting of the British Association in Edinburgh in 1850; although then discussed by Hugh Miller and Prof. John Fleming. The author hoped that during the present meeting some advance would be made in solving this great problem, as well as in correlating and arranging the glacial beds of Canada, Acadia, and Britain.

*On the Mode of Occurrence of Precious Stones and Metals in India*, by V. Ball, M.A., F.R.S.—For full 3000 years India has been known as the source of precious stones and metals, but scarcely 200 years have elapsed since other countries yielding precious stones have entered into competition with her; and it is only within the present century that she has ceased to hold a pre-eminent position as a supplier of the markets of the world. In order to arrive at a full and satisfactory elucidation of this subject, two branches of inquiry must be undertaken—one based upon what has been actually ascertained by careful geological exploration of the country, and the other upon such historical records as are available of the former production of the minerals in question, and of the indications of the sites where they were mined. By means of our present knowledge of the geology, it has become possible to give definite form to many vague statements by early writers, and to recognise the actual positions of mines which are now, by the people of the localities themselves, forgotten and deserted. In the majority of these cases, had the geologist not got the historical hand to guide him, he would be unwilling to predicate the presence of such minerals from mere superficial examination. As a collateral result, many of the widespread myths and fables connected with mining have proved to have originated in peculiar local customs. They rest, therefore, on more substantial bases of facts than could have been suspected by any one unacquainted with these customs. This method of combining the results of geological research with historical records the author has found on previous occasions to have the advantage of bringing the geologist into touch with the rest of humanity, arranging as it does the interest of historians, linguists, and others, who find in the facts so presented to them pabulum applicable to the requirements of their own particular

pursuits. In this paper it will not be necessary or suitable to enter at length into details—the author having done so elsewhere.<sup>1</sup> His object is rather to direct attention to the subject generally, and to make known the fact that much has been accomplished of late years which has not as yet found its way into manuals and encyclopædias. Most of the information to be found in such works is far behind our present knowledge; and, where not actually incorrect, has been superseded by fuller and more accurate observations. The subjects taken for special consideration are the following:—Diamond, ruby, sapphire, spinel, beryl, emerald, lapis-lazuli, gold, silver. The steel of India, or *wootz*, might be included here, since, at least 2000 years ago, it was one of the most precious productions of India.

*On the Relative Ages of the American and the English Cretaceous and Eocene Series*, by J. Starkie Gardner, F.L.S., F.G.S.—The paper is a contribution towards the determination of the ages of the American Cretaceous-Eocene rocks, relative to those of Europe. It briefly describes the chief characteristics of the various stages of the series in America. The lowest beds there are distinguished by the presence of well-developed dicotyledonous leaves, associated with *Ammonites* and other Cretaceous Mollusca, considered to warrant their correlation with the Gault and Chalk of England. Newer beds thought to be intermediate in age between Secondary and Tertiary are distinguished by the incoming of palms and a new flora of Dicotyledons, associated with *Mosasauros*. The rest are correlated with the various divisions of the Tertiary series recognised in Europe. The entire series seems to have been deposited without any considerable break in continuity, but reveals a sudden transition from a temperate to a subtropical flora, and from a Cretaceous to a Tertiary Vertebrata. The high development of the flora is, however, quite irreconcilable with the accepted correlation. In further comparing the American series with that of Europe, it is observed that the subdivisions of the Cretaceous series were first determined for a limited area, when different ideas of evolution and gradual passage prevailed, and subsequently extended to embrace areas at a distance which may be, rightly or wrongly, correlated with those of England and Western France. The comparisons now drawn are only between the rocks of the original and typical area and of America, excluding the Cretaceous rocks of other countries. Thus restricted, the Neocomian of Europe comprises only shore deposits, characterised by a Cretaceous-Jurassic fauna and a Jurassic flora. The Gault is a deeper sea-deposit, comparable to the "Blue Mud" of the *Challenger*, with a typically Cretaceous fauna and a Jurassic flora. The Upper Greensands are more or less the equivalents of the Gault, deposited under differing physical conditions, corresponding to the "Greensands" of the *Challenger*, and have been assumed to represent the shore or shallower water conditions preceding the Chalk. The Chalk itself is described with a view to prove that it is a truly oceanic deposit, formed at a distance from shore and at a considerable depth, corresponding in all respects with the existing "Globigerina Ooze." The arguments against this view are refuted in detail, and the suggestion made that the alleged shallower habitats in the tropics of the few surviving Mollusca may be due to the lower temperature prevailing now in the abyssal depths of the ocean having driven heat-loving types from the depths at which they were able to live in the Chalk period. The whole Cretaceous series in the British area is the result of a gradual conversion of land into sea, owing to subsidence. The process commenced with the Neocomian, became more serious with the Gault, and continued until the close of the Chalk. The focus of the depression, so far as its results are accessible, was the English Channel, whence it spread in an easterly direction across Central Europe. As the land subsided, the gulf increased in magnitude, and Blue and Green Muds were formed on a wider and wider area, to be succeeded in due time by chalky Ooze. The nearer the focus of subsidence the older the Greensands and Gault, and the farther we recede from it the newer in age they become. The zones of increasing depth travelled outward and forward, and though now represented by continuous bands of the same lithological characters, extending over many countries, it would be rash in the extreme to infer the synchronism of portions of these when separated by degrees of latitude. The time required for these zones to travel from Kent to the Crimea, and to accumulate a mass, mainly composed of minute organisms, of over a thousand feet in thickness, must have been sufficient to account

<sup>1</sup> "Economic Geology of India," and "A Geologist's Contribution to the History of India," *Proc. Roy. Dub. Soc.* 1882.

for a very sensible progress in the evolution of organic forms. The deposition of the Chalk commenced in the English area at a period when the land floras were still of Jurassic character. By the time it had reached Limburg, Saxony, and Bohemia, Dicotyledons had become developed. The period required for the chalk ocean to encroach but 300 to 400 miles must thus have been very vast. The question may, however, arise whether plant development at this stage followed the otherwise universal law of evolution, or was exceptionally rapid. The fauna has to be examined to see whether it discloses an equally appreciable progress. The conclusion arrived at is that while the groups with which the author is less acquainted apparently do so, the progress in the Mollusca is unmistakable. The helicoid, turbinate, and patelloid groups are archaic and stationary, but the fusiform shells betray a tendency to elongate their canals, and the relative abundance of such, and gradual dropping out of now extinct genera, furnish an unmistakable index of the relative ages of the more littoral deposits. From this point of view we are able to demonstrate that the Greensands of Aix-la-Chapelle are far younger than their lithological structure and sequence would indicate, while the appearance of such distinctly new developments as cone and cowry shells further support the views of the relatively almost Tertiary, or, at least, transition, age of the Cretaceous series in Denmark. While, therefore, denudation on a truly colossal scale has produced one of the most considerable gaps in the whole geological record between Cretaceous and Tertiary over the British area, beds of intermediate age may successfully be sought for at a distance from this centre. The erroneous correlation of these, bed by bed almost, with the typical Cretaceous series, as developed in England, has led to a still more untrustworthy correlation of the American series with ours. The Cretaceous series of America contains at its very base a flora composed of angiosperms so perfectly differentiated that they are apparently referable to existing genera. One of the oldest floras in Europe containing angiosperms is that of Aix-la-Chapelle, and even this we have seen is relatively modern; but these are not referable in at all an equal degree to existing genera, and even the Coniferae are embarrassing on account of their highly transitional characters. The oldest Cretaceous flora of America, so far from possessing any Cretaceous characters, agrees in a remarkable manner with that of the English Lower Eocene, while the Laramie, or supposed Cretaceous-Eocene, flora has very much in common with that of our Middle Eocene, and marks a similarly sudden rise in temperature. The question is whether the evidence of the fauna in favour of the Cretaceous age of the series is so conclusive that the floral evidence must be set aside. Taking the Cretaceous series as represented in California, the older stages possess Mollusca of definitely Cretaceous aspect, but those of the newest have a decidedly Eocene facies. To be Cretaceous a fauna must have some elements which did not survive to a later period; but are we in a position to state that the Ammonitida, the Belemnites, and Inocerami did not do so? Even our present limited knowledge is entirely opposed to such a view. It must be remembered that the Eocenes in their typical area, England and France, were deposited under peculiar local conditions, and it would be as logical to infer from the absence in them of Cretaceous types that these existed nowhere else as it would be were the bed of the English Channel now upheaved to class as extinct all forms of life not met with in its sands and muds. If, as there is evidence to show, America was isolated at the time, the survival there of forms of Reptilia elsewhere extinct would be in accordance with ordinary observation at the present day. The flora of the American series is Eocene; the fauna of its earlier stages is Cretaceous. We are compelled therefore to choose whether we will believe that a large Eocene flora was developed there during the Cretaceous, or that some members of a Cretaceous fauna lived on to an Eocene date. The former supposition demands greater rapidity of evolution than we are accustomed to admit, and no external evidence is advanced to support it. The latter is more conceivable from the standpoint of evolution, and is not contradicted by any evidence that has yet come under the author's observation.

*On Some Remains of Fish from the Upper Silurian Rocks of Pennsylvania*, by Prof. E. W. Claypole, B.A., B.Sc. (London), F.G.S., of the Second Geological Survey of Pennsylvania.—The earliest vertebrate animals yet known from any part of the world are some remains of fish in the Upper Silurian rocks of England. They are for the most part of three types. First, short fin-spines, named by Agassiz *Onchus tenuistriatus*; second, frag-

ments of shagreen, or the skin of a placoid fish (*Thelodus* and *Sphagnotus*), belonging probably to the same that carried the spine; and third, ovate, finely striated plates or shields, supposed to be the defensive armour of some fish, unlike any now living. No one has doubted the ichthyic nature of the first and second of these three forms. But as regards the third there has been much controversy. Evidently allied to *Cephalaspis*, its right to the name of fish has been called in question, and suspicion has been raised in regard to the whole family of the Cephalaspids. On the whole, however, it seems best to retain them in the class of fishes, and to this conclusion Prof. Huxley evidently inclines in the conclusion of his "Essay on the Classification of the Devonian Fish." One may expect some, or even considerable, divergence of structure from the usual ichthyic types in such early forms. These English fossils occur in the lowest beds of the Devonian (Cornwall), and in the highest beds of the Silurian (Shropshire and Hereford). The well-known Upper Ludlow "bone bed" has yielded them in considerable quantity, and one specimen is reported by Sir C. Lyell in his "Elements of Geology" (1865) as discovered from the Lower Ludlow, beneath the Aymestry limestone. Below this horizon I have never heard of their occurrence. The English Ludlow, taken as a whole, has been usually correlated with the Lower Helderberg of North America, and on good grounds, both containing *Eurypterus* and *Pterygotus*. The English Lower Ludlow and the Water-Lime or basal beds of the North-American Lower Helderberg are the lowest strata containing these fossils. On both sides of the Atlantic they range from this level upwards into the Devonian. The oldest vertebrate fossils yet announced from America are those found in the Corniferous limestone or Lowest Devonian of Ohio. Possibly the beds at Gaspé, on the Gulf of St. Lawrence, are somewhat lower, as they have yielded *Cephalaspis*, which is not yet known from Ohio, and *Coccosodus*, of which Ohio has yielded only a single specimen. No authenticated fish-fossil has yet been announced from the Upper Silurian rocks of America. It is true that reports of the discovery of such remains have been published at various times, but investigation has proved them all erroneous. (See "Palæontology of New York," vol. ii. pp. 319, 320, pl. lxxi.; *American Journal of Science*, second series, vol. i. p. 62; "Palæontology of Ohio," vol. ii. p. 262.) During my recent work on the palæontology of Perry County, Pennsylvania, I came upon some fossils which at once suggested relationship to the Ludlow group above described. Among them were a few spines recalling *Onchus tenuistriatus*, but with some differences. I have named them *Onchus pennsylvanicus*. With them I discovered abundance of specimens bearing a strong resemblance to *Pteraspis*, but larger, and differing in some other respects. These I name *Glyptaspis* (*G. elliptica* and *G. bitruncata*). Comparing these with *Pteraspis* we find them much thinner, not exceeding one-tenth of an inch in thickness; whereas specimens of *Pteraspis* in my possession from Cornwall are nearly one-fourth of an inch thick. The striation on both is equally fine, but is rather less regular on the American specimens. These also show no trace of the spine in which the shield of *Pteraspis* terminates, as shown by Murchison in "Siluria." No traces of the English fossil shagreen—*Thelodus* and *Sphagnotus*—have been found in the Pennsylvanian beds, though it abounds in the Ludlow rocks. The fossils were found in a bed of sandstone about 200 feet below the base of the water-lime in Perry County, Pennsylvania, near the top of the great mass of variegated shale composing the Fifth Group of Rogers in the First Survey of Pennsylvania. This shale in New York immediately overlies the Niagara limestone, which is correlated on satisfactory evidence with the Wenlock limestone of England. Ten or twelve species are common to the two beds. It seems, therefore, that the great mass of coloured shale, near the top of which these fossils were found, and which is a continuation of the Onondaga group of New York, has no representative in the British series, but corresponds to an interval between the Upper Wenlock and the Lower Ludlow. (For details regarding the correlation of these beds in Pennsylvania with those in New York, see a paper by the author in *Proc. Amer. Phil. Soc.* for 1884.) It is consequently a necessary inference that the beds yielding *Glyptaspis* and *Onchus* in Pennsylvania are somewhat older than those containing *Pteraspis* and *Onchus* in England. Microscopic examination of the specimens, and a comparison of their structure with that of *Pteraspis* and *Cephalaspis* are in progress, and the details will be given in the paper. Other fossils in the author's possession indicate the possible existence of fish at a still earlier date, but the material is not yet worked out.

*On Fluxion-Structure in Till*, by Hugh Miller, A.R.S.M., F.G.S., Geological Survey of England and Wales.—It has long been recognised as one of the characteristics of the till that its long-shaped boulders are striated lengthwise. They have, as it has been concisely expressed, been "launched forward end-on." From the minute and magnifiable striæ upon the smaller (e.g. almond-sized) boulders it also appears that these at least have been carried forward, involved in the matrix, and were glaciated chiefly by its particles. Under the microscope these particles exhibit most of the varieties of form and glaciation that are found among larger boulders. The structure of the till in open situations shows that the axes of its stones have been turned by a common force in the direction of glaciation; it exhibits a rough structure comparable to the fluxion-structure of igneous rocks, the smaller boulders dividing around and apparently drifting past the larger, like the tide round an anchored skiff. These structures, which have been found by the author over many hundreds of square miles, chiefly in the north of England, indicate that at least a surface-layer of the till was dragged along, with a shearing movement of particle upon particle, producing intimate glaciation within its mass. Proofs are adduced that this moving layer was in general a surface-layer only, and that the till did not, as has often been supposed, move forward *en masse*, licking up its additions from beneath. This is the only intelligible explanation of the order (as well as the structure) of the boulder-clays of which the author has any practical knowledge. In up-lying situations, where the drift consists of raw material, fluxion-structures are seldom detected. In sheltered spots they are not generally developed. They are characteristic of well-kneaded till in open situations, liable, however, to obscuration by contortions within the mass. Of twelve experimental attempts made near the watershed of England in East Cumberland, 600-900 feet above the sea, to determine the ice-movement from this structure alone, eight were correct, three indeterminate, and only one misleading. The pressure and movement capable of producing this widespread fluxion-structure seem to have been that of some mass vast and far-spreading—closely investing, slow-moving, and heavily dragging—such as glacier ice. It needs only to be assumed that the confluent glaciers communicated something of their own movement and structure to the ground-moraine below.

*On the Southward Ending of a Great Synclinal in the Taconic Range*, by James D. Dana, L.L.D.—The Taconic Range, which gave the term "Taconic" to geology, lies in Western New England, between Middlebury, in Vermont, on the north, and Salisbury, in Connecticut, on the south. In former papers, published in the *American Journal of Science*, the author has shown, first, that the rocks constituting the range vary as we go from north to south, from roofing-slate and hydromica (or sericite) schist to true chloritic and garnetiferous mica schists; secondly, that these schists lie mostly in a synclinal or compound synclinal; thirdly, that the crystalline limestone along the eastern foot is one with that along the western, the limestone passing under the schist as a lower member of the synclinal; and fourthly, that since the limestone contains in Vermont (according to the discoveries of the Vermont Geological Survey, and also of Mr. A. Wing), and in the State of New York, fossils of the Lower Silurian, ranging from the inferior divisions to the higher, the Taconic schists are probably of the age of the Hudson River group or Llandeilo flags. The author's papers further show that while a large part of the Taconic Range has eastward dip on both the east and west sides, a southern portion about twelve miles long, consisting of Mount Washington in south-western Massachusetts and its continuation into Salisbury, Connecticut, is a broad tray-shaped synclinal, the dips of the two sides being toward one another, like the sides of an ordinary trough. The width of the broad synclinal between the limestone belt on either side is about five miles. As the result of investigation during the last two years, the synclinal character of this Mount Washington part of the Taconic Range is illustrated in the paper by new sections, and by facts connected with the dying out of the great synclinal (or compound synclinal) in the town of Salisbury. The mean height of Mount Washington above the sea-level is about 2000 feet, and above the wide limestone region on either side and to the south, about 1250 feet. The synclinal virtually ends along an east and west line through the village of Lakeville, in the town of Salisbury, where a beautiful lake lies within the limestone area. The surface of the mountain region descends 1000 feet in the southern, or last, three miles; and in the latitude of Lakeville, the width, as the map presented shows,

diminishes abruptly from five miles to a narrow neck of six-tenths of a mile. The area south is of limestone, and the neck of schists referred to is hardly 150 feet in height above it. The limestone may in some places be seen emerging from beneath the schist at a small angle; and at one locality a low over-shaped anticlinal of limestone has the schist covering all but a narrow portion at top; the quarrymen had to remove the schist to work at the limestone. Several narrow strips or belts of limestone, S. 15° W. in direction, corresponding with the direction of this part of the range, show out through the sides of the mountain where local anticlinals have had their tops worn off. Further, the dip of the schist over much of the southern slope is southerly and at a small angle, but with many local anticlinals and synclinals. In addition, there are small areas of schist in the limestone region, like straggling portions of the dwindled mountain, which appear in general to be remains of local flexures. There is the plainest evidence that the limestone formation of southern and south-eastern Salisbury comes out from beneath the dwindled, flattened-out, and worn-off mountain synclinal. And the reason why this limestone is exposed to view over plains miles in width, east and west of the Taconic Mountain, as well as to the south, is simply this, that the once overlying schist has been removed because in badly broken anticlinals and synclinals. The paper closes with an allusion to the orographic, stratigraphical, and lithological interest of the facts, and to their important bearing on the question of the origin and chronology of certain kinds of crystalline rocks, such as chloritic, garnetiferous, and staurolitic mica schists, as well as others less coarsely crystalline.

*The Primitive Conocoryphean*, by G. F. Matthew, A.M., F.R.S.C.—Relates to the development of the species *Ctenocephalus matthewi* and other Conocorypheans of the Acadian fauna, and is considered under the three heads, viz., the Development of the Glabella; the Acquisition of Sensory Organs; and the Decoration of the Test. Under the first head it is shown that the peculiar glabella of the species above referred to is closely related to the early history of the trilobite. The glabella, in its earliest stage, is very different from that of the adult, and in outline is not unlike that of *Paradoxides*; it also resembles this species in the position of the ocular fillet. At the next stage the glabella or axial lobe becomes trumpet-shaped, as in *Carasites*, and in the third the glabella proper is developed by the segmentation of the axial lobe: the glabella and ocular fillets now resemble those of *Ptychopara*. In the following stages the family characters of the Conocorypheans begin to assert themselves, especially the widening of the base of the glabella, the appearance of the canals connected with the ocular ridges, and the development of spines. (2) *The Acquisition of Organs of Sense*.—The ocular fillet appears, in the second stage of growth, as a faint, narrow ridge, close to the anterior marginal fold, and extending but a short distance from the glabella. It is not until the fifth stage of growth that the ramifying branches which spread from the ocular ridge to the anterior margin made their appearance. The ocular lobe and sensory apparatus connected with it are more distinctly visible on the under than on the outer surface of the test, and the canalets connected with the lobe spread over the anterior slopes of the shield, and extend to the anterior margin. In the tuberculated species they connect by hollow spines with the outer surface. In one species they cover a wider space than in the others, extending some distance behind the ocular ridges and over the front of the glabella. (3) *Decoration of the Test*.—In all the Acadian species of this group but one, the surface of the test at maturity is covered with tubercles and spines similar to the surface-markings of *Conocoryphe sulgeri*, &c. In the earliest stages, however, no such tubercles are found, but the surface appears smooth or scabrous. In *Ctenocephalus matthewi* the surface, in the first three stages of growth, appears smooth; in the fourth, tubercles begin to appear, and about the fifth stage all projecting parts of the test are studded with them. Those on the glabella and frontal lobe are arranged in transverse rows, those on the cheeks in interrupted rows conforming more or less to the periphery of these protuberances. Towards the adult stage these tubercles and spines become more irregular in position and number, conforming in this respect to the law of development in the Ammonites, expounded by Prof. Alphonso Hyatt.

*The Value of Detailed Geological Maps in relation to Water-Supply and other Practical Questions*, by W. Whitaker, B.A., F.G.S., Geological Survey of England.—Those maps of the Geological Survey of England in which various divisions of the

Drift have been coloured tell us, as a rule, a very different tale from the corresponding sheets in which the Drift is ignored, and it is only these Drift maps that really give us a true idea of the nature of the surface. Indeed in many districts a geological map that does not show the Drift is comparatively useless for most practical purposes, at all events in a populous country like England. Moreover, it is not merely enough to mass Drift as such, but its constituent members should be fairly distinguished, not merely with regard to their classification or relative age, but also as to their composition, whether of clay, loam, or gravel and sand. To illustrate this there are exhibited copies of the two versions of many of the Geological Survey maps of the London Basin, with and without Drift, from which the following important points will be at once seen:—(1) Large tracts, shown as Chalk on one version, really consist, at the surface, of the generally impervious Boulder Clay, whilst over others the Chalk is covered by Brick-earth and Clay-with flints: all these beds being such as give an aspect to the country very different to what we find where the Chalk is bare. (2) Parts of the wide-spreading area of the London Clay (of the Driftless maps) are really quite altered and deprived of their clayey character, by the sheets, long strips, and more isolated patches of gravel and sand that occur so often, whether along the river-valleys or over the higher plains. (3) The sandy, permeable Crags are in great part hidden by Drift, which, though often consisting of sand and gravel, is sometimes of Boulder Clay. Indeed, so widespread is the Glacial Drift in the greater part of Norfolk and Suffolk, that only a Drift edition of the Geological Survey maps of the eastern parts of those counties has been issued; a map without Drift would necessarily be a work of fiction. To illustrate the important bearing which these Drift maps have on a great question, that of water-supply from the Chalk, the author also exhibits some special maps, which he has made to show the areas over which rain-water has access to the Chalk, as distinguished from those over which the surface-water cannot sink down into the Chalk, or can only do so very partially. These maps will be more particularly noticed in Section G.

*Pennsylvania before and after the Elevation of the Appalachian Mountains*, by Prof. E. W. Clappole, B.A., B.Sc., F.G.S. Lond.—The paper, of which the following notes are an abstract, is intended as an attempt to handle, in a necessarily imperfect manner, and only to first approximations, a difficult but important and interesting geological subject. The method of treatment is, in the writer's opinion, one that has not hitherto been employed for the same purpose. The object in view is to form some estimate, as near to the truth as possible, of the amount of compression or shortening produced at the surface by the corrugation of the upper layers of the coast into mountain chains, with especial reference to the American Atlantic seaboard. In order to confine the paper within due limits, certain propositions must be taken as proved. The principal of these are:—(1) That central contraction has developed tangential pressure in the crust; (2) that the tangential pressure has produced crumpling of the crust; (3) that to this crumpling are due long ranges of mountains; (4) that the Appalachian Mountains came into being in this manner in the later portion of the Paleozoic era. These admitted, the conclusion necessarily follows that during the formation of the Appalachian Mountains a considerable contraction of the crumpled area ensued, in a direction at right angles to that of the chain. The following points constitute the main features of the paper:—(1) Short account of the great ranges of Pennsylvania, in plan and section, with diagrams; (2) situation and account of the line of section adopted; (3) limitation of the field to a consideration of eleven great ranges—Blue Mountains, Bower Mountains, Conococheague Mountains, Tuscarora Mountains, W. Shade Mountains, Black Log Mountains, Blue Ridge Mountains, Jack's Mountain, Standing Stone Mountains, Tussey Mountains, Bald Eagle Mountains; (4) Discussion of the different parts of this section—(a) the Mountain Region, (b) the Cumberland Valley; (5) attempt to estimate or measure the curved line of the crumpled Upper Silurian (Medina) sandstone; (6) inference that the sixty-five miles of the line of section represents about 100 miles of surface previously to the crumpling of the crust and elevation of the mountains; (7) this result, for several reasons, below rather than above the truth; (8) geographical effects of this contraction; (9) development of the fact that such elevation of mountains by tangential pressure involves not only elevation, but considerable horizontal movement; (10) diminution of motion to north-west; (11) a few words on the failure of attempts yet made to account for this contraction; (12) suggestions and conclusions.

## UNIVERSITY AND EDUCATIONAL INTELLIGENCE

AT King's College Prof. W. Grylls Adams, F.R.S., will deliver a course of lectures on Electricity and Magnetism and their applications to Electric Lighting, Transmission of Power, &c., during the academical year 1884-5. A course of practical work in electrical testing and measurement, with especial reference to electrical engineering will also be carried on under his direction in the Wheatstone Laboratory. The lectures will be given once a week—on Mondays at 2 p.m.—and the Laboratory will be open on Wednesdays and Fridays from 1 to 4.

## SOCIETIES AND ACADEMIES

### PARIS

**Academy of Sciences, September 15.**—M. Rolland, President, in the chair.—Address delivered at the inauguration of the Fresnel Monument at Broglie, by M. Jamin.—Remarks on algebraic equations, in connection with a communication from M. de Jonquières on the application of geometry to algebra, by M. Léon Lalanne.—Note on the two methods, proposed by Hamilton and Sylvester, for resolving the linear equation in quaternions, by Prof. Sylvester.—On the composition and properties of the light emitted by insects of the *Pyrophore* genus, by MM. Aubert and Raph. Dubois. Examined under the spectroscope, the spectrum of this light appeared very beautiful, continuous, and destitute alike of very bright and dark bands. It occupied about seventy-five divisions of the micrometer, extending on the red side to the centre of the interval separating the A and B rays of the solar spectrum, and on the side of the blue a little beyond the F ray. When its intensity diminishes, the red and orange disappear altogether, the spectrum being then reduced to the green with a little yellow and red, the green persisting longest. The reverse takes place when the insect begins to glow. Thus the least refrangible rays are the last to be emitted, a result hitherto observed in the spectrum of no other luminous body, except to a limited extent in that of the sulphide of strontium. Examined to ascertain its photo-chemical properties, this light showed a feeble display of the phosphorescence of the sulphide of calcium.—Remarks on a singular case of deformation in the images observed through telescopes, by M. Govi.

### BERLIN

**Physiological Society, August 1.**—Dr. A. Auerbach had made experiments to ascertain which of the constituents of flesh exercised the acid, alkali-abstracting effect on the blood witnessed in the reaction of the urine of flesh-eating animals compared with that of the urine of plant-eating animals. He found that the acid phosphoric potash increased the ammoniacal contents of the urine in a manner similar to that of the administration of acids. A dog fed on flesh having been brought into nitrogenous equilibrium, and kept in this state for some days, had a portion of acid phosphoric potash given to it in addition to the meat. The nitrogenous excretion remained the same as before, but the quantity of secreted ammonia had considerably increased, and this increase continued for some days after the dog was put back to the former flesh diet without the salt. The quantity of secreted ammonia corresponded, to the utmost nicety, with the quantity necessary for the conversion of the salts which had been taken,  $PO_4KHH$ , into  $PO_4KNO_3H$ .—Prof. Kronecker gave a report of a series of experiments conducted during the session now ended in the department of the Physiological Institute under his care. He first recounted the experiments of Mrs. Dr. Boll, who investigated whether asphyxiated fishes could recover animation without a supply of oxygen, and simply by withdrawing the carbonic acid from them. Goldfishes were left in boiled water free of air till the symptoms of asphyxia became distinctly manifest, and then a somewhat diluted caustic lye was added to the water without the admission of air. In every such case the fishes soon recovered their lively movements, and swam about freely in the water. It might therefore be concluded that, with the discharge of the surplus of carbonic acid, the symptoms of asphyxia would also disappear.—Prof. Kronecker then reported on the experiments of Dr. Kranzfeld, which had for their subject the movements of the stomach. In the stomach of each of the animals examined, the cardiac part, the pyloric part, and the middle had to be discriminated. Of these three parts the last was in most cases immovable, while the two other parts displayed lively movements. In the act of

swallowing, as observation proved, the stomach took no share. The cardiac and the pyloric parts were excitable in different manners. The pylorus reacted strongly even on slow electric stimulations of moderate intensity such as failed to induce any contraction in the cardiac part. Contraction of the cardiac part followed however more frequent stimulations. The act of vomiting, at least in all the animals examined, was constantly brought about by a swallowing movement. In the discharge of the contents of the stomach, on the other hand, the œsophagus took no part whatever. The motors at work were the abdominal pressure and the movements of the gastric walls, and during the time the vomiting lasted the cardiac orifice was open. The whole mechanism of the act of vomiting was still, however, the subject of investigation.—Dr. Jastrehoff has made a particular investigation of the question, important in practice, regarding the effect on the blood-pressure of interference with different parts in the case of operations in the peritoneal cavity. He found that the blood-pressure was raised by all encroachments of this kind, especially that of impinging on the intestine, and, most strongly of all, by a refrigeration of the intestine. In the case of a quick excision of a warm tumour from the peritoneal cavity the blood-pressure rose to quite a rapid rate, and the influence of ether was only able somewhat to abate it.—In continuation of former experiments on the movements of the vagina, Prof. Kronecker has further established that they are not peristaltic movements like those of the intestine, but that the vagina contracts, exactly in the same manner as does the œsophagus, in sections which in definite numbers (mostly three) and in definite series compress themselves from the top downwards. A solution of continuity in the wall of the organ in no respect affected the course of the contraction.—Dr. Ratimoff has studied the effect of chloroform on the heart and the respiration. In order to charge the air with the vapour of chloroform a special apparatus was constructed which allowed an exact registration of the chloroform. Air completely saturated with chloroform contained in every case, whether the process of interfusion took place slowly or rapidly, 30 cubic centimetres of chloroform to 100 litres of air, and invariably caused the death of the rabbits subjected to it, and that through paralysis of the heart. Such a mixture as produced a complete narcosis of the animal, without affecting the heart or the respiration, contained 5·6 or 7 cubic centimetres of chloroform to 100 litres of air, a mixture which was able to maintain the narcosis for hours at a time. In these experiments, however, it appeared that the animals very soon got accustomed to the chloroform, and if, for example, the narcosis was effected at the beginning by a proportion of 5 cubic centimetres of chloroform, the dose had subsequently to be increased to 6 and 6½ cubic centimetres in order to keep up the narcosis.—Dr. Schapiro has investigated the effect of atropine on the frog's heart, and has found it analogous to the effect of heat. The heart became through its application much more accessible to external treatment than in a normal state, and in general its effect may be formulated in the statement that by means of atropine the fissures in the frog's heart become widened.—Mr. Aronsohn had formerly found that 0·73 per cent. solution of ordinary salt was of altogether indifferent and unstimulating effect on the nasal mucous membrane, and offered the best vehicle for the introduction of smelling substances. He now communicated that he had examined other salts, in particular carbonate of soda, sulphate of soda, sulphate of magnesia, &c., with a view to determining in what concentration they affected the nasal mucous membrane with equal indifference as did 0·73 common salt solution. He found that for this purpose much more considerable quantities of these salts were required. In the case of sulphate of soda, for example, four times the quantity that sufficed in the case of common salt was needed to produce the same absence of effect. In such stronger concentrations these solutions might take the place, either in whole or in part, of the kitchen salt solution.—Dr. Heimann reported on a new method for the production of localised pressure on the cerebrum. He placed an animal at the periphery of a round chest made to revolve round its centre, caused it to rotate 300 times a minute, and observed paralytic symptoms which passed away in a short time after the end of the rotation. By experiments he convinced himself that the change in the distribution of the blood in the two halves of the brain produced by the centrifugal force was without influence in this phenomenon, and therefore concluded that it was exclusively the one-sided pressure of the brain against the skull which caused the paralysis. To still further localise this pressure he trepanned the skull at a spot where it was known that the part of the membrane of the cerebrum there

situated was the centre for the movements of an extremity, fixed into the opening a cork stopper, which of itself exercised no pressure, and placed the animal in such a posture in the rotating apparatus that the operated side was situated outwardly. In the rotation the spot in question was now pressed against the cork, and so paralysis showed itself in the extremity appertaining to that spot. On the cessation of the revolution the movement of the paralysed part was soon restored. These experiments could be repeated at pleasure without doing any harm to the animal.

## VIENNA

Imperial Academy of Sciences, July 17.—K. Laker, on the first microscopic phenomena of coagulation of mammalian blood.—A. Weiss, on a peculiar occurrence of calcium oxalates in the epidermis of the organs of some Acanthaceæ.—On spontaneous movements of vegetable dyeing bodies, by the same.—Preliminary note on a peculiar solved yellow dye in the flowers of some Papaveraceæ, by the same.—L. Boltzmann, on the properties of monocyclic systems and of other systems allied with them.—H. List, on the epithelium of the cloaca of *Scyllium canicula*.—K. Zulkowsky and K. Lepéz, aid to the determination of the halogens of organic bodies.—R. Benedikt and P. Julius, on a new resorcin-blue.—A. Nalepa, on the anatomy of Tyroglyphæ.—O. W. Fischer, contribution to a knowledge of diquinolyles.—On two organic stannum compounds, by the same.—T. Habermann, on some basic salts.—F. Berger, on the action of acetamide in phenylcyanide.—S. Schubert, on the behaviour of the starch-granule if heated.—G. Spitz, on some mixed ethers of resorcin.—K. Natterer, contribution to a knowledge of dichloro-ether.—K. Auer von Welsbach, on rare earths.—Z. H. Skraup and O. W. Fischer, on methyl-phenantroline.—Z. H. Skraup, on a new mode of formation of phenantroline.—L. Szajnocha, contribution to a knowledge of the middle Cretaceous Cephalopod fauna of Elobi Island on the western coast of Africa.—K. Auer von Welsbach, contributions to spectral analysis.—E. von Fleischl, on double refraction of circumpolarising fluids.—E. Steinach, studies on the renal circulation of the blood.

## CONTENTS

	PAGE
Modern Steam Practice and Engineering . . . . .	509
Our Book Shelf:—	
Ander-on's "Catalogue and Handbook of the Archaeological Collections in the Indian Museum" . . . . .	511
Letters to the Editor:—	
Barnard's Comet.—A. A. Common . . . . .	511
The Krakatoa Eruption.—Prof. C. Piazzzi-Smyth . . . . .	511
The Sky-Glows.—T. W. Backhouse; P. K.; Robt. Leslie . . . . .	511
The Diffusion of Species.—Dr. G. C. Wallich; R. Scot Skirving . . . . .	512
Shifting of the Earth's Axis.—W. M. Flinders Petrie . . . . .	512
Salmon-Breeding.—Arthur Nicols . . . . .	512
A Sea Monster.—Alfred Morris . . . . .	513
Hail.—A. D. . . . .	513
The "Comma-shaped Bacillus," Alleged to be the Cause of Cholera. By Surgeon-Major Timothy Richards Lewis, M.B. . . . .	513
Forests in Coburg, Germany, and Russia . . . . .	515
Stone Hatchets in China. By Rev. Dr. Joseph Edkins . . . . .	515
Notes . . . . .	517
Our Astronomical Column:—	
The Figure of Uranus . . . . .	519
The Lunar Eclipse on October 4 . . . . .	519
Olbers' Comet of 1815 . . . . .	519
The Comet of 1729 . . . . .	519
Constitution and Origin of the Group B of the Solar Spectrum. By M. L. Thollon. ( <i>Illustrated</i> ) . . . . .	520
The Migrations of "Salmo salar" (L.) in the Baltic. By Prof. And. Joh. Malmgren . . . . .	521
The British Association:—	
Reports . . . . .	522
Section A—Mathematical and Physical Science . . . . .	523
Section C—Geology . . . . .	526
University and Educational Intelligence . . . . .	531
Societies and Academies . . . . .	531

THURSDAY, OCTOBER 2, 1884

## THE "CHALLENGER" REPORTS

ort of the Scientific Results of the Voyage of H.M.S. Challenger" during the Years 1873-76 under the command of Capt. George S. Nares, R.N., F.R.S., and apt. Frank Tourle Thomson, R.N. Prepared under the Superintendence of the late Sir C. Wyville Thomson, F.R.S., &c., and now of John Murray, F.R.S.E., of the Naturalists of the Expedition. Zoology—Vol. IX. Text and Plates. Two Vols. (Published by order of Her Majesty's Government, 1884.)

ANOTHER volume forming Part XXII. of the Zoological Series of Reports on the Scientific Results of the Challenger Expedition has just been published, containing an account of the Foraminifera by H. B. Brady, F.R.S. It will be universally acknowledged that the task of preparing this Report could not have been intrusted to a less able hand. The representatives of this interesting group of animals, writes Mr. Murray in an editorial note, are universally distributed over the floor of the ocean and in surface and sub-surface waters, and the presence or absence of certain surface forms in the deposits from different depths and localities is intimately connected with some of the most remarkable and intricate problems of physical Oceanography. It was therefore of the first importance that one very familiar with the group of the Foraminifera should have been chosen to undertake so much an amount of labour as was requisite to investigate the enormous quantity of material that was collected. The Report itself is the best evidence of the great success which has attended Mr. Brady's investigations; it consists of a volume of text of over 800 pages, and is accompanied by a volume of 115 very exquisitely executed plates.

While the chief part of the Report is taken up with the descriptions of the new or rare species of Foraminifera discovered by the various bottom-dredgings and tow-net haulings obtained during the Challenger Expedition, the author has also included some account of the collections made in the regions of the North Atlantic, which, though not visited by the Challenger, were explored during the expedition of the Porcupine in 1869, and he has made the survey of the group more complete by also referring to the forms found during the cruise of the Zetis Errant in 1880, and during the British and Austro-Hungarian North Polar Expeditions.

The Report, however, contains a great deal more than mere descriptions of new or rare species. From Mr. Brady's personal acquaintance with the multifarious forms to be met with in the group and with its literature, he has been enabled to treat in a full and able manner the subject of the classification of these forms, and has thereby developed this Report into an elaborate monograph of recent Foraminifera.

In an admirably written introduction a sketch is given of the gradual development of our knowledge of these forms from the time of D'Orbigny (1826) to the present, and an elaborately compiled bibliography is appended, containing various classifications of the Rhizopods, from that of

Dujardin in 1841 to that of Leidy in 1879, are glanced at. More details are given as to the various attempts at classifying the Foraminifera, and the author proposes a scheme differing in many respects, and often widely, from those given by previous writers, but one which, in its essential elements, is in no way incompatible with the different conclusions at which they had arrived. The nature of the investment of the animal—that is to say, the minute structure of its test—as an exclusive basis for the primary divisions of the order, has been abandoned. While under all circumstances it furnishes important characters, and is even in some families quite distinctive, it is nevertheless a fact that, whilst there are certain groups which are invariably arenaceous, and some which are always calcareous and perforate, there are yet others in which no uniform rule obtains. The author omits any division of the order into sub-orders, not finding any easily-recognised characters to serve as a basis for such subdivision, and he divides the order at once into families. These families are (1) Gromiadae, (2) Miliolidae, (3) Astrorhizidae, (4) Lituolidae, (5) Textulariidae, (6) Cheilostomidae, (7) Lagénidae, (8) Globigerinidae, (9) Rotalidae, (10) Nummulinidae. The Gromiadae, a family composed chiefly of fresh-water organisms, "have been a source of considerable trouble, on account of the want of accuracy and detail in the published descriptions of a number of types more or less closely allied to the group, and only such genera have been included as are known to have long, reticulated pseudopodia." In this portion of the subject the author has had the advantage of the advice of his friend William Archer. "The sub-family Dactyloporinae, which in the original draft was placed with some reservation amongst the Miliolidae, pending the fuller publication of the results of Munier-Chalmas's researches, is now entirely omitted. The examination of specimens brought under my notice by E. Perceval Wright and C. Schlumberger has removed any doubt left on my mind as to the propriety of the transfer of the entire group to the calcareous Algae." The singular genus Bathysiphon of Sars has been removed to the Astrorhizidae.

With reference to the subject of nomenclature, the following are Mr. Brady's views, which seem founded on common sense, and with which we entirely agree. It is surely not requisite in a group like this "that a uniform standard of fixity of characters should be adopted, or that a set of beings of low organisation and extreme variability should be subjected to precisely the same treatment as the higher divisions of the animal kingdom. The advantages of a binomial system of nomenclature have not diminished since the days of Linnæus, though the views of the naturalist as to what constitutes a 'genus' or a 'species' have changed, and will probably continue to change, but, be that as it may, the Linnæan method is too simple and convenient to be abandoned without some better reason than the different value of these terms as employed in different zoological groups." "The practical point upon which all are agreed is that it is impossible to deal satisfactorily with the multiform varieties of Foraminifera without a much freer use of distinctive names than is needful or indeed permissible amongst animals endowed with more stable characters." All who have had any experience of the life-history of these Rhizopods, who know their immense plasticity, and yet

who remember their, within certain limits of deviation, fixedness of type, will cordially agree with this.

The subject of dimorphism is alluded to, and the two quite distinct phenomena among Foraminifera described by this term are explained, but the author does not seem to select one of these above the other for the exclusive right to the term, as would seem desirable.

One of the most interesting subjects in reference to deep-sea deposits is their direct connection with the pelagic species of Foraminifera. As a rule these forms are not of pelagic habit; on the contrary, probably 98 or 99 per cent. of the known species or varieties live in the sand or mud of the sea-bottom, and possess no powers of floating or swimming; but, on the other hand, some few forms, belonging to eight or nine genera, do most certainly pass their existence either in part or in whole at the surface of the ocean, or floating at some depth below that surface. These forms are found, too, in immense profusion, and a relatively very large mass of the oceanic deposits consist of their calcareous shells. A list of the at present ascertained pelagic forms is given. The most prominent genera are Globigerina, Pulvinulina, Hastigerina, Pullenia. The question seems still unsettled as to whether the species are exclusively pelagic, passing the whole of their time living at or near the surface, or whether they can or do pass a certain portion of it on the sea-bottom. Mr. Brady adduces a series of facts which tend to the inference that the Foraminifera which are found living in the open ocean have also the power of supporting life on the surface of the bottom-ooze, and further, so far as our present knowledge goes, there is at least one variety of the genus Globigerina which lives only at the sea-bottom; but the author is most cautious not to express any dogmatic opinion on the subject.

In dealing with the composition of the test, the presence of a considerable percentage (6 to 10) of silica has been established as existing in the arenaceous forms. The substance secreted for the incorporation of the foreign bodies which cover the test has been proved to be composed of ferric oxide and carbonate of lime in variable proportions, the former being often in considerable excess. It is not without interest to note the presence in some of the porcellanous forms of a thin siliceous investment. A few Miliolæ from soundings of a depth of about four and a half miles, with somewhat inflated segments, scarcely distinguishable in form from young thin-shelled specimens of a common littoral species, were found to be unaffected by treatment with acids, and upon further examination it became apparent that the normal calcareous shell had given place to a delicate homogeneous siliceous investment. While immersed in fluid, the shell-wall had the appearance of a nearly transparent film, and this when dried was at first somewhat iridescent.

A list is given of those stations from which soundings or dredgings were obtained in sufficient quantity to furnish good representative series of Rhizopods, and maps are appended showing the tracks of the *Challenger*, with these stations marked, as also of the areas explored by the *Porcupine* and the other northern expeditions.

Any generalised summary of the details of the new forms would be impossible. Of the several hundred species described and figured, over eighty are here noted

for the first time, and this without counting numerous well-marked and named varieties, or the numerous new forms already diagnosed in Mr. Brady's preliminary Reports.

The family Astorhizidæ is the one which has received the largest number of additions; indeed our acquaintance with the larger arenaceous Rhizopods is almost entirely derived from the various recent deep-sea explorations. A knowledge of the life-history of these forms is still needed to place the classification of the group on a secure basis, and as some few of the forms are inhabitants of comparatively shallow water, their investigation would seem to be well worthy of the attention of observers at some of our zoological marine stations. Many other problems to be solved are also pointed out in this Report, the extreme value of which will be recognised by all students of biology.

#### THE ENGLISH FLOWER GARDEN

*The English Flower Garden: Style, Position, and Arrangement. Followed by a Description, Alphabetically Arranged, of all the Plants best suited for its Embellishment; their Culture, and Positions suited for each.*

By W. Robinson, with the co-operation of many of the best Flower Gardeners of the day. Illustrated with many Engravings. (London: John Murray, 1883.)

A LOVE of flowers seems more or less characteristic of most human beings, and the tending and caring them is to most people a pleasant labour. Their brightness of colour, their charm of form, the sweetness and refreshingness of their varied perfumes please and delight the senses, while the mystery of their lives and deaths captivates the mind and awakes up the pleasures of hope. In no European country has this love of flowers been more manifested than in England, so that a flower garden seems an indispensable adjunct of an English home. It too often happens that many of those who love flowers have not the knowledge requisite to take care of them, and then the flower garden is handed over to the care of others. What to grow and what not to grow becomes then not so much a question of deliberate enlightened forethought as a thing of fashion, commonplace and unstable. No honest lover of Nature, no one who has once known the beauties of plant life, could ever for a moment remain pleased or satisfied with the arrangement of things out of place which is so peculiarly characteristic of one style of modern English gardening. It was not always thus: anywhere in Continental Europe that one visits "Le Jardin anglais" of some fine demesne or of some public park, there one is sure to find some attempt to form a natural prospect by the judicious arrangement of tree, shrub, flower, and grass; but in England itself, the very home of Sylvia, all traces of Nature are too often obliterated, and a meretricious display of colour, inclosed within a sharply defined geometrical sameness of outline, takes the place of a refreshing contrast in contour accompanied with joyful surprises of brightness. What a difference there is in the pleasure of viewing a large mass of *Gentiana acaulis* in the centre of a wide expanse of scarlet geranium encircled with yellow calceolarias and viewing some few tufts of the same plant opening their blue corollas amid the grass by the borders of some Alpine meadow. Those who love gardens and like to see in them some few touches

Nature owe a debt of gratitude to Mr. W. Robinson for his life-long labours in disturbing our minds as to the correctness of modern views on gardening, and for in a great measure destroying the miserable conventionality it had made our gardens bad imitations of very artistic carpets, or of nightmare-giving wall-papers. But destroying what was bad it was also most desirable to build up something good to replace what was gone, and the present most welcome volume we find indications, clear and distinct, of the abounding wealth of flowers at our disposal which are fitted for the embellishment of our open-air gardens. In the compilation of this work on the "English Flower Garden," Mr. Robinson has had the co-operation of some of the most practical and thoughtful writers of the day, and also the valuable aid of Mr. W. Aldring, whose experience as superintendent for some time of the Hardy Plant Department of the Royal Gardens at Kew has well qualified him for the task. The best part of the work—On Gardens, their Arrangement, &c.—is for the greater part from the pen of the author. We should have liked that a small portion of this part had been devoted to the subject of town and suburban gardens of small size. Many a modest cottage garden has, we read, lessons to give, but then our ideas of a modest cottage garden are not helped by an illustration of the charming pounds attached to Sheen Lodge. The second part contains in alphabetical order a list of the more important genera and species of plants which will grow in the open in Great Britain or Ireland, with figures, some very good, some indifferent, of most of the more attractive species. In some few cases we notice figures given which are not referred to in the text; when these are not of "desirable" species for the flower garden, as in the case of *Gentiana lutea* and *Scilla maritima*, it would have been better to have put others in their place. To all our readers who have or contemplate having a garden we cordially recommend this very excellent book.

#### OUR BOOK SHELF

*The King Country; or Explorations in New Zealand.* By J. Kerry-Nicholls. (London: Sampson Low and Co., 1884.)

His interesting volume Mr. Nicholls describes a good deal of exploring work. The King Country, with which volume is largely concerned, is that district of the North Island of New Zealand which is still under the name—not entirely nominal—of the King Tawhiao, who only recently left our shores. It occupies a very large space between the west coast and the Lake Taupo region, lying on its north-eastern border that wonderland with which the late Baron Hochstetter has made us familiar. Additional details of the sub-volcanic action of this region, its boiling springs and glistening terraces, are given. From Rotomahana Mr. Nicholls travelled northwards in a zigzag to Lake Taupo, and geologists will be specially interested in the observations relating to the great volcanic plateau on the south of the Lake Taupo, and Mr. Nicholls's account of his ascent of Mounts Tongariro and Ruapehu, the former still in a state of volcanic activity. In fact there is abundant evidence that at no very remote period volcanic action must have been widespread and copious over a very large area of the North Island. Though not so compared with the Southern Alps, which Mr. Green and his companions scaled last year, still Mr. Nicholls's journey was formidable and trying enough. In the King

Country the natives have retained many of their original characteristics and customs almost unchanged, and therefore such narratives as that of Mr. Nicholls is of considerable value to the ethnologist. The region is richly wooded, the scenery in many places magnificent, and the geological features well worth minute investigation. In an appendix we find a list of the New Zealand tribes with their localities, and careful lists of the flora and fauna met with during Mr. Nicholls's journey. Altogether the narrative is interesting, and contains a good deal of fresh information. There is an excellent map and many attractive illustrations.

*Forests and Forestry of Northern Russia and Lands beyond.* Compiled by John Croumbie Brown, LL.D. (Edinburgh: Oliver and Boyd, 1884.)

THE forestry of Russia has so recently been the subject of an article in our columns, that we need do little more than refer to this, the latest of the long series of volumes by Dr. Brown on his favourite *Forstwissenschaft* or forest science. It appears to have been compiled *apropos* of the International Exhibition of forest products in Edinburgh, and is intended "to introduce into English forestal literature detailed information on some of the points on which information is supplied to students at the schools of forestry on the Continent." The information contained in the volume has been obtained personally during journeys in Russia, or from the best official sources. There is also, it should be said, much to interest the most general and careless of readers, for Dr. Brown quotes extensively from the best recent writers on the districts of Russia to which his book specially refers.

#### LETTERS TO THE EDITOR

[The Editor does not hold himself responsible for opinions expressed by his correspondents. Neither can he undertake to return, or to correspond with the writers of, rejected manuscripts. No notice is taken of anonymous communications.]

[The Editor urgently requests correspondents to keep their letters as short as possible. The pressure on his space is so great that it is impossible otherwise to insure the appearance even of communications containing interesting and novel facts.]

#### M. Thollon's Views of "Great B" in the Solar Spectrum

THE excellence and power of M. Thollon's prisms have become proverbial in the spectroscopic world. For the sake, therefore, of having his own account of what he has himself seen (*NATURE*, vol. xxx. p. 520), with physical apparatus of gigantic size, so well planned, so admirably constructed, and manipulated with such matchless skill,—doubtless every reader will make very little objection to any small accompanying inaccuracy in one outside reference.

To me, therefore, as well as probably to every one else, it is a very trifling matter that he should lay to my charge that I have said "Great B" does not increase in intensity as the sun approaches the horizon; although in my "Macleira Spectroscopic" book I have actually introduced Plate 5 to show, as compared with Plate 4, that it does so increase very notably.

But the real point of interest, of special importance just now, and perplexity too, is not that there is some effect of the telluric character in the "B" lines—but how much? and in what manner does it grow with zenith distance?

Now that residual question does not seem yet to have occupied M. Thollon, or he would have described the different rates at which the dry gas lines of "B" grow with zenith distance compared with the lines of watery vapour; and, as a first and easy result, he would undoubtedly have obtained, as I have with far inferior means, an indication that the water-vapour of the earth's atmosphere is confined to the lower strata only, while the dry gas composing "B" belongs more nearly to the whole atmosphere, high and low. To that too, at least; for some observations of "B" when near the zenith, or looked at through the shortest aerial path possible at the place, showed me so immense an intensity still in its lines, as to lead to the suspicion



that part of their producing gas may be even far outside the usually considered limits of everything belonging to the earth.

M. Thollon, indeed, gives a view of the "B" region, "as," he says, "it would appear if observed outside the earth's atmosphere"; and therein he shows every line constituting our magnificent earthly constellation "Great B," absolutely wiped out of existence—a few *ultra-faint*, accidentally intruding solar metallic lines alone excepted. But how has the eminent *savant* obtained that view? Not by ascending in a balloon, or up the sides of a high mountain above all the grosser atmosphere, and seeing that it was so, but merely by observing some small amount of difference of effect, at two slightly different degrees of large zenith distance, viz. 60° and 80°, at the Observatory of Nice.

Two points, however, alone, will never enable a curve to be drawn on their sole authority; and as a curve of effect is what the investigation now requires, M. Thollon's hitherto merely duplex observations will acquire a far greater power of conviction for other men's minds, if he will kindly supplement them with others at 20° Z.D., or as near to it as the latitude of Nice will allow him at time of summer solstice. Still more would he make us all his debtors if he would repeat those three angular directions at three successive stations at greater hypometric altitudes; duly remembering that while every one knows that water-vapour and oxygen (the gaseous parentage of "B" according to the grand experiments of M. Egoroff) do exist in the earth's atmosphere, that does not, by itself, therefore render them impossible in greater or less quantity to the outer region of the sun's envelopes; or, in a highly attenuated degree, to the 92,000,000 of miles of space between. C. PIAZZI-SMYTH

15, Royal Terrace, Edinburgh, September 27

#### Shifting of the Earth's Axis

WITH reference to the letter of Mr. W. M. Flinders Petrie (*NATURE*, September 25, p. 512), I would remark that there has been no sensible change in the latitude of Greenwich (as found by observations of circumpolar stars) during the last forty-seven years, a period nearly twice as long as that covered by the Pulkowa observations which M. Nyrén has discussed. In a paper on the "Systematic Errors of the Greenwich North Polar Distances" (*Mem. R.A.S.* vol. xlv.), I have exhibited the results for the co-latitude of the centre of the Greenwich transit-circle for each year and for groups of years from 1836 to 1877 reduced to the same refractions throughout (Bessel's), and corrected where necessary for index-error of the thermometer, and the accordance of the individual results is as close as can be expected, when allowance is made for the systematic errors to which all observations are liable, but which are usually ignored in estimating theoretically the probable errors of mean results. It may suffice if I here give the results for co-latitude for three periods of years:—

1836-49	mean co-latitude	38° 31' 21"·85
1851-65		21"·87
1866-83		21"·85

The first and last results are identical and are absolutely inconsistent with Mr. Petrie's supposed increase of the Greenwich co-latitude of 1" or more in a century.

W. H. M. CHRISTIE

Royal Observatory, Greenwich, S.E., September 27

#### The Sky-Glows

FROM the great purity of the sky this evening, and from the flatness of the horizon westwards, on the line of the Great Northern Railway between Huntingdon and Hitchin, the sunset glow was of a very beautiful description. At five minutes before six (watch-time, three or four minutes slow) the sun set; and it was no sooner hidden than a parhelion-like patch of white light, 6" or 8" in diameter, brighter than the rest of the sky, occupied a place 10° or 15° above the sunset point of the horizon, and continued shining there with pearly brightness for about ten minutes. The horizon-line became edged at the same time with bright red, melting abruptly away upwards into orange, and higher up into a field of yellow light round the lucid spot. At 6.5 this spot's white light began to acquire a rosy tinge, and during the next ten minutes, until 6.15, it became intensely rose-coloured, preserving its definite place unchanged in the upper expanse of yellow; a vivid golden oriole-yellow stripe some degrees broad divided it from the red fringe along the horizon, the dazzling gold colour shading exquisitely into the fiery red

below and rosy red above, and deriving itself from the latter bronze-like greenish cast in its bright golden hue by contrast.

By 6.15 the rosiness of the bright spot had extended upwards and outwards from its centre, and was now blended in its cool and confines with the yellow band and red fringe below it, the whole presented a conflagration or red aurora-like outbreak of light in the west, 20° or 25° high, and extending 45° or 50° base along the horizon.

The yellow belt was fading out of this glory, and the brightness and rosiness of its upper part was fast disappearing, when at 6.15 there appeared, with extreme quickness in the bright base, dark intervals dividing it into upward radiating divergent beams of light, which rapidly acquired such fixed breadths and distinctness that I easily counted six or eight separate beams nearly equidistant from each other, and of equal lengths and strengths, marking out plainly by their divergence the space, and the considerable depth to which it had already spread below the horizon. The two outer ones only of the beams, the northern side, were a little confused together, and marred the symmetry which the whole presented, but the full number of their display was several times counted over during the minutes—until 6.25—that they continued visible. They were about 15° long from their bases, and extended across and upwards to themselves the light of what had been the golden-yellow beam but they gradually shortened and became dull red when at latter hour the horizon assumed the red appearance which usually presents some time after sunset. The above striking phases of the glow,—the white spot, the rose-red one, and the streamers,—occupied just ten minutes each, and the unusual aspect of the sky ceased entirely just thirty minutes after sunset.

The patch of whitish light observed this evening had all the appearance of a true, but extended and diffused, mock sun of some description; and I have noticed the peculiarity before; the sunset glows of last winter and spring, whenever I had opportunity to see the sky and watch their early phase after sunset; but crystals of ice being then plentiful in cirrus, the evidence of the mock sun's formation by non-aqueous ice in the atmosphere was not so strong as now, when it occurred after a long continuance of a summer temperature which has been unusually high. It is also singular and curious that the rosy tint began in the white-glow spot, and spread evenly outwards from it as a centre, as the extent and intensity of this remarkable colour grew and increased.

Appearing as the white spot does, when I have seen it, pretty fixed height of not less than about 12° from the horizon soon as the sun has set, it seems difficult to reconcile its position at such an altitude with a theory of its production by reflection of the sun's horizontal rays from fine films or laminae of foggy glassy dust, unless descending equatorial currents, perhaps those extremely stable heights may have a sensible inclination downwards from the west, and may tilt the films' under in a direction corresponding with that of the current slipping towards the sun?

With regard to the diverging beams, they are also, perhaps not quite ordinary, irregularly produced straight lines of reflection; but seemed by their symmetry to be connected, at least the origin of the shadow-gaps which formed them, with the ruled stripes or pleats of the cirrus, and of loftier haze, in case directed, it seemed, nearly east and west. With such bands and stripes directed rather more south-westerly, or a little towards the point of winter sunset, and intersected also slightly slanting systems of striation, I constantly noticed the sky in New castle-on-Tyne, during the prevalence last winter of spring of the repeated sunset glows, to be for weeks and months more or less constantly and uniformly, but in general weak and dimly, streaked and furrowed over. Either an unusual steady current was prevailing in the upper air; or else a permanent current there, and long lines of aerial disturbances through its streams were made more visible and conspicuous than ordinary by exceptional radiation, or some other unusual refrigerating haze-engendering cause, depriving the upper air of its transparency, during the time of the sky's presenting such unusual appearances in what Quetelet named and considered to be "stable" or untempestuous upper regions of the atmosphere.

Whatever may be the explanation of the streamers and of the white glare-spot, observations may perhaps be made of it under even more favourable conditions than occurred this evening, and they would then possibly give a little help towards arriving at some further conclusions both as regards the origin and other nature of the haze-causing substance, and as

manner and direction of the motions of the extremely lofty air-currents in which the finely-divided material is suspended.

A. S. HERSCHEL.

Collingwood, Hawkhurst, September 25

ON September 27, being on the river about 6 p.m., I noticed the beautiful colour of the sky, which lasted for three-quarters of an hour after sunset. The day had been very cloudy, but not much rain had fallen, and about 4.30 p.m. the sky cleared and the sun shone out. My attention was drawn to the appearance of the sky about 6.15, after the sun had set. Great masses of red appeared in the west on a background of gold and primrose; above this the sky shaded from green into blue; the red colour extended upwards for about 40°, and appeared of various shades, deep red, magenta, and rose colour, the various small clouds which were floating about being pink. This red light gradually broadened out and died away, giving place to deep orange and gold, the latter colour lasting till 6.45.

The water was as gorgeous as the sky above, the reflections of the trees being bright red and purple on a floor of gold. I may add that the red light from the sky was so strong that a rosy hue was thrown on some trees and everything around.

Hurley Mill, September 28

T. M. BROWNE

#### September Stream of Krakatoa Smoke at Strong's Island

AFTER long delay, owing to the wrecking at Strong's Island of the *Morning Star*, I feel very fortunate in coming into possession at last of a most important record of fact, which I hasten to publish, in the form of an extract from the journal of Miss Cathcart, the young lady missionary labouring at Strong's Island with Rev. Dr. and Mrs. Pease, and well known in Honolulu. It is as follows:—

"September 8.—Yesterday there was a very peculiar appearance of the sun. The sky was somewhat cloudy, but not so as to obscure the sun, which was of a silver blue colour, and not so bright but what we could look at it without any trouble. The shadow was the same as in an eclipse. There was no bright sunshine all day."

Although the journal contains no further record on the subject, nor any mention of the red glows which must have followed, it is so precise as to date and as to the phenomena observed as to be of the greatest value in continuing the history of the equatorial smoke-stream from Krakatoa beyond Honolulu and Fanning's Island, to which it had been continuously traced on its long route *via* the Seychelles, Cape Coast Castle, Trinidad, and Panama. It was observed by the barque *Southard Hurbert* some 2000 miles east-south-east of Honolulu on September 3, at Fanning's Island on September 4, and at Honolulu in conspicuous brilliancy on the evening of the 5th. Mr. Frank Atwater, landing at Maalaea, Maui, on the morning of the 5th, observed a wonderful red glow, and marvelled much (having just arrived) if such were the sunrises in these islands. The same morning passengers on the *Zealandia* steaming southwards towards the line were awakened by blue sunlight streaming into their berths. Mr. F. L. Clarke has supplied a report, somewhat imperfect as to date, of an obscured and coppery sun seen at the Gilbert Islands on or about September 7. This would be September 6 in our reckoning, the Gilbert Islands being west of the meridian of 180°.

Now we have the very precise date given by Miss Cathcart, of September 7 (6th) at Strong's Island, or just one day later than at Honolulu, and thirty-six hours later than the late afternoon coppery and lurid obscuration seen at Fanning's Island. Strong's Island is about 2320 miles nearly due west of Fanning's Island. This gives a rate of progress of the smoke-stream of sixty-four miles an hour. It seems proper to reckon time from Fanning's Island rather than from the Hawaiian Islands, as the latter were evidently north of the central course of the stream, and perceived its atmospheric effects half a day later than the former, although nearly on the same meridian.

It is to be specially noted also that the phenomena were characterised by the peculiarities seen at Fanning's Island, as well as at Panama, rather than those seen at Honolulu. Here the obscuration of the sun was so slight as not to have been noticed during the day, nor was any change in its colour observed, except by Mr. and Mrs. H. M. Whitney, who saw its disk *green* at setting on the 5th. At Strong's Island, as well as

at Fanning's Island, Panama, Trinidad, and eastward, the sun was heavily obscured, and its light changed to green at low altitudes, and blue when high up. This proves that the heavier thickness of the smoke-stream did not extend so far north as Honolulu, but was confined to a narrow belt near the equator. Fanning's Island is in lat. 2° 40' N., long. 159° W. Strong's Island is in lat. 5° N., long. 162° 30' E. The *Zealandia* was perhaps 5° N. when the blue sun was observed. Honolulu is in lat. 22° 17' N., and received only the clouds fraying off from the edge of the smoke-belt as it swept by to the southward.

The sun's rays were so greatly obscured by the density of the smoke strata in the main belt that they seem there to have failed to produce the marvellous twilight effects which were so conspicuous in Honolulu. All along the line from Seychelles to Strong's Island, we hear of lurid appearances, green sun, blue light, great obscuration, sun easily observed with the naked eye, but hardly anywhere a word about twilight effects, or red glows; while at Honolulu, under the thinner side clouds of the stream, the colour effects in the twilight were amazing.

The topic is an endless one, and I will not prolong. Many ask what is the cause of frequent revivals of the red glows, such as the very fine one of last evening, August 19. It seems merely to show an irregular distribution of the vast clouds of thin Krakatoa haze still lingering in the upper atmosphere. They drift about, giving us sometimes more, sometimes less, of their presence. It is also not unlikely that in varying hygrometric conditions the minute dust-particles become nuclei for ice crystals of varying size. This would greatly vary their reflecting power. This accords with some observations of Mr. C. J. Lyons, showing that the amount of red glow varies according to the prevalence of certain winds.

S. E. BISHOP

Hawaiian Government Survey, Honolulu, August 20

#### Biology & Botany

ACCORDING to the regulations of the Cambridge Local Examinations, 1883, junior students can alone take botany, while senior students must take elementary biology instead. What has been the result? Taking the Regent's Park centre as a typical example, for it is a single school of several hundred girls, and sends up probably more than any other school in England, we find that from 1872 to 1882, inclusive, 273 senior students entered, and 191, or 70 per cent. passed in botany. In 1883, however, *none were sent up at all*. If we ask, What is the object of teaching science in schools? the answer is obviously for its educational value. Now this can only be acquired by practical study. Botany is eminently qualified for affording this use, whereas zoology is not. The lady principal of the school in question will not entertain the idea of teaching any branch of science if it cannot be taught practically, and very pertinently asks, "How can I get two to three hundred frogs, and make my girls dissect them? In the first place, the parents would not allow it." Consequently biology becomes a dead letter, and botany is discountenanced by the Syndicate for the elder girls.

On inquiring of a member of the Syndicate, I am informed that the general idea is that the juniors should study botany from this educational point of view, but seniors are of such an age that mere "object-lessons" are no longer necessary, but training in scientific thought is called for. Now, in the first place, it must be borne in mind that, from the pressure of other subjects, it is not generally, if ever, easy to teach science at all adequately in schools; and, secondly, the small amount of botany that can only possibly be taught, even to the elder pupils, is little more than practical descriptions, a certain acquaintance with the leading families of plants, and the general principles of physiology and histology. There is not the time to do more. As an examiner for the College of Preceptors for many years, and having to look over papers from schools, &c., from all parts of England, I can testify to the fact that the standard of botanical teaching is decidedly low. Of course there are exceptions, but the majority, who get less than half marks, show little more than a smattering of the subject. Instead, therefore, of insisting on elder pupils advancing to biology, my own feeling is that it would be decidedly better to encourage seniors to continue the study of botany alone, but more thoroughly. The idea of calling such botany an "object-lesson" will sound somewhat ludicrous to my fellow teachers, who know what teaching practical botany thoroughly really means!

The remedy, therefore, seems obvious. Let the seniors as before pass in botany alone, but of a higher standard if you

will; and leave biology as it is for any who may wish to take up that subject. At present the effect can only be to quash the teaching entirely beyond its first and most elementary stage.

There are not wanting signs elsewhere of the evil effects of the younger school of botanists not recognising the importance of first training students in a thorough course of practical and systematic botany before proceeding to laboratory work. In an examination lately held for a post at Kew, I am informed that two gentlemen who had been trained at Cambridge competed with a gardener for the post. The gardener secured it. *Verb. sap.*  
GEORGE HENSLOW

### Animal Intelligence

HAVING frequently observed in your columns accounts of remarkable instances of reasoning power in animals, I am tempted to send you the following notes, which may perhaps be not without interest to the readers of NATURE.

A young canary belonging to our family is in the habit of receiving small pieces of biscuit, cake, or such like from the tea-table. The hardness of the biscuit has ever been a source of great annoyance to Dicky. One day, however, after an expectant and close examination of the tea-table, he was offered a piece of hard biscuit. Without making the least attempt to break it, he lifted it from the floor of his cage, and taking it to his water-trough, gently dropped it in, following up the action by patiently stirring it round and round with his beak, until it was in a condition to be eaten. He then carefully removed it and devoured it without any trouble. He now puts every *hard* substance which he deems eatable into the water. He endeavoured to soften sweets in the same way, but finding that the sweet became gradually smaller and smaller, he hastily abstracted it, and has never since put anything of that nature into the water.

An equally interesting case of reasoning power was lately exhibited by our cat. Pussy had lately become the mother of a family of kittens, and was naturally indisposed after the occurrence. She wandered about through the house in a strange manner, as if seeking for something, always, however, keeping within near range of the coal bunkers when they were likely to be required. With a view to finding out what she wanted, the bunkers were left open. The cat immediately entered, and commenced searching diligently among the coals, until she found a piece covered with pyrites. This she proceeded to lick vigorously, returning to the bunker and repeating the operation at regular intervals. On ground sulphur being offered her, she at once forsok the pyrites for that, and ere long, by use of that medicine, regained her usual health.

R. J. HARVEY GIBSON

Zoological Laboratory, University College, Liverpool,  
September 29

In the notes on Australian ants forwarded by me by the last mail I forget whether any mention was made respecting an idea that has struck me several times, as to the method in which the antennæ are employed by ants as a means of communicating with each other. That ants utter no audible sound is pretty plainly proved by experiments made with the microphone. It is said that the *Ambillidæ* give a kind of sharp cry when captured, but the statement requires to be verified. Ordinary ants may be generally spoken of as destitute of any means whereby to utter articulate speech. Beyond the fact that they do not appear to be able to speak, so as to be heard by human ears, the tests resorted to by Sir John Lubbock would go to show that it is extremely doubtful whether ants possess the sense of hearing at all. This, however, does not preclude the possibility, or even the probability, of their being in full power of a means by which they are able to converse. It will be remembered that the antennæ are divided into two separate portions, the *scape* and the *flabellum*. The latter is subdivided into about ten separate segments. Now in this arrangement, by adopting a preconceived system of signals, all the words of an English dictionary might be expressed.

Let us say that A meets B, and, according to the vocabulary of *Formicaria*, that a touch with the tip of the antenna of A on the terminal segment of the antenna of B signifies any particular word. A similar touch made on the second segment of the antenna of B indicates another word, and so on. Here there is a means of expressing at least ten different words by taking from the point of the flabellum to its base. If the second

point of the flabellum of A is employed as a touching organ, the number of signs that might be conveyed from the one ant to the other would be twenty. If all the segments were thus utilised, a hundred different signs might be interchanged. This is for one antenna only. By utilising the pair this number would be doubled, and by multiplying the number of touches, to express words or plurals of words, also, and by crossing the antennæ so that the right antenna of A touched the left of B, and *vice versa*, all clearly distinct signals, the vocabulary of these little people would be extended almost *ad infinitum*. Say that the one touch of a segment of the flabellum meant an ant, two touches a pair of ants, and three a multitude; here there exists a means by which complicated ideas might be communicated in a manner somewhat similar to that adopted by the Chinese, by whom a particular sign means a woman, two mischief, and three marital unfaithfulness; or, as in the language of the Australian natives, who employ the term "Yarra" as signifying "flowing," and "Yarra-Yarra" as "ever-flowing." All this would be pantomime, of course; but those who have witnessed a public exhibition of the skill of well-taught deaf-mutes, are aware of the amount of information that can be imparted by the simple use of the ten digits, just half the number of separate conversational organs at the disposal of ants. Nor do persons and nations, well able to speak audibly, fail to avail themselves of the same kind of speech. A Chinaman utters a certain word, but it may mean half a dozen different things, as he moves his fingers to the right or to the left, up or down, or describes some imaginary diagrams in the air.

The above views may seem altogether visionary at first sight, but we have been told so many remarkable stories relative to the instincts displayed by the singularly intelligent creatures under consideration, that no persevering student of their habits will be inclined to say that the use by them of some such code of signals is altogether beyond the range of possibility, even of probability.

It might be as well if naturalists, when watching the meeting of ants, would notice carefully whether the observed touches vary in any particular, and whether any noticeable results followed after, and appeared to be connected with, the variations.

THOMAS HARRISON

244, Victoria Parade, East Melbourne, Victoria,  
July 16

### Meteors

I HAVE to record a brilliant series of meteors seen last night (Sunday, July 20) by myself and others. I will describe that seen by myself, as, amid the many splendid meteors I have observed during my sixty years of life, I have never seen one more magnificent. I was walking up and down my "quarter-deck," the carriage-drive in front of my house, which faces due north and south, admiring the glorious tints of the dying day, for we have been having, on a reduced scale, the grand sunsets about which I have already written. I was looking due north, and saw a huge fireball suddenly appear about half way between the horizon and the zenith. It moved slowly and horizontally, leaving a broad trail of red light behind it, as well defined as that emitted by a rocket. The meteor itself was about half the size of a full moon, white, and of the most intense and dazzling brilliancy. It travelled so slowly that I had time to call out, *several* times, to my wife, "Look at that glorious meteor," and she had time to turn round and see it. At about north-north-west it suddenly broke up into six, if not *seven* pieces, but at this moment its light was so intense that I could not be quite certain; six, however, I counted *distinctly*. They did not *fall*, but trailed on in a line after the larger mass, which did not seem diminished by the rupture, and finally, at north-west, they all disappeared. On taking out my watch I found it was just two minutes past six, and as we are a month past our shortest day, you can fancy there was plenty of daylight left to dim its splendour. But it was a magnificent sight, and its intense brilliancy surpassed anything I have seen before.

At 6.30 two friends walked up to dinner. I asked if they had seen the meteor. They said, "Yes, how splendid it was!" I asked, "Could you count the number of pieces into which it broke?" They looked at each other in amazement. "It did not break!" "In what direction did it pass?" was my next question. "From west to east," said one of them; "if you were standing here you could not have seen it; it was low down on the southern horizon, behind your house." I then

found on comparing notes that this one, which they both said was large and extremely brilliant, had appeared about *twenty-five minutes past six*.

At night we attended the Governor's last "reception," prior to his leaving the colony. He was handing my wife to her carriage—I was unfortunately in the house—when another fine meteor illumined the sky. It must have been in the west, or, from the position of the carriage and the buildings, my wife could not have seen it. She says it fell straight down from the zenith, and broke into several pieces. This occurred at 10 45; I had just previously looked at my watch. I also heard of other smaller, though bright, meteors, but did not see them myself. What are we doing, Mr. Editor? Are we going through the tail of a comet? or is cosmic dust igniting? or are the "dire and bloody" portents? Whatever they are, I record them, in the hope that others may have seen and noted them.

British Consulate, Noumea, July 21 E. L. LAVARD

### The Milleporidæ

SPECIAL interest is attached to any direct evidence as to the nature of the reproductive organs in the Milleporidæ, the more especially as no traces whatever of such organs have hitherto been discovered. In the absence of any direct evidence it has been concluded that, from the apparent absence of ampullæ, the gonopores probably develop free of the cœnosteum; and this seemed partly borne out by the general resemblance between the zooids of the Milleporidæ and those of the gymnoblastic Hydroids.

On some dry specimens, however, of a new species of Millepora (*Millepora murrai*, characterised by its extremely laminated and coalescent frond, much and palmately divided at their extremities, and by its minute gastropores, .25 mm. wide, and its still more minute dactylopores and even surface) from the Philippines, there occur, irregularly and numerous distributed among the young branchlets of the cœnosteum, large receptacles, which, though the absence of the soft parts prevents any absolute confirmation thereof, can leave no doubt as to the true ampullate nature of the generative organ in this family. These receptacles occur either closely, or widely apart, as circular cavities in the superficial reticulations of the cœnosteum, and are covered above by a very thin and porous layer, which is often broken away. When it is thus laid open, the cavity is seen to be about .75 mm. in diameter. The receptacles are seen on the surface as white, circular, scarcely raised areas about .5 mm. in diameter, with a small pore in the centre; and they are generally rather numerous placed on one or both faces of the palmated branchlets.

By the discovery of the ampullæ in the Milleporidæ, a complete confirmation is given to the relationship which Prof. Moseley has shown to exist between this family and the Stylasteridæ; and it is seen that the two families are even more closely related than had been imagined. The presence of such a structure seems to bring the Milleporidæ into relationship rather with the calyptoblastic than with the gymnoblastic Hydroids, in spite of the general resemblance of its zooids with the latter.

JOHN J. QUELCH

Natural History Museum, South Kensington

### To Find the Cube of any Number by Construction

THE following graphical construction for finding the cube of a number may interest more than the mere mathematician:—

Take a triangle  $ABC$ , in which suppose  $A$  to be the vertical angle and  $B$  greater than  $C$ . Draw the perpendiculars  $AD$ ,  $BE$ ,  $CF$ , thus obtaining the pedal triangle  $DEF$ ; take  $H$  the middle point of the perpendicular  $EG$  on  $DF$ . Then  $\tan CDH = \tan^3 CDE = \tan^3 A$ . If then we take a triangle with vertical angle  $A$  such that  $\tan A = n$ , we see that  $\tan CDH = n^3$ .

The proof of the above result is quite elementary.

September 22

R. TUCKER

### The Failure of the Parsley Crop

WOULD you permit me to ask some subscribers to your paper if it be possible to account for the total failure of the crop of parsley this and last year. Is it owing to any known insect or what? The parsley comes up well, grows to about one inch in height, then begins to dwindle and get yellow, and the whole

summer remains about half an inch high, the only green part being the crown. All the market gardeners are in the same position as myself, only one having a crop, and this was sown in freshly cultivated earth. I have carefully examined leaves and roots under the microscope, but can discover no cause for this disease. Have any of your subscribers been troubled in the same manner, and can any one suggest a remedy? W. H. C. B. Cheltenham, September 23

### Wasps as Fly-Killers

YOUR correspondent at p. 385, vol. xxx., may be informed that in this part of the world wasps enter dwellings by the open windows in summer-time, and hunt house-flies unmercifully, leaving the dead flies in hundreds on the floors, ready to be swept into a dustpan. This occurs only in the country, and where wasps' nests are near by. Westwood quotes from St. John's "Letters to an American Farmer" that: "The Americans, aware of their (wasps') service in destroying flies, sometimes suspend a hornets' nest in their parlours." (Introduction to "Modern Classification of Insects," ii. p. 240, foot-note).

GEORGE LAWSON

Dalhousie College, Halifax, Nova Scotia, September 8

### GEORGE BENTHAM

WE recently announced the death of the veteran botanist, George Bentham, when within a few days of his eighty-fourth birthday. His life, from a very early age, was one of incessant mental activity, and of much change and vicissitude during its three or four first decades. Through his birth, connections, and various residences on the continent of Europe, as well as in England, he became acquainted with many men famous in literature, science, and art, and his career is rendered especially notable from its intimate association with his uncle Jeremy, the jurist, in the arrangement of whose papers and preparation of whose works for the press he was actively engaged for not a few years, and with whom he resided on the most intimate terms as companion and secretary till the death of that relative in 1832. This and the scientific value now attached to the "pedigree" have suggested the expediency of entering with some detail into the family history and early life of Mr. Bentham (for most of which we are indebted to information imparted by himself) before detailing his botanical career and writings.

About the year 1750 Jeremiah Bentham, an attorney or solicitor, one of a family of scriveners who, as fathers and sons, had inhabited the Minorities since the beginning of the seventeenth century, migrated to the West End of London, purchasing property in Queen's Square Place and Petty France (now York Street, on the south side of Birdcage Walk, St. James's Park). He had two sons: the elder, Jeremy, the well-known writer on Jurisprudence, the younger, Samuel (subsequently Sir Samuel), father to George, the botanist. Samuel devoted himself to the study of naval architecture, and at the age of twenty-two visited the arsenals of the Baltic for the purpose of improving himself. From thence he travelled far into Siberia, and became intimate with Prince Potenkin, who induced him to enter into the service of the Empress Catherine, at first in a civil, and afterwards in a military, capacity. In the latter he took a distinguished part in a naval action against the Turks on the Black Sea. For this he received the Cross of St. George, and was given the command of a regiment quartered in Siberia, which enabled him to penetrate eastward to the frontier of China. After ten years of absence he returned to England, and was shortly afterwards promoted to the rank of general. The death of Catherine followed soon after, when he was offered employment in England by his friend Earl Spencer, then First Lord of the Admiralty, who was anxious to avail himself of Gen. Bentham's ingenuity and experience in

improving the civil branch of our naval system. This he accepted, resigning the Russian service, and attained the post of Inspector-General of Naval Works. His son has been heard to say that amongst other improvements introduced by Gen. Bentham into the dockyard were the steam sawmills and the machinery for the eccentric turning of blocks, through his employment of the late Isambard Mark Brunel, whom he brought over to England.

In 1796 Gen. Bentham married the eldest daughter of Dr. George Fordyce, F.R.S., the well-known physician and author. Mrs. Bentham was a woman of great ability and energy; she had actively aided her father in the preparation of his works, and with still greater perseverance she devoted herself to assisting her husband in his arduous labours, drawing up as well as writing out his voluminous reports to the Admiralty, and accompanying him on his visits of inspection to the dockyard, which were often of several months' duration. Up to the age of eighty she wrote a most beautiful hand, and it is within the recollection of readers of this article that letters in the *Times*, under her signature, when she was considerably over ninety years of age, appeared during the Crimean War, urging the introduction of improvements in our war material, especially great guns, which her late husband had suggested.

It was during one of the annual inspections of the Portsmouth Dockyard that George was born, at Stoke, then a village near Portsmouth, and now absorbed in that town. He was the second son, and had three sisters, one of them older than himself. All were forward children: on their fourth birthdays the two elder sisters made the clothes they wore on those days and wrote out a list of their possessions; and before he was five years old, George wrote copies, enjoyed reading Miss Edgeworth's "Easy Lessons" with his brother, and began to study Latin. The whole family were taught reading by the words, not letters or syllables.

In 1805 Gen. Bentham was sent by the Admiralty on a mission to St. Petersburg, having for its object the building in Russia of ships for our navy, and he took his family with him. There they remained for two years, during which time the education of the children was intrusted to a talented Russian lady, who could speak no English; and the young people, showing a remarkable facility for the acquisition of languages, were able before leaving to converse fluently in Russian, French, and German. Latin was acquired under a Russian priest, and, at six years of age, music, to which George subsequently became passionately attached, was commenced.

War between England and Russia breaking out in 1807, Gen. Bentham was recalled. The homeward route was by Revel and Sweden, and the voyages were notable. At Revel they embarked for Stockholm in a Russian frigate, a bad sailer, with a crew hardly any of whom had before been at sea; and, after driving backwards and forwards in the Baltic under continuous gales, they landed on the fourteenth day at Carlsrona! In Sweden they were detained several weeks, long enough for the two brothers and their elder sister, by dint of perseverance and hard study, to learn enough of Swedish to converse in that language and read it with tolerable ease. From Gothenburg they sailed for Harwich in a wretched craft, and, after beating about the North Sea in a succession of tempests, arrived on the fourteenth night, when the crew took the boats and hastened ashore, leaving the Benthams till the following midday with no other food but rejected bits of biscuit picked up wherever they could be found.

In England the family settled at Hampstead, whence the father went daily to his offices at the Admiralty and Somerset House, whilst George and his brother pursued their studies. These, then and ever afterwards, were conducted by private tutors, and it was a life-long source of

regret to George that he had never been at school or college. This, in his opinion (and not his alone), accounted for an habitual shyness and reserve that often caused him to be misunderstood, and credited with motives or sentiments that were foreign to his disposition and character. Much of his time was spent at Berry Lodge, a house and property which his father had bought between Gosport and Alverstoke, where the summer months were passed, and which still belongs to the family. It was from here that he was once taken by his father on a visit to Lady Spencer at Ryde, and met at her house John Stuart Mill—then on a visit there—a boy of six, in a scarlet jacket and nankeen trousers buttoned over it, and who was then considered a prodigy. Bentham has described him as wonderfully precocious, a Greek and Latin scholar, historian, and logician, fond of showing off, and discussing with Lady Spencer the relative merits of her ancestor the Duke of Marlborough and the Duke of Wellington, he taking the part of the latter.

The year 1814 opened upon a period of great excitement throughout the Continent; the invasion of Russia by Napoleon and the burning of Moscow were naturally matters of intense interest to the Bentham family. The boy George, then only thirteen, now budded into an author, commencing with his brother and sister the translation of a series of articles from a Russian paper, detailing the operations of the armies, which were contributed to a London magazine of ephemeral duration. He gloried in the reverses and final abdication of Napoleon, and was presented to the Emperor of Russia by his father on the visit of that monarch to the naval establishment at Portsmouth.

Peace being proclaimed, the Bentham family went to France, and prepared for a long residence in that country; they resided first at Tours, then at Saumur and Paris, during the eventful period that extended from the return of Napoleon to his final overthrow. Young Bentham kept full journals of all that passed, interspersed with anecdotes relating to the forced exile of Louis, the defeat of the Emperor, the restoration of the Bourbons, the conduct of the allies, the execution of Ney and Lapedoyère, the condition of the city of Paris, and the prominent part taken in the politics of the day by Walter Savage Landor, who was intimate with his family. Moreover, he seems to have been able at this early age to enjoy and even take his part in the society of the eminent men of the time and the salons of the leaders in literature and science, the Duc de Richelieu, Talleyrand, the Comte de Damas, Jean Baptiste Say, the aged Mme. Andelan (the daughter of Helvétius), were amongst the intimate friends of the family; as was Baron Humboldt, who took warmly to the lad, encouraging especially his taste for geographical science, giving him introductions to libraries and to individuals who could aid him in the preparation of a work which he had begun on the data of physical geography.

In 1816 Gen. Bentham organised what may be called a caravan tour of France for himself and family, having for its objects partly unceremonious visits to his many friends in the provinces, and partly the leisurely inspection of the great towns and other objects of interest. The *cortège* consisted of a two-horse coach fitted up as a sleeping-apartment, a long, two-wheeled, one-horse spring van for himself and Mrs. Bentham, furnished with a library and piano, and another, also furnished, for his daughters and their governess. The plan followed was to travel by day from one place of interest to another, bivouacking at night by the road, or in the garden of a friend, or in the precincts of the prefectures, to which latter he had credentials from the authorities in the capital. In this way he visited Orleans, Tours, Angoulême, Bordeaux, Toulouse, Montpellier, and finally Montauban, where a lengthened stay was made in a country-house hired for the purpose. From Montauban (the *cortège* having broken down in some way) they proceeded, still by private conveyances, to

Carcassonne, Narbonne, Nîmes, Tarascon, Marseilles, Toulon, and Hyères.

It was during this tour, when at Angoulême, that Bentham's attention was first turned to botany, and it fell out on this wise:—His mother, who was fond of plants, and a great friend of Aiton at Kew, had purchased a copy of De Candolle's "Flore Française," which was then just published. Young Bentham took it up accidentally, and was struck with the analytical tables for the determination of the affinities and names of plants, which exactly fitted in with the methodising, analysing, and tabulating ideas which he had derived from his Uncle Jeremy's works, and had endeavoured to apply to his own geographical tables. He at once went into the back-yard of the house, and, gathering the first plant he saw, he spent the whole morning studying its structure with the aid of the introductory chapter of the "Flore," which treated of elementary botany, and succeeded in referring it to its natural order, genus, and species. The plant, *Salvia pratensis*, was not an easy one for a beginner, owing to the irregularity of the flower and abnormal character of the ovary and stamens. His success led him to pursue the diversion of naming every plant he met with in future.

At Montauban, near Tours, where the family resided for many months, Bentham spent what he always regarded as the happiest period of his life; he was entered as a student of the Faculté de Théologie, at Tours, followed with ardour the courses of mathematics, Hebrew, and comparative philology (the latter a favourite study in after-life), and at home occupied his time with music, Spanish, drawing, and botany, whilst, during the holidays, dancing was his delight; it was a favourite boast that at Montauban he attended thirty-four balls between Twelfth-night and Mardi-gras, of which thirteen were consecutive, and lasted from nine at night to the same hour on the following day.

The appearance of the "Dictionnaire d'Histoire Naturelle," a course of lectures under Benedict Prevost, and De Candolle's general works on the structure and classification of plants, first opened his mind to scientific botany, and induced him to take up the study of exotic plants, to which he devoted himself till 1820, when he took to the amusement of shooting and stuffing birds. At this period, too, John Stuart Mill resided in his father's family for seven or eight months, and it was probably due to this that Bentham was diverted to the study of philosophy, and at the age of twenty began a translation into French of his uncle's "Chrestomathia," which was published in Paris some years afterwards. Here, too, he began the study of Lamarck's works, with the "Système analytique des Connaissances positive de l'Homme," only to give it up in disgust on reading "Dieu créa d'abord la matière," followed by the statement that nature was the second thing created, and this produced everything else. Sliding down from great things to small, a fit of entomology supervened, and he commenced tabulating observations on insect life as he had his geographical and philosophical facts and ideas.

The next phase of Bentham's Protean life was that of a practical estate-manager and farmer, his father having bought a property of 2000 acres, that of Restinalières, near Montpellier, and given over the management of it to his now only son, for he had lost his eldest through an accident some years before. Into this work Bentham threw himself with ardour, and now his methodical habits, close application, and familiarity with French country life stood him in good stead. The farms and vineyards rapidly improved, and were very profitable. Still he found time for his favourite pursuits, his holidays were spent in botanical excursions to the Pyrenees and Cevennes, and his spare hours at home in logic and the preparation of a French edition of his uncle's essay on Nomenclature and Classification. Here, too, he wrote his own first work of importance, "Essai sur la Nomenclature et Classification

des Arts et Sciences," which was published in Paris, and established his position in France as an acute analyser, clear expositor, and cautious reasoner.

In 1823 Bentham was sent to England for the purpose of purchasing agricultural implements and obtaining information as to improved methods of farming that might be introduced into the Montpellier estate. On arriving in London he was asked by his uncle to visit him, bringing his translation of the "Chrestomathia." This invitation, the attractions of English scientific and literary society, and the fact that provincial jealousies threw every obstacle in the way of the introduction of improvements into the Restinalières estate, led ultimately to the abandonment by his father of the latter (in 1826), and the return of the Bentham family to England.

On his arrival in London he was at once received into the best literary and scientific society; he attended the breakfasts and receptions of Sir Joseph Banks, and studied in his library and herbarium, and that of the Linnean and Horticultural Societies, and formed life-long friendships with Brown, Lambert, Don, Sabine, Menzies, &c. During a tour through England and Scotland, taking with him letters of introduction to the leading botanists there, he became acquainted with Sir James Smith, Dawson Turner, Graham, Greville, Hooker, and many others. It was during this tour that he formed a friendship with the late Dr. Arnott (subsequently Professor of Botany in Glasgow), with whom he made, in 1824, an extended journey into the Pyrenees, which resulted in his first botanical work, "Catalogue des Plantes indigènes des Pyrénées et de Bas-Languedoc, avec des Notes et Observations" (Paris, 1826).

On the settlement of the family in London a new career was opened to Bentham, his uncle Jeremy having invited him to devote much of his time to aiding him in the arrangement and preparation of his MSS. for the press, accompanying the invitation with assurances that he would provide for him at his death. The proposal of aiding his uncle was congenial to him, but not the accompanying one, for he was now desirous of seeking a serious profession that would lead to independence; and after many embarrassing interviews on the subject with his uncle it was arranged that he should enter Lincoln's Inn and study law, whilst devoting some morning hours to his uncle, besides dining with him twice a week and writing for him afterwards from 8 to 11 p.m. In one shape or another this arrangement of working with and for his uncle lasted till the death of the latter in 1832; when, owing to the many foolish and fruitless speculations of the great jurist, the extravagant sums spent by his executors on the posthumous publication of his works, and some irregularity in his will, Bentham found himself in possession of the house in Queen Square Place, but with less property than he should have received. His father's death, however, in the previous year, had rendered him in a measure independent.

From 1826 to 1832 Bentham's life was one of incessant activity. Besides his irksome labours for his uncle, in whose ideas he did not at all participate, and many of whose acts he regretted, he had the editing and often rewriting of his father's (now Sir Samuel Bentham's) voluminous papers on the management of the navy and the administration of the dockyards. His legal studies were sacrificed to logic and jurisprudence; the fruits of the former being the publication of his "Outlines of a New System of Logic, with a Criticism of Dr. Whateley's Elements of Logic" (London, 1827), in which the doctrine of the quantification of the predicate is for the first time clearly set forth. This remarkable work fell still-born from the press; only sixty copies were sold, when the publishers became bankrupt, and the stock was seized and went for waste paper. It was not till 1850 that the fact of its containing a discovery was recognised (*Athenæum*, December 31, 1850); this led to a sharp dispute as to Sir

William Hamilton's claims to the same, and which was ended by a verdict of Herbert Spencer's in the *Contemporary Review* (May 1873) in favour of Bentham.

In jurisprudence two subjects deeply engaged his attention—one was codification, in which he entirely disagreed with his uncle, and his paper on which attracted the attention of Brougham, Hume, and O'Connell; the other was the laws affecting larceny, his suggestions on which he submitted to Sir Robert Peel, *apropos* of his Bill for the consolidation of the criminal law. Of this Peel thought so highly that he wrote a complimentary letter to its author, informing him that his remarks should be fully considered and submitted to Sir John Richardson, to whom the Bill was referred. Brougham also (to whom his uncle showed the paper) wrote a letter of eighteen pages of remarks on it. These and a pamphlet on the "Law of Real Property" are Bentham's chief contributions in his adopted profession. Of practice he had very little; he got his first brief in 1832, and, as junior counsel, bewigged and begowned, followed his leader when called for; but, being overcome with nervousness, he cut short his argument, and had the mortification of hearing the counsel for the opposite side say that "a more preposterous speech it had not been his fortune to hear during a long course of practice."

In botany Bentham was more at home than in the courts. In 1828 his herbarium arrived from France, and in the same year he was elected a Fellow of the Linnean Society, and joined with delight its reunions, attending its meetings punctually, its anniversary dinners, and those of its club. The return of Wallich from India with the enormous collections of the East India Company which first made known the flora of the Himalayas, Burmah, and many other parts of that vast empire, gave him occupation in the study and publication of various intricate genera and natural orders of plants. Of these writings, his "Labiatarum, Genera and Species" was the most important; this large family having been in a state of utter chaos before Bentham brought his remarkable powers of generalisation and description to bear upon it.

In 1829 Bentham finally gave up the law for botany, and amongst other labours accepted the honorary secretaryship of the Horticultural Society, which was in a perilous condition of debt and dissension. From these he extricated it with perfect success, and, aided by his friend Lindley, the assistant secretary, raised it to a flourishing condition financially and scientifically, and which it has never since approached.

In 1833 he married the daughter of the late Right Hon. Sir Harford Brydges of Botalbrooke, formerly Ambassador at the Court of Persia, and in 1834 removed to his late uncle's house in Queen Square Place, the site of which is now occupied by the "Bentham wing" of the "Queen Anne's Mansions." There he resided till 1842, when, with the view of providing better accommodation for his now extensive herbarium and library, and devoting himself more exclusively to science, he removed to Pontrilas House in Herefordshire, where he revised the *Labiata*, and elaborated the great families of *Scrophularinæ*, *Polygonæ*, and others for his friend Alphonse de Candolle's continuation of the "Prodromus Systematis Naturalis Regni Vegetabilis."

In 1854, finding that the expenses of his collections and books were exceeding his means, he determined on presenting the whole to the Royal Gardens at Kew (they were valued at 6000*l.*), and returning to London; at the same time he entertained the idea of abandoning botany, with characteristic modesty regarding himself as an amateur who had hitherto pursued the science rather as an intellectual exercise in systematising, than as a scientific botanist, who, in his opinion, should unite a competent knowledge of anatomy, physiology, and of Cryptogamic plants, to skill as a classifier and

describer of Phanerogams. He yielded, however, to the entreaties of his friends, the late Sir W. Hooker and Dr. Lindley, coupled with the offer from the former of access to his own private library and herbarium, and a room in Kew where his own was placed, backed by the request that he would inaugurate the series of colonial floras that was planned at Kew, by elaborating that of Hong Kong. Consequently, in 1855 he again took up his residence in London, first at Victoria Street, and latterly at 25, Wilton Place, and for the remainder of his life, till disabled by age, he almost daily throughout the year, except during autumn excursions to the Continent or visits to friends in Herefordshire, repaired to Kew and occupied himself exclusively with descriptive botany from 10 a.m. till 4 p.m.

The Hong Kong flora finished, Bentham took up that of Australia, and, aided by the observations, collections, and numerous discoveries of his active and able correspondent, Baron Mueller, of Victoria, he, single-handed, completed it in 1867 in seven octavo volumes, containing about 7000 species, the most extensive exotic flora ever brought to a conclusion. Meanwhile, the plan of a general work on Phanerogamic plants had been on various occasions discussed by Dr. Hooker and himself; at first it was proposed to confine it to carpology, but it finally assumed shape in a critical study and description of the genera of plants, founded on all available characters, for which his herbarium and the Hookerian offered unrivalled resources. This work, entitled "Genera Plantarum ad Exemplaria, imprimis in Herbariis Kewensibus servata, definita," was commenced in 1862 and concluded in 1883, the greater portion of it being the product of Bentham's indefatigable industry.

The only material break in Bentham's work at Kew was his acceptance of the presidency of the Linnean Society, which he held from 1863 to 1874, and to the duties and interests of which he devoted his time, his energies, and his purse, with characteristic singleness of purpose. He combined with the duties of President those of Secretary, Treasurer, and Editor of the botanical parts of the *Transactions* and *Journals*, spending a part or the whole of one day a week in the Society's rooms during the eleven years of his presidency. On the final transference of the Society's collections, library, and portraits from the rooms in old Burlington House to those they now occupy, he arranged the whole himself, classifying the books, and literally with his own hands placing them on the shelves they now occupy. His presidential addresses were remarkable for their grasp and wide range, and those who knew him only as a systematist and descriptive writer were surprised to find the great powers of analysis and the sound judgment he displayed in discussing evolution and its bearings, the writings of Haeckel, geographical distribution, the condition and prospects of fossil botany, deep-sea life, abiogenesis, methods of biological study, and the histories and labours of the Natural History Societies and their journals, and the scientific periodicals of every civilised quarter of the globe.

On the conclusion of the "Genera Plantarum" in the spring of 1883, his strength, which had for some years shown signs of diminution, suddenly gave way, and, after several ineffectual attempts to resume his studies, his visits to Kew ended, and, lingering on under increasing debility, he died of old age on September 10 last, when within a few days of his eighty-fifth year, leaving no family, and directions that his funeral was to be a strictly private one.

The above sketch conveys no idea of the prodigious amount of systematic and descriptive work in Phanerogamic botany that Bentham accomplished. In the "Genera Plantarum" there is hardly an order of any importance that he did not more or less remodel. His labours on the Compositæ, Graminæ, Cyperacæ, and Orchidæ are especially noticeable, and he contributed

masterly essays upon these and others to the Linnean Society. His treatises on the Leguminosæ are no less exhaustive and valuable; and there is not a temperate or tropical region of the globe whose floras have not been largely elucidated by him. It may safely be affirmed that for variety and extent of good work of the kind he had no superior. The distinctive qualities of his descriptions are—scientific accuracy, good arrangement, precision of language, lucidity, and the discarding of what is superfluous. In these respects he has had no superior since the days of Linnæus and Robert Brown, and he has left no equal except Asa Gray.

Of his amiable disposition, and his sterling qualities of head and heart, it is impossible to speak too highly: though cold in manner and excessively shy in disposition, he was the kindest of helpmates and most disinterested of labourers for others.

Of recognition by foreign Academies Bentham had his full share, including that of Corresponding Member of the Institute of France. His election into the Royal Society was not till late (1862). It should have been in 1829, when he was proposed by R. Brown, and at his recommendation withdrawn, along with other scientific candidates, who thus showed their dissatisfaction at the Society's election of a Royal Duke to the President's chair. He, however, received the Royal Medal of the Society, and in 1878, on the completion of the Australian flora, the Secretary of State for the Colonies, unsolicited, recommended him to Her Majesty for the Companionship of the Order of St. Michael and St. George.

#### A MODEL LENS FOR USE IN CLASS DEMONSTRATIONS

IN using diagrams or models as aids in teaching, this question constantly arises—How far may we represent Nature diagrammatically without producing in the mind of a student one-sided and false impressions? I have myself endeavoured to follow this rule: that, if a complicated object or phenomenon is to be studied, we may simplify this, and bring out many salient features, with a diagrammatic representation; this must, however, only be looked upon as a stepping-stone to a more complete study of the object or phenomenon itself. The

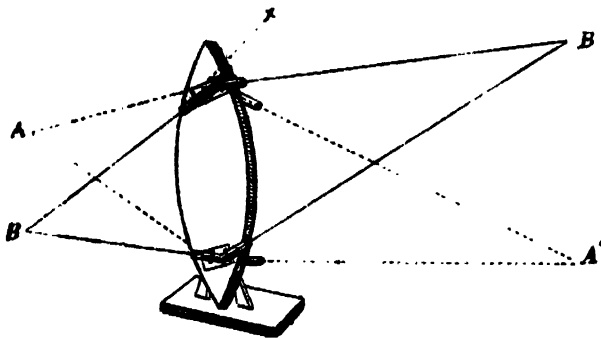

model of a lens to be described I have found of much service in lecturing, antecedent to a demonstration of the passage of luminous rays through actual lenses.

This model may be constructed out of the simplest materials, and should cost but two or three shillings. It consists of a piece of deal board cut in the shape of the cross-section of a biconvex lens, and fixed to a stand of wood (see diagram). Four small squares of board, *x*, are fixed in the positions indicated, two on either side of the lens. Glass tubes bent at obtuse angles are fixed to these by staples, and can rotate with them on the screws by means of which the squares are fixed to the lens. Two pieces of string to represent visual rays are then passed through the tubes *A A'* and *B B'*. The theory of the use of

this model will be at once apparent. A ray of light passing through a lens of a given curvature and density will practically (this is not absolutely true) be bent at a given angle, whatever be the direction of the ray, so long as it passes through the same part of the lens. In the model this constant degree of bending is given to the string—representing the ray of light—by the bent tubes. These, rotating on the lens, allow one diagrammatically to represent the rays passing through it in any desired direction.

Taking the string *B B'*, for example, and holding it at these two points in the two hands, and keeping the string taut, it will be found that in shifting the point *B*—representing a luminous point in any direction, *B'* will shift until it occupies the position of the corresponding focus. By shifting the string it is possible to demonstrate the focal points of parallel, diverging, and converging rays, either parallel to the axis of the lens, or on secondary axes. Then, by using at the same time the string fixed to the other side of the lens *A A'*, the formation of an image may be shown. Grasping with the two hands *A* and *B*, an assistant holding *A'* and *B'*, it will be seen how by this lens an inverted image is produced. Bring the points *A* and *B* nearer the lens, keeping them, however, at the same distance apart, and the points *A'* and *B'* will recede from the lens and from each other, showing how the image of the nearer object is formed farther away from the lens, and is larger in size. On the other hand, if *A* and *B* be pulled away from the lens, *A'* and *B'* approximate to it and to one another.

In working the model the squares should rotate easily, and the strings must always be held taut. For lecture-room purposes the lens should be about two feet high, and the strings may be coloured. On the same principle I have constructed models of other lenses or lens combinations.

JOHN B. HAYCRAFT  
Physiological Laboratory, Mason College,  
Birmingham

#### THE ELECTRICAL EXHIBITION AT PHILADELPHIA

[FROM A CORRESPONDENT]

TO one who has visited the various electrical exhibitions held in recent years in the chief European cities, the Exhibition now open in the city of Philadelphia might seem a little disappointing from the absence of novelty in the exhibits, though replete with objects of interest for all to whom this class of show is not familiar. As might be expected, the strong point of the Philadelphia show is electric lighting; and the building—a temporary structure erected close to the depot of the Pennsylvania Railroad Company on the west bank of the Schuylkill—presents both interiorly and exteriorly a blaze of light. The array of dynamo-machines is remarkably complete. Edison leads the way with a variety of machines, including one "Jumbo," of the same type as, but rather smaller than, the pair of machines in use at the Holborn Viaduct lighting station. There are also a large number of Weston's machines, and a very valuable exhibit by the Thomson-Houston Company. The machines of the latter company are quite unique amongst dynamos; one of them can maintain sixty arc lights on one circuit, though there are but three coils on its armature. Other dynamos are shown by Ball, Hockhausen, Van Depoele, and McTighe. There are several excellent arc lamps, possessing novelty, however, in matters of detail only. A great show of incandescent lamps is made by the Edison Company, and also by the Weston Company. The latter has some remarkable lamps with filaments sixteen inches in length prepared from a new parchment-like substance, of which samples are shown. These lamps are from 100 to 200 reputed candle power.

Electric motors are exhibited by several inventors.



The little Grisco motor and the Cleveland motor are of course present, driving sewing-machines and fans. Edison contributes also some small motors of excellent finish. Amongst larger machines there is one by Daft and one by Elihu Thomson. But by far the most important of all exhibits of this class is that of Mr. F. J. Sprague, which shows a very great advance on anything hitherto accomplished. Mr. Sprague appears to have succeeded in producing a motor which runs at a uniform speed whatever its load. It is employed in driving a small loom.

In telephones there is not much new. The Clay Telephone Company exhibits its system, with a remarkably simple and efficient receiving instrument. Beyond this there is absolutely nothing new. The chief interest centres on the historic exhibitions of Elisha Gray, Graham Bell, A. E. Dolbear, and Van der Weyde. The remarkable telephones of Daniel Drawbaugh are not yet exhibited to public gaze on account of pending legal proceedings.

In telegraphy the sole novelty is the marvellous multiplex telegraph of Delaney, based upon the principle of La Cour's "phonic wheel," and capable of transmitting seventy separate messages simultaneously through a single wire.

Passing on to other exhibits, it should be mentioned how Messrs. J. W. Queen and Co. display a very large collection of imported apparatus, including the finest instruments of Elliott Brothers, Carpentier, Breguet, Hartmann, and Edelmann. Some excellent measuring-instruments by the Electric Apparatus Company of Troy, N.Y., are also shown. A collection of a curious and instructive nature was exhibited by the U.S. Patent Office, consisting of the historic models sent by inventors. Here may be seen the original Edison telephone, the original Brush dynamo, the original Edison lamp, and many other similar objects, including many old forms of electric motor dating from the years 1840-50. A special effort has also been made to get together a complete modern library of books bearing on the science of electricity. Some six thousand volumes have in this manner been procured, and form a valuable collection.

The Franklin Institute of Philadelphia, which has organised this Exhibition, must be congratulated on the energy and enterprise which it has put forth. It would be impossible to get together a collection of apparatus more thoroughly representative of the solid progress made in electro-technics on the American continent. Though the Exhibition is yet far from complete, it has become much more so since its opening on September 2. It will remain open until October 11.

#### A NEW APPLICATION OF INDIA-RUBBER<sup>1</sup>

IF iron takes the lead among articles of modern industry in the extent and number of its applications, it yet falls short of india-rubber in their variety. This latter article, indeed, promises soon to attain a universal diffusion. Its industrial career, though little more than just begun, already outstrips that of most substances that were first in the field.

The mere enumeration of its qualities would suffice to account for the diversity of its applications. It possesses so great an elasticity that by this quality alone it adapts itself to a thousand different uses—brace-bands, garters, sides of boots, &c.

Observe how, if not the lightest, india-rubber is at least the most powerful reservoir of mechanical energy known. It lends itself most readily to the restitution, under the form of mechanical labour, of the energy imparted to it by tension, and this restitution may be effected with remarkable quickness. It is owing to the relative lightness of india-rubber considered as an accumulator of energy, and, above all, to its power, that the exactness of the

<sup>1</sup> From *La Nature*.

principle of "heavier than air" may be demonstrated on a small scale.

From an electrical point of view, india-rubber acts as a better insulator than gutta-percha, and is, indeed, one of the best insulating bodies known. At the same time that its specific inductive capacity is weaker than that of gutta-percha, it does not become plastic at a moderate temperature. These properties render it an excellent insulator in electrical applications: submarine and subterranean telegraphy, electric light, transmission of force, &c. While it insulates better than gutta-percha, the conductor, where india-rubber is used, does not run the risk of being put out of centre, as is the case sometimes with gutta-percha.

India-rubber is known to oxidise under exposure to air and light; above all, under alternations of dryness and damp. By subjecting it, however, to a special operation, called vulcanisation, a product is obtained which main-



FIG. 1.—Position in which household utensils furnished with india-rubber may be placed without falling.

tains its flexibility at low temperatures, resists heat much better, does not oxidise in air, and absorbs less water. It is especially under the form of vulcanised india-rubber that its applications are numerous.

There is, finally, a third form of india-rubber, no less useful, that of ebonite, or hardened india-rubber, a form which combines with its lightness and great electrical resistance, the further advantage of resisting acids, and which is therefore exclusively employed when vessels for the electric pile or other reservoirs of a light and not readily brittle character are wanted. Like a new Proteus, india-rubber is thus seen to adjust itself to the ever more numerous and pressing demands of modern industry.

To turn now to the new, curious, and original application an idea of which it is the object of this notice to convey. The aim of the inventor, whose name unfortunately has not reached us, has been to take advantage of the great mutual adherence of a soft and a hard body. It is by the utilisation of this relation that the inventor has originated quite a series of household objects in earthen-

ware, porcelain, glass, &c., which manifest a remarkable adherence to the body supporting them, and this result he has obtained by the very simple expedient of securing to the lower part of all kinds of goblet objects (Fig. 2) a groove, AA, in the form of a swallow-tail, into which is lodged a band of red india-rubber, a variety of vulcanised india-rubber, forming, when deposited, a kind of circular cushion. Objects furnished in this manner are almost incapable of falling from their places. They may be placed on a wooden table, and the table be inclined (Fig. 1) from 45 to 50 or even 60 degrees without upsetting any of them. The most direct and immediate use offered by the properties which a vessel so provided with india-rubber thus acquires is evidently in the shipping service. At the Fisheries Exhibition of last year in London, and at the Health Exhibition of this year, the inventor has displayed a little barque, the bridge of which is entirely covered with dishes, plates, &c., all furnished in the manner described, and the barque, floating in a basin, may be

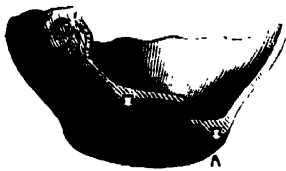

2.—Arrangement of the india-rubber covering in a swallow-tail AA, provided at the base of the object.

tossed to and fro in every direction without displacing a single piece.

All who have been on long voyages at sea know the disagreeable and painful impression produced by the screen of cord laid along the table to prevent the glasses and bottles from falling.

As an accessory advantage possessed by the undisplaceable india-rubber dishes may be reckoned the less noise they occasion, and the less risk of breaking they run on being clapped down carelessly or hastily on the table. Washhand basins and water-pots may likewise be advantageously constructed with the india-rubber band.

Invalids in bed, and compelled to eat from a board placed more or less horizontally across the bed, and children, so apt to upset glasses and bottles, will both find their advantage in the undisplaceable contrivance. We have thus a simple, ingenious, and useful application of india-rubber, which we thought it incumbent on us to place before our readers.

#### NOTES

In the Daily Weather Report of the Meteorological Office for Friday last, there appears a note of some importance on the temperature of the Gulf Stream. A comparison has been made between returns from 28 ships, containing 116 recent observations, with the data in the charts of the Atlantic sea-surface temperature (recently published by the Office), of the area which lies, roughly speaking, between the latitudes of the North of Ireland and of Bordeaux respectively, and extending half way across the Atlantic. It appears from this comparison that during the past summer the ocean temperature in the course of the Gulf Stream was abnormally high, in June the whole of the above-mentioned area being about  $3^{\circ}$  above the mean, in July the half of the area nearest to the British Isles being about  $1^{\circ}5$  and in August about  $1^{\circ}$  higher than the mean. It is to be hoped that similar comparisons will from time to time be given by the Meteorological Office, so that the point may be investigated which was long ago suggested by the late General Sabine, as to there being possibly a connection between the temperature of the tropical and sub-tropical waters of the Atlantic and the

weather of Europe which followed, and to which we drew attention some years ago (NATURE, vol. xxi. p. 142).

SIR WILLIAM THOMSON lectured on Monday night, under the auspices of the Franklin Institute, at the Academy of Music, Philadelphia, on the "Wave Theory of Light," to a large audience.

GEN. PITT-RIVERS, as Inspector of Ancient Monuments, has issued a very careful and detailed report on his excavations in the Fen Pits, near Penselwood, Somerset. These pits are on the borders of Wilts, Somerset, and Dorset, and consist of a number of hollows in the surface of the ground of various forms and sizes, without order or regularity in their distribution. They cover a tract of high land of greensand formation, the area thus originally covered having been estimated at 700 acres. Various conjectures have been made by antiquaries as to their use, some maintaining that the pits are the remains of a great British city, or formidable series of fortifications; if so, as Gen. Pitt-Rivers points out, it would upset all our conclusions as to the social and political condition of the Britons, and of the extent of the pre-Roman population of these islands. Last autumn Gen. Pitt-Rivers carried out a series of excavations, cutting a section right across the pits in the parts most likely to yield remains of any possible inhabitants. Not a bit of pottery the size of a pea, he tells us, was found, and no indication whatever that these pits have ever been used as habitations. Ample evidence, however, was found that the pits were used as quarries, from which the inhabitants obtained grind-stones or quern-stones. The remains of quern-stones were found, all bearing marks of having been tool-dressed, and in the villages around many such stones are met with, all of them stated to have been obtained from the pits. It is to be hoped that the very careful piece of work thus performed by Gen. Pitt-Rivers, and his report, will set the question permanently at rest. Several plates of sections, plans, &c., accompany the report.

A COMMISSION of five French medical men have reported on their investigations as to the real nature and action of the cholera poison. The substance of their report as it appears in the *Times* is as follows:—"The initial lesion of cholera takes place in the blood. It essentially consists in the softening of the hæmoglobin, which makes some globules lose first their clear shape, the fixity of their form, and the faculty of being indented. Those globules adhere together, lengthen out—*en olive*—stick together, and in fulminating cases especially some are seen which are quite abnormal, while others appear quite healthy. The entire loss of elasticity of the globule (which is shown by the preservation of the elliptic form when it has been stretched out) is, in our view, a certain sign of the patient's death. To stretch out a globule you have merely to alter the inclination of a plate on which a sanguineous current has been established in the field of the microscope. The fluid column stops at one point, whereas the rest continues to flow. An elongation of the intermediary globules results, and then a rupture of the column. In the gap thus formed are some scattered globules. If these revert to their primitive form, the patient may recover. If they keep the elliptic form, we have seen death follow in every case, even if the patient's symptoms were not serious at the time of the examination of the blood."

EDUCATION in British Burmah appears to be in a sad condition. According to a correspondent of *Allen's India Mail*, the province has not yet produced any student capable of attaining the B.A. degree, and only five or six have succeeded in passing the first examination in Arts. There is no local school of medicine, and such native medicine as exists is a compound of empiricism and a belief in charms and enchantments; while the principal legal authority has repeatedly deplored the gross

ignorance of law exhibited by both advocates and judges. The Viceroy himself complained of the slowness of the official department in respect to female education. A change, however, appears to have been made by the Government of India, which has authorised the establishment of a College, though not yet of a University. Until 1881 the control of education in British Burmah was purely administrative, being vested in a Government department; but Lord Ripon decided to create a controlling body something like the London School Board, except that its members will be nominated, not elected. The rights of the missionaries, who appear to have been the pioneers of education in the province, as well as of the Burmese themselves, were recognised, and they are represented on the new governing body. The labours of the Board so far have been very successful. It created a law school and a free library; it has organised and simplified all public examinations, and has promoted a movement amongst the wealthy natives for endowing scholarships for the higher branches of education and for the promotion of learning generally. This is all very promising; but, according to the correspondent whom we have quoted, there is a slight rift in the lute in the shape of the hostility of the local officials to the acts and even to the existence of the Board. Bureaucratic prejudice, however, can hardly hinder effectually the work of a council established on such a broad basis as this one is, backed as it also is by the authority of the Government of India.

THE Health Exhibition in connection with the Autumn Congress of the Sanitary Institute of Great Britain was opened at Dublin on Tuesday by the Lord Mayor. The inaugural address to the members of the Institute was delivered in the evening by the President, Sir Robert Rawlinson. He observed that in our own days one of the greatest works to be accomplished is to stem the torrent of sanitary ignorance now working so much mischief. Quarantine, as now practised, works at enormous money cost as well as incalculable inconvenience, and produces much misery without preventing the effects intended to be warded off. Sir Robert Rawlinson referred to the conditions under which cholera has so long afflicted India and China, partly arising from bad or insufficient food, impure water, and defective sanitary arrangements. Turning to England, he spoke of its temperate climate, pure atmosphere, and soil almost entirely free from malaria; but we have much to be ashamed of, and much to amend, in our social economy. Commenting on cholera generally, he said that occasionally it is epidemic we know. That it is contagious in the sense imagined by the ignorant experience does not prove. The President then pointed out the connection between disease and the want of good sanitary arrangements in various countries, and showed the importance of pure air, good food, pure water supply, and efficient drainage and sewerage, putting forward practical suggestions for sanitary engineers.

MAJOR SERPA PINTO, the Portuguese traveller, will leave Mozambique very shortly at the head of an expedition in order to explore the country between Mozambique and Lake Nyassa. The route to be taken is kept secret, but it is rumoured that he will proceed to the Congo, *via* Lake Tanganyika. The expedition, which is now being fitted out, will be on a large scale. It will comprise one hundred Inhambane Zulus as a body-guard, and two hundred and fifty carriers, and will be accompanied by a Portuguese naval lieutenant and an English photographic artist.

THE death is announced from Bangkok of Mr. Henry Alabaster, the most eminent European servant of the Siamese Government. Besides various political services, Mr. Alabaster, who had been at one time in the British Consular Service, played an important part in the great advances recently made by

Siam. He introduced and established the telegraph and telephone in the country, collected a valuable European library for the palace, and originated the museum and the botanic gardens at Bangkok.

INTELLIGENCE has been received at Mozambique of the death, on August 16, of Capt. Foot, British Consul in the districts adjacent to Lake Nyassa. Capt. Foot has done some good exploring work in the Nyassa region.

THE Annual Exhibition of the Photographic Society opens at the Gallery in Pall Mall on Monday next.

A RED glow, similar to those of last year, was seen in the western sky at Berlin on September 13 at 6.45 p.m., viz. half an hour after sunset. It reached to a height of about 20° above the horizon, the colour, being red to violet, which changed into a deep yellow near the horizon. Some measurements of the visible diameter was made by an observer, who discovered that the glow was limited by a spherical segment 20° in height, and with an extension towards the horizon of 35°. The centre of the segment coincided exactly with that of the sun below the horizon, which was then 78° west of the true north.

THE first news has been received from Lieut. Wissmann, leader of the expedition for the exploration of the Kasai. In a letter from Malange, dated August 25, he writes: "I am at last so far that I can say I leave this place to-morrow." Till then he had been merely making preparations.

A RECENT issue of the *Ceylon Government Gazette* contains a correspondence on the "grub" which ravages the coffee plantations of the island. The principal, and in fact only important, document in the publication is a lengthy report by Mr. R. McLachlan on the subject. Some forty species of beetles were submitted to him, but special interest centred in twenty of these, all or nearly all of which were allied to the *Melolontha vulgaris*, or common European cockchafer. Mr. McLachlan assumes that no undergrowth of grass or other herbaceous plants is allowed in the plantations, for the grubs of the European cockchafer and its allies feed on the roots of such plants, and not as a rule on those of trees and shrubs. But the larvae would make their way from the roots of the weeds to those of the coffee plant. Whether hardening the surface of the ground around the plant so as to render it difficult for the female to deposit her eggs would be of any efficacy, is a point for the planters to decide for themselves in view of the welfare of the plant at the time. Mr. McLachlan professes himself unable to suggest any chemical poison for the grub, although he thinks that dilute kerosene oil might be tried. He advises, "above all things," to encourage insectivorous birds to the fullest possible extent, and adds that a flock of crows probably destroy more grubs in an hour than would be possible by any artificial means in a week; the systematic catching of the perfect insect or larva is also suggested as beneficial, and hand-picking should be resorted to where labour is cheap. Finally, he thinks it highly desirable that the Planters' Association or the Ceylon Government should establish an experimental plantation of a few acres, in which the natural history of the various kinds of grub, and the effect of the various supposed or real remedies, could be carefully watched.

A NEW development of telegraphy has been instituted by Michela in Italy: he has constructed a machine by which signs corresponding to various sounds can be telegraphed; thus we have practically a telegraphic shorthand to which the name "steno-telegraphy" is given. Michela's apparatus has now been in regular use for some period in telegraphing the debates of the Italian Senate. The transmitting apparatus briefly consists of two series of ten keys, each of which corresponds to some particular sound. Each key acts in reality like a Morse key, and thus transmits a current to the receiving instrument. The

receiving instrument consists of a combination of twenty Morse receivers, to each of which is attached a style which marks on the receiving paper its proper sign, thus producing a stenographic message. Great speed in transmitting is claimed for this method, and the following figures are given as comparative :—

Morse simple ... ..	500 words per hour
Hughes simple ... ..	1,200 " "
Wheatstone ... ..	1,800 " "
Steno-telegraphic ... ..	10,000 " "

A MEDICAL student, M. J. Ol-en, who has been engaged during the summer in studying the fungoid flora in the neighbourhood of Bergen (Norway), has found on Ask Island a specimen of the remarkable *Tricholoma colossium*. It is the first time it has been found in Norway, and it has only once been found in Sweden. The stem is 2½ inches in diameter. Prof. Elis Fries in describing this variety says: "I discovered this unique variety for the first time among branches of spruce lying on the ground in a place near the Tem Lake in Småland (Sweden). It is the largest and finest of the hitherto discovered mushrooms."

THE thirteenth annual *conversazione* of the Chester Society of Natural Science was held in the Town Hall on September 25, and was attended not only by the members, but by a contingent of the Iron and Steel Institute, who have been holding their annual meeting in the Cestrian city. The Kingsley Memorial Medal was awarded to Mr. A. O. Walker, F.L.S., and Kingsley Memorial prizes were given for local natural history collections. It was announced that a prize of 10*l.* would be given in 1885 for the best collection of coal-measure fossil plants from the Society's district, a similar sum in 1886 for the best collection of "Bees and Wasps" from the same area, and in 1887 "for the best Essay on the Physiography of the Society's District, on the lines of Prof. Huxley's Physiography;" the district in question being Flint and Denbigh, with as much of the county of Cheshire as lies west of a line drawn south from Warrington. The exhibition of microscopic objects was, as is usually the case at Chester, exceedingly good, and for teaching purposes they were rendered more useful by the publication by the Society of a little handbook of twenty-eight pages, on Natural History, for use in the annual *conversazioni* and other meetings of the Society. It is drawn up by Mr. C. F. Fish, and appears to be an expansion of the useful programme, on which we commented last year. The information as to the classification and structures of the lower orders of life, both animal and vegetable, appear to be very carefully done, and are very concise. The work could be made much more useful by expanding the geological and physical portions: it is published at a few pence.

DR. GEORG SCHWEINFURTH has left Berlin to return to Egypt, whence he intends to start upon a new scientific exploring tour through the desert.

ON September 18 the meeting of German naturalists was opened at Magdeburg, under the presidency of Dr. Gachde. Over a thousand men of science were present. Strasburg was fixed upon as next year's meeting-place, with Profs. Kussmaul and De Bary as secretaries. Among the addresses delivered we may mention:—On the relation of micro-organisms to the infectious diseases of man, by Prof. Rosenbach (Göttingen); on the importance of German colonisation in Africa, by Dr. Gerhard Rohlfs; various medical addresses by Drs. Schwarz (Cologne), Paetz (Alt-Scherbitz), Finkler (Bonn), and Prior.

THE death is announced near Sydney of James Snowdon Calvert, the last survivor of Leichhardt's Australian exploring expedition.

A TELEPHONE now transmits, by the ordinary telegraph wire, the music from the Brussels Opera House to the Royal Châlet at

Ostend. The system, of course, is Van Rysselberghe's, mentioned in our last number.

THE late Dr. Ferd. von Hochstetter's travelling reports, dating from the celebrated *Novara* Expedition (1857-59), are now being published in book form, upon the occasion of the twenty-fifth anniversary of the *Novara's* safe return to Trieste. The book will contain a portrait of the author, a preface by V. von Haardt, and a map of the course of the *Novara*. Hölzel of Vienna is the publisher.

M. CHARLES HUBER, who was travelling in the interior of Arabia in the service of the French Ministre de l'Instruction Publique (formerly together with Prof. Euting of Strasburg) has been murdered near Labegh (Rabegh?) by Bedouins of the Harl tribe. His Arabian servant Mahmoud has met the same fate.

NEWS has been received from Capt. Adrian Jacobsen, now travelling in Northern Asia, by order of the Berlin Ethnological Museum with a view of making ethnographical collections. Capt. Jacobsen, after leaving St. Petersburg, visited Kasan, Ekaterinburg, and Tomsk, and has already sent home two large cases containing ethnographical objects collected among the uncivilised Russian tribes of the Tscheremiss, and Tschurnasch, and Wotjaks.

REFERING to our note of last week on Mr. St. Clair's "Note on a Possible Source of Error in Photographing Blood Corpuscles," the author writes to say that "in Dr. Norris's photographs where the colourless disks are well defined, the dark ones are out of focus." But it has not been shown possible to produce the ghosts while the real images are at all visible, and until this is done we must adhere to the opinion we have already expressed.

THE additions to the Zoological Society's Gardens during the past week include a Toque Monkey (*Macacus pilatus* ♂) from India, presented by Mrs. Batchelder; a Common Marmoset (*Leontideus jacchus* ♂) from Brazil, presented by Mr. W. E. Steinscher; six Great Bats (*Vesperugo noctula*), British, presented by Mr. W. Atkinson; two King Parrakeets (*Aprosmictus scapularis*), two Cockateels (*Catopsitta novæ-hollandiæ*) from Australia, presented by Mrs. C. Price; two Spanish Terrapins (*Clemmys trjuga*), South European, presented by Mr. W. H. J. Paterson; a Common Viper (*Vipera berus*), British, a Viperine Snake (*Tropidonotus viperrinus*) from West Africa, presented by Mr. William Cross; a Common Snake (*Tropidonotus natrix*), a Common Viper (*Vipera berus*), British, presented by Mr. W. H. B. Pain; a White-breasted Kingfisher (*Halcyon smyrnensis*) from India, two Reed Buntings (*Emberiza schanickulus*), a Blackcap (*Sylvia atricapilla*), a Pied Wagtail (*Motacilla lugubris*), British, a Tree Boa (*Corallus hortulans*) from Cuba, purchased.

#### OUR ASTRONOMICAL COLUMN

COMET 1884 b (BARNARD, JULY 16).—Dr. Berberich of Strasburg, who has investigated the elements of this comet from observations extending to September 14, has found an elliptical orbit, in which the period is only 5½ years, a result which will perhaps have been rather expected, considering the nature of the parabolic orbits previously calculated, and, as was pointed out by Prof. Weiss, their resemblance to the elements of De Vico's comet of short period observed in 1844. Dr. Berberich's ellipse is as follows:—

Perihelion passage, 1884, August 16·48346 Greenwich M. T.

Longitude of perihelion ... ..	306 7 31"1	} Mean
" ascending node ... ..	5 3 50"2	
Inclination ... ..	5 28 49"6	
Angle of eccentricity ... ..	36 3 43"8	
Log. semi-axis major ... ..	0·493392	
Period of revolution ... ..	2007·9 days or 5·4965 years	

At aphelion in this orbit the comet would be distant from the orbit of Jupiter 0'503, but there is a very much closer approach to the orbit of Mars, at a true anomaly of  $37^{\circ} 13'$ , corresponding to heliocentric longitude  $343^{\circ} 25'$ , where the distance of the two orbits is only 0'0088, and it is worthy of note that between April 5 and 10, 1868, both Mars and the comet would pass that point, and if Dr. Berberich's period is approximately correct, there must have been a close approach of the two bodies, possibly a closer one than calculation assigns. The following positions are deduced from the elliptical orbit:—

		At Berlin, Midnight			Decl.	Log. Distance from Earth.
		R.A.				
		h.	m.	s.		
October	5	...	20	33 51	...	- 22 30'1 ... 9'8331
	9	...	20	46 54	...	21 2'5 ... 9'8536
	13	...	20	59 26	...	19 35'6 ... 9'8746
	17	...	21	11 28	...	18 10'0 ... 9'8960
	21	...	21	23 4	...	16 45'9 ... 9'9175
	25	...	21	34 14	...	15 23 5 ... 9'9391
	29	...	21	45 1	...	- 14 2'9 ... 9'9608

The comet is rapidly growing fainter, but it is obviously of importance for its theory that observations should be continued as long as possible.

COMET 1884 c.—A new comet was discovered by Herr Wolf at Heidelberg on September 17, and was observed at Strasburg on September 20. It was also independently detected by Dr. Copeland at Dun Echt on September 22, the night before the telegraphic notice from Kiel arrived at that Observatory. Prof. Tacchini has favoured us with the following observations made by himself and Prof. Millosevich at the Observatory of the Collegio Romano in Rome:—

		Rome M.T.			R.A.			Decl.
		h.	m.	s.	h.	m.	s.	
Sept.	21	...	9	24 47	...	21 15 46'00	...	+ 21 59 22'6
	23	...	7	30 12	...	21 16 44'33	...	+ 21 7 48'7

This comet is likely to remain visible for several months, according to the orbits yet calculated, but a somewhat wider extent of observation than is now available will be required to predict its track in the heavens with any degree of certainty.

THE LUNAR ECLIPSE ON OCTOBER 4.—We gave last week the times of occultations of two stars during the totality of this eclipse, of which accurate positions are found in our catalogues. A somewhat extensive list of stars liable to occultation has been determined at Pulkowa with sufficient precision for the predictions of the times of immersion and emersion, which have been communicated to various observatories. Several stars rated higher than the ninth magnitude appear on this list, where the *Durchmusterung* magnitudes are followed. Our remark last week should have been explained as referring only to stars of which accurate places are found in the catalogues.

### HYDROXYLAMINE AND THE ASSIMILATION OF NITROGEN BY PLANTS

THE researches of V. Meyer and E. Schulze on the action of hydroxylamine salts upon plants (*Berl. Ber.*, xvii, 1554) were undertaken with the *a priori* probability of showing that this base plays an important part in the synthetical activity of the plant; and although they have not succeeded in establishing the experimental fact, the results obtained are of great interest, and the whole is eminently suggestive of future possibilities. The supply of nitrogen to plants takes the form of nitrates and ammoniacal salts, and these classes of compounds being destitute of synthetical activity, we are driven to assume that the earlier stages of nitrogen assimilation consist in the conversion of these comparatively inert substances into derivatives having the "chemical tension" necessary to synthetic activity. Hydroxylamine and its salts, which occupy in point of oxidation a position intermediate between ammonia and the nitrates, are bodies possessing this character in the highest degree. To use the author's words, "the behaviour of this base towards the organic oxy-compounds is most aggressive; it is indeed astonishing with what facility it converts carbonyl-compounds into azotised derivatives." This is notably the case with the ketones and aldehydes of the fatty series, the products of the union being oximido-derivatives, e.g. aldioxime, acetoxime, isonitroso acids; in these the characteristic C=NO<sub>2</sub> group easily undergoes reduction, with formation of the corresponding amido derivatives; and upon the hypothesis of the formation of hydroxylamine in the plant as the first stage in nitrogen assimilation, it is easy to see

in what manner its non-nitrogenous constituents, which for the most part possess the characteristics of aldehydes and ketones, would contribute to the further stages in its elaboration.

To test this hypothesis, in the first instance, the authors instituted parallel experiments on the culture of maize, to which the nitrogen was supplied in the form of ammonium sulphate, hydroxylamine sulphate, and hydrochlorate and potassium nitrate, respectively. The result was, in a word, to show that the hydroxylamine salts act as direct poisons to plant life, as indeed they have already been shown by Bertoni to act towards animal life. Having established this fact, the authors inferred their probable action as antiseptics, and experiment showed that they possess this property in a remarkable degree. This result, as they contend, does not negative the original hypothesis, as the occurrence of the base in the plant would necessarily be transitional.

It seems to us that the antiseptic properties of hydroxylamine are a dire consequence of its synthetical activity; and further that antiseptics fall into three classes according to their disturbance of one of the three essential conditions of cell life, which are: (1) hydration; (2) oxidation; (3) the synthetical activity of aldehydes (Löw and Bokorny), chiefly in the direction of condensation. In illustration of this classification we may cite as typical members of group (1) common salt, (2) sulphurous acid in its various combinations, (3) phenols.

### THE BRITISH ASSOCIATION REPORTS

Second Report of the Committee, consisting of Prof. A. W. Williamson, Chairman, Profs. Sir H. E. Ruscoe, Dewar, Frankland, Crum-Brown, Odling, and Armstrong, Messrs. A. Vernon-Harcourt, J. Millar Thomson, V. H. Veley, F. Japh, H. Forster Morley, and H. B. Dixon (Secretary), appointed for the purpose of drawing up a Statement of the Varieties of "Chemical Names" which have come into use, for indicating the causes which have led to their adoption, and for considering what can be done to bring about some convergence of the Views on Chemical Nomenclature obtaining among English and Foreign Chemists.—The Report is somewhat lengthy, and includes some long tables of varieties of names for common chemical substances. It commences with historical notes on chemical nomenclature. No attempt was made until about 100 years ago to name chemical substances in a way which would indicate their composition; alchemistic or "culinary" names being given to substances in many cases. Macquer is credited with being the first to introduce generic names like vitriol and nitre to indicate sulphates and nitrates. The term salt was used to indicate almost any substance soluble in water and affecting the sense of taste, and in the eighteenth century acids, salts, and bases began to be distinguished. Rouelle was the first to define a salt from its chemical properties, and distinguish it from acids and bases (see Kopp's "History of Chemistry," iii.). Bergmann and Guyton de Mousseau separately proposed systems of nomenclature, many terms of which are still in use. De Mousseau made the terminations of names of acids uniform, and the names of salts to indicate their composition from bases and acids. In 1787 Lavoisier, De Mousseau, Berthollet, and Fourcroy prepared a scheme of naming compounds which is practically that in common use now, introducing the terminations "ate" and "ic," "ite" and "ous," in acids and salts. But higher and lower oxide are not distinguished by generic names. Berzelius made a more elaborate classification of salts, and added some names. He distinguished the halogen compounds of hydrogen as hydracids, and distinguished clearly between "neutral," "acid," and "basic" salts. The views now held of acids, salts, and bases are practically those of Gerhardt and Laurent, who first recognised the part played by hydrogen in acids and salts. The Report then goes on to consider the tables, which give the number of times a substance has been distinguished by any particular name. Table I. deals with the names of oxides of carbon from 1755 to 1882. By far the greater number of sources give the names carbonic oxide to CO and carbonic acid to CO<sub>2</sub>; systematic names like carbonous oxide and carbonic oxide only occurring two or three times, the terms carbonic oxide and carbonic anhydride or dioxide being next in frequency. In France and Germany the names oxide de carbon and acide carbonique, Kohlenoxyd and Kohlensäure have been much more frequently used. But in several instances the same names have been used in a different sense; the term carbonic oxide being some-

times used for  $\text{CO}_2$ , sometimes for  $\text{CO}$ . In Table II. the prominence of this "diversity of names for the one thing," and giving the same name to distinct substances, is more frequent. The use of numerical prefixes has also been very irregular; "thus, trisodic phosphate has been called 'triphosphate of soda,' 'diphosphate of soda,' and 'sesquiphosphate of soda'; in all these cases the prefix is intended to indicate the number of molecules of soda to one molecule of phosphoric acid." "In some of the older forms of nomenclature ambiguity was avoided by using the prefix 'bi-' to multiply the acid when in excess over the base, and 'di-' to multiply the base when in excess over the acid; thus,  $\text{Na}_2\text{O}_2\text{SiO}_2$ , bisilicate of soda,  $2\text{Na}_2\text{O}\cdot\text{SiO}_2$ , disilicate of soda." The Report goes on to say that "the usefulness of any system of nomenclature depends on its permanence." Curiously enough the tables show that where names have been adopted supposed to represent in some way the chemical constitution of bodies, they have not, as a rule, endured; the advance of knowledge necessitating a change of opinion, whilst names not expressing a chemical opinion as to constitution have endured. "As a rule, those names are to be preferred which have shown most vitality and have led to no ambiguity. Where there are two compounds composed of the same elements, the termination: 'ous' and 'ic' should be employed. The prefixes 'proto' and 'deuto,' introduced by Thomas Thomson, were intended to mark the compounds in a series, not the number of atoms in a molecule. Where retained this use only should be made of them." Referring to change of name, instance is made of the oxides of carbon, the names of which have recently to some extent been transposed, the higher one being termed "carbonic oxide," and the lower one, to which the term "carbonic oxide" has long been applied, has had a new name. The sensible conclusion of the Report is to retain names of substances which are in common use, rather than to change them for names indicating constitution, and which might be again found to require alteration in accordance with some new view of the constitution of the substance.

#### SECTION B—CHEMISTRY

At the meeting of the Chemical Section at Montreal a new departure was made in the selection by the Organising Committee of two subjects for special discussion. The subjects chosen were: "The Constitution of the Elements," and "Chemical Changes in their Relation to Micro-Organisms."

##### *Discussion on "The Constitution of the Elements"*

Prof. Dewar began by referring to Grove's discovery that water suffered decomposition at the temperature of the oxy-hydrogen flame, an experiment which led Sainte-Claire Deville to undertake his researches on dissociation. Deville has shown that in compound substances there is an equilibrium between decomposition and recombination, this balanced relation changing with the temperature. The experiments of Deville on the temperature of burning gases agree closely with the results obtained by Bunsen, who determined the pressures generated in the explosion of hydrogen and other gases with oxygen. The breaking up of the iodine molecule, effected by Victor Meyer, is a decomposition of elementary matter. Owing to the rapid recombination, there seems no hope of isolating atomic iodine at low temperatures. The vapours of potassium and sodium have different densities at different temperatures; probably also their molecules consist of two atoms at lower, and of one atom at higher, temperatures. More exact determinations are needed of those substances which exhibit a variable vapour density. The evidence afforded by spectral analysis proves that oxygen and nitrogen have two spectra, and therefore probably different molecules at different temperatures. Hydrogen has a complicated spectrum under certain conditions. Referring to Mr. Lockyer's speculations, he said there was a general basis of similarity in the type of the vibrations of certain allied elements, viz. the triple lines in zinc and cadmium. Mr. Lockyer has proved that the identity of certain "basic" lines of different elements, such as iron and calcium, is not due to impurity, but the greater dispersion of more powerful instruments has shown that the coincidence of these lines is only apparent and not absolute. The differences observed in some of the spectral lines of a single element in the sun might be accounted for not by the decomposition of the "element" into simpler matter but by great differences of level in the luminous vapour. Prout's hypothesis, that the atomic weights of the other elements are

multiples of that of hydrogen, has no basis in experimental fact. Stas and Marignac have both returned in their old age to the re-determination of the atomic weights made by them twenty years ago. Stas, avoiding the possible sources of error in his former methods, has lately found 14.055 for the atomic weight of nitrogen; his old determinations gave 14.044. For potassium he now arrives at the number 39.142 instead of 39.137. Marignac gives the following as the atomic weights of zinc and magnesium, 65.33 and 24.37,—numbers very far removed from whole numbers.

Prof. Wolcott Gibbs drew the attention of the Section to the probability that what is generally regarded as a simple molecule, such as sodium chloride, consists in the solid state of several hundreds of atoms, and that the salt undergoes in solution a kind of molecular dissociation. Very complex molecules, such as those acids he had prepared containing many molecules of the oxides of molybdenum, vanadium, barium, &c. are probably derived by substitution from what are called simple molecules, but which are really composed of a great number of atoms.

Prof. Frankland said he ventured to differ from Prof. Dewar in one point. He thought it might not be impossible by a decomposition of compound molecules to prepare isolated iodine atoms.

Sir Lyon Playfair suggested as a useful line of work the determination of the conditions under which such bodies as nitric peroxide would enter into combination with other compounds.

Prof. Tilden pointed out that a large field lay open to workers in thermo-chemistry, on the one hand in determining the temperatures at which chemical action begins, and on the other the heat-changes of chemical combination and solution at different temperatures.

Rev. Father Perry agreed with Prof. Dewar that some differences in the solar lines were due to difference of level of the luminous vapour. But, on the other hand, the widening of solar lines in the umbra of spots cannot be accounted for in this way. The Astronomer-Royal and Mr. Lockyer have been studying the solar spectrum from the line D to F. The Rev. Father Perry (studying D towards B) has found differences in the lines of the same metal in different spots which could not be attributed to difference of level only.

Prof. Dewar, in answer to Father Perry, stated that the widening of certain lines at the red end of the spectrum might have been anticipated from the results of his own work in the crucible. The supposed allotropic spectrum of magnesium is due to a compound of magnesium and hydrogen. The fact that in the upper regions of the solar atmosphere, where hydrogen and magnesium occur in enormous quantities, this allotropic spectrum is not observed presents a difficulty. Perhaps at the mean temperature of the solar atmosphere this compound is dissociated. If so, somewhere nearer the surface or in the spots a condition of temperature should occur in which the compound should be stable. He hoped Father Perry would succeed in observing this spectrum in the umbra of spots. It had been stated that if our elements are compound substances they should be found decomposed at the enormously high temperatures of the sun; but if it is admitted that the elements are compounded of hydrogen, and that dissociation can occur, the compound vapour is diffused through an atmosphere of hydrogen, one of the products of its dissociation, and is therefore precisely under those conditions in which it is most stable.

##### *Discussion on "Chemical Changes in their Relation to Micro-Organisms"*

Prof. Frankland, in opening the discussion, distinguished between two kinds of chemical action—(1) that in which substances brought into contact mutually undergo chemical change, and (2) that in which chemical change is effected in one substance by contact with another, which itself apparently suffers no alteration. The following definitions were proposed to distinguish animal and vegetable organisms:—(1) A plant is an organism performing synthetical functions, or one in which these functions greatly predominate; it transforms actual into potential energy. (2) An animal is an organism performing analytical functions, or one in which these functions greatly predominate; it transforms potential into actual energy. All micro-organisms appear to belong to the second class. Oxidation is the essential condition of life. There are, however, many other chemical transformations in which potential becomes actual energy, and which therefore can support life. After de-

scribing the chemical changes produced by a large number of micro-organisms, the author concluded that there is no break in the continuity of chemical functions between micro-organisms and the higher forms of animal life. It is true there are apparently certain sharp distinctions between them. The enormous fecundity of micro-organisms and their tremendous appetites seem to separate them from the higher orders of animals. But this distinction is only comparative. It must be borne in mind that an animal like a sheep converts much of its food into carbonic acid, hippuric acid, and water, thus utilising nearly the whole of the potential energy, while the micro-organism as a rule utilises only a small portion. Those micro-organisms which have been chemically studied produce, like the higher animals, perfectly definite chemical changes. The position of these organisms in Nature is only just beginning to be appreciated. It may safely be predicted that there is no danger of their being spoiled by the petting of sentimentalists, yet these lowly organisms will receive much more attention in the future than they have done in the past.

Principal Dallinger referred to the attempted distinction between the lower animal and vegetable forms. In following out the life-history of certain monads he used a nutritive fluid containing no albuminoid substances, but only mineral salts and tartrate of ammonium. Organisms classed by Prof. Huxley as animal were found to live in this mineral fluid. Bacteria of forms which cannot be distinguished by the microscope have very different physiological functions. These Bacteria can be modified physiologically, but not at all readily morphologically; by a slow change it is possible to completely reverse the conditions of the environment of the Bacterium without changing its form. It is most important to study the physiology of Bacteria.

Dr. Macalister pointed out that the experiments made on the conversion of the Bacillus of the hay infusion into the *Bacillus anthracis* had not been confirmed by more exact experiments. The germs of the *Bacillus anthracis* readily diffused themselves through the air of the laboratory, and without the very greatest care it was impossible to avoid contamination of the liquids with stray germs.

Prof. Dewar referred to the extraordinary behaviour of very small quantities of peroxide of hydrogen on putrescible liquids. One-hundredth of a per cent. of the peroxide perfectly preserved many liquids, keeping them quite clear and without a trace of any Bacteria. The conversion of sugar into anhydrous alcohol and carbonic acid seemed to be unaccompanied by a thermal change, so that an important question arises, Where does the power which effects the change come from? Possibly, like chlorophyll, the Bacteria absorb rays of radiant heat and light. Dr. Engelmann has studied the distribution of radiant energy in the spectrum of the sun and flames by the activity of the Bacteria submitted to different parts of the spectrum.

Sir Lyon Playfair regarded it as curious that the products formed in the growth of the higher animals—namely, carbonic acid and urea—should be so much simpler than the products formed by lower organisms.

**Complex Inorganic Acids**, by Prof. Wolcott Gibbs.—This research may be regarded as a series of generalisations of the class of silico-tungstates discovered by Marignac in 1861, and of the analogous class of phospho-molybdates studied by Deville. Scheibler has described two distinct series of phospho-tungstates; the author finds there are at least ten, the highest having the formula  $24\text{WO}_3 \cdot \text{P}_2\text{O}_5 \cdot 6\text{H}_2\text{O}$ , the lowest the formula  $6\text{WO}_3 \cdot \text{P}_2\text{O}_5 \cdot 6\text{H}_2\text{O}$ , and that the phospho-molybdates are at least equally numerous, and have a similar range. Corresponding compounds containing arsenic oxide also exist. To generalise these results the author replaced phosphoric oxide by vanadic oxide and antimonio oxide, so as to form vanadico-tungstates and antimonio-tungstates, and the corresponding compounds of molybdenum. Many of these salts are very beautiful. Probably the greater number of oxides of the type  $\text{R}_2\text{O}_5$  form similar compounds. A second series of complex acids contain *two* molecules of the type  $\text{R}_2\text{O}_5$ , so that we have various phospho-vanadico-tungstates and phospho-vanadico-molybdates. The generalisation of the term  $\text{WO}_3$  or  $\text{MoO}_3$  appears also possible, as the author has prepared compounds in which sulphur and selenium replace oxygen in  $\text{WO}_3$  or  $\text{MoO}_3$ . Again, the author finds that phosphorous and hypophosphorous acids enter into similar combinations with tungstic and molybdic acids, and he has also prepared compounds in which the methyl, ethyl, and phenyl derivatives of phosphorous and hypophosphorous acids occur. An attempt to

prepare complex acids containing pyro-phosphoric acid failed, as that acid quickly changed to the ortho-acid; but with meta-phosphoric acid the author succeeded in preparing several new compounds. The author has further shown that the group  $\text{R}_2\text{O}_5$  may be replaced by  $\text{R}'_2\text{O}_5$ ,  $\text{R}''\text{Cl}_2$ — $\text{R}'$  being a metal of the platinum group—and that the chlorine can be replaced by bromine or iodine. The type of silico-tungstates is also capable of generalisation, silica being replaced by a large number of similar oxides, as, for instance, the oxides of selenium, tellurium, platinum, &c. As an instance of the extreme complexity of some of these compound acids, the author gave the body  $60\text{WO}_3 \cdot 3\text{P}_2\text{O}_5 \cdot \text{V}_2\text{O}_5 \cdot \text{VO}_2 \cdot 18\text{BaO} + 150\text{Ag}$ . This body has the enormous molecular weight of 20,066. In conclusion the author stated that in formulating certain compounds containing  $\text{V}_2\text{O}_5$  he found much similar expressions resulted when a part of the  $\text{V}_2\text{O}_5$  was supposed to have the structure  $(\text{V}_2\text{O}_5)_2\text{O}$ ,  $(\text{V}_2\text{O}_5)$  replacing  $\text{W}$  or  $\text{Mo}$ .

**On the Incomplete Combustion of Gases**, by H. B. Dixon.—The author gave a résumé of the work he had done in continuation of the researches of Bunsen, E. von Meyer, Horstmann, and other chemists, on the division of oxygen when exploded with excess of hydrogen and carbonic oxide. The following are the general conclusions arrived at:—(1) No alteration *per saltum* occurs in the ratio of the products of combustion. The experiments made completely confirm Horstmann's conclusion: Bunsen's earlier experiments are vitiated by the presence of aqueous vapour in the eudiometer. (2) A dry mixture of carbonic oxide and oxygen does not explode when an electric spark is passed through it. The union of carbonic oxide is effected indirectly by steam. A mere trace of steam renders the admixture of carbonic oxide and oxygen explosive. The steam undergoes a series of alternate reductions and oxidations acting as a "carrier of oxygen" to the carbonic oxide. With a very small quantity of steam the oxidation of carbonic oxide takes place slowly; as the quantity of steam is increased the rapidity of explosion increases. (3) When a mixture of dry carbonic oxide and hydrogen is exploded with a quantity of oxygen insufficient for complete combustion, the ratio of the carbonic acid to the steam formed depends upon the shape of the vessel and the pressure under which the gases are fired. By continually increasing the initial pressure a point is reached where no further increase in the pressure affects the products of the reaction. At and above this critical pressure the result was found to be independent of the length of the column of gases exploded. The larger the quantity of oxygen used, the lower the "critical pressure" was found to be. (4) When dry mixtures of carbonic oxide and hydrogen in varying proportions are exploded above their critical pressures with oxygen insufficient for complete combustion, an equilibrium is established between two opposite chemical changes represented by the equations:—

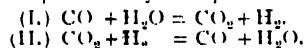

At the end of the reaction the product of the carbonic oxide and steam molecules is equal to the product of the carbonic acid and hydrogen molecules multiplied by a coefficient of affinity. This result agrees with Horstmann's conclusion. But Horstmann considers the coefficient to vary with the relative mass of oxygen taken. (5) A small difference in the initial temperature at which the gases are fired makes a considerable difference in the products of the reaction. This difference is due to the condensation of steam by the sides of the vessel during the explosion, and its consequent removal from the sphere of action during the chemical change. When the gases are exploded at an initial temperature, sufficiently high to prevent any condensation of steam during the progress of the reaction, the coefficient of affinity is found to be constant whatever the quantity of oxygen used—provided only the quantity of hydrogen is more than double the quantity of oxygen. (6) The presence of an inert gas, such as nitrogen, by diminishing the intensity of the reaction, favours the formation of carbonic acid in preference to steam. When the hydrogen taken is less than double the oxygen, the excess of oxygen cannot react with any of the three other gases present—carbonic oxide, carbonic acid, and steam, but has to wait until an equal volume of steam is reduced to hydrogen by the carbonic oxide. The excess of inert oxygen has the same effect as inert nitrogen in favouring the formation of carbonic acid. The variations in the coefficient of affinity found by Horstmann with different quantities of oxygen are due partly to this cause, but chiefly to the varying amounts of steam condensed by the cold eudiometer during the reaction in different experiments. (7) As a general

result of these experiments it is shown that, when a mixture of dry carbonic oxide and hydrogen is exploded with oxygen insufficient for complete combustion, at a temperature at which no condensation of steam can take place during the reaction, and at a temperature greater than the critical pressure, an equilibrium between two opposite chemical changes is established which is independent of the mass of oxygen taken, so long as this quantity is less than half the hydrogen. Within these limits the law of mass is completely verified for the gaseous system composed of carbonic oxide, carbonic acid, hydrogen, and steam at a high temperature.

*On Magnetic Rotation of Compounds in Relation to their Chemical Composition*, by W. H. Perkin, Ph.D., F.R.S.—The author gave a *résumé* of his researches on the magnetic rotary polarisation of compounds in relation to their chemical composition. After referring to the remarkable discovery of Faraday in relation to this subject, and the results obtained by more recent workers in this field, it was shown that no relationship in reference to chemical composition was likely to be found by the usual method of calculating the results of the observation of unit-lengths of the fluid bodies examined, but that, if lengths related to each other in proportion to their molecular weights—making the necessary correction for the difference of densities—were compared, a useful result would probably be obtained. Experiments have proved this to be the case; and in the series of homologous compounds it was found that for every addition of  $\text{CH}_2$  a definite increase of what is called the "molecular rotation" is obtained. Besides this it was found that the rotation also was capable of indicating differences in the construction of organic compounds. Iso, secondary, tertiary bodies give different results from the normal compounds. The compounds containing the halogens were also referred to, and formulæ given by which the molecular rotation of twenty-six series of compounds could be calculated.

*Spectroscopic Studies of Explosions*, by Profs. Liveing and Dewar.—The explosions observed were chiefly those of hydrogen and oxygen and of carbonic oxide and oxygen, and were made in an iron tube fitted with quartz ends. The spectra were both observed with the eye and photographed. Linings of thin sheet metal of various kinds were introduced into the tube. The metals iron, nickel, and cobalt gave many lines in the flash. No other metal gave anything like so many lines as these three, but magnesium gave the *b* group, copper gave one green and two ultra-violet lines, manganese the violet triplet, and chromium three triplets. On the other hand, zinc, cadmium, mercury, aluminium, bismuth, antimony, and arsenic developed no lines in the flash. It appears to be proved that iron, nickel, and cobalt are volatile in some degree at 3000°. It might be possible to establish a spectroscopic scale of temperature if the lines successively developed with increasing temperature were noted. Thus, the iron line T seems to be just developed at 3000°, the aluminium lines at H at a somewhat higher temperature, the lithium blue line may be just seen in the inner green cone of a Bunsen burner, while the green line comes out in the explosion flash. [The photographs of the explosion spectra were exhibited to the Section.]

*On Evaporation and Dissociation*, by Prof. William Ramsay and S. Young, D.Sc.—The authors described experiments made with the object of ascertaining whether the coincidence of the curves which represent the vapour-pressures of stable solid and liquid substances at different temperatures with those indicating the maximum temperatures attainable by the same substances at different pressures, when evaporating with a free surface, holds good also for substances which dissociate in their passage to the gaseous state. The substances examined were chloral hydrate, ammonium carbamate, phthalic acid, succinic acid, aldehyde ammonia, ammonium chloride, nitric peroxide, and acetic acid. It was found that, with chloral hydrate and ammonium carbamate, which cannot exist at all in the gaseous state, the temperatures of volatilisation do not form a curve. When the dissociation was considerable, but not complete, as in the case of phthalic and succinic acids, an indication of a curve was observed at low pressures, but it differed widely both in form and position from that representing the vapour-pressures or pressures of dissociation. As the dissociation increases the curves approach each other more closely, and they appear to be coincident in the case of ammonium chloride and nitric peroxide within the limits of temperature at which observations were made, and at which the amount of dissociation is probably small. With acetic acid very numerous observations proved the perfect coincidence of

the curves. The results appear to be unfavourable to the view that, when liquefaction of a stable substance takes place, gaseous molecules coalesce to form more complex groups of molecules, and that these complex molecules dissociate when the substance is vaporised.

*A Redetermination of the Atomic Weight of Cerium*, by H. Robinson, B.A. Cambridge.—Cerous chloride was prepared by passing hydrochloric acid over cerium oxalate at first gently heated and afterwards raised to redness. The solution of pure chloride was added to a pure solution of silver nitrate, and then dilute solution of silver nitrate was added from a weighed bulb, until the precipitation of chlorine was complete. The liquids were illuminated by yellow light only during the precipitation. As a mean of seven closely concordant results, the atomic weight of cerium is given as 140.2593, that of silver being 107.93.

*The Action of Sulphuretted Hydrogen on Silver*, by Prof. F. P. Dunnington, University of Virginia.—A piece of pure silver, flattened and carefully polished on each face, was placed in the middle of a glass tube two feet long. At each end of the tube a plug of five inches of phosphoric anhydride was confined by glass wool. Pure dry hydrogen was passed through this tube while it was gently heated throughout. The hydrogen was then removed by a Sprengel pump, the silver being heated to 30° C. This operation was repeated three times, and then pure dry sulphuretted hydrogen was slowly passed through the apparatus for an hour, and the tube finally drawn off at each end. After a few days the silver was slightly darkened near its edges, and after five months the silver was blackened on its edges, while the main portion of the surface was white and bright. [The silver was exhibited to the Section in this state.]

*On Molecular Volumes*, by Prof. W. Ramsay.—The object of this research was to ascertain whether, as has long been taken for granted, the boiling-point of compounds under equal pressures really afforded suitable points for a comparison of their molecular volumes. The experiments made with the following series of compounds—water, methyl alcohol, ethyl alcohol, propyl alcohol, isopropyl alcohol, isobutyl alcohol, and ether—prove that the value of the group  $\text{CH}_2$  is by no means constant. (1) While at the boiling-points of these liquids at low pressures the value is approximately constant (fluctuating between 17.5 and 22), at high temperatures the difference becomes much more marked, attaining at 20 m. of mercury pressure the greatest irregularity; e.g. the difference between the molecular volumes of ether and isobutyl alcohol, two isomeric substances, amounts to a total of twenty units. (2) It was found by experiment that when the liquids were at temperatures corresponding to equal vapour-pressure, but exposed to their critical pressures, no correspondence between their molecular volumes was observable. (3) It was thought possible that if the liquids, still at temperatures corresponding to equal vapour-pressure, could have existed under no pressure, some basis of comparison might be found. From the known compressibility of the liquids it was possible to calculate their volume in this hypothetical state. Although by this method their relative volumes were considerably altered, yet no point of comparison was reached. (4) The author therefore concludes that the boiling-points of liquids, under whatever pressure they may be taken, are not suitable temperatures at which to compare their molecular volumes.

*On Some Phenomena of Solution, Illustrated by the Case of Sodium Sulphate*, by Prof. W. A. Tilden, F.R.S.—The study of the solubility of sodium sulphate in water at temperatures above 100° C., leads to the conclusion that the salt dissolves in the anhydrous state. In order to determine whether this salt dissolves in water at lower temperatures in the anhydrous or the hydrated state, the author has made a series of calorimetric measurements of the thermal changes which attend the act of solution of  $\text{Na}_2\text{SO}_4$  in water at temperatures below and above 33° to 34°, the critical point in the curve of solubility.

*Calorimetric Effect of Dissolving  $\text{Na}_2\text{SO}_4$  in n Molecules of Water at T°*

n	T°	C
100	31.7	1740
100	35.4	1522
100	42.85	1342
100	46.1	1071
100	55.0	985

These figures establish the fact that by dissolving anhydrous sodium sulphate in water at temperatures above 33°, the thermal change is still positive, although a diminishing quantity, and



hence that the act of solution is still attended at these temperatures by chemical combination between the salt and the water. These results when plotted out give a line which is nearly parallel to the curve of solubility between these limits of temperature.

*On Calcium Sulphide and Sulpho-carbonate*, by V. H. Veley, M.A.—Calcium oxide, free from metals of the iron group, was obtained by heating perfectly transparent crystals of Iceland spar in a current of hydrogen. This oxide was hydrated in a damp atmosphere free from carbonic acid. The hydroxide was heated to 65° C., and hydric sulphide passed over it. The resulting calcium sulphide and water were weighed, and the synthetic results thus obtained were found to agree closely with the results of the analysis of the calcium sulphide. It is worthy of note that perfectly dry calcium oxide is unaltered by the passage over it of perfectly dry hydric sulphide, and generally the formation of calcium sulphide proceeded the more rapidly the greater the quantity of water originally present in the hydroxide. This result may be due to the formation, at first, either of the hydrosulphide, or the hydroxy-hydrosulphide (CaOH,SH), and the subsequent conversion of either of these substances into the sulphide. The calcium sulphide, prepared as described above, was moistened with water, and hydrogen saturated with carbon bisulphide passed through it. It gradually turned yellow, and finally red, and on exhaustion with cold water a red solution was obtained, from which, on evaporation *in vacuo*, red, deliquescent, prismatic crystals separated. The composition of these crystals was found by analysis to correspond with the formula  $\text{Ca}(\text{OH})_2 \cdot \text{CaCS}_2 \cdot 11\frac{1}{2}\text{H}_2\text{O}$ . A solution of this substance gave characteristic precipitates with metallic salts, which the author intends to examine more minutely.

*On the Velocity of Explosions in Gases*, by H. B. Dixon, M.A.—MM. Berthelot and Vieille have shown that in oxygen and hydrogen and several other mixtures of gases the "explosive wave" is propagated at a velocity closely approximating to the mean velocity of translation of the gaseous products of combustion calculated on the assumption that all the heat of the reaction is contained for the moment in the products formed. The mean of a number of determinations with electrolytic gas gave a velocity of 2810 m. per second, the calculated mean velocity of the steam molecule formed being 2831 m. per second. These experimenters found that carbonic oxide exploded either with oxygen or nitrous oxide did not agree with the rule. The author has shown that steam is necessary for the burning of carbonic oxide both with oxygen and nitrous oxide, and that, as the proportion of steam is increased, the rate of inflammation is also increased. Experiments made in a lead tube 55 m. long and 13 mm. in diameter entirely confirmed MM. Berthelot and Vieille's experiments with hydrogen and oxygen. The rate of the "explosive wave" was found to be 2817 m. per second as the mean of several closely concordant experiments at 10° C. With carbonic oxide and hydrogen nearly dry, the explosive wave was not established until the flame had traversed a distance of 700 mm. from the firing-point: the explosive wave was found to have a velocity rather over 1500 m. per second. After the explosion a fine layer of carbon was found to cover the inside of the explosion-tube, showing that at the enormous temperature of the explosive wave carbonic oxide is decomposed into its constituents.

*A Theory of Solution*, by W. W. J. Nicol, M.A., B.Sc.—The author has proposed the theory that the solution of a salt in water is a consequence of the attraction of the molecules of water for a molecule of salt exceeding the attraction of the molecules of salt for one another. It follows, therefore, that, as the number of dissolved salt molecules increases, the attraction of the dissimilar molecules is more and more balanced by the attraction of the similar molecules: when these two forces are in equilibrium, saturation takes place. Any external cause tending to alter the intensity of either of these two opposite forces disturbs the condition of equilibrium, and further solution or solidification ensues. The contraction which occurs on the solution of a salt in water has been regarded as strong evidence in favour of chemical combination having taken place, but the author finds that a further contraction takes place on further dilution, even when the number of water molecules per salt molecule is far in excess of the number in the cryohydrates.

*On the Manufacture of Soda and Chlorine*, by W. Weldon, F.R.S.—Chlorine is at present manufactured exclusively from hydrochloric acid, obtained as a by-product of the manufacture of soda by the Leblanc process. It is owing to this that the Leblanc process has been able to withstand the severe com-

petition of the ammonia process, which gives soda much more cheaply than the Leblanc process, but does not yield either hydrochloric acid or chlorine. The author announces a process for the preparation of chlorine in connection with the manufacture of soda by the ammonia process. The new process consists in decomposing by magnesia the ammonium chloride of the ammonia-soda process, adding magnesia to the resulting solution of magnesium chloride, and so obtaining solid oxychloride of magnesium, which, heated in a current of air, gives off chlorine and leaves magnesia.

*On the Diamond-bearing Rocks of South Africa*, by Prof. Sir Henry E. Roscoe, President.—After an introductory description of the geological and physical aspects of the remarkable diamond-bearing deposits at Kimberley and elsewhere, the author gave the chemical composition of these rocks. The most noteworthy feature of the examination of these rocks is the discovery in the so-called diamond earth of a volatile crystalline hydrocarbon, soluble in ether, which seems to confirm the hypothesis that the Carboniferous shales, which are penetrated by the diamond-bearing pipes, have been the source of the carbon now found in the crystalline state in the diamond. The physical structure of the ash or incombustible portion of the diamond is of a very singular character, and has hitherto not been examined. A careful study of the diamond ash may possibly throw light on the important question of the mode of formation of the diamond.

*Colour of Chemical Compounds*, by Prof. Carnelley, D.Sc.—The colour of chemical compounds is conditioned by at least three circumstances, viz. (1) temperature (Ackroyd); (2) the quantity of the electro-negative element present in a binary compound (Ackroyd); (3) the atomic weights of the constituent elements of the compounds (Carnelley); and that in such a way that the colour passes or tends to pass through the following chromatic scale—white or colourless, violet, indigo, blue, green, yellow, orange, red, brown, black—either by (1) rise of temperature, or (2) increase of the quantity of the electro-negative element in a binary compound, or (3) with increase of the atomic weights of the elements A, B, C, &c., in the compounds  $\text{Ax Ry}$ ,  $\text{Bx Ry}$ ,  $\text{Ca Ry}$ , &c., in which R is any element or group of elements, whilst A, B, C, &c., are elements belonging to the same sub-group of Mendeleeff's classification of the elements. Tables accompany the paper in illustration of the above. Out of 426 cases in which the third of the above rules has been applied, there are but sixteen exceptions, or less than 4 per cent. Finally a theoretical explanation is given which appears to account in a very simple manner for the influence of the above three circumstances on the colour of chemical compounds.

*Notes of Nitrification*, by R. Warington.—He considered the present position of the theory of nitrification, and next gave a short account of the results of recent experiments conducted by him at Rothamsted. Messrs. Schloesing and Müntz, early in 1877, showed that nitrification in sewage and in soils is the result of the action of an organised ferment, occurring in soils and impure waters. The experiments of the author have confirmed the soundness of this theory. The evidence for the ferment theory is now very complete. Nitrification in soils and waters is strictly limited to range of temperature within which the vital activity of the living ferment is confined. It proceeds with slowness at 0°, is at a maximum at 37°, and ceases at 55°. Nitrification is also dependent on plant food suitable for organisms of low character. Further proof of the ferment theory is that antiseptics are fatal to nitrification. Heating sewage to boiling-point, or soil to the same temperature, effectually prevents it. Finally, nitrification can be started in boiled sewage or other sterilised liquid by the addition of a little surface soil or a few drops of a solution already nitrified. These nitrifying organisms have as yet received but little microscopical study.

*On the Liquefaction of Oxygen and the Density of Liquid Hydrogen*, by Prof. Dewar, F.R.S.—The problem of liquefying oxygen and hydrogen, and consequently others of the so-called permanent gases, having been solved by Cailletet and Pictet, the author has since been employed studying the physical characters of these gases in the condensed state. The critical pressures and temperatures at condensation have been determined, and the relation of one to the other is shown to be constant. The merits of various cold producers that could be employed in the process were discussed. Condensed ethylene he considered the best, then condensed nitrous oxide and carbonic acid. The lowest temperature that could be obtained by carbonic acid is about 115° C., and by nitrous oxide 125° C.

*On the Production of Permanent Gas from Paraffin Oils*, by

Dr. Stephen Macadam.—For the last fourteen years the author has devoted much attention to the illuminating values of different qualities of paraffin oils in various lamps, and to the production of permanent illuminating gas from paraffin oils. The earlier experiments were directed to the employment of paraffin oils as oils, and the results proved the superiority of the paraffin oils over vegetable and animal oils, especially for lighthouse service. The later trials were mainly concerned with the breaking up of the paraffin oils into permanent illuminating gas, and the results formed the basis on which paraffin oil gas has been introduced into the lighthouse service of Great Britain, both for illuminating purposes and as fuel for driving engines of furnaces. The following table shows the results of his investigations on the relative values of the crude, green, and blue oils:—

	Crude	Green	Blue
Gas per gallon in cubic feet ...	98	102	127
Candle power ...	50	53	54
Light value of gas from ton of oil given in lbs. of sperm candles	4494	4741	6044

*On the Assimilation of Atmospheric Nitrogen by Plants*, by W. O. Atwater.—It is almost a universal opinion that free nitrogen is not assimilated by plants. He referred to the classic experiments of Boussingault and Lawes, of Gilbert and Pugh, which, commonly regarded as decisive, may have been performed without consideration to certain conditions. Experiments made by the author show that at any rate certain plants grown under normal conditions do assimilate nitrogen. Peas were grown in sand which had been purified by burning and washing, and to which were applied nutritive solutions containing known quantities of nitrogen. The amount of nitrogen supplied to the plant plus the amount contained in the seed was compared after the experiment with the amount given by analysis of the plant and the residual solution. The excess of the latter amount over the former, which in some cases was excessive, represented the nitrogen acquired from the air.

Prof. Gilbert dissented from the conclusion drawn by Prof. Atwater, as he had found that, the greater the care used to prevent foreign matters accumulating on the plants under experiment, the less nitrogen was found in excess of that obtained from the seed and soil.

PROF. FRANKLAND communicated the results of a study of the phenomena attending the discharge of accumulator-cells containing alternate plates of lead peroxide and spongy lead: (1) The energy of a charged storage-cell is delivered in two separate portions, one having an E.M.F. of 2 volts and upwards, the other an E.M.F. of 0.5 volt and under. One of these may be conveniently termed *useful*, and the other *useless*, electricity. (2) The proportion of useful electricity obtainable is greatest when the cell is discharged intermittently, and least when the discharge is continuous. (3) Neither in the intermittent nor continuous discharge at high E.M.F. is the current, through uniform resistance, augmented by rest. At low E.M.F., however, the current, after continuous discharge of the high E.M.F. portion, is greatly augmented, but only for a few minutes. This augmentation of current at low E.M.F. after rest is hardly perceptible when the high E.M.F. discharge has been taken intermittently. (4) The suddenness of fall in potential indicates two entirely distinct chemical changes, the one resulting in an E.M.F. of about 2.5 volts, the other in one of about 0.3 volt. (5) The chemical change producing low electromotive force is the first to occur in charging, and the last to take place in discharging, the cell. It is the change which occurs during what is called the "formation" of a cell, and, for economy's sake, a reversal of this change should never be allowed to take place. (6) Currents of enormous strength can be readily obtained from storage batteries coupled up in parallel, viz. a current of 25,000 amperes from only 100 cells. Such a current reduces to insignificance the output of the large-t dynamo ever built. It is to be hoped that currents of this magnitude will open up new probabilities of research into the constitution of matter.

#### SECTION C—GEOLOGY

*Plan for the Subject-Bibliography of North American Geology*, by G. K. Gilbert, of the U.S. Geological Survey.—The United States Geological Survey is engaged on a Bibliography of North American Geology. The work when completed will give the title of each paper with the title-page of the containing

book, and the number of plates, the whole being arranged alphabetically by authors. There is in contemplation also the simultaneous preparation of a number of more restricted bibliographies, each covering a division of geologic literature. The plan includes abbreviated titles of papers with reference to the pages on which the special subjects are treated, the entries in each bibliography being arranged alphabetically by authors. The selection of topics for treatment in this manner involves the classification of geologic science, and Mr. Gilbert submitted a tentative classification requesting the criticism of geologists.

*Marginal Kames*, by H. Carvill Lewis, A.M., Professor of Geology at Haverford College.—After reviewing the work on American kames, and the theories of the origin of kames, the author describes his investigations of short kames at the extreme margin of the ice-sheet along the line of the terminal moraine in Pennsylvania. These *marginal kames* run backwards from the edge of the ice, draining it by a sub-glacial drainage. These kames are discussed in detail, and are thought to represent sub-glacial rivers formed during the melting of the ice-sheet.

*On the Geology of South Africa*, by T. Rupert Jones, F.R.S., F.G.S., &c.—The contour of the south coast is parallel with the outcrop of the strata in the interior, from Oliphant's River (31° 40' S. lat.) on the west coast, southward to the Cape, and then eastward to about 33° 30' S. lat. Here the edges of the strata, formerly bending round to the north, have been swept away to a great extent; but their outcrop is again seen on the east coast at St. John's River (31° 40' S. lat.), where they strike north-eastwardly through Natal, probably far up the country. (1) Gneissic rock and the Namaqualand Schists apparently underlie the others, coming out on the north west, and exposing a narrow strip on the south coast. (2) Mica Schists and Slates, interrupted by Granites here and there, form a curved maritime band, from about 30 to 70 miles broad, and are known as the Malmesbury Beds (Dunn). These and the beds next in succession (the Bokkeveld Beds, 3) are overlain unconformably by the Table-Mountain Sandstone (4), 4000 (?) feet thick, which forms patches and extensive ridges, and possibly dips over No. 3, to join No. 5, the Witteberg Beds. Nos. 3 and 5, together about 2100 feet thick, lie parallel, and form a concentric inner band. The former contains Devonian fossils; the latter is probably of Carboniferous Age (with *Lepidodendron*, &c.), and forms the Wittebergen and Zwartbergen in the Cape District, and the Zuurbergen in Eastern Province. The Ecce Beds (6) come next; Lower Series, 800 feet; Conglomerate Beds (Dwyka), 500 feet; Upper Series, 2700 feet; conformable with No. 5; in the south much folded, and in undulations throughout, until it passes under the next set of beds, No. 7, in some places 50 miles to the north. The Ecce Beds have fossil wood and plant remains in abundance here and there, but these have not been clearly determined. This series has not been well defined until lately, and even now its limits are not fully determined. It includes the Karoo Desert, and therefore takes in the lowest members of Bain's great Karoo Formation, Nos. 12 and 14 of his map (1856), or the Ecce, Koonap, and part of the Beaufort Beds of Jones (1867). The series No. 7, horizontal and unconformable on the Ecce Beds at the Camdeboo and elsewhere, retains the name of Karoo Sandstones; and after a width of about 40 miles is conformably surmounted by a set of somewhat similar beds (8) in the Stormberg; and thus No. 7 should be regarded as the Lower, and No. 8 the Upper, Karoo Sandstones. The latter end off northwards in the Draakensberg, Natal, Orange Free State, the Transvaal, and Zululand, with the still horizontal Cave Sandstone and associated beds. The Lower Karoo Sandstones probably thin away northwards beneath the others. Below the Karoo Sandstones, and dying out southwards near the Camdeboo (Prof. Green), are the Shales (7\*), which constitute the country around Kimberley, described as the Olive Shales of the Karoo Formation by G. W. Stow. These die out northward against the old rocks of Griqualand-West and the Transvaal. They contain Glacial Conglomerates in their lowest (earliest) beds, in Griqualand-West, just as the Ecce series has its great Glacial Conglomerate (the Dwyka Conglomerate in No. 6) in its lowest portion. As the Stormberg Beds (8) lie upon the Olive or Kimberley Shales (7\*) in the Orange Free State, the Lower Karoo Sandstones (7) must die out northwards. The Kimberley Shales contain some Reptilian bones and plant remains, and some coal on the Vaal; the Karoo Sandstones are rich with Dicotyledon and other Reptilian bones, and have some Fish remains; and their upper portion (Stormberg) contains Ferns and Cycadeous leaves, and some seams of coal. A fossil mammal also has been found in this series. Throughout its range the

Karoo Series is traversed with igneous dykes. Limestones and Sandstones (9) with fossils of nearly pure Jurassic, but with some of Cretaceous type, occur unconformably in the Eastern Province. Their fossil Flora is like that of the Stormberg Beds. Cretaceous strata (10) are known on the Natal coast: and Tertiary and post-Tertiary deposits (11) form several patches on the east, south, and west coasts.

THE SOUTH AFRICAN FORMATIONS

- 11. Tertiary and Post-Tertiary, 100' ?  
(Unconformable on several different rocks)
- 10. Cretaceous  
(Unconformable on Carboniferous ?)
- 9. Jurassic  

Uitenhage Formation	}	Trigonia Beds
		Wood-bed
		Saliferous Beds
		Zwartkop Sandstone
		Enon Conglomerate, 300'
		(Unconformable on Devonian and other old rocks in Albany)
- Triassic  

Karoo Beds	}	8. Upper	Cave Sandstone, 150'
			Red Beds, 600'
			Stormberg Beds, 1000'
		7. Lower	Sandstones and Shales, 5000'
			7*. Kimberley or Olive Shales and Conglomerates, 2300'
			(Unconformable on Ecca Beds in the south, and on the old Vaal and Kaap series in the north)
- Carboniferous ?  

}	6. Ecca Beds	Upper Ecca Beds, 2700'
		Dwyka Conglomerate, 500'
		Lower Ecca Beds, 800'
	5. Witteberg and Zuurberg Quartzites, 1000' ?	
	4. Table-Mountain Sandstone, 4000'	
		(Unconformable on the Old Cape Schists and Slates and on the Bokkeveld Beds)
- Devonian  

3. Bokkeveld Beds, 1100'	
	(Probably unconformable to the Malmesbury Beds)
- Silurian ?  

2. Malmesbury Beds, Mica Schists and Slates of the Cape	
	(Probable unconformity)
1. Namaqualand Schists and Gneiss	

SECTION G—MECHANICAL SCIENCE

*On the Flow of Water through Turbines.*—By Arthur Rigg, President of the Society of Engineers, London.—After remarking that a strict adherence to the older accepted rules of design never produces thoroughly efficient turbines, and that in the best of such motors these rules are disobeyed, the writer pointed out how little reliable practical information can be obtained from all the voluminous literature relating to turbines. He also stated that the course of a stream flowing through the guides and buckets of a turbine had no appreciable influence upon the duty obtained, so long as one essential condition was observed—namely, that its velocity should be gradually reduced to the least that will carry it clear of the buckets. In comparing screw propellers and turbines, each were shown to possess similarities; and experiments made by the writer, and published in the *Transactions* of the Society of Engineers for 1868, were referred to as explanatory of this view of the case. It was further pointed out that there is no such thing as absolute motion, for all velocities are relative to something else; and thus in a turbine we need only concern ourselves with such diminution in velocity as occurs in relation to the earth, and not necessarily with velocities in relation to the moving buckets of a turbine. Impact was considered as a pressure due to the destruction of velocity in a direction perpendicular to a plane surface, while reaction, from a vertical stream, is the natural integration of the horizontal elements of the successive pressures which act vertically in regard to the concave surface upon which the stream is caused to flow. In most theoretical investigations it is assumed that impact and reaction are equal when a current is divided at right angles to its

original course, and this condition implies that a maximum result should be obtained from screw propellers when their blades stand at 45° to the plane of rotation. But in practice an angle of 42° is found best, and this is so because impact and reaction under the conditions stated are not equal, but bear to each other the proportions of 71 to 62; and these proportions give an inclination of screw-blade of 41° by taking an experiment which corresponds most closely with the conditions of a screw propeller. The resultant due to these proportions is found to be 94.25 units, whereas if impact had been the same as reaction it would have been 100.75 units, and this is the total amount that can be aimed for in designing a screw propeller, or pure impact turbine, where the stream is merely turned through a right angle from its original course. But if instead of turning the current only 90° it is turned through 180°, then impact and a still further reduced reaction both act vertically downwards; and it is their sum, and not merely their resultant, that constitutes the total pressure obtainable from a jet of water. Taking the standard unit employed in the experiments described, this sum is found to be 126, of which 71 represents impact, and the remaining 55 the effect of a complete reaction. Therefore, in designing a turbine or screw propeller, it would seem desirable to aim at changing the direction of a stream, so far as possible, into one at 180° to its original course, for it may be said that carrying out this view has placed the modern scientifically designed turbine in that pre-eminence position it now holds among all hydraulic motors.

*The Severn Tunnel Railway*, by T. Clarke Hawkshaw.—This paper described the Severn Tunnel Railway works, begun in 1873, and now approaching completion. The railway is being made to shorten the direct railway route between the South of England and South Wales. It passes under the River Severn about half a mile below the present steam ferry, which connects the South Wales and Bristol and New Passage lines. The river, or estuary, is about 2½ miles wide. The length of the line is 7½ miles, of which 4½ miles are in the tunnel which passes under the Severn. The bed of the river is formed principally of Trias rocks (marls, sandstones, and conglomerates), in nearly horizontal strata. These overlie highly inclined Coal-measure shales and sandstones, which are also exposed in the river bed. The tunnel is made almost wholly in rocks of the Trias and Coal-measure formation, the exception being a little gravel passed through near the English end. The lowest part of the line is below the shoots, the deepest part of the river, where there is a depth of 60 feet of water at the time of low water, and 100 feet at the time of high water. Below the shoots, the line is level for 13 chains, rising 1 in 100 to the English end, and 1 in 90 to the Welsh end. Below the shoots, there is a thickness of 45 feet of rock (Pennant sandstone) over the brickwork of the tunnel. Under the Salmon Pool there is less cover, only 30 feet of Trias marl. Much water has been met with throughout the works, which have been flooded on several occasions. In 1879 the works under the Severn were drowned for some months by the eruption of a large land spring into one of the driftways under land on the Welsh side of the river. On another occasion a cavity was formed from the driftway under the Salmon Pool to the bed of the river, when a hole, 16 feet by 10 feet, was found in the marl. The works were flooded by the water which found an entry through this hole. It was filled with clay, and the tunnel is now finished beneath it. The quantity of water now being pumped is about 10,000 gallons per minute. Additional pumps have been erected, as the large land spring, which has been penned back by a brick wall, still remains to be dealt with. When all the pumps are available, the total power will be equal to 41,000 gallons a minute. The tunnel is for a double line of way, and will be lined throughout with vitrified bricks set in Portland cement mortar. It is being made by the Great Western Railway Company. Sir John Hawkshaw is engineer-in-chief; Mr. C. Richardson, engineer; and Mr. T. A. Walker, the contractor.

SECTION H—ANTHROPOLOGY

THE first paper read in this Section was that of Prof. Boyd Dawkins, *On the Range of the Eskimo in Time and Space*. In his introductory sentences Prof. Dawkins remarked on the importance and interest of his subject. He began his inquiry into the condition of the Eskimo by particularising those of Greenland. By the aid of a sketch-map upon the blackboard, he traced the progress of the dwellers on the Arctic shores, following them to the continent of Asia. He noted that in the

vast region which is occupied by the Eskimo the degree of civilisation is practically the same, that civilisation being of a rude nature. Speaking of their relations to other nations, the Professor remarked on the broad belt of enmity, a debatable ground, that exists between the Eskimo and the Red Indian, between whom there is no friendship. But, he said, there is a likeness between the tongues of the two races, though this does not by any means prove any affinity between them. Coming to the question of the date of the settlement of the Eskimo in Greenland, he said that Markham's assumption that they crossed by Behring Straits from Asia, being driven forth by Tartar hordes, was purely assumption, and that this opinion was not shared by Mr. Dall or himself. He held that there was proof that the Eskimo, in the year 1000, ranged farther southward than where we are now. There was reason to believe this, he said, by archaeological proofs, and he maintained that the Eskimo were a retreating race, being continually driven farther north by stronger and more powerful tribes, such as the Red Indians, and that if the Arctic regions had been less inclement (this being safety to this people), before this time the Eskimo would have been exterminated by the Red Indians. Even in Asia, he said, these were a retreating race, pushed farther to north and east by pursuing tribes. The lecturer remarked on the word "kayak" or boat, used by the Eskimo, and its likeness to the word (caïque) used for the same object by the Turkish people, and quoted his friend Dr. Isaac Taylor, who had traced the history of this word. He explained the etymology of this word in an interesting manner, and caused a little laughter by remarking that the boat was used by the Eskimo to carry their "wives, children, and other chattels." He said, in concluding the first portion of his inquiry, that, from proofs established, the Eskimo formerly lived in a wide range of country far more south than their present habitation, and that they were driven to the north by more powerful nations. Speaking of the range of the Eskimo in time, Prof. Dawkins made some very interesting remarks on the habits and implements of the cave-dwellers in Europe. Illustrating the artistic power of these dwellers, the lecturer pointed out an enlarged sketch of a reindeer, drawn on bone, and found in a cave in Switzerland. This sketch, he said, was perfectly natural, and was admirably done by the skin-clad artist whom he pictured. He also showed the picture of an elephant, with trunk uplifted, and mouth opened, found in a cave in Auvergne. The habits of life of these cave-dwellers in Europe, he said, were the same as those of the Eskimo, and those only of the Eskimo; their implements were the same, and he would connect them in many ways, such as neglect of the rites of sepulture, for instance. The cave-dwellers, he maintained, were in every respect similar to the Eskimo, and this bore out his theory that the latter people are a retreating race in Europe, and once lived far southward of their present range. With regard to the time at which these cave-dwellers existed, and when the Eskimo came into America, the Professor said that the former dwelt in Europe in what is known as the "Pliocene" period. He said that in his opinion the Eskimo represented as a race the ancient cave-dwellers of Europe, and as such he regarded them with interest and respect. He thought that the difficulty of the question of migration was partly disposed of by the fact that the water of Behring Straits was extremely shallow, and in concluding a most interesting address, he recapitulated the proofs that he had brought forward in order to support his assertions.

Mr. F. W. Putnam, Curator of the Peabody Museum of American Archaeology and Ethnology at Harvard University, gave a short notice of *The Recent Explorations by Dr. C. L. Metz and himself in the Little Nicomi Valley, Ohio*. The particular mounds, to the singular structure of which Mr. Putnam confined his remarks he has called the Turner group. The mounds, out of one of which he had taken seventy-three skeletons, were burial mounds of the ancient Indians, and some seem to have been erected for an entirely different purpose. By means of rough sketches, Mr. Putnam illustrated the formation of these mounds. One of these seemed, from the fact that everything in it had been burnt, to be erected for a sacrificial purpose. A mass of a peculiar substance, like ashes, but which was not ashes, was found in the mound. What this substance was the lecturer did not know, but it was now being analysed by chemists. He described in detail the interior of the mounds which had been explored, noticing the covered pits which were found in them, some of these containing ashes and animal bones. A mixture of iron and gravel, forming a solid cement, was a curious feature

in the mound, as the presence of the iron could not be accounted for. He said that previous explorations of the mounds had been very superficial, and had led to misrepresentation on the subject, but he had found that the removal of every inch of earth was necessary in order thoroughly to explore them, and this was done. In one mound two complete skeletons were found, in the midst of ashes. Round these were fragments of three other skeletons, and sixteen skulls, six of these latter having holes bored in them, evidently with stone drills. Scratches on the skulls showed how the flesh had been scraped away with a stone knife, and the skulls had evidently been placed round the skeletons for the purpose of ornament. Mr. Putnam said that in many respects these mounds were totally different from any that had yet been discovered and explored in this country. He showed photographs to illustrate his subject, amongst them being a remarkable specimen of art in the shape of a representation of a human face cut out of a sheet of mica. This, he said, would favourably compare with Dr. Dawkins' sketch of an elephant's head drawn by a cave-dweller of Europe. The speaker also noticed many other artistic objects, such as bracelets of copper covered with native silver, and peculiar and large earrings of the same material. In other cases he had found objects covered with native meteoric iron and with native gold; also terra-cotta images of small size, most of them much broken by the action of the fire into which they had been thrown. He remarked upon the likeness in many respects that the ornamentation of these objects bore to the work of the Egyptians.

A paper by Dr. Paul Topinard was read, entitled *Instruction anthropométrique élémentaire*. The author described various instruments that had been devised by him for enabling inexperienced travellers to take measurements of the human body with moderate accuracy.

Mr. Jeremiah Curtin read a paper *On Myths of the Modoc Indians*. He said that there were between three and four hundred Modocs, most of whom were in the Indian Territory and Southern Oregon. He proceeded to read a "myth" of these people which related to a personage called the Blue Woman, who was supposed by the Indians to be the second person in the Universe. This story, which was something like a fairy tale, was taken down in the original language by the speaker himself. He described the hardships through which the young Modocs went in order to fit themselves for manhood, such as climbing a mountain in order to reach an almost inaccessible pond, in which they swam.

### SCIENTIFIC SERIALS

*Journal of the Russian Chemical and Physical Society*, vol. xvi. fasc. 6.—On the succession of reactions, by M. Lvoff, being an introduction into a series of researches undertaken by the author and several students, in order to disclose the mechanism of polymerisation.—On the action of chlorine on butylenes, by M. Chechoukoff.—On constants of chemical affinity, by W. Ostwald. The author, who maintains the views of Berthollet, further elaborated by Guldberg and Waage, considers that there is, for each body, a certain numerical coefficient of its chemical affinities as characteristic for the body as its atomic weight; and in addition to his former works, already published in the *Journal für pract. Chemie*, he publishes now a preliminary list of "constants of chemical reactions."—On glycidic acids, by P. Melikoff.—On the displacement of chlorine by bromine, and an explanation of the reactions which are accompanied by a disengagement of heat, by A. Potylitzin. The substitution of chlorine by bromine, in seeming contradiction with the law of maximum work, and which Berthelot has endeavoured to explain by the formation of chloric bromine and bromides of metals, could be explained by admitting that the reaction is going on with the heat received from the surrounding medium. This important inquiry, pursued by the author for several years past, brings him to interesting conclusions on thermo-chemistry.—On asarone, by MM. Rizza and A. Butleroff, being an inquiry into the properties of the camphor received from *Aaarum europaum*.—On a new apparatus for determining specific heat, by W. Loughinin. It is a modification of the apparatus of Neumann.—On the reduction of isodinitrobenzyl, by P. Goloubeff.—On the preparation of animal colouring matters from albuminoid substances, by W. Mikhailoff.—On azophenylacetic acid, note by M. Wittenberg.—On the solution of lithium carbonate in water, note by J. Bevad.—On a hygienic photometer for schools, by Prof.

Petroushevsky. It allows the amount of light received by books, paper, &c., on the desks of scholars, to be rapidly and accurately measured.—On the volume of a liquid considered as a function of temperature under a constant pressure, by K. Jouk. Diethylamine and ethyl chloride both agree with Prof. Avenarius's formula:  $v = a + b \log (\tau - t)$ .—On the relation between pressure and the density of rarefied gases; preliminary communication by K. Kraevitch.—Notes on the structure of the atmosphere, by MM. Stankevitch and Rogovsky.

*Annalen der Physik und Chemie*, No. 7, June 15.—On the electric discharge in gases, by O. Lehmann (2 sheets of figures).—Contribution to the investigation of the origin of thermo-electric streams in a continuous homogeneous conductor, by Rudolph Overbeck (10 figures).—On the changes which the molecular structure of iron undergoes by heating and cooling, by Carl Froune (2 tables).—On the appearance of electricity with the development of gases, by W. Hankel.—On a constant battery for electrical measurements, by W. von Beetz.—On the position of the pole, the induction and temperature coefficient of a magnet, and on the determination of the magnetic moment by bifilar suspension, by F. Kohlrausch.—On the dispersive power of a diamond, by A. Schrauf.—Researches on radiant heat, by Heinr. Schneebeli.—On the construction of Bohnenberger's reversible pendulum for the determination of the length of a pendulum for observing the period of oscillation in relation to a given length of mass, by Wilhelm Weber.—On the equilibriums of floating elastic plates, by H. Hertz.—The electricity of flame; reply by J. Kollert.—On a new position for the measuring wire in the Wheatstone-Kirchoff bridge combination, by Hugo Meyer (2 figures).—Wheatstone's rheostat and mercury contact, by J. Bodynski (2 figures).

*Journal de Physique théorique et appliquée*, July.—On the analytical expression of absolute temperature and Carnot's function, by G. Lippmann.—On the electro-chemical equivalent of silver, by M. Mascart.—On the phenomenon of crystalline overheating of sulphur and the rapidity of transformation of octahedral to prismatic sulphur, by D. Gernez.—Study of the distribution of potential in conductors of two or three dimensions traversed by continuous currents, by A. Chervet.—On an electrostatic standard of potential, by Messrs. Crova and Garbe.—On the variation of the capillary constant at water-ether and water-carbon bisulphide surfaces under the action of an electromotive force, by M. Kroncholl and Lord Rayleigh.—On the electro-chemical equivalent of silver, and on the absolute electromotive force of Clark cells, by B. C. Damien.

SOCIETIES AND ACADEMIES

PARIS

Academy of Sciences, September 22.—M. Rolland, President, in the chair.—On algebraic equations: part third, on irrational equations, by M. de Jonquières. The author arrives at the somewhat unexpected conclusion that all algebraic equations, whether rational or not, which belong to the same "species," possess the same maximum number of real roots, whatever be their respective degrees.—Observations on the corona now visible round the sun; variations in its form and colour; a method of increasing its luminosity; polariscopic observations; polarimetric and photometric observations, by M. A. Cornu. The author is still disposed to connect this phenomenon with the Krakatoa eruption. The facts adduced are regarded as numerous enough to support the natural hypothesis of a cloud of particles with a nearly constant mean diameter, projected by the volcano and held in suspension in the higher regions of the atmosphere.—On the general evolution of the vegetable functions in annual plants: the Amaranthaceæ, by MM. Berthelot and André.—On the movement of Hyperion, by Prof. S. Newcomb. The author concludes that all the conjunctions of Hyperion with Titan take place near the aposaturn of the latter satellite. The point of conjunction oscillates about 180° on either side of the aposaturn during the period of revolution of the perisaturn of Hyperion in relation to that of Titan.—On the completion of the new method for resolving the most general linear equation into quaternions, by Prof. Sylvester.—Remarks on the third instalment of the new topographical map of Algeria presented to the Academy by Col. Perrier. This section consists of six sheets, comprising Miliana (province of Algiers), Saint Denis-du-Sig (province of Oran), Herbillon, Cap-de-Fer, Cap-de-Garde, Bugeaud (province of Constantine). The surveys are executed on a scale of 1 : 40,000, and the map,

engraved on zinc, is issued at the scale of 1 : 50,000. Each sheet comprises seven plates, the relief being figured geometrically by equidistant curves of 10 m. in 10 m., and the plastic disposition of the surface being obtained by means of a dubbed drawing with lithographic crayon, based on the zenithal light and heightened by a slight touch of oblique light. The map marks a great improvement in the cartographic art.—On a development in a continuous fraction, by M. Stieltjes.—Note on the antiseptic properties of the sulphuret of carbon, by M. Ckiandi-Bey. From numerous experiments carried on for several years, the author finds that this sulphuret, which is soluble in water, arrests all fermentation, kills all microbes, is a most powerful antiseptic, and is, moreover, endowed with considerable penetrative power. Hence he strongly recommends it as a most efficacious remedy for cholera, typhus, diphtheria, phthisis, and all diseases traceable to living germs.—Contributions to the study of the Cretaceous flora of the west of France, by M. L. Cric.—The Perpetual Secretary announced to the Academy that the International Committee of Weights and Measures representing the high contracting parties to the Convention for the Metre signed at Paris on May 20, 1875, has received the adhesion of England, which had hitherto taken no part in the Convention. With the further accession of Roumania and Servia the Committee now represents an aggregate population of 421,440,396, distributed over Germany, England, Austria, Hungary, Belgium, the Argentine Republic, Denmark, Spain, the United States, France, Italy, Peru, Portugal, Roumania, Russia, Servia, Sweden, Norway, Switzerland, Turkey, and Venezuela.—The photolithographic facsimile of a letter addressed by Gauss to Olbers on September 5, 1805, was presented to the Academy by Prince Boncompagni.

CONTENTS

PAGE

The "Challenger" Reports . . . . .	533
The English Flower Garden . . . . .	534
Our Book Shelf:—	
Kerry-Nicholls's "King Country; or, Explorations in New Zealand" . . . . .	535
Brown's "Forests and Forestry of Northern Russia and Lands beyond" . . . . .	535
Letters to the Editor:—	
M. Thollon's Views of "Great B" in the Solar Spectrum.—Prof. C. Piazzzi-Smyth . . . . .	535
Shifting of the Earth's Axis.—W. H. M. Christie, F.R.S. . . . .	536
The Sky-Glows.—Prof. A. S. Herschel; Miss T. M. Browne . . . . .	536
September Stream of Krakatoa Smoke at Strong's Island.—S. E. Bishop . . . . .	537
Biology <i>v.</i> Botany.—Rev. George Henslow . . . . .	537
Animal Intelligence.—R. J. Harvey Gibson; Thomas Harrison . . . . .	538
Meteors.—Consul E. L. Layard . . . . .	538
The Milleporidæ.—John J. Quelch . . . . .	539
To Find the Cube of any Number by Construction.—R. Tucker . . . . .	539
The Failure of the Parsley Crop.—W. H. C. B. . . . .	539
Wasps as Fly Killers.—George Lawson . . . . .	539
George Bentham . . . . .	539
A Model Lens for Use in Class Demonstrations. By John B. Haycraft. ( <i>Illustrated</i> ) . . . . .	543
The Electrical Exhibition at Philadelphia . . . . .	543
A New Application of India-rubber. ( <i>Illustrated</i> ) . . . . .	544
Notes . . . . .	545
Our Astronomical Column:—	
Comet 1884 <i>b</i> (Barnard, July 16) . . . . .	547
Comet 1884 <i>c</i> . . . . .	548
The Lunar Eclipse on October 4 . . . . .	548
Hydroxylamine and the Assimilation of Nitrogen by Plants . . . . .	548
The British Association:—	
Reports . . . . .	548
Section B—Chemistry . . . . .	549
Section C—Geology . . . . .	553
Section G—Mechanical Science . . . . .	554
Section H—Anthropology . . . . .	554
Scientific Serials . . . . .	555
Societies and Academies . . . . .	556

THURSDAY, OCTOBER 9, 1884

*THE CHOLERA POISON*

THE reporter of the French Commission appointed to investigate the mode of action of the cholera poison and its method of propagation, as judged of from the behaviour of the disease during the epidemic in the southern provinces of France, has made public the conclusions which have been arrived at. It will be remembered that the French Commission which studied the same subject in Egypt last summer differed from the German one in regarding the blood as containing the specific organism of the disease, a contention which found no support in this country when the medical societies had had an opportunity of examining microscopically the preparations which were supposed to afford proof of it. Dr. Koch, chief of the German Commission, on the contrary, declared that the French statement was due to an error of observation, and maintained that the comma bacillus which he had discovered in the coats and contents of the intestines formed the specific germ of the disease. The French Commission of 1884 now return to the subject by still maintaining that the blood contains the poison, and that the initial lesion of cholera takes place in the blood. In proof of this they describe the changes which the blood cells undergo during the process of cholera; they regard certain modifications, such as result from the entire loss of elasticity of the globules, as one of the most certain signs of the patient's impending death; they maintain that by the hourly examination of the blood of cholera patients the progress of the malady can be mathematically followed; they assert that cholera, as such, is transmissible to the rabbit as the result of the injection into its veins of the blood of a cholera patient at the algid period; and lastly, they maintain that the microbe specially described by Dr. Koch has no such specific properties as have been claimed for it.

So far the two sets of observations are diametrically opposed to each other, and neither of them finds much support from the investigations of Drs. Lewis and Cunningham in India. The French contention that cholera is transmissible to one of the lower animals is at variance with all previous trustworthy experiments, and until the details of the method of operating and of the symptoms induced are made public, it would be premature to accept the conclusion at which the Commission have arrived at as in any way proven. But, on the other hand, time is not lending support to the contention of the German Commission, and it is asserted that the early labours of Dr. Klein in Calcutta have confirmed the view which he has all along held, that the announcement of the discovery of a specific cholera organism in the comma microbe is, at least, premature. Fortunately, many observers are now at work in the field of cholera micro-pathology, and the opportunities which have been, and still are, afforded for such work both in Europe and in India are exceptionally favourable. The interests of science will be best observed by waiting for the results of the labours now in progress, and by the exercise of caution in accepting any views which are based on any isolated series of experiments. But whatever be the result, Dr. Koch and the German

Commission must be regarded as having given fresh life to a scientific question the interest in which had for some time past been flagging, and to them must be given the credit of having secured in Dr. Klein's work at Calcutta the establishment of an English laboratory for the elucidation of a subject which this country should always regard as peculiarly its own, in view of the fact that among its possessions is the country which has always been regarded as the home of cholera.

*THE SANITARY INSTITUTE AT DUBLIN*

THE Sanitary Institute of Great Britain succeeds, by its annual migrations from town to town, in securing a widely-diffused interest in matters relating to public health, and there are but few large towns in the United Kingdom that stand in greater need of some such stimulus than Dublin, where, under the presidency of the veteran sanitary engineer, Sir Robert Rawlinson, C.B., the Institute has met this autumn. Within the past twelve years we have made great strides in organising a sanitary administration in this country, every portion of which is subject to the control of a sanitary authority having at least two executive officers—the medical officer of health, who is intended to be a skilled adviser as to the principles which should be held in view in action taken for the promotion of health; and an inspector of nuisances, whose functions relate in the main to the periodic inspection of his district with a view of the removal of such conditions as are likely to cause injury to health, or nuisance. In Ireland a somewhat similar organisation has also been established, and, as in this country, the working of the system is subject to the control of a central body known as the Local Government Board. But to judge from a paper read before the Institute by Dr. Edgar Finn, there is a wide difference between the efficiency of the two systems, and it is certain that, whether judged by the progress that has actually been made or by the amount of money that has been raised by way of loan for the execution of sanitary works in England and in Ireland, the latter country must be regarded as comparing very unfavourably with the former.

According to Dr. Edgar Finn, this is partly due to the fact that the Irish Local Government Board is in itself unmindful of using the ordinary means at its disposal for enforcing the proper carrying out of the provisions of the Act under which it is constituted, partly to the circumstance that in the large mass of the sanitary districts the Boards of Guardians who have been constituted the sanitary authorities take but little interest in their sanitary duties, but mainly to the faults inherent to the system under which the medical officers of health are appointed in the rural districts. In Ireland the dispensary or poor-law medical officers are appointed to act as rural medical officers of health, and Dr. Finn points out that the miserable addition of from 10*l.* to 15*l.* to their other salaries does little more than suffice to induce them to hold their tongues, and to take no official notice of the conditions of dirt and unwholesomeness with which they come into contact. And not only so, but it is alleged that such officers cannot possibly be unfettered and independent in their action, for they are generally the medical attendants of the Guardians whom they serve, and who

are probably in most cases the owners of the properties needing sanitary amendment. In England, on the contrary, Dr. Finn points to the frequency with which rural sanitary authorities combine amongst themselves, and at times also with urban authorities, in the appointment of a single officer of health, to whom it is then possible to give such a salary as will command the entire services of a really competent and independent officer. The contention is true to a certain extent, but it must be remembered that the same system which Dr. Finn describes as faulty in Ireland is precisely the one which the poor-law inspectors, to whom the English Local Government Board originally looked for advice in this matter, secured throughout a very large portion of England when first the appointment of medical officers of health became compulsory in 1872, although it is true that the same Board has during the past five or six years been striving its utmost to undo the arrangement then carried into effect. It was originally felt that a local officer whose other duties necessitated his constant presence in every portion of his district would be the most competent of all to advise as to its sanitary circumstances, the more so as he, of all others, would have the earliest information as to the existence of preventable sickness and death. At first sight the idea seems a very plausible one, and if the principal duties of an officer of health were to be performed on the occurrence of disease, it might still find intelligent supporters. But it is essentially the prevention of the conditions leading to such diseases, and not their remedy after the disease has occurred, that should be looked for from the officer of health, and it is daily becoming more and more apparent that wider districts, supplying wider experience and commanding more skilled services, tend to this, rather than narrow areas which are only looked after during the performance of multitudinous duties of a more pressing character. It is not that the dispensary or poor-law medical officer is necessarily incompetent to perform the duties expected of an officer of health, for in England such officers at times hold both appointments with considerable advantage; but the great mistake which was originally made in England, and which has been repeated in Ireland, was to regard men as competent to perform the duties of one office merely because they held another office involving the performance of totally different duties.

The present is, however, a period of transition in this matter, and the public cannot expect to secure the highest procurable services until degrees and diplomas in sanitary science shall be so universally taken by those who seek public health appointments, that it shall always be possible to find candidates possessing the needful guarantee that they are competent to perform the duties of medical officer of health. The principle of combination by several authorities to secure the entire services of a single officer of health over a reasonably large area tends to efficiency, and most of such officers recently appointed have been able to prove their fitness for the post by the possession of some such diploma as we have referred to, and which can now be procured in each of the three divisions of the United Kingdom.

We have given this matter some prominence because of the importance which attaches to it wherever medical officers of health are appointed, but the Institute dealt at Dublin with many other subjects which are of equally

pressing importance in Ireland. The need for improved dwellings for the poor, for adequate supplies of wholesome water, for efficient means of drainage, and for some proper methods for the disposal of refuse, are urgent requirements in many parts of Ireland. The lack of them causes needless mortality and sickness, and the methods by which they may best be supplied were fully indicated. As a test of the needs of the country in these respects, statistics as to deaths and sickness need to be intelligently examined, and amongst the contributions to the Congress few papers were of more value than that in which Dr. Grimsbaw, Registrar-General for Ireland, dealt with the statistical measures of the health of communities, and so explained how a proper estimate of the health of a district may best be arrived at.

#### CONTRIBUTIONS TO PHENOLOGY

*Beiträge zur Phänologie.* By Dr. Egon Ihne and Dr. Hoffmann. (Giessen: Published by the Authors, 1884.)

PHENOLOGY, the observation of the first flowering and fruiting of plants, the foliation and defoliation of trees, the arrival, nesting, and departure of birds, and such like, has attracted the attention of naturalists from time to time for nearly 150 years. Some have continued their observations for several years and have formed therefrom a "Calendar of Nature"; others have gone still further and have tried to deduce more general results. But the subject is beset with difficulties, especially when an observer endeavours to procure the aid of others, and this has proved so great at times that the work has not flourished as much as it deserved. The subject has been most carefully studied by M. Quetelet of Brussels, and his writings have served as the basis for most of the subsequent attempts which have been made at organising a System of observation. Dr. Egon Ihne of Giessen, in connection with Dr. Hoffmann, whilst endeavouring to form a series of Charts of plant-flowering for Europe generally, has consulted all accessible works likely to contain any information on the subject. This information is most generally scattered through the Transactions and Reports of Botanical and Local Societies, but still there is much to be obtained from other works, whose titles would not lead one at first to consult them for the purpose. The number and minuteness of the notices mentioned by these Professors, shows that they must have spent a long time in preparing this work, and very valuable service has been rendered to Phenology by publishing the list of sources from which information can be obtained. The total number of works noticed is 196, and naturally those published in Germany are most numerous. It will, however, surprise many to find that, whilst 102 German works are noticed, Great Britain with only 21 comes next, leaving 73 for the rest of Europe. It must be evident, therefore, that, notwithstanding the great care taken in compiling this list, there must be many works not noticed which contain phenological information, and the Authors would doubtless welcome notices of any works omitted from their list.

The main part of the book consists of a short account of the progress of Phenology in each of the countries of Europe, followed by a list of the works published in that country, with such short notes as may suffice to explain the nature of the information each contains. To this is

added a very complete index in two parts. The first part gives a list of the stations at which observations have been made, arranged alphabetically under the names of the countries of Europe in which they are situated; the total number of such stations is 1926. The second part consists of the names of these 1926 stations arranged alphabetically, with the years in which observations have been taken, and references to the works in which these observations are recorded. Some very curious facts may be obtained from this index. Whilst there are 315 stations in Great Britain, there are no less than 918 in Germany and Austria, and consequently 693 for the rest of Europe. But a more critical examination of the list reveals the fact that, of these 1926 stations, only 334 were taking observations in 1882, the date of the compilation of the work, and at only 97 of these 334 stations had observations been continued for ten years or more. Even this small number requires modification, for out of the 97 only 60 had observations for ten *consecutive* years, thus showing how spasmodically the subject had been treated till quite a recent date. Of the 1592 stations at which observations have ceased, there are only 210 with records of ten years and over. Considering the nature of the subject, ten years' work must be considered as the very least from which anything reliable may be deduced; whence, small as the number is compared with the large number of stations at which phenological work has been done, it is yet satisfactory to find that there is some good material to be obtained. Of late years the subject has been much more attended to, especially in England, since the Royal Meteorological Society took the matter in hand, and of the 334 stations at which observations are now taken, no less than 94 are in Great Britain and 112 in Germany.

Dr. Ihne regrets that the observations as taken for the Royal Meteorological Society refer to herbaceous rather than woody plants, and are exclusively confined to wild flowers and not to cultivated ones. His own list, which has been very generally distributed throughout Europe, has been drawn up on a different principle, and without entering into definite reasons, he condemns the Meteorological Society's list. Certainly in England, in the only case besides that of the Meteorological Society where a comparison of flowering throughout England has been tried, cultivated plants have been entirely excluded, being found by actual experience to yield no reliable results.

The second part of the work is taken up with an enumeration of the notices on the plants in the list issued by the Professors taken during the years 1879 to 1882. It would have been perhaps more convenient if they had been exhibited in a tabular form; at present it would be a work of some labour to extract the notices for the purposes of comparison.

#### LETTERS TO THE EDITOR

[The Editor does not hold himself responsible for opinions expressed by his correspondents. Neither can he undertake to return, or to correspond with the writers of, rejected manuscripts. No notice is taken of anonymous communications.]

[The Editor urgently requests correspondents to keep their letters as short as possible. The pressure on his space is so great that it is impossible otherwise to insure the appearance even of communications containing interesting and novel facts.]

#### The Younger School of Botanists

A COMMUNICATION from the Rev. George Henslow to last week's NATURE (p. 537) concludes with the following passage:—

"There are not wanting signs elsewhere of the evil effects of the younger school of botanists not recognising the importance of first training students in a thorough course of practical and systematic botany before proceeding to laboratory work. In an examination lately held for a post at Kew, I am informed that two gentlemen who had been trained at Cambridge competed with a gardener for the post. The gardener secured it. *Verb. sap.*"

The last sentence is no doubt intended as a sort of *argumentum ad hominem*, which it may be admitted is not without a certain apparent force. Assuming for the moment the statement to be true, it must be pointed out that the only scientific posts at Kew which are open to public competition are those of assistants in the herbarium. These posts demand qualifications of a somewhat technical character, for which a general training in botany would by no means necessarily fit the candidates. I can imagine that a senior wrangler might fail in a competition for a post of computer in an observatory where arithmetical dexterity was the main thing required; a senior classic might cut an equally poor figure in seeking an appointment of library assistant if he were tested in the art of writing catalogue slips. I apprehend that in neither case would failure prove anything as regards either mathematical or classical education.

The examination to which Mr. Henslow alludes can only be one which was held by the Civil Service Commission during the past summer. There were, I believe, some dozen candidates; whether any Cambridge men were amongst them I am unable to say. But the successful candidate was not a gardener, but the laboratory assistant of the late Professor of Botany at Oxford—a gentleman whose services the present Professor is in despair at losing.

On a former occasion it is true that one of our garden staff did obtain one of these appointments in an open competition. It is not very remarkable that it should be so. Men of ability on the spot have, of course, great facilities for seeing the nature of the duties required and for qualifying themselves accordingly; furthermore they have the advantage of the lectures of my colleague Mr. Baker, which are especially directed to the branch of botany which principally occupies us at Kew.

As to the larger question raised by Mr. Henslow, I am afraid I am not wholly free from some responsibility for the proceedings of "the younger school of botanists," the effects of which he regards as evil. In the face of the successful revival in this country of many branches of botanical study which the younger school has effected, I am emphatically of the opinion that these effects are the reverse of evil. I believe I was one of the first to organise a course of so-called laboratory work in botany on lines which it is only right to say were borrowed and extended from the teaching and example of Prof. Huxley. In what I attempted I had the generous aid of many now distinguished members of the younger school. I do not doubt that they have immensely improved on the beginning that was in the first instance somewhat tentatively made. But the principle, I believe, has always remained the same, namely, to give the students a thorough and practical insight into the organisation and structure of the leading types of the vegetable kingdom. When, therefore, Mr. Henslow, himself a teacher, asserts that such laboratory teaching as this should be preceded by a thorough course of practical and systematic botany, it appears to me that he is bound to explain what he precisely means by this very dark saying. For, if botanical laboratory work in this country is not thorough, is not practical, and, in dealing with types drawn from every important group, is not systematic, it is important to know in what respects it falls short of these requirements.

W. T. THISELTON DYER

Royal Gardens, Kew, October 4

#### The Solar (Dust?) Halo

THE reddish halo to which Mr. Backhouse draws attention in his letter of September 20 in NATURE (p. 511) has of late been noticed by several observers, and this I think is because, while the sunrise and sunset glows have exhibited a marked decline in their duration and brilliancy since last winter, the halo has shown no similar diminution of intensity, and thus attracts more attention relatively than it did at first, when it remained for some time almost entirely unnoticed in this country. In reply to Mr. Backhouse's question as to whether this halo has been seen in England previous to last November, I have a very strong impression that it made its first appearance here coincidentally with



the arrival of the unusual sunsets last year, and that it has never been seen here before, at any rate within the last twenty years. This impression is founded, first, on the fact that, like Mr. Backhouse, I have been in the habit of frequently looking at solar halos for years past. Secondly, I have been engaged since September 8 last year in a series of observations with anemometers attached to a kite-string (latterly wire), which has naturally necessitated my frequently looking up at the sky. I remember noticing the halo in November, and calling the attention of my assistant to the beautiful salmon colour it showed in the interstices of a mackerel sky, which shut off the direct glare of the sun.

On several occasions I measured its radius with a theodolite I was using, and in every case the value came out either  $22\frac{1}{2}^{\circ}$  or  $23^{\circ}$ . It must therefore be due, like the ordinary ice-halo, to refraction through hexagonal prisms. I noticed it all the way going out to America in August last, and saw it beautifully when standing on the Terrapin Bridge over Niagara Falls on August 23. A large black cloud had shut off the sun's glare, and the red border happened just to coincide with the edge of the cloud. I called the attention of some American ladies to the spectacle, which they had of course never noticed before, and which they admired immensely. I regard the sunset glows as partly an intensification of the halo, produced by the greater thickness of the stratum through which the refraction takes place when the sun is below the horizon (the sunset, in fact, being formed of the upper half of the halo which lingers behind) plus reflection from the same stratum, which can of course only come into operation when the sun shines obliquely on it. The fact of the halo remaining constant while the sunset glows have become weaker may be readily explained on the hypothesis that the stratum has gradually sunk to a lower level than it had last winter, since the duration and even brilliancy of the glow must of course vary directly with its height, whereas the halo at midday need not be sensibly altered by a variation in its level.

Three weeks ago yesterday, I saw the sun rise from the summit of Mount Washington, 6293 feet above sea-level, and at ten minutes to five o'clock saw, in addition to the usual sunrise effects, a large circle of rosy purple haze situated about  $15^{\circ}$  above the horizon, and apparently having no connection with the yellow and red horizontal bands beneath it. The morning was exquisitely fine, the only clouds being a few light streaky cirrostrati, as shown in diagram, and the air was as clear as it only can be in America. I may add that the haze circle appeared almost suddenly after the first yellowish light had been visible for twenty minutes, and as soon as the sun rose above the horizon it seemed to vanish almost entirely. I have seen the sun rise from various altitudes up to 12,000 feet, but I never saw anything so curious as this sunrise before. In fact, I went up mainly to see it, and was not disappointed.

E. DOUGLAS ARCHIBALD

Tunbridge Wells, September 27

### Cole's Pits

YOUR note on the result of Gen. Pitt-Rivers' examination of the Pen Pits (Somerset) in this week's number of NATURE (p. 545) reminds me of a series of similar pits in this county of Berks, known as "Cole's Pits." They are situated near the branch of the Great Western Railway which runs from Uppington to Faringdon. I have visited them more than once when on visits to Wadley, the residence of my friend Mr. T. L. Goodlake, J.P. They correspond generally with the description given in NATURE of the Pen Pits, are probably of quite equal extent, are similarly situated on rising ground forming the cap of a ridge of hills, and are on the same Greensand formation. Many and various theories have been propounded from time to time by antiquarians, and of course the name by which these pits have been known for generations has been appealed to as connecting them with the "merry King Cole," and giving support to the views of those who regard them as traces of an "ancient British town." The utter absence of order in the arrangement of these shallow holes and rude mounds (for they are nothing more) excited my suspicion, nor could I see much in them to suggest occupation by any race which has inhabited these islands even so late as the time of the ancient Britons. On further investigation of them I came across a more modern sort of hut, consisting of a space rudely roofed over, the back of

which was cut into the side of one of these grass-grown banks. The idea occurred to me that this would help to furnish evidence, since, if these hollows were dug in the strata of the hill to be roofed over for human habitation (the notion which, I am told, finds general favour) we ought to find some traces of stratification in a section thus presented to us. Not a trace of this was to be found; the section showed nothing but a chaotic mass of rubbly material with no more order in its arrangement than is to be found in the waste heaps of any old quarry or in a terminal moraine.

So far one's first impressions of the "pits" and mounds, as of an extensive series of old disused quarries, received confirmation. I cannot hazard a conjecture as to the extent to which quartz-stones may have been obtained from the "Cole's Pits"; but it seemed to me extremely likely that the range of hills in question, here so many hills on sandy formations (our Bagshot Sands, for example) owed its existence, *quâ* hills, to the protection of the hard "paw" which is so frequently met with in such formations, which I have attempted to account for in the *Proceedings* of the Geological Association (vol. viii. No. 3), and which was certainly largely worked in places for rude building construction in very early times, large masses of it being seen still in the old Roman wall which to-day completely encircles the area occupied by the ancient town of Silchester. It is possible, too, that such ironstone may have been rich enough in the metal to serve as ore, when iron "forges" were common in past centuries in the forest districts of the south of England. Further support is given to the view which I venture here to put forward as to the origin of the Cole's Pits, by the fact that lower down the hill, and at a rather lower "horizon," there is a sand-pit open in the side of the hill, in which thin bands of ironstone occur, some of which, to judge from their specific gravity, might certainly have been available as ore, under conditions which obtained in the iron industries of the country a few centuries ago. A. IRVING

Wellington College, October 3

### The Flow of Streams

THE observations made by Mr. Maw on a stream flowing into the Lake of Thun are an extremely interesting example of well-known hydraulic laws. It would be well, however, if he would tell us what was the depth of the water; from the observed phenomena I presume it was small. Mr. Smith's very ingenious mode of practically showing the different strengths of a current from surface to bottom should also be supplemented by an account of the size of the stream operated upon. The situation of the point of greatest velocity varies considerably with the conditions of the river or stream, and is by no means fixed. The observations made on some large rivers, notably those by Mr. Revy on the large rivers of South America, seem to show that the greatest velocity is, in such cases, almost, if not quite, on the surface, and that from that point it diminishes uniformly downwards to the bottom. The ratio between the surface and bottom velocities is, however, a constantly changing one, and in large rivers varies with the depth of the water. Mr. Revy's observations seem to show that in large rivers, where the influence of the banks is practically inappreciable, the surface velocity varies directly as the depth, whilst the bottom velocity varies as the square of the depth; as the depth increases, the difference between the top and bottom currents diminishes, until at a depth of about 71 feet they are practically equal. These results are borne out by the observations of Messrs. Humphreys and Abbott on the Mississippi and Mr. Gordon on the Irrawaddy. All observations to be useful, therefore, should give the size of the river or stream operated on. If Mr. Smith has not seen the diagrams given by Mr. Revy in his "Hydraulics of Great Rivers," I think he would be interested in them. GEORGE HIGGIN

### Lepidoptera

I AM at present carrying on some researches here, for which a supply of living caterpillars of such large Lepidoptera as the Death's Head, Goat, or Hawk Moth is necessary. As I have had some difficulty in obtaining these, I should feel exceedingly obliged to any of your readers who may find or possess larvae of the above or other large species, if they could furnish me with specimens. G. LOVELL GULLAND

Zoological Laboratory, University College,  
Gower Street, London, October 4

### Animal Intelligence

MR. HARRISON, like most of those who deal with animal communications, assumes that sounds or words must form the basis. This rests upon the assumption that speech is a primary system of communication for mankind, instead of being secondary. Many babies will begin with sign communication, and show a preference for it after they are well able to articulate words. The dog will follow human gestures as well as sounds and words. It is indeed worthy of consideration how far signs play a part in communication between animals. Instead of supposing a complicated system of words, as Mr. Harrison does, it is easy to conceive that, with the apparatus he describes, many signs may be made. Expressions of alarm, joy, direction, can be as well made with antennæ as with hands.

32, St. George's Square, October 6

HYDE CLARKE

### Shifting of the Earth's Axis

PERMIT me to say that it was from the diagrams in the paper by Mr. Christie which he quotes (*NATURE*, October 2, p. 536) that I drew the conclusions of decrease of latitude. In the fuller statement to which I referred, I had expressly said that it was from the Polaris observations that a decrease of latitude might be deduced. The question turns on whether the truest result is obtained by trusting entirely to Polaris, or by including other stars which are at greater N.P.D. and have more variation in the refraction: as the former is less dependent on the most uncertain element of reduction—refraction—I inclined to rely on it entirely. It would be remarkable if the great oceanic circulation should have a mean axis of motion so nearly coincident with that of the earth as not to produce 1/100th of a second change in the Pole during half a century; the presumption would seem against such a fixity.

W. M. FLINDERS PETRIE

Bromley, Kent

### To Find the Cube of any Number by Construction

CAPT. H. BROCARD (of Montpellier), writing to me on the subject of my note in last week's *NATURE* (p. 539), communicates the following two simple constructions:—

1. On two rectangular axes  $Ox$ ,  $Oy$ , take  $A$  on  $Ox$  and  $B$  on  $Oy$ , such that  $\angle OAB = \alpha$ , through  $B$  draw  $BC \perp$  to  $AB$ , meeting  $Ox$  in  $C$ , and draw  $CD \perp$  to  $BC$ , meeting  $Oy$  in  $D$ : join  $AD$ . Then  $\tan OAD = \tan^3 \alpha$ .

2. Take  $BOD = \alpha$ , from  $A$  on  $OD$  erect  $\perp$  to meet  $OB$  in  $B'$ : draw  $B'D \perp$  to  $OB'$ , and let fall  $AC \perp$  to  $B'D$ . Then if we take  $O A' = \text{unity}$  ( $A'$  is the projection of  $A$  on  $OB$ ),  $BC = \tan \alpha$ ,  $A'B = \tan^2 \alpha$ ,  $CD = \tan^3 \alpha$ .

It may be of interest to note with reference to the figure indicated in my construction, that M. Brocard finds that if  $FK \perp$  to  $FD$  meets  $CB$  in  $K$ , and  $A'L \perp$  to  $FA'$  meets  $FO$  ( $\perp$  to  $BC$ ) in  $L$ , then  $LD$  passes through  $H$ .

October 6

R. TUCKER

### THE ASCENT OF WATER IN PLANTS

THE fact that water is taken up by plants and passes off as vapour at the leaves is one of the best known data of vegetable physiology. The current of water passing up the stem of the transpiring plant is known, moreover, to be copious and rapid, and to pass through certain parts of the wood only. Apart from other questions, it has long been sought to explain by what forces this current can be maintained in the plant, and the difficulties which have arisen and been surmounted have been many; certain of these difficulties, however, are still outstanding.

It was an immense stride forwards when the fact was demonstrated that the water absorbed by the roots passes up the stem in the younger wood; and when it was recognised that in the Conifers this consists of definite elongated cells, not openly communicating, and is not complicated by the presence of vessels, &c., the problem promised to be much simpler.

As is now well known, the earlier hypotheses which were made to explain the ascent of water in transpiration have been long put aside, as new facts were observed which could not be satisfactorily explained by them: the

old theory of capillarity succumbs evidently to the facts; and Quincke's hypothesis, though less easily despatched, must also be relegated to the list of past errors.

Two theories, or rather hypotheses, have attracted so much attention lately, that we may fairly regard them as the two rival views for the explanation of the ascent of the transpiration current. The one, especially advocated in its earlier shape by Boehm, seeks to explain the ascent as due essentially to the pressure of the atmosphere acting on a system of air-bubbles and water which can be shown to exist in the plant: this hypothesis, but shortly stated here, is obviously in contradiction to several important facts, e.g. the height of tall trees, and the difficulty of explaining how the atmospheric pressure could act on the closed system of the plant.

The second, and very different hypothesis, is the one recently proposed by Sachs. Assuming that the molecules of water imbibed by the wood cell-walls are held between the complex molecules of these walls in a peculiar condition—very much, in fact, as salt molecules are held between the molecules of water in the sea—then the difficulties in connection with tall trees disappear; for by the peculiar properties of the wood cell-walls it matters not whether a given molecule of water is a yard or a hundred yards high. This hypothesis undoubtedly explains numerous facts, and, if choice lay between it and the theory of atmospheric pressure only, no doubt could exist as to which we should accept; nevertheless, there are objections to it apart from the assumption of such very peculiar properties of lignified walls.

Before saying anything as to the possible modifications of the former theory, it will be well to see how it arose in the first instance.

Jamin, in the *Comptes Rendus* for 1860, published an investigation on some capillary phenomena, and particularly on the behaviour of capillary tubes containing air-bubbles in addition to water.

Suppose an open capillary tube of glass filled with alternating drops of water and bubbles of air. If pressure is exerted at the one open end of such a tube, of considerable length, it is observed that the pressure is not transmitted simply through the system, but that each successive one of the alternating columns of water causes a lessening of the effect. (Of course each column of water, between two air-bubbles, has two concave ends, and the changes produced in these can be observed. Without here going into the explanation of this phenomenon of the apparent disappearance of the pressure, it suffices for our purpose that an open column consisting of air-bubbles alternating with drops of water may be placed upright and the water not flow out. Jamin showed that with long tubes, the water-columns of which were sufficiently broken by air-bubbles, even a pressure of three atmospheres applied to one end failed to move the lower parts of the column. Such a column of alternating drops of water and air bubbles is called a "*chapelet de Jamin*."

It is known that porous bodies, such as gypsum, absorb water with great force: such bodies when saturated with water are very impervious to air, a fact which may be illustrated by means of the wet linen in any wash-tub. Jamin even proposed an explanation of the ascent of water in accordance with these facts, regarding the wood simply as a porous body.

It is not necessary to go into details as to the various modifications of the theories which in any way depended upon ordinary capillary phenomena; enough that the objection that, even if the plant had capillary tubes sufficiently fine to support the water columns required by a tall tree, the water could not flow through them so rapidly as the requirements of respiration demand seemed fatal to any of these theories, and made Sachs's assumption of the extraordinary properties of wood cell-walls appear the more necessary. Moreover, the Conifers have no such capillary tubes in the secondary wood.

It is impossible to put in a short space all the reasons which led Sachs to draw a sharp distinction between the behaviour of water entering into preformed capillary cavities or interstices, and water which is "imbibed," *i.e.* forces its way between the molecules or micellæ of an organised body. It may be remarked that cases may easily be supposed where it would be difficult to draw the line, and it is certainly not easy to see why "imbibed" water should be held less fast than water in capillary interspaces. It is just here, in fact, that the assumption of the extraordinary conductivity of wood comes in.

It is clear, then, that the great difficulty which is to be put aside by assuming, with Sachs, that the water of transpiration is held in a peculiar mobile condition in the substance of the cell-walls, is that of accounting for the great height of the water columns in tall trees. The old capillary theory will not explain this away, because, although the requisite columns of water could be *supported*, the water could not be *moved* as required.

Frederick Elfving brought forward an awkward objection to Sachs's theory a couple of years ago. By stopping up the lumina of the cells and vessels in such a manner that the edges of the cut elements could still be exposed, it was shown that no water could be pressed through a piece of wood. He showed, moreover, that coloured solutions passed into the cavities of the wood-cells through the thin membranes of the bordered pits, but—as must be concluded from his results—not through the thick substance of the walls. Objections have been raised to some details, but it seems difficult to avoid the conclusion that Elfving's results contradict every other view than that the water passes through the thin membranes of the bordered pits, and through the cavities of the elements, and not through the main substance of the walls of the lignified cells.

Elfving has recently published a paper on this subject ("*Acta Soc. Scient. Fennicæ*," t. xiv. 1884) proposing an important modification of the views hitherto held. It is needless to go into the reasons why the theory of gaseous pressures generally must be abandoned, even in its later form, as was Boehm's air-pump theory before; though it is instructive to note that much insight into the physics of the plant may be obtained by a careful study of Boehm's, and especially Hartig's, views, and the various criticisms of them. We may, however, summarise Elfving's remarks, and the chief points for criticism in all the views, as follows.

In advocating the "imbibition theory," no proof is afforded that the lumina of the elements of the living wood are ever *entirely* devoid of water: some water is always present at least in the cells. This does not go against either theory; but the proof that the cells were at any time entirely devoid of water would decidedly support the "imbibition theory."

Enough has already been said as to why we may reject the theory of atmospheric pressure.

Confining our attention to the wood of Conifers, for obvious reasons, the chief facts are as follows. As the young wood-cells lose their protoplasm, water, containing air in solution, occupies the cavity, and bubbles of air are formed alternating with drops of water—in fact, a series of "*chapelets de Jamin*" are formed; only, instead of being simple and in one long tube, each one is complex, and the broken water-columns are confined in closed chambers permeable (to water, but not to air) at the bordered pits, and therefore communicating. One advantage of this is that the "*chapelets*" are less easily broken.

Elfving then passes on to show that, according to Jamin's researches, these columns of water may be of any height likely to come under our consideration: we have thus no more difficulty as to the *suspension* of the continuous columns of water—continuous, that is, in a serpentine course. The molecules of water can pass between

the supporting bubbles of air as if they had no weight, since it is only the movement of the masses of water as a whole in the longitudinal direction which is prevented by the capillary forces in the "*chapelet de Jamin*"; the individual particles of water have perfect freedom of motion, and will of course travel towards the transpiration surfaces.

Elfving then goes on to show that many other facts are explained by his theory, and especially the loss of conductivity for water in branches cut off in the air. We must refer the reader to the original paper, however, for further details.

In conclusion, while there is no doubt that Sachs's ingenious "imbibition theory" of the ascent of the water in plants was startling, on account of the bold assumption of the peculiar condition of the water in the cell-walls, it must not be forgotten that it was suggested after a series of profound researches into the properties of wood, and by a master-mind which had tried all previous explanations and found them wanting; moreover, the strangeness of an hypothesis is in itself no argument, and so long as the "imbibition theory" explains more facts than any other it must be accepted on those terms.

If, however, the theory proposed by Elfving turns out to explain the same number of facts equally well, it will have to be allowed that it rests on a foundation of a very different nature, and which can be experimentally tested. It is not easy to suggest a distinctive name for the latter theory; perhaps it might be known as the "step" theory, since the intra-cellular movement of the water up to the leaves seems to be somewhat of the nature of a series of ascents by steps, or from side to side. We recommend the subject to the careful consideration of those physicists who have an adequate knowledge of the structure of plants.

#### NATURAL SCIENCE IN TASMANIA

ALTHOUGH the scientific energy of Tasmania is not all that could be wished for, still the Royal Society of Tasmania is doing something to keep the flame alive. It is much to be wished that some of its hundred Fellows would devote themselves to an investigation of the flora and fauna of their districts, about which there is still much to be learnt. The *Proceedings* of the Royal Society for 1882 and 1883 have just reached us. The volume for 1882 contains over 180 pages, and is illustrated by four creditably executed lithographic plates. The details of the proceedings at the monthly meetings of the Society are first given, then follow the papers, the more important of which are as follows:—On the fishes of Tasmania, with a classified catalogue of the hitherto recorded species, by Robert M. Johnston. Incidentally he mentions that out of a population of 120,000 persons, it is estimated that about 1050 persons are directly dependent upon the capture and sale of fish. Hobart is the chief centre of the industry. Out of the 188 known species, about one-third are regarded as good edible fish, though only some 21 of these are sufficiently abundant to be ranked as of importance from a food point of view, and of these, some, like the sprat and anchovy, are quite neglected, from want of knowledge and want of energy. Among the so-called fresh-water fish, *Lates colonorum*, though a well-known fish in Australian waters, is confined, so far as is yet known, in Tasmania to one small river discharging into Anson's Lagoon, on the north-east of the island. Though not a sea-going fish, it is chiefly to be found at the mouth of small streams whose connection with the sea is frequently closed by shifting sand-bars; and possibly in this way it became originally acclimatised to fresh water. The fresh-water herring (*Prototroctes marasma*) is said to be the finest of the native fresh-water fishes; chiefly insect-feeders, they give the angler some sport. Some fourteen years ago they suddenly almost disappeared

from most of the rivers where formerly they had abounded, and thousands were seen floating dead down the stream, destroyed apparently by some species of Saprolegnia. It is satisfactory to note that of introduced fish the colonists have now a fine non-migratory trout (brown trout) and a splendid sea-going migratory salmon, the exact species of which is still involved in uncertainty. Among marine fishes special mention is made of the Barracouta (*Thyr-sites atun*) and Kingfish (*Th. solandri*), which abound all the year round; but there would appear to be next to no attempt to cure the fish for the foreign market. Mr. R. Etheridge contributes a paper on Trilobites and other fossils from the Lower Silurian rocks of the Mersey River district, Tasmania. Several new species are described, and the species of Trilobites and Brachiopods are figured. Lieut. Beddome describes sixteen new species of Tasmanian shells, and Messrs. Higgins and Petterd some new species of Antechini and Muridae.

The volume for 1883 contains 65 pages and but few memoirs. Messrs. Higgins and Petterd describe in it some new Tasmanian mice, and the same authors contribute an interesting account of a new cave-inhabiting spider. This species (*Utheridium troglodytes*) was found in a recently-discovered cave in the Chudleigh district. The cave was found to consist of several chambers, in the innermost of which the spiders were found. The floor of the cave is about thirty feet below the level of the present entrance, and is only reached by two well-like descents of from fourteen to sixteen feet each, connected by low passages. There was also found a large deposit of mammalian remains, some in the crevices of the rocks, others embedded in the earthy and stalagmitic floor. These remains can be all referred to non-carnivorous marsupials and mice. It is strange that no insects were found, but the cave would seem to be worth a more detailed investigation, which the authors promise, adding that the stalactites surpassed in beauty those of the well-known Chudleigh Caves.

### EXPLORATIONS IN ICELAND

#### THE LAVA DESERT OF ÓDÁÐAHRAUN

IN about the central region of Iceland, on the northern skirts of Vatnajökull, the largest glacier in Europe, is situated the most extensive occidental lava desert, the Ódádahraun, covering a total area of about 16,000 square miles English. The whole of this wilderness is almost entirely one barren mass of lava, though here and there the traveller may observe patches filled with drifts of sand giving growth to some few stray tufts of upright lyme-grass (*Elymus arvensis*); but frequently a journey may be made through this region for days together without one single blade of grass being sighted. The total absence of vegetation and water in these tracts makes travelling here excessively arduous and risky, and these difficulties are still more aggravated by the elevation of the country above the level of the sea, in consequence of which it may frequently happen, even in the midst of summer, that the traveller is enveloped in blinding snow-storms, which preclude all attempts at further progress while they last. In such predicaments no reliance can be placed on the compass, because of iron entering so very largely into the composition of the lavamasses. Hence this desert has hitherto remained a *terra incognita*, and has never been surveyed; yet volcanoes of gigantic dimensions are found here, and many natural phenomena beside, which command great scientific interest. Not only to the world of science has Ódádahraun been an unknown region, but even the inhabitants of the surrounding country-side have at all times entertained the most vague and ignorant ideas concerning it. For ages they pictured it to themselves as the home of trolls and mountain sprites. Even as

late as the present century it was commonly believed that up among the volcanoes there were to be found verdant valleys containing a whole population of outlaws; a belief which took its rise and received its fortification from the fact that jets of steam issuing from the crevassed mountains were taken by distant beholders for smoke ascending from the chimneys of the abodes of outlaws. The outlaws themselves were pictured to the imagination as either human beings of a savage type, or as some preter-human race of gigantic strength. So firmly ingrained in the people was this belief, that even as late as 1830 an armed expedition was despatched from Mývatn for the purpose of exploring the haunts of these communities of outlaws, the result of which, I need not say, proved discouraging.

In ancient times one of the highways of the country ran across the northern portion of Ódádahraun, which early records show the bishops of Skálholt to have been in the habit of taking on their visitation tours to the east country. This road was used for the last time in 1736, but has been lost since, and now no one is able to point out its locality and direction. Across the southern portion of the lava no attempt at forcing a passage had ever been made by man until a certain adventurer named Pjetur Brynjúlfsson, in 1794, succeeded in threading his way from the East Fjörds westward between the lava and the northern spurs of Vatnajökull, until he struck the road of Sprengisand, which traverses the country right across from the northland to the southland quarter. In 1838 Björn Gunnlaugsson, the famous constructor of the best map of Iceland, undertook a journey of exploration to Ódádahraun, but fell in with such tempestuous weather that all his attempts at exploration were defeated, and he himself barely escaped with his life. Next year he repeated his journey, and, being favoured with better weather, he forced his way from the south up into the boundary line between the lava and the glacier, and pushed on some distance to the eastward. In this trip he attained some positive results. In 1840 a Danish naturalist, Schythe, intending to explore this region, took the same route, but was overtaken by such excessively stormy weather that, after having lost most of his horses, he just escaped with extreme difficulty into the country-side of Jökuldal in the east country. From this time no attempt at reconnoitring this wild country was hazarded until the stupendous explosion from Askja in 1875 gave such surprising evidence of the enormous activity of the volcanoes in these wildernesses. This year Mr. Watts made his way right across Vatnajökul, striking Askja in his descent over its northern spurs. Shortly afterwards Askja was visited by an Icelander, Jón Thor-kelsson, who made his way up to it on foot in the midst of winter. In the summer of 1876 the Danish Government despatched Prof. Johnstrup with a party of scientific men to these volcanic wastes, who explored the region of Askja and constructed a map of the volcanoes. Prof. Johnstrup's is the only scientific exploration that ever yet was carried out in Ódádahraun. At more recent dates Askja has been visited by several English tourists, such as Messrs. Lock, Coles, and Morgan. In 1880 several farmers from the districts of Mývatn and Bárðardal made the complete circuit of Ódádahraun. But, in spite of all such reconnoitring trips, the whole of Ódádahraun is practically unknown yet, with the exception of the corner occupied by Askja.

Instructed by the Government, I have now for several years been engaged in surveying the upland tracts of Iceland, exploring the country geographically, and examining into its geological structure and character generally. This summer I resolved to attempt an exploration of Ódádahraun with such means as I had at my command. With a view to more expeditiously effecting my purpose, I adopted the plan of selecting certain fixed stations on grassy spots here and there about the wildernesses which

surround the lava (the Ódáðahraun), and from each of these in turn, as my base of operations, to undertake trips into and about the lava to such a distance as circumstances in each particular case seemed to warrant. To attempt any comprehensive survey of the whole lava at once, the explorer must be supplied with a far larger stock of ponies than I, with my limited means, could muster, and unless such an expedition can carry sufficient fodder for the animals, any lengthened sojourn in one and the same spot is out of the question. But, by the method of exploration that circumstances forced me to adopt, the result must always come short of one's aspirations.

During the first part of July, which I spent in the country-side of Mývatn, I was engaged in examining the volcanoes of the neighbourhood, which for the most part as yet are quite unknown. I also investigated the geology of the country generally, made collections of insects and plants, and ascended the highest mountain peaks in order both to take the bearings of the mountains about Ódáðahraun, which are visible from Mývatn, and to connect my surveys with such points in the neighbourhood as Björn Gunnlaugsson had formerly fixed trigonometrically. Having finished my outfit and other preparations, I started on July 16, from the place where I am now writing, for the desert. The weather was cold and threatening, with snow-showers travelling along the higher mountain rises. Our first day's eastward march took us over the mountain called Námafjall into the large wilderness of Mývatnsöræfi, which is bounded on the east by Jökulsá í Axarfirði, the longest river in Iceland. Generally speaking this wilderness is covered with old lavas, which are connected with that of Ódáðahraun; but plains of drift-sand open here and there, which are studded with hillocks sustaining tufts of *Elymus arenarius*. In these wilds are found a great number of craters arranged in rows on defined lines from north to south, many crevasses, and rifts floored with earth at the bottom (jarðföll, *i.e.* earth-falls, sinks, or dips), which is but what might be expected, where so many lavas have welled forth from the disrupted bowels of the earth. In this locality there occurred a great eruption in 1875, and in shaping our course to the more southern localities, which were the object of my exploration, we passed close under the northern skirts of the new lava which that eruption created. As the day wore on, a gale of wind arose, and in such a case travelling over these parts ceases to be a pleasure. For some time we had the sand-storm at some distance to the northward before our eyes until it overtook us at last; columnal clouds of brown ashes were whirled into the air, and on joining together in ever increasing numbers the whole view soon becomes enveloped in such dusty darkness that eyesight becomes of little avail; eyes, nostrils, ears are filled with pulverised sand, which is of such a fineness as to penetrate without difficulty even the traveller's clothes; drifts of it find their way into the boxes, and gather together under the saddles and the packing gear on the horses: when in contact with the skin it causes great irritation and general discomfort to the body.

As we proceeded through this wilderness, we were struck by the frequent occurrence of horses' bones, in some cases singly, in others in masses, peeping through the sand between the hillocks. This day, by 11 o'clock at night, we halted in Fjallagjá, a long glen between two rifts, where we found *Elymus arenarius* growing in considerable quantity, but no water; it was a troublesome task to secure our tent in the loose drift-sand, but after repeated attempts we succeeded at last in fixing the pegs tolerably securely in the flanks of the hummocks among the interwoven tissues of the roots of the upright lyme-grass. In the evening the temperature fell to 30°·2 F., and during the night the earth was covered white with snow; our ponies spent the uncomfortable time in con-

stant attempts at running away, which, however, were frustrated by our vigilance. The following morning the same weather continued, still alternating all through the day between sand-storms, snow-showers, hail and sleet squalls. With our view obscured so that we could not take any bearings of the mountains, we still pushed on all day long in a southerly direction, reaching our baiting-place to the south of Her ubreið late at night, in some grass plots along the River Lindaá, a tributary to the above-mentioned Jökulsá, which it joins close on the northern spurs of Herðubreið. The evening came on bitterly cold, and with such a thick fog that even the mountain of Herðubreið in our close neighbourhood was rendered invisible. From this spot, where I remained for a fortnight, I directed my excursions in various directions about the eastern portion of Ódáðahraun. Herðubreið is one of the highest mountains in Iceland (5290 feet), and of remarkably commanding aspect, terminating, towards the top, in a shoulder of precipitous rocks capped with a cone of perennial ice. This mountain, in spite of repeated attempts, has never yet been ascended. In a north-westerly direction from Herðubreið there arises a mountain-range of considerable length, on a line from south to north, which is called Herðubreiðarfjöll or Dyngjufjöll ytri (the outer, *i.e.* northern, Dyngjufjöll), and is utterly unknown. My first excursions I directed to the examination of these mountains. To the south of this range there rises a great volcano called Dyngja, built up of layers of lava with an inclination of 8° to 9° on all sides and rising shield-fashioned to an elevation of 3600 feet; it bears a close resemblance to the famous volcano Skjaldbreið in the south. On the 19th I set out to examine this volcano. Starting in the early morning from my tent on the banks of Lindaá, I had to traverse a lava plateau 1500 feet above the level of the sea, and such was the difficulty of travelling here, that frequently we were on the point of giving up all further attempts at pushing our ponies on, but by dint of perseverance we reached the volcano after a tortuous scramble of four hours and a half. The layers of lava forming the slopes of this volcano are excessively rough and of peculiar formation, all split up into fissures from north to south or hollowed out by caves and lava bubbles. Wherever the foot is planted the ground sounds hollow; in every direction there are innumerable hornitos, seemingly formed originally of a variety of strands of the fiery ooze twisted into all sorts of fantastic shapes, the outer surface suggestive of a tangle of intertwined snakes of inordinate thickness. When we had made the ascent half way up the mountain, we were overtaken by fog and snowstorm, so that in a short time all objects were hidden out of view and the earth covered with snow. Still in the expectation of the fog clearing away, and the snowstorm blowing over, we went on, and after two hours' brisk walk reached the summit of the volcano. Here all was covered with ice and snow in a temperature of 28° F. Although the blinding snowstorm prevented anything being seen, I set my theodolite on the chance of the darkness clearing, and had to wait for an hour and a half shivering in the biting blast, when the weather so far cleared that I could take the bearings of several surrounding mountain peaks. This volcano has never been ascended by any man before me, nor would the fact have been passed over in silence, if such had been the case, for even in Iceland the activity of fire has hardly left any traces behind comparable to what is witnessed here. The original crater is 1500 to 1600 feet in diameter, and has, some time subsequent to its first formation, been filled with masses of lava, and now exhibits in the centre a large patch of lava round the circumference of which there stand twelve peak-formed lava columns. In the centre of this plain again there is an enormous crater 400 to 500 feet in diameter and 600 to 700 feet deep. It is hardly possible to picture to the imagination any sight more stupendous than that which

opens to view by looking over the verge of this crater down into the precipitous abyss. The crater, with its bottom covered with snow and the sides all whitened with a glacial crust, suggests to the beholder a gigantic cauldron hollowed out in marble. Enormous rocks, which have tumbled down from the brim of the crater, look like minute black specks against the whiteness of the bottom. The composition of the lava is practically entirely basaltic; but reddish rocks of trachyte are strewn about the circumference of the original crater, which shows that sometimes trachytic eruptions have taken place here, as in Askja in 1875. When the weather cleared, I had distinctly in view the greater part of Ódáðahraun as well as Dyngjufjöll proper, and all the lava currents which have taken their course from the latter complex of volcanoes. In a north-westerly direction from the above-described volcano is another, lower, but quite as wide in circumference, to which we gave the name of Kerlingar-Dyngja. Having surveyed Dyngja, we returned the same way we had come, and reached our tent at half-past two o'clock the next morning.

In a southerly direction from Herðubreið there extends a very considerable mountain range, 3,400 feet high, which is called Tögl (Tails); it is separated from Herðubreið by a narrow gate through which, once upon a time, a lava current has found its way. Thus Herðubreið is surrounded by lava on all sides, though that mountain itself is no volcano, but a pile of coarse palagonite breccia interspersed with stray thin layers of basalt throughout its lower parts. One of my excursions I directed to the Tögl. From the tops of these mountains an extensive view opens southward over the sands along the course of Jökulsá and the northern region of Vatnajökull. The aspect of the country to the south of Herðubreið is truly forbidding, all covered with the yellow-gray scoriæ from the explosion of Askja in 1875, generally one to two feet in thickness, and no sign anywhere of vegetation. The whole southern horizon exhibits the vast expanse of the snow-white glacial bolsters of Vatnajökull, out of which, in a northerly direction, rises the enormous complex of volcanoes called Kverkfjöll. In some fiery convulsion this mass of mountains has split from end to end, and through the rent a glacier has found its way right down to the level land below. To the west of this rent I observed in the jökull a mass of craters, from one of which huge clouds of white steam ascended into the air. Nothing is known about the volcanic activity in this spot, no one having ever visited those parts of Vatnajökull. On the western side of Kverkfjöll the jökull is one flat ice plateau all the way down to Ódáðahraun, skirting into a number of moving glaciers terminating in sands and extensive moraines, from which flow innumerable affluents to Jökulsá in Axarfjörð. Towards the east, about the approaches to Sandfell, the next highest mountain in Iceland (5800 feet), the jökull exhibits sharp-cut black vertical walls, probably ledges of underlying basaltic belts; but further to the west the flatness of the jökull owes its formation to the substratum being made up of palagonite tufa, a softer and more easily ground material. Our western view was determined by a part of Ódáðahraun, southern Dyngjufjöll, Askja, and the southern parts of Herðubreiðarfjöll. At the southern termination of Dyngja there rises a very peculiarly formed tufa "fell," along the crest of which is to be observed a row of a number of vertical tufa peaks, each from one to two hundred feet high, so that the outline of the mountain gives the impression of a gigantic hedgehog.

Next day I set out on the examination of Herðubreiðarfjöll. Directing our course to the north-east, we ascended on our way a mountain by the banks of Jökulsá called Ferjufjall, near which, as the story goes, there was a ferry in those olden times, when the bishops were in the habit of taking that road over the northern skirts of Ódáðahraun, to which I have alluded already. In a north-

westerly direction from this place excessively ancient lavas come to view, which are clearly older even than the Glacial period, exhibiting everywhere large and unmistakable signs of glacial abrasions. In this excursion we came upon a row of those beacons which by general custom in Iceland are erected to point out where roads run through wildernesses. Most of these beacons were but cumuli of stones; one, however, we found still standing, covered with moss and lichens. This we knew now must be the eastern end of the long-lost road, an assumption which subsequent discovery corroborated. As we approached nearer to Herðubreiðarfjöll we came upon a series of craters surrounded by a recent lava, and so rough that no horse might cross it, almost impassable even for a traveller on foot. Leaving our ponies behind, we made our way across this lava, however, as best we could, and reached the highest crest of the mountains shortly before sunset, and enjoyed from it an extensive view. All about these mountains, which are composed of palagonite breccia, there is a number of ridges observable, with small dales and narrow dips scooped out between them, all, however, totally barren of vegetation. About the central portion this range sinks down into low necks honeycombed with many large craters, from which floods of lava have spread over the surrounding country on both sides, east and west, covering an area of some tens of square miles. Having completed my survey of this region, we returned and joined our ponies shortly after midnight, all scratched and lacerated from the lava, with our shoes and stockings in shreds.

TH. THORODDSEN

Reykjahlíð, near Mývatn, August 4

(To be continued.)

#### THE CONNECTION BETWEEN CHINESE MUSIC, WEIGHTS, AND MEASURES

CHINESE music can now be heard by all who desire to hear it at the Health Exhibition, and more may be learned on the subject from the pamphlet published by the Commissioners for the Chinese department. A curious account of the common origin of Chinese weights, measures, and musical notes is contained in a paper read some years ago before the German Asiatic Society of Japan by Dr. Wagener. The story is based on native legends, and is also to be found among the Jesuit "Mémoires concernant les Chinois." Dr. Wagener says there is not the slightest doubt that the Chinese system of weights and measures is more than 4600 years old; and it is a highly remarkable circumstance that, quite irrespective of the fact that it is more scientific and exact, it possesses all the advantages for which the French metrical system is so much praised. In the first place, it starts from a basis supplied by Nature; secondly, the decimal arrangement is almost consistently employed throughout; thirdly, linear and dry measure proceed directly from the same unit as the measure of weight; and lastly, what the metrical system does not do, it regulates in the simplest manner the relations of musical notes, which latter form the starting-point for the whole system of weights and measures. The following account of the origin of this system (says Dr. Wagener) contains fact and fancy mingled, but it is easy to distinguish between them. In the reign of the Emperor Hoang-ti, who ruled over China in the twenty-seventh century before Christ, the scholar Lyng-lun was commissioned to complete the musical system which had been discovered 250 years earlier, and particularly to lay down fixed rules for making musical instruments. Naturally he had to commence with the bamboo, which had already been long used to give the note for other instruments. He therefore betook himself to the province of Siyung in North-Western China, where, on the northern slope of a range of

high mountains, a species of bamboo grew, which, on account of its uniformity and its structure, being neither too hard nor too soft, was exceedingly suitable for a wind instrument. He cut one down and tried it. Tradition says that it gave the same note as his own voice when he was excited by no emotion; and the rippling of the sources of the great Hoang-ho, or Yellow River, which were in the vicinity, followed in the same tone. At the same time the fabulous bird Fung-Hiang, accompanied by his mate, flew to the place. Both perched themselves on a neighbouring branch, and commenced a song, in the course of which each of the birds gave six separate notes. These are the notes which are called the six male and six female tones in the scale discovered by Lyng-lun, and which correspond to the ancient doctrine of the male and female principles in Nature. As a matter of course, the deepest of the male notes was the one already discovered by the philosopher himself. He now endeavoured to reproduce the other notes with the help of bamboo pipes, and succeeded. His task was now to lay down fixed rules as to the length of the pipes, so that thenceforth they could be easily constructed everywhere. For this reason, and also because such a scale of notes depends upon slight differences of length, and there were scarcely at this time instruments to divide great lengths, he necessarily arrived at the notion of passing from the less to the greater, and of laying down an adequately small natural unit for his measurements. That could be nothing else but a grain of seed; and now the point was to get seeds of the greatest possible uniformity. He chose a sort of millet, the *Sorghum rubrum*, the seed of which is of a dark brown colour, and which is said to possess the advantages of greater hardness and uniformity than that of the gray and other kinds. The seed is pointed at the ends, and from one point to the other the length is somewhat greater than in the direction at right angles. Lyng-lun now fixed the length of the pipe, which gave the keynote at 81 grains of the seed placed lengthwise in a row. But when the grains were placed breadthwise it took 100 grains to give the same length. Thus the double division of  $9 \times 9$  and  $10 \times 10$  was naturally arrived at. According to the dimension in question, it was called a musical or an ordinary foot, the latter being introduced with the decimal subdivision as a measure of length. The breadth of a grain of seed was 1 *fen* (a line), 10 *fen* = 1 *tsun* (an inch), 10 *tsun* = 1 *che* (a foot), 10 *che* = 1 *chung*, 10 *chung* = 1 *ny*. In subsequent times the line was divided into tenths, hundredths, &c. Lyng-lun also laid down rules for the breadth as well as for the length of the pipe, because, although the note is essentially dependent on the length, it is nevertheless necessary for its purity that the pipe should be neither too broad nor too narrow. He therefore fixed the circumference on the inside at nine grains laid lengthwise. With these dimensions, namely, a length of eighty-one grains, and an internal circumference of nine, the pipe which gives the keynote contains just 1200 grains, and this volume accordingly was made the unit of dry measure, and was called a *yo*: 2 *yo* = 1 *ko*, 1 *ko* = 1 *cheng*, 10 *cheng* = 1 *ten*, 10 *ten* = 1 *hu*. So far we see how the units of length and dry measure were connected with the musical keynote. The twelve notes of the scale are all derived from the keynote, and are to a certain extent comprehended in it. Hence if the 1200 grains contained in the pipe are divided among the twelve notes it gives to each a hundred, and the weight of these hundred grains was made by Lyng-lun the unit of weight. This was divided and subdivided on the decimal system until a single grain became the lowest weight of all. At a later period even the coinage became connected with this system, for one of the weights, the *leang*, corresponding to our ounce, became the weight of metal put into a coin, so that the modern *tael*, in which mercantile quotations are found every day in the *Times*, is merely an ounce of silver, and is thus directly con-

nected with the musical scale. Finally, says Dr. Wagener, it appears from this account that, in China, weights, measures, coinage, and the tuning of musical instruments have been derived quite consistently from a constant unit supplied by Nature herself, and that the essentials of this system are over 4600 years old.

### NOTES

THE Queen has been pleased, through His Grace the Duke of Richmond and Gordon, to intimate a subscription of 25*l.* to the Scottish Marine Station for Scientific Research, Granton, Edinburgh.

THE Washington International Prime Meridian Conference discussed at length on Monday a resolution for adopting the Greenwich meridian, which several American and British delegates advocated. M. Janssen, the French delegate, opposed the motion in a long address, arguing in favour of what he called a "neutral" meridian, and suggesting that the prime meridian should run, either through Behring Straits, or one of the Azores. After some further debate the Conference adjourned subject to the call of the chairman. No opposition to the election of Greenwich was shown excepting by France, but doubts are expressed as to whether the Conference will have any result.

ACCORDING to the *Standard's* Calcutta Correspondent, the Commission under the direction of Dr. Klein, appointed by the Indian Government to examine into the cholera question, is satisfied that Dr. Koch's microbe is not the cause of the disease. The Commission is still continuing its inquiries, but so confident is Dr. Klein on the microbe question that he swallowed a number of them without any evil results.

"THE Philadelphia meeting of the American Association," *Science* states, "is credited with being the most successful up to this time. The total attendance was 1249. Great Britain contributed 303; Pennsylvania, 246; New York, 161; Massachusetts, 87; District of Columbia, 84; New Jersey, 58; Ohio, 57; Connecticut, 32; and Virginia, 22. The membership was increased nearly 25 per cent., 515 new members being elected, the number of members up to this meeting being 2033. The number of papers read was larger than ever before, and it is to be hoped that the weeding-out of the trivial matters so often offered was carried to a greater extent than usual. There was a general feeling that there was too much going on. A large portion of the physicists were engaged as examiners at the Electrical Exhibition, and were, of course, interested in the meetings of the Electrical Conference. Somewhat less science, and somewhat more time to enjoy the junketing, would be more in accordance with the desires of many, if one may judge from the opinions expressed on the way home. A proposition to confine the reading of papers to the mornings would have met with many supporters."

IT would seem that the International Scientific Association, which it was proposed at Philadelphia to organise, has been really founded. *Science* informs us that it has now a more assured existence, thanks to the fund of twenty thousand dollars which will be established through the liberality of Mrs. Elizabeth Thompson. Of this fund five thousand dollars have already been paid to the Association, and five thousand more will be paid next year on condition of ten thousand being raised from other sources. The income from this fund is to be devoted to research. Not only did Mrs. Thompson give liberally to this new Society, but she also gave one thousand dollars to the American Association for the Advancement of Science, to be used in researches on light and heat. Mrs. Thompson takes great interest in the recent marvellous advances in the application of electricity, and felt a desire to contribute, as far as lay in

her power, to the advancement of our knowledge of the forces of Nature. Appreciating the unity of energy, whether displayed as heat or light or electricity, Mrs. Thompson gave the money for researches as to the nature and sources of light and heat, in the hope that more may be learned of the connection which may exist between heat and light and electricity.

PROF. COSSAR EWART has sailed for the United States on a semi-official mission connected with the Fishery Board. He is to make full inquiry into the fishery regulations of the United States, to examine the fish hatcheries there, and otherwise to gather all possible information on the subject upon which he was engaged at home during last winter and spring with so much energy and success.

THE death is announced of Dr. Leopold Fitzinger, formerly custodian of the Zoological Court Cabinet at Vienna.

THE latest news from the Lena Meteorological Station at Sagastyr appeared in the last issue of the St. Petersburg *Zvezdita*, dated January 3 and February 14. The small-pox, brought last year from Yakutsk, has made great ravages among the already scarce population of the delta. Nearly all (seventy) Yakuts living at Bouloun have died from the epidemic; and in the three settlements at Cape Iyloff forty persons died from it; even at Kytakh, close to the Meteorological Station, a Yakut who had fled from small-pox died in December last. The staff of the Observatory were quite well in February, and, with their provisions of fresh meat, were not afraid of scurvy. The magnetic storms were not so strong nor so frequent as last winter. The greatest cold witnessed in December was  $-48^{\circ}$  C., and, on the whole, the winter was far milder than last year. Frosts below  $-40^{\circ}$  were rare, and temperatures as low as  $-52^{\circ}$  were not witnessed this winter. The average temperature of February was only  $-33^{\circ}$ , instead of  $-41^{\circ}$ , as it was in 1883. On the contrary, strong winds were more frequent than last year.

THE new astronomical Observatory in Hong Kong appears to be now in full working order under Dr. Doberck. We have received its usual monthly weather reports, containing copious observations on the barometric pressure, temperature, temperature of evaporation and radiation, relative humidity and tension of aqueous vapour, duration of sunshine, rainfall, duration and velocity of the wind, &c.,—in all, fifteen tables. The meteorological work, especially when taken in connection with that of the Observatories at Siccawei, Manilla, and Tokio, and the observations at the various Chinese Customs stations and lighthouses must be of great value. For the benefit of shipmasters the Astronomer publishes daily a *China Coast Meteorological Register*, giving a summary of the atmospheric circumstances along the coast of China.

AT the same time as the German Association the German Meteorological Society met at Magdeburg and held a public meeting on September 20. Prof. Neumayer spoke on the development of meteorology and its importance in the life of nations. The following gentlemen were elected honorary members of the Society:—Prof. Buys-Ballot (Utrecht), W. Farrel (Washington), J. Hann (Vienna), G. Mohn (Christiania), A. Mühry (Göttingen), and E. E. Schmid (Jena).

PHYLLOXERA has made its appearance in the Pomological Institute of Proskau (Silesia). It is hoped, however, that the spread of the disease may yet be prevented.

THE Russian University of Kief has elected Profs. Kolbe, Helmholtz, Kirchhoff, Pettenkofer, and Hoppe Seyler as honorary members.

A COMMITTEE has been formed at Lucerne with a view of erecting what is called a "universal column." It is to measure 300 feet in height, and is to contain in its interior relief portraits

of all the celebrated men and women of the present era on bronze tablets. Another project of the Committee is the building of a "museum of the nineteenth century," to be dedicated to art, science, inventions, commerce, and industry, and to contain the busts and statues of all distinguished persons in these domains. The cost is estimated at seven to eight million francs (280,000*l.* to 320,000*l.*), and is to be met by subscription, lotteries, &c.

THE old lighthouse erected by Smeaton upon the Eddystone rocks 125 years ago, recently replaced by a new lighthouse, has been re-erected upon the Plymouth Hoe. It was opened on September 24 with appropriate ceremony.

PROFESSORS and teachers of mechanics and mechanical engineering have the greatest difficulty in getting suitable models to illustrate the different machines, and combinations of parts, under discussion in their classes; diagrams go a long way as a means of illustration, but appear sometimes very complicated, more especially when the paths of the moving parts are drawn. Take, for instance, the link motion of the locomotive,—the diagram of the motion showing the relative positions of the different parts, when one of the cranks is placed in eight different positions in its path, is very complicated; when a model is used all this vanishes, the action being very simple, and perfectly plain to the average student. Then again the various arrangements of spur-driving gear, nest-gearing, and similar appliances, are very soon understood when illustrated with a model; with a diagram, or drawn on a blackboard, they look complicated and confusing. Perhaps the best and simplest form of demonstrating mechanics is by means of scale models, saving the teacher many long descriptions, and giving the student at once the best possible opportunity of understanding the construction as well as the motion of the different parts. We have before us an Illustrated Catalogue of Apparatus for Technical Instruction, &c. (manufactured by James Rigg, engineer, Queen Victoria Street), issued to meet the demand for appliances required in the various branches of technical education. The grouping of the several subjects is similar to that adopted by the Science and Art Department, the corresponding number of the Government list of 1883 is given side by side with the catalogue number, and the selection of models is decidedly good. The index includes all the subjects generally taught in technical classes. The models are constructed to secure strength and durability, without unnecessary finish, thus placing before the public a valuable series of models for the advancement of technical education at a moderate cost.

THE Japanese Government nominated Mr. Kikuchi Dairoku to attend the Meridian Congress at Washington. This gentleman is a Cambridge Wrangler, and at present fills the Chair of Mathematics at the Tokio University. It says not a little for the scientific advance of the Japanese that they can find one of themselves qualified to represent them at such a scientific meeting as that now being held at Washington.

WE have received from the Commissioner for Japan to the Health Exhibition a catalogue, with explanatory notes, of the exhibits of the Japanese Education Department now at South Kensington. It is not, we believe, generally known that the Japanese section was intended to have been much larger, and the articles were actually shipped from Japan; but owing to a fire on board the steamer by which they were being conveyed, they were spoiled. The loss was chiefly among the appliances, designs, &c., relating to art education, silk-weaving and embroidery by girls at the industrial schools, and specimens of work in bronze by the deaf-and-dumb. The pamphlet before us is much more than a bare catalogue; it is much more a long series of notes on Japanese education and educational appliances past and present, those dealing with the past being by far the



more interesting. On p. 27 we notice a curious statement. No. 61 to No. 85, says the catalogue, are works published by the University of Tokio. "As English translations accompany many of them, the visitor will be able to gather at once what they treat of," in other words, it is implied that the works were originally written in Japanese, and were afterwards translated into English. This is wholly incorrect; the works which are spoken of as "translations" are the originals, and were written by European gentlemen (whose names, by the way, are suppressed) in the educational department of Japan. Most of them were noticed at the times of their appearance in our own columns. They are all works of high scientific value, and their publication reflects much credit on the University, but, if any remark were necessary at all, it should have been that the Japanese was the translation, and the English the original, and not as stated in the catalogue. Exhibits 86 to 103 are the theses of the students in chemistry presented on graduation, and here the writer's name is in every case given. These papers are no doubt creditable in their way; still they are only the ordinary work of good students, while the others approach in many cases to the dignity of considerable volumes, and represent much labour and knowledge. Yet here the authors' names are withheld, and they are actually spoken of as translations. The writers were men whose names will long be connected with Japanese educational advancement—Messrs. Morse, Knipping, Korschelt, Ewing, and others—and the Commissioner can hardly have been ashamed to have their names in his catalogue, for all who know anything of Japanese education know how much science in Japan is indebted to the labours of these and others like them. Probably quite unintentionally there is not only the *suppressio veri* but also the *suggestio falsi* in the catalogue under this head.

At the Working Women's College the opening address for the year to students and friends will be delivered in the Maurice Hall of the College, 7, Fitzroy Street, W., to-morrow (Friday) night at 8 p.m., by Mr. George Macdonald. Those interested in the work of the College are invited to be present.

MESSRS. LONGMANS AND CO. announce the following publications as forthcoming:—"Louis Pasteur, his Life and Labours," by his Son-in-Law; translated from the French by Lady Claud Hamilton. "The Science of Agriculture," by F. J. Lloyd. "Custom and Myth; Studies of Early Usage and Belief," by Andrew Lang, M.A. "A Manual of Telegraphy," by William Williams, Permanent Assistant to the Director-General of Telegraphs in India. "Above the Snow Line: Mountaineering Sketches between 1870 and 1880," by Clinton Dent, Vice-President of the Alpine Club.

WE have to record the death of M. Bourdon, the inventor of the metallic barometer and manometer which are so largely used.

IN the report last week of the paper read by Prof. Ramsay and Mr. Sydney Young before the Chemical Section of the British Association, "On Evaporation and Dissociation" (p. 551), in the sentence "as the dissociation *increases* the curves approach, &c.," "increases" should be "decreases." In Mr. Nicols's letter on "Salmon-Breeding" (September 25, p. 513, col. 1, line 13 from top), *parrs* should be *pairs*.

THE additions to the Zoological Society's Gardens during the past week include a Lesser White-nosed Monkey (*Cercopithecus peanrista* ♂) from West Africa, presented by Miss Ethel A. Hut'on; a Bonnet Monkey (*Macacus sinicus* ♀) from India, presented by Mr. W. Phillips; two Great Bats (*Vespertilio noctula*), British, presented by Capt. W. St. George Ord; a Horned Lizard (*Phrynosoma cornutum*) from Texas, presented by Mrs. S. Russell; an Erxleben's Monkey (*Cercopithecus erxlebeni* ♀) from West Africa, a Common Marmoset (*Hapale jacchus*), a Black-eared Marmoset (*Hapale penicillata*) from South-East

Brazil, a Pig-tailed Monkey (*Macacus nemestrinus* ♀) from Java, two Small Hill-Mynahs (*Gracula religiosa*) from Southern India, a Blue-bearded Jay (*Cyanocorax cyanopogon*) from Para, an Alligator (*Alligator mississippiensis*) from the Mississippi, deposited.

### PHYSICAL NOTES

M. GARBE has laid down the two following laws in connection with Lipmann's capillary electrometer:—(1) The capillarity constant of mercury is greatest when the electrical difference at the meniscus is *nil*, and, as a rule, its value is independent of the sign of this difference. (2) The electrical capacity at a constant surface of an electrode plunged in a liquid is purely a function of the electrical difference, independent of the sign of that difference, and is least when that difference is *nil*.

M. BEETZ has made a standard cell which is a modified form of Latimer Clark's mercurous sulphate cell. It consists of a tube in which a compressed cake of mercurous and zinc sulphates is placed; at one end of the cake the zinc pole is placed, and at the other end the mercury pole. On short-circuiting the following results were obtained:—

5 minutes ...	1'440 volts	6 hours ...	1'437 volts
1 hour ...	1'439 "	12 "	1'434 "
4 hours ...	1'439 "	48 "	1'408 "

The resistance was 15'700 ohms.

M. DECHARME has made some experiments comparing a drop of water falling on to a surface of glass, which he had covered with a thin layer of minium so as to preserve forms obtained, with a rifle bullet striking a target. He found a striking analogy in the results.

M. FOUSSEREAU has found the specific resistance of distilled water, in the same apparatus, to vary from 118,900 to 712,500 ohms, that is to say, in the ratio of 1 to 6. He accounts for this in three ways: (1) by the solution of the surface of the containing vessel; (2) by the solution of matter from the air; (3) to the effect of the dissolved matter during distillation. On the first point he found that at 15° C. after standing in a glass vessel for forty eight hours the resistance fell 1/30. At 30° C. the change was more rapid, and at 75° C. the resistance varied, so that he was unable to make any measurements. The solution of gases from the air had only a small effect. On the third point great care was observed. Experiment proved that the addition of 1/1,000,000 of potassium chloride reduced the resistance 1/3; according to M. Bouty, hydrochloric acid is five or six times as powerful. In respect to ice, M. FousserEAU found that at the moment of congelation] the resistance increased nearly 15,000 times, and continued to increase as the temperature fell. Thus ice at -1° C. has a specific resistance of 4865 megohms, and at -17° C. 53,540 megohms. A sample of ordinary water gave 65 times the conducting power, whilst the ice from it was from 30 to 40 times as conducting.

HERR WARBURG has succeeded in electrolysing glass; the method that he adopted is as follows:—He heated a piece of soda lime glass to about 300° C.—at which temperature it is a conductor—and placed it between mercury electrodes. It was necessary to use from 15 to 30 Bunsen cells for a long period. He then found that at the anode side of the glass he had a layer of silicic acid; this layer very quickly reduces the strength of the current owing to its bad conductivity.

M. DUTER has made some very interesting experiments on magnetic shells. He finds that, if thin disks of steel be placed in the field of a powerful electro-magnet so as to magnetise them through from face to face, when they are removed from the field, they have almost entirely ceased to be magnets; but the faint trace left still showing that the disks were magnetised as shells. Again, M. Duter built up a series of steel disks, either separated by thin paper or cardboard, or placed directly together. This series was then magnetised with the disks in the same position as before: now on removing the whole from the field he found he had a permanent magnet, fairly powerful and regularly magnetised. His next step was to take the magnet to pieces by separating it disk from disk; each disk was then found to have almost ceased to be a magnet, but on placing them together again he found that he still had a permanent magnet, but weaker than before.

M. BOUQUET DE LA GRUYE has invented a multiplying seismograph. The instrument has been fixed at Puebla, and a series of observations made during November and December 1882 show twenty-two abnormal movements in one month, probably seismic, only one being felt at Puebla. The sun and moon have been proved to have a direct action on the pendulum, the sun repelling it and the moon attracting it.

M. A. RIGHI has published a paper in the *Journal de Physique* on "The Influence of Heat and Magnetism on the Electrical Resistance of Bismuth." He says that the resistance of bismuth increases between some temperatures and decreases between others. These variations can be drawn in a curve which shows a maximum at a low temperature, then a minimum, again another maximum just before fusing, and a second minimum whilst in a liquid state, this minimum being in value about one-half the foregoing maximum. The positions of these maxima and minima vary with the physical conditions of the bismuth; if the bismuth be cooled rapidly, the two maxima approach one another until they even merge together, and the curve becomes similar to a parabola. In the first case the two maxima occur at  $-40^{\circ}$  C. and  $240^{\circ}$  C., the intervening minimum being at  $115^{\circ}$  C. In the case of rapidly cooled bismuth the single maximum is at  $50^{\circ}$  C. These results only occur in commercial bismuth, and are more exaggerated as the bismuth is hardened in the preparation, wire showing them more than castings, and cold drawn wire more than hot. Pure bismuth behaves like an ordinary metal. The resistance of bismuth either pure or commercial is increased in the magnetic field; in some experiments the increase has been one-eighth of the original resistance. The increase in resistances is generally proportional to the magnetic force, and decreases with a rise in temperature.

In a recent paper by M. Planté, he gives the result of some experiments made to arrive at the cause and explanation of ball lightning; he was led to these experiments by having one of his mica condensers destroyed by a similar phenomenon. He charged one of his condensers from his secondary battery of 300 pairs, when the condenser was pierced, and instead of a bright spark a small incandescent globule was formed, which moved slowly over the surface of the condenser, following the parts where the insulating layer had least resistance, and destroying the metal film; the path being most curious and erratic. This motion continued, and the globule lasted one or two minutes, until the batteries ran down. In the case of a condenser in which the insulating material was ebonite, a sound was emitted similar to a toothed wheel being rapidly rotated against a piece of cardboard or sheet metal; at the same time there was a strong smell similar to that produced when ebonite is burnt. M. Planté repeated this experiment with 1600 secondary cells, which gave an electromotive force of 46,000 volts, and obtained similar but much more complicated result. The second experiment made was to make a condenser of two flat pads of paper moistened with distilled water and brought near together so as to form an air condenser; now on connecting this condenser with his battery he obtained an incandescent globule which moved about between the pads and passed from one to the other. In this case he noticed that if the pads became dry at any point the globule disappeared, but either appeared at some other point, or at the same point again, as soon as it again became damp. In this experiment he found that the globule lasted a much greater time than in the case of the mica condenser, which fact was owing to the greater resistance in the condenser plates which did not allow the battery to discharge so rapidly.

### GEOGRAPHICAL NOTES

To the *Bollettino* of the Italian Geographical Society for September Prof. Bellio contributes an account of a curious manuscript by the Sicilian missionary Fra Teramo Castelli (1597-1659), who spent the better part of his life in Transcaucasia. This altogether unique work comprises seven thick folio volumes, originally preserved in the Theatine Convent, Palermo, but, after the suppression of the religious orders, rescued from destruction and removed by P. di Marzo to the municipal library of that city. Its peculiar character will be at once evident when it is stated that there is no written text, the volumes containing nothing but pen-and-ink sketches and their illustrations, accompanied by brief legends or explanations mostly in Italian or indifferent Latin, but occasionally also in

Greek and Georgian. This method was deliberately adopted by the author or artist to convey his impression of men and things, because, as he naively remarks, "we thus see at a glance the fact, which, if written out, would take up much time both of the writer and of the reader." Of the designs, of which there are altogether 1176, 347 are of little value, being occupied with mystic, devotional, or ascetic subjects. But all the rest are highly interesting, especially to students of geography and ethnography. The two regions chiefly illustrated are Mingrelia (basins of the Rion and Ingur) and Georgia proper (basin of the Kur), jointly stretching from the Euxine to the Caspian, and bounded on the south by Armenia, on the north by "the kingdom of Astacan," that is, the Tatar khanate of Astrakhan. Mingrelia is identified with the ancient Colchis, while Georgia, "quæ Gurgistan barbaris dicitur," is said to comprise not only Iberia, but also a part of Greater Armenia and a portion of Atropatia, or Atropæene. Frequent allusion is made to the great fertility, rank vegetation, and moist climate of the low-lying tracts, whence arise "dropsy, extremely dangerous tertian and quartan fevers, causing worms to abound in the stomach and flesh of the people, on which account they consume vast quantities of salt." They are otherwise described as Christians of the Greek rite "with a little difference," very numerous and warlike, especially the highlanders, still sometimes wearing armour, and endowed with great physical beauty. There is a portrait of a certain Mamia "Gorielis Princeps Armatus," mounted on a charger, and dressed in a complete coat-of-mail, with high boots, helmet, plume, spear, and shield. It is curious that this practice of wearing armour still lingers among the Khevsur highlanders of the same region. A striking contrast to the Gorean warrior is presented by the picture of Vommissa, a poetess wearing a simple robe, a double row of pearls round her neck, a head-dress also fringed with pearls, and a rich mantle lined with fur. She holds a quill in her right hand, a scroll of paper or parchment in her left, and round about are disposed an ink-bottle, more paper, a penknife, a pair of scissors, and a vase apparently containing perfumes. Another lady, the Princess Lipardiani, is provided with a fan somewhat in the shape of a violin, with a little square mirror let in at the narrow part, exactly of the same form as is still fashionable in the country. "According to the seasons they gather the harvests of barley, millet, grapes, and nuts," is a legend occurring under one of the numerous designs representing peasants reaping corn as high as a man and making sheaves such as are commonly seen in Italy. Elsewhere is figured a scene in a market town with the explanation: "Trade is carried on by barter; one hen for two pounds of salt, one sheep for two hens, one sword for two goats, one horse for three oxen," adding that all these values are determined by official tariffs. Amongst the sports is one called *trocus*, which from the accompanying description seems to be identical with the game of polo recently introduced into England from the East. "Four horsemen gallop about playing with a ball the size of an orange, which they endeavour to pick up from the ground, hurl into the air, and drive forward with a racket." Then it is added in Latin: "Equites ludentes hoc pacto ut aspicias rarissimi sciunt se ipsos gerere, requiritur agilitas quedam cum certo determinato impulsu ita ut si plus aut minores ponuntur spiritus non bene ludunt sæpeque quasi novi *setolontes* cadunt in terra ab altis equis cursoribus." Under several characteristic portraits of natives occur Latin verses pointing out how the mental faculties and moral tendencies may be deduced from the form of the head and expression of the features, thus anticipating the doctrine of Lavater. Of forty-six designs figuring the Sultan and his Court, his army and chief subjects, several are of considerable ethnological interest, comprising portraits of Persians, Arabs, Tatars, Egyptians, Circassians, Indians, Chinese, Portuguese, and other nationalities. Appended to these figures is the, for the times, remarkably liberal sentiment that all nations have good and bad qualities irrespective of their religions, and that the Chinese have a good system of philosophy and theology, although different from that of Christian peoples. Prof. Bellio's paper is enriched with a large number of facsimiles conveying an excellent idea of these curious volumes.

THE two last numbers of the *Russische Revue* contain articles on the little-known peninsula of Kamchatka, its geography, natural resources, and the history of its conquest. The districts adjoining the sea are so mountainous as to be almost uninhabitable. There is, indeed, one magnificent harbour in Awachinskaya Bay, and on this stands Petropaulovski. A chain of volcanic

mountains, some of them reaching to a height of 5000 feet, runs down the centre of the peninsula, and through this the large navigable river Kamchatka makes its way to the Pacific Ocean. The valley of this river is the most cultivated portion of the district. The hills are covered with forests of fir, larch, cedar, birch, &c., and in these are found numerous wild animals, such as the fur sable, the otter, foxes of all colours, and the bear, which latter, on account of the great supply of food, attacks neither man nor the domestic animals. It is curious to note that the squirrel, which is universal in Siberia, is not found here at all. Swans, wild ducks, &c., are found in great quantities in the lakes and marshes in the interior, and their eggs, as well as the birds themselves, are taken in great numbers by the people. The fish which throng the rivers in enormous numbers in the summer form the principal food of the natives. For the most part they are salmon (*Salmo salar*), and are dried and stored up for the winter; but owing to the scarcity and dearth of salt the fish frequently become rotten, and the people suffer great privation. The rigour of winter is much softened by warm ocean currents, which create those thick continuous fogs that render the coast so dangerous to navigation. The total population of both sexes is put down at only 6500 souls, but owing to the total absence of agriculture, and to the primitive methods adopted for preserving food for the winter, these are frequently in a state of semi-starvation. For all except bare food they have to look abroad—clothes, utensils, tea, tobacco, &c., and all these they purchase by means of their fur sable, which is unequalled in any other part of the world. About 5000 of these skins are sold each year at 15 to 20 roubles each. At the beginning of the present century, cattle were introduced from Yakutsk, and, owing to the excellent grass and water, would have thriven well, but on account of the lack of industry or energy on the part of the natives, it was found impossible to lay in sufficient stores of fodder in winter. The question whether agriculture is possible in the peninsula has never yet been answered. Markets exist in the ports of Eastern Siberia, which are at present supplied with such articles as salt meat, butter, cloth, and hides from San Francisco. The main obstacle to agriculture is the excessively damp and constantly foggy climate. The sun seldom shines, and does not therefore give enough warmth for the growth of rye and wheat. The trade is almost wholly with California; and as there is little or no money there it is carried on by a system of exchange, the natives offering their sable skins in return for such goods as they require. The articles conclude with an historical sketch of the peninsula down to the annexation of the Amoor region to Russia in consequence of the treaty with China of 1860.

THE latest news from Col. Przevalsky communicated to the Russian Geographical Society is dated January 20 and March 22. In the first of his letters the Russian traveller writes from Dnyouan-in, where he was staying at the residence of the Prince of Alashan. After leaving Urga on November 20, he reached this small town in Alashan on January 15, after a journey of 740 miles across the desert of Gobi. The cold in the neighbourhood of Urga was very intense, and the mercury was sometimes frozen; in Alashan it was, on the contrary, quite warm when there was no wind. M. Przevalsky proposed to leave Dnyouan-in the next day, and *via* the Tchebsen temple reach Kuku-nor. He wrote his second letter from this place. He had crossed Southern Alashan and the Han-sou Mountains without difficulty. There he spent the month of February, principally in hunting and in zoological explorations, which yielded rich collections. On March 23 he was to leave Tche's in for Kuku-nor. The Chinese authorities did not hinder his advance, but refused to give him a guide for the sources of the Yellow River (Hoang-ho); the indefatigable traveller did not, however, attach any importance to this refusal, being sure of finding the sources of the Hoang-ho himself. When the Tsaidam was reached, M. Przevalsky proposed to establish his first station there, and to continue his journey with a few men and provisions. His second station would be established at Ghast in Western Tsaidam. As to Thibet, he had decided to go to Lassa if the Thibetians did not oppose him. Otherwise he would explore only Northern Thibet as far as Lob-nor, endeavouring to penetrate as far south as possible.

ANOTHER traveller who has been sent out by the Russian Geographical Society, M. Potanin, wrote on April 17 from Tientsin. The expedition had reached Chefoo on April 13 on board the corvette *Shoboleff*, and continued the journey on

Pekin, and there to obtain authorisation for the journey to Ordos and Han-sou *via* Utay or Kuku-Koto.

IN a paper contributed to a recent issue of the *Revue de l'Histoire des Religions*, M. Léon de Rosny, the Japanese scholar, argues that one of the two chief chronological factors in the present Japanese race is the Aino. It has long been recognised that there was a certain intermingling of the original Japanese invaders with those whom they drove before them, and who now remain in parts of Yezo, the Kuriles, and Kamchatka; but M. de Rosny thinks that the Aino element is an exceedingly large one, and permeates the whole race. His arguments are based on an examination of the co-mogony described in the earliest works. He finds here two separate and distinctly marked mythologies, one of a transparently aboriginal character. The Japanese of to-day is, he believes, a mixture of the conquering yellow and the conquered white races.

THE Berlin Geographical Society heard a lecture on October 4 from Herr Robert Flegel, who has just returned from making an exploration in the region of the Niger, as agent of the German African Society. Herr Flegel's exploration has occupied the last two years, in the course of which he explored all Adamawa and discovered the sources of the Binuë; but his effort to travel from the Binuë to the Congo ended in failure, owing to the feuds and violence of the intervening tribes. Herr Flegel carried away with him the conviction that the Binuë is navigable for 1100 kilometres, and its chief affluents, as for instance the Taraba, for a distance of from fifty to sixty nautical miles during five or six months of the year. Herr Flegel is accompanied by two natives, who attended him on his travels, and who listened on bended knee and with crossed arms to the praise bestowed upon them by the President of the Geographical Society for their devotion to their master.

NEWS has been received from the leader of the German expedition in South America, Dr. von den Steinen. The expedition had arrived at Aldea dos Bacairis, on the Rio Parantinga, the ultimate point from which regular communication with the civilised world is possible. Their journey had been considerably delayed by untoward circumstances and difficulties. They left Cuyaba on May 26, and reached Rosario on June 2. There they stayed a few days to purchase provisions. On June 14 they reached the first Aldeamento of the Bacairis on the Rio Novo, a tributary of the Arimo. There they remained a week, making anthropological and linguistic investigations. They continued their march on June 21, and arrived at Aldea on the 28th. On July 5 they were to cross the Parantinga.

A GEOGRAPHICAL SOCIETY is about to be founded in the Scottish capital; it is to be opened next month by Mr. H. M. Stanley.

### A GIGANTIC EARTHWORM

IT is well known that earthworms exist in many parts of the world of enormous size compared to those with which we are familiar in this country.

Dr. Templeton mentions (see *Proceedings of the Zoological Society*, 1844, p. 89) large worms which are abundant after heavy showers in many parts of the island; this species, named by him *Megascollex caruleus*, is represented by a number of examples in the British Museum, some of which are certainly more than two feet long. In South America at least two distinct genera are to be found which attain to a very considerable size. Prof. Perrier, who is so well known as an authority upon the anatomy of the group, has given them the appropriate name of *Aneus* and *Titanus*. Dr. Horst of Leyden, also well known for his researches into the anatomy of earthworms, has published in the "Notes from the Leyden Museum" a description of two species belonging to another genus, *Acanthodrilus*, which measure three feet or so in length; they are natives of Western Africa. Australia and New Zealand are also inhabited by these gigantic creatures. Prof. Thomas, of Auckland, New Zealand, informs me that he has heard of a large earthworm two or three feet in length, which is to be found in the interior of the island, and one of similar size has lately been described from South Australia, by Prof. M'Coy, under the name of *Megascolides*. There is, however, a still larger species which inhabits South Africa. Forty years ago Rapp described

and figured an earthworm six feet two inches in length, which was obtained from the neighbourhood of Port Elizabeth, but since that time there does not appear to have been any further description of the animal. Being anxious to secure a specimen for dissection, I applied to the Rev. G. R. Fisk, who most kindly sent me a living one; it is the same species as that described by Rapp, but is not quite so large; it measured between four and five feet in length, and about half an inch in diameter; these measurements are, however, rather under than over-stated; it is not easy to get an exact idea of the length of the animal, since it expands and contracts within such very wide limits. The general appearance is much like that of the common British species, the bristles being disposed in four series of pairs to each segment; this outward resemblance is not borne out by the internal structure, which is very different from that of *Lumbricus* or any other genus.

These monstrous worms appear to be fairly abundant in the neighbourhood of Port Elizabeth and other parts of the Cape Colony (see the *Cape Times* for May 29, 1884), but are only rarely seen; they do not seem to move about at night like our British worms; only heavy and prolonged rains drive them to the surface from their underground burrows; on such occasions, as I am informed by a correspondent at Kleinpoort, which only take place a few times a year, the ground is often covered by hundreds of these creatures slowly crawling about in all directions; they must present a most remarkable sight; as a general rule they do not return into the earth after the rain has ceased, but remain above ground, and are shortly killed by the sun. The same gentleman states that the soil in which he has observed them is of a hard clayey nature, and retains a considerable amount of water, which is invariably brackish. This fact has some significance in connection with the geographical distribution of earthworms. It was formerly believed that earthworms and their eggs were killed by immersion in salt water, and consequently the presence of similar or closely-allied species in two regions now separated by the sea would be a strong indication of a previous land connection, setting aside, of course, those cases evidently due to man's interference (i.e. the importation of earthworms from tropical countries among the roots of plants). The fact that this earthworm from the Cape, and presumably its eggs, are unaffected by brackish water, and still more the occurrence of another genus, *Pontodrilus* (cf. Perrier, *Arch. de Zool. Exp.*, t. ix.), among decaying seaweed cast up by the sea, shows plainly that the greatest caution must be observed in drawing any such conclusions.

Zoological Gardens, N.W.

F. E. BEDDARD

#### THE ACTION OF AMMONIA UPON SOME LEPIDOPTEROUS PIGMENTS

TWO or three years back, some entomological friends induced me to kill all my insects with ammonia, instead of employing potassium cyanide, and I have never regretted the change I then made. Nearly the first species so treated was *Melanargia galathea*, and on opening the pill-boxes I was much surprised to find every one of them of a beautiful primrose-yellow colour. In a few moments the primrose-yellow had vanished and the insects were of their normal white again. Evidently this phenomenon was due to the volatile ammonia, so I held a specimen over the bottle, and instantly the primrose colour returned, only to disappear again with the departure of the pungent ammoniacal fumes. The reagent employed was a saturated aqueous solution of ammonia, and the black pigment of the wings remained unchanged throughout. Now here was something of great interest and well worth investigation, so I determined to follow it up, and since that time have never lost an opportunity for experiment or study. Many of my friends are now familiar with the results obtained, but as they appeared to be previously unknown to all those with whom I have communicated on the subject, I have thought it best to place them on record. They may be well known and authenticated, but to ascertain this a careful search through the vast mass of the chemical and microscopical literature both of this country and the Continent would be required, and for this my spare time is quite inadequate. I must therefore crave the indulgence of those who may be familiar with the facts herein recorded. Naturally, the first species selected for experiment was *Melanargia galathea*. As before, ammonia gave the primrose coloration. The next reagent employed was a solution of potassium hydrate, in which pieces of the wing

were placed, and they immediately turned yellow. Other alkalis, such as solutions of sodium hydrate and barium hydrate, were tried, and gave similar results, the only difference being that with the fixed alkalis the primrose coloration was permanent, whereas with ammonia it was necessarily fleeting.

As alkali turned the pigment yellow, acids I thought might prevent this, or even produce another colour. Accordingly the wings were treated with a great many acids, the chief being sulphuric, nitric, sulphurous, hydrochloric, phosphoric, and acetic. With all these, when used in excess of the alkali, the pigment was restored to its natural white colour. I also found, that whenever the liquid employed was exactly neutral to both red and blue litmus, the pigment remained unchanged, whilst the slightest addition of alkali produced the primrose-yellow, and when acid predominated the normal colour prevailed. Thus, we see, this pigment is a good test for alkalinity.

To enumerate all the species experimented upon would occupy too much space, so I will only give the most important. As some Continental species are mentioned, I have followed Staudinger's arrangement. *Papilio machaon* and other *Papilio*s were unchanged, and the same may be said of the genus *Thais*. *Parnassius apollo*, *P. delius*, and *P. mnemosyne* turned a pale yellow. With such semi-transparent species a deeper coloration could not be expected, from the small amount of pigment present.

None of the species of *Aporia*, *Pieris*, or *Anthocharis* showed any alteration with ammonia, but *Leucophasia sinapis* and its vars. *lathyri*, &c., exhibited a delicate primrose colour. Not a single species in *Colias*, *Rhodocera*, *Thaïs*, or *Polymnatus* was changed; but the behaviour of the species of *Lycena* was extremely curious and somewhat unexpected. *L. argades*, *L. argolus*, *minima* (= *alsus*), *semiargus* (= *axis*), *alon*, *arion*, and *cyprenus* remained unaltered. *L. bellica*, *argyrotoxus* (= *azon*), *argus*, *opilete*, *orbitulus*, *eros*, *tarus* (= *alaxis*), *eumedon*, *amanus*, *bellargus* (= *adoni*), *meleager*, *jolas*, and especially *astrarche* (= *aceticis*), *corpdon*, and *damon* were beautifully suffused with primrose on the under side and cilia, wherever the white pigment occurs. It is difficult to say why some of the species in this genus are unaffected, whilst others exhibit the most gorgeous colouring; but in the case of *L. argolus*, at least, this may be accounted for. The pale bluish white of the under side is not the result of white pigment at all, but is due to reflected light from the almost pigmentless scales, in which a change could not be looked for. All the species which were examined in *Nemobius*, *Charaxes*, *Apatura*, *Linocnitis*, *Vanessa*, *Melicerta*, and *Argynnis* exhibited no change. In the *Satyridae*, besides *Melanargia*, *Enis allo* is clearly suffused with primrose beneath. In *Satyrus*, *S. circe* and *S. briseis* have the white bands changed, but *S. alyone* and *S. semle* are not affected. *Erebia* and *Pararge* are alike unchanged. *Cyanocephala hero*, *C. arcana* (and vars.), *C. pamphilus*, and *typhon* (= *darius*), have the cilia and under side deeply suffused with yellow. Of the *Hesperiidae*, *Spilothyrus alceæ*, *Syrichthys alboculus*, *S. serranube*, and *malus* (= *alboculus*), all have the whites changed to primrose, but *Nisoniades*, *Hesperia*, and *Cartrocephalus* are not affected.

With the *Heterocera* I have obtained but negative results, although the number of species operated upon are to be counted by hundreds. It would be unsafe to generalise with such scanty data to go upon, but a few remarks may be ventured. The white pigmentary deposits of *Pieris* and *Melanargia*, although to the eye the same, must have a very different chemical constitution, and at one time I thought the negative ammonia results would be a good character of the *Pieridae*, in contradistinction to *Melanargia*, &c.; but facts would not support this speculation, for *Leucophasia* proved refractory, and the *Satyridae* gave results by no means uniform. Many more experiments must be performed. Nature must be thoughtfully questioned again and again before we can possess a firm basis for speculation.

Hitherto changes of colour only have been dealt with, and few reagents employed, but by recent experiments on the solubility of the various pigments in different media, most interesting facts have been brought to light, which in the future I hope to communicate. What a wonderful and lovely sight is the under side of *Vanessa atalanta*! It has at least a dozen shades of colour, most exquisitely mingled. Some day these colours will be analysed and their constitution made known. The results herein recorded may then be of service.

GEORGE COVERDALE

24, Fleming Road, Lorrimore Square, S.E., August 16

## SCOTTISH FISHERY RESEARCHES

APPENDIX F of the Report of the Scottish Fishery Board contains a series of valuable papers with accurate and well executed plates. Dr. Stirling gives a preliminary report on "The Chemistry and Histology of the Digestive Organs of Fishes." The first part gives the results of chemical investigations of the digestive processes in the herring, cod, haddock, and skate. The second part deals exclusively with the intestinal tract of the herring. The muscular coat of the œsophagus consists of striped muscular fibres arranged more or less regularly at the upper part, but disposed circularly in several layers at the lower. The mucous membrane of the œsophagus has longitudinal folds, and is lined with cylindrical epithelium interspersed with numerous goblet cells. The œsophageal glands are simple tubular glands, with, at first, a very short secreting portion. The glands in the "cardiac sac," or "crop," are, like those of the œsophagus, branched tubular glands lined in their upper part by tall columnar epithelium, and in their secretory parts by a single layer of cubical cells, like the "outer" cells of the fundus in mammals. The gland tubes become shorter towards the lower part of the cardiac sac, and they are absent in the pneumatic duct, which is lined by a single layer of columnar epithelium, and divided into two compartments by folds of the mucous membrane. Dr. Stirling has found that the organ which has been hitherto known as the "crop" in the herring, is something more than a mere receptacle, and corresponds in structure and function to the cardiac portion of the stomach of higher vertebrates. There is a striking resemblance between the cells lining the secretory portion of the gland tubes and the "outer cells" in the mammalian stomach, the point of difference being that the tubes are lined by a single continuous layer of these cells. There are apparently no internal layers of cells comparable to the inner cells of mammals, and, as might be perhaps expected, the glands are simpler than those of the mammals, and without that differentiation of tissue which is brought about by specialisation of function. One cell may subserve two functions, and, from an evolutionist's point of view, the secretion of an acid and the formation of a ferment have not as yet in the fishes been relegated to two distinct sets of cells. The pyloric sac or stomach is that short tubular organ with thick muscular walls, and resembling a gizzard, which opens out of the crop and is continued into the intestine. The surface of the mucous membrane consists of irregular depressions, which are deeper than those of the cardiac sac and may be regarded as crypts. The pyloric sac is always lined by a very thick coating of mucus, which not only lies on the surface, but dips down into the pyloric crypts. The surface of the pyloric sac and the glands or crypts are lined throughout with a single layer of tall, narrow, columnar epithelium, having the same character as that which lines the gland ducts and the surface of the cardiac sac. There is no muscularis mucosæ. The circular muscular coat is very thick, while the longitudinal is thin. Structurally the pyloric sac is comparable to the pyloric end of the mammalian stomach. Plates i. and ii. give series of figures illustrating various points in the anatomy of the intestinal part of the herring.

Prof. Macintosh gives a short note of preliminary observations made at the Marine Station, St. Andrew's, on the ova of various food fishes. Cod ova were specially examined, and experiments made as to their buoyancy and the effects of impure water, which proved very marked, and of changes of temperature. The small size of the yolk-sac, as well as the activity shown from the first by the newly-hatched fish show that they must soon take in nourishment from without. The ova of the common flounder were successfully hatched out. Other forms examined and experimented on were the long rough dab, turbot, *Cyclopterus lumpus*, herring, &c., and amongst invertebrates the ova of squids, *Natica*, whelk, nudibranchs, mussel, *Asterias rubens*, lobster, and shore-crab.

The vexed question as to whether the sprat is a separate species of the Clupeidæ or merely the young of the herring is satisfactorily settled in favour of the former opinion in the first part of the Report on the Sprat Fishing during the Winter of 1883-84, by J. Matthews Duncan, F.R.S.E., in which definitions of the differences in external and internal characters are distinctly proved. The sprat is more graceful in shape and slightly thicker in body than the young herring. The dorsal surface of the head is proportionally slightly longer in the herring, the operculum therefore extending further back. The suboperculum in the

sprat is shorter and more triangular. The lower jaw is always longer and the diameter of the eye rather larger in the herring. In both sprat and herring the lower edge of the belly from the anal fin forwards is covered by a series of scales, having a central longitudinal "keel" and two lateral rays projecting forwards and upwards. These are more numerous but weaker in the herring than in the sprat, where the central keel is stronger and the termination forms a sharp point, so that the difference can easily be felt. In the sprat the pelvic fin is anterior to the first ray of the dorsal, whilst in the herring it is posterior to it. The pectoral fin is placed proportionately further back in the herring, and the centre of the dorsal slightly behind the centre of the body. The position of the dorsal fin varies more in the sprat, the position of the anal fin more in the herring. The number of rays in the pectoral, dorsal, and anal fins is not constant in either species, but appears invariable in the pelvic fin, that of the herring having two rays more. The arrangement of the teeth in both species is the same on the maxilla, premaxilla, and tongue, but those on the tongue are smaller in the sprat, and the vomerine teeth present in the herring are entirely wanting. The same superiority, as far as number is concerned, shown by the herring in the fin rays, &c., is seen in comparison of other organs, the vertebrae, gill-rakers, and filaments, the branchial and pseudo-branchial filaments, and the branchiostegal rays, being all more numerous than in the sprat. The pyloric caeca are also more numerous. The slender duct by which the stomach (crop of Huxley, NATURE, vol. xxiii. p. 607) communicates posteriorly with the swim-bladder is slightly shorter and thicker in the sprat. In the herring the anterior end of the swim-bladder gives off two delicate branches, which run forward at first along each side of the parasphenoid, then diverge, and enter a small spindle-shaped capsule. From the anterior end of this capsule the duct passes out, and divides into two branches, one of which runs straight forward from the vesicle, whilst the other passes outwards at nearly a right angle. In the herring the ducts are very delicate tubes, measuring, in a herring 120 mm. long, 0.9 mm. in diameter, and are surrounded by a cartilaginous sheath, .25 mm. in external diameter. The ducts meet posteriorly in the middle line, and open by a single aperture into the narrow anterior end of the swim-bladder. The spindle-shaped capsule is about 1 mm. long by .6 mm. broad, and the spherical capsules are about 1.3 mm. in diameter, the anterior one slightly larger. The sprat, however, shows a remarkable departure from this arrangement. The ducts are about the same size as, and their form and direction are similar to, those in the young herring, though, at the point where they diverge from the parasphenoid (about 5 mm. from the swim-bladder) they lie higher, and are more difficult to follow. But the duct on each side ends in a *single* capsule only, exactly similar to that of the herring, and it neither forms a spindle-shaped dilatation, nor gives off a branch to a second vesicle. Thus, while in the herring there are three vesicles on each side of the head, all containing air, in the sprat there is only one. The foregoing differences are so numerous and so constant at all seasons that there can be no question as to the sprat being a distinct species from the herring, a further proof being that the former is found with developed milt and roe. Mr. Matthews shows in Plate iii. the difference between sprat and herring in the shape of the body and the keel scales, in the size of the ova, and in the formation of the air-vesicles of the ear.

In the valuable paper on the "Natural History of the Herring" Prof. Cossar Ewart, Convener of the Scientific Committee, treats of the varieties of the herring, the migration, the spawning-ground, the process of spawning, and the artificial fertilisation and hatching of ova. The varieties of the herring have long been discussed in all countries frequented by this fish, and differences believed to exist not only between herring of different countries, but of different districts and seasons. How far this may be true could not be determined even by careful examination and figuring of over 500 specimens, taken at different parts of the coast during winter and spring. Comparisons of outline show not so much that the herring of one district differ from those of another, but that there is a remarkable variation amongst herring caught at the same time. Heincke ("Varietäten d. Herings. Jahrb. d. Comm. in Keil, 1876-78") considers the position of the dorsal and pelvic fins of great importance, but, as specimens examined of the same length, caught at the same place, and as nearly as possible at the same stage of maturity, showed more difference than Heincke finds in his autumn and spring herring, some better character must be

considered requisite. It seems unlikely that the same herring spawn twice a year, but that the fish which spawn in the spring and autumn of one year do not spawn again respectively till the spring and autumn of the next year, in which case it is difficult to account for two distinct races of herring. It may be supposed that at first all herring were in the habit of spawning about the same period, but as time went on they were found spawning during every month of the year. Specimens of ova, for example, have been sent nearly every week from the Aberdeenshire coast, showing that herring have been spawning uninterruptedly in one district for at least ten months, from August 1883 to June 1884. The explanation of why at the present day there are two great spawning periods is not that spring and autumn are the two best periods for the depositing and hatching of the eggs, but that these are the two most favourable periods for the appearance of the fry, as then the surface-forms on which they feed are more abundant, as examination of the Ballantrae Bank showed. In the case of the herring the number of individuals does not depend so much on the number of eggs hatched as on the number of fry that survive. These when hatched are at first protected by their minute size and great transparency, and, given sufficient food, are likely to pass safely through the larval stage. If the larval food were more abundant in autumn and in spring, more fry would naturally survive at these periods, and this would ultimately result in the formation of great shoals of autumn and spring herrings. All that has been written on the migration of the herring leaves us still very much in the dark as to either the extent or the causes of it. Meantime, we may suppose that the movements of the herring are regulated during a greater part of the year by the supply of food, which naturally renders their movements very inconstant, and during the rest of the year by what may be termed their spawning instinct. This seems to imply several things, but it specially leads the herring to select ground suitable for the deposit of eggs, waters having a suitable depth, and water which will provide abundant food for the young fry. It has been long known, and was placed beyond doubt by the Fishery Board investigations of 1862-63, that herring were wont to spawn on hard ground. A very complete survey of the Ballantrae not only corroborated this fact, but showed that the herring even preferred to deposit their ova in the basin-shaped gravel-coated areas, where presumably the water is stiller than over the stone-covered ridges, and where it covered many square yards with a layer nearly half an inch in thickness. Eggs were also often found arranged in low masses over the surface of the long stems of laminaria. In several instances the dredge had apparently come upon part of the bank where the eggs lay "to a very great depth," but on examination it was found that the spawn, instead of forming thick masses, was arranged in irregular heaps ranging from a quarter to half an inch in thickness, and varying in size from scarcely an inch to nearly six inches square. By laying the portions side by side in a tank it was possible to obtain a very accurate notion of the arrangement of the undisturbed ova, which certainly often form a regular layer covering several yards of the bottom. On the east coast, judging from the specimens brought up by the long-line fishermen, the herring seem to select hard ground plentifully covered with sea firs, especially *Hydrallmania* and *Antennularia*. Fishermen and others believe that there is some relation between the herring deserting any given spawning-ground—such as the once much-frequented bank off Dunbar and the equally famous Guillam Bank in the Moray Firth—and the loss of herring-nets during storms, or when over-fished. The reason is that nets loaded with putrefying fish, when left on the ground, cause the herring to seek more agreeable banks elsewhere. This pollution would be continued and extended by portions of the net continuing to fish during the whole season, so that not only might the eggs first deposited be destroyed, but fish which might have spawned on other portions of the bank be taken, and their eggs, though shed, rendered useless. In this way not only the greater part of a shoal, but what is of even greater importance, nearly all the eggs deposited during the spawning period might be destroyed, and the survivors of the comparatively small brood hatched desert their birthplace as spawning-ground and cast in their lot gregariously with the first large shoal they met with. In the artificial fertilisation and hatching of herring ova the natural process of spawning was followed as far as possible, and many thousands of eggs treated in this way on March 8 hatched out on March 28, 29, and 30, the temperature varying from 41° to 44° F. When the eggs had been plentifully supplied with pure water, the extremely active

embryos kept revolving or wriggling inside the capsule, till this ruptured and allowed the larval herring to escape head-foremost. But if the supply of pure water had been limited, the capsule gave way prematurely, the long, slender body escaped, but the head remained within, and the embryo usually perished in spite of all efforts to escape. The hatching was greatly expedited by the temperature of the water being slightly raised. As soon as the fry escape, they begin to try and ascend towards the surface, which they generally succeed in reaching on the fourth day, when they are found swimming freely about. This instinctive desire to rise to the surface as soon as they escape from the egg-capsule is evidently intended to bring them to the vicinity of the food, on which, after the fourth or fifth day, they depend for nourishment. Sketches are given (Plates iv. v.) of herring, illustrating the different positions of the fins. A map of the Ballantrae spawning-bank (Plate vi.), and drawings of a colony of *Hydrallmania falcata* (Plate vii.) and *Antennularia antennina* (Plate viii.), with cluster of eggs attached. A series of figures (Plate ix.) show the eggs deposited artificially on glass and naturally on stones, gravel, and on a lost net dredged at Ballantrae.

A number of interesting specimens received by the Board are likewise described and figured:—(1) A new Blenny (*Lumpenus lampræiformis*, Plate x.), believed to be the first specimen recorded from the shores of the British Isles; it measured 10·7 inches in length, and was taken in forty fathoms of water, fifteen miles off St. Abb's Head. (2) A fine *Torpedo nobilitiana* (Plate xi.) taken off Lybster in forty fathoms of water. (3) A Comber (*Serannus cabrilla*, Plate xii.) taken off Shetland, the first recorded in the North Seas. (4) A Turbot (*Rhombus maximus*, Plate xiii.), dark on both sides, with an eye on each side of the head and rounded frontal process, taken off Anstruther. (5) A splendid Opah (*Lampris luna*), four feet in length, taken in seventy-five fathoms of water off Fluga, Shetland, and now being examined by Prof. Turner, F.R.S. Another item is a list compiled by Miss MacLagan of edible British fishes and mollusks, with their Latin, French, Italian, and German synonyms.

## THE BRITISH ASSOCIATION

### SECTION D—BIOLOGY

#### Department of Zoology and Botany

*Remarks on the Characteristic Features of North American Vegetation*, by Prof. Asa Gray.—The first impression produced on a visitor from Europe to the Atlantic coast would be the similarity of the flora to that of England, many of the plants being almost or quite the same. The larger number of these are obviously introduced. The mullein, the toad-flax, the rib-worts, the milfoil, the clovers, thrive by every roadside as in England, and perhaps with even greater luxuriance, the competition being less. This strongly suggests the idea that the distribution of plants is not always due so much to adaptation as to opportunity. As one proceeds westward and southward, the difference becomes more marked, the European type gradually disappearing. But as European settlements extend, the settlers carry their plants with them, and the plants are well up to the time, and travel by rail. On the other hand, some plants, but a much smaller number, are carried from America to Europe, and naturalised there. Such are *Impatiens fulva* and *Erigeron canadensis*. Turning from similarities to differences, one of the first points that strikes a European visitor is the great wealth of trees and shrubs. This Prof. Gray illustrated by giving the number of European and North American species in the most important arboreescent orders. The reason of this is probably to be found in the different conditions of the two continents during the period of glaciation. The flora of Europe is exceptionally poor in trees, and, on the return of a warmer climate, the return northwards of those that survived in the south was barred by the Mediterranean. The fossil remains of trees belonging to many tropical orders are found in our Miocene and Pliocene strata. In America, on the contrary, there was nothing to prevent their gradual return from the south, and accordingly we find solitary examples, or in some cases a larger number of representatives, of many tropical orders among the trees of the Northern States. Such are *Menispermum* (Menispermaceæ), *Liriodendron* (Magnoliaceæ), *Diospyros* (Ebenaceæ), *Tecoma* (Bignoniaceæ), and many others. This difference is also promoted by the greater heat of the American summer as compared with that of Europe. On the high lands of North America are also many Arctic plants, which

remained after the Glacial period had passed away; but this flora is insignificant compared with that of Europe. A few species are found on the cool shores of Lake Superior, the shores of Labrador, and certain summits of the Appalachian Mountains. One of the most interesting features of North American botany is an outlying region of a true tropical flora which extends northwards up the Atlantic coast as far as the "pine-barrens" of New Jersey. Proceeding westwards, whether in the States or in Canada, a gradual striking change is observed: not only do the European importations disappear, but European genera give place to those specially characteristic of the western continent. Here above all is to be observed the extraordinary wealth of Compositæ, which make up about one-eighth of the total phanerogamous flora of North America; great numbers of species of *Aster*, *Solidago*, *Eupatorium*, *Silphium*, and other genera. Between the wooded region of the Atlantic and the wooded region of the Pacific coast, there is an immense tract of woodless prairie land, the home of the "buffalo" and of many grasses; and in the spring the number of bright coloured herbaceous plants is also very large. These plains are destitute of water, and probably never grew trees, and are capable of growing nothing but herbaceous plants, which completely disappear in the hot dry summer. Then comes the great chain of the Rocky Mountains, which are well wooded on their sides, and have on their summits a flora of about 200 Arctic species. When the traveller reaches the Sierra Nevada, he enters perhaps the noblest coniferous forest in the world. But while the Pacific coast is extraordinarily rich in Conifera, it has a smaller number of trees belonging to other orders than the Atlantic coast; the entire absence of oaks, ashes, and maples, is especially remarkable.

*Observations on the Trapping of Young Fish by "Utricularia vulgaris,"* by Prof. Moseley.—Small perch just out of the ovum were found in the bladders of *Utricularia vulgaris*, some of them caught by the head, some by the tail; but very close observation failed to detect the actual act of capture. No process of digestion has been discovered, and the object of the capture requires further investigation.

*On the Jessop Collection, to Illustrate the Forestry of the United States in the New York Natural History Museum,* by Albert S. Bickmore.—The great importance of the forest industries and lumber trade of the United States led Gen. Walker, the Superintendent of the Tenth Census, to provide for a corps of competent experts, under the direction of Prof. Charles S. Sargent, who have made new explorations of our forest lands, and gathered original data regarding their present extent. The results of these elaborate researches have been partially published from time to time in the form of bulletins, and the completed work will soon appear in two large quarto volumes of the census series. To place this great fund of valuable information before the artisan and labouring classes in an accessible form, a great collection of our forestry and its products was needed, and this Mr. Morris K. Jessop offered to provide at his own expense. After the field work planned by the census had been finished, Prof. Sargent directed his assistants to return to the forests, and to carefully select the individually largest and soundest tree of each species. Prof. Sargent is preparing a manual which will be a guide to the collection, and which contains all the most important information in the large census volume that will be useful to the visitors and to the artisan classes. The museum is most fortunate in its location in Central Park, where more native and domesticated species are flourishing than can be seen together at any other place on the continent. This is the first effort yet made in this country to gather the native woods together into one collection on a scale commensurate with the extent of the new continent and the importance of its forests.

*On the Origin of Fresh-water Faunas,* by W. J. Sollas.—The author commented on the lack of interest which had been previously taken in the subject, and then referred to the experiments made by Bourdon in changing salt water into fresh. The old idea that salt water had been the mother of life was now generally acknowledged. In the River Jumna, one thousand miles from its mouth, were found marine forms of mollusks. We had to look further than change of temperature and the composition of the water for the manner in which marine specimens obtained their distribution. The currents of rivers always flowed seaward, and if free-swimming larvæ got a short distance up a river they were certain to be washed down again. The case was different with swift-swimming fish, the Salmonidæ, for instance,

which were able to swim up stream and lay their eggs in lagoons. According to a table which he had prepared, nearly all the groups of fishes were both fresh-water and marine. He referred to the evidence afforded by geology to show that fresh-water forms were but modifications of those found in salt water. He believed the sea-water fauna had become fresh-water fauna in the times when tracts of salt water had become fresh-water lakes. He dwelt on the subject of secluded development, and concluded that the higher the organism the less possible was it to diverge from the parent stem. The tree of life at the present time rather put out new leaves than fresh branches.

Prof. Murat of Harvard briefly criticised the paper. The subject was one, he said, rather for suggestion than dogma.

*On the Concordance of the Mollusca inhabiting both sides of the North Atlantic,* by Dr. Gwyn Jeffreys.—It was recommended that this paper should be printed entire in the *Proceedings*.

*On the Identification of Animals and Plants of India which are mentioned by early Greek Authors,* by Prof. Valentine Ball, F.R.S.—He said that upon examination it had been found that many of the animals mentioned by Herodotus, Strabo, and other Greek historians, which had usually been regarded as myths by commentators, were easily identified as animals which were found to-day in the forests of India. For instance, the marticora mentioned by old classical writers, and usually regarded as a combination of tiger and scorpion, was really a tiger. It was said by the Greek writers that the marticora had poisonous whiskers and a sting at the end of the tail. In India to-day the inhabitants still regarded the whiskers of the tiger as poisonous, and when one was killed they always took care to burn the whiskers. With regard to plants, Herodotus mentioned the "Indian reed" or *Calamus indicus*, which was generally regarded by scholars as the bamboo. This was, however, impossible, as the bamboo did not grow large enough to furnish material for canoes, as Herodotus expressly stated that the *Calamus indicus* did. The speaker thought it was the Palmyra palm which grew in the valley of the Indus, and which was known in the Sanskrit language as the "Father of Reeds." There were many others of these animals and plants which could be identified, and when the writer's investigations were published he hoped it would be found that he had exonerated the old travellers from the imputations which had been cast on their veracity.

*On the Rudimentary Hind Limb of the Humpbacked Whale, Megaptera longimana,* by Prof. J. Struthers.—He said the humpbacked whale was extremely rare on the British coast. One had been seen often spouting for some weeks in December in the Firth of Tay; it was mortally wounded, and finally towed ashore dead near Aberdeen. It was a male, forty feet in length. After it had been exhibited for a couple of weeks at Dundee he had partially dissected it. Having been preserved, it was further exhibited, and he had only completed his dissection immediately previous to coming out. The presence of a rudimentary thigh-bone had been discovered in this species many years ago by the late Prof. Reinhardt of Copenhagen. The thigh-bone was composed entirely of a cartilage of conical shape, in length five and a half inches on the right side, four inches on the left; it was incased in fibrous tissue, and rested loosely on the pelvic bone without articular surface. Looking at the anatomical facts and comparing them with those of the other species he had referred to, the conclusion which must be arrived at was that the thigh-bone in the humpbacked whale was a rudimentary structure, a vestige of a more complete limb possessed by ancestors, from which it was descended. The skeleton of this whale would be placed in the Dundee Museum, he hoped, before the Association met in Aberdeen next year.

*On the Value of Nerve-supply in the Determination of Muscular Anomalies,* by Prof. D. J. Cunningham.—He spoke of the muscula sternalis as a new muscle in man, which had no counterpart among animals. It was, according to his experience, found more frequently among females than males, while Prof. Sheppard, of McGill College, had, he learned, had three cases, all among males.

Prof. Moseley said that this subject of the anomalies of the muscles had a very important bearing in solving many of the riddles of the evolutionary theory.

Prof. Struthers said that while it was not at all impossible that new muscles were starting up within us, it was also possible that the muscles might have existed before, and not been discovered, as our predecessors did not examine things as closely as did the modern investigators in muscular anomalies.

Dr. G. E. Dobson regarded this muscle as a rudimentary vestige of a muscle found in all the lower animals, by the use of which they are enabled to draw in their head and forelegs when they erect their spine.

*On the Mutual Relation of the Recent Groups of Echinoderms*, by Prof. A. M. Marshall.—Of these there were four groups, the common starfish, brittle starfish, sea-urchins, and holothurians. He said the nerve-system was originally derived from the skin. In some animals the nerve system sank below, in others it remained near the skin, these latter being in a more primitive condition than those in which the nerve-system had sunk down.

Prof. Moseley characterised the paper as very valuable, having fully borne out all the discoveries of Prof. Carpenter, whose advancing age had prevented his being present.

A paper *On the Facial Membranes of the Marsupials*, by Mr. A. H. Caldwell, who was sent to Australia by the British Association to investigate certain interesting biological questions, was read, in his absence, by Mr. Sedgwick. It gave an account of the development of the marsupial embryo, which has been hitherto a riddle in biology. A letter from Mr. Caldwell as to the progress of his investigations in Australia was also read.

*On Some Peculiarities in the Geographical Distribution and Habits of Certain Mammals Inhabiting Continental and Oceanic Islands*, by G. E. Dobson, M.A., F.R.S.—The geographical distribution of mammals inhabiting continental and oceanic islands has been lately so ably treated of by Mr. Wallace, in his work "Island Life," that I do not purpose entering upon the subject from a general point of view, but will limit my remarks to some peculiarities of distribution which have attracted my attention while engaged in the special study of certain mammalian orders: I refer particularly to the Chiroptera and Insectivora. It is an interesting fact, not hitherto noticed, that many of the most characteristic species of the Chiropterous fauna of Australia have their nearest allies, not in the Oriental, but in the Ethiopian Region, thus contrasting remarkably with the avifauna. The remarkable genus *Chalinolobus* is represented only in Africa south of the equator and in Australia, a single species extending into New Zealand. Again, the species of the sub-genus *Mormopterus*, which belongs to a genus (*Nyctinomus*) of worldwide distribution, is limited to the same zoological regions, being found only in Africa south of the equator, Madagascar, the Mascarene Islands, Australia, and Norfolk Island. The presence of a species of this genus in Norfolk Island and its absence from New Zealand is very remarkable, for, as I pointed out for the first time about ten years ago, one of the two New Zealand bat-known, namely *Chalinolobus tuberculatus*, is also common in Australia. The species of the extraordinarily specialised genus *Megaderma* have their headquarters in the Oriental and Ethiopian Regions; yet the largest species not only of the genus, but also of all known insectivorous bats, namely *M. gigas*, lately described by the writer from Central Queensland, has its nearest ally, not in any of the Oriental species, but in *M. cor* from Eastern Africa. Another very remarkable leaf-nosed bat, the type of my genus *Trionops*, found in Madagascar, Eastern Africa, and Persia, but unknown in the well-searched Oriental Region, has its nearest and only ally in *Rhinonycteris aurantia* of Australia, the type of another very peculiar genus. Finally, Australia agrees much more closely with Madagascar and the Mascarene Islands than with the Oriental Region in the species of the large genus *Pteropus*, for, while species of the section of which *P. vulgaris* of Madagascar is characteristic are well represented in the former regions, they are absent from the latter. Furthermore it is noticeable that, while 80 per cent. of the species of the genus inhabit the Australian Region and Madagascar with its islands, a single species only has found its way to the great continent of Hindostan and to Ceylon.

*On the Geographical Distribution of the Laridae (Gulls and Terns) with Special Reference to Canadian Species*, by Howard Saunders.

*Result of the Investigations of Insular Floras*, by W. B. Hemsley.

*Some Observations on the Direct Descendants of *Bos primigenius* in Great Britain*, by G. P. Hughes.

*On Natural Co-ordination as Evidenced in Organic Evolution*, by Dr. W. Fraser.

#### Department of Anatomy and Physiology

*On the Presence of Eyes and Other Sense-organs in the Shells of Chitonidae*, by H. N. Moseley, M.A., F.R.S., Linacre Professor of Human and Comparative Anatomy in the Uni-

versity of Oxford.—The Chitonidae have hitherto been regarded as characterised by an entire absence of organs of vision, the presence of eyes in the shells of numerous genera having been entirely overlooked by naturalists. The author first discovered eyes in a specimen of *Schizochiton incisus*, dredged by Capt. Chimmo, R.N., in the Sulu Sea, in which species they are larger and more conspicuous than elsewhere, and on examining carefully the shells of certain other forms, found eyes present there also. The eyes are entirely confined to the shells, and to the exposed parts of these, the "tegmenta" not occurring at all on the "articulamenta." They never occur on the girdle or zone, or any other part of the mantle. They appear as bright, highly-refracting, convex beads on the shell-surfaces, encircled by zones of dark pigment formed by the choroid layers. The eyes are usually circular in outline, and very minute, measuring in *Schizochiton incisus* about 1/175th of an inch in diameter, in *Acanthopleura spingeri* 1/350th of an inch, and in *Corphicum aculeatum*, in which they are oval in outline, 1/600th of an inch by about 1/400th. In the case of all the intermediate shells the eyes are confined to the aræ laterales, or to the lines of demarcation between the aræ laterales and the aræ centralis, which latter is usually entirely devoid of them. In some genera of Chitonidae, such as *Acanthopleura* and *Corephicum*, the eyes appear to be often destroyed and obliterated in the older regions of the shells by decay and delamination of the tegmental surface, or its destruction by boring Algae or animals. They are, however, constantly re-formed by the mantle in the process of growth of the shell at the growing margin of the tegmentum, and may be observed in this situation in all stages of construction. In other genera, such as *Tonicia*, the eyes lie in shallow pits of the shell-surfaces, and thus escape destruction by wear, nearly the entire number which have been formed being thus found present in fully-grown shells. The tubercles and prominences by which the tegments are covered in some forms serve, perhaps, as protections to the eyes from attrition. The entire substance of the tegmentum in the Chitonidae is traversed by a series of branching canals, which are occupied in the living animal by corresponding ramifications of soft tissue and nerves. The strands of soft tissue are continuous with the tissues of the mantle along the line of junction of the margin of the tegmentum with the upper surface of the articulamentum by means of a series of tubular perforations in the shell-substance. Further, in the intermediate shells of most genera there are a pair of lateral slits (*incisuræ laterales*), one on either side in each shell in the lateral laminae of insertion; these slits lead each to a narrow tract in the deep substance of the shell, which follows the line of separation between the aræ centralis and aræ lateralis. This tract is permeated by longitudinal canals, into which open a series of five apertures on the under surface of the shell. By these apertures numerous nerves enter the tract from the bed of the shell, and, traversing the longitudinal canals, give off a series of lateral branches on either side from it to the network within the tegmentum. In the cases of the anterior and posterior shells, there are usually a considerable number of slits present in the laminae of insertion, each connected with a similar nerve-supply to the tegmentum. The network terminates at the surface of the tegmentum all over in a series of elongate cylindrical organs of touch, the plug-like ends of which are somewhat dice-box shaped, and can be protruded beyond the level of the tegmental surface from a series of pores, "macropores," by which this surface is covered. These larger organs of touch give off from their sides five branches of soft tissue, which pass vertically to the surface of the tegmentum, and terminate there in minute plug-like organs like the larger ones, but much smaller, and which are protrusible from a series of smaller pores (micropores) in the shell-substance. The smaller and larger touch-organs, and their corresponding pores, are disposed on the surface of the tegmentum with more or less exact regularity in different genera of Chitonidae; in many cases in very definite lines and patterns. The eyes are connected with the same network of soft tissue as the touch-organs, and are apparently to be regarded as having arisen in development as special modifications of them. The soft structures of each eye lie in a more or less pear-shaped chamber excavated in the substance of the tegmentum. The stalk of the pear, which forms the canal for the passage of the optic nerve, is directed always towards the free margin of the tegmentum, and here its wall is pierced by a circular aperture, which is covered by the cornea. The cornea is calcareous, resisting the action of strong boiling caustic alkalis, but collapsing at once when treated with acid.



In section it is seen to be composed of a series of concentric lamellæ. Its substance is continuous with the general calcareous substance of the tegmentum at its margins. The pear-shaped cavity of the eye, formed by the shell-substance, is lined by a dark brown pigmented choroid membrane of a stiff and apparently somewhat chitinous texture. This membrane exactly follows the shape of the cavity, but, by projecting inwards beyond the margin of the cornea all round, forms an iris of a less diameter than the latter. A perfectly hyaline, strongly bi-convex lens is placed behind the iris aperture. It is composed of soft tissue, and dissolves in strong acetic acid. The optic nerve at some distance from the retina is a compact strand, but before reaching the latter has its numerous fine fibres separated and loose. The retina is composed of a single layer of rather short but extremely distinct nucleated rods of roughly hexagonal section, with their free ends presented to the light. Immediately behind them is a dense mass of nerve-fibres with numerous nuclei and nerve-cells interspersed. The retina is on the type of that of *Helix*, and not, as might have been supposed, on that of the dorsal eyes of *Oncidium*. A large part of the peripheral fibres of the optic nerve do not pass to the retina, but pass outside the eye-chamber by a series of apertures in the choroid round the iris margin, and end at the shell-surface in a zone of touch-organs encircling the eye. The touch-organs are identical in structure with the smaller touch-organs already described as appended to offsets of the larger touch-organs all over the shell. In giving off nerves to a series of such small organs, the eye thus corresponds exactly in structure to these larger touch-organs, and its homogeneity with them is thereby clearly indicated. The arrangement of the eyes varies much in the different genera. In *Schizochiton incisus* the eyes are restricted to single rows traversing the lines separating the lateral area from the area centralis, and corresponding in portions with the incisura laterales and courses of the principal nerves. There are six rows of eyes, with six marginal slits on the anterior shell, and six on the posterior, and a single pair on each of the intermediate shells, twenty-four rows in all, with an average of about fifteen eyes in each, or, in all, 360 eyes. In *Acanthopleura spiniger* the eyes are irregularly scattered around the bases of the tubercles with which the surface of the tegmentum is covered, and are confined in the specimens examined to the region of the margins of the shells adjoining the mantle. The surface of the older regions of the tegmentum sinks in this species especially liable to flake off, carrying the eyes with it, and it will probably be found, when series of examples of various ages are examined, that the eyes are originally more widely extended over the shell surfaces. In *Corephicum ulatum* the eyes are very small, with corneas oval in outline, the long axis of the oval being directed vertically to the shell margin. They are never placed on the tubercles with rows of which the shell-surface is covered, but between the bases of these. The two kinds of pores lodging the organs of touch are arranged in vertical parallel lines with great regularity, the large pores occurring at intervals in the lines of smaller pores. The eyes are present in enormous numbers, the anterior shell alone bearing more than 3000, and the entire eight shells more than 11,500. In *Tonitua marmorata* the eyes are arranged in single straight radiating rows on the anterior and posterior shells. On each lateral area of the intermediate shells there are from two to four similar rows of eyes. In *Ornithochiton* the eyes are disposed somewhat similarly. In the genus *Chiton*, eyes appear to be entirely absent, though the touch-organs of two sizes and corresponding pores are present. In *Molpalia*, *Mangina*, *Lorica*, and *Ischnochiton*, I have as yet detected no eyes. In *Chitonellus* there are no eyes, and the supply of touch-organs is scanty and confined to the margins of the tegmenta. The arrangement and structure of the eyes and organs of touch will probably be of great value in the classification of the Chitonidæ, which has hitherto proved so difficult a problem. No traces of any structures resembling the eyes and touch-organs of the Chitonidæ can be detected in the shells of *Patella* or allied genera. The tegmentary part of the shells of this group appears to be something *sui generis*, entirely unrepresented in other Mollusca. Its principal function seems to be to act as a secure protection to a most extensive and complicated sensory apparatus, which in the Chitonidæ takes the place of the ordinary organs of vision and touch present in other Odontophora, and fully accounts physiologically for the absence of these latter in them. Dr. W. B. Carpenter observed the perforate structure of the tegmentum in *Chiton*, though he did not examine the nature of the contained soft network. The late

Dr. Gray, in his well-known paper on the structure of Chitons, recognised the fact that the tegmentum in the Chitonidæ is something peculiar to the shells of this family.

*On a Method of Studying the Behaviour of the Germs of Septic Organisms under Changes of Temperature*, by Rev. Dr. Dallingier.—Description of a new apparatus invented for this purpose.

*A Vegetable Organism which Separates Sulphur*, by A. W. Bennett.—Description of *Beggiatoa alba*, an organism found in the effluent water from sewage-works, known as the "sewage-fungus," which has the property of separating sulphur out of the organic matter in the water, or in the salt used in precipitating the sewage, in the form of minute sharply refringent globules.

*On the Coagulation of Blood*, by Prof. H. N. Martin and W. H. Howell.—The blood of the Slider Terrapin, a turtle easily obtainable in Baltimore, had been used for a number of experiments, the object of which was to determine whether the views entertained by Hammarsten or by Schmidt were most reliable. The general conclusions went to show that the views of Hammarsten were more in accordance with the results of these observers.

Prof. Schäfer asked if the authors had made any experiments with reference to the addition of lecithin and white corpuscles respectively to the blood plasma.

Prof. Martin replied that no experiments had been made with lecithin, but that he had found that the plasma did not clot when entirely free from white corpuscles or a watery extract of them.

*On the Blood of Limulus polyphemus*, by Francis Gotch and J. P. Laws.—The paper was chiefly interesting, as Prof. Schäfer remarked, on account of its indicating the combination of copper with a proteid replacing the usual iron.

*On Vaso-motor Nerves*, by Prof. H. P. Bowditch.—He gave an account of some experiments he had been making to determine the need of vaso-motor nerves. He had employed an entirely new method, namely, the use of the plethysmograph.

*Demonstration of the Co-ordinating Centres of Kronecker*, by Prof. T. W. Mills.—This subject had been previously practically demonstrated to most of the physiologists present. The view, held by Prof. Kronecker is that there is a centre which, when injured, is paralysed, and whose function of co-ordinating the muscular movements to form a beat is thus lost, the heart going into what is known as fibrillar contraction, which is wholly insufficient to propel the blood through the body.

Dr. Martin had seen this phenomenon when working on the coronary artery, and thought it due rather to injury of the nerves.

Prof. Schäfer held a somewhat similar view.

Dr. Bowditch asked if, as the injuries referred to were mostly superficial, they did not differ very much from the case in point, which was a deep injury.

Prof. McKendrick thought that if it was merely an injury of a nerve that caused the phenomenon, the heart might be brought back to its natural action; while the fact was a dog's heart, he understood, had never been recovered.

Dr. Mills also stated that Prof. Kronecker would, in consequence of injury of this centre, explain deaths from slight pricks of the heart, sudden death in heart disease in certain cases, and death from chloroform.

Prof. Schäfer thought that from the evidences it was clear electric excitation should not be used to recover hearts suffering from chloroform administration, inasmuch as the phenomenon could itself be caused by the application of an electric current.

Dr. Osler thought the strength of current usually used by physicians in such cases was not so strong as those Prof. Schäfer had in view.

*On the Cardiac Nerves of the Turtle*, by Profs. Kronecker and Mills.—This communication went to show that in the sea turtle there were nerves whose function was perfectly analogous to that of the vagi and accelerantes in mammals. The course of these nerves varied a good deal in different species and in different individuals. It had also been discovered that the pulsating great veins of the land turtle were under the influence of the vagus.

Prof. Martin had found in the Slider Terrapin a ganglion, apparently answering to the thoracic ganglion of the dog, from which the accelerator nerve passed to the heart.

*On the Functions of the Marginal Comotition*, by V. Horsley and Prof. Schäfer.—The object of their experiments was to ascertain the effect of stimulation of localised areas of the marginal

convolution in the monkey, and their results filled up a gap in the well-known work of Ferrier in that they were able to show that removal of certain areas, the excitation of which had previously caused movements of muscles of the trunk, &c., on both sides led to paralysis of muscles of the trunk of such a degree that the animal was unable to stand. By removal of the frontal lobes no paralysis of voluntary movements were obtained. These results were in opposition to those of Munk, of Berlin.

*Ova of Monotremes.*—The President stated that he had a most important announcement to make. He had just received a cablegram from Sydney, from Prof. Liversidge, announcing that Mr. Caldwell, the Balfour Student, who was sent out to Australia to investigate the mysteries in connection with the mammals of that country, had discovered that the Monotremes were oviparous. He did not consider that a more important telegram in a scientific sense had ever passed through the submarine cables before. The Monotremes formed two families characterised by the duck-billed Platypus and an animal which was known to the Australians as the ant-eater. These were the lowest forms of mammals, and it had never been known how they produced their young. The extraordinary discovery was now made that these mammals laid eggs, and that the development of these eggs bore a close resemblance to the development of the eggs of the Reptilia. This discovery proved that these animals were more closely connected with the Sauropsida than with the Amphibia.

*On Sensory Nerve-Sacs in the Skin of Amiurus, a Siluroid Fish; and On the Function of the Air-Bladder in Amiurus, and its Relationship to the Auditory Organ,* by Prof. R. Ramsay Wright.—He referred to the numerous species in North American fresh waters, and their remarkable uniformity, almost all belonging to one genus, *Amiurus*, while tropical fresh waters teem with many different genera differing extremely from each other in form. All the species, however, live in muddy waters, and, to make up for the want of the powerful eyesight which characterises the salmon, are provided with an exceedingly sensitive skin and with special tactile appendages on the head. The lecturer described the already known forms of sensory organs in the skin, and then pointed out that certain structures recalling the nerve-sacs of ganoid fishes, like the sturgeon and gar-pike, are scattered all over the body from head to tail, and both on the upper and lower surfaces. This diffusion of these organs is of interest as indicating probably an ancient type of their arrangement. The second point touched upon was the function of the air-bladder and its relationship to the auditory apparatus. Prof. Wright believes the fish becomes sensible of alterations in the pressure of the surrounding water in the auditory apparatus, and suggested that the air-bladder is also an important channel through which sounds are communicated to the terminal organs of the auditory nerve.

In the discussion which followed Prof. Alfred Haddon of Dublin confirmed the latter point, and suggested that this particularly delicate apparatus for receiving sounds was present on account of the fact that tropical Siluroids, at any rate, are capable of producing sounds by means of a stridulating apparatus, some forms of which he had himself described.

#### SECTION H—ANTHROPOLOGY

MR. HORATIO HALE read an interesting paper *On the Origin of Wampum*. He said that amongst the Indians it represented mammon, or money, and was equally valued. It had once been actually accepted in Massachusetts and New York as legal currency, owing to lack of silver, and was largely used in the Indian trade. Wampum consisted of a kind of bead or shell, but must not be confounded with the cowries of the East. Indians on the sea-coast drove a large trade in this article, and Long Island was a mine of wealth. The word wampum was of Algonquin origin, and meant white. The speaker explained the various uses to which this material was put. It was generally used in strings and belts, and at the great Iroquois ceremonies it was considered indispensable. Black wampum was more valuable than white. Of the many thousands of belts that had been known to exist during the last three centuries, scarcely fifty remained, and Mr. Hale regretted the dull indifference that had been displayed by the Americans with regard to this interesting and valuable material, valuable as forming a chronicle of the tribes who manufactured the belts. Mr. Hale exhibited an historical belt of wampum, composed of white beads, with four black squares, which, he said, represented four towns. This belt, he said,

was one hundred and sixty years old. Another and still more remarkable belt was also shown by the speaker, who explained the emblems upon it, which, he said, were intended to represent the signs of the Christian religion. There were three crosses representing the Trinity, a lamb, executed in a primitive manner, and a dove. These objects, Mr. Hale said, had been evidently suggested to the Indian artist, who had done his best to represent them, but he said that his artistic powers should not be judged by this specimen. The speaker also displayed some strings of beads, and said that these were used in the Indian chants, the beads recalling certain verses to the singers. Mr. Hale showed to the Section a photograph of some Indian chiefs of the six nations who had met at Brantford and explained to him the meaning of their wampum belts. Shell beads, he said, were used in large quantities by the mound-builders, and he argued that it was probable that the art of manufacturing this medium had descended to the modern tribes from their more advanced ancestors. Some beads, which had been found in an enormous burial-place in Orillia county by Mr. Hirschfelder, were shown by Mr. Hale, who said that these were undoubtedly used by the Hurons. Crossing the Rocky Mountains, he said that wampum would be found in actual use, the material itself and the labour devoted to its ornamentation making it extremely valuable. Being susceptible of a high polish, it forms very handsome ornaments, and is better adapted for this purpose than for currency, for which it is cumbersome. Speaking of the amount of shell money possessed by the primitive Indians, Mr. Hale said that the average man owned about one hundred dollars' worth, that being, he said, about the value of two women, two grizzly bear skins, twenty-five cinnamon bear skins, or three ponies. Mr. Hale remarked on the districts in which wampum was found, and quoted some sentences from a work of his own with regard to the discovery of wampum in the Kingsmill Islands of Micronesia in the Pacific Ocean. There, he said, he saw strings of alternate wooden and shell beads. He exhibited to the Section specimens of beads from the Kingsmill Islands and from California, some of these having lost their lustre from the long time which they had been buried in a grave. Mr. Hale made some interesting remarks upon the history of Chinese money or "cash," tracing its origin to the tortoise-shell disks used in earlier times. Mock money, he said, was sometimes burnt at sacrifices, as the Californian Indians burnt their shell money at funerals. He traced the passage of this currency between Asia and America, showing how it could have been brought from one district to another. It was used, he said, by Indians in Eastern North America, those in California, the inhabitants of Micronesia, and the Chinese. He thought that the monetary system was indigenous to China, and that by early intercourse it had been conveyed to this continent. He noticed the fact that Chinese junks and Micronesian prows may have been wrecked on the western shores of America, and that their crews may have introduced the system of shell money amongst the Indians.

Major J. W. Powell read a paper on *The Marriage Laws of the North American Tribes*. In the course of his observations, the speaker remarked upon the custom of burying articles with the dead. There were two classes of property amongst the Indians, communal, or that belonging to the tribe, and personal, or that belonging to the individual. In order to prevent controversy the latter was buried with its owner. With regard to the marriage laws, Major Powell said there were many strange customs. For instance, in some tribes, marriages were arranged by officers of the tribe, and the choice of wife or husband was limited to certain groups of persons. Marriage was therefore not by personal choice, but by legal appointment. But marriage could be performed by elopement, or running away, when, if the couple could remain in safety from detection and punishment until after the day of jubilee, or the day when all offences are considered forgiven, then that marriage would be considered legal. Wives could also be obtained by trial of battle, a contest of some kind, when the woman became the helpmate of the victor. There was also marriage by capture. The methods of obtaining a wife were so common that the custom of marriage by legal appointment was much neglected. But though this was the legal and proper method, the others had become legalised by long custom, and now the capture, contest, or elopement were merely simulated.

Mr. C. A. Hirschfelder of Toronto, as representative of the Numismatic and Antiquarian Society of Montreal, read a paper *On Prehistoric Remains in Canada*. The ancient remains of

Canada have, as yet, been by no means satisfactorily examined, and consequently but superficially described; and although we have no stone ruins, still that does not detract from the interest of the prehistoric works, found scattered over various sections of this country, which are well worthy of a thorough scientific examination. The forts, which were built principally of earth, although stone was not infrequently used to some extent in their construction, are particularly interesting from two points of view—viz. the almost perfect symmetrical shape, and the advantageous positions which were invariably chosen. As to the first-named feature, they bear a striking resemblance to the ancient earthworks of the Western States, by which some writers have endeavoured to prove that the authors of those works must have been advanced in certain sciences. As to the situation of these forts, their ancient builders seem to have carefully studied localities, and to have fully appreciated the advantages to be gained thereby, as the situations chosen were invariably such as either to command a view for a long distance over the country, or, if near the water, to be so constructed that a fleet of canoes could be seen a long distance away, so that sudden attacks by water would be impracticable. The forts were generally made either circular or oval, although one or two surveyed were crescent or semi-circular, the form probably depending upon the lay of the land; and it is very singular that there has not been, to my knowledge, a single fort discovered in Canada which even approaches a square. Entrenchments seem to have been a not uncommon mode of defence, and have every appearance of being anterior to the wall or embankment forts; the largest one surveyed was half a mile in circumference, of a circular form, and, judging by counting the concentric rings of trees growing right in the ditch, which must have grown after the fort was constructed, also by decayed vegetable-matter and other evidences, was computed to be from 800 to 1000 years old. Ancient burial-places may be classed under three heads—mounds, ossuaries, and single graves. Mounds are not of frequent occurrence in Canada, and all which have so far been examined have contained human bones, proving that they were used as burial repositories. These tumuli (if they may be so termed) are not by any means large; they generally measure about 100 feet in circumference, and are only about 5 feet high. The dead seem to have been buried without any regular system, each mound containing from six to twelve bodies. The ossuaries are probably the most interesting remains we have. They consist of round symmetrical holes dug to the required depth, and into which the bodies were promiscuously deposited; some of the larger ones contain the remains of several thousand bodies. The single graves are the most ordinary remains we have, and are generally found on high ground, a hill-top being a favourite site. In dwelling upon sepulture, I trust to be able to show clearly that the burial of articles with the dead was not so much a religious act as a mark of respect to the dead. The archaeological relics of Canada have never been fully described, and are deserving of a higher rank, in a scientific sense, than has as yet been accorded them. We have a grand field to work in, and the articles we find well repay us for the trouble taken. The aborigines of America are undoubtedly the fathers of smoking, and the elaborate workmanship which was bestowed upon their pipes shows the important place it took in their every-day life. There are no articles found which so well portray the aboriginal ingenuity as the pipes. Animals, birds, reptiles, and the human physiognomy are all carved upon the bowls and stems with life-like accurateness. Many specimens found would trouble a clever artisan of the present day to duplicate, allowing him all the modern tools to work with, because stones, tools, ornaments of various kinds, &c., were also manufactured with a precision simply perfect; and, strange to say, it seems to have been a matter of little moment whether they worked the hardest or softest qualities. Pottery, shell, and bone were extensively used in the manufacture of articles for their every-day life, whether for ornaments or necessary utensils; copper was also utilised to some extent, principally for tools, ornaments, and sword-blades; the ore was merely pounded into the required shape. Shells, which must have been brought a distance of nearly 2000 miles, are sometimes found in graves, evidencing the extraordinary fact that a trade must have been carried on between the aborigines of the north and those of the south, which, extending over such a vast distance, and with their primitive mode of travelling, must have made the articles exchanged of great value. The wampum was probably nearly altogether carved from these foreign shells.

Major J. W. Powell, U.S.A., read a paper on *The Classification of North American Languages*. Major Powell said that

in his remarks he would confine himself to those languages which possessed at least a thousand words. Pointing to a map of the United States on which the distribution of the languages was marked, the speaker said that there were four great distinctive tongues on the continent, the Algonquian, the Shoshonian, the Siouan, and the Athabaskan. The classification of these languages was impossible, he said, but we could classify the arts, the habits, the philology of the peoples. He remarked on the fact that grammars and dictionaries, books, and even newspapers, were published in some of the Siouan languages, the Dakotan for instance. For the purpose of convenience and study of the North American languages, rules had been drawn up and adopted, which rules were read and commented upon by Major Powell. One of these was that family names should not be recognised if they consisted of more than one word, and another that all tribal names should terminate in "an," as Algonquian and Shoshonian. These were highly necessary to prevent confusion. The speaker described the difficulty he had experienced in classifying the different names during the past fifteen years, and remarked that the affinities of various languages were not yet practically determined. Within a year, he hoped, would be completed, as far as the United States were concerned, but it would take some years before the work for the North American continent was concluded. Four gentlemen were now in the field engaged in collecting vocabularies for this purpose. Remarking on the likeness between the words "kayak" and "caique," Major Powell said that it could be imagined how extremely difficult it was to decide upon such a matter, there being, for instance, eighty languages in North America which possess no affinities with each other. Grammatical affinities might exist, but none closer. He thought that early arts could not be relied upon to connect peoples. Institutions and languages were more valuable and lasting helps to classify nations, the latter especially so. Finally, the speaker said that, as there were eighty different stocks of languages and the same number of mythologies, it would be a long time before their labours were completed.

Mr. Rosefeldt observed that, although he had lived among the Indians for some years, he had never met with an Indian who could pronounce the letter R. In this they were like the Chinese, and therefore might have migrated into America by way of Behring Straits. He related an incident which occurred during his residence amongst the Indians. One of them asking him to what family he (the speaker) belonged, Mr. Rosefeldt replied, the fox, as this animal occurred in his coat-of-arms. The Indian said, "Then I must be your 'pickanniny,' or son, showing the figure of a snake on his arm, 'as the snake is the son of the fox!'" This showed that the Indians imagined that they derived their descent from various animals.

Mrs. Erminie A. Smith read a paper on *The Customs and Language of the Iroquois*. Some years ago Mrs. Smith was received into the tribe of the Tuscaroras, and adopted as a sister by one of the chiefs of that nation. An assemblage was held to do honour to this auspicious event, and a handsome bead-work dress was prepared for Mrs. Smith. The chief who adopted her being one of the "Bear" family, she also became a Bear. Mrs. Smith made some interesting remarks upon the costumes and upon the gambling habits of the Indians, and showed some of the silver brooches used by them as stakes in the games. A hair "waterfall," composed of some five hundred scalps joined together, was exhibited, as well as the temperance banner of the Tuscaroras; this bore a rude representation of the American eagle destroying the demon of intemperance, with six stars of the six nations, and figures of the animals which are symbols of the tribes. Noticing the construction of the Iroquoian language, Mrs. Smith said that there were two so-called genders, noble and ignoble; the former comprised God, men, and angels, and the latter demons, the lower animals male and female, inanimate objects, and "women, children, and other chattels."

Mr. F. H. Cushing read a paper on *The Development of Industrial and Ornamental Art among the Zunis of New Mexico*. The speaker's remarks were illustrated by numerous specimens of pottery and other kinds of work done by the Indians. Mr. Cushing said that by adoption of the Zuni language, customs, habits of living, and costume, to the minutest particular, he had been enabled to obtain a vast amount of information regarding these people—descendants, as he said, of the "Pueblo Indians." The word "Pueblo," he explained, was applied to a nation who lived in communal dwellings. He brought forward evidence, linguistic and otherwise, to prove the descent of the Zunis from

these races. He described the causes that led to the architecture of the petty clans, such as a need of protection which induced them to seek the caves in cliffs, and traced the history of the "Pueblo" or communal dwellings. The art of pottery, he said, was practised in the "Pueblo" district to a very great extent. He gave an interesting account of the formation of the Zuni gourds, or water vessels, showing how they were covered with wickerwork in order to preserve them. Basket-work vessels were also used, these latter being covered with a preparation of clay in order to prevent the escape of the contents. Mineral coal was used in the manufacture of earthenware vessels and also upon the corrugated surface given to the bowls. A curious fact with regard to the food utensils of the Zunis was that they regard the bowls they make as possessing something in the nature of life or spirit. They place food and water near the vessel, and as a woman completes it she imagines she has made something like a created being. The different sounds made by the pots as they are struck, or as their contents boil, for instance, are believed to be the voices of the beings which are associated with the vessels. Apertures or blank spaces are left for the escape of this spirit. A Zuni woman, as she closes the apex of a pointed clay vessel, turns her eyes away, and says that it is "fearful" to watch this operation. She thinks that if she knowingly (that is in her sight) closes this orifice, which she regards as a source of life, the source of life in herself may be closed, and that she may be debarred from the privilege of child-bearing. Other evils are also expected to follow if she does not turn away as she completes the vessel's shape by closing the apex. The Zunis, in representing animals, always show a kind of line or passage leading from the throat to the heart, and cannot be induced to dispense with this line in any pictorial representation of animals. In conclusion, the reader of the paper referred to the probable origin of the shapes used in the pottery of America.

Dr. Daniel Wilson then read a paper on *The Huron-Iroquois, a Typical Race of American Aborigines*.—He remarked upon the natural boundaries of countries, and the difficulties they presented to nomadic races. East of the Rocky Mountains the ethnology was comparatively simple. There were but three great races or families, the Iroquois, the Algonquin, and the Athabaskan. The Blackfeet were, however, a different race, and possessed different characteristics. West of the Rocky Mountains the subdivisions were more numerous, but not so large. He mentioned the valuable though imperfect vocabulary of Jacques Cartier, which showed something of the language used by the Iroquois or Six Nations. He enumerated the nations of which this confederation was composed, and remarked upon the localities in which they lived. The original native population of this part of Canada, Dr. Wilson said, was the Huron-Iroquois. They were found in the valley of the St. Lawrence by the early explorers. Some of them had been driven out and had returned to Canada at the time of the American Revolution, in one case, he said, bringing with them the silver communion service given to the Mohawk church by Queen Anne, and now used in the Tuscarora church. Dr. Wilson referred to the Indians of Lorette and of Anderson as representing the ancient type of Hurons. These people, he said, believed that their ancestors came from the neighbourhood of the "great sea" or the Atlantic. The speaker then showed a skull, probably that of a Hochelaga Indian, which had been found near this spot. This, he said, presented all the types of the Huron race. He contended that it was a Huron people that had been found here by Jacques Cartier, though he said that the funeral customs of that nation did not seem to have been practised in this district. These funeral customs, and the ceremony of the "feast of the dead" were described in an interesting manner by the Professor. Dr. Wilson remarked upon the want of knowledge of metallurgy shown by the inhabitants of North America, and the general slow progress in civilisation which was displayed by these people. Copper in large quantities was ready to their hand, but no trace of its being used was found, and the application of fire to the metal seemed not to be thought of. He noticed the earth-works of the Ohio Valley, which he said should be visited by the British visitors before their return to Europe. He concluded by referring to the influence that the half breed population of Manitoba might have in future times upon the inhabitants.

Dr. Tylor, after expressing his thanks to Prof. Wilson for his communication, called upon Mr. Horatio Hale to make some remarks upon the subjects on which the last speaker had touched. This Mr. Hale did, saying that the tradition amongst the Hurons was that their ancestors had moved westward from the districts

in which they were found by Cartier. With regard to the question of the language of the Hurons as compared with that of the Iroquois, Mr. Hale read a letter from the Hon. Judge Force, of Cincinnati, who had studied this subject. Mr. Hale also made some interesting observations on the difference of pronunciation between these people, his remarks being listened to with deep attention.

Prof. G. Lawson read a paper on *Food Plants used by the Indians*. The Professor began by remarking on the various berries that were found on this continent, as well as the numbers of nut-bearing trees. He showed that the wants of the aborigines would be supplied by the natural products of the woods and fields, and spoke particularly of the wild potato of Nova Scotia, which was so well known among the Indians. Other plants noticed were the bean, fields planted with this vegetable being found by Columbus and by Jacques Cartier, and maize, which was also much used. Beans were grown among the Indian corn, which formed the main crop. Evidence showed that plants like melons, pumpkins, and others of the same nature were cultivated by the Indians. Columbus, in 1492, found these plants surrounding Indian villages in such a condition as proved that they were cared for.

Lieut. A. W. Greely exhibited a collection of photographs of Esquimaux relics.

Lieut. P. H. Ray read a paper *On the Habits and Customs of the Inu of the Western Shore and Point Barrow*. Many of the natives had been measured, and it was found that the tallest height was 5 feet 10 inches, and the lowest 5 feet 1 inch. This was much higher than the natives of Greenland. Their powers of endurance were wonderful. Marriage laws they had none: the contract was severed at will. They never quarrelled or entered upon any controversy, and were extremely kind to their parents. Lieut. Ray described the manner in which these people prepared their food for travelling, and in which they captured the reindeer and the seal. Though they did not believe in a future existence, they were intensely superstitious, as Lieut. Ray found when he learned their language, and they paid great veneration to the oldest of their women. He thought these people the most primitive that white people had ever come in contact with.

Mr. R. Law read a paper by himself and Mr. J. Horsfall, *On Some Small Flint Implements found beneath Peat on Several Elevated Points of the Pennine Chain lying between Huddersfield and Oldham*.—Mr. Law introduced his subject by saying that, though perhaps of a local nature, it might be interesting. In the course of his paper he said that the flint implements which had been discovered had been submitted to competent authorities, and it was considered that they were the smallest ever discovered in England. They were supposed to have been carving implements, and some of them were not more than one inch in length and a quarter of an inch in breadth, while they were carefully marked and chipped on the edges. The speaker concluded by describing the moorland country and geological character of the soil in which these implements were found.

#### SCIENTIFIC SERIALS

THE *Journal of the Franklin Institute* for August contains:—Wire triangular truss, by Chas. J. Quetil, C. and M.E. (illustrated).—New British standard wire gauge.—Report on the trial of the "City of Fall River," by J. E. Sagne, M.E., and J. B. Adger, M.E., with an introduction by Prof. R. H. Thurston (continued from vol. cxviii. p. 74, illustrated, and with a table).—Tests by hydrostatic pressure, by S. Loyd Wiegand, M.E.—Velocity of approach in weir computations, by A. W. Hunking and Frank S. Hart (with tables).—The earth's ellipticity, by L. D'Auria.—Suggestions for the improvement in the manufacture of glass, by George W. Holley.—Survey of the future water-supply of Philadelphia, by Rudolph Hering, C.E.—Influence of high pressure on living organisms.—Atmospheric changes at Nice.—Bernau's telescope.—Microscopic organisms on the surface of coins.—Magnetism in Madagascar.—Selective absorption of solar energy.—Use of oxygen as a refrigerant.

*Annalen der Physik und Chemie*, No. 8, July 1.—On a new method of determining the vapour-densities of bodies with a low boiling-point, by Nik. von Klobukow (10 figures and a table).—On a new method of determining the vapour-densities of bodies with high boiling-points, by Nik. von Klobukow (7 figures).—On the influence of pressure on the viscosity of liquids, particularly of water, by W. C. Röntgen (2 figures and 2 tables).—On the

influence of density on the viscosity of dropping liquids, by E. Warburg and J. Sachs.—On the conductivity of heat of tourmaline, by Franz Stenger (2 figures).—The expansion of crystals by heat, by Eug. Blasius (3 figures).—On the passage of electricity in gas, by F. Narr (with tables).—Remarks on the resistance box of Siemens and Halske, by E. Dorn (4 figures).—On the known dichromatic colour-systems, by Arthur König (1 figure).—On the sensibility of normal eyes for the perception of light of long wave-length, by Arthur König and Conrad Dieterici (1 figure and tables).—Metallic and total reflection of isotropic media explained by means of Neumann's system, by E. Ketteler.—Experimental determination of the wave-length of the invisible prismatic spectrum, by S. P. Langley (5 figures and table).—Demonstration research on the relation between light polarised by reflection and by refraction, by G. Krebs (4 figures).—On a freezing apparatus, by E. Lommel (1 figure).

*Journal de Physique théorique et appliquée*, August.—On the electric conductivity of very weak saline solutions, by M. E. Bouty (7 parts, 30 pages, with figures and tables).—The influence of heat and magnetism on the electrical resistance of bismuth, by M. A. Righi.—Variation in the physical properties of bismuth placed in a magnetic field, by M. Hurion.—Variation of the resistance of bismuth and some alloys with the temperature, by M. A. Leduc.—On some experiments illustrating an explanation of Hall's phenomenon, by Shelford Bidwell.—Note on Hall's phenomenon, by Herbert Tomlinson.—The explosive wave, by MM. Berthelot and Vieille.—Researches on the compressibility of gases, by E. H. Amagat.—Mémorial on the compressibility of air and carbonic acid at 1, 8, and from 20 to 300 atmospheres, by E. H. Amagat.—On a new form of the relation  $F(\rho v t) = 0$ , relating to gases, and on the law of the expansion of these bodies at constant volume, by E. H. Amagat.

## SOCIETIES AND ACADEMIES

### SYDNEY

**Royal Society of New South Wales**, August 6.—H. C. Russell, B.A., President, in the chair.—Four new members were elected. Donation received consisted of 327 vols. and pamphlets, forty-six anthropological photographs, and a collection of fossils.—A paper was read by Mr. Lawrence Hargrave on the trochoidal plane. The paper was explanatory of some models of animal progression exhibited by the author before the Society, and gave in detail the opinions and deductions he had formed from his observations of the natural motions of animals. The author was of opinion that there was evidence to show that Nature almost universally used the trochoidal plane for the transmission of force, and that its use by man opened up a wide field for engineers; he asked the opinion of the members whether there were grounds for believing that the trochoidal plane was a distinct mechanical power, and if not under what head they classed it.

### PARIS

**Academy of Sciences**, September 29.—M. Rolland, President, in the chair.—Remarks in connection with a work "On the Origin of the Earth," presented to the Academy by M. Faye. The book is described as mainly historical, recording the various theories on the cosmogony of the universe that have prevailed from primitive times down to the present day.—Observations on a preceding communication dealing with the theory of the form of the planets, by M. F. Tisserand.—On the vegetation of the Amaranthaceæ: distribution of the fundamental substances amongst the various parts of this family of plants and its congeners at the various periods of their growth, by MM. Berthelot and André.—A simple process for effecting the separation of cerium and thorium from mixtures in which these elements are found, by M. Lecoq de Boisbaudran.—On the solubility of the prussiate of gallium; rectification of a previous communication by M. Lecoq de Boisbaudran.—On the trinomial linear equation in matrices of any order, by Prof. Sylvester.—Report of the Commissioners, MM. Bouley, Bert, Gosselin, Marey, Pasteur, Vulpian, and Richet, on various communications touching the treatment of cholera. Of the eight communications received since the last report, five are undeserving of mention. The three others are rather theoretical than practical, and that of Dr. Pereda y Sanchez alone seems to contain a few suggestions worthy of further consideration.—On the second experiment made by MM. Tissandier brothers to propel a screw balloon by means of electricity, by M. G.

Tissandier. This trial, made on September 26 at Auteuil with improved appliances, yielded all the results that could be expected from a balloon constructed with an exclusive view to experimental study. The vessel proved perfectly stable, obeying every movement of the rudder, and enabling the aéronauts to execute numerous manœuvres in various directions above Paris.—Observations of Barnard's comet and of Luther's planet made at the Observatory of Nice, by M. Perrotin.—Observations of Wolf's comet made at the Paris Observatory (equatorial of the West Tower), by M. G. Bigourdan.—Observations of the same comet made at the Paris Observatory (equatorial *coude*), by M. Périgaud.—Observations of the same comet made on September 21 at the Observatory of Bordeaux with the meridian circle, by M. Courty.—Note on the group of points in involution marked on a surface, by M. Le Paige.—Description of a new polarising prism presenting some advantages over those of Nicol and of Hartnack and Prazmowski, by M. E. Bertrand.—Note on the products obtained from tellurium acted on by nitric acid, by MM. D. Klein and J. Morel.—On the employment of the sulphate of copper (blue vitriol) for the destruction of mildew, by M. Ad. Perrey. Vines recently treated with this solution in the department of Saône-et-Loire were everywhere distinguished from the surrounding plants by the bright green colour and healthy appearance of their foliage. But this remedy seems to be efficacious only in the case of young vines from four to six years old.—Report on the present climatic conditions and sanitary state of the isthmus of Panama, by M. R. Regnier. The prevailing notions regarding the insalubrity of this region appear to be unfounded. Its temperature varies from 24° to 30° C. in winter, rising to 35° in summer. The climate is hot and moist, with two seasons, summer and winter, the latter being the rainy season and the shorter of the two. Although the climate does not produce the same depressing effect on Europeans as many other tropical countries, certain hygienic precautions should be taken and scrupulously observed. Two large hospitals, one at Panama, the other at Colon, have been erected for the treatment of the men at present employed in the construction of the canal. A health resort has also been established at Taboga, and these various measures are stated to have reduced the mortality almost to a lower rate than in many great centres of industry. It is at present about 2.5 per cent., a proportion not exceeding the average of European countries.

## CONTENTS

	PAGE
The Cholera Poison . . . . .	557
The Sanitary Institute at Dublin . . . . .	557
Contributions to Phenology . . . . .	558
Letters to the Editor:—	
The Younger School of Botanists.—W. T. Thiselton Dyer, C.M.G., F.R.S. . . . .	559
The Solar (Dust?) Halo.—Prof. E. Douglas Archibald . . . . .	559
Cole's Pits.—Rev. A. Irving . . . . .	560
The Flow of Streams.—George Higgin . . . . .	560
Lepidoptera.—G. Lovell Gulland . . . . .	560
Animal Intelligence.—Dr. Hyde Clarke . . . . .	561
Shifting of the Earth's Axis.—W. M. Flinders Petrie . . . . .	561
To Find the Cube of any Number by Construction.—R. Tucker . . . . .	561
The Ascent of Water in Plants . . . . .	561
Natural Science in Tasmania . . . . .	562
Explorations in Iceland. By Th. Thoroddsen . . . . .	563
The Connection between Chinese Music, Weights, and Measures . . . . .	565
Notes . . . . .	566
Physical Notes . . . . .	568
Geographical Notes . . . . .	569
A Gigantic Earthworm. By F. E. Beddard . . . . .	570
The Action of Ammonia upon some Lepidopterous Pigments. By George Coverdale . . . . .	571
Scottish Fishery Researches . . . . .	572
The British Association:—	
Section D—Biology—Department of Zoology and Botany . . . . .	573
Department of Anatomy and Physiology . . . . .	575
Section II—Anthropology . . . . .	577
Scientific Serials . . . . .	579
Societies and Academies . . . . .	580

THURSDAY, OCTOBER 16, 1884

## HANDBOOK OF BOTANY

*Handbuch der Botanik.* I. and II. Herausgegeben von Dr. A. Schenk. (Breslau: Verlag von Eduard Trewendt, 1879-1882.)

AS early as 1861 it had become apparent to certain leading German botanists that the limits of their science had been so far extended as to make it impossible for one writer to treat the whole subject with such uniformity and thoroughness as is required in the composition of a standard text-book, including the substance of the facts well ascertained up to the date of its issue. Accordingly Hofmeister, with the assistance of others, and especially of Sachs and De Bary, planned a joint "Handbook of Physiological Botany," and though, owing to the difficulties which are always liable to attend joint authorship, the parts written by the several contributors were issued at various dates from 1865 to 1877; and though some of the parts included in the original scheme never appeared at all, those published are together the result of the most considerable attempt hitherto made to issue a comprehensive and standard Text-book of Physiological Botany. During the twenty years which have followed the adoption of this plan by Hofmeister and his colleagues unprecedented advance has been made in the science, and it is thus still more necessary than before that the task of authorship of a comprehensive handbook should be divided. The "Handbook of Botany," which is in course of issue by Prof. Schenk, and of which two volumes are already complete, is a second attempt, somewhat similar in idea to that of Hofmeister, though differing from it in many points. The staff of authors is larger, and since the space allotted to the several authors is less, greater uniformity in date of issue has been attained; there is, however, in Schenk's "Handbook" no pre-arranged and well-balanced plan of the ground to be covered, or at least the first two volumes give no clue to any such plan. Each article appears to be independent of its neighbours, and must be regarded as a separate essay on a definitely circumscribed, and in some cases a very limited, branch of the science. Since this is the case, it is clear that the "Handbook" cannot be used by beginners as a text-book of the science; it is suited rather to specialists, and others who may desire special information on the subjects which are treated. To these the book will be of the greatest use and interest, since the articles are written by well-known men, who have made the subjects of their essays their special study.

It will be impossible here to discuss each of the articles in detail, nor indeed will it be necessary to do so, since in more cases than one the articles are in the main useful epitomes of more extended works already well known to the public; in other cases, however, the articles are the result of fresh constructive work. While those of the former category will be merely named, those of the latter order demand more careful attention.

The first article, entitled "Die Wechselbeziehungen zwischen den Blumen und ihre Kreuzung vermittelnden Insekten," is by Dr. Hermann Müller, whose name will

be sufficient guarantee of its excellence; while it is written in such a style as to interest those who have not made botany their special study. It is followed by a short article by Prof. Drude on Insectivorous Plants. The essay on the Vascular Cryptogams, by Dr. Sadebeck, is one of the most important of the whole series: the author gives a concise account of the chief facts hitherto ascertained, and has arranged them on a plan which is well suited to their comparative treatment. After a short general description of the cycle of life as found in these plants, he treats in the first section of the spore, germination, the prothallus with the sexual organs, and the embryo; while the second section is devoted to the vegetative organs and the sporangia. Each organ is described successively, as far as it is known, in the various forms of vascular Cryptogams, and thus the comparison of details of structure and development of each organ in various groups is made more easy than is usually the case in other works. Then follows an article by Prof. Frank under the heading "Die Pflanzenkrankheiten"; this may be regarded as a useful abstract of his more extended work on the same subject, which is already well known to botanists. The first volume is brought to a conclusion by an article on the Morphology of Phanerogams, by Prof. Drude. It has been the object of the author to furnish a compendium of the external conformation of flowering plants, and their sexual organs, reference being made to their comparative anatomy and development. At the present day this object is in itself unsatisfactory: to gain a true insight into the morphology of Phanerogams reference must necessarily be made to the lower forms, and the want of such reference and comparison is apparent throughout this article, especially in that part of it which is devoted to the morphology of the flower.

The second volume includes, in the first place, a treatise on Vegetable Physiology, by Detmer, which has laboured under the disadvantage of being published almost simultaneously with the excellent lectures of Prof. Sachs on the same subject. It is followed by Falkenberg's essay, headed "Die Algen im weitesten Sinne," which is one of the most important of the whole series. In the introduction he shows how the classification of the Thallophytes proposed by Cohn in 1872, and adopted by Sachs, led the way to the system of classification proposed by De Bary for the Fungi; this writer, after excluding the Myxomycetes and Schizomycetes, recognises that the various remaining groups of Fungi may be regarded according to their morphological characters as a natural series. Falkenberg treats the Algae in a similar way; he strips off from the whole series of chlorophyll-containing Thallophytes (to which the term Algae in its widest sense may be applied) certain outlying groups, viz. the Diatomaceæ, Schizophyceæ, and Floridæ; the remaining Chlorophyceæ and Melanophyceæ together form that series which he terms the *Algae in the narrower sense*. Adopting this general method, the author has constructed a compendious description of the whole series of Algae, which will well repay those who read it. The essay on the Muscineæ, by Goebel, is written in a similar spirit to that of the article which precedes it, and can be well recommended as giving the best concise account of the morphology and development of that class hitherto published. The article by Prof. Pfitzer on the Diatomaceæ will be welcomed, as

giving in an accessible form a detailed account of the structure of these plants from the pen of one who has already distinguished himself in this field. The second volume is brought to a close by a treatise by Haberlandt named "Die physiologischen Leistungen der Pflanzengewebe," a subject well suited to one of the Schwendenerian school, to which its author belongs. Anatomical facts, many of which are already well known, are here placed before the reader in the light of the anatomico-physiological method, which the pupils of Schwendener claim as having been initiated by him in 1874.

From what has been already said, it is clear that this "Handbook" will, by the individual worth of many of its articles, take a prominent place among standard botanical works, and will undoubtedly be of great service to advanced students. Further volumes are still in progress, and the appearance of their successive numbers will be looked forward to with interest.

F. O. B.

#### OUR BOOK SHELF

*A Synopsis of the British Mosses.* By C. P. Hobkirk, F.L.S. Second Edition. 8vo, 240 pages. (London: L. Reeve and Co., 1884.)

THIS is a new edition of a work that appeared originally in 1873. There is no other recent handbook of British mosses, so that it has had the field entirely to itself, and has had a large circulation amongst our home collectors. It is a cheap working handbook, something on the scale of Babington's "Manual of the British Flowering Plants and Ferns," without any figures, but with full diagnostic characters of all the indigenous genera and species. Britain is exceptionally rich in mosses, and in this new edition 129 genera and 576 species are enumerated and described, with a short notice of locality.

Mr. Hobkirk is well known as an excellent practical bryologist of many years' experience. He has not attempted either in this or the previous edition to introduce any novelty in classification. In the first edition he followed Wilson closely, and Wilson in his turn deviated but little in arrangement, nomenclature, and the circumscription of genera and species from the great standard work on the mosses of the whole of Europe, the magnificent "Bryologia Europea" of Bruch and Schimper, which contains elaborate figures of every known species. In this second edition Mr. Hobkirk has altered his classification to correspond with that of Jaeger's "Adumbratio Muscorum," a change which we consider of very doubtful utility, as it has the effect of making the preliminary synopsis much more elaborate and more difficult for a beginner to understand and use.

An illustrated work on British mosses brought up to the standard of Bruch and Schimper has been greatly wanted. Now, Dr. Braithwaite is bringing out in parts a work of this character, with admirable original drawings and detailed descriptions. At the present time this is about one-third completed, and it is greatly to be hoped he may have health and strength to finish it. For any one needing a cheap working handbook we can cordially recommend the present book. It contains a brief glossary of terms. Only the names that are adopted are given, without any synonyms. One fault in the preliminary key that will puzzle a beginner is the want of definitions for the two primary divisions—Sacomitria and Stegomitria. Another point that without explanation will likely puzzle students is that the authorities cited for each species are those of the author who first used the specific name, taken quite independently of the genus under which it is now placed, so that, for instance, Linnæus is cited as the authority for *Eucladium verticillatum*, when the genus *Eucladium* was first characterised by Bruch and Schimper

half a century after Linnæus died. The orthodox plan is to cite the authority for genus and species combined.

J. G. BAKER

*Our Insect Allies.* By Theodore Wood. 8vo, pp. 1-238. (London: Society for Promoting Christian Knowledge, 1884.)

WRITERS on popular entomology are hard driven nowadays to find titles for their works, or subjects that have not already been worn to shreds by previous authors. To be successful they must possess the same talent that enables a *chef-de-cuisine* to contrive an *entrée* from the same materials, so disguised by name and sauces as to lead his patrons to consider they are partaking of a new dish. The author of this nicely got up little book has evidently felt himself in such a position, but on the whole he has succeeded very well, the more so because there are fewer errors than ordinarily exist in popular entomological works. He takes as his standpoint the fact that very many insects are indisputably serviceable: some by ridding the world of putrid or unhealthy organic matters, both animal and vegetable; some by destroying other insects undoubtedly noxious. The result is that we get here a series of histories of individuals or groups detailed in popular language, often from personal observation, and for the most part well illustrated by woodcuts. The author evidently feels himself most at home in dealing with the *Colleptera*, and, as we think, judiciously takes up the position that bark-beetles and wood-borers are scavengers, seeking to devour what is already morbid, and are not the cause of decay in the trees in which they are found. We fail to follow his account of the mechanism by which the click-beetles (p. 207) perform that acrobatic movement so familiar to our childhood in the shape of the "jumping frog"; to our mind the "mucro" that is the chief agent in this action is not "elastic." Why are the *Aphis*-parasites known as *Aphidius* stated to be *Chalcididae* (p. 168)? Why is a *Syrphus* larva figured (p. 160) as that of a "Golden-Eye," or "Lace-Wing"? The introductory remarks and the concluding notes contain some very judicious reasoning on the aim and purpose of entomological studies, and we sincerely wish we could agree with the author (p. 236) that collectors, as opposed to students, are "now in a very small minority"; a vast improvement towards this end has undoubtedly taken place latterly, but the time for congratulation has not yet arrived. The Society under whose auspices this little book is published has done much towards popularising natural history in this country; this work may be classed amongst the best of the series, and no doubt in a second edition the author will revise it and rectify a few palpable errors.

#### LETTERS TO THE EDITOR

[The Editor does not hold himself responsible for opinions expressed by his correspondents. Neither can he undertake to return, or to correspond with the writers of, rejected manuscripts. No notice is taken of anonymous communications.]

[The Editor urgently requests correspondents to keep their letters as short as possible. The pressure on his space is so great that it is impossible otherwise to insure the appearance even of communications containing interesting and novel facts.]

#### Shifting of the Earth's Axis

HAVING quoted the Greenwich observations so often, and with all respect, during the last twenty years, in my several Great-Pyramid publications, as showing that there is a slow shifting of the earth's axis going on, with the effect of altering the latitude of places minutely from age to age (see more especially p. 81 of fourth edition of "Our Inheritance in the Great Pyramid"), I cannot remain unconcerned when the present energetic Astronomer-Royal comes out so very positively with the statement that the Greenwich observations of the last forty-seven years (which he confines himself to) show nothing of the kind, and that there is no such movement of the earth's axis going on.

At least so I understand his letter in NATURE, vol. xxx. p. 536. If that statement or conclusion is perfectly correct, I must of course allude to it in the next edition of my Pyramid book, and adopt its corrections, whatever they may lead to; so that it is well at once to ask any further questions which seem demanded for full trust and credibility.

That the observations made at Greenwich during the last forty-seven years, when computed as the said Astronomer-Royal has computed them, do not show any change of latitude during that space of time, no one is more ready to allow most honourably than myself. But before we can admit that that result, pure and simple, absolutely establishes the non-shifting of the earth's axis of rotation, two more things at least must come about, viz. :—

First, the Astronomer-Royal must attack and demolish the observations and calculations made at the great Russian Observatory of Pulkowa, which show that such a change, at the rate of about one foot *per annum*, has been going on through the last quarter of a century, and are even believed in America to be more accurate than the Greenwich observations. And

Second, he must take up, and similarly destroy, the testimony of the earlier Greenwich observations themselves, before these last forty-seven years of his own computation began.

Now those earlier Greenwich observations were so remarkable for what they did indicate in their own time, that I may freely mention now, seeing that all the parties are dead, that somewhere about 1836, Sir Thomas, then Mr. Maclear, at the Royal Observatory, Cape of Good Hope, received a private letter from Thomas Glanville Taylor, Honourable East India Company's Astronomer at Madras—and earlier an assistant at the Royal Observatory, Greenwich—stating his belief that the latitude of the British National Observatory was continually decreasing; and he gave a list of latitudes, as determined by Greenwich observations, so far back as they went, but condensed into three epochs, to prove the point.

The matter was kindly communicated to me by my then chief, Sir Thomas Maclear, and was of course deemed interesting and curious at the time; but had quite gone to rest in my mind, until twenty-nine years afterwards, when I fell across the same effect, in the same direction and at nearly the same rate, but through a longer period of time and to a much larger accumulated quantity, at the Great Pyramid of Gizeh in Egypt. The datum for the latitude of 4000 years ago, to compare with the present observed latitude of the same spot—though exactly that which the learned Dr. Hook desired so much, but in vain, to find anywhere 200 years ago—is not perhaps so purely and perfectly scientific as the high-class practical astronomers of our times will always condescend to notice. But in the accompanying feature of change of azimuth, so creditably brought to the front by Mr. Flinders Petrie, there is a testimony of modern observation to ancient accuracy of so respectable a character—if I may be allowed so to say—that it ought not to be entirely ignored; and it was first mentioned thus.

While I was at the Great Pyramid in 1865, and just after I had there measured the azimuths of the entrance-passages of the Great and Second Pyramids on successive evenings by reference to the six-hour elongations of Polaris, there came a letter from a retired civil engineer in Edinburgh, a man of long Batavian experience in his day, and gifted with remarkable powers of modern science and originality of mind,—in which letter he was pleased to run down all the presumed object of my work out there on the Gizeh Hill. Especially too was he pungent on the point that even the best of the ancients had not that triumph of modern civilisation, “the manufacturing principle,” in them; “for,” said he, “they could not make two things alike.”

Whereupon I sent him the azimuths of the entrance-passages of those two grand pyramids, so many hundred feet apart, and pointed out, that, though they showed an error of azimuth for modern date of nearly five minutes, yet the one pyramid exhibited so very nearly the same identical quantity as the other,—that they were, angularly, nearer together, or more exactly alike, than were the two halves of one and the same azimuth circle I was observing with. And yet that circle was by so celebrated a maker of modern times as Troughton, and the instrument a choice one specially made by him to be presented to the celebrated Prof. Playfair, by his admiring students in the University of Edinburgh; and by Playfair's executors, again, presented after his death to the Royal Observatory, Edinburgh, where it is still preserved in honour.

C. PIAZZI-SMYTH

15, Royal Terrace, Edinburgh, October 10

### The Sky-Glows

IN reply to Mr. Backhouse's question (p. 511) as to where the context of Mr. Neison's remarks can be seen, I can only say that I do not know. I came across the portion quoted relating to these phenomena at the end of the Astronomer-Royal's Report upon the Weather of 1883. Like Mr. Backhouse, I have been on the look-out for solar halos, or big rings round the sun as we call them, for the last thirty years, more with a view to be prepared for squalls, &c., when boating, than anything else. But for some years there has been so much haze about the sun, and the weather has so often cried “Wolf,” so to speak, with no responding gale or squall, that of late I have ceased to take much note of such warnings. I may here mention that the rosy corona, when visible, as it so often is now, can be well seen by looking towards the place of the sun, but standing in the shadow of some high building; or at times by totally eclipsing the sun with a hat held between him and the eye.

As far back as January 1, 1884, in a letter to the *St. James's Gazette*, I ventured to predict that we had not seen the last of what were then spoken of as the “Recent Sunsets”; there was a very remarkable after-glow ten days after this, reaching the zenith, seen even in London. In the same letter of January 1, I suggested some increase in solar energy as the cause of these phenomena.

For some time, though feebler repetitions of the glows continued to be seen up to the end of March, there was nothing strong enough in the way of colour worth noting. But from what I continued to see in the shape of vapour, together with that strange warm colour by day about the sun, I felt sure that whatever might be the cause of these phenomena must still be going on, and in a short note dated April 12, I again spoke of their probable early reappearance. A graphic account of these after-glows, written by an observer at Smyrna, appeared in the *St. James's Gazette* of February 25, in which he pointed out what I have often since noticed, viz. that with excess of moisture all colour disappears.

This was at times very remarkable in the early part of July this year, when we had some of the strangest white sunsets I have ever seen. The sky around and above where the sun had set, looking almost ceiling-like in its opacity, upon which soon appeared numbers of weird small cloud forms, at times very regular, like ripple-marks in sand, or the bones of some great fish or saurian embedded on a slab of stone.

Against these pale sunsets all buildings and trees told like black velvet, while the clouds would rest almost stationary for a long time. Years back such a sky would have betokened a hurricane; but evening after evening they were repeated, and no storm of any importance followed. For many years past, but notably during the summer of 1883, I had observed a steady increase in a white luminous glare about the sun, so much so that I wrote about it in the year 1882 to my brother in India. I was not therefore surprised altogether when as the sunsets increased in colour, which they mostly do in autumn, that this glare last winter was followed by something more than usual in the way of colour; and here I should like to say that, as far as I have seen, and I have missed very few chances of watching them, that though last winter twilights often increased up to a certain time in strength, yet they did not exceed in duration the time allotted to twilight in the almanacs. This letter is already too long, but I cannot help asking, in conclusion, whether it may not be possible that we have been all along muddling up cause and effect, and that the eruption at Krakatoa, the recent earthquakes and waves, as well as the strange atmospheric phenomena, which are still about us, cannot all be traced to one cause, viz. actual increase of sun power?

Southampton

ROBERT LESLIE

THIS evening after sunset I noticed a column of yellowish light over where the sun had set, and moving with the sun. I have seen the same before. Can it be the zodiacal light? I have frequently noticed during the present year, while the sun was much too high for any sunset colours, a pinkish colour in the sky. This has been observed by others, but I do not know whether it has been seen outside the British Islands. It must be connected with the sunset-glows which several of your correspondents have described.

JOSEPH JOHN MURPHY

Belfast, October 12



### Circular Rainbow

IN the notice given in NATURE (Sept. 11, p. 465) of the beautiful circular rainbow that is seen in the spray of the Montmorenci Falls near Quebec, the expression in the heading, "seen from a hill-top" will convey an erroneous idea without some explanation. The complete circle is only seen by getting down in the spray to the edge of the low rocks, within a few inches of the level of the water, and the circular bow then passes down to the feet on each side; it is indeed most perfectly seen by turning round and stooping down to look back between the legs, when the complete circle is seen without interruption from the feet. The bow is small in diameter, and is a narrow band, appearing nearer to the eye than an ordinary spray rainbow. I had the pleasure of seeing it on August 25, on the occasion of the British Association Canadian visit.

WILLIAM P. MARSHALL

15, Augustus Road, Birmingham, October 13

### To Find the Cube of any Number by Construction

PROF. KARL PEARSON has kindly referred me for a simple graphical construction for any positive or negative power of any rational quantity whatever to Egger's "Grundzüge einer graphischen Arithmetik." This method, he informs me, is reproduced in Cremona's "Il calcolo grafico." I was of course aware that there were several simple constructions. I was induced to write upon the subject owing to the unexpected discovery that there was a line in the geometry of the triangle which enabled one to obtain the cube of a number.

October 14

R. TUCKER

### EXPLORATIONS IN ICELAND<sup>1</sup>

#### THE LAVA DESERT OF ÓDÁSAHRAUN

ON July 25 we set out for the southern Dyngjufjöll, in order to examine Askja. All previous explorers of that volcanic locality have taken the northern route from Svartárkot, but no one has hitherto approached it from the east, from Herðubreitð, any advance from that side having been deemed impracticable. This I wanted to test for myself, and shaped my course from the tent (pitched, as before said, to the south of Herðubreitð) in a direct line on the wide gap that opens in Askja to the east. The whole intervening country was one continuous succession of lavas, so effectively covered with pumice and scoriæ from the great explosion of 1875, fortunately for us, that the whole was really one scoriac plain, the pumice boulders measuring generally one to two cubic feet, some more, some less. If it had not been for this scoriaceous cover, these lavas would have proved pretty certainly utterly impassable for horses. We took good care to keep to the crests of the thickest pumice-drifts, and though such travelling is rough enough for horses, yet they sustain no great harm, because the pumice is so light and brittle. Under the south-eastern spurs of Dyngjufjöll we came upon a lake, shallow, but of considerable magnitude, of the existence of which there was no previous knowledge. About midway between Herðubreitð and Dyngjufjöll the country begins to rise up towards the aforementioned gap in Askja. Askja is a cauldron-shaped valley in the centre of Dyngjufjöll, which is an enormous complex of mountains 4500 feet high. This valley contains innumerable craters which have erupted at various periods; the sides of this valley rise to between 700 and 800 feet, but out of the aforementioned gap lavas have flowed over the lower country outside all the way down to Ódásahraun, forming an enormous oval of an average incline of 4° 33'. When we came close up to the gap, the scoriæ ceased, and at once the lava became exceedingly difficult to pass. But by aid of frozen snowdrifts filling dips and dints in the slopes, we managed to thread our way along, and thus actually to get into the valley; only one single tongue of lava we had to cross without the aid of snowdrifts—one which, though very narrow, we had the greatest difficulty in getting our ponies

<sup>1</sup> Continued from p. 565.

over. Having at last succeeded in this, we rode along frozen snowdrifts under the southern slopes of the Askja valley, and thus reached actually on horseback the craters which exploded here in 1875. Previous visitors to Askja have entered the valley through a pass in the mountains inclosing the valley from the north, outside which pass they have had to abandon their horses and to reach the craters on foot over an almost impassable lava-stretch in the bottom of the valley, taking four to five hours in passing the distance from the pass to the craters. From our tent by Lindaa it took us nine hours to reach the craters, but the return route we accomplished in seven. We now left our ponies provided with their fodder beside the large eruptor of 1875, and set off on foot to examine the locality in every direction, spending for that purpose the whole of the bright night and a portion of the next day. So over-covered was Askja with snow that journeying along here was like journeying in the heart of winter. The whole mass of Dyngjufjöll is made up of palagonite breccia interspersed with layers of basalt. Into this mass Askja sinks in the shape of a shallow basin, and may derive its present form partly from certain stretches of it having sunk down in consequence of eruptions, partly from that natural dint or basin-formation of valleys which is so strikingly common to tufa mountains in Iceland. But the supposition that the whole of this valley, about sixteen square miles English, is one crater, the result of one great volcanic explosion, is unwarranted. In the great eruption of 1875 a very considerable extent of ground "fell in" in the south-eastern corner of the Askja valley round the craters, and the vertical precipice of the fractured crust of the earth on the side of the Askja valley measures, according to Prof. Johnstrup's survey, 740 Danish feet; that at the opposite side in the mountains is at least double in thickness. The vertical walls of the precipices exhibit in a clear manner the successive layers of lava which fill the bottom of the Askja valley. In the earth-slip thus created there was, in 1876, a small lake of dull-green colour, circular, and measuring about 4000 feet in diameter. This lake now fills the whole bottom of the slip and measures 10,000 feet in length. In 1876 the temperature of the water was 22° Celsius (71°·6 F.), but has now fallen to 14° C. (57°·2 F.). The crater, which by its explosion covered the east country with pumice and scoriæ in 1875, is situated in the north-eastern brim of the fissure, and is 300 feet in diameter and 150 feet deep; its outer circumference flat, and built up of scoriac ashes, its inside cylindrical and perpendicular. In 1876 this crater only emitted steam, now it has turned into a boiling cauldron of clay, the clay mud at the bottom being gray with an admixture of bluish green tint, boiling and wallopping incessantly; through the south-eastern part of its bottom there issues by a subterranean vent a thick column of steam with loud roars and reports, and all around this column smaller fissures issue thinner jets of steam and fumes. Interspersed with the scoriæ in Askja and on the eastern side of the surrounding mountains are found small glazed grayish-blue pieces of trachyte thus formed by the last eruption; among these there are some found of which one-half, or a portion, is reduced to pumice, while the remainder retains its trachytic constituency. In the south-eastern corner of the dip right up from the water are also found a number of craters from which radiate rents and gulfs honeycombed with innumerable fumaroles and crater-tubes from which clouds of steam roll up high above the crests of the mountains, the roar and boom from which are heard to a great distance, resembling the rumbling sound of steam let off from many boilers at once. Deposits of sulphur are already visible round a number of the fumaroles, and yellow-green patches of sulphur show all about the precipices, where every chink and rupture lets off sulphurous fumes. In the eastern part of the slip the scoriaceous layers

have recently been rent asunder by a rift 150 to 200 feet deep, reaching from the summit of the mountain all the way down to the water. Across this rift there is no way of passing, and, in order to reach the south-eastern corner of the slip, it is necessary to scramble up to the top of the mountain, so as to get round the crevasse. It is difficult to form any adequate conception of the titanic grandeur of Nature at this spot. He who has once had the opportunity of viewing it from the precipice of the earth-slip will never forget the impression. Having finished my survey here, we returned to our tent the same way we had come, glad of rest, exhausted with fatigue and want of sleep as we were, after thirty-six hours' continuous travel.

On July 28 I set out on my return journey to Mývatn, taking a direct course across the northern part of Ódáðahraun to the farmstead of Grænavatn, on the southern side of the lake (Mývatn). This I did with a view to re-discovering the whole of the old highway, the eastern end of which I had already traced. First we shaped our course directly for the northern end of Herðubreiðarfjöll, guided by the beacons to which I have alluded already. We crossed a pass, dividing the easternmost neck of the mountains from the main range, in the eastern approach to which an excessively rough lava, split by innumerable rifts, had to be traversed, in which we succeeded by the mode of scrambling. On the verge of one of the rifts in this lava we came upon a dilapidated beacon, and again upon another on the western defile from the pass, from where we threaded our way along the skirts of a recent and very rough lava, directing our course for the central neck of Herðubreiðarfjöll. Here we were intercepted by two enormous rifts, 100 to 150 feet deep, divided by an earth-slip one mile broad, and twenty miles long. With the exception of Almannagjá and Hrafnagjá, near Thingvellir, these are the largest rifts in Iceland. Having succeeded in bringing our caravan over the eastern brim down alongside the spurs of an isolated "fell," we charged the western brim in vain for a long time until we came upon a sort of steep pass, up through which we brought our ponies, and found upon the verge three dilapidated beacons, which showed that we were still on the traces of the old highway. From this spot beacons may be still traced in a straight direction for Fremri Námur, but recent rifts and lavas have destroyed the road, which, though I now knew its direction, I could pursue no farther. Here, namely, we thought we had overcome all difficulties, but found soon to our cost that we were mistaken. Some distance to the east of Fremri Námur there is a quite recent-looking lava, very long, but narrow, which evidently has welled out of a lava fissure here in 1875, when, besides Askja, Mývatnsöræfi also were in a state of volcanic activity. This lava is not connected with the well-known more northerly lavas of 1875, wherefore its existence has been overlooked hitherto; and when Johnstrup constructed his map of the lava of Mývatnsöræfi, he was not aware of the fact that the same rift which gave birth to the northern lavas of 1875 had, further to the south, given existence to this, which measures fully one-half of the others. To the east of this lava the earth is all cut up by bottomless cracks, over which it was truly a breakneck business to pass. Across some we had to urge our ponies to jump, others we passed by means of natural bridges of loose boulders, which frequently gave way. This was travelling with one's life in one's hand, and to me it is the greatest wonder that no harm resulted to man or beast. To attempt crossing this new lava was entirely out of the question, so we had to bend our way southward along its eastern skirts until we might get round its southern spur. At this end of the lava I observed a peculiar rift not more than thirty to forty feet long and three to four inches broad, on which twelve craters were situated, in every way formed and shaped as large craters are generally, but of such miniature dimensions, that they looked as if they

had been intended for toys for children; the aperture of most of them was only four to five inches in diameter, that of the largest two feet. These had, however, squirted forth dashes of lava to the distance of sixty feet. When at last we had reached the southern end of the lava, a new trouble intervened in the shape of what appeared to be an endless rift, and utterly impassable. We had therefore to make up our minds to spending the night, or whatever time might be required, in finding a passage across this barrier; and after five hours' weary struggle we at last managed to scramble across where the main crack split up into smaller ones. This was hard work for our ponies, languishing with thirst and with hardly anything to eat; and perhaps only a degree less arduous for us, who in the matter of food and drink were no better off. Having crossed this serious barrier, we came upon a much more even tract of lava, and presently, to our intense relief, struck a pool of water under a snowdrift in a dent in the lava, where, having watered our horses, we treated them to the last scanty remainder of their fodder, and then went on our way. In the early morning we reached the valley called Heilagsdalir in Bláfjöll, where we were obliged to pitch our tent in order to give the exhausted animals the benefit of the scanty pasture which a few plots of grass offered. After a few hours' welcome sleep we broke up hastily, a gale of wind with rain and sand-drift having burst upon us in the meanwhile. Our course now lay across the spurs radiating to the eastward from Bláfjöll, but such was the violence of the hurricane that it was well nigh impossible to sit on horseback without being blown away, and equally difficult to guard against the despairing animals being blown out of our hands into the howling wilderness. After some really considerable trouble and hardship, we managed to scramble down a precipitous gorge into the upland plateau on which the Lake of Mývatn has found its bed. After having more than once lost our bearings on these lower lava wilds, we succeeded at last in striking the homestead of Grænavatn, exhausted with our exertions, and were glad of a grateful rest in good beds, after having spent a fortnight in a tent, with our saddles for pillows.

TH. THORODDSEN

Reykjahlíð, near Mývatn, August 4

### STORAGE BATTERIES

THE importance and desirability of an efficient and economical storage battery have been very widely recognised, but it is at the present time pretty generally felt that no existing form of storage battery is perfect, and that they are on the whole extravagant and wasteful to an extent sufficient to more than compensate for their undeniable convenience. It is perfectly certain that their employment has not become at all general, and that they have failed to realise the somewhat sanguine hopes of their early promoters.

It seems worth while to examine into the causes of this partial failure, and to inquire how far the evil opinion held by many practical men concerning our present method of storing electrical energy is justifiable.

One of the main objections is that storage involves a loss of some 50 per cent. of the whole. Now all methods of storing and transmitting energy involve some loss. To say that any particular method involves a loss of 50 or even 90 per cent. is not to condemn it utterly. There are many cases when the convenience of storage outweighs the evil of waste altogether; three principal ones may be specified.

(1) When the power of the source would be otherwise so completely wasted that every fraction of it stored is clear gain. This is the case of much terrestrial water power. The energy of the tides or of Niagara is enormous, and wholly wasted so far as human activity is con-

cerned ; if 50 or even 10 per cent. could be stored in such a way as to be conveniently available, it would be of considerable value, and any arrangement capable of effecting this storage could only with injustice be stigmatised as wasteful. The solar energy of the Carboniferous epoch has most of it been wasted ; but a small fraction—probably not a millionth per cent.—has been saved and stored in the Coal-measures. It is possible to abuse the coal for not having stored more, but we find it a useful modicum nevertheless.

(2) A second case when the advantage of storage overbalances the loss is when regularity and continuity of supply is needed, and when the source is irregular and fitful. Wind and wave power illustrate this kind of source ; it is manifest that wind power has not been so largely used as it would have been, had it been steady and dependable. A practicable method of storing up its energy and giving it out as wanted would gradually cause it to be very largely employed. This case is also illustrated faintly by a gas-engine or jerky motor of any kind, and the regularity and dependableness of a storage cistern may very well make it desirable to put up with some waste provided it be not excessive. Mechanical devices for approximating to regularity, such as the use of slack driving belts, undoubtedly give rise to a waste of power, and so does any form of regulator. But in the utilisation of artificial forms of power like this, questions of economy become almost pre-eminent ; and wastefulness is here a most serious objection, and, it may be, prohibitive defect. At the same time, if the engine is liable to stop, or if it is not always working, some mode of storing energy may be absolutely necessary, whether wasteful or not.

(3) Another case, and to some extent the converse of the last, is when the available source is weak, though continuous, while the power is only needed for a short time, but during that time is required to be great. This is exemplified in the operation of pile-driving, where energy is stored in the slowly-raised weight to be suddenly expended on the head of the pile, also in the operation of drawing a bow ; or again when a small waterfall or steam-engine, running continuously, is to be utilised for lighting during five or six hours each day : the obviously right plan in such circumstances as these is to store the energy during the hours it is not wanted, and thus virtually to double or treble the power of the source while it is actually in use. Unless, however, the loss occasioned by storage were reasonably small, there would be but small gain in attempting the process in this third case.

It is plainly advantageous to devise a method of storing that shall give out the greater part of what is put in ; but we see by these examples that a reasonable loss may be more than compensated by convenience, regularity, availability, and dependableness. Again, when energy has to be transmitted over great distances, it is in practice difficult or impossible to make the expenditure of energy at one end depend upon and be regulated by its consumption at the other ; and so, without some system of storage, great waste will ensue during intervals of small consumption. Looking to the immense development which the transmission of energy may be expected to undergo in the course of the next few decades, a convenient and manageable method of receiving large quantities of transmitted energy, and of holding it in readiness until wanted, must be of prime importance.

It was in view of such applications as these that the invention of the storage battery by Faure was hailed with enthusiasm by the highest scientific authority in Great Britain ; while the public, jumping to the conclusion that a thing for which so many uses could be instantly found must needs be a profitable investment, hastened to provide money, not for commencing careful experiments and perfecting the arrangement, which would have been wise, but for manufacturing tons of apparatus in its first crude, immature, and untried form. Some day it may perhaps be

recognised that because it can be shown that a thing will be extremely useful when perfect it does not follow that it has already attained that perfection, that indeed probabilities based on historical developments are enormously against such abnormal and instantaneous maturity, and that the careful nursing and rearing necessary to healthy maturity are better given in the seclusion of laboratory and study than in the excited and heated atmosphere of the Stock Exchange. It is doubtless recognised already that all preliminary operations are better conducted on a scale smaller than the wholesale manufacturing one. In developing a new industry there are scientific difficulties to be overcome, and there are manufacturing difficulties. By scientific difficulties we mean such as the determination of weak points, the best ways of strengthening them, and generally the discovery of theoretically the best modes of effecting the object in view ; manufacturing difficulties begin with questions of expediency and economy—how most cheaply and satisfactorily to carry out the indications of theory, to obtain this or that material—and include the organisation of a system of manufacture, of division of labour, of machine tools, which shall enable the work to be done with economy, security, and despatch. Over-haste in the preliminary stages causes both these sets of difficulties to be tackled together, and so throws a grievous burden on both adviser and manager. All these untoward conditions have storage batteries experienced ; and to say they have not fulfilled the hopes of their early promoters is no more than to say that those hopes were untimely and unreasonable. The period of maturity has been undoubtedly delayed by injudicious treatment, but its ultimate attainment seems to us inevitable ; and it is at present a matter of opinion how nearly it has already been reached : certainly great steps towards it have been made. Let us inquire what some of the difficulties encountered have been, and it will be seen that, formidable as some of them are, they belong essentially to an infantile stage, and are not suggestive of constitutional debility.

The first form of manufacture consisted in rolling up sheets of lead and composition, with trousering to keep them separate. The difficulties found were that the coatings would not adhere, but became detached in large flakes ; that the trousering got corroded through and permitted short circuiting ; and that free circulation of fluid being impossible, the acid became exhausted in some places and concentrated at others, and thus every sort of irregularity began. Now regularity or uniformity is of the most vital and fundamental importance in any form of battery. If any part of a plate is inactive, that part is better away ; if any plate in a cell is inactive, it is better away ; and if any cells of a battery are inactive, they are infinitely better away. The rolling or coiling up of the sheets being found awkward in practice and liable to detach the coatings, flat plates came to be used, then perforated plates, and then cast grids ; these last having such large hole space that they held enough composition, and held it securely enough, to enable the trousering or intermediate porous material to be dispensed with. This was an evident step in advance : free circulation of the liquid became possible, and could be assisted by stirring ; there was nothing to corrode except the plates themselves, and the composition, being in the cells or holes of the grid, might be reasonably expected to adhere. So far expectation was not altogether belied. The adhesion was not perfect, it was true, and pieces of composition sometimes fell out of the holes, especially if too powerful currents were passed through the cell, but still it was much better than it had been ; and if the plates were well filled, properly formed, and fairly treated, the composition adhered extremely well and securely. The circulation of the liquid was not automatically perfect either, but mechanical agitation could be readily applied ; without it the acid near the bottom of the cells tended to become more concentrated than that near the top, not by reason of gravitation

undoing diffusion, which is impossible, but because during each charging fresh acid is formed, and in great part falls to the bottom in visible streams. Another great advantage was that some amount of inspection of the plates became possible, and experience as to the actual behaviour and appearance of the plates, began to be accumulated. And painfully varied that experience was. Every variety of extraordinary behaviour which could be suggested as probable, and a good many which no one could possibly have imagined beforehand, made their appearance. The hundreds of tons of batteries made at this period doubtless enabled these unpleasant experiences to be more rapidly acquired than would have been done on a small scale, but it was a costly series of experiments. However, the experiments were made, the public involuntarily assisted in the acquisition of experience, and, caring less for knowledge than for marketable commodities, they expressed dissatisfaction at the result. Many of these incipient difficulties are now overcome by the manufacturers, but the great dislike of the public to involuntary experiments, and the shock which their confidence underwent on being unexpectedly called upon to participate in research, have not yet altogether abated.

The main difficulty now experienced was how to keep the plates from touching. They might be put in wooden frames, or elastic bands might be stretched round each of them, and if they would only keep flat it was impossible they should touch unless the composition should drop out of the holes. Sometimes the composition did drop out of a hole, and bridge across the interval between two plates, but the more common and more fatal experience was that the plates would not keep straight. In a few months the positives were found to swell, and as they swelled to buckle—to buckle and twist into every variety of form, so that elastic bands, wooden frames, and every other contrivance failed altogether to prevent short-circuiting. The cause of the buckling is of course irregular and one-sided swelling, and the cause of the swelling is apparently the gradual peroxidation and sulphating of the material of the bars of the lead grid, which occupy less room as metallic lead than as oxide or salt. As the bars swell, they press on the inclosed composition, occasionally driving it out, but more frequently, and with properly made and treated plates universally, distending themselves and stretching the whole medial portion of the plate. The edge or frame of the grid is stronger than the middle bars, and is not so easily stretched; in a good and uniformly worked plate it does stretch, and an old positive plate is some quarter of an inch bigger every way than a new one, but if one face of the plate is a trifle more active than the other, it is very plain that the most active side will tend to become convex; and buckling once begun very easily goes on. To cure it two opposite plans have been tried: one is to leave the plates as free and unconstrained as possible, hanging free it may be from two points, thin, and with crinkled or crimped margins to allow for expansion; the other is to make them thick and strong, with plentiful ribs for stiffness, and besides to clamp them up one to another as tightly as may be, and thus in mechanical ways to resist buckling and distortion. I do not know that any one could say for certain beforehand which of these two plans would be likely to answer best, but practice is beginning to reply in favour of the latter, and well braced plates of fair thickness show no unmanageable tendency to buckle. It must be remembered that no material can buckle with a force greater than that necessary to restore it to flatness, and this force in the case of lead is very moderate. Hence it may be fairly hoped to overcome and restrain all exuberances by suitable clamps and guides arranged so as to permit flat and even growth, but to check all lateral warpings and excrescences.

Uniformity of action is still essential, especially if all the plates in a cell are clamped together. Plates mechani-

cally treated alike ought to be electrically so treated also, and it is impossible to keep a set of plates working satisfactorily together unless the contact of each is thoroughly and equally good, so that each may receive its fair share of current. Defects of contact have been a fruitful source of breakdown and irregularity. Clamps and screws of every variety have been tried, but the insidious corroding action of nascent oxygen exerted through the film of acid which by spray and creeping forms and concentrates on the lugs—this corroding action crawls between the clamped surfaces, gradually destroys all perfect contact, and sometimes produces almost complete insulation. Contacts on the negative plates give but little trouble; contacts on the positives have taxed a great amount of patience. Lead contacts “burned,” *i.e.* melted, not soldered on, are evidently less liable to corrosion than brass or copper fittings, or than any form of clamp, but they are apt to be somewhat clumsy if of sufficient conductivity, and moreover they are awkward to undo again, and somewhat troublesome to do. However they have proved themselves so decidedly the best that now no other contacts will be used, and their re-introduction has been followed by a marked improvement in the behaviour of the cells. So long as contact with one plate was better than with another, a thing quite possible to happen without any difference being perceptible to the eye, so long was it possible for one or two plates to remain almost wholly inactive while another one or two received far more than their share of current, and became distended, warped, overcharged, and ultimately crumbled away. If one or two plates in a cell are black, and giving off torrents of gas, while the rest are brown and idle-looking, it is pretty fair evidence of irregular and insufficient contact, or else of some great discrepancy in the age or make of the plates. This point also is one that was not attended to in the early stages of manufacture; plates were made for stock, and cells were made up with plates of all ages selected at random from the store. Directly uniformity is perceived to be essential, this is recognised as obviously bad. Plates intended to work together should be of the same age and make, and inasmuch as keeping does not improve them, the best plan is not to make for stock, but to keep material ready, and then quickly make up as wanted. Plates in work deteriorate slowly, but they are wearing out in the fulfilment of their proper function; plates in idleness deteriorate as quickly, and they are rusting out in fulfilment of no function at all. Worn-out plates, however, are by no means valueless. Lead material has a well recognised price, and if attention were given to the subject, it is probable that decrepit and useless plates might be made to yield a very large percentage, if not the whole, of their original lead. For it must be remembered that plates deteriorate not by waste but by accretion: an old plate contains as much lead as a new one, but it contains it with the addition of oxygen and sulphur; no longer a tenacious coherent frame, but a crumbling mass of incoherent powder.

The age of plates is a point of vital interest, though but little is known as to the possibilities in this direction at present. A year may be regarded as a fair average age at the present time; but this is a low rather than a high estimate. Thick plates are found to last far longer than thin, which is only natural when it is remembered that the wearing out is due to corrosion, that corrosion proceeds mainly from the surface inwards, and that the internal portions of a thick plate are to a great extent protected by the mass of superincumbent material. If it can be shown, as we understand it can, (1) that the cost of materials is far more than the cost of manufacture; (2) that the worn-out material has a market value not incomparably less than the original; and (3) that the frequency with which plates have to be renewed is not such as to cause much inconvenience; then we hold that the first stage of the durability difficulty has been over-

come. Much more may be hoped for in this direction as experience increases, and it is not extravagant to hope that a well-ribbed, properly-clamped, and fairly-treated thick plate may last as long as five years before it becomes disintegrated.

It is evident, however, that in a region where pure experiment is pre-eminent, and where the units of time are months and years, instead of hours and days, the accumulation of experience is a slow and tedious process. It is no use making statements involving periods of five years when no one has had the present improved form in use for so much as six months. Nevertheless it is possible to see that the present cells are better than their predecessors; and as their predecessors have lasted in good condition for a year and more it is not presumptuous to indulge in well-founded hopes. Many of the difficulties connected with the early forms of battery were aggravated by Utopian notions concerning internal resistance and compactness. The internal resistance of a cell was so beautifully small, that the manufacturers were tempted to diminish it still further by putting the plates far too close together. An eighth or tenth of an inch interval is well enough if the plates had been hard rigid slabs of perfect flatness; but it was madness to pack flexible lead plates full of composition certain to swell and liable to drop out so near together as this. Security and dependableness were sacrificed to a natural desire for sudden and Utopian perfection. We may hope that these lessons have been profited by, and that the manufacturers perceive that confidence and security are the first conditions of success, and that minutiae as to the number of noughts before the significant figures in the specification of resistance begin, though those also are of importance in their turn, are yet of quite secondary consideration. Moreover, this packing of the plates so closely did not really do much to secure the result desired; the greater part of the resistance of half run-down cells is not in the liquid between the plates, but in the surface or scum separating each plate, and especially each negative plate, from the liquid, and hence putting the plates a safe distance, say a quarter or one-third of an inch, apart exerts an effect on the total resistance which is certainly far more than compensated by the ready opportunity thus afforded for access by both sight and touch. The old opaque boxes chock full of plates, with slight india-rubber bands between them, were started and left to Providence. No one could see what went on, nor could one readily get at anything to rectify what was wrong. In the present glass boxes properly arranged on accessible shelves with only plugs or studs between the plates, clear vision through the cell in any direction is easy, and accidental obstruction not only very seldom occurs but if it does it can without difficulty be seen and removed. But it must be granted that these boxes are less compact than their predecessors, and for some purposes, such as locomotion, compactness is of the first importance. Most true, for some purposes. It is not to be supposed that one type of cell will answer every possible demand. A dynamo to be highly efficient must have a large and massive field magnet, but in some places bulk and weight are fatal objections, and in these places smaller and more compact dynamos may be more suitable; something, however, must be given up to secure the required lightness and compactness, some sort of compromise must be effected. Just so with cells: we can point out what is theoretically the best form, and this form may, for large stationary electric light or power installation, be actually the most suitable; but we may also see that for boats, for tramcars, and for fish torpedoes, some very different and far more compact form may be quite essential.

Efficiency, Durability, Economy, Compactness: it may not be possible to attain all these at once—if it were, there would be small room for discussion—but sometimes one and sometimes another will be the pressing necessity, and

manufacturers of storage batteries, like manufacturers of dynamos, must be prepared with forms suited to various needs.

We have spoken mainly of difficulties connected with the positive plates, and have said nothing concerning the negatives. It is not that these are not susceptible of improvement, but their faults have been of a less imperious and obtrusive nature. They are not perfect, but they do fairly well, and there has been little need to worry much about them, until the extraordinary behaviour of positives had been taken in hand and checked. The time is coming to attend to these also. They fail not from exuberance, but from inertness. As they grow old, they do not swell, and warp, and burst, and crumble, like the positives, but they grow quietly hoary, and serenely decay. The composition in a worn-out negative consists of white sulphate through and through, but the frame remains intact, and it consequently never falls to pieces, nor does it swell. Impurities in the acid used tell upon a negative plate—nitric acid is fatal. Acid much too weak or very much too strong is also deleterious, and idleness is bad. The difficulties connected with negatives mostly depend on their aggravating property of always requiring a quite opposite treatment to positives. The less a positive is formed and overcharged the better. A negative delights in complete formation and frequent overcharge. In recognition of this it is now customary to form them separately, and to give the negative a thorough dose of hydrogen without commencing the corrosion of the positive by an overdose of oxygen. When the discharge from a cell begins to flag, it is the resisting scum of sulphate that has formed over the negative plate which is responsible for the flagging. The true E.M.F. of a cell is wonderfully constant throughout the whole discharge; but the internal resistance is all the time increasing, at first very slowly, ultimately, towards the end, with a rush. One such run-down cell in the midst of a lot of others therefore obstructs the current terribly. If only a series of cells could with certainty be made to work together uniformly, if a series could behave as well as some of the cells in it, no one would have cause to complain.

Through the whole history of the manufacture, from the very beginning, a few cells here and there have always exhibited astonishing efficiency;—the aim of manufacturers may be said to be to bring all cells up to the level of a few. Much progress in this direction has been made, and it may be very fairly expected that, as uniformity is gradually attained, a series of cells subjected to the same treatment may behave in the same manner. Whenever this is certainly accomplished, there will have been reached a high stage of efficiency, beyond which further progress need be only in the improvement of comparably insignificant minutiae.

The subject of the electrical storage of energy is really one of national importance;—it is comparatively a small matter whether this or that form of storage, or this or that company of manufacturers, succeeds in bringing out the permanent form. It sometimes unfortunately happens that enterprising pioneers only clear the way, and retire just in time for other men to come in and reap the fruits of their labours. So much capital and so much labour have been already expended in the effort to bring storage batteries to perfection, so great progress has been made, and so apparently small are the steps which yet remain to be accomplished, that we may surely fairly hope that some of the original believers in their great, and as it seems to us inevitable, future may yet live to see their faith justified and their patience rewarded, and may even taste some of that so-called "substantial" reward without the hope of which great commercial enterprises would never be undertaken, and modern civilisation would have scarcely yet begun.

O. J. L.

### METEOROLOGY OF THE LOWER CONGO<sup>1</sup>

IN this work Dr. Danckelman has made a valuable contribution to the meteorology of Africa. The observations, which are printed *in extenso*, were made at Vivi, lat. 5° 35' S., long. 13° 52' E., at a height of 374 feet, from May 1882 to August 1883. The hours of observation were 7 a.m., 2 p.m., and 9 p.m., and to these were added for the six months ending May 1883 observations at 6 a.m. and 8 a.m., which thus furnish important data regarding the march of diurnal phenomena for the first three hours after sunrise. The full details which are given of the instruments employed, their exposure, and the methods of observing are particularly satisfactory. While the instrumental observations are very complete, no less care has been taken to make the non-instrumental observations of weather equally complete, and these have been planned and carried out to aid in discussions affecting both local and general meteorology.

In resuming and discussing these sixteen months' observations, Dr. Danckelman has conjoined with the results obtained for Vivi the results of observations made at St. Thomas, Gaboon, Chinchoxo, Loanda, and Melange, these places roughly representing the west of Africa from near the equator to about lat. 10° S. At all these places the annual minimum pressure occurs in February or March and the maximum in July, with a small secondary maximum in January. At Vivi atmospheric pressure at 32° and sea-level is 29.932 inches in February, 30.117 inches in July, and 29.997 inches for the year.

At Vivi the mean annual temperature is 76°.4, the lowest monthly mean being 70°.5 in August, and the highest 79°.5 in February. The highest observed temperature was 97°.2 on November 5, 1882, and the lowest 53°.8 on July 29 of the same year. A noteworthy feature of the climate of Vivi is the relatively low temperature from June to September; during the other eight months the means vary only from 77°.4 to 79°.5. This feature is common to the whole of this region of West Africa; and it corresponds to the dry season of the year, which, as regards the Lower Congo, is characterised by Dr. Danckelman as undoubtedly the most agreeable and the finest, as well as the healthiest, season of the year. On the other hand, on the elevated plateaux of the interior, the heat is very great during the day, and many maladies prevail among the natives, numbers of the ill-clad blacks succumbing to the diseases caused by exposure to the low temperature of the nights. The temperature of the Congo was observed at intervals during the year, the observations being made at a part of the river where the current was rapid. The results give a mean annual temperature of 81°.8, being thus 5°.4 higher than that of the air.

Of the winds observed at Vivi the percentages are south-west, 39; west, 15; west-south-west, 9; north, 8; and calms, 18; winds from any other direction being of rare occurrence. Thus of the 82 per cent. of wind-directions observed, 63 per cent were from the south-west quadrant. During the whole year south-west winds predominate in the afternoon, but during the dry season the wind frequently veers to west towards evening, so that at 9 p.m. west and west-south-west winds are more frequent than south-west, whilst south and south-south-west winds very rarely occur. This striking predominance of south-westerly winds has important bearings on the climatology of the whole of the Lower Congo as respects humidity, cloud, and rainfall. A striking peculiarity of the climate are the strong winds which often set in late in the afternoon and evening, and which are carefully recorded in the journal of the observations. The following are the number of times such winds have occurred each hour from 3 p.m. to 11 p.m.—6, 11, 24, 28, 30, 32, 22, and 4,

<sup>1</sup> "Mémoire sur les Observations Météorologiques faites à Vivi (Congo Inférieure), et sur la Climatologie de la Côte sud-ouest d'Afrique en général." Par Dr. A. von Danckelman. (Berlin, 1884.)

the hours of greatest frequency thus being from 5 p.m. to 10 p.m. During the other hours of the day they seldom occur. The degree to which this prevails is seen from the fact that the mean force of the wind is greater at 9 p.m. than at 2 p.m., the latter hour being the time about which the wind generally attains its maximum diurnal velocity over the land.

Thunderstorms are of frequent occurrence from November to May, but none were recorded from June to October. As regards their distribution during the day, scarcely any occurred from 11 p.m. to noon, the period of maximum frequency being from 1 p.m. to 8 p.m.; but particularly from 4 p.m. to 6 p.m., 29 per cent. of the whole having occurred during these two hours. During the rainy season heat lightning is of frequent occurrence in the south, east, and north horizon, but rarely in the west. When the wind shifts from the ordinary south-west direction into east, the change is almost invariably followed by a thunderstorm, or by thundery-looking clouds, which indicate a thunderstorm not far off. Thunderstorms most frequently advance from the east. During the sixteen months the number of storms which advanced from an easterly direction was fifty-three, whereas only fourteen came from a westerly direction. The severest thunderstorms come from the north-east. They are intimately connected with the rainfall, which being wholly dependent on the thunderstorm, the diurnal periods of the two phenomena are the same. The rainiest months at Vivi were November, 11.34 inches; December, 8.94 inches; April, 9.10 inches; and March, 5.67 inches. The annual amount was 42.56 inches. No rain fell from June to September, and the fall in October was very small. During the dry season, however, when no rain falls, the hygrometer not unfrequently indicates an atmosphere highly charged with vapour, and occasionally a light drizzle sets in which the Portuguese call "Cacimbo," but the amount falling is too small to be measurable. These results show, in an unmistakable manner, the powerful and beneficial influence of the prevailing south-westerly winds from the Atlantic on the climate of this extensive region in the continent of Africa.

### THE RECENT ECLIPSE OF THE MOON

WE have received the following communications with reference to the recent lunar eclipse:—

THE total eclipse of the moon on Saturday, October 4 was of particular importance as it was—since the one in 1877, which was practically lost through bad weather—the first opportunity of measuring the changes which the heat radiated by the moon undergoes with the proceeding eclipse. And indeed on Saturday evening at six o'clock it appeared highly probable that the fate of this eclipse would be the same as that of its predecessor, the sky being thickly covered with misty clouds, with hardly a motion whatever. Suddenly, however, as if by magic thirty-two minutes before the beginning of the total phase they all disappeared, and left a most perfect and exceptional clearness behind them, which not only lasted during the remainder of the eclipse, but also through the two following days and nights. Thus I was enabled to carry out the greater part of my programme in every detail. The apparatus used was the same which the Earl of Ross described in his communications to the Royal Society in 1869, 1870, and 1873; it condenses by means of two small concave mirrors alternately on two thermopiles the rays of the moon collected by the 3-foot telescope, and the currents thus created are measured by the aid of galvanometer with mirror and scale. The time of exposure was 1 min. sid. time for each pile, and the observations were throughout the eclipse carried on with only two interruptions of eight and nine minutes, the former caused by my examining the condensing mirrors for dew, the

latter by the re-winding of the driving-clock of the telescope. Thus I took altogether 211 readings of the galvanometer, which were taken together in groups of ten for the formation of reliable mean values. It is these means—without the application of the still necessary reductions—which form the ordinates of the preliminary curve inclosed, the abscissæ of which are the times before the beginning and after the end of the total phase. It will be seen that no observations were made during the total phase, as I could not make certain that the moon's image was actually on the condensing mirrors; besides the readings of the galvanometer on near approach to the total phase became so unsteady and irregular that it was plain that the effect, if any, fell below the sensitive-

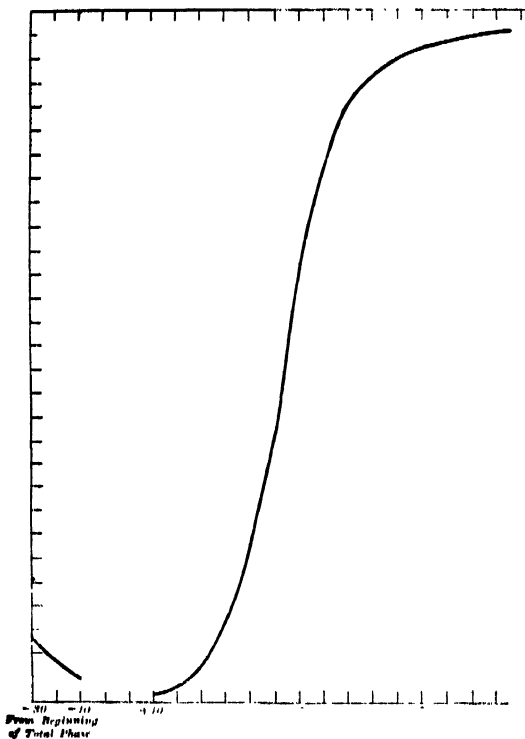

Curve showing the change of the lunar radiant heat as measured by thermopile and galvanometer during the total eclipse of the moon on October 4, 1884, at Birr Castle Observatory, by Otto Boeddicker.

ness of the instrument and the unavoidable errors of observation. This is much to be regretted, as the few observations obtained before the total phase began show plainly that the minimum of the radiated heat takes place later than that of the moon's light. Indeed, so slowly did the readings of the galvanometer increase again that about twenty minutes after the total phase was over the almost entire absence of any effect led me to think that the small condensing mirrors must be covered with dew, an apprehension which was happily not verified. I should add that the galvanometer readings here given are not comparable with those published in 1873.

OTTO BOEDDICKER

The Earl of Rosse's Observatory, Birr Castle,  
Parsonstown

THIS eclipse was seen from here (height above sea 530 feet) to great advantage in a cloudless sky, with the stars very brilliant and the air calm.

For some minutes before the actual contact a faint smoky look was visible, and this had the effect of flattening the edge of the moon on the side towards which the

shadow was approaching. At 8h. 16m. there was a slight but very perceptible shadow, about a fourth of the moon's diameter in advance of the dark shadow, and in four minutes later the eclipse just entered the moon. At 8h. 44m. the margin of the dark shadow, which had had all along an edge of a woolly and irregular appearance, had now decided streaks in advance of it. The edge of the moon on the opposite side from the base to within 30° of the apex was marked by a rim of intense bright blue. Ten minutes later the blue margin was less brilliant and narrower, and the woolly appearance before mentioned was more decided, but less streaky. At 8h. 58m. the blue had contracted in length both at the base and apex, and gradually assumed a greenish shade. The cusps of the moon were elongated and more drop-like than continuous. At 9h. 18m. the shadow had almost covered the moon, which showed a faint glow beneath, though the circular appearance was not visible to the naked eye. A minute later, as the last point of light disappeared, a dense blackness of irregular form appeared on the opposite portion of the moon, extending over nearly a third of the surface. At 9h. 39m. the moon was scarcely perceptible to the naked eye. Through the telescope a faint luminosity at the apex could be discerned. At 9h. 47m. to the naked eye the moon seemed like a blurred star, very indistinct and considerably reduced in apparent size, and of no definite form. At 10h. 2m. the faint luminosity at the apex had almost gone, and the outline of the moon was more apparent through the telescope. The blurred, star-like appearance to the naked eye was still unchanged. At 10h. 9m. there was a thin luminosity on both horizontal sides of the moon. The apex of the moon was very indistinct. At 10h. 20m. a broader belt of light appeared on the northern side, but that on the opposite side was indistinct. There was still the same indistinctness to the naked eye, though every now and then a faint crescent-like appearance could be seen. At 10h. 38m. a somewhat broader crescent. At 10h. 43m. a bright light like that of the moon was visible to the naked eye at the apex, and four minutes later the moon reappeared. At 10h. 57m. the tip of a mountain was lit up near the moon's apex. At 11 p.m. the upper cusp extended further than the lower one. At 11h. 15m. a slight haze formed a burr about the moon, which was somewhat kidney-shaped. At 11h. 22m. the burr still visible, but much rounder in form. The eclipse ended at 11h. 45m.

Having previously observed a number of lunar eclipses, I was specially struck with that of to-night; the density and blackness of the shadow was far greater than any previous one that I had seen, especially throughout the period of totality. In all previous eclipses I have been able to trace the outline; in the present case this was quite impossible. Usually the outline is more or less plainly seen, and not unfrequently there is a strong reddish light. The last total eclipse of the moon was seen from this place, and it had a copper-coloured appearance, and there was no difficulty in tracing the outline. In the present eclipse the moon's outline was invisible for some time to the unaided eye, and the apparent size so much diminished that it had more the appearance of a large star whose light was just able to pierce through a dense haze. Some of the valleys of the moon were left for a time in great darkness after the light had travelled beyond them. I may mention that all the above appearances were also seen by Major A. E. L. Lowe and Mr. H. L. Lowe, who were using other telescopes. E. J. LOWE

Shirenewton Hall, near Chepstow, October 4

IT is to be hoped that the unusual phenomena attending the late eclipse of the moon may lead to a discussion which will throw some light upon the great differences observed on different occasions in the visibility of the eclipsed moon—differences which have not hitherto, so far as I know, been adequately explained.

In the late eclipse, as viewed from this station (where the sky was not only perfectly cloudless, but free from the least suspicion of haze), the obscuration of the moon was carried to a degree far beyond anything witnessed in the eclipses of recent times. For some time before and after the middle of the eclipse (that is, about 10 p.m.) the only trace of our satellite that remained in the sky was a faint dingy-brown nebulous spot, to which it was impossible to assign any definite form or dimensions, but which certainly did not approach the moon in point of apparent size. So inconspicuous was it that it was quite invisible through the window of a room in which lights were burning; and in the open air, if one had not known exactly where to look for it, one might have searched for some little time without discovering it. I speak of course of the naked-eye appearances. With an opera-glass the nebulous spot was resolved into a well-defined disk of the proper dimensions, but still very faint and dingy, the hue being a kind of reddish-brown. It was further remarked that the illumination was uniformly distributed over the disk, at least so far as this, that there was no preponderance of light in the direction of any one part of the moon's edge. This is what should naturally have followed from the central character of the eclipse, but it seems desirable to note the circumstance with reference to a theory presently to be mentioned.

The most obvious explanation of the unusual obscurity of the moon would be its unusually deep immersion in the earth's shadow, but this view seems to be clearly disproved by a comparison with the phenomena observed in a former eclipse. Referring to a note which I made at the time of the eclipse of August 23, 1877, I find the following remark:—"The moon, even in the middle of the total phase, was a conspicuous object in the sky, and the ruddy colour was well marked. In the very middle of the eclipse the degree of illumination was as nearly as possible equal all round the edge of the moon, the central parts being darker than those near the edge." Now the duration of totality in that eclipse was 1h. 44m. In the late eclipse it was 1h. 32m. The immersion of the moon in the earth's shadow must therefore, I presume, have been at least as deep on the former occasion as on the recent one. It may be mentioned as an additional argument against this explanation that in the late eclipse the visibility of the eclipsed portion was observed to be much less than usual even before the eclipse was complete. In fact it was not until within a few minutes of the total phase that the eclipsed portion could be certainly distinguished with the naked eye.

Another obvious suggestion in the way of explanation has reference to variations in the condition of that portion of the earth's atmosphere through which the sun's rays would pass to reach the moon. This explanation is not without interest in connection with the remarkable sunset effects of last winter, and, in a less degree, of the present autumn. But there are serious difficulties in the way of accepting it, for, in order to account for the observed phenomena, it would be necessary to suppose that an entire ring of the earth's atmosphere was uniformly affected. A want of uniformity in this respect would not cause merely an uneven illumination of the moon's disk, which some observers seem to have noted, and which may very well be set down to the actual differences on the surface of the moon; the effect would be specially marked upon some part of the moon's edge, and would be similar to what is observed soon after totality has commenced and shortly before it ends. Nothing approaching to this appearance was to be seen in the late eclipse at the time when the obscuration was greatest.

Is it possible that the surface of the moon may be in some small degree self-luminous, and that a variation (from unknown causes) in the degree of this self-luminosity may account for the difference observed in the

visibility of the moon in two eclipses, in both of which the solar light was equally at its minimum?

Clifton, October 7

GEORGE F. BURDER

ON the occasion of the total eclipse of the moon on Saturday, October 4, the Director of the Pulkowa Observatory, near St. Petersburg, issued a circular to a number of other observatories suggesting the use of the opportunity to fix the exact diameter of the moon, the mean value of the true diameter not being known to a second. Even as regards a probably existing depression of the surface of the moon, we know only that it cannot be very great. The circular also requested observers to watch attentively all stars, even those of the tenth magnitude, eclipsed by the moon, and their egress on the other side, which is only possible during a total eclipse. In order to make these observations exact, Prof. Döllen, of the Pulkowa Observatory, calculated the number of such stars covered by the moon on that date, which he finds were 116, most of which are of the ninth and tenth magnitude and only one of the sixth. He has, moreover, for the use of observers, calculated the exact position of these during the eclipse for no less than sixty observatories from Pulkowa to the Cape, which is expected to give the desired result.

#### NOTES

OUR readers will hear with sincere regret that Prof. Huxley, under the orders of his medical advisers, left England yesterday for some months of absolute rest. When it is remembered how many functions Prof. Huxley has to fulfil, we need hardly say that the cause of his enforced retirement for a time is overwork. His presence in England will certainly be missed during the coming winter, and he may feel assured that he carries with him the sympathies of many friends, known and unknown. Prof. Huxley goes in the first instance to Venice.

WE heartily support the suggestion which has been made in the *Gardener's Chronicle* that it would be most appropriate that some memorial of the late Mr. Bentham should, subject to the consent of the authorities, be placed in the Royal Herbarium at Kew, to which he was such a benefactor, and in connection with which his life-work was for very many years carried on. Official etiquette would probably preclude any steps being taken by the authorities at Kew in the matter; and, indeed, it is a subject that would more gracefully and appropriately be dealt with by outsiders.

SIR WILLIAM HARCOURT is always happy when he touches on science, either to point a political shaft, or, as on Tuesday at Derby, when descending directly on its progress and bearings. He showed himself well versed—as one bearing the honoured name of Harcourt ought to be—in the history of scientific progress, and in the high importance of science apart from its utilitarian uses. Scientific study, in his conception, is above all others "the most useful and the most ennobling." "Depend upon it," he concluded, "if I may turn for a moment to the utilitarian view, these are not days in which we, as a people, can afford to be idle or to be ignorant. There is an immense competition going on in the world in all departments of trade. Remember you have the competition of countries where education of this character is of a more complete character, far more complete than anything we have in this country. If you go into Germany you will find in every small town that there are institutions where the severest education is given in all departments of technical knowledge. The old days when people could afford to go on in an easy, happy-go-lucky sort of manner are gone by. You may depend upon it, in the race which we have to run in the world, a training of the severest description is requisite, so that we may hold our own." We trust Sir William will bear his admirable Derby



utterances in mind when as a legislator he has to consider the relation of science and of scientific workers to the Government and the country.

**PROF. HUGO GYLDÉN**, Director of the Observatory at Stockholm, and well known for his studies during recent years of the eight great planets, has been offered and has accepted the Professorship of Astronomy at the Göttingen University.

**HIS MAJESTY** the King of Italy has conferred the decoration of Knight of the Crown of Italy upon Deputy-Surgeon-General Francis Day, formerly Inspector-General of Fisheries in India, and lately Commissioner of the Indian Section in the great International Fisheries Exhibition.

**DR. SOPHUS TROMHOLT** having returned to Bergen after a lengthened sojourn in Iceland, whence we have from time to time received accounts of his researches, intends for the next few years to devote his time to the production of a great catalogue of all the auroræ seen in Northern Europe from the earliest times. The Norwegian Government have granted a not inconsiderable sum towards this gigantic undertaking. As this labour and the imminent production of his new work, "Under the Rays of the Aurora Borealis," will occupy all his time for some while, the distinguished *savant* announces his inability to issue for the coming winter such sheets for the recording of auroræ as he has for some years been in the habit of distributing over all parts of Northern Europe. He trusts, however, that observers may continue to note the phenomena as heretofore on the lines laid down by him, and forward the same to him with as little delay as possible. His address is Bergen.

**CHANDA SINGH**, a blind student of St. Stephen's College, Delhi, is, according to the account given in *Allen's Indian Mail*, a prodigy. He cannot read or write, but possesses such a strong memory as to be able to repeat all his text-books, English, Persian, or Urdu, by rote, and to work out sums in arithmetic with remarkable rapidity. The unusual intensity of his mental powers is shown by his ability to multiply any number of figures by another equally large. At the last University examination he was examined *visâ voce* by order of the Director of Public Instruction of the Punjab, and he stood twenty-seventh in the list of successful candidates. On the recommendation of the same official, the judges of the local court have allowed him to appear at its law examination. Memory, as is well known, is wonderfully developed in Orientals, owing to the system of education which has obtained amongst them; but cases like Chanda Singh must be very rare even in the East.

**DURING** the last week of September the Thüringo-Saxon Verein für Erdkunde held its annual meeting at Kösen under the presidency of Herr Dunker (Halle). Amongst a number of interesting papers read we note the following:—On Baku and its naphtha and petroleum wells, by Herr Eberius (Döllnitz); on the scientific and economical importance of Cameroon, by Prof. Kirchhoff; on the limits between the High and Low German on the eastern side of the Elbe, by Dr. Haushalter (Rudolstadt); on the salt and fresh-water lakes between Halle and Eisleben, by Prof. Kirchhoff; on ancient places of worship in Northern Thüringia, by Dr. Rackwitz (Nordhausen).

**THE** thirty-second annual meeting of the German Geological Society took place at Hanover in the last week of September under the presidency of Herr von der Decken. Among the papers read we note the following:—On the limits of the Dyas formation, by Prof. Geinitz (Dresden); on the geology of North-Western America, by Prof. vom Rath (Bonn); on the Brachiosaurus occurring in the Hessian limestone, by Prof. Credner (Leipzig); on the geology of the Harz Mountains, by Herr Langsdorff (Klausthal); on the occurrence of dolerite in the

Vogelsberg, by Prof. Streng (Giessen); on Tasmanian tin ores, by Herr Gordaek (Klausthal); on new Devonian Bryozoa, by Dr. Bornemann (Eisenach). The next place of meeting will be Darmstadt.

**WRITING** on a subject of some interest at the present time, viz. the orthography of the names of the better known Chinese places, a correspondent of the *Tablettes des deux Charentes* says that *Tonquin* is more correct than *Tonkin* (and we presume also than *Tungking*, *Tonking*, &c.), for this is how the name is pronounced. He thinks that French pronunciation generally approaches that of the Chinese more than the English. Thus the Chinese have the nasal sound of *n* and a sound of *u* which we in England do not possess. We cannot always reproduce these Chinese sounds, while the French can do so easily. To represent the nasal sound the English add a *g* to the *n*, but they do not always pronounce it. The French borrow the English orthography, but they pronounce the *g* which the former have added, and thus completely disfigure the names. Thus (the correspondent goes on) the French pronounce *Shanghai* instead of *Shanghai*, and *Hongue-Kongue* in place of *Hon-Kon*. The most curious instance is that of *Canton*. The English call the province *Kwang-tung*; all the French journals follow this orthography, and yet it is Canton pure and simple. If the *k* is to be employed at all it should be written *Ton-Kien*, for we write *Fo-Kien* as the name of the province in which Foochow is situated, and the *Kien* is the same in each instance. The truth appears to be that all Far Eastern names have been transliterated haphazard, and almost in every case by people who knew nothing of the native languages. The older orthographies, such as *Canton*, *Whampoa*, &c., we owe to masters of ships, supercargoes, and the like, who visited the place in the last or beginning of the present century. In some cases they are not good attempts at reproduction, but little practical inconvenience has ever been found in adhering to them. According to the writer whom we have quoted the French are in a worse plight than ourselves; our orthography was at least an honest attempt to reproduce the names as they sounded to Englishmen. The French adopt this orthography, and then give the letters their French pronunciation; in other words the transmutation is (1) Chinese as it sounded to an Englishman; (2) that Englishman's Chinese as it sounded to a Frenchman! Little wonder then that there are hopelessly irreconcilable methods of spelling Chinese names of places.

**THE** Japanese Commissioner to the Health Exhibition writes that the omission of the names of the foreign authors of certain scientific works in the Japanese Section was quite unintentional. He adds that three of these works are by Japanese assistant professors. The omission, on which we commented last week in noticing the Catalogue, coupled with the statement that the English volumes were translations, was certainly calculated to leave an erroneous impression as to the authorship of the works in question.

**THE** second document just issued (Brockhaus, Leipzig) in connection with the "Riebeck'sche Niger Expedition," is like the first, which dealt with the Fulah language, mainly philological. The chief contents are: "Specimens of the Language of Ghât in the Sahara, with Hausa and German Translations," by the learned leader of the expedition, Herr Gottlob Adolf Krause. The Ghât being merely a variety of the Mashagh (Berber, or Western Hamitic), no special grammar was needed of a language which has already been somewhat fully elucidated by Barth, Hanoteau, Prof. Newman, and Stanhope Freeman. But these texts in the Arabic and Roman characters with interlinear German translations, and free Hausa and German versions, will be accepted as a boon by students of the languages of Sudan and North Africa. The accompanying "Anmerkungen" throw

considerable light on many obscure grammatical points, besides bringing into still closer relationship the Semitic and Hamitic groups, whose fundamental affinity is daily becoming more and more obvious. The widespread relations of what Herr Krause calls the "Haussa-Musukanische Sprach-Stamm" (Haussa-Musgu linguistic family) are also elucidated, and the curious principle of vowel harmony prevalent in this group for the first time clearly explained. It differs entirely from the Bantu, which is initial, and also from the Finno-Tatar, inasmuch as in the latter the vowels of the agglutinated postfixes conform to that of the root, which is never modified, whereas in Haussa-Musgu the root-vowel conforms to that of the postfix, and is consequently subject to constant change. Thus: *a-dara* = he loves; *e-diri-kini* = he loves you, where the preceding pronominal and root-vowel *a* has been throughout modified to *e* and *i* by the influence of the following *i* of the pronominal suffix *kini*. The introduction contains many interesting details on the history of the Ghât oasis, which most of our readers will learn for the first time was incorporated in the Turkish Empire some ten years ago. Here also some fresh light is thrown on the origin of the national or imposed names Mashagh (Imoshagh), Tuarek, Berber, Moor, Tibu, Fezzan, and Ghât. For his munificence in undertaking the publication of these "Mittheilungen" without the remotest prospect of any pecuniary returns, Dr. Emil Riebeck has earned the lasting gratitude of the scientific world.

In the June number of *Timchri*, a journal steadily growing in scientific importance and general usefulness, the accomplished editor, Mr. E. F. Im Thurn, continues his valuable "Notes on West Indian Stone Implements." The title of these papers is now enlarged by the additional words, "and other Indian Relics," so as to include all objects, whether of stone, shell, bone, or clay, which are often found associated together in such a way as to render their separate treatment almost impossible. This enlargement of the subject cannot fail to be appreciated by ethnologists, who will here find much instructive matter lucidly arranged, and illustrated by eleven plates containing thirty-five fac-similes of stone and shell implements, and twenty-one of Carib pottery. The first group of objects belong to Sir Thomas Graham Briggs, of Barbados, who has placed his fine collection at the disposal of Mr. Im Thurn, at the same time generously providing the means for the due illustration of the series. The second group forms part of a quantity of native (Carib) pottery recently discovered on the Enmore Plantation, west coast of Demerara. The urgent necessity of encouraging collections of this sort before all have disappeared, like the natives themselves, before the advance of civilised man, is made evident by the statement that a large heap of shell implements lately found in the parish of St. James, Barbados, were carted away "to macadamise a road." Other attractive papers in this number are: "Bush-Notes of a Huntsman," by M. McTurk; "The Mountains of the West Indies," by T. P. Potter; and "Essequibo, Berbice, and Demerara under the Dutch" (continued), by the Editor.

THE following announcements are made by Mr. Edward Stanford:—"A Parliamentary County Atlas of England and Wales," containing maps of all the counties engraved on a uniform scale. This atlas includes as a distinctive feature a series of physical, statistical, and administrative maps of England and Wales and of London. The rainfall, barometric pressure, temperature of the air and of the seas around our coasts are shown for every month of the year; a river basin map, with an accompanying table giving the area of each river basin and the length of the chief water channel in each basin; an orographic map, indicating by colours the plains, hills, and mountains, with such other information of interest. A short description of each county accompanies the maps. "A Trigonometrical Survey of the Island of Cyprus," executed by command of His Excellency

Major-General Sir R. Biddulph, K.C.M.G., C.B., R.A., High Commissioner, under the direction of Major H. H. Kitchener (Captain R.E.), Director of Survey, assisted by Lieut. S. C. N. Grant, R.E. The map is drawn to a scale of one inch to one statute mile = 1 : 63,360, the scale of the Ordnance Survey of the United Kingdom; it has been engraved on fifteen copper plates, and will be printed on imperial sheets, forming, when bound, an atlas measuring 15 inches by 22 inches, or, when mounted together, one map measuring 12 feet 6 inches by 7 feet. "A School Map of British Colonies and Possessions," drawn on a uniform scale, and agreeing in style, size, and price with the other maps of Stanford's Series. Also a second and much enlarged edition of the "Geology of Weymouth, Portland, and the Coast of Dorset," with coloured geological map, section, and photographic frontispiece; "The Countries of the World," the fifth and concluding book of the Geographical Readers, by Charlotte M. Mason, containing Asia, Africa, America, and Australasia; the concluding volume of Stanford's "Compendium of Geography and Travel—Europe," by F. W. Rudler, F.G.S., and G. G. Chisholm, B.Sc., edited by Sir Andrew C. Ramsay, LL.D., F.R.S., with ethnological appendix by A. H. Keane, M.A.I., illustrated with fifteen maps and numerous cuts; "The Monuments of Athens: a Historical and Archaeological Description," by Pomagistes G. Kastromenos, translated from the Greek by Agnes Smith, author of "Glimpses of Greek Life and Scenery"; "The Visitor's Guide to Orvieto," by J. L. Bevir, M.A., Assistant Master at Wellington College.

E. AND F. N. SPON have in the press "Candles, Soap, and Glycerine," a practical treatise on the materials used and processes involved, by Mr. W. Jant Carpenter, B.Sc.; "A Text-Book of Tanning," embracing the theory and practice of preparing and dyeing all kinds of leather, by H. R. Procter, of Lowlights Tanneries, Examiner in Tanning to the Guilds Institute; "On Portable Railways," by Mr. Paul Deauville, M.I.M.E.; "History and Description of the Manchester Water-Works," by J. F. La Trobe Bateman, F.R.SS. Lond. & Edin., Past President of the Institution of Civil Engineers, F.G.S., &c.; "An Electrical Supplement to the Pocket-Book of Engineering Formulae," by G. L. Molesworth, M.I.C.E., M.I.M.E., Consulting Engineer to the Government of India for State Railways; "On the Analysis of Iron and Steel," by T. Bayley, author of "The Chemist's Pocket-Book"; a new edition of "The Modern Practice of Sinking and Boring Wells," by Mr. Ernest Spon, Assoc. Mem. Inst. C.E.; Spon's "Mechanics' Own Book," a manual for handicraftsmen and amateurs; "Sanitary Protection," a course of lectures delivered in the Theatre of the Royal Dublin Society, 1884, by W. Kaye Parry, M.A.

PHYLLOXERA is making steady progress in the Rhenish vineyards it seems. The pernicious insect has now been found on the right bank of the river, in the vineyards of Castle Ockenfels near Linz, where over 100 acres are infected. State aid has been asked for at Berlin, as the occurrence of the pest near Linz is far more serious than that in the Ahr Valley.

A TUNNEL, measuring about 5000 feet in length, and constructed at least nine centuries before the Christian era, has just been discovered by the Governor of the island of Samos. Herodotus mentions this tunnel, which served for providing the old seaport with drinking water. It is completely preserved, and contains water tubes of about 25 centimetres in diameter, each one provided with a lateral aperture for cleansing purposes. The tunnel is not quite straight, but bent in the middle; this is hardly to be wondered at, as the ancient engineers hardly possessed measuring instruments of such precision as those constructed nowadays.

THE *Globus* reports the discovery of the ruins of an ancient city near Samarkand. They are situated upon a hill, which was

doubtless a fortress formerly. Remains of utensils and human bones have also been found. According to Arabian sources the large city of Aphrosiab existed there in the time of Moses; it was the royal residence, and the king's castle stood on the hill, and was provided with subterranean corridors. The result of the excavations show that the ruins are indeed those of a very ancient city. The various depths, however, differ widely; in the lower ones fine glass objects are found, which are quite absent from the upper ones; the lowest layers contain remains of a very primitive nature, *i.e.* coarse implements of clay and flint. The excavations are being continued. News from Turkestan announces the discovery of another ancient city, Achsy, on the right bank of the Amu Darya. Remains of brick walls and other buildings are said to be visible in considerable numbers.

THE additions to the Zoological Society's Gardens during the past week include a Macaque Monkey (*Macacus cynomolgus* ♂) from India, presented by Mr. A. F. M. Smith; a Brown Capuchin (*Cebus fatuellus*) from Guiana, presented by Mr. G. S. Malet Barrow; a White-backed Piping Crow (*Gymnorhina leucolata*) from Australia, presented by Mr. F. Larkworthy; two Loggerhead Turtles (*Thalasseochelys caonana*) from the Mediterranean, presented by Mr. Allan McGregor; a Common Chameleon (*Chamaleon vulgaris*) from North Africa, presented by Mr. A. R. Rogers; a Horned Lizard (*Phrynosoma cornutum*) from Texas, presented by Capt. H. Mends; a Brown Mud Frog (*Pelobates fuscus*), European, presented by Mr. Claude Russell; a Sulphur-breasted Toucan (*Kamphastus carinatus*) from Mexico, a Macaque Monkey (*Macacus cynomolgus* ♂) from India, a Robben Island Snake (*Coronella phocarum*) from South Africa, deposited; a Collared Fruit Bat (*Cynonycteris collaris*), born in the Gardens.

OUR ASTRONOMICAL COLUMN

THE APPROACHING APPEARANCE OF ENCKE'S COMET.—It may be hoped that, as at the last return of this comet in 1881, an accurate ephemeris for its reappearance, which is now at hand, may be issued from the Imperial Observatory at Pulkowa. According to the mean motion, assigned by the calculations of Dr. Backlund at perihelion passage in 1881, the comet would be again in perihelion (perturbations neglected) about March 7.5 G.M.T., 1885, so that as the effect of planetary attraction will be small during the actual revolution, the comet's track in the heavens will not greatly differ from that it followed in 1852, when the perihelion passage occurred on March 14. It was first observed in that year by Dr. Vogel, at Mr. Bishop's Observatory in the Regent's Park on the evening of January 9, a refractor of 7 inches aperture being employed; at this time its distance from the sun was 1.35, and that from the earth 1.55, so that the intensity of light expressed in the usual manner was 0.23. At the return in 1875, when the perihelion passage took place on April 13, the comet was detected at the Observatory of Marseilles by M. Stephan, on the evening of January 27, distant from the sun 1.50, and from the earth 1.98, the theoretical intensity of light being therefore 0.113, or only half that at the comet's discovery in 1852. There appears to be a probability that with the large instruments now so comparatively common in observatories, the comet may be observed at a greater distance from the sun than in that year, and possibly during the absence of moonlight in November. If we assume March 7.5 for the date of perihelion passage, and bring up the longitudes in Dr. Backlund's orbit of 1881 to the beginning of 1885, we shall have the following positions of the comet at Greenwich midnight:—

1884	R.A.		N.P.D.		Distance from		Intensity of Light
	h.	m.	Earth	Sun	Earth	Sun	
Nov. 5	23	2'1	82	24	1'310	2'043	0.140
9	22	57.4	83	4	1'318	2'000	0.144
13	22	53.4	83	40	1'328	1'957	0.148
17	22	50.1	84	13	1'340	1'913	0.152
21	22	47.4	84	42	1'352	1'867	0.157
25	22	45.4	85	7	1'365	1'821	0.162

Encke did not continue the ephemeris in 1852 beyond the date of perihelion passage, but if we calculate from his elements for April 19.5 (the day of the new moon), we find the comet's place to have been in R.A. 342° 55', N.P.D. 109° 22', its distance from the sun 0.89, and from the earth 0.95, or the intensity of light 1.41; it would rise at the Cape about 14h. 1m., and must therefore have been readily observable. We may expect that in 1885 observations will be made in the southern hemisphere after perihelion passage.

VARIABLE STARS.—Mira Ceti is now close upon a minimum a phase of which there are not too many observations: its magnitude is usually about 8.5 on Bessel's scale.  $\chi$  Cygni will probably be at minimum about November 15: the mean of the last five periods, according to the observations of the late Prof. Julius Schmidt, is 408.2 days, and 1880 May 31.2 may be taken as a mean maximum epoch. A maximum of the fiery-looking variable R Leonis may be expected about December 10. R Leporis will probably be at minimum at the beginning of January.

SOUTHERN BINARIES.—There are two southern double-stars which appear to deserve much closer observation than they have yet received on the score of their probable binary character and rapid motion. They are:—

	R.A.			N.P.D.		
	h.	m.	s.	h.	m.	s.
$\lambda$ . 5014	17	59	22	133	24	2
$\lambda$ . 5114	19	18	32	144	33	2

The positions are brought up to 1885.0 from the Paramatta Catalogue.

ON THE SEAT OF THE ELECTROMOTIVE FORCES IN THE VOLTAIC CELL

AT the Montreal meeting of the British Association a discussion on the above subject was opened by Prof. O. J. Lodge. Copies of the following notes were distributed to the members present by the opener of the discussion, together with the accompanying letter. As it has been suggested that their reproduction here would be of service, we willingly give them their place.

University College, Liverpool, July 29th, 1884

The following set of statements are privately issued by me solely with the object of securing attention to definite points in the discussion on Contact Electricity, at Montreal, which I have been instructed by the Sub-Committee to open. They are numbered for convenience of reference. I have no authority whatever for appending the names I have appended to some of the statements; and in general the whole thing is merely a statement of my own personal belief. At the same time the wording is carefully chosen and is intended to be correct in detail, and the views indicated I have held with greater or less clearness for some seven years. I should have small hesitation in believing these views to be true, were it not that I fear they are at variance with those of Sir Wm. Thomson. It is in a spirit of presumption, but simply in order more easily and distinctly to elicit the truth, that I have ventured thus to do them, and I am very willing to modify all or any of them if ground shown. It may be hoped that the discussion at Montreal will result in a substantial basis of agreement with regard to the elementary and long-debated matter. OLIVER J. LODGE

I.—ORTHODOX STATEMENTS BELIEVED BY O. J. L. TO BE TRUE IN THE FORM HERE SET DOWN

A.—Volta

- Two metals in contact ordinarily acquire opposite charges for instance, clean zinc receives a positive charge by contact with copper, of such a magnitude as would be otherwise produced under the same circumstances by an E.M.F. of .8 volt.
- This apparent contact E.M.F. or "Volta force" is independent of all other metallic contacts wheresoever arranged hence the metals can be arranged in a numerical series such that the "contact force" of any two is equal to the difference of the numbers attached to them, whether the contact be direct or through intermediate metals. But whether this series changes when the atmosphere, or medium surrounding the metals changes is an open question: on the one side are experiments of De la Rive, Brown, Schultze-Berge; on the other side, Pfaff, Pellat, von Zahn. It certainly changes when the metallic surfaces are oxidised or otherwise dirty. And in general

this "Volta force" is very dependent on all non-metallic contacts.

3. In a closed chain of any substances, the resultant E.M.F. is the algebraic sum of the Volta forces measured electrostatically in air for every junction in the chain; neglecting magnetic or impressed E.M.F. [Verified most completely by Ayrton and Perry.]

#### B.—Thomson

4. The E.M.F. in any closed circuit is equal to the energy conferred on unit electricity as it flows round it.

[Neglect magnetic or impressed E.M.F. in what follows.]

5. At the junction of two metals any energy conferred on, or withdrawn from, the current, must be in the form of heat. At the junction of any substance with an electrolyte, energy may be conveyed to or from the current at the expense of chemical action as well as of heat.

6. In a circuit of uniform temperature, if metallic, the sum of the E.M.F. is zero by the second law of thermodynamics; if partly electrolytic, the sum of the E.M.F. is equal to the sum of the energies of chemical action going on per unit current per second.

7. In any closed conducting circuit the total intrinsic E.M.F. is equal to the sum of the chemical actions going on per unit electricity conveyed ( $\Sigma \int \theta e$ ), diminished by the energy expended in algebraically generating reversible heat.

8. The locality of any E.M.F. may be detected, and its amount measured, by observing the reversible heat or other form of energy there produced or absorbed per unit current per second. [This is held by Maxwell, but possibly not by Thomson, though its establishment is due to him.]

#### II.—STATEMENTS BELIEVED BY O. J. L. TO BE FALSE THOUGH ORTHODOX

9. Two metals in air or water or dilute acid, but not in contact, are practically at the same potential. [Sir Wm. Thomson, Clifton, Pellat.]

10. Two metals in contact are at seriously different potentials (*i.e.* differences of potential greater than such milli-volts as are concerned in thermo-electricity). [This is held by nearly everybody.]

11. The contact force between a metal and a dielectric, or between a metal and an electrolyte, is small. [Ayrton and Perry, Clifton, Pellat, and probably Sir Wm. Thomson.]

#### III.—STATEMENTS BELIEVED BY O. J. L. TO BE TRUE THOUGH NOT ORTHODOX

12. A substance immersed in any medium tending to act upon it chemically will (unless it is actually attacked) be at a different potential to the medium in contact with it, positive if the active element in the medium is electro-positive, negative if the active element is electro-negative.

13. The above difference of potential can be calculated approximately from the potential energy of combination between the substance and the medium, the energy being measured by compelling the combination to occur and observing the heat produced per amount of substance corresponding to one unit of electricity.

14. In addition to this contact force, due to potential chemical action or chemical strain, there is another which is independent of chemical properties, but which seems to be greatest for badly-conducting solids, and which is in every case superposed upon the former contact force, the two being observed together and called the Volta effect. Very little is known about this latter force except in the case of metals; and in these it varies with temperature, and is small. In the case of non-metals it is often much larger than the chemical contact force.

15. The total contact force at any junction can be experimentally determined by measuring the reversible energy developed or absorbed there per unit quantity of electricity conveyed across the junction. [Practical difficulties, caused by irreversible disturbances, being supposed overcome.]

16. In a chain of any substances whatever, the resultant E.M.F. between any two points is equal to the sum of the true contact forces acting across every section of the chain between the given points (neglecting magnetic or impressed forces).

17. In a closed chain the sum of the "Volta forces," measured electrostatically in any (the same) medium, is equal to the sum of the true contact forces, whether each individual Volta force be equal to each individual true force or not.

18. Wherever a current flows across a seat of E.M.F., there it must gain or lose energy at a rate numerically equal to the E.M.F. multiplied by the strength of the current.

#### Development of the above and Special Application to Metals:

19. A metal is not at the potential of the air touching it, but is always slightly below that potential by an amount roughly proportional to its heat of combustion, and calculable, at any rate approximately, from it. For instance, clean zinc is probably about 1.8 volts below the air, copper about .8 volts below, and so on. If an ordinary oxidising medium be substituted for "air" in the above statement it makes but little difference.

20. Two metals put into contact reduce each other instantly to practically the same potential, and consequently the most oxidisable one receives from the other a positive charge, the effect of which can be observed electrostatically.

21. There is a slight true contact force at the junction of two metals which prevents their reduction to *exactly* the same potential, but the outstanding difference is small, and varies with temperature. It can be measured thermo-electrically by the Peltier effect, but in no other known way. It is probably entirely independent of surrounding media, metallic or otherwise.

22. If two metals are in contact the potential of the medium surrounding them is no longer uniform: if a dielectric it is in a state of strain, if an electrolyte it conveys a current.

23. In the former case the major part of the total difference of potential is related closely to the difference of the potential energies of combination, and is approximately calculable therefrom. In the latter case the total E.M.F. is calculable accurately from the energy of the chemical process going on, minus or plus the energies concerned in reversible heat effects.

24. There are two distinct and independent kinds of series in which the metals (and possibly all solids) can be placed; one kind depends on the dielectric or electrolytic medium in which the bodies are immersed; the other kind depends on temperature. The one is something like the Volta series, but it is really the Volta series minus the Peltier; the other is the Peltier. To reckon up the total E.M.F. of a circuit we may take differences of numbers from each series and add them together.

#### IV.—BRIEF SUMMARY OF THE ARGUMENT

25. Wherever a current gains or loses energy, *there* must be a seat of E.M.F.; and conversely, wherever there is a seat of E.M.F., a current must lose or gain energy (that is, must generate or destroy some other form of energy, chemical, thermal, or other) in passing it.

26. A current gains no energy (*i.e.* destroys no heat) in crossing from copper to zinc, hence there is no appreciable E.M.F. there.

27. When a current flows from zinc to acid, the energy of the combination which occurs is by no means accounted for by the heat there generated, and the balance is gained by the current; hence at a zinc-acid junction there must be a considerable E.M.F. (say at a maximum 2.3 volts).

28. A piece of zinc immersed in acid is therefore at a lower potential than the acid, though how much lower it is impossible to say, because no actual chemical action occurs. [If chemical action does occur, it is due to impurities, or at any rate to local currents, and it is of the nature of a disturbance.]

29. A piece of zinc, half in air and half in water or acid, causes no great difference of potential between the air and the water (Thomson, Clifton, Ayrton and Perry, &c.), consequently air must behave much like water.

30. If the air were slightly positive to the water, as it is (Hankel), it might mean that the potential energy of combination of air with zinc is slightly greater than that of water, or it might represent a difference in the thermo-electric contact forces between zinc and air, and zinc and water, or it might depend on a contact force between air and water. [If such a contact force between air and water exists, it is obviously of great importance in the theory of atmospheric electricity, for the slow sinking of mist globules through the air would render them electrical.]

31. Condenser methods of investigating contact force no more avoid the necessity for unknown contacts than do straightforward electrometer or galvanometer methods; the circuit is completed by air in the one case and by metal in the other, and the E.M.F. of an air contact is more hopelessly unknown than that of a metal contact.

32. All electrostatic determinations of contact force are really determinations of the sum of at least three such forces, none of which are knowable separately by this means.

33. The only direct way of investigating contact force is by the Peltier effect or its analogues. [Maxwell.]

34. Zinc and copper in contact are oppositely charged, but are not at very different potentials: they were at different potentials before contact, but the contact has nearly equalised them.

[Certain portions of these statements which may appear wildly hypothetical, such as 13, are to be justified by figures. The justification is not complete, for lead and iron are untractable, but it does not affect the main position.]

#### THE AMERICAN ASSOCIATION

WE are indebted to the courtesy of the Editor of *Science* for the following reports of the Sectional proceedings of the American Association.

In the Section of Physics a paper was read on "The Relation of the Yard to the Metre," by Prof. William A. Rogers, who has given his life to perfecting the construction and the testing of standards of length, and the result of this his latest investigation is that the metre is 39'37027 inches in length. One of the most important physical measurements is that of the wave-length of light of any given degree of refrangibility, and this determination is best made by means of the diffraction grating. On account of the extensive use of the magnificent gratings constructed by Prof. Rowland for this purpose, Prof. Rogers instituted an investigation to determine the coefficient of expansion of the speculum-metal used in the construction of these gratings. He also noted that from its homogeneity, fineness of grain, and non-liability to tarnish, this speculum-metal is peculiarly suitable for constructing fine scales, though its extreme brittleness is an objection to its use for large scales.

Prof. Rowland stated that he proposed to construct scales on his ruling-engine which would enable the physicist at any time, by purely optical means, and without knowing the coefficient of expansion of the metal or its temperature, to obtain the value of the length of the scale in terms of the wave-length of any given ray of light. These scales were simply to be straight pieces of speculum-metal ruled with lines just as an ordinary grating, except that the length of the lines is to be only about one centimetre, every one-hundredth line being somewhat longer than its neighbours: the whole ruled slip is to be one decimetre in length. From the manner of ruling, it will be easy to count the whole number of lines in the length of the strip, and then by a simple use of the scale as a grating, in a suitable spectrometer, the whole length may be immediately found at any time in terms of any specified wave-length of light. In some forms of telephones and in the microphone the action depends on the change in resistance of a small carbon button on being subjected to pressure. There has been much discussion as to whether this diminution of the resistance with pressure is due to a change in the resistance of the carbon itself, or simply to the better contact made between the carbon and the metallic conductor when the pressure is applied.

Prof. Mendenhall has carried out some experiments to determine the question; and one of his methods of experimenting—that with the hard carbons—appears to point conclusively in favour of the theory that the resistance of the carbon itself is altered by pressure. The experiments made by him on soft carbon are open to criticism, though they also point to the change taking place in the carbon. Prof. Mendenhall finds that the resistance is not simply proportional to the pressure, and thinks that by increasing the pressure a point of maximum conductivity would be reached where there would be no change in resistance for a small change in pressure.

Prof. A. Graham Bell, the inventor of the telephone, read a paper giving a possible method of communication between ships at sea. The simple experiment that illustrates the method which he proposed is as follows:—Take a basin of water, introduce into it, at two widely-separated points, the two terminals of a battery circuit which contains an interruptor, making and breaking the circuit very rapidly. Now at two other points touch the water with the terminals of a circuit containing a telephone. A sound will be heard, except when the two telephone terminals touch the water at points where the potential is the same. In this way the equipotential lines can easily be picked out. Now,

to apply this to the case of a ship at sea: Suppose one ship to be provided with a dynamo-machine generating a powerful current, and let one terminal enter the water at the prow of the ship, and the other be carefully insulated, except at its end, and be trailed behind the ship, making connection with the sea at a considerable distance from the vessel; and suppose the current be rapidly made and broken by an interruptor; then the observer on a second vessel provided with similar terminal conductors to the first, but having a telephone instead of a dynamo, will be able to detect the presence of the other vessel even at a considerable distance; and by suitable modifications the direction of the other vessel may be found. This conception Prof. Bell has actually tried on the Potomac River with two small boats, and found that at a mile and a quarter, the farthest distance experimented upon, the sound due to the action of the interruptor in one boat was distinctly audible in the other. The experiment did not succeed quite so well in salt water.

Prof. Trowbridge then mentioned a method which he had suggested some years ago for telegraphing across the ocean without a cable; the method having been suggested more for its interest than with any idea of its ever being put in practice. A conductor is supposed to be laid from Labrador to Patagonia, ending in the ocean at those points, and passing through New York, where a dynamo-machine is supposed to be included in the circuit. In Europe a line is to extend from the north of Scotland to the south of Spain, making connection with the ocean at those points; and in this circuit is to be included a sensitive galvanometer. Then any change in the current in the American line would produce a corresponding change in current in the European line; and thus signals could be transmitted.

Mr. W. H. Preece then gave an account of how such a system had actually been put into practice in telegraphing between the Isle of Wight and Southampton during a suspension in the action of the regular cable communication. The instruments used were a telephone in one circuit, and in the other about twenty-five Leclanché cells and an interruptor. The sound could then be heard distinctly; and so communication was kept up until the cable was again in working order. Of the two lines used in this case, one extended from the sea at the end of the island near Hurst Castle, through the length of the island, and entered the sea again at Ryde; while the line on the mainland ran from Hurst Castle, where it was connected with the sea, through Southampton to Portsmouth, where it again entered the sea. The distance between the two terminals at Hurst Castle was about one mile, while that between the terminals at Portsmouth and Ryde amounted to six miles.

A few years ago Mr. E. H. Hall, then a student at the Johns Hopkins University, taking a thin strip of gold-leaf through which a current of electricity was passing, and joining the two terminals of a very sensitive galvanometer to two points in the gold-leaf, one on one edge, and the other on the other, choosing the points so exactly opposite that there was no current through the galvanometer, found that on placing the poles of a powerful electro-magnet, one above and the other below the strip of gold-leaf, he obtained a current through the galvanometer, thus indicating that there was a change in the electric potential, due to the action of the magnet. Mr. Hall explains this change by supposing the rotation of the equipotential lines in the conductor about the lines of magnetic force. This explanation has been brought into question by Mr. Shelford Bidwell, who attempts to explain the action thus: the magnetic force acting on the conductor carrying the current would cause the conductor to be moved sideways, were it free to move; but, since it is held by clamps at the ends, the magnetic force acting upon it brings it into a state of strain, one edge being compressed and the other stretched; and Mr. Bidwell supposes the whole Hall effect to be due to thermal actions taking place in consequence of this unsymmetrical state of strain. Prof. Hall, who is now at Harvard, has made some careful experiments to test this explanation of Mr. Bidwell. He used not only gold-leaf, but strips of steel, tinfoil, and other metals, and clamped them sometimes at both ends, sometimes in the middle, and sometimes only at one end; and in all cases the action was the same, with the same metal, irrespective of the manner of clamping. This was strong evidence against Mr. Bidwell's position.

Sir William Thomson suggested, as a further test to bring about the state of strain, which Mr. Bidwell supposes to be the primary cause of the action, by purely mechanical means, bring-

ing pressure to bear on one side or the other, and seeing whether the action obtained is at all commensurate with the action found by Mr. Hall.

Prof. Hall then discussed an experiment by which Mr. Bidwell had obtained a reversal of the effect, and showed that the reversal was only apparent, and that when carefully examined the results of Mr. Bidwell's experiments were best satisfied by the theory of the rotation of the equipotential surfaces about the lines of magnetic force.

Sir William Thomson spoke of the discovery of Mr. Hall as being the most important made since the time of Faraday. He favoured Mr. Hall's explanation, though he considers Mr. Bidwell's suggestion as very important, and thinks that it will very likely be found that both the Hall effect and thermal effects have a common cause, rather than that one is to be taken to explain the other. He showed also that the mathematical examination of the subject indicates three relations to be investigated,—first, the relation of thermal force to the surfaces of equal rate of variation of temperature; second, the relation of electric current to the equipotential surfaces; third, the relation of the thermal flow to isothermal surfaces. The second of these is that investigated by Mr. Hall, who has found that under the conditions mentioned the lines of flow are *not* perpendicular to the equipotential surfaces. There remains, therefore, "work for two more Halls," in either proving or disproving the existence of the analogous actions in these other two cases. Sir William Thomson also suggested the following exceedingly interesting mechanical illustration or analogue of Hall's effect. Let us be living upon a table which rotates uniformly for ever. A narrow circular canal is upon this table, concentric with the axis of rotation of the table, and nearly full of water. After a while the water will acquire the same velocity of rotation as the table, and will come to a state of equilibrium. The outer edge of the water in the canal will then stand a little higher than the inner edge. Let us now apply a little *motive* force to the water, and by means of a pump cause it to flow in the canal in the same direction in which the table is already rotating: it is evident that it will stand higher on the outer edge, and lower on the inner edge of the canal, than before. But, should we cause it to flow in the opposite direction to the motion of the table, it will stand lower on the outer edge, and higher on the inner edge, than in its position of equilibrium. The experiment made by Mr. Shelford Bidwell may also be illustrated by putting a partition in the canal so as to divide it into two circular concentric troughs, and make a little opening in the partition at some point; then taking two points near the opening in the partition, one in one trough and one in the other, if they are very close to the partition, the point in the outer trough will be at a *lower* level than that in the inner one; but if they are not close to the partition, but one is taken close to the outer edge of the outer trough and the other close to the inner edge of the inner trough, then the point in the outer trough will be at a *higher* level than that in the inner trough, though the difference in level will be only about half of what it would have been had there been no partition separating the canal into two troughs.

Prof. Forbes called attention to the fact that the classification of the metals according to their thermo-electric qualities gives not only exactly the same division into positive and negative, but that the very *order* obtained in that way corresponds to that obtained by classifying according to the Hall effect, except *possibly* in the case of aluminium.

In the Section of Mathematics and Astronomy the first paper read was by Prof. E. C. Pickering, upon the colours of the stars. The need of exact photometric measurement of different parts of their spectra was first pointed out, and the author then described a very ingenious method of accomplishing this. In the telescope tube, a little beyond the focal plane, is a direction prism, so set as to give a spectrum extended in declination; and on the preceding side of this prism is placed a piece of plane glass, whose edges are so ground that, when a small portion of the following side of the cone of rays falls upon it, it gives a small white ghost, just preceding the spectrum and always opposite the same wave-length. In the focal plane is one of Prof. Pritchard's neutral-tint wedge photometers, and behind it a thin metal diaphragm with four long, narrow slits parallel to the equatorial motion; so that, when the spectrum transits behind them, four little stars—a red, yellow, blue, and a violet—shine through these slits, and the time of the disap-

pearance of each, as they move towards the thicker edge of the wedge, measures its brightness. From these times may be deduced the magnitude and colour curve of the star. To fix the same wave-lengths for each observation, the little white ghost is adjusted upon one of two parallel wires which project out beyond the preceding side of the diaphragm. For a succeeding transit, the ghost is adjusted upon the other wire, half a slit-interval distant, and thus eight points of the spectrum are photometrically measured.

Prof. Young of Princeton spoke very highly of the ingenuity and effectiveness of the device, especially for the systematic measurement of a large number of stars. He pointed out, however, what might be a source of error, viz. the different sensitiveness of different observers' eyes to different colours, so that they would probably observe the times of disappearance of the four coloured stars slightly relatively different.

The next paper, by Prof. Daniel Kirkwood, discussed the question whether the so-called "temporary stars" may be variables of long period, referring to the sometimes-claimed identity of the temporary stars 045 and 1264, with the well-known Tycho Brahe's star, which blazed forth in Cassiopeia in 1572, and whose position is pretty closely known from his measures. The conclusion reached was, that on account of the sudden apparition of the temporary stars, the short duration of their brightness, and the extraordinary length of their supposed periods, they should be considered as distinct from variables.

Prof. Mansfield Merriman, the author of the well-known treatise on "Least Squares," proposed a criterion for the rejection of doubtful observations, founded upon Wagen's demonstration of the law of frequency of error, which was simpler than Pierce's or Chauvenet's. It involves, however, a determination of what is the unit of increment between errors of different sizes, a thing difficult to determine in very many cases.

Prof. Pickering then read another paper upon systematic errors in stellar magnitudes, showing, without any question, that the magnitudes of all the star-catalogues, from that of Ptolemy down to the great work of Argelander in the *Durchmusterung*—all depending upon eye-estimates—are systematically affected by being in, or close to, the Milky Way; they all being estimated too faint, and the error amounting to about half a magnitude in the Milky Way itself. This arises from the brightness of the background upon which the star is viewed. In the Harvard photometry measures, this source of error is avoided, since, in the comparison of each star with the Pole-Star, the two fields are superposed, and their added brightness affects both stars alike.

Prof. M. W. Harrington, Director of the Ann Arbor Observatory, read a paper upon the asteroid ring. He showed that the representative average orbit would be an ellipse of small eccentricity, with semi-major axis equal to about 2.7 times that of the earth, and inclined to the plane of the ecliptic about 1°; and that, in the progressive discovery of these small bodies, the average mean distance had gradually increased, but now seemed to have reached its limit. On the assumption that the surfaces of all the asteroids have the same reflecting power as Vesta, Prof. Harrington reaches the conclusion that the volume of Vesta is about 5/17 that of all these 230 bodies put together, and that Vesta and Ceres together form almost one-half the total volume.

Prof. Rogers, of the Harvard College Observatory, read two papers. The first, upon the magnitude of the errors which may be introduced in the reduction of an observed system of stellar co-ordinates to an assumed normal system by graphic methods, showed a great amount of laborious research, and was a good illustration of the vast amount of monotonous work necessary in the present stage of astronomical observation in order to reach the highest degree of accuracy attainable by the search for and elimination of minute systematic errors. His next paper was upon the original graduation of the Harvard College meridian circle *in situ*. This described a method of turning a meridian circle through any desired constant arc up to about 30° without any dependence upon the circle and reading microscopes, effected by means of an arm swinging between fixed stops, and clamping to a circular ring on the axis by an electro-magnetic clamp. With this Prof. Rogers claimed to be able to set off a constant arc through as many as five thousand successive movements of the clamping arm. The ingenious method suggested and carried out by Mr. George B. Clark, of the firm of Alvan Clark and Sons, of grinding the clamping circle to a perfect circular form while the telescope was swung round in its Y's was

fully described, and also Prof. Rogers' method of arresting the momentum of the telescope at the stops by water-buffer plungers. The great advantage of thus being able to set off a constant arc independent of the circle and microscopes was pointed out, with especial reference to the investigation of division errors and flexure of circle, and also to the division of the circle itself *in situ*; i.e. mounted on its axis and turning on its pivots.

Prof. Young called attention to the necessity of guarding against expansion and contraction of the bar holding the stops, due to radiation from the observer's body.

Mr. S. C. Chandler, Jun., of the Harvard College Observatory, gave the results of observations and experiments with an "almucantar" of four inches' aperture, a new instrument devised by Mr. Chandler, which seems to be of remarkable accuracy, and promises to furnish an entirely new and independent method of attacking some of the most important problems in exact observational astronomy. The instrument consists of a telescope and vertical setting-circle, which can be clamped at any zenith-distance, and is supported on a rectangular base which floats in a rectangular trough of mercury, the whole turning round a vertical axis so as to observe in any azimuth; these observations being simply the times of transit of any heavenly body over a system of horizontal wires in the field. The observations thus far have been entirely upon stars, and all at the apparent zenith-distance of the pole. After some very small periodic variations in the zenith-distance pointing had been traced to changes of temperature, and had been removed by sawing through the wooden bottom of the mercury trough, the instrument showed an astonishing constancy in this zenith-distance pointing, extending over weeks at a time, and far exceeding the constancy of the corrections to the best fundamental instruments of our observatories.

A paper was read by Mr. Chandler, upon the colours of variable stars. Showing, first, that most of the variables were red, he described some fairly satisfactory methods which he had used to measure the degree of redness of all the periodic variables; and then, plotting a series of points whose abscissae represented the length of the periods, and ordinates the degree of redness, their agreement with a curve making a very decided angle with the axis of abscissae brought out without question the remarkable law that *the redder the star the longer is its period of variability*. In discussing any theory of variable stars, Mr. Chandler pointed out that Zöllner was the only one who had thus far taken into account two laws already known, viz. (1) that they are generally red; (2) that they increase in brightness much more rapidly than they decrease; and now, in any further theory, this new third law must have a place, viz. that the redder they are the longer is their period.

Dr. R. S. Ball, Astronomer-Royal for Ireland, read a paper upon the ruled cubic surface known as the cylindroid, whose equation is

$$z(x^2 + y^2) - 2mxy :$$

Mr. W. S. Auchincloss of Philadelphia exhibited a balancing machine for finding the centre of gravity of any number of different weights distributed along a line, which seemed to be of excellent construction, extremely easy and rapid in manipulation, and quite sensitive. In connection with a time-scale of 365 days at one side, it was shown how rapidly a complicated system of business accounts could be settled, and how it could be applied to various engineering problems.

Prof. J. H. Gore, of the U.S. Geological Survey, read a paper upon the geodetic work of the U.S. Coast and Geodetic Survey.

The next paper was by Mr. J. N. Stockwell of Cleveland, upon an analysis of the formula for the moon's latitude as affected by the figure of the earth. In this Mr. Stockwell claimed that Laplace's formula for expressing this was wrong; the question turning upon an approximate integration of a differential equation, which he claimed to show was wrong by separating into two terms a single one which expressed the difference of two effects, which, thus evaluated separately, became either indeterminate or of an impossible amount.

Prof. J. C. Adams of Cambridge, England, made some comments upon Mr. Stockwell's paper, speaking in high terms of the general work which Mr. Stockwell had done in the difficult subject of the lunar theory; but from such conclusions and methods as those brought forward in this particular case he said he must express his total dissent. He then pointed out that this equation was, to begin with, only an approximation;

that, before it could be treated at all as a rigorous one, many other small terms must be included; that, further, its integration was only an approximation; and that in this case any separation into terms, which, on a certain approximate assumption, became either indeterminate or very large, was of no value as a test of the equation.

Prof. Ormond Stone, Director of the Leander McCormick Observatory of the University of Virginia, gave an elaborate description of that Observatory, now approaching completion, and to be devoted entirely to original research. The telescope, which will soon be mounted, is the twin in size of the Washington 26-inch, and like it in most of its details, except that the driving clock is like that of the Princeton 23-inch, with an auxiliary control by an outside clock, and that it has Burnham's micrometer illumination. The Observatory has a permanent fund of 76,000 dollars as a beginning, and 18,000 dollars have been expended in Observatory buildings, and 8000 dollars for the house of the Director. Situated 850 feet above the sea, and on a hill 300 feet above surroundings, the main building, circular in shape, is surmounted by a hemispherical dome 45 feet in diameter. The brick walls have a hollow air-space, with inward ventilation at bottom and outward at top.

Mr. Warner, the builder of the dome, gave an interesting description of the ingenious method of adjusting the conical surfaces of the bearing-wheels, so that they would, without guidance, follow the exact circumference of the tracks; and then of the adjustment of the guide-wheels, so that the axis of this cone should be exactly normal to the circular track. The framework of the dome consists of thirty-six light steel girders, the two central parallel ones allowing an opening six feet wide. The covering is of galvanised iron, each piece fitted *in situ*, and the strength of the frame is designed to stand a wind-pressure of a hundred pounds per square foot. There are three equal openings with independent shutters, the first extending to the horizon, the second beyond the zenith, and the third so far that its centre is opposite the division between the first and second. The shutters are in double-halves, opening on horizontal tracks, and connected by endless chain with compulsory parallel motion of the ends. The dome weighs twelve tons and a half, and the live-ring one ton and a half, and a tangential pressure of about forty pounds, or eight pounds on the endless rope, suffices to start it. If this ease of motion continues as the dome grows old, it is certainly a remarkable piece of engineering work.

In the discussion following, Prof. Hough thought he should prefer the old style of single opening extending beyond the zenith.

Prof. Stone could not agree with him, the greater extent of opening making it less probable that the dome would have to be moved so far in turning from star to star, and at the same time furnishing better ventilation, and the opportunity for cross-bracing adding strength to the dome. He stated that he should first take up the remeasurement of all the double stars of less than 2" distance between 0° and -30°.

The Rev. Father Perry, the Director of the Observatory at Stonyhurst, England, gave the result of late researches on the solar surface, with special reference to evanescent spots.

Mr. Lewis Swift, Director of the Warner Observatory at Rochester, N.Y., read a paper upon the nebulae, in which he described his method of search for new nebulae. One very interesting statement of Mr. Swift, to the effect that there had not been a first-rate clear sky since the red glows appeared a year ago following the Krakatoa explosions, bears out the general experience of workers in other observatories, especially those who try to see stars near the sun in the daytime.

An interesting discussion arose as to the much-disputed existence of the nebula round the star Merope in the Pleiades; the general drift of it being that the nebula no doubt existed, but in order to see it a clear sky was necessary, and a very low power and large field, so that the nebula might be contrasted with darker portions of the same field; that a large telescope was not necessary, in fact the smaller the better, provided the optical qualities were relatively as good. Mr. Swift said he could always see it under favourable conditions; and Mr. E. E. Barnard, of Nashville, Tenn., the discoverer of the latest comet, said that before he knew of its existence at all, he picked it up as a supposed comet.

Prof. Adams of Cambridge, England, read a paper upon the general expression for the value of the obliquity of the ecliptic at any given time, taking into account terms of the second order. The difficulties of obtaining a formula for this quantity, on

account of the many varying elements upon which it depends, were clearly explained by a diagram, and the results given of an approximation carried much further than ever attempted heretofore.

Prof. Harkness, in paying a high compliment to the celebrated mathematician and astronomer for these laborious and valuable researches, also expressed a wish that some of the  $n$ -dimensional-space mathematicians would follow the example of Prof. Adams, and apply some of their superfluous energy to the unsolved problems in the solar system, which have some direct practical bearing.

Prof. Newcomb, in remarking upon the mass of the moon used in this problem, expressed the opinion that this could be obtained most accurately by observations of the sun, in determining the angular value of the radius of the small circle described by the earth about the common centre of gravity of earth and moon, since this, in his opinion, seemed to be the only constant which could be determined by observation absolutely free from systematic errors, and hence was capable of an indefinite degree of accuracy by accumulated observations; and he asked Prof. Adams's opinion on this point.

The latter replied that he thought the quantity too small for certain accurate determination, almost beyond what could be actually seen by the eye in the instruments used.

Prof. Newcomb admitted, in the case of absolute determinations, the general impossibility of attempting to measure what cannot be seen, but, in the case of differential or relative determinations in which there was no supposed possibility of constant or systematic errors, he advanced the theory, which he had some thought of elaborating more fully at some time, that such determinations might be carried by accumulated observations to a sure degree of accuracy far beyond what can be seen or measured by the eye absolutely.

Prof. Adams hoped he would more fully elaborate and publish this idea, since there was in it an element well worth careful consideration.

Prof. Harkness doubted the sufficient accuracy of meridian observations of the sun, on account of the distortions produced by letting the sun shine full into the instrument; and spoke of the difficulties in the transit of Venus observation from this cause.

Prof. Newcomb replied that he would have to show that this would be periodic with reference to the moon's quarters in order to affect this constant systematically.

Prof. Adams then presented another note upon Newton's theory of atmospheric refraction, and on his method of finding the motion of the moon's apogee.

In the Section of Chemistry papers were read by C. F. Mabery of Cleveland, O., on chloropropionic acid and some derivatives of acrylic and propionic acids; and by C. W. Dabney on anhydrobenzamidosalicylic acid.

Dr. Springer of Cincinnati exhibited some improved torsion scales and balances. One of these had been used by Prof. F. W. Clarke, and its action was spoken of as being very satisfactory.

Messrs. L. M. Norton and C. F. Prescott read a paper on continuous etherification; and Prof. Monroe detailed results of analyses of an efflorescence on the bricks of some new buildings. It was chiefly sodium sulphate.

Mr. Clifford Richardson, in a paper on the chemistry of roller-milling of wheat, stated that the dark colour of north-western hard winter wheat could be overcome by using steel rollers run at different speeds.

Prof. Atwater has examined the nutritive value of different fish. He finds flounder to be the least value, and salmon the highest, and in invertebrates the oyster takes the lowest place as a food-stuff.

A lengthened discussion took place on the subject of valence in chemistry. Prof. Clarke remarked that it was especially useful in organic chemistry in explaining isomerism and in synthesis. It was also used in mineralogy; and he mentioned as examples of isomerism the three minerals kyanite, andalusite, and fibrolite, giving the structural formula for each. He then took up the questions of variable valence, invariable valence, and maximum valence as points that might be discussed. He remarked, further, that valence was an attempt to explain the arrangement of the atoms in a molecule, and spoke of the drawback of being obliged to represent them on a plane surface, space of three dimensions being much nearer the true state of affairs.

Prof. B. Silliman remarked that the last statement of Prof. Clarke was the key to the whole difficulty about valence. A plane surface is insufficient to explain the facts. He testified to the great utility of valence, and spoke of the chaotic condition of organic chemistry before this question of valence was appreciated. It was a working hypothesis, a scaffold without a building, but not the building. Hypothesis is not always the truth.

Prof. W. Ramsay said that the difficulties about valence could be traced to Lavoisier, who worked upon stable compounds, as oxides, chlorides. He also thought that a study of the heat of formation of many compounds would be a key to the valence of the elements; and said that the difficulties of conceiving of the motions of the atoms was well illustrated in Sir William Thomson's effort to explain them in complicated vortex evolutions.

Mr. A. H. Allen called attention to the failure of chemists to recognise the value of the work of John Newlands, in the periodic classification of the elements usually ascribed to Mendeléeff.

Prof. Greene remarked that it was best to consider the cause of valence.

Prof. Ira Remsen testified to the utility of valence. He remarked that there were two ways of teaching: one by giving all the principal theories first, and the other giving the facts and then the theories—which latter he considered the best method. He had come to the conclusion that valence should never be mentioned until all the important properties of a compound are known. In regard to its value to young students, he thought its use was dangerous until they fully understood its meaning. He believed that the value of valence had been magnified, and that it was better to study the reactions of compounds, and the methods for their synthesis, and the manner of breaking up.

Mr. A. H. Allen said that many formulae that showed the structure of compounds according to the valence of the elements do not give any idea of the true constitution of these compounds as ascertained from a knowledge of their properties. He gave, as examples of his meaning, potassic dichromate and fuming sulphuric acid.

Prof. Dewar, of Cambridge, England, maintained that the graphical method and structural formulae were most useful, but they are often presented in a way that shows an incomplete knowledge of the ideas of the person who devised the formula. He remarked that the text-books contained too many pictures of graphical formulae, and that he considered it better to follow the historical method for developing theory.

Prof. Atwater thought that some idea of valence should be given at the beginning, as it assisted the student's memory.

Prof. W. Ramsay said that he was satisfied of the utility of making the student perform experiments that brought out facts to illustrate the theory of valence, so that he could thus understand its meaning from his own work.

Prof. Caldwell said that he could not get along with students in chemical analysis who had not obtained some idea of the theory of valence.

Prof. Remsen thought that the theory of valence might be some good as an assistance to the memory; but such assistance was of doubtful value, and too empirical.

Prof. J. W. Langley, Vice-President, said that valence, or chemism, may be a force emanating from the atom, or it may be a force outside the atom; it is static, or dynamic, and a knowledge of it was more a physical than a chemical problem. From the educational view he thought it better to use the theory of valence in connection with the history of the theories concerning atoms and molecules. As a further step, the language and figures of magnetism might be used.

Prof. Stewart described a process of making leather by treating hides with sulphurous acid under pressure.

Prof. Atwater has grown pease in wa-hed sea sand, and found them to gain from 35 to 50 per cent. more nitrogen than they contained originally, and refers this increase to nitrogen directly absorbed from the air.

Dr. Springer, in a paper on fermentation, showed that a ferment exists in the stems of tobacco plants which decomposes nitrates and forms butyric acid from sugar solutions.

Prof. Dewar spoke of the density of solid carbonic acid, which he finds to be 1.58 to 1.60.

Other short communications were made by Prof. Munroe on deliquescence; on human milk, by Prof. Leeds; on gas analysis, by Dr. Elliott; and on fish oils, by Mr. Allen.



The most interesting discussion was on educational methods in laboratories and chemical lectures, by Prof. Remsen, who remarked that in Germany the student does not go into the laboratory until he understands reactions, while in England and the United States he is placed there at the beginning of the course. Prof. Remsen follows an order of instruction in which the student becomes first acquainted with apparatus and methods of manipulation. He next makes gases, and repeats lecture experiments. He then experiments on oxidation and reduction. Next follows the quantitative analysis of air. Then come alkali-metry and acidimetry, with success. This practical work and the lectures occur simultaneously, and by the time the lecturer has reached the metallic elements, the students are ready to take up test-tube reactions with profit. During the first year the student should only just begin analysis. After the general properties of the metals are known, let the student devise methods of separation. The course of instruction in our colleges Prof. Remsen regards as too short and superficial. Lecture-experiments should never be made for show. Æsthetics and chemistry are entirely distinct.

Prof. Atwater said that chemistry is taught now, as a rule, after the student has acquired the methods of the classics and has never been taught to observe facts. Chemists must show that their science will give what is called "liberal culture," or it will not find a place in our educational institutions. Present methods are not doing this, as they fail to make the student think for himself.

In the Section of Geology and Geography no paper was greeted with more interest or closer attention than that by Prof. J. E. Hilgard, Director of the U.S. Coast Survey, on the relative level of the Gulf of Mexico and the Atlantic Ocean, with remarks on the Gulf Stream and deep-sea temperatures. Its two most essential points are:—(1) The discovery by a most careful series of levels, run from Sandy Hook and the mouth of the Mississippi River to St. Louis, that the Atlantic Ocean at the former point is 40 inches lower than the Gulf of Mexico at the latter point; and (2) that ocean-water at all depths exceeding 1000 fathoms possesses a temperature of nearly 35° F., because this is the temperature consistent with its greatest density. Should the water become either cooler or warmer, it must expand; which it cannot do on account of the superincumbent pressure.

Prof. Henry S. Williams, of Cornell University, in a paper on the influence of geographical and physical conditions in modifying fossil faunas, introduced the exceedingly important subject of the extent to which palæontological evidence is to be regarded as an absolute guide in correlating strata in different regions. Prof. Williams explained a series of sections, principally in Chemung and Catskill rocks, taken from a number of localities across New York State, and adduced from them abundance of proof that faunas in Devonian times, as at present, changed not only geologically in sequence of time, but also geographically according to the areas of their distribution. The influences which brought about a change in the character of the sediment deposited also manifested themselves in altering the forms of the organisms inhabiting these sediments.

Prof. Alexis Julien of New York communicated the results of a very extended study of the *Eozoon canadense* from nearly all the localities where it has thus far been found, adding other localities of his own discovery. The result of his investigations led him to decide in favour of the inorganic nature of the so-called fossil, although his ideas in regard to the mode of its formation differ considerably from any heretofore advanced. He noticed as universal in all localities, that the calcium and magnesium carbonates were very unequally distributed in the Eozoal limestones, and that there was a large development of pyroxene where the dolomite was least abundant. He moreover observed the constant tendency on the part of pyroxene to be arranged in layers alternating with either calcite or apatite, as well as abundant evidence that pyroxene passed by hydration into serpentine, a process which could be seen in every stage at any of the localities visited. From these data it was assumed that siliceous waters, permeating limestones originally evenly dolomitic, would cause the local development of pyroxene by the change of the magnesium carbonate into the corresponding silicate. Were it the case, as so often occurs, that this pyroxene was developed in layers, its subsequent alteration to serpentine or loganite would readily account for all the appearances exhi-

bited by the Eozoon, without the necessity of appealing to organic agencies.

A large number of papers (forty-three in all) were presented before the Section of Biology; but we regret that in our limited space we can give merely the briefest outlines. The first we may mention was a paper by Mr. D. C. Beyer, on the influence of oxygenated and un-oxygenated blood, as well as of blood in various degrees of dilution, on the heart of the frog and terrapin. The paper aimed to prove that it is not concentrated mammalian blood which produces the greatest amount of work either in the heart of the frog or that of the terrapin, but that a certain degree of dilution is necessary.

Dr. C. S. Minot read a paper on biological problems. The author opposed the trinomial system, and considered the present mode of determining species entirely unscientific, and thought that the species should be based on a statistical study of all the variations that are known to occur. Individuals are not always homologous. The only fixed units are (1) cells; (2) the whole series of generations of cells from a single ovum—a cell-cycle. An individual may be almost any fractional part of a cell-cycle. Roughly speaking, the higher the organism the fewer the number of individuals it comprises. The author considered the ovum to be homologous with the encysted protozoon, the radial zone being equivalent to the capsule or cyst of the protozoon, and the contents also homologous.

Prof. E. D. Cope in a paper on the phylogeny of the Artiodactyle mammals derived from American fossils, considered the derivation of the selenodont dentition from the bunodont as established from a mechanical point of view. The oldest American Artiodactyl (*Pantolestes*) is bunodont. The modification proceeded as in other ruminants on the lines of the co-ossification of the bones of the legs and feet. The peculiar structure of the carpus in the *Oreodontidæ* shows them to be, without doubt, the ancestors of the *Tragulina*. The following table represents the present views of the author on the subject:—

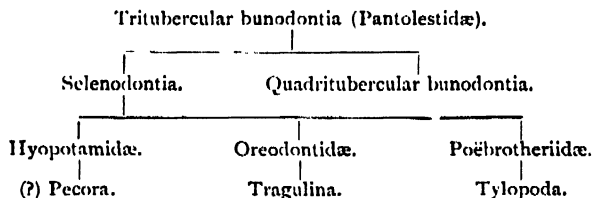

Mr. H. F. Osborne presented observations on the amphibian brain, containing results of microscopic study upon the frog, *Menobranchus*, *Menopoma*, and *Amphiuma*. His method of study was by making series of sections, in their different planes. The relative position of gray and white matter was the same as that found in the spinal cord of these and other vertebrates. The courses of the principal nerve-fibres in their course from the medulla forward to the hemispheres was described, showing the course of the transverse commissures, and pointing out a commissure in the roof of the third ventricle hitherto overlooked. This demonstrated that each brain-segment had its own dorsal commissure. The differences of the cerebellum in the *Anura* and *Urodela* were pointed out, and the resemblances of the latter to the mammalian brain were dwelt upon. The pia blood-vessels are all sent in upon the anterior face of the pituitary body. The pineal elements were shown to consist of certain very inconspicuous foldings of the epithelium of the roof of the third ventricle, which have been generally overlooked. These foldings represent what remains of the stalk of the pineal gland.

Mr. S. Garman's paper on *Chlamydoselachus*, the frilled shark, treated of the internal anatomy of this peculiar shark. The nearest forms are *Notanidae*, *Hexanchus*, and *Heptanchus*. Hind and fore brain resemble that of foetal sharks; the cartilage is soft: the lateral line is open as in foetal sharks, and continued to the end of the tail. The pelvis is twice as long as broad: the nearest resemblance to this is seen in the foetal *Heptanchus*. According to the author, the *Chlamydoselachus* may be a sub-order of the *Galei*.

The next paper was by Prof. E. D. Cope, on the mammalian affinities of Saurians of the Permian epoch, and referred to the detection of mammalian resemblances between *Thesomorphus* and reptiles of the Permian epoch. Resemblances in the pelvic and scapular arch were pointed out. The quadrate bone was discussed, referring to the theory of Albrecht. The genus

Clepsydraps shows that it has the mammalian number of bones in its tarsus, and the resemblance was nearest to that found in *Platyus anatinus*.

Dr. C. H. Merriam read a paper on the hood of the hooded seal (*Cystophora cristata*), describing it as an inflatable proboscis overhanging the mouth, and extending posteriorly to a point behind the two eyes, lined with nasal mucous membrane, and divided longitudinally by two cartilages. It is not noticeable until the male has reached its fourth year.

In a paper on some points in the development of pelagic teleostean eggs, Mr. G. Brook, Jun., first considered non-pelagic eggs, instancing those of trout, in which the hypoblast originates as an involution of the lower layer upon itself, the space between the layers being quite distinct. In pelagic eggs the process is quite different. Sections of the eggs of *Trachinus vipera* at this stage show that the parablast of Klein, the intermediate layer of American authors, is made up of a large number of free cells, and nuclei are absorbed from the yolk, which contribute to a very great extent to build up the hypoblast. In this case there is no true invagination. In *Motella mustela* the origin of the hypoblast is similar to that of *Trachinus*; but the resulting cells, instead of being quite similar to the original ones, as usual in teleostean eggs, are very much larger, and hexagonal, so that they cannot be derived directly from the lower layer of cells. The author sustained the views of Ryder as regards the segmentation cavity in pelagic eggs. He also holds that there is no circulation in pelagic embryos before hatching.

Mr. G. Macloskie, in a paper on the dynamics of the insect's test, commenced with a general description of the chitinous skeleton with its in- and out-growths, &c. The tracheæ have spiral crenulations, which have been hitherto misunderstood and supposed to be threads; these tracheæ transmit gases directly to the tissues, and the blood is not used for this purpose. The tracheæ are not directly controlled by muscles, their action depending on the successive production of a partial vacuum, and condensation of air around them.

Prof. A. Hyatt read a paper on the larval theory of the origin of tissue, stating that the building-up of the tissues of the Metazoa is due to a quick and rapid division of cells. Minot's theory that the origin of the sexes is due to the difference in cell elements was supported. The author considered the Planula a more primitive form than the Gastrula. In another paper Prof. Hyatt presented objections to some commonly-accepted views of heredity, asserting that heredity has no need of the gemmule hypothesis or pangenesis, but that it can be equally well understood upon the supposition that the nuclei of cells are the immediate agents of the transmission of characteristics. The author presented the case of a man in Maine, who resembled his mother on one side of his body and his father on the other side, as an illustration of his theory, and he contested the position of Prof. Brooks as regards heredity. In a paper on the structure and affinities of *Beatricea*, the same author stated that this fossil has had many positions assigned to it in almost all the groups of the Invertebrata, though he himself now thought it a Foraminifer. Thin sections were examined, the structure being found to consist of cells joined by a stolon.

Dr. C. S. Minot presented a paper on the skin of insects. The skin consists of three layers—externally the cuticula, overlying an epithelium, which lies in turn on a sheet of connective tissue; the epithelium is homologous with the epithelium of other animals, and should be so called instead of hypodermis; and dermis, which should be applied to the connective tissue, as it is the homologue of that of vertebrates. The cuticle of caterpillars has not yet been fully described: it consists of two layers, a thick one and a thin one.

In a communication on the development of *Limulus*, Mr. J. S. Kingsley stated that the account begins after the formation of the blastoderm. At this time there is a single layer of cells surrounding the yolk, in which are scattered nuclei. The mesoblast arises as a single sheet on the ventral surface. Its cells come largely from the blastoderm, but some arise from the yolk nuclei. The mesoblast soon forms two longitudinal layers, one on each side in the neighbourhood of the limbs. The coelom is formed by a splitting of the mesoblast, and at first consists of a series of metameric cavities extending into the limbs. The supra-oesophageal ganglion arises by an invagination of the epithelium. The heart arises as two tubes in the somatophore, which later unite. The mesenteron does not appear until after hatching. The amnion of Packard is the first larval cuticle, and bears no resemblance to the amnion of the tracheata. A second

cuticle is formed and moulted before hatching. The eyes appear on the dorsal surface at the same time that the limbs appear on the ventral. In these characters *Limulus* agrees essentially with the Tracheata, and has nothing in common with Crustacea.

Prof. B. G. Wilder, in a paper entitled, "Do the cerebellum and oblongata represent two encephalic segments, or only one?" remarked that most writers had considered two segments to exist. The cephalad of these segments is held to include the cerebellum, together with the portion of the "brain-stem" immediately connected herewith and the latter part of the oblongata. The only writers that have admitted of a single segment caudal of the mesen are Balfour, A. M. Marshall, Owen, and Spitzka. The views of Spitzka were then discussed, concluding with the opinion that sufficient evidence to settle either side was insufficient, and that the question was still open.

Dr. J. A. Ryder presented a paper on the morphology and evolution of the tail of osseous fishes. The caudal fin of fishes is developed in the same way as the median or unpaired fins, from a median fin-fold. After the protocercal stage of the larva is passed, a lower caudal lobe grows out, which is probably the homologue of a second anal fin. The hypotheses which grow out of a consideration of the facts of the development of the tails of fishes are the following:—(1) Whenever heterocercality manifests itself, there is a more or less extensive degeneration of the caudal end of the chordal axis, which began to be somewhat manifest far back in the phylum in such forms as Holocephali, Dipnoi, and Chondropterygians. (2) With the outgrowth of the lower lobes (second anal) the energy of growth tended to push the tip of the chorda upward; the lobe itself arising, probably in consequence of the localisation of the energy of growth and the deposit of organic material at the point, according to the demands of use and effort. (3) Local use and effort, acting as constant stimuli of local growth, carried the heterocercal condition and its accompanying modification of degeneration and reduction still further, as is shown by a study of the homologous elements in the tails of fishes; while use and effort would also continue to augment heterocercality, until the inferior and superior lobes were of about the same length and area, when the morphological characters of the caudal fin would become approximately stable for any one species, as may be shown by measurements of a simple mechanical illustration, in which the interaction and composition of the faces which are brought into action are demonstrated. (4) The mechanical demonstration alluded to above, taken together with the fact that the primitive or ancestral form of the tail, which is typified by a temporary condition in fish larvae, when the myocomata are rudimentary, but still symmetrical, amounts almost to a demonstration of the principles first laid down by Lamarck, then elaborated by Spencer, and more recently applied to special cases by the author and Prof. Cope.

In a communication on growth and death, Dr. C. S. Minot gave the results of 10,000 measurements of weight of growing guinea-pigs and other animals from birth to maturity. The rate of growth was found to steadily diminish from birth onward; so that the loss of power begins at once, and continues until death. The common views of death were discussed, and the current conceptions of animal individuality were attacked. The author then referred to the bearing of our present knowledge of senescence upon the theory of life, and the relation of life to a material substratum.

A paper on the osteology of *Oveodon* was read by Mr. W. B. Scott, in which this genus was said to belong to the Artiodactyla, although there are some strong resemblances to the Suidæ. The vertebrae are ruminant, markedly in the case of the axis. The thoracic vertebrae have long prominent spines, and small bodies slightly amphicælus. The lumbar, probably five in number, are heavy, with short spines and broad flat transverse processes. The sacrum contains two vertebrae which touch the ileum. The tail is long and slender, and the legs proportionally long. There are a short head and short metapodials, giving the animal a wolf-like appearance. The radius and ulna are distinct. The carpus consists of eight bones, including the pisiform. There are short unanchylosed metacarpals. The ungual phalanges are long and pointed, as in *Hyopotamus*. A rudimentary pollex is present, this being the only Artiodactyl with one.

Mr. J. Struthers, in a paper on finger muscles in *Megaptera longimana*, and in other whales, records rudimentary flexor and extensor muscles in these animals, and shows that they are more or less used, as the muscular fibres are red and not degenerated.

Dr. G. M. Stenberg described his experimental research

relating to the etiology of tuberculosis. The author repeated the inoculation experiments of Koch, with similar results. The experiments of Formad to induce tuberculosis in rabbits by introducing into the cavity of the abdomen finely powdered inorganic material, have also been repeated with entirely negative results. The author held that Koch's bacillus was an essential factor in the etiology of tuberculosis.

Dr. C. E. Bessey, in a paper on the adventitious inflorescence of *Cuscuta glomerata*, stated that the examination of young plants shows that the inflorescence is developed from numerous crowded adventitious buds, and not by the repeated branching of axillary flowering branches as commonly stated.

In a paper on the hitherto unknown mode of oviposition in the Carabidae, Prof. C. V. Riley records habits of *Chlenius impunctifrons*, traced from the eggs up. The eggs are laid singly, in cells made of mud or clay, on the under surface of leaves.

Mrs. A. B. Blackwell read a paper on the comparative longevity of the sexes. The study was exhaustive, and made on statistics from all parts of the world; and the greater longevity of woman over man was established. In old countries the females preponderate, while males lead in newly settled ones. Up to eighteen years the males are in excess of the females; later the females predominate in numbers.

### THE PRIME MERIDIAN CONFERENCE

THE Prime Meridian Conference at Washington on Monday adopted the Greenwich line as the universal prime meridian. Only one vote—that of St. Domingo—was given against its adoption; but the representatives of France and Brazil declined to vote.

The following details of the session are from the *Times* Correspondent:—

To the American resolution for adopting the Greenwich line, Mr. Fleming (Canada) moved an amendment to the effect that the Conference should adopt the 180th degree of longitude east from Greenwich as the prime meridian; but the other British delegates opposing the proposition it was lost. Señor Valera, the Spanish Minister, said that he had been instructed by his Government, in voting for the meridian of Greenwich, to say that it hoped the metric system of weights and measures would be adopted by England, the United States, and the other nationalities there represented, as recommended by the Conference at Rome. Gen. Strachey (Great Britain) said that he was authorised to state that his country had asked to be allowed to join the Metrical Convention, and that the metric system was already recognised by the laws of Great Britain, and was in use for scientific purposes. He could not, however, say that it would be adopted in any circumstances as a popular system of weights and measures throughout England. M. Lefavre (France) said the Greenwich was not a scientific meridian, and that it implied no progress in any science, but was merely a commercial standard. Since, therefore, nothing would be gained to science by adopting Greenwich, France could not make a sacrifice of her own meridian, and incur the vast expense consequent upon the adoption of a new one, because she would thereby gain no advantage whatever. Sir William Thomson, who was present as a guest, by the invitation of the Conference, spoke in favour of the choice of Greenwich. He said that it was purely a matter of convenience, and that Greenwich answered the world's convenience better than any other standard meridian. Sir Frederick Evans (Great Britain) presented a statement showing that the shipping tonnage controlled by the Greenwich standard of longitude was about 14,000,000 tons, and that controlled by the Paris one only 1,735,000 tons. From the statement of chart sales, &c., to nations outside England, he showed how largely the Greenwich measure was used.

The resolution recommending the choice of Greenwich was then adopted, the ayes being 21, and there being but one nay—San Domingo. France and Brazil abstained from voting.

Mr. Rutherford (United States) moved that from the Greenwich meridian the longitude be counted in two directions, up to 180°, the east longitude being "plus," and the west "minus." The Russian Minister advocated this proposal, but Count Lowenhaupt (Sweden) moved the adoption of the fourth resolution of the Roman Conference for counting longitude continuously through the whole 360°. Herr von Alvensleben (Germany) said that this was a matter of detail, and therefore he should not vote upon it. The British delegates agreed with the Ger-

man Minister that this was a matter of detail, and held that it would not make any difference which method was adopted. Señor Juan Pastorian (Spain) stated that he favoured the plan of counting longitude westward continuously round the world.

The discussion was here adjourned.

### UNIVERSITY AND EDUCATIONAL INTELLIGENCE

OXFORD.—The beginning of Michaelmas Term shows that the University and Colleges have not been idle in erecting new buildings for the accommodation of students. The new buildings of Magdalen—to be called the Waynflete Buildings—are ready for occupation, and will be used this term. No one can deny that the most beautiful of Oxford Colleges has added a new ornament to the city in the Waynflete Buildings. The new buildings of Trinity College are rapidly approaching completion. Stretching back from quaint old Kettle Hall in Broad Street, they extend to near the beginning of the Lime Walk in the College Garden. The open space in front of the College—known as Trinity Green—will now be bounded on the east by these new buildings. The Green will thus become one of the largest "quads" in Oxford. On the north side of the University Museum the new Physiological Laboratory is rising. Its situation is one of the pleasantest in Oxford. That Prof. Burdon-Sanderson is attracting pupils to physiology is a patent fact in Oxford, and one that will be received outside that city with the strongest feeling of satisfaction.

Since last Term we have to deplore the loss of Mark Pattison, Rector of Lincoln College. Mr. Merry, Public Orator in the University, and Fellow and Tutor of the College, has been elected his successor.

The following scheme of lectures and classes has been agreed on by the Board of the Natural Science Faculty:—

In the Department of Physics Prof. Clifton will lecture on the Galvanometer and Methods of Measuring Electric Currents, and on Thermo-Electricity. Prof. Price will lecture on Optics, Physical and Geometrical. Prof. Clifton and Mr. Walker give instruction in Practical Physics in the Clarendon Laboratory. Mr. Walker will give a course on Questions incidental to the Practical Study of Mechanics and Heat. Mr. Baynes will give a course of lectures at Christ Church on Thermodynamics, and form a class for practical instruction in Magnetic and Electrical Measurements. Mr. Dixon will give a course of experimental lectures, on Elementary Heat and Light, at Balliol College. Prof. Pritchard will lecture on Spherical Astronomy, and form a class for practical work in the University Observatory.

In the Department of Chemistry Prof. Odling will give a course of lectures on 3-carbon and 4-carbon compounds. Mr. Fisher will lecture on Inorganic, and Dr. Watts on Organic, Chemistry. At Christ Church Mr. Vernon Harcourt will form a class for Volumetric Analysis. Practical instruction in Chemistry is given daily in the Museum Laboratory, and in the Chemical Laboratories at Christ Church and Balliol College. Prof. Gilbert will complete his course on the Constitution of Plants, and will then lecture on the Effects of Manures, Exhaustion and Variations of Season on the Amounts of Produce and on the Composition of Wheat.

In the Morphological Department Prof. Moseley will begin his course of Comparative Anatomy; each lecture will be followed by special demonstrations on the subject of the lecture. Dr. Hickson gives a course on the Morphology of the Vertebrata, each lecture to be followed by special demonstrations. Mr. Barclay Thompson lectures on the Anatomy of the Mammalia; Mr. Jackson on the Fundamental Principles of Comparative Embryology; Mr. Poulton on the Distribution of Animals; Mr. Morgan on Odontography and on Human Osteology. Prof. Westwood will lecture on the Insect Skeleton.

In the Department of Physiology Prof. Burdon-Sanderson will lecture on the Physiology of Circulation and Respiration. Practical instruction will be given in the Laboratory by the Professor, Dr. Dixie, and Dr. Gotch.

Prof. Bayley Balfour will give a course of lectures in the Botanic Garden, on the General Morphology of Plants.

Prof. Prestwich will lecture at the Museum on the Principles and Elements of Geology. Dr. Tylor will lecture on the Intellectual Development of Mankind.

During the course of the present Michaelmas Term, Scholarships will be awarded in Natural Science at the following Colleges:—At Balliol College, without limitation of age; at

Christ Church, limited to persons under nineteen; at Magdalen College, limited to persons under nineteen years on July 2, 1885.

Mr. J. N. Dobie has been elected to a Natural Science Scholarship at Exeter College in Biology and Chemistry.

CAMBRIDGE.—Mr. G. F. Harmer, B.A., of King's College, has been appointed Demonstrator of Comparative Anatomy. Mr. Harmer was placed in the first class of the Natural Sciences Tripos in 1883, being distinguished in Zoology and Comparative Anatomy.

An examination for Entrance and Foundation Scholarships will be held at Gonville and Caius College, beginning on January 9 next. Six Entrance Scholarships, varying in value from 40*l.* to 80*l.*, may be awarded. The successful candidates must come into residence in October 1885. They may be awarded for Classics, Mathematics, or Natural Science, separately or combined. They are tenable for a year, when the holder will be eligible for a Foundation Scholarship. The scholarships may be increased or diminished each year, according to the scholar's performances in the College or University Examinations. Those who distinguish themselves in the Triposes may have their scholarships prolonged after their degree. A successful candidate, who after the examination enters for competition at another College, forfeits *ipso facto* any scholarship for which he may have been recommended. Candidates must be under nineteen years of age on the first day of examination. Undergraduates of the College may at the same examination compete for scholarships, in which case there is no restriction of age. Candidates in Natural Science will be examined in Physics, Chemistry, Biology, and Animal Physiology, and will be expected to show proficiency in at least two of these subjects, of which chemistry must be one. The Rev. A. W. W. Steel, Senior Tutor, will furnish fuller particulars.

Lectures and Demonstrations on Physics and Chemistry in Michaelmas Term: Prof. Stokes, short course on Double Refraction and Polarisation; Mr. Atkinson, Heat and Hydrostatics; Mr. Glazebrook, Electricity (el.), also Advanced Physics; Mr. Shaw, Physics, Elementary and Advanced. Mr. Hart, Mechanics and Heat (1st M.B.); Electricity (Nat. Sci. Tripos, Part 1); Practical Physics, Demonstrations and Practical Work at Cavendish Laboratory.

Chemistry: Prof. Liveing, General Course; Prof. Dewar, Dissociation and Thermal Chemistry; Mr. Main, Elementary Organic Chemistry; Mr. Pattison Muir, General Principles, and Elementary Chemistry, especially Metals; Mr. Heyeck, General Principles (non-metals).

Demonstrations in Spectroscopic Analysis, Prof. Liveing; Special Demonstrations for Medical Students, Mr. Sell and Mr. Fenton; also Special Demonstrations for Nat. Sci. Tripos, Part 1; Mr. Robinson, Demonstrations in Analysis of Food and Water; Practical Work at the University, St. John's, Caius, and Sidney College Laboratories.

Prof. Lewis, Mineralogy and Crystallography; Demonstrations on Minerals, by Mr. Solby.

Prof. Stuart, Mechanism and Applied Mechanics; Mr. Lyon, Rigid Dynamics. The Mechanical Workshops are open from 8 to 1 and 2 to 6 daily.

Geology: Prof. Hughes, Economic Geology and Geological Surveying; Tides, Mr. E. Hill; Stratigraphy, Dr. R. D. Robert; Palæontology, Echinoidea, Mr. T. Roberts; Constituents of Rocks, Mr. A. Harker. Field Lectures will be specially announced.

Botany, Elementary, with Practical Work, Dr. Vines; Physiology of Plants, Advanced, Dr. Vines.

Zoology and Comparative Anatomy: Prof. Newton, Evolution in the Animal Kingdom; Elementary Morphology (Invertebrata, Mr. Sedgwick; Advanced Invertebrata, Mr. Harmer; Mammalia, Living and Extinct, Osteology, Strickland Curator (Dr. Gadow).

Physiology, Elementary Course, with Practical Work, Prof. Foster; Chemical Physiology, Advanced, Mr. Lea; Advanced Course of Physiology and Histology, Mr. Langley; Preparation for 2nd M.B., Mr. Hill.

Human Anatomy, Muscular System, Prof. Macalister; also Demonstrations of Visceral Anatomy; General Pathology, Prof. Roy; also Practical Class in Morbid Histology.

Advanced Mathematical Lectures: Prof. Stokes, Optics; Prof. Cayley, Recent Developments in Analysis and Geometry; Prof. Darwin, Theoretical Astronomy; Mr. Forsyth, Higher Algebra, Binary Forms; Mr. Hobson, Higher Dynamics; Mr.

Glazebrook, Higher Geometrical Optics; Mr. J. J. Thomson, Electrostatics; Mr. Macaulay, Thermodynamics; Dr. Besant, Theory of Equations, Differential and Integral Calculus; Mr. Lock, Fourier's Series, and Vibrations of Strings and Bars; Mr. Stearn, Hydrodynamics; Mr. Temperley, Laplace's Functions; Mr. Webb, Theory of Attractions and Elasticity, if a sufficient number apply.

THE formal inauguration of the University College of North Wales, Bangor, has been fixed for the 18th inst., and it is expected that the Duke of Westminster, the Earl of Powis, Lord Aberdare, Lord Penrhyn, Mr. Mundella, and other gentlemen, will take part in the proceedings. The fitting up of the new laboratories and lecture theatres for the chemical and physical departments is being rapidly pushed forward, and the buildings include a very complete suite of rooms for the use of each department. An excellent equipment of scientific apparatus has been secured for all branches of chemistry and physics. Mr. George Macgowan, F.R.S.E., formerly of Prof. Fresenius's Laboratory, Wiesbaden, and now of Prof. Kolbe's Laboratory, Leipzig, has been appointed Demonstrator in Chemistry under Prof. Dobbie, and Mr. D. M. Lewis, M.A., Trinity College, Cambridge, Demonstrator in Physics under Prof. Gray.

## SOCIETIES AND ACADEMIES

SYDNEY

Linnean Society of New South Wales, July 30.—Dr. James C. Cox, F.L.S., Vice-President, in the chair.—The following papers were read:—Revision of the Lamellibranchiata of New Zealand, by Capt. F. W. Hutton, F.G.S. This is a carefully revised list of all the Lamellibranchiate mollusks of New Zealand, with the corrected synonyms and localities of each species. A list is also given of the names of each genus which had been wrongly included by previous authorities in the New Zealand fauna.—List of some New South Wales Zoophytes identified by Dr. Kirchenpauer, by Baron Sir F. von Mueller, K.C.M.G., F.R.S., &c. The list contains the exact localities of six species of Hydroida and fifteen of Bryozoa collected by Miss Bate on the south-east coast, and Miss Hodgkinson at the Richmond River. They were all detached from sea-weeds, and identified by Dr. Kirchenpauer, Burgomeister of Hamburg.—New Fishes in the Queensland Museum, part iii., by Charles W. De Vis, M.A. Mr. De Vis in this paper goes through the families *Berycidae*, *Scorpidae*, *Carangidae*, *Scombridae*, *Trachinidae*, and *Triptilidae*, describing in all twenty-three new species, mostly from the coasts of Northern Queensland.—Census of Australian snakes, with descriptions of two new species, by William Macleay, F.L.S. The two new species are named *Dipsas boydii* and *Diemania atra*, both from the Herbert River District, Queensland. The census gives the names, references, and localities of 108 species of snakes, thirty-five of these being innocuous, and seventy-three venomous. The paper concludes with some remarks on the immunity from snake-bite enjoyed by Australia, as compared with India.—On a new species of kangaroo (*Dorcopsis chalmersii*) from the south-east end of New Guinea, by N. de Miklouho-Maclay. A young kangaroo obtained by N. de Miklouho-Maclay in New Guinea, in 1880, has proved to be (on account of the great size of the præmolars, the general shape of the skull, and the direction of the hair on the neck) a new species of *Dorcopsis*, which he describes as *Dorcopsis chalmersii*, Mcl. The specific name, *Chalmersii*, is given in honour of the well-known and distinguished missionary of the south coast of New Guinea. The paper contains a full description of the animal and its dentition.—On a complete debouchement of the sulcus Rolando into the fissura Sylvii in some brains of Australian aborigines, by N. de Miklouho-Maclay. A complete junction of the sulcus Rolando with the fissura Sylvii, which is very rare in brains of our race (a single case only having been described by Prof. Turner), has been found by the author in two out of four brains of Australian aborigines. The junctions of the sulcus Rolando with other sulci are, according to Dr. Maclay, also not uncommon in brains of men of dark races, and occur more frequently than in the brains of men of the white race.—The Australian Hydromedusæ, part v. (conclusion), by R. von Lendenfeld, Ph.D. In this paper the monograph on the Australian Hydromedusæ is brought to a close. All known Australian species are enumerated, with the necessary references, and thirty new species discovered and described by the author are added. The total number of species

is 231. The most interesting of the new species are illustrated. The classificatory system established by the author is used.—Muscular tissue of Hydroid Polyps, by R. von Lendenfeld, Ph.D. A Hydroid Polyp discovered by the author in Port Phillip possesses a singular apparatus for escaping its enemies. This animal was investigated by Dr. R. von Lendenfeld, and a remarkable muscular structure was discovered. The histological structure of this is described, and some general conclusions drawn from the observations on muscular tissue, by O. and R. Hertwig, Claus, and the author.—Notes on the fibres of certain Australian Hiricinidae, by R. von Lendenfeld, Ph.D. The author discusses the origin of the "filaments," and describes some new and interesting peculiarities of the Australian Hiricinidae.—On the Myrtaceae of Australia, by the Rev. W. Woolls, Ph.D., F.L.S. In this paper the author gives tabular statements of the distribution of this large order throughout the globe, but with special reference to its development in Australia. From an examination of these tables, as well as from other considerations, it is clear that West Australia must be regarded as the metropolis of the essentially Australian flora, the plants of the eastern portion of the continent bearing evident relation to Asiatic and Oceanic forms, while those of the west find their nearest, though still very distant, kindred in the yet more distant continent of South Africa.—On marine Annelids of the order Serpulea: observations on their anatomy, with descriptions of the Australian species, by William A. Haswell, M.A., B.Sc. The points treated of are the pseudohemal system, the segmental organs, the tubiparous glands, budding and hermaphroditism, and the characteristics of the Australian representatives of the order. The arrangement of the vessels in several of the genera is described. Segmental organs of a simple type are shown to exist in addition to tubiparous glands which had been previously regarded as representing the segmental sacs of other *Polychaeta*. Details are given of the structure of the tubiparous glands in a variety of genera.—On a new Crustacea found inhabiting the tube of *Vermilia*, by William A. Haswell, M.A., B.Sc. In the tube of a Port Jackson *Serpulid* the author found several specimens of a remarkable Isopod, each with a brood of young. It proved to be a form differing in various points from any of the known families, but most nearly related to the Anthuridae. The young were free in the cavity of the tube, sheltered, however, by fasciculi of hairs fringing the pereon of the parent. Like the "normal" Isopoda, and unlike the Anthuridae, the embryos are flexed in the egg towards the dorsal side; there is a pair of jointed larval appendages connected with the second larval cuticle.—Note on *Pristiophorus cirratus*, by William A. Haswell, M.A., B.Sc. This remarkable genus of sharks was shown to be viviparous, and to possess a rudimentary shell thrown off in the uterus as in *Mustelus*, *Carcharias*, *Galeus*, and *Sphyrna*.

## PARIS

**Academy of Sciences**, October 29.—M. Rolland, President, in the chair.—Note on the total eclipse of the moon on October 4, by M. Mouchez. Owing to its long duration, this eclipse offered a favourable opportunity for more exactly determining the diameter of the moon through the occultation of numerous small stars near the lunar disk. Although the weather was far from favourable, a sufficient number of observations were taken by MM. Périgaud and Bigourdan to advance the solution of this problem considerably. A large number of photographs were also taken by MM. Paul and Prosper Henry. The duration of the eclipse appeared to be rather less than the period theoretically determined.—Note on the experiments recently made at Turin and Lanzo to distribute the electric light to great distances, by M. Tresca. These experiments, carried out by Messrs. Gaulard and Gibbs in connection with the International Electrical Exhibition now being held at Turin, are stated to have been attended by a large degree of success. A Siemens' dynamo-electric machine of 30 horse-power generated an alternate current, which was simultaneously utilised by the Swan, Siemens, and Bernstein systems distributed over a circuit of twenty-four miles between the Exhibition, Lanzo, and intermediate stations.—Note on the nitrates present in plants at the various periods of their vegetable development, by MM. Berthelot and André.—On the explicit solution of Hamilton's quadratic equation in quaternions or in matrices of the second order, by Prof. Sylvester.—A fresh communication on a method of extracting the colouring matter from straw, by M. E. Cadoret, was referred to the previously appointed Commission; and a memoir by M. Goyet, on a project for the construction of a

marine canal between the Atlantic and the Mediterranean was referred to M. de Lesseps for examination.—Results of the observation of the recent lunar eclipse made at the Paris Observatory (equatorial *coudé*), by M. Périgaud.—Note on the same eclipse as observed at the Paris Observatory (equatorial of the West Tower), by M. G. Bigourdan.—Observation of the same eclipse, by M. Trépid.—Observations of Wolf's comet made at the Observatory of Algiers (0.50 m. telescope), by M. Rambaud.—Observations of the new comet, made on September 24, 25, and 26, by M. Perrotin. Under the spectroscope the nucleus yielded a continuous brilliant spectrum crossed by the three usual bands of comets, and by a fourth in the violet, like that observed some months ago in the spectrum of the Fons-Brooks comet.—Observations of the solar spots and faculae during the third quarter of the present year, by M. Tacchini.—Remarks on the solar halos observed at Rome during the last four months (four illustrations), by M. P. Tacchini. This phenomenon, which has been constantly visible at Rome shortly before sunset since the first appearance of the after-glows in November 1883, is stated to resemble in every respect that already described elsewhere by M. Cornu.—Note on the action of water and of nitric acid on the basic acid of the bioxide of tellurium, by MM. Klein and J. Morel.—Note on the experimental study of infectious osteomyelitis, by M. A. Rodet.—On the elimination of phosphoric acid by the urine in cases of mental disorders and epilepsy, by M. A. Jallier.—Geological observations on the section of the Cordilleras traversing the Isthmus of Panama, by M. Ch. Mano. A careful survey of this region in connection with the works now in progress on the Inter-oceanic Canal has satisfied the author that the northern continuation of the Andes system following the double curve of the isthmus throughout its entire length, belongs to a far more recent geological epoch than that of the syenites and serpentines of Chocho and Antioquia, whence they appear to branch off. They are also later than the diorites, volcanic and other porphyries of the Costa Rica coal range, which belong to the system of the Rocky Mountains, stretching thence northwards to the Polar Sea. The eruptive rocks of the isthmus seem to be contemporary with the volcanic formations of Auvergne, dating from the Quaternary or the dawn of the present epoch, and containing fossil human remains.

## CONTENTS

	PAGE
<b>Handbook of Botany</b> . . . . .	581
<b>Our Book Shelf:—</b>	
Hobkirk's "Synopsis of the British Mosses."—J. G. Baker . . . . .	582
Wood's "Our Insect Allies" . . . . .	582
<b>Letters to the Editor:—</b>	
Shifting of the Earth's Axis.—Prof. C. Piazzismyth . . . . .	582
The Sky-Glows.—Robert Leslie; Joseph John Murphy . . . . .	583
Circular Rainbow.—William P. Marshall . . . . .	584
To Find the Cube of any Number by Construction.—R. Tucker . . . . .	584
Explorations in Iceland. By Th. Thoroddsen . . . . .	584
Storage Batteries . . . . .	585
Meteorology of the Lower Congo . . . . .	589
The Recent Eclipse of the Moon. By Otto Boeddicker; E. J. Lowe; George F. Burder. ( <i>Illustrated</i> ) . . . . .	589
<b>Notes</b> . . . . .	591
<b>Our Astronomical Column:—</b>	
The Approaching Appearance of Encke's Comet . . . . .	594
Variable Stars . . . . .	594
Southern Binaries . . . . .	594
<b>On the Seat of the Electromotive Forces in the Voltaic Cell</b> . . . . .	594
<b>The American Association</b> . . . . .	596
<b>The Prime Meridian Conference</b> . . . . .	602
<b>University and Educational Intelligence</b> . . . . .	602
<b>Societies and Academies</b> . . . . .	603

THURSDAY, OCTOBER 23, 1884

## FIELD AND GARDEN CROPS

*Diseases of Field and Garden Crops.* By Worthington G. Smith, F.L.S. (London: Macmillan and Co., 1884.)

THE fact that a handbook of the diseases of crops has been written would not seem to other than botanists and agriculturists to be anything specially noteworthy. But in the British Empire, where plant economics is certainly better understood and its lessons more eagerly and thoroughly applied than in any other community, it is both true and surprising that no guide to the study of plant diseases and their prevention—at least none worthy of the name—has until now appeared. Nothing more admirable than the papers on vegetable pathology contributed by the Rev. Mr. Berkeley to the pages of the *Gardeners' Chronicle*, and the many writings of this and other authors scattered throughout our serial scientific literature, can, within their range and for their time, be shown elsewhere. But of recent years remarkable advances have been made, especially in Germany, in the study of the ætiology of plant diseases, and an excellent and comprehensive handbook was prepared a few years ago by Prof. Frank. Without doubt this author has gone as far as the state of science permitted him, but nevertheless a serious attempt to deal with vegetable pathology has yet to be made, and the attempt must be preceded by a great amount of laborious research. The activity shown in the investigation of parasitic diseases leaves little to be desired, but the many other ailments that the plant is subject to are but little regarded. That injuries are done by defective nutrition, by frost, and such like causes, is doubtless well recognised, but beyond this recognition there has not been very much inquiry into the matter. It is as if we were to be content with classifying the diseases of man into those due to the prevalence of east winds and the like.

While pathology is in this condition our therapeutical resources must continue scanty. Much may be hoped however from such researches in plant nutrition as those of Dr. Gilbert and Sir John Lawes. The means in our power of coping with the attacks of insects and of fungi are, it must be confessed, not very effective. There is doubtless something exhilarating in the wholesale destruction of insect pests by means of a judicious mixture of soap-suds and petroleum (applied on occasion by a fire-engine), and the heroic slaughter of the enemy may spur on the administrator to further and greater deeds, but except for very "local application" even this method will hardly lead to generally useful results. More—much more—is to be hoped from the encouragement of insectivorous birds, as recommended by entomologists. In fungal diseases our chief hope lies in "stamping out" either by means of the interception of a generation (where possible) on a comparatively worthless host, or by rigorous destruction of infected crops. It is true cases occur where timely amputation may save the remainder, and a method of cultivation (of potatoes) is under trial, the aim of which is to check the disease in each case at a certain stage of its

VOL. XXX.—No. 782

progress—but the result will be seen. The introduction of new and "disease-resisting" races opens up also a means of evading fungal diseases.

Mr. Worthington Smith in the introductory chapter of his book laments that "there are no special teachers of vegetable pathology in this country, and the few men who have made the subject more or less a specialty, have not the time or opportunity for extensive or continued experiment and research." As one of those who have given much time and attention to this subject, Mr. Smith has here endeavoured to make up in some measure for this want by supplying us with a treatise on the diseases of crops, selecting such as are of the first economic importance, describing their phenomena in simple language, and considering the best means of preventing attack. With the exception of the attacks of Nematodes, he has confined himself to vegetable parasites, and of these he has supplied copious illustrations faithfully recording his views of the structure and the phases passed through by such organisms. The advice given throughout is cautious and to the point; the book is in very handy form, and within the reach of all in point of price. As such, then, it must be considered a decided gain to the farmer, the gardener, and the author's fellow-workers. Many of the last-named will regard with regret the fact that the author has not seen his way to accepting the proofs of so well-established a fact as the heterœcism of the *Uredineæ*. Mr. Smith devotes a chapter to the consideration of the subject, in which he attempts to combat the irrefragable evidence of the truth of this fact furnished us by experiment. Such objections, to give but one example, as that to the different periods occupied by the cultivation-experiments of different observers are not only of no account, but Mr. Smith must surely know from his own experience that the germination and further growth of spores as well as seeds vary exceedingly in different circumstances even under the same observer's hands. But it would be beyond the scope of this review were I to enter upon any defence of the existence of heterœcism in the *Uredineæ*. What is more particularly to be noticed in this section of the book is a theory of the hereditary nature of parasitic diseases. At p. 197 the author says:—

"We have shown that plants invaded by *Puccinia* and *Æcidium* carry an hereditary disease by which they are saturated, and that the disease is capable of reaching the seeds and reappearing in the youngest seedlings. Now, if plants thus suffering from hereditary disease, and having the latent germs of disease in every part of their organisation, are experimented upon in an unnatural way, have spores of fungi placed near their organs of transpiration, whose germ-threads can pierce the epidermis or enter and choke the stomata and so reach their intercellular spaces, is it not likely that this inoculating process may start into activity the latent germs of disease?"

This is illustrated by the "instance of a person constitutionally subject to phthisis (consumption): give that person a cold and phthisis appears; but the same cold will give rise to rheumatic fever with a second constitution, and scrofula with a third, according to the tendency of the individuals to these disorders." Since Mr. Smith considers the heterœcism of the *Uredineæ* as not proven in spite of the nature and the amount of the evidence, one cannot help being profoundly astonished at the ease

D D

with which he, even their own author, accepts such startling speculations concerning the hereditary nature of the parasitic diseases of plants.

In the matter of the potato disease, Mr. Smith gives a history of the whole subject, and a full description of the oospores, which he claims to be those of the *Phytophthora*. At p. 340 there is a sentence of some interest in view of the above-mentioned theory.

"It is quite possible, then, that just as every atom of a mycelial thread of this fungus (potato fungus) will continue its growth to a perfect form, so every atom of a broken-up flagellum—perfectly invisible to the eyes even when the highest powers of the microscope are used—may be capable of carrying the poison and at length reproducing the perfect form of the fungus in the potato plant."

Everything is possible, but some things are undoubtedly highly improbable, and chief among these are those which we have not the slightest grounds for supposing probable. Such is the case with this speculation since (to take the flagellum only) in the first place it is not by any means certain, as the author indeed points out in the same paragraph, that a flagellum breaks up at all, and in the second it is quite unwarrantable on any known basis of fact to suppose that its fragments are endowed with any reproductive function.

Apart from such speculations, I venture to think that Mr. Smith has rendered the study of vegetable parasites a signal service in the publication of this book. Its practical uses to the farmer and the gardener are apparent, and to the student of the subject the advantage is no less, even in those cases where the author differs from the great majority of his fellow-workers, since "the case for the opposition" is as well and as strongly stated as the materials permit. The book is of practical value in this country, and it is, moreover, one which no intelligent agriculturist can afford to dispense with in these times, when farming is engaged in a struggle of such severity at so many points.

GEORGE MURRAY

### OUR BOOK SHELF

*How to Forecast the Weather with the Pocket Spectroscope.* By F. W. Cory. (London: Chatto and Windus, 1884.)

It is of little use putting any instrument, however simple it may look, into a student's hands, if he is not previously taught how to use it. This needful information is supplied by the handy little book now before us, showing what can be done with a direct-vision spectroscope only some 3½ inches long.

The book commences by describing two pocket spectroscopes now in use: the "rainband spectroscope," and a newer and somewhat larger instrument, "Grace's spectroscope," which, however, is still small enough for the pocket, being only 5½ inches long when closed, and which has the advantage of giving a larger spectrum. Here, however, there is a most important omission, for the adaptation of a lens to focus the image of a cloud or a part of the horizon on the slit is not referred to. Instruments thus armed are far better than those of the ordinary construction for meteorological purposes, and, as made by Hilger, they are not appreciably larger. We are next told how to use the spectroscope, and a map is given (Plate 1), showing the positions of some of the lines which the student should learn to recognise in the spectrum of the sun, in order to see at once if the rainband is present or not.

On another page we find the principal rainband itself (Plate 2), which is instructive as showing the student what to look for; but in the construction of this map a larger spectroscope, of two prisms, has been employed, so that if the student in looking for the rainband uses his pocket spectroscope, he will be somewhat disappointed. It would have been more complete if a drawing of the rainband, as seen with Grace's spectroscope, could have been given side by side with Plate 2, which shows so much of the detail.

The book concludes with letters, reprinted from the *Times*, from the Astronomer-Royal for Scotland and others, showing the value of the spectroscope for meteorological purposes.

We think no one can lay down this little volume without feeling this opinion confirmed, and that in the pocket spectroscope we possess an invaluable instrument with which to forecast the state of the weather. B.

*Celestial Motion: A Handy Book of Astronomy.* By W. T. Lynn. (London: Stanford, 1884.)

MR. LYNN'S long training at the Royal Observatory has eminently qualified him to write this little book. It is in no sense a school-book, but all the same it contains a most useful introduction to those parts of the science of astronomy of which it treats. These are the earth, sun, and moon; the planets arranged in three groups; comets, meteoroids, and the fixed stars. There is added a very painstaking and concise history of astronomical discovery, the only blot in which is an ineffective reference to spectrum analysis at the end.

*The First Six Books of the Elements of Euclid, and Props. i.—xvi. of Book xi., and an Appendix on the Cylinder, Sphere, Cone, &c.* With copious Annotations and numerous Exercises. By John Casey, LL.D., F.R.S. (Dublin: Hodges, Figgis, and Co., 1884.)

THIS is the second edition of a work which so accomplished a geometer as Prof. Henrici (vol. xxix. p. 453) has pronounced in these columns to be in many respects an "excellent" book. As the first edition contained 254 pages, and this one reaches 312 pages, it is manifest that the work has grown—and with its growth we find that it has acquired an accession of strength. We will indicate in what directions it has increased. First and foremost is the addition of the propositions of Euclid's Eleventh Book, which are generally read by junior students, and an appendix (well suited for candidates for the London Intermediate Examination) on the properties of the prism, pyramids, cylinder, sphere, and cone. There is also now given an explanation of the ratio of incommensurable quantities, and a still greater number, than in the first edition, of alternative proofs. Further, we can testify, by a careful perusal of the text, that the work has been "thoroughly revised as well as greatly enlarged." One feature we note, that whereas in the first edition the *syllabus* of the Association for the Improvement of Geometrical Teaching was often referred to by quotation, in this edition the name occurs but once or twice. There are reasons for most actions—we presume there are for this course of action.

We are glad to note that Dr. Casey makes frequent use of the term *right line*; the absence of the word "right" is liable to lead young boys astray: we should also prefer in one or two instances the term "circumference" (the line) to the term "circle."

Numerous easily rectified clerical mistakes occur, and we could wish that the author had uniformly written *AB* for a line drawn from *A* to *B* instead of apparently writing the letters haphazard. The terms *area* and *perimeter* are employed without definition; a work by Prof. Townsend (p. 142) is referred to without giving exact reference; and an examination question (p. 173) in-

volves an acquaintance with Gauss's discoveries in regular polygons without the information having been given to the student. The proofs of i. 9 and iii. 35 appear to us to admit of improvement, the first by the familiar addition of "on side remote," &c., and the latter might advantageously be curtailed. These are small faults in a work of such extent, and we instance them to show how little we find not to our liking in an admirable text-book. We notice that Dr. Casey has adopted the convenient terms "circum-circle," "circum-centre," &c., first introduced, we believe, by W. H. H. in these columns. He also calls a certain well-known locus by the name of "Simson's line," following the practice now usually adopted by geometers in this country, we do not know on what authority; that well-informed writer in the *history* of the subject, Mr. J. S. Mackay, states in his edition of Euclid, recently reviewed in these columns, that he had not met with the property in Simson's writings.

Prof. Henrici in his article on "The Axioms of Geometry" (*NATURE*, *loc.*) does not approve of Dr. Casey's treatment of the Fifth Book (the Algebraic), and criticises adversely Hamilton's quaternion proof of Euclid i. 32, given by our author in an appendix (cf. also *NATURE*, vol. xxix. p. 573). Dr. Casey prints the article as in the first edition, and takes no notice of the criticisms we refer to. A very large and well-selected collection of exercises (upwards of 800 we think), with the addition (now) of numerous examination questions, complete a work every way worthy of the reputation of the great Irish geometer.

#### LETTERS TO THE EDITOR

- [The Editor does not hold himself responsible for opinions expressed by his correspondents. Neither can he undertake to return, or to correspond with the writers of, rejected manuscripts. No notice is taken of anonymous communications.]
- [The Editor urgently requests correspondents to keep their letters as short as possible. The pressure on his space is so great that it is impossible otherwise to insure the appearance even of communications containing interesting and novel facts.]

#### The Sky-Glows

ON reading Prof. Herschel's letter in *NATURE* for October 2 (p. 536), in which he so vividly describes the sunset of Sept. 20, I was so forcibly reminded by its similarity, especially with regard to the "diverging beams," to one which I lately witnessed during an excursion to the White Mountains (New Hampshire), that I send you a short account of it. It occurred on the evening of September 9 while we were staying at Twin Mount House, at a short distance from which is an elevated wooden erection, commanding splendid views of the neighbourhood. We had been watching the shadows creeping over the hills, the evening light reflected on a bend in the river below, had seen the sun go down behind the soft gray outlines of Mount Agassiz, and revelled in the glorious tints, such as Prof. Herschel describes, when, on returning to the hotel and stepping out on the balcony to take a last look, we saw, from the point where the sun had lately disappeared and where the fiery glow still lingered, these remarkable "diverging rays," so distinct in their character and so sombre in their dark (though slightly greenish) shadow-like hue—there were not many of them—that I involuntarily exclaimed that I had never seen anything like them before, and that surely the climate must have something to do with their striking appearance and unusual definition. I may mention that the day-glow was also conspicuous at times on that continent, notably at Quebec on August 25 last.

Since writing the above, I find that your correspondent, Mr. J. E. Clarke (September 18, p. 488), also refers to dark bars at sunrise and sunset, and the radiating character of the latter.

Further Barton, Cirencester, October 17 E. BROWN

THAT Mr. Backhouse is right in thinking the day-glows were entirely fresh in November of last year, the following extract from my diary confirms. As ordinary meteorological phenomena are entered upon a daily chart, my note-book only refers to what

is unusual. Those whom I called to notice the sky thought it quite strange. "1883, xi. 25.—SKY COLOURING at 2.45 to 3 p.m. of a pale rosy-pink tint to the blue, giving a greenish-gray cast to cirro-cumuli where it shone through. Formed circle round sun extending from about 10° to 25° or 30° away. Inside the 10° sky yellowish. Can this have anything to do with the green sun seen in India, and therefore with the Java eruptions? Have noticed once or twice of late unusual sunset-colouring very late. At 4.30 strange ruddy or bright red tint on brick houses in Bootham. At 5.30 the west ruddy, as from glare of fire; still signs visible of this up to six. Sunset at Greenwich at 3.58; therefore here at 3.38. Notice also various newspaper reports and also in *NATURE* of striking appearances after sunset, ascribed to auroras, &c." J. EDMUND CLARK  
Bootham, York, October 19

#### Cole's Pits

IN reference to the subject of the "Cole's Pits," respecting which a notice from Mr. A. Irving appeared in *NATURE* for Oct. 9 (p. 560), I find that as early as 1784 these pits, or rather perhaps some of them, were investigated by the Hon. Daines Barrington. And a paper appears on the views entertained by him regarding them in *Archæologia*, vol. vii. p. 236, under the head of "An Account of Certain Remarkable Pits, or Caverns, in Berk-shire." Although Mr. Barrington expresses some doubts as to his conclusions, he nevertheless leans to the opinion that they are the winter dwellings of a pre-Roman people, the entire series constituting perhaps an ancient British town. He estimates them at about 273 in number, and covering a space of about 14 acres. In depth they vary from 7 to 22 feet, and are 40 feet and upwards in diameter, the largest being not in all instances the deepest. They extend in regular series, and are placed rather closely to each other. They are referred to a period anterior to that of Stonehenge; and it is conjectured that if each pit contained five occupants the entire community would have numbered something like a population of 1400 souls. As suitable for the residence of uncivilised people stress is laid on the fact that the place is entirely of the dried sand on the rich vale of the White Horse. The dwellings are supposed to have been entered by climbing down a rude ladder or notched pole after the manner adopted by the natives of Kamchatka in reaching their underground habitations. It is remarkable as bearing on the theory that these pits are abandoned quarries, that no objects, such as pottery, indicative that they (the pits) were used as dwellings, were found by Mr. Barrington. There can be no doubt that the pits are simply the sites of shafts dug for the purpose of obtaining the underlying ironstone. Indeed, Mr. Godwin-Austen appears to have set the matter at rest many years ago; and although I am not able at the moment to state in what paper on the subject the opinion occurs, I am in possession of a note in which Mr. Godwin-Austen, with the keen perception of the skilled geologist, observes that although "the Faringdon tradition points this spot out as the site of the castle of King Cole, whose memory is preserved in a well-known fragment of popular poetry, geology can countenance no fictions except its own, and Cole's Pits are evidently the remains of the open workings for the ironstone underlying the mass of sand."

Reading, October 10

JOSEPH STEVENS

#### Circular Rainbow

THE circular rainbow mentioned by Mr. Marshall seems to be similar to what may be seen at the Niagara American Falls by persons who are fortunate enough to have taken the trip under a portion of that Fall at the right time. When coming out into the front of the Fall, if the sun be shining and in a favourable position, each observer is surrounded by a rainbow of which his eye is the centre, and which accompanies him while in front of the Fall like the halo of a saint of old, but larger.

Before railroad days, when travelling by coach from Bristol to Bridgwater, I once saw a complete circular rainbow resting on the vale below the Leigh Woods, just out of Bristol.

Barnstaple, October 20

W. SYMONS

P.S.—One morning, as the sun was rising over the Southern Atlantic, the sea being moderately rough, I saw each white crested wave drowned with the prismatic colours, causing a dancing play of glorious colour never to be forgotten.



THE NEW GEOLOGICAL MAP OF RUSSIA<sup>1</sup>

GEOLOGISTS will be glad to hear of the appearance of the first sheet of the "Geological Survey of Russia," published by the Geological Committee on the scale of 10 versts to an inch. It comprises nearly the whole of the Government of Yaroslav and the eastern parts of Tver, between 57° 0' and 57° 42' N. lat., and 43° 10' to 47° 40' E. long., corresponding thus to Sheet 56 of the General Staff Map of Russia. This region, which is watered by the Upper Volga, the Mologa, and the Sheksna, is an undulating plain, the highest points of which, close to Bejetsk, reach 700 feet above the sea-level, gently sloping east and west to a level of from 350 to 420 feet. It has been dealt with first on account of a series of geological explorations which have already been made within its limits. It was visited by Blasius, Murchison, Keyserling, and Barbot-de-Marny, and careful explorations have been undertaken during the last few years within the limits of the province of Yaroslav, under the direction of its Provincial Assembly and Statistical Committee, by MM. Schurovsky, Piktorsky, Eremeyeff, Dittmar, Kryloff, and Nikitin.

The map, which has been prepared by M. Nikitin, is very carefully printed, and will be the more welcome to European geologists as all important names and explanations are given in French, side by side with the Russian text. The colours and the explanatory letterpress are in conformity with the recommendations of the International Geological Congress. A quarto volume, in Russian, by M. Nikitin, with plates and drawings, accompanies the map, the whole being summed up in German at the end of the volume.

The first thing which strikes one on looking at the map is the very great space covered with the gray colour of the Quaternary deposits. A greenish patch of Jurassic rocks in the middle of the map, several patches of Trias on its borders, and a very small Carboniferous patch, altogether hardly cover one-third of the surface; the remainder representing the "Boulder Clay, which conceals deposits of unknown age." The thick sheet of Boulder Clay will be for a long time the stumbling-block of Russian geologists. Natural sections are found only on the banks of the greater rivers, while the valleys of the smaller ones, to their very bottom, are cut through Quaternary deposits. Even the two railways that cross the space covered by the map have been laid without excavations of any importance to the geologist; and no artificial excavations worthy of notice are to be found in the whole area.

As to the geological description which accompanies the map, it is full of interest. The Carboniferous deposits which are denuded over a very limited space in the north-west, belong to the Upper series, characterised by *Spirifer mosquensis*. They probably extend throughout the region in nearly horizontal strata gradually inclined towards the east; but they are concealed by the Variegated Marls which are the subject of so lively a controversy among Russian geologists, and which are considered by the author as belonging to the Trias, contrary to the opinion of the Kazan geologists, who consider them Permian. Although appearing on the surface only in isolated islands, these Marls probably also extend throughout the Yaroslav region; the salt-springs at least, which appear at many places, and which usually take their origin, in Russia, either in the Devonian or in the Variegated Marls, seeming to indicate a great extension of these deposits. The Jurassic formations appear now (as throughout Middle Russia) only as sporadic islands, which are remains of a widely-extended strata destroyed by denudation; the Jurassic sea, according to the author, extending at least as far north as the latitude of Tver. The Jurassic deposits, which have been, like the Variegated

Marls, the subject of special monographs by M. Nikitin, are represented in the Yaroslav region; the lower ones by the Callovian and the Oxford Clay, the two chief subdivisions of the former being characterised respectively by *Cadoceras Milashevici* and *Quenstedioceras Leachi*, and those of the latter by *Cardioceras cordatum* and *C. alternans*. The Upper Jurassic is represented by the "Volga Series," Lower and Upper, respectively characterised by *Perisphinctes virgatus*, *Oxynoticeras fulgens*, and *Olcostephanus subditus*. They are invariably covered with a sheet of sands (like the Jurassic of Central Russia), which seems to have been a littoral deposit accumulated during the retreat of the Jurassic sea.

A very interesting chapter is devoted to the Quaternary deposits of Yaroslav and Central Russia. The thick sheet of Boulder Clay which covers Central and North-West Russia, and contains erratics from Finland and Olonetz, as also from those regions which the erratics had to cross on their way from the north, has long been a puzzle to Russian geologists. Within the limits of the map, it appears with its usual characters, that is, those of a layer 8 to 10 m. thick, spread without interruption over the country—over the watersheds as well as the valleys—without any traces of stratification or even of striation by water: the thickest boulders and the finest particles appearing closely mixed together without bearing any traces of sorting by water-currents. As to the boulders, they are of all possible sizes, from a grain of quartz to masses 2 and 3 m. in diameter. While crystalline rocks and schists from Finland and Olonetz are prevalent, local boulders—Carboniferous and sometimes Jurassic—are also not absent, especially in the lower strata. The boulders have a tendency towards a disposition in ridges which run from north-west to south-east, crossing the rivers, or rising sometimes in the shape of moraines, or eskers of great size. A sheet of boulder-bearing sand, with traces of stratification, appears at many places beneath the Boulder Clay, which passes also in its upper parts into an unstratified sand with boulders.

Such being the character of these deposits, it is obvious that the theory fails which tries to explain them by floating ice, as does also Prof. Trautschold's theory of "Eluvium." The author accepts, therefore, the theory now generally adopted by geologists, and specially advocated for Germany by Berendt, Penck, and Bernhardt, and for Russia by P. Krapotkin, and considers the Russian Boulder Clay as an equivalent of the *Krosstenleva* of Sweden. Like the British Till, it is no doubt the bottom-moraine of the great ice-sheet which covered Northern Germany and Russia, without reaching the Ural Mountains, during the ice-period. This period succeeded to a relatively mild climate, when the plains of Moscow were covered with thick oak and maple forests, inhabited by the mammoth and the rhinoceros, which were compelled by the ice-sheet slowly advancing from the north-west to emigrate east and south. The Loess of Southern Russia, and the Loess-like deposits of the intermediate region, were probably contemporary with the glaciation of the north.

Another chapter is devoted to the formation of rivers in European Russia, and to the great processes of denudation in the later parts of the Quaternary period. This subject has been keenly discussed of late by Russian geologists. The author is to be congratulated on the scientific manner in which he has laid the basis for a discussion of the three important questions—as to the Variegated Marls, the Boulder Clay, and the more recent alluvial deposits—with which he has had to deal in this first fascicule of the Geological Survey of Russia.

## EARTHQUAKES

THOSE observers who have undertaken the detailed study of a region severely injured by an earthquake are well acquainted with the difficulties that attend on

<sup>1</sup> "General Geological Map of Russia." Sheet 56, Yaroslav, &c. by S. Nikitin. (Memoirs of the Geological Committee, vol. i. No. 2.) St. Petersburg, 1884.)

such a perilous and unthankful work as examining the ruins. The necessity is soon felt for some means of accurately registering the various characters of the earth's movement. The imperfect record of the features of an earthquake afforded by broken walls, fissured roofs, and overturned objects is dependent upon a variety of causes.

1. The earthquake consists of a series of movements that do not radiate from a mathematical point, or even from the focal cavity, with perfect uniformity.

2. The group of disturbances which constitute a shock (of variable duration) may not arise from the same point, as, for instance, in the rending of a fissure in an upward direction, the first impulses would be derived from a much lower point than the last.

3. The great variation in the physical qualities of the rocks traversed, dependent upon their composition, intimate structure, and mode of arrangement. Also we may here include the irregular conformation of the surface.

4. The want of homogeneity and of regularity in the structure of houses and walls, and also the presence of door and window openings.

5. The presence of old fissures in buildings, either the result of displacement, shrinkage, or former earthquakes.

Were it possible to construct absolutely perfect instruments for registering the complex movements of an earthquake, we should be able to exclude the two important causes of error coming under the heads (4) and (5), but the others can never be removed, unless that under head (3) might be so by a complete knowledge of the subterranean geology of a district in question—a far from easy matter.

After perusing the recent paper by Prof. J. A. Ewing on "Measuring Earthquakes" (NATURE, vol. xxx. pp. 149 and 174), one might despair of ever understanding the complex tracings the author obtained. A more careful consideration of the subject would seem to help us out of the difficulty to a considerable extent in so far as theoretical reasons will permit us, and it is not till suitable seismographs have been fairly tried in other districts than the unsuitable alluvial plain of Yeddo that we shall learn whether there is any practical use in instrumental observation of earthquake movements.

In an alluvial plain like that of Yeddo, reposing as it probably does on the irregular surface of different but more elastic rocks, from which are transmitted to it the vibrations, the condition is such that a number of waves would be reflected and refracted so as to meet each other at various angles interfering with each other and producing very complex results on any pendulum instrument.

I am personally neither acquainted with the geology of the region in question nor with the type of disturbances constituting its earthquakes, yet from descriptions of the latter one would feel inclined to regard them as the tail-end movements of powerful shocks far below the surface, conditions highly favourable to complexity from reflection and refraction. Besides, the incoherent alluvium, often water-logged, is subject to a remarkable disturbance when vibrations are communicated to it from without, as may experimentally be illustrated by spreading jelly, or, better, mud, over the irregular surface of a piece of wood and tapping with a hammer.

These remarks may at first sight appear beyond the question, but we must not leave the subject without further trial. Any one who has studied the injuries resulting from destructive earthquakes such as that of 1857, described in Mallet's classical memoir, or of those of 1881 and 1883 in Ischia, cannot but be struck with the regularity of the injuries when the observer carefully excludes the large number of modifying influences, as heterogeneity in structure of buildings or the surface configuration of the point in question.

The following instruments were suggested by the study of the two great Ischian earthquakes, and with suitable modifications might be made appropriate to study small or great shocks as the case might require. The use of a

pendulum as the main part of the mechanism has many objections, which have often been pointed out, and I think that future investigations will strongly confirm such opinions. Nevertheless I have given examples where the pendulum may be used, or replaced by other methods employing the same type of registering apparatus (Fig. 1).  $a$  is a pendulum with preferably a pear-shaped bob of great weight, which has attached to its lowest point a strong plaited thread of dentist's silk,  $e$ , which passes through a perforated glass plate,  $d$ . The hole in the glass plate is smoothly drilled of the exact size of the silk thread, so as to allow it to run easily but no more; it has its lip smoothly rounded off so that a section of the edge (see  $d'$ ) is semicircular. The glass plate is firmly gripped by the horizontal metal plate  $c$ , which is rigidly fixed to the supports  $b$ , which in their turn are embedded in a solid masonry or rock basement. The silk thread is connected by a light wire cage,  $f$ , to the cylinder  $g$ , which slides easily up and down the fixed triangular column  $h$ . The cylinder  $g$  is connected to the writing arm lever  $i$ , which

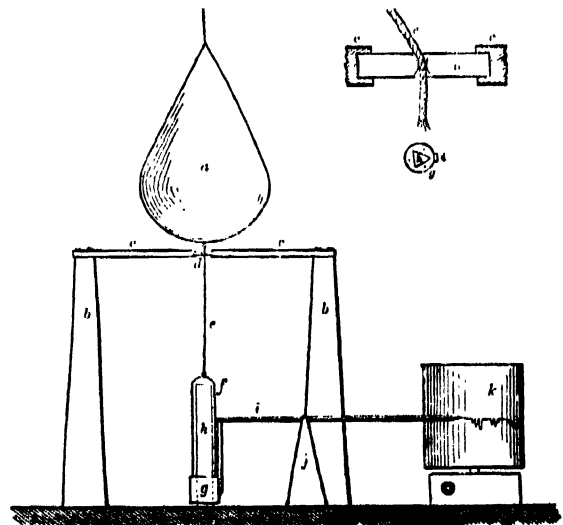

FIG. 1.—Pendulum apparatus to register amplitude of wave continuously.

may be short, and write directly on the recording drum  $k$ , being then a simple stylus, or, as in the figure, arranged to magnify the amplitude two or more times at choice.

When any earth-movements take place, the relative horizontal swings of the pendulum are converted into vertical movements of the silk thread, cylinder, and stylus, which on a time-ruled recording sheet will give accurate amplitude tracing minus the friction of the apparatus, which, if well constructed and the pendulum proportionally very heavy, may be excluded. By using a heavy pendulum with short suspension we may measure oscillations of short period, or, by using a long suspension and a delicate apparatus with greatly magnifying lever, this apparatus might be a useful tromometer, or measure of slow earth oscillations or tiltings (Fig. 2).

Three solidly-fixed cast-iron uprights,  $a$ , support a circular massive cast-iron plate,  $b$ , which has a conical aperture at its centre. Resting upon this is a circular sheet of plate-glass drilled at its centre in the same manner as the silk thread perforation in Fig. 1, as it serves a similar

purpose. This glass plane must be perfectly horizontal. A circular disk of lead, *g*, is inclosed between glass planes, *d*, and rests on three perfect spheres, *f*, which should be preferably of glass or ivory. Rigidly attached at its centre on the lower side is a conical spire, *m*, whose point reaches just the level of the glass plane *c*, and has fixed to it the silk thread *n*. From the centre of the upper side

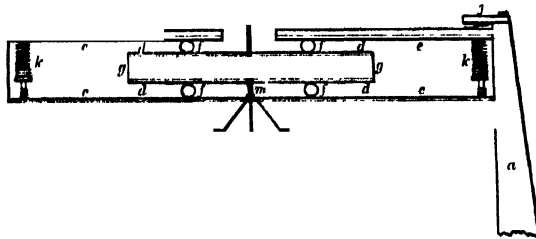

FIG. 2.—Ball and plane seismograph for indicating amplitude and azimuth in all phases of a shock.

projects the steel stylus *o*, bearing a fine platinum wire at its extremity, which may be used with the double azimuth circle of Fig. 3 in a direct manner in case of large earthquakes, or by a lever supported in gimbals, as also in Fig. 3. Another glass plane, *c*, with a large circular aperture at its centre for the free movement of the azimuth stylus *o*, has a wrought iron trellis work backing *h*. This reposes on the springs *k*, which are regulated by the

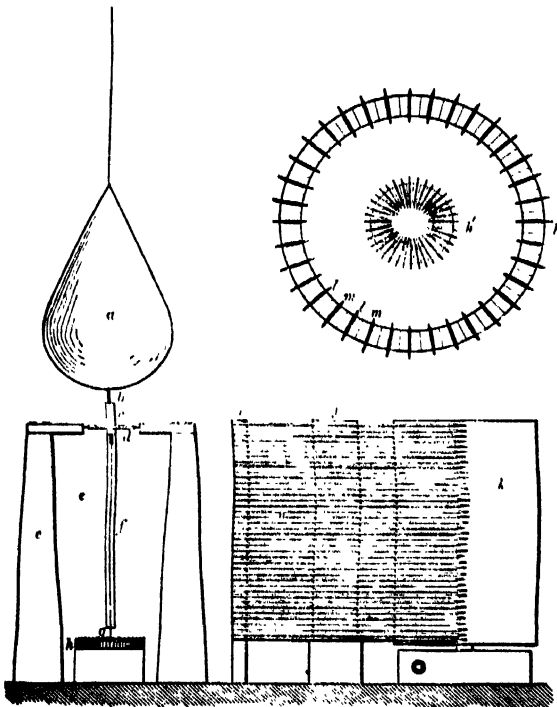

FIG. 3.—Azimuth register of wave path in all phases of an earthquake.

milled-head screws *l*, so that it is only pressing sufficiently on the upper balls *f* to keep them in place. The upper springs *i* are introduced to allow slight freedom of motion to prevent breakage of the plates in almost vertical shocks or from the expansion of the lead disk, balls, &c. The silk thread is connected to the registering apparatus in the same manner as in Fig. 1, the slight weight of which will tend to draw back the rolling lead disk to its central

position, and so prevent it shuffling out of its place, and yet have almost no effect in modifying the register of the absolute wave amplitude.

In working over an earth-shaken district of small area, such as that of Ischia, an error of observation of azimuth of even a few degrees matters little in determining the exact position of the epicentre. But on the contrary, in large areas such as the Neapolitan earthquake of 1857, and to a far greater extent in widespread disturbances such as the great Lisbon catastrophe, an error of a few minutes of a degree is sufficient to produce great divergence in the orientation of the azimuth and a consequent incorrectness in the location of the epicentre. In most seismographs so far employed, especially those of Italy, no attempt has been made to divide the circle into eight divisions, so that an error of nearly 45° could occur.

Fig. 3 represents a separate apparatus, although it would probably in practice be found preferable to replace the pendulum by the rolling disk and balls as already mentioned when describing Fig. 2, except that the contact rings *h* would then be inverted. A pendulum, *a*, with a

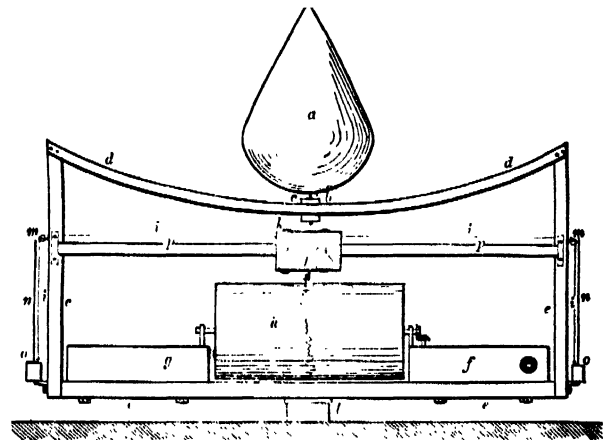

FIG. 4.—Horizontal component of wave-path register for strong and destructive earthquakes.

length of suspension suitable to circumstances of observation, carries a steel spring wire, *b*, which slides in the cylinder *c*, which, together with the light wire arm *f*, forms a universal lever moving about the fulcrum at *a*, which are gimbals. This lever should be so balanced that, if placed in a horizontal position, the part above *d* should counterpoise the part *f*. The lever carries a fine platinum wire, *g*, which, when at rest, is the centre of the two contact circles *h*, *h'*. This part of the mechanism is in connection with one pole of a battery.

The contact circles *h*, *h'*, consist of a suitable number of brass segments, *l*, which have a V-shaped groove on their upper surface, and the edges, both inner and outer, are bevelled off. Each one is insulated from its fellow by the vulcanite plates *m*, which project a little on the inner, upper, and outer sides, and are sharpened to a knife edge.

The registering apparatus consist of a number of long soft-iron spring styles bolted to the column *i*, with their

points near the revolving register cylinder  $k$ . A pile of electro-magnets,  $j$ , each of which is in connection with the two corresponding segments of the two contact circles and the battery, when the current passes, draws one soft-iron spring style towards its poles, and brings the point  $n$  in contact with the cylinder  $k$ . The pendulum might be made to act directly on the contact circles without the magnifying lever  $c$ , if thought necessary, and the breadth of the outer circle might be greater and give a correspondingly longer dash so as to distinguish those derived from the two circles.

It will be seen that the most complex movements of the pendulum or rolling disk can be accurately registered, since four contacts will be marked in each semiphase of the oscillation of the pendulum, and a fifth point can be obtained by calculation from the instrument for registering amplitude, which, together with the position of rest, will give sufficient data to obtain the loops for each semiphase throughout the disturbance.

In large earthquakes where the wave-amplitude is very great, the rolling disk and balls would require to be of very great size, which in many cases it might be impracticable to carry into execution, although the results might be of great perfection in so doing. The present instrument (Fig. 4) is intended to replace the rolling disk where that cannot be used of sufficient size.

A strong rectangular frame,  $c$ , carrying two strong uprights at its two extremities, is made so as to rotate with great facility around the vertical axis  $l$ . It supports the registering drum  $h$  with the clockwork arrangement  $f$  and a counterpoise,  $g$ . In practice it might be found advisable to attach these beneath the frame and so lower the centre of gravity of the whole apparatus. At a suitable distance above the drum a crossbar,  $p$ , is attached, which should be highly polished and square in section. The weight  $j$  should be made very heavy, and be allowed a very easy motion by means of four pairs of wheels,  $k$ , which are in contact with the crossbar  $p$ ; these might be mounted on friction wheels (not shown in diagram). Attached on both sides of the weight are the silk threads  $ii$ , which traverse the upright, run over the pulleys  $m$ , and are attached to the weights  $oo$ , which are only heavy enough to draw the weight  $j$  back to its place when it has been disturbed, that is to say, only just sufficient to overcome the friction of the wheels  $k$ . These weights,  $oo$ , are traversed by the guide wire  $u$  to prevent them dangling about during the swinging round of the frame.

The upper part of the frame carries two parallel bars,  $d$ , between which is a narrow groove to allow of the sliding of the plate  $c$ . They form the segment of a circle whose radius is equal to the length of the entire pendulum and its suspension. The pendulum  $a$  has fixed rigidly to its inferior extremity the steel axle  $b$ , which passes through the rectangular flat block  $c$ , which is prevented from slipping off by a bolt-head below, so that the flat block can rotate around the axle without falling off.

The action of the apparatus is as follows:—When an earth movement takes place the whole apparatus is brought into the azimuth of the wave-path by the oscillations of the pendulum  $a$  in that direction, which is affected by the block  $c$  sliding in the groove between the bars  $d$ . The pendulum should, in preference, have a short suspension, so that the period of its oscillations should be less than the wave intended to be registered by the apparatus, and should possess sufficient weight to have complete command over the frame, keeping it always in the wave-path azimuth. The weight will now appear to slide backwards and forwards on the bar  $p$ , registering its movements by the writing stylus, attached beneath it, on the drum  $h$ . The moment that  $j$  is moved from its central position one of the weights  $o$  is raised from its position of rest (these weights should preferably be hollow brass boxes into which only sufficient fine shot could be poured to overcome the friction of  $j$ ), and rises as long as  $j$  continues to

roll along the bar; if then the second half of the semiphase is not sufficient to bring it back to its normal position this will be done by  $o$ . When  $j$  has reached its central position,  $o$  will have come to rest at the base of the guide wire, and so no longer has any action, but is replaced in the second semiphase by its fellow of the opposite side. Of course the influence of the counterweights in retarding the rolling mass must be experimentally tried and taken into consideration in the calculations made from the tracings.

The principle of this instrument is the acceleration and retardation of a falling body during each semiphase of an earth-wave. Fig. 5 illustrates a means of registering such changes in the rate of a falling body so acted on, although some other person better acquainted with mechanical movements might possibly suggest some improve-

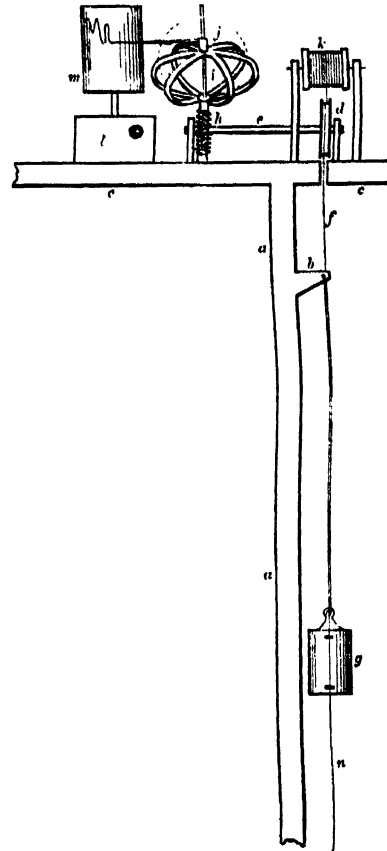

FIG. 5.—Apparatus for registering the vertical component of earth-waves during the whole of the disturbance.

ment. A rigid vertical support of considerable length,  $a$ , is attached to the side of a well and is connected at its upper end to the table  $c$ ; and by a small bracket  $b$  two vertical guide wires,  $n$ , pass through rings in the sides of the weight  $g$ , so far resembling Morin's apparatus illustrating the falling of bodies. Attached to the weight  $g$  is the silk thread  $f$ , which turns once or twice around the wheel  $d$ , and is supplied from the drum  $k$ . The wheel  $d$  is connected by the axle  $e$  and the continuous screw  $h$  to the apparatus  $i$ , which is a skeleton of flat steel springs, generally used to illustrate the distortion of a sphere by centrifugal motion. (I have proposed this in preference to the *ball governors* as retaining less impressed energy, which would unnecessarily complicate and even modify the results.) Sliding on the central axis of the spring sphere is a small cylinder,  $j$ , which is prevented from

rotating by means of a ridge on its inner surface and a corresponding groove on the upright bar. This cylinder carries the writing arm and stylus, which registers on the cylinder the rising and falling of the former;  $l$  is the motive power of the cylinder  $m$ . The apparatus for detaching the falling weight  $g$  is not shown in the diagram, but might be of the following arrangement:—A bob suspended by a spiral spring is made to make contact with a cup of mercury, as in the old form of vertical seismometers, besides a small lever of the first order attached at one end to the bob, the other extremity being above another cup of mercury. In this way, whether the movement of the bob be either up or down, in relation to the mercury cups, contact will be either made in the first case through the lever, or in the second directly by the bob. The current thus established could be used by an electromagnetic apparatus for removing a catch which holds the weight  $g$ . It could also start the cylinder  $m$  and stop a clock. The diagram will sufficiently explain the action of the apparatus.

If we review the advantages and disadvantages of the different instruments, I venture to say that, though far from perfection, they have much to be said in their favour. Their principal feature is the capability of registering continuously all the variations of the earth's movement during the complex disturbance known as an earthquake; that by employing large tracing drums with a spiral arrangement and time-ruled paper, accurate time-records can be obtained for a considerable period and without interruption, so that a single observer could have under his command a large number of instruments, even at stations some considerable distance apart, thus resulting in much economy of trained observers. Then again the records are all permanent, being graphically inscribed. The instruments for registering azimuth and amplitude, and capable of doing so with the greatest delicacy and friction, in all cases can be reduced to a minimum, or easily calculated. With regard to the registration of the vertical component of an earth-wave, the old form of spiral spring and bob principle may be excluded from consideration as perfectly unreliable; and even the improvements by Messrs. Milne and Ewing, and the ingenious idea of Mr. T. Gray, with its mercury trough compensator, cannot give accurate indication of the characters of a group of earth-waves. Another instrument worthy of trial is the hydrometer vertical-motion seismograph of Mr. T. Gray (*Phil. Mag.*, September 1881, p. 209). I think, however, that this instrument might be improved by using a long thin glass tube filled with air and floating in ether or some other fluid of very low viscosity. I would, however, venture to predict that a seismometer based on the principle of a falling weight, being accelerated or retarded according as the earth moves up or down, will supersede other methods, although no doubt such means of registering as described in this paper may be greatly improved upon.

The instruments described in this paper are all of considerable size, but it seems impossible to get good results unless heavy weights and their attendant mechanisms are used so as to reduce friction to a minimum in the consideration of results; for it is certainly a pity to have imperfect results in consequence of limiting the size of the apparatus. One great objection to the falling weight seismometer is the necessity for a deep well, to give sufficient time to register an earthquake of ten or twenty or even more seconds' duration; yet, by giving the weight more work to do by the introduction of multiplying wheels, this might be reduced as the circumstances might demand.

These instruments and the remarks on them are the outcome of long meditation while wandering over the ruins of two great earthquakes, and although expressed without a technical knowledge of mechanical construction, I hope I have made my ideas sufficiently clear.

H. J. JOHNSTON-LAVIS

## INTERNATIONAL WEIGHTS AND MEASURES

IN inviting attention to the work done at Sèvres during the past year by the Comité International des Poids et Mesures,<sup>1</sup> we are glad to have the opportunity of congratulating those interested in accurate measurement on the fact that this country is now to be represented on the Committee, and will thus have a voice in their discussions. This, as we have pointed out on previous occasions, appears to be required of a country so largely interested in scientific research as ours.

### METRES

Description of Standard	Error in terms of the true standard metre (1 $\mu$ ,—6 $\mu$ )	Mean coefficient of dilatation, $\alpha$ ° to $t$ ° C.
Standard I <sub>1</sub> , which serves as the provisional standard of the Comité until the final prototype is verified	+ 6 $\cdot$ 00	10 $^{-9}$ (8594 $\cdot$ 6 + 1 $\cdot$ 26 $t$ )
Standard I. for the use of the Bureau	+ 76 $\cdot$ 04	10 $^{-9}$ (8602 $\cdot$ 9 + 2 $\cdot$ 09 $t$ )
Standard II. for the use of the Bureau	+ 80 $\cdot$ 61	10 $^{-9}$ (8569 $\cdot$ 1 + 2 $\cdot$ 79 $t$ )
Standard III. for the use of the Bureau	+ 14 $\cdot$ 53	10 $^{-9}$ (8560 $\cdot$ 0 + 1 $\cdot$ 63 $t$ )
Standard XIII., belonging to French section of the Comité	+ 3 $\cdot$ 05	10 $^{-9}$ (8540 $\cdot$ 6 + 2 $\cdot$ 62 $t$ )
Bronze subdivided Standard N belonging to the Comité	48 $\cdot$ 58	10 $^{-9}$ (17483 + 7 $\cdot$ 07 $t$ )
Brass Barometer-Standard T <sub>1</sub> belonging to Comité, constructed by Société genevoise pour la Construction d'Instruments de Physique	- 7 $\cdot$ 2	10 $^{-9}$ (18178 + 7 $\cdot$ 9 $t$ )
Brass Barometer-Standard T <sub>2</sub>	- 31 $\cdot$ 6	10 $^{-9}$ (18213 + 7 $\cdot$ 2 $t$ )
Brass Barometer-Standard T <sub>3</sub>	- 0 $\cdot$ 5	10 $^{-9}$ (18037 + 4 $\cdot$ 7 $t$ )
Brass Barometer-Standard constructed by Messrs. Hermann and Pfister, P...	- 149 $\cdot$ 3	10 $^{-9}$ (18821 + 8 $\cdot$ 4 $t$ )
Platinum Standard for Spain originally constructed by Froment with lines traced by J. Alfonso, Secretary to Standards Commission at Madrid, E	+ 4 $\cdot$ 95	10 $^{-9}$ (8898)
Iron Standard of the United States Government made by Repsold, US	+ 97 $\cdot$ 8	10 $^{-9}$ (10563)
Standard for Office of Weights and Measures at Vienna, II <sub>A</sub>	+ 14 $\cdot$ 1	10 $^{-9}$ (18708 + 3 $\cdot$ 00 $t$ )
Standard for Office of Weights and Measures at Vienna, A <sub>A</sub>	- 8 $\cdot$ 9	10 $^{-9}$ (17971 + 3 $\cdot$ 15 $t$ )
Iron Standard of Société genevoise, F	- 31 $\cdot$ 4	10 $^{-9}$ (11063)
Brass Standard of Société genevoise, L	- 62 $\cdot$ 6	10 $^{-9}$ (19155)
Bimetallic Standard for French War Department, constructed by Porro—		
Brass, C	- 111 $\cdot$ 8	10 $^{-9}$ (18699)
Steel, A	+ 31 $\cdot$ 1	10 $^{-9}$ (10420)
Copper Standard for M. Tresca, Cu	+ 10 $\cdot$ 7	10 $^{-9}$ (16334 + 5 $\cdot$ 82 $t$ )
Green Glass Standard made by M. Baudin for thermometric purposes, V	+ 128 $\cdot$ 2	10 $^{-9}$ (8392 + 4 $\cdot$ 8 $t$ )

<sup>1</sup>Travaux et Mémoires," tome iii. 400 pages. (Paris: Gauthier-Villars, 1884.

## KILOGRAMMES

	mgr.	mgr.
International kilogramme K <sub>I</sub> belonging to the Bureau ...	—	—
International kilogramme K <sub>III</sub> belonging to the Bureau ...	K <sub>I</sub> —K <sub>III</sub> = - 0'1232 ± 0'0026	
Kilogramme-type C belonging to the Bureau ...	C—K <sub>III</sub> = + 0'3217 ± 0'0034	
Kilogramme-type S belonging to the Bureau ...	S—K <sub>III</sub> = + 0'4632 ± 0'0034	
Standard kilogramme H for Spain ...	H—K <sub>III</sub> = - 1'8762 ± 0'0034	
Standard kilogramme Z for Austria ...	Z—K <sub>III</sub> = - 1'3501 ± 0'0034	

The present volume, like its two predecessors, is published by the Director of the Bureau under the authority of the Comité, and contains some account of the modes of comparison of the standards, with descriptions of the apparatus used, and a complete statement of the observations and of the methods of their reduction. The work of the Bureau has mainly included determinations of the lengths of certain standard metres and of the weights of certain standard kilogrammes for different Governments and authorities, as shown in the above tables.

These tables do not include the important comparisons of the British Standards with those of the Bureau, an account of which is given in a Report presented to Parliament by the Board of Trade last year, and in the Report of the Proceedings of the Committee for 1883.

The comparisons of the metres by Dr. René-Benoit, and those of the kilogrammes by M. Marek, were made in the same manner and after the same methods as those described in vols. i. and ii., to which we have previously referred.

M. Marek gives a thoughtful description of the excellent normal barometer and cathetometer in use at the Bureau, as well as of the methods of calibrating the thermometers used during the weighings. There are also illustrations of the apparatus used in ascertaining specific gravities, and of M. Stas's method for clearing the surfaces of metals by a jet of alcohol vapour, of which we regret that the demands on our space do not allow an account.

The many pages of observations and calculations which are given in this volume are clearly arranged and carefully printed. We doubt, however, whether it may be desirable to publish so much detail, particularly all the observations of the balances. Each Report of verification should evidently include all the observations, &c., from which the results have been obtained, but it would appear to be necessary only that the Government or authority directly interested should be furnished with a full detailed Report. Economy of time and money might be effected by readers and purchasers, and perhaps the objects of the Comité further advanced, by the omission in such publications of any unnecessary detail.

## NOTES

THE Washington Prime Meridian Conference has adopted a resolution declaring the universal day to be the mean solar day, beginning, for all the world, at the moment of mean midnight of the initial meridian, coinciding with the beginning of the civil day, and that meridian to be counted from zero up to twenty-four hours. The resolution further declares that the Conference expresses the hope that, as soon as practicable, astronomical and nautical days may be arranged everywhere to begin at mean midnight. Prof. Janssen, of France, moved that the Conference should express the hope that technical investigations to regulate and extend the application of the decimal system to the divisions of the circle and of time would be encouraged, in order to permit of the extending of that application to all cases where it might present real advantages. The

motion was adopted, and the Conference adjourned until Wednesday.

M. BERTRAND, the Perpetual Secretary of the Paris Academy of Sciences in the Mathematical Section has been proposed as a candidate to fill the place vacated by the death of M. Dumas in the Académie Française. His nomination is certain, and will take place without opposition. It is almost customary for the Académie Française to offer a seat to one of the secretaries of the Academy of Sciences; Delambre, Fourier, Flourens, Cuvier, and Dumas enjoyed this honour in succession. Arago was offered it several times, but obstinately refused it. He strictly adhered to the old constitution of the Institut National as created by the Directory of the First Republic, which states that the five sections constitute the several parts of a living encyclopædia established to deliberate *in common* on many different questions, and that consequently no member of one section should be eligible to another. When the Restoration took place, the Institut was divided into independent academies, and the old practice of electing a person to several of them was revived. It has not been altered since 1848, although several attempts have been made in order to recall into existence the former republican organisation.

ON the night of Saturday, October 4, some interesting observations of lunar coronas and fog-bows were made at Ben Nevis Observatory. The mountain-top had been enveloped in mist for several days previously, but about 9 p.m. it began to clear, and by 11 o'clock the moon, partially eclipsed, was visible, surrounded by a strong double corona; all the colours from red to blue being seen in both rings. Measurements of these were taken by Mr. Dickson, Interim-Superintendent, with an instrument designed for the purpose by Prof. Tait. These gave:—Outer diameter of red—outer ring, 7° 46'; inner ring, 4° 52'. After midnight the sky became quite clear and the moon shone brightly, no corona being visible. At times, however, detached portions of very thin mist came up the north-west side of the mountain and brushed over the top. Whenever this occurred a strong corona again surrounded the moon, with a *third* set of rings, outside the other two, and much fainter, but sufficiently bright to allow of all the colours being distinguished. At 1.30 a.m. on October 5 the outer set of rings was more distinctly marked than before, and measurements were again taken. These gave:—Outer diameter of red—inner ring, 4° 6'; middle ring, 6° 2'; outer ring, 8° 10'. All these measurements are subject to an error of not more than ± 6'. At 1.15 a.m. a lunar fog-bow was visible on a fog bank to the northwards. From the edge of the precipice to north-east of the Observatory this appeared to consist of an outer ring, having a diameter of 75°, and an inner and fainter ring, diameter 65°, the space between the rings appearing almost quite dark, as if caused by a sharply-defined break in the fog. No colours could be distinguished.

FROM the *Alla California* we learn that the Lick Trustees have just received, through the kindness of Capt. Goodall, of the firm of Goodall, Perkins, and Co., important advices from Paris in regard to the glass disk which is needed to complete the 36-inch equatorial for the Lick Observatory. It will be remembered that the contract for two disks—one of flint and the other of crown glass—which are needed for the construction of an achromatic objective, was let to the celebrated firm of Alvan Clark and Sons in 1861. There were only two firms in the world who were capable of making glass disks of such size, nearly 40 inches in diameter. The Clarks employed one of these, Messrs. E. Feil and Co. of Paris, to cast the rough disks for them. The flint disk was cast in an unexpectedly short time, but the making of the crown glass disk has proved to be a matter of great difficulty, and this alone will have delayed the making of the large objective, and thus the completion of the Lick Obser-

vatory, by several years. The Lick Trustees will have all the Observatory, excepting the large telescope and the dome to contain it, finished and ready for work during 1885. As soon as two perfect disks of crown and flint glass are on hand, the focal length of the telescope can be calculated, and the size of the great dome determined upon; and nothing can be done until this focal length is known. Nineteen trials have been made by the Messrs. Feil to cast a perfect crown disk, and a delay of more than two years has been incurred through the difficulties and risks of the operation. It appears from the letter of Capt. Goodall to Capt. Floyd, which has been referred to, that Messrs. Feil have cast two disks, which they expect to be suitable for the purpose. The Captain visited their works early in September, and they were expected to ship one of the disks to Clark and Sons early in October. There is then reason to believe that the rough disks for the large telescope will soon be in the hands of the optician. The successful working of these disks into the proper curve for a perfect object-glass is a matter of the greatest difficulty, but the extraordinary skill which the Clarks have acquired leave no doubt that within two or three years after the receipt of a perfect disk the whole 36-inch objective (the largest possible) will be finished. While the objective is making, the dome and the mounting can be constructed, so that the whole delay is and has been due to the difficulties incident to the opticians' work. The work on Mount Hamilton has progressed as far as possible under the present conditions, and it will not be long before California possesses the most perfect observatory in the world, placed in the most favourable situation which can be found.

THE recent works of the United States Geological Survey, and especially the remarkable report of Capt. Dutton, have given an opportunity to Prof. Trautschold of Moscow, to draw a parallel between the geological structure of Colorado and that of European Russia, which appears in the *Bulletin* of the Moscow Society of Naturalists. In Russia, the Silurian, Devonian, Carboniferous Limestone, and Lower Permian series are marine deposits, while the Upper Permian is of fresh-water or terrestrial origin. The Trias and Lower Jurassic rocks are also continental deposits,—or seem to be so to a great extent,—while the Upper Jurassic groups are again of marine origin, as is also the Chalk, which contains only islands with land-vegetation. Three parts of the Tertiary series consist of terrestrial and fresh-water deposits, marine deposits appearing only in the south; and the Quaternary is also a continental formation. Such being, according to Prof. Trautschold, the structure of Russia, he had already concluded that in the Northern Hemisphere there was a general retreat of the sea during Palæozoic times, and a growth of continents, upon which the Carboniferous and then the Permian floras largely increased, European Russia being, during the Triassic and the first half of the Jurassic periods, a continent with nearly the same outlines as now. During the second half of the Jurassic period, another subsidence of the continent, and an advance by it into the Northern Hemisphere, again took place, without reaching, however, the same level that it had had during the Palæozoic period; the sea remaining shallow. A second retreat of the water took place during the Tertiary and Quaternary periods. Similar oscillations might well explain, in Prof. Trautschold's opinion, the structure of the Grand Cañon district, where the connection between the Jurassic and Triassic is as close as in Russia.

THE next ordinary general meeting of the Institution of Mechanical Engineers will be held in the large Lecture Theatre, University College, Shakespere Street, Nottingham, on November 5. The chair will be taken at 4 p.m., by the President, I. Lowthian Bell, F.R.S. The following papers will be read and discussed, as far as time will admit:—On the Mineral Wagons of South

Wales, by Mr. Alfred Slater, of Gloucester; on the Application of Electro-Magnets to the working of Railway Signals and Points, by Mr. Illius A. Timmis, of London; Second Report on Friction Experiments, by Mr. Beauchamp Tower, of London.

THE International Congress convened to deliberate upon the best means of preventing the spread of *Phylloxera vastatrix* was opened on Monday at Turin. Among the personages present were the Duke d'Aosta, Signor Grimaldi, Minister of Commerce, the Syndic of Turin, and the French, Greek, Spanish, Portuguese, Servian, and Roumanian Delegates to the Congress. After a short address of welcome from the Syndic of Turin, Signor Grimaldi explained the object of the Congress, and dwelt particularly upon the necessity of common legislative measures being adopted in all infected countries in such a form as not to interfere with the liberty of trade. It was, however, most requisite to raise barriers to the spread of the Phylloxera.

THE last issue of the *Transactions* of the Seismological Society of Japan (vol. vii. part 1) contains a paper by Prof. Milne on *Earth Tremors*, dealing successively with artificially produced tremors, natural tremors, and at some length with various instruments constructed to record these minute movements. Micro-seismology, by the way, appears to be the name of this new branch of science. The results which have been obtained so far do not appear to be of great importance. The motions are more law-abiding than earthquakes; but it is impossible to say yet whether their systematic study will enable us to foretell an earthquake, although from examples quoted it appears that earthquakes are frequently preceded by great microseismic activity. Nor is the cause of these constant movements understood. Among the theories on this subject mentioned by Prof. Milne is one that they may be due to slight vibratory motions produced in the soil by the bending and crackling of rocks caused by their rise upon the relief of atmospheric pressure. Rossi thinks they may be the result of an increased escape of vapour from the molten material beneath the crust of the earth consequent upon a relief of external pressure. In the same number Dr. Du Bois writes on the great earthquake of Ischia; and a catalogue of earthquakes in Tokio between July 1883 and May 1884, as observed by a Palmieri's seismograph, is also given. From the annual report of the Society we observe that the committee appointed to report on a system of earthquake observations give as their conclusion that the most important observation is that of time, and experiments are now being carried out to obtain a suitable clock for this purpose. The next number is to contain an important paper by Prof. Milne giving a detailed account, with a series of maps, of 387 earthquakes recently felt in Northern Japan.

MR. SPENCE PATERSON, H.B.M. Consul at Reykjavik, writes to the *Standard* that on September 9 he visited Cape Reykjanes, the south-west point of Iceland, in order to observe the volcanic island which recently appeared off that Cape. It was first seen by the light-keeper at Reykjanes on July 29, and had then the shape of an irregular truncated cone, with a slight hollow on the top and a projecting shoulder on the north side. No earthquakes or other volcanic manifestations accompanied its appearance, but on August 5 a series of severe shocks occurred, which split the walls of the lighthouse and damaged the lamps. For several days rain and fog obscured the island; when next seen, its shape had altered; part of the south side had fallen down into the sea, forming two little mounds, and leaving a steep, almost perpendicular face on the south. The height of the island is about two-thirds of its length. It lies about west-south-west of Reykjanes. Two officers of a French war-vessel, who recently visited Reykjanes, estimate its distance from the coast at nine or

en miles, but Mr. Paterson believes it to be considerably reater. When first seen, the upper part of the island was perfectly black, but it has now begun to whiten, owing to the droppings of the myriads of sea-fowl which frequent the adjacent coast and neighbouring islands, and seem already to have taken possession of the new land. The neighbourhood of Reykjanes is noted for volcanic manifestations—islands have from time to time risen and sunk there, and only a couple of years ago a violent eruption occurred near the spot where the new island lies; columns of smoke and steam rose out of the sea, and large quantities of pumice were thrown up and floated ashore on the neighbouring coast.

It is stated that in consequence of the immense success obtained by the opening of the Arlberg Tunnel, France has confidentially sounded the Swiss Federal Council as to piercing the Alps at the Simplon.

A FATAL gas explosion took place in Paris four months ago near the Porte St. Denis, under circumstances quite similar to the accident which took place in Bermondsey last week. Since that time the Prefet de la Seine has appointed a Commission to determine the best manner of searching for gas escapes. An electric lamp fed with a portable accumulator has been selected and rendered obligatory for such operations. This apparatus has been described at length in the French illustrated papers. It might perhaps be improved, but the principle is quite sound, and it is to be regretted that the results of the French experiments have not become known in England.

WE have received a communication from Prof. M. Nyrén, Director of the Imperial Observatory at Pulkowa, near St. Petersburg, informing us that the weather there was so cloudy that not a vestige of the moon could be seen on the occasion of the recent total eclipse. In Helsingfors, where Prof. Nyrén happened to be that night on his return journey from abroad, he could distinguish the darkening of the moon's disk through the clouds, but it was too thick to observe the eclipse of the stars. At Dorpat, the second great Russian Observatory, the weather was also entirely unfavourable for observations. This is greatly to be regretted, in view of the elaborate preparations made by the Russian astronomers, to which we referred last week.

THE Royal Bohemian Society of Sciences will celebrate its hundredth anniversary at Prague on December 6 next.

THE new University building at Vienna was completed on the 11th inst. The new building at Strasburg will be inaugurated on the 26th inst.

THE death is announced of Dr. Robert Ave-Lallemant, well known as a traveller in Brazil, who was born at Lübeck in 1812. He died there on October 10. Also of Dr. Wilhelm Gonnermann, a naturalist who, together with Dr. Rabenhorst edited the celebrated "Mycologia Europæa." He died at Coburg, aged seventy-eight years.

THE French Minister of Public Instruction has commissioned M. Brau de St. Paul Lias to proceed to Malacca and Sumatra for the purpose of making natural history collections. M. Étienne Gautier is to do the same in Persia and Asiatic Turkey; and Dr. Guardia goes to the Balearic Isles to study the dialect there.

THE life of a Ceylon planter appears to be a constant contest with insect pests of one kind and another. A short time since we noticed a correspondence on a "blight" which attacked the tea-plant, and now the Ceylon papers which arrived by the last mail contain a report, by Dr. Trimen, the head of the Botanic Gardens in the colony, on an insect which has caused much alarm by its depredations on cacao and cinchona plantations.

He thinks the only serious damage to cacao comes from the *Helopeltis antonii*, which appears to be a recent importation to Ceylon, although well known in Java. It is believed to be still in small numbers, and to be confined to certain localities, and the only remedy suggested by Dr. Trimen is that the planters should have it carefully sought for and destroyed.

WE are requested to announce that in future the ordinary meetings of the Essex Field Club will be held in the large hall of the Public Hall, Loughton, Essex. The first meeting of the winter session will be on Saturday next, the 25th inst., at seven o'clock.

A SOCIETY has been established at Vladivostok in Eastern Siberia for the purpose of exploring the Amour district, with a view of founding in Vladivostok a museum illustrative of the natural history of the region.

THE additions to the Zoological Society's Gardens during the past week include a Meadow Pipit (*Anthus pratensis*), six Twites (*Linota flavirostris*), a Linnet (*Linota caunabina*), eight Lesser Redpolls (*Linota rufescens*), British, presented by Mr. T. E. Gunn; two Robben Island Snakes (*Coronella phocarum*) from South Africa, presented by the Rev. G. H. R. Fisk, C.M.Z.S.; a Hardwick's Mastigure (*Cromastix hardwickii*) from India, presented by Mr. Cuthbert Johnson; a Moustache Monkey (*Cercopithecus cephus*) from West Africa, a Greater Sulphur-crested Cockatoo (*Cacatua sulphurea*) from Australia, a Blue and Yellow Macaw (*Ara ararauna*) from South America, deposited; six Coypus (*Myopotamus coypus*), three Cockateels (*Calopsitta nove-hollandie*), bred in the Gardens.

#### OUR ASTRONOMICAL COLUMN

WOLF'S COMET.—The observations of this comet to the end of September having been found irreconcilable with parabolic motion, Prof. Krueger, the editor of the *Astronomische Nachrichten*, and Mr. S. C. Chandler, jun., of Harvard College, have investigated the elements by a general method, and find an elliptic orbit of very limited dimensions, the period of revolution being 6.55 years by Prof. Krueger's calculation, and 6.65 years by Mr. S. C. Chandler's. Other elements by the former calculation are as follows:—

Perihelion passage 1884 November 17.8999 G.M.T.

Longitude of perihelion ... ..	19 20 56	} M. Eq. 1884°
" ascending node ... ..	206 35 35	
Inclination ... ..	25 3 54	}
Angle of eccentricity ... ..	33 32 29.7	
Log. semi-axis major ... ..	0.544040	
Log. perihelion distance ... ..	0.194792	

In such an orbit there would be a very close approach to the orbit of Jupiter in about 209° heliocentric longitude, where the distance between the two would be less than 0.12, and with Prof. Krueger's period of revolution there would be great perturbation early in the year 1875, so that it is possible the comet may not have been moving long in its present track. It will be interesting to examine this point further, when the major axis of the comet's orbit has been more accurately determined by a wider extent of observation.

We have thus two comets of short period brought to light in the same year. As regards Barnard's comet the length of revolution appears to be yet somewhat doubtful, Prof. Morrison of Washington assigning 6.43 years, and Dr. Berberich of Strasburg 5.50 years only.

THE NOVEMBER METEORS.—Assuming that these bodies are moving strictly in the orbit of the first comet of 1866, we find by Prof. Oppolzer's definitive elements that the nearest approach to the orbit of Mars is in about heliocentric longitude 0° 5, distance 0.30; the nearest approach to the orbit of Jupiter is in 198° 7, distance 0.79; in the case of Saturn the least distance of orbits is 0.46 at 214° 9; and in that of Uranus 0.37 at 234° 2. In 1866 the comet traversed the plane of the earth's orbit in 51° 4, distant therefrom only 0.0066.



**NEW SOUTHERN DOUBLE-STARS.**—Mr. H. C. Russell, Government Astronomer at Sydney, has circulated a list of newly-detected double-stars, some found by himself with the large instrument, and others by Mr. Hargrave with the 7½-inch equatorial. In most cases the components belong to the tenth and eleventh magnitudes.

**THE TOTAL SOLAR ECLIPSE OF 1816, NOVEMBER 19.**—The first total eclipse of the sun in the present century in which the central line passed over Europe took place on the morning of November 19, 1816. Maps of its track appeared in the *Berliner Jahrbuch* for 1816, and in the first part of Hallaschka's *Elementa Eclipsium*, where the full computation of this eclipse is given as an example. In Lindenau and Bohnenberger's *Zeitschrift für Astronomie*, vol. v., Hagen gives the moon's place deduced from Burckhardt's Tables, with the horizontal parallax and semi-diameter; if we combine these with similar quantities for the sun, taken from Carlini's Tables of 1833, we find the following elements of the eclipse:—

G. M. T. of Conjunction in R. A. 1816 Nov. 18 at 21h. 46m. 57s.

R. A. ... ..	234	42	20
Moon's declination ... ..	18	37	9 S
Sun's " " " " " " " " " " " "	19	30	29 S
Moon's hourly motion in R. A. ... ..	36	58	
Sun's " " " " " " " " " " " "	2	37	
Moon's " " " Decl. ... ..	11	37	S
Sun's " " " " " " " " " " " "	0	38	S
Moon's parallax ... ..	60	15	
Sun's " " " " " " " " " " " "	0	9	
Moon's semi-diameter ... ..	16	25	
Sun's " " " " " " " " " " " "	16	12	

In the *Berliner Jahrbuch* Bode makes the eclipse total at both Dantzic and Warsaw; the above elements do not show totality at either place, but give the magnitudes 0.990 and 0.992 respectively. They indicate, however, a total eclipse at Bromberg, duration 1m. 22s. Possibly there may be other observations of the totality on record, but the only one we have found was made by Hagen at Culm in Bohemia, where he observed its commencement but not the ending. It would appear that the weather at this season was an impediment to observation, or more details of the total phase in its passage over Germany might have been expected. Before the eclipse of July 1842 there was only one in which the line of totality approached near the European continent, viz. that of July 17, 1833, which was total in Iceland; on Mount Hecla the total eclipse commenced at 4h. 56m. 37s. a.m., and continued two minutes, the sun at an altitude of 13°; but the days of physical observations had not then arrived, and we do not find it recorded that a midsummer expedition to Iceland was organised.

### CHEMICAL NOTES

THERE has of late been a considerable amount of work done on the relations between the composition and structure of chemical compounds and various physical constants of these compounds; and also on the relations between the conditions of chemical change and some of the physical properties of the constituents of the changing systems. Among the more important work on the former class of relations are to be mentioned Perkin's researches on the *magnetic rotatory polarisation* of compounds (*E. S. Journal, Trans.* for 1884, p. 421 *et seq.*); and Schiff's researches on the *coefficients of capillarity* of liquid carbon compounds (*Annalen*, cccxiii. 47). The investigations of Raoult on the connections between the freezing-points of solutions and the distribution of the salts therein form an important contribution to the study of the second group of relations (see especially *Ann. Chim. Phys.* (6), ii. p. 66, *et seq.*). Perkin has measured the rotations of the plane of polarisation of a ray of monochromatic (sodium) light, produced by passing the ray through columns of various liquid carbon compounds placed between the poles of a large electro-magnet. Then, by

the use of the formula  $\frac{r \times M}{d}$ , where  $r$  = observed rotation,  $d$  = density, and  $M$  = molecular weight (as gas), of the given compound, he has calculated the magnetic rotatory effect of unit-length of the liquid obtained by condensing unit-length of the vapour of the same liquid. The observed results are thus referred to lengths of liquid related to each other in the ratio of the molecular weights of the various compounds examined.

Each result is divided by the number obtained, by the same method, for water, and the quotient represents the *molecular rotatory power* of the given compound. The molecular rotatory powers of a great many compounds belonging to twenty-six series have been determined, and the results show that the constant in question is closely connected with the valencies of the atoms, and with the distribution of the interatomic actions, in the molecules of the compounds examined. Schiff has made an extended series of determinations of the *coefficients of capillarity*, that is the capillary elevations in tubes 1 mm. radius, of many liquid carbon compounds. By multiplying this constant by the density of the compound, and dividing by 2, another constant is obtained which represents the weight of liquid raised by capillary action through unit-length of the line of contact between the liquid and the containing vessel. Lastly, by dividing the coefficient of capillarity by twice the "molecular volume" (*i.e.*  $\frac{\text{molecular weight of gas}}{\text{density of liquid}}$ ), a quotient is obtained

which represents the relative number of molecules raised along the line of contact between the liquid and solid surfaces. Schiff's results, although very numerous, do not yet allow very definite conclusions to be drawn regarding the connection between the three constants and the molecular structure of the compounds examined; but that a definite connection exists is rendered very probable by these investigations. Raoult has made many determinations of the *molecular lowering of the freezing-point*—that is, the lowering of the freezing-point produced by the solution of 1 gramme-molecule of substance dissolved—of various solvents by acids, bases, and salts. The solvents employed were water, benzene, nitro-benzene, ethylene dibromide, acetic and formic acids. In each case the molecular lowering of the freezing-point is approximately equal to one of two values, of which one is double the other. The acids examined may be divided into two groups as regards their effect on lowering the freezing-point of water. The value of the constant measured by Raoult is approximately 40 for one of the groups, and 20 for the other group. The bases examined likewise fall into two groups; the mean values of the constants being 39 and 19 respectively. Raoult states that the acids with the higher value (40) almost completely displace the acids with the lower value (20) from their combinations with bases, when the acids and salts react in equivalent quantities. The bases of the first group almost completely displace those of the second from their combinations with acids. Measurements of the molecular lowering of the freezing-point of water by the action of acids, bases, and salts, present us with data from which, according to Raoult, the distribution of the various acids, &c., in a changing chemical system may be deduced.

### AMERICAN ORNITHOLOGISTS' UNION

THE second annual meeting of the American Ornithologists' Union was held in the American Museum of Natural History, New York City, September 30 to October 2, 1884, the President, Mr. J. A. Allen, in the chair.

The Active Members present were: J. A. Allen, H. B. Bailey, Chas. F. Batchelder, Eugene P. Bicknell, William Brewster, Montague Chamberlain, Dr. Elliott Coues, D. G. Elliot, Dr. A. K. Fisher, Col. N. S. Goss, Dr. J. B. Holder, Dr. C. Hart Merriam, Robert Ridgway, Thomas S. Roberts, John H. Sage, George B. Sennett, Dr. Leonhard Stejneger.

Dr. Philip Lutley Sclater, Mr. Howard Saunders, and the Rev. E. P. Knubley, of the British Ornithologists' Union, were also present, and were cordially invited to take part in the proceedings of the Union.

The Associate Members in attendance were William Dutcher, Fred T. Jencks, and Dr. Howard Jones.

On the recommendation of the Council the following persons were elected to Foreign Membership:—Heinrich Gätké, Helligoland; Dr. W. Taczanowski, Russia; Henry Seebohm, England; Howard Saunders, England; Dr. H. Burmeister, Brazil.

The following among others were elected Corresponding Members:—Dr. John Anderson, F.R.S., India; W. T. Blanford, F.R.S., London; Major H. W. Feilden, London; Dr. Hans Gadow, England; Col. H. H. Godwin-Austen, London; Dr. Julius von Haast, New Zealand; Dr. E. Holub, Austria; Dr. C. F. Homeyer, Germany; E. L. Layard, New Caledonia; Dr. A. B. Meyer, Germany; Dr. A. von Mojsisovics, Gratz; Dr. A. J. Malmgren, Finland; Dr. A. von Middendorff,

Russia; Col. N. Przevalsky, Russia; Dr. Gustav Radde, Russia; Dr. Leopold von Schrenck, Russia; Dr. W. Severzow, Russia; Rev. Canon H. B. Tristram, England; Dr. Hjalmar Theel, Sweden.

The report of the Committee on Revision of Nomenclature and Classification of North American Birds was presented by the Chairman, Dr. Elliott Coues, who said that the work of the Committee had been divided by the creation of two Sub-Committees: one (consisting of Messrs. Ridgway, Brewster, and Henshaw) to determine the status of species and sub-species; the other (consisting of Mr. Allen and Dr. Coues) to formulate the canons of nomenclature and classification adopted by the Committee. He also expressed the indebtedness of the Committee to Dr. Leonhard Stejneger for determining many points in synonymy, and for other aid. Dr. Coues then read at length the report of the Sub-Committee on Codification of Canons of Nomenclature and Classification, as adopted by the full Committee. The reading occupied about an hour and a half. Mr. Ridgway continued the report by reading the list of species prepared by the Sub-Committee on the Status of Species and Sub-Species as adopted by the full Committee. The Committee unanimously adopted the tenth edition of Linneus's "Systema Nature" as the starting-point in zoological nomenclature; and unflinchingly avowed its adherence to the rule of priority; and emphatically and unequivocally indorsed the employment of trinomials in the designation of sub-species.

The report of the Committee on Bird Migration was presented by the Chairman, Dr. C. Hart Merriam. Dr. Merriam stated that a circular had been issued setting forth the objects and methods of the Committee, specifying the division of the territory of the United States and British North America into thirteen districts (each of which had been placed in charge of a competent superintendent), and supplying instructions to observers concerning the data desired—which were classed under the heads of Ornithological, Meteorological, and Contemporary and Correlative Phenomena.

In order to secure a large number of observers, the Chairman had written to the editors of eight hundred newspapers, asking them to call attention to the work of the Committee and to state that more observers were desired. The several superintendents had also written to a large number of papers—just how many the Chairman was not aware. The Press very kindly gave the matter the prominence its importance deserved, and abstracts of the circulars, amounting in some cases to an actual reprint, and usually coupled with editorial comment, were published in several hundred newspapers. This resulted in the receipt by the Chairman of upwards of three thousand applications for circulars of information and instruction. In all, nearly six thousand circulars were distributed. By this means the Committee finally secured nearly seven hundred observers, in addition to the keepers of lights. The observers are distributed as follows:—Mississippi Valley district, Prof. W. W. Cooke, Superintendent, 170; New England district, John H. Sage, Superintendent, 142; Atlantic district, Dr. A. K. Fisher, Superintendent, 121; Middle-Eastern district, Dr. J. M. Wheaton, Superintendent, 90; Quebec and the Maritime Provinces, Montague Chamberlain, Superintendent, 56; district of Ontario, Thomas McLlwraith, Superintendent, 38; Pacific district, L. Belding, Superintendent, 30; Rocky Mountain district, Dr. Edgar A. Mearns, Superintendent, 14; Manitoba, Prof. W. W. Cooke, Superintendent, 10; British Columbia, John Fannin, Superintendent, 5; North-West Territories, Ernest E. T. Seton, Superintendent, 5; Newfoundland, James P. Howley, Superintendent (returns not yet received). Migration stations now exist in every State and Territory in the Union excepting Delaware and Nevada.

The Committee was fortunate in obtaining the co-operation of the Department of Marine and Fisheries of Canada, and of the Lighthouse Board of the United States. By this means it secured the free distribution of upwards of twelve hundred sets of schedules and circulars to the keepers of lighthouses, lightships, and beacons in the United States and British North America.

The returns thus far received from observation were exceedingly voluminous and of great value. They were so extensive, indeed, that it was utterly impossible for the Committee to elaborate them without considerable pecuniary aid.

In order to show the Union the character and extent of the labours of the Committee, the Chairman had requested the superintendents of all districts east of the Rocky Mountains to prepare reports upon five common, well-known, and widely-

distributed birds, to wit: the robin (*Merula migratoria*), cat-bird (*Mimus carolinensis*), Baltimore oriole (*Icterus gabula*), purple martin (*Progne subis*), and nighthawk (*Chordeiles papabue*). This had been done, and the reports received were presented for examination. The Chairman directed special attention to those prepared by Dr. J. M. Wheaton and Dr. A. K. Fisher as examples of tabulated returns, and to that received from Prof. W. W. Cooke as an example of the generalisation of results.

The Chairman called attention to the action of the International Ornithologists' Congress held in Vienna last April, stating that he had been instructed (in common with the delegates from other countries) to represent the cause of the Committee in the National Government, begging it "to further to the utmost the organising of migration stations," and "to appropriate a sufficient sum for the support of these stations, and for the publication of annual reports of the observations made."

The Council was instructed to memorialise the Congress 'of the United States, and the Parliament of Canada, in behalf of the work of the Committee on Bird Migration.

On the motion of Mr. Brewster, the Committee on Geographical Distribution was merged into the Committee on Migration as a Sub-Committee, the whole Committee to be entitled a "Committee on the Migration and Geographical Distribution of North American Birds."

The Report of the Committee on the Eligibility or Ineligibility of the European House-Sparrow in America was presented by Dr. J. B. Hoker, Chairman of the Committee. Dr. Hoker said that a circular of inquiry had been printed, and about one thousand copies circulated in Canada and the United States. Particular pains had been taken to secure evidence from those who advocated the cause of the sparrow. A large number of returns had been received, and the evidence for and against the naturalised exotic had been carefully sifted and summarised. The result overwhelmingly demonstrated that the sum of its injurious qualities far exceeds and cancels the sum of its beneficial qualities. In other words, it was the verdict of the Committee that the European house-sparrow is not an eligible bird in North America. The Union sustained the decision of the Committee.

The Report of the Committee on Faunal Areas was presented by the Chairman, Mr. J. A. Allen. Mr. Allen said that, for the purposes of the Committee, North America had been divided into several districts, each of which had been placed in charge of a member of the Committee as follows:—Arctic and British America and the northern tier of States bordering the Great Lakes, from New York to Minnesota inclusive, were being worked by Dr. C. Hart Merriam; Canada, south of the St. Lawrence, and New England, by Arthur P. Chadbourne; the Eastern and Middle States, from New Jersey to Florida, and west to the Mississippi River, by Dr. A. K. Fisher; the Rocky Mountain region by Dr. Edgar A. Mearns; and the Pacific region by L. Belding. It was the plan of the Committee to collate and tabulate the required data from all published sources; to avail itself in like manner of the material contained in the returns of the observers of bird migration (this privilege having been granted by the Committee on Bird Migration); to illustrate the facts thus obtained by coloured maps showing the summer and winter range of each species; and to generalise the final results and place the same before the Union, accompanied by coloured charts showing, with as much precision as possible, the exact limits of the several faunal areas in North America.

Dr. P. L. Sclater said he was glad to know that North America, which he knew as a *Nearctic* region, was being worked in so thorough a manner by so competent a Committee, and that the results obtained could not fail to be of great interest and value.

The matter of the wholesale slaughter of our native birds for millinery and other purposes was brought forcibly before the Union by Mr. Wm. Brewster, and a Committee was appointed for the protection of North American birds and their eggs against wanton and indiscriminate destruction.

Dr. Merriam spoke of the capture, just two weeks previously (September 19), of a second specimen of the wheatear (*Saxicola ananthe*) at Godbout, on the north shore of the St. Lawrence, by Mr. Napoleon A. Comeau. Mr. Comeau exhibited the bird, a handsome male, and said that he shot the first specimen at the same place on May 18 last. He also spoke of the capture at Godbout of the European house-sparrow (*Passer domesticus*), thus extending the known range of the species, on the north shore, by at least 250 miles.

Dr. Leonhard Stejneger exhibited a stuffed specimen of a willow grouse from Newfoundland, which he regarded as a new geographical race, differing from the continental form chiefly in the possession of more or less black upon its primaries. Mr. Brewster said that he had recently examined 150 specimens of ptarmigan from Newfoundland, and had observed the peculiarities pointed out, but did not consider them constant. He was inclined to regard the characters mentioned as seasonal, and possibly to some extent individual. Dr. Stejneger replied that this coloration of the wing feathers could not possibly be seasonal as they (the primaries) were moulted but once a year. Dr. Merriam stated that during a recent visit to Newfoundland he had examined a very large number of willow grouse in the flesh, and was still engaged in investigating the change of colour in this species. His studies led him to disagree with Dr. Stejneger's last statement. He (Dr. Merriam) was convinced that change in colour in individual feathers did take place, both independent of and coincident with the moult. Mr. D. G. Elliot agreed with Mr. Merriam in considering the change of colour of individual feathers an established fact. An animated discussion followed, and was participated in by Messrs. Brewster, Comeau, Coues, Elliot, Merriam, Ridgway, and Stejneger.

In response to a call from the President, Dr. P. L. Schlotter said:—

"I hope the members of the American Ornithologists' Union will excuse me if I offend the feelings of any one by the remarks I am about to make. It has aggrieved me much to find in this country three large and valuable collections of birds which are not under the care of paid working ornithologists. One of these is in Boston, one in New York, and the other in Philadelphia. Each contains what all ornithologists admit to be most valuable typical specimens. A grave responsibility rests upon the possessors of types of species, and the loss or injury of such specimens is a great and irreparable loss to science. The collection of the Boston Society of Natural History (known as the La Frenayé Collection) has been much damaged by neglect, and the entire collection ought to be catalogued and so arranged as to render any particular specimen readily accessible. In this building (the American Museum of Natural History in New York) are the types of the celebrated Maximilian Collection, and many other specimens of exceeding great value. A large number of these have never been properly identified, and some of them are missing and have doubtless been destroyed by insect pests. The value of others has been lost through neglect, by the displacement of labels, and by the omission of proper measures for their preservation. The same remarks would, in a general way, apply to the collections of the Philadelphia Academy of Natural Sciences. It is sad to find no paid ornithologists in charge of these exceedingly valuable collections, and I beg to suggest that the American Ornithologists' Union can undertake no worthier task than to impress upon the proper authorities the urgent necessity of immediate action in this matter."

The officers of the Union were re-elected as follows:—President, J. A. Allen, Cambridge; Vice-Presidents, Dr. Elliott Coues and Robert Ridgway, Washington; Secretary and Treasurer, Dr. C. Hart Merriam, Locust Grove, New York.

The place of meeting for next year was referred to the Council for decision.

### THE CAPILLARY CONSTANTS OF LIQUIDS AT THEIR BOILING-POINTS

THE paper of Prof. Robert Schiff, published in *Liebig's Annalen*, March 1884, on this subject, marks the first successful attempt out of many that have been made to connect the surface-tension of a liquid with its molecular constitution.

It has long been known that the tension diminishes rapidly with a rise of temperature, but the importance of this fact when it is desired to make a comparative examination of different liquids has not been fully appreciated or sufficiently insisted on till now by Prof. Schiff, who has to lament that, out of the considerable array of experimental investigations on the subject which he has examined, very few results could be extracted which could be usefully employed in such a comparative study, a failure which he attributes to the completely arbitrary and dissimilar physical conditions under which the different substances in question have been examined.

Since it is impossible to compare surface-tensions at the critical point, because that is the point at which the surface-tension vanishes, it is necessary to seek some other condition in which

different liquids may be physically comparable, and that which naturally suggested itself for trial to Prof. Schiff, was the boiling-point of the liquid itself, whose significance in this respect he has himself established.

The principle of his method was to select with great care two capillary glass tubes of perfectly cylindrical bore, of different diameters, that of the wider being about 1.3 mm., and of the narrower about half as much. These two tubes are then united into a little U-tube (about 7 cm. long), which, after being partly filled with the experimental liquid, is hung in a wider vessel, at the bottom of which a little of the same liquid is kept boiling. From the difference of level of the liquid in these two connected capillary tubes, as measured at a temperature which must be very nearly the boiling-point, the surface-tension at that temperature is readily deduced, since the method of procedure involves the thorough wetting of the upper portion of the tube with condensed liquid.

In this manner Prof. Schiff has determined the surface-tension at the boiling-point of some sixty liquids, with a possible error which he estimates at 1.75 per cent. of the mean value—at the worst, 2.4 per cent. His results may be stated as follows:—

1. For isomeric liquids that are chemically comparable, the surface-tension at the boiling-point is the same (within the limits of observational error). The observations do indeed point in the case of isomers of one class to a fall in surface-tension with a fall in the boiling-point, while in another class there is a perceptible rise with a rise in the boiling-point, but these variations are within the limits of possible errors of observation.

2. The quantity which turns out to be that on which attention should be fixed is not the surface-tension itself, but the surface-tension divided by the molecular weight, a quantity to which the author gives a vivid significance by pointing out that, in the case of a capillary elevation against a vertical wall wetted by the liquid, it is proportional to and represents the number of molecules raised above the free surface per unit length of the wall; for, since the tension per unit length is equal to the weight of the total number of molecules lifted, this tension divided by the weight of each molecule gives the total number lifted.

To the surface-tension in milligrams per millimetre divided by the relative molecular weight (and multiplied for convenience by 1000), Prof. Schiff accordingly assigns the symbol *N*, and his results show that not only is this number *N* the same for isomeric substances (as is implied in the previous statement), but that it is often the same for liquids of very different chemical constitution. He then proceeds to examine the formulæ of such chemically different liquids which have the common property that *N* is the same, in the manner exemplified in the following illustration:—

"Taking all the different substances for which *N* is nearly 16, we find—

Hexane, $C_6H_{14}$ ... ..	$N =$	16.1
		16.0
Xylol, ethyl-benzol, $C_8H_{10}$ ...	$N =$	15.9
		15.8
		16.2
		15.8
		15.6
With the formula $C_8H_{10}O_2$ ...	$N =$	15.6
		15.9
		15.7

"This indicates that substances with the formulæ

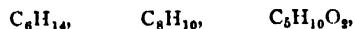

are, so far as concerns the value of the number (*N*) of molecules lifted, equivalent to each other.

" $C_8H_{14}$  differs from  $C_8H_{10}$  in having  $C_2$  less and  $H_4$  more; accordingly, so far as concerns the constant *N*,

$$2C = 4H.$$

" $C_8H_{10}$  differs from  $C_8H_{10}O_2$  in having  $C_2$  more and  $O_2$  less, so that, with reference to the constant *N*,

$$3C = 2O."$$

In order to test whether these equivalences are accidental or not, he examines other series, for which *N* has respectively the value 10.5, 13, 27, &c., but always with the same result, so that he concludes that these equivalences are not chance coincidences, but that it is really possible to replace a certain number of atoms of one kind by a certain number of another kind without producing in the value of *N* an alteration which comes within the limits of precise observation.

From the equivalences  $2C = 4H$  and  $3C = 2O$  it follows that  $C = 2H$  and  $O = 3H$ ,

while from a similar examination of liquids containing chlorine he deduces  $Cl = 7H$ .

These equivalences enable him to write down what may be called the hydrogen equivalent, with respect to the value of the number  $N$ , of any compound of the four elements in question, *i.e.* the number of hydrogen atoms, which, if they existed as a molecule in the free state, would constitute a substance for which the value of  $N$  at the boiling-point would be the same as for the original substance. Thus, selecting a few substances whose hydrogen equivalents are tolerably evenly distributed over the range that he has examined, he obtains the following table:—

	H	N
$CH_4O$	$= H_9$	59·8
$C_2H_6O$	$= H_{13}$	38·4
$C_3H_8O$	$= H_{17}$	29·0
$C_3H_8O_2$	$= H_{18}$	27·0
$C_4H_{10}O_2$	$= H_{22}$	20·4
$C_8H_{10}$	$= H_{36}$	16·1
$C_8H_{10}$	$= H_{30}$	13·1
$C_8H_{18}$	$= H_{34}$	10·5
$C_8H_{16}O_2$	$= H_{38}$	8·7
$C_{10}H_{22}$	$= H_{42}$	7·7

From these observations as data, a curve is easily drawn of which the ordinates are proportional to the number of atoms in the hydrogen equivalent and the abscissæ to the corresponding value of  $N$ ; and it is remarkable that the curve so drawn is of equable curvature, and corresponds equally well, not only to the selected data from which it is plotted, but also to all the other observed values of  $N$ , so that by transforming the molecular formula of any liquid into its hydrogen equivalent we can at once find, by reference to the curve, the value of  $N$  for the substance, and, by multiplying this by  $\frac{\text{mol. weight}}{1000}$ , we obtain the

surface-tension at the boiling-point.

There are only three liquids for which Prof. Schiff notices that the value of  $N$ , as calculated from the curve, differs markedly from the observed value. These are—

Amylene ( $C_8H_{10}$ ), for which $N$ (obsd.) = 22, and $N$ (calcd.) = 23·4	
Diallyl ( $C_8H_{10}$ ), " " " " = 18·4 " = 20·5	
Ethylene-chloride ( $C_2H_4Cl_2$ ), " " " " = 24·6 " = 20·5	

In the first case the disagreement is explained by the presence of impurity; in the second, impurity is very possibly the cause; while in the third it is possible that the equation  $Cl = 7H$ , is not applicable to substances in whose formula more than a single carbon atom is represented, a point which the author hopes to clear up by further investigation. We observe, however, that to these disagreements should be added the case of ethyl-isobutyrate ( $C_8H_{12}O_2$ ), for which  $N$  as given by the curve is 13·1, while the observed value was 12·3, a deviation of 7·5 per cent. On this the author makes no remark.

We will venture here to call attention also to a slight error that pervades all Prof. Schiff's results. We refer to the manner in which he corrects for the meniscus. The importance of this correction is in these measures very considerable, since the total elevation observed is always less than 10 mm. and sometimes less than 5 mm., and the correction is sometimes as much as a per cent. of the whole. Prof. Schiff, rejecting as insufficiently accurate Laplace's correction, which is based on the assumption that the surface of the meniscus may be regarded as that of a hemisphere of the same radius as the tube, and which consists therefore in adding to the observed height one-third of this radius, prefers to measure the height of the meniscus directly and to take as the correction one-third of the arithmetical mean between the observed height and the radius of the tube. In doing this he assumes that the surface may be regarded as that of a sphere of radius very appreciably greater than that of the tube, and gives a diagram in which it is so represented; but if this assumption or representation were correct, the laws of capillary tubes would be very different from what they are; moreover, according to theory, the form of the meniscus, and therefore the correction, must always be the same for liquids with the same capillary elevation; but Prof. Schiff's correction, based on the direct measurement of the meniscus, varies very considerably for elevations that are almost identical, which

shows that the measures of the meniscus are not to be relied on: thus in the case of ethyl-toluol (para) ( $C_9H_{10}$ ) the elevation is '603 cm., and the correction '013 cm., while for isobutyl-formiate ( $C_8H_{10}O_2$ ) the elevation is '599 cm., but the correction '008 c.m., and in many cases one of two liquids which must theoretically have the greater correction has in point of fact the smaller. In order to see how far the empirical correction was at fault, we have selected one of Prof. Schiff's measures in which the elevation has about its mean value, and have calculated for comparison the correction of Hagen and Desains, which is based on the very approximately accurate assumption that the meniscus may be regarded as an oblate spheroid, and which is said to have been verified (? in the case of water) for tubes whose diameter attained as much as 4·6 mm. The following is the result:—

Propyl Formiate: observed elevation	=	mm. 6·45
" " Laplace's correction	=	- 0·1046
" " Hagen and Desains' correction	=	- 0·102
" " Schiff's correction	=	- 0·07
Corrected value (Schiff) 6·38; (Hagen and Desains), 6·348 mm.		

It will thus be seen that an error of about  $\frac{1}{3}$  per cent. in the value of the surface-tension has entered into the result on this occasion, and that more has been lost than gained by substituting the empirical correction for that of Laplace; in some cases the error will be rather greater.

The importance in molecular physics of the step which Prof. Schiff has taken cannot easily be overrated. If it were only that he had found that isomeric substances have the same surface-tension at the boiling-point, that alone would have been a fact of great importance in reference to the interpretation of what we are accustomed to call the internal vapour-tension in a liquid; but in the system of absolute atomic equivalences with respect to surface-tension, and the knowledge of the manner in which the surface-tension varies with variations of the atomic equivalent, he has given to the physicist now for the first time most important data for correlating the surface-tension with the molecular actions existing expectively in the mass of the liquid and in the vapour above it.

A. M. W.

### RESEARCHES ON THE ORIGIN AND LIFE-HISTORIES OF THE LEAST AND LOWEST LIVING THINGS<sup>1</sup>

TO all who have familiarised themselves, even cursorily, with modern scientific knowledge, it is well known that the mind encounters the *infinite* in the contemplation of minute, as well as in the study of vast natural phenomena. The farthest limit we have reached, with the most gigantic standard of measurement we could well employ, in gauging the greatness of the universe, only leaves us with an overwhelming consciousness of the awful greatness—the abyss of the infinite—that lies beyond, and which our minds can never measure. The indefinite has a limit somewhere; but it is not the indefinite, it is the measureless, the infinite, that vast extension forces upon our minds. In like manner, the immeasurable in minuteness is an inevitable mental sequence from the facts and phenomena revealed to us by a study of the *minute* in nature. The practical divisibility of matter disclosed by modern physics may well arrest and astonish us. But biology, the science which investigates the phenomena of all living things, is in this matter no whit behind. The most universally diffused organism in nature, the least in size with which we are definitely acquainted, is so small that fifty millions of them could lie together in the one-hundredth of an inch square. Yet these definite living things have the power of locomotion, of ingestion, of assimilation, of excretion, and of enormous multiplication, and the material of which the inconceivably minute living speck is made, is a highly complex chemical compound. We dare not attempt a conception of the minuteness of the ultimate atoms that compose the several simple elements that thus mysteriously combine to form the complex substance and properties of this least and lowliest living thing. But if we could even measure these, as a mental necessity, we are urged indefinitely on to a minuteness without conceivable limit, in effect, a minuteness that is beyond all finite measure or conception. So that, as modern physics and optics have enabled us not to conceive merely, but to actually realise, the vastness of spatial extension, side by side

<sup>1</sup> By Rev. W. H. Dallinger, LL.D., F.R.S., F.L.S., Pres. R.M.S.

with subtle tenuity and extreme divisibility of matter, so the labour, enthusiasm, and perseverance of thirty years, stimulated by the insight of a rare and master mind, and aided by lenses of steadily advancing perfection, has enabled the student of life-forms not simply to become possessed of an inconceivably broader, deeper, and truer knowledge of the great world of visible life, of which he himself is a factor; but also to open up and penetrate into a world of minute living things so ultimately little that we cannot adequately conceive them, which are, nevertheless, perfect in their adaptations and wonderful in their histories. These organisms, whilst they are the least, are also the lowliest in Nature, and are to our present capacity totally devoid of what is known as organic structure, even when scrutinised with our most powerful and perfect lenses. Now these organisms lie on the very verge and margin of the vast area of what we know as living. They possess the essential properties of life, but in their most initial state. And their numberless billions, springing every moment into existence wherever putrescence appeared, led to the question, "How do they originate?" Do they spring up *de novo* from the highest point on the area of *not-life*, which they touch? Are they, in short, the direct product of some yet uncorrelated force in nature, changing the dead, the unorganised, the not-living into definite forms of life? Now this is a profound question, and that it is a difficult one there can be no doubt. But that it is a question for our laboratories is certain. And after careful and prolonged experiment and research the legitimate question to be asked is, Do we find that in our laboratories and in the observed processes of Nature now, that the not-living can be, without the intervention of living things, changed into that which lives?

To that question the vast majority of practical biologists answer without hesitancy, *No*, we have no facts to justify such a conclusion. Prof. Huxley shall represent them. He says, "The properties of living matter distinguish it absolutely from all other kinds of things," and, he continues, "the present state of our knowledge furnishes us with no link between the living and the not-living." Now let us carefully remember that the great doctrine of Charles Darwin has furnished biology with a magnificent generalisation: one indeed which stands upon so broad a basis that great masses of detail and many needful interlocking facts are, of necessity, relegated to the quiet workers of the present, and the earnest labourers of the years to come. But it is a doctrine which cannot be shaken. The constant and universal action of variation, the struggle for existence, and the "survival of the fittest," few who are competent to grasp will have the temerity to doubt. And to many, that which lies within it as a doctrine, and forms the fibre of its fabric, is the existence of a continuity, an unbroken stream of unity running from the base to the apex of the entire organic series. The plant and the animal, the lowliest organised and the most complex, the minutest and the largest, are related to each other so as to constitute one majestic organic whole. Now to this splendid continuity practical biology presents no adverse fact. All our most recent and most accurate knowledge confirms it. But the question is, Does this continuity terminate now in the living series, and is there then a break—a sharp, clear discontinuity, and beyond, another realm immeasurably less endowed, known as the realm of not-life? or, Does what has been taken for the clear-cut boundary of the vital area, when more deeply searched, reveal the presence of a force at present unknown, which changes not-living into the living, and thus makes all nature an unbroken sequence and a continuous whole? That this is a great question, a question involving large issues, will be seen by all who have familiarised themselves with the thought and fact of our times. But we must treat it purely as a question of science; it is not a question of *how* life first appeared upon the earth, it is only a question of whether there is any natural force *now* at work building not-living matter into living forms. Nor have we to determine whether or not, in the indefinite past, the not-vital elements on the earth, at some point of their highest activity, were endowed with, or became possessed of, the properties of life.

On that subject there is no doubt. The elements that compose protoplasm—the physical basis of all living things—are the familiar elements of the world without life. The mystery of life is not in the elements that compose the vital stuff. We know them all, we know their properties. The mystery consists *solely* in *how* these elements can be so combined as to acquire the transcendent properties of life. Moreover, to the investigator it is not a question of *by what means* matter dead—without the shimmer of a vital quality—became either slowly or suddenly possessed of the

properties of life. Enough for us to know that whatever the power that wrought the change, that power was competent, as the issue proves. But that which calm and patient research has to determine is whether matter demonstrably *not living* can be, without the aid of organisms already living, endowed with the properties of life. Judged of hastily, and apart from the facts, it may appear to some minds that an origin of life from not-life, by sheer physical law, would be a great philosophical gain; an indefinitely strong support of the doctrine of evolution. If this were so, and, indeed, so far as it is believed to be so, it would speak and does speak volumes in favour of the spirit of science pervading our age. For although the vast majority of biologists in Europe and America accept the doctrine of evolution, they are almost unanimous in their refusal to accept as in any sense competent the reputed evidence of "spontaneous generation"; which demonstrates, at least, that what is sought by our leaders in science is not the mere support of hypotheses, cherished though they may be; but the truth, the uncoloured truth, from nature. But it must be remembered that the present existence of what has been called "spontaneous generation," the origin of life *de novo* today, by physical law, is by no means required by the doctrine of evolution. Prof. Huxley, for example, says, "If all living beings have been evolved from pre-existing forms of life, it is enough that a single particle of protoplasm should *once* have

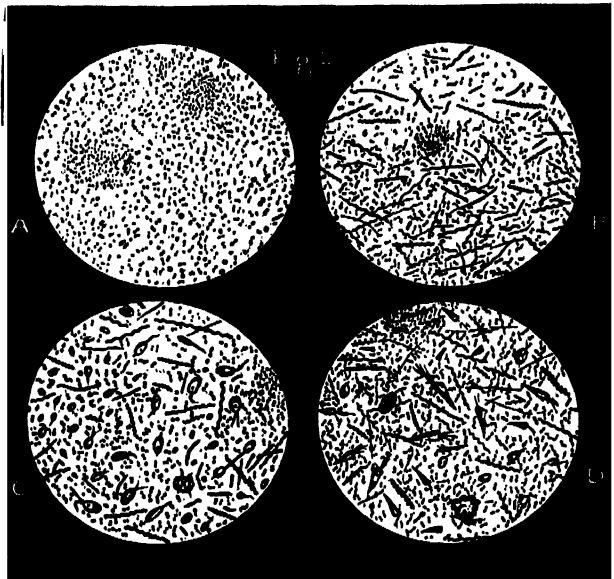

appeared upon the globe, as the result of no matter what agency; any further independent formation of protoplasm would be sheer waste." And why? we may ask. Because one of the most marvellous and unique properties of protoplasm, and the living forms built out of it, is *the power* to multiply indefinitely and for ever! What need, then, of spontaneous generation? It is certainly true that evidence has been adduced purporting to support, if not establish, the origin in dead matter of the least and lowest forms of life. But it evinces no prejudice to say that it is inefficient. For a moment study the facts. The organisms which were used to test the point at issue were those known as *Septic*. The vast majority of these are inexpressibly minute. The smallest of them, indeed, is so small that, as I have said, fifty millions of them, if laid in order, would only fill the one-hundredth part of a cubic inch. Many are relatively larger, but all are supremely minute. Now, these organisms are universally present in enormous numbers, and ever rapidly increasing in all moist putrefactions over the surface of the globe.

Take an illustration prepared for the purpose and taken direct from nature. A vessel of pure drinking water was taken during the month of July at a temperature of 65° F., and into it was dropped a few shreds of fish muscle and brain. It was left uncovered for twelve hours; at the end of that time a small blunt rod was inserted in the now somewhat opalescent water, and a minute drop taken out and properly placed on the

microscope, and, with a lens just competent to reveal the minutest objects, examined. The field of view presented is seen in Fig. 1, A. But—with the exception of the dense masses which are known as zoogloea or bacteria, fused together in living glue—the whole field was teeming with action. Each minute organism gyrating in its own path, and darting at every visible point. The same fluid was now left for sixteen hours, and once more a minute drop was taken and examined with the same lens as before. The field presented to the eye is depicted in Fig. 1, B, where it is visible that whilst the original organism persists yet a new organism has arisen in and invaded the fluid. It is a relatively long and beautiful spiral form, and now the movement in the field is entrancing. The original organism darts with its vigour and grace, and rebounds in all directions. But the spiral forms revolving on their axes glide like a flight of swallows over the ample area of their little sea. Ten hours more elapsed and, without change of circumstances, another drop was taken from the now palpably putrescent fluid. The result of examination is given in Fig. 1, C, where it will be seen that the first organism is still abundant, the spiral organism is still present and active, but a new and oval form, not a bacterium, but a *monad*, has appeared. And now the intensity of action and beauty of movement throughout the field utterly defy description, gyrating, darting, spinning, wheeling, rebounding with the swiftness of the grayling and the beauty of the bird. Finally, at the end of another eight to sixteen hours, a final "dip" was taken from the fluid, and under the same lens it presented as a field what is seen in Fig. 1, D, where the largest of the putrefactive organisms has appeared and has even more intense and more varied movements than the others. Now the question before us is, "How did these organisms arise?" The water was pure; they were not discoverable in the fresh muscle of fish. Yet in a dozen hours the vessel of water is peopled with hosts of individual forms which no mathematics could number! How did they arise? from universally diffused eggs? or from the direct physical change of dead matter into living forms? Twelve years ago the life-histories of these forms were unknown. We did not know biologically how they developed. And yet with this great deficiency it was considered by some that their mode of origin could be determined by heat experiments on the adult forms. Roughly the method was this. It was assumed that nothing vital could resist the boiling point of water. Fluids, then, containing full-grown organisms in enormous multitudes, chiefly bacteria, were placed in flasks, and boiled for from five to ten minutes. While they were boiling the necks of the flasks were hermetically closed; and the flask was allowed to remain unopened for various periods. The reasoning was: "Boiling has killed all forms of vitality in the flask; by the hermetic sealing nothing living can gain subsequent access to the fluid; therefore, if living organisms do appear when the flask is opened, they must have arisen in the dead matter *de novo* by spontaneous generation, but if they do never so arise the probability is that they originate in spores or eggs."

Now it must be observed concerning this method of inquiry that it could never be final: it is incompetent by deficiency. Its results could never be exhaustive until the life-histories of the organisms involved were known. And further: although it is a legitimate method of research for partial results, and was of necessity employed, yet it requires precise and accurate manipulation. A thousand possible errors surround it. It can only yield scientific results in the hands of a master in physical experiment. And we find that when it has secured the requisite skill, as in the hands of Prof. Tyndall, for example, the result has been the irresistible deduction that living things have never been seen to originate in not-living matter. Then the ground is cleared for the strictly biological inquiry, How do they originate? To answer that question we must study the life-histories of the minutest forms with the same continuity and thoroughness with which we study the development of a crayfish or a butterfly. The difficulty in the way of this is the extreme minuteness of the organisms. We require powerful and perfect lenses for the work. Happily during the last fifteen years the improvement in the structure of the most powerful lenses has been great indeed. Prior to this time there were English lenses that amplified enormously. But an enlargement of the image of an object avails nothing, if there be no concurrent disclosure of detail. Little is gained by expanding the image of an object from the ten-thousandth of an inch to an inch, if there be not an equivalent revelation of hidden details. It is in this revealing quality, which I shall call *magnification* as distinct from *amplification*, that our recent lenses so brilliantly

excel. It is not easy to convey to those unfamiliar with objects of extreme minuteness a correct idea of what this power is. But at the risk of extreme simplicity, and to make the higher reaches of my subject intelligible to all, I would fain make this plain.

But to do so I must begin with familiar objects, objects used solely to convey good relative ideas of minute dimension. I begin with small objects with the actual size of which you are familiar. All of us have taken a naked-eye view of the sting of the wasp or honey-bee; we have a due conception of its size. This is the scabbard or sheath, which the naked eye sees.<sup>1</sup> Within this are two blades, terminating in barbed points. The point of the scabbard more highly magnified is presented, showing the inclosed barbs. One of the barbs, looked at on the barbed edge, is also seen. Now these two barbed stings are tubes, with an opening in the end of the barb. Each is connected with the tube of the sac C. This is a reservoir of poison, and D is the gland by which it is secreted. Now I present this to you, not for its own sake, but simply for the comparison, a comparison which struck the earliest microscopists. Here is the scabbard carefully rendered. One of the stings is protruded below its point, as in the act of stinging; the other is free to show its form. Now the actual length of this scabbard in nature was the *one-thirtieth* of an inch. I have taken the point C of a fine cambric sewing needle, and broken it off to slightly less than the one-thirtieth of an inch, and magnified it as the sting is magnified. Now here we obtain an instance of what I mean by magnification. The needle-point is not merely bigger, unsuspected details start into view. The sting is not simply enlarged, but all its structure is revealed. Nor can we fail to note that the *finish* of art differs from that of Nature. The homogeneous gloss of the needle disappears under the fierce scrutiny of the lens, and its delicate point becomes furrowed and riven. But Nature's finish reveals no flaw, it remains perfect to the last.

We may readily amplify this. The butterflies and moths of our native lands we all know; most of us have seen their minute eggs. Many are quite visible to the unaided eye; others are extremely minute. A gives the egg of the Small White Butterfly,<sup>2</sup> B that of the Small Tortoiseshell, C that of the Waved Umber Moth, D that of the Thorn Moth, E that of the Shark Moth, and F we have the delicate egg of the Small Emerald Butterfly, and at G an American Skipper, and finally at H the egg of a moth known as *Mania Maura*. In all this you see a delicacy of symmetry, structure and carving, not accessible to the eye, but clearly unfolded. We may, from our general knowledge, form a correct notion of the average relation in size existing between butterflies and their eggs; so that we can compare. Now there is a group of extremely minute insect-like forms that are the parasites of birds. Many of them are just plainly visible to the naked eye, others are too minute to be clearly seen, and others yet again wholly elude the unaided sight. The *c* Epizoa generally lodge themselves in various parts of the plumage of birds; and almost every group of birds becomes the host of some specific or varietal form with distinct adaptations. There is here seen a parasite that secretes itself in the inner feathers of the peacock, this is a form that attacks the jay, and here is one that secretes itself beneath the plumage of the partridge.

Now these minute creatures also deposit eggs. They are placed with wonderful instinct in the part of the plumage and the part of the feather which will most conserve their safety; and they are either glued or fixed by their shape or by their spine in the position in which they shall be hatched. I show here a group of the eggs of these minute creatures. I need not call your attention to their beauty; it is palpable. But I am fain to show you that, subtle and refined as that beauty is, it is clearly brought out. The flower-like beauty of the egg of the peacock's parasite, the delicate symmetry and subtle carving of the others simply entrance an observer. Note then that it is not merely *enlarged* specks of form that we are beholding, but such true magnifications of the objects as bring out all their subtlest details. And it is *this* quality that must characterise our most powerful lenses. I am almost compelled to note in passing that the *beauty* of these delicate and minute objects must not be considered an *end*—a purpose—in Nature. It is not so. The form is what it is because it *must be* so to serve the end for which the egg is formed. There is not a superfluous spine,

<sup>1</sup> A magnified image of the bee's sting was projected on the screen.

<sup>2</sup> A series of the eggs of butterflies were then shown, as were the objects successively referred to but not here reproduced.

not a useless petal in the floral egg, not an unneeded line of chasing in the decorated shell. It is shaped beautifully because its shape is needed. In short, it is Nature's method; the identification of beauty and use. But to resume. We may at this point continue our illustrations of the analytical power of moderate lenses by a beautiful instance. We are indebted to Albert Michael of the Linnean Society of England for a masterly treatise on a group of Acari, or *Mites*, known as the *Oribatida*. Many of these he has discovered. The one before you is a full grown Nymph, of what is known as a *palmicinctum*. It is deeply interesting as a form; but for us its interest is that it is minute, being only a millimetre in length. But it repeatedly casts the dorsal skin of the abdomen. Each skin is bordered by a row of exquisite scales; and then successive rows of these scales persist, forming a protection to the entire organism. Mark then that we not only reveal the general form of the Nymph, but the lens reveals the true structure of the scales, not enlargement merely, but detail. The egg of the organism, still more magnified, is also seen.

To vary our examples and still progress. We all know the appearance and structure of chalk. The minute Foraminifera have, by their accumulated tests, mainly built up its enormous masses. But there is another chalk known as Barbadoes earth; it is siliceous, and is ultimately composed of minute and beautiful skeletons such as those which, enormously magnified, you now see. These were the glassy envelopes which protected the living speck that dwelt within and built it. They are the minutest of the Radiolaria, which peopled in inconceivable multitudes the Tertiary oceans; and, as they died, their minute skeletons fell down in a continuous rain upon the ocean bed, and became cemented into solid rock, which geologic action has brought to the surface in Barbadoes, and many other parts of the earth. If a piece of this earth, the size of a bean, be boiled in dilute acid and washed, it will fall into powder, the ultimate grains of which are such forms as these which you see. The one before you is an instance of exquisite refinement of detail. The form from which the drawing of the magnified image was made was extremely small—a mere white speck in the strongest light upon a black ground. But you observe it is not a speck of form merely enlarged. It is not merely beauty of outline made bigger. But there is—as in the delicate group you now see—a perfect opening up of otherwise absolutely invisible details. We may strengthen this evidence in favour of the analytical power of our higher lenses, by one more familiar example, and then advance to the most striking illustration of this power which our most perfect and powerful lenses can afford. I fear that it may be taking too much for granted to assume that every one in an audience like this has seen a human flea! Most, however, will have a dim recollection or suggestive instinct as to its size in nature. Nothing striking is revealed by this amount of magnification excepting the existence of breathing pores, or spiracles along the scale armour of its body. But there is a trace of structure in the terminal ring of the exoskeleton which we cannot clearly define, and of which we may desire to know more. This can be done only by the use of far higher powers.

To effect this, we must carefully cut off this delicate structure, and so prepare it that we may employ upon it the first of a series of our highest powers. The result of that examination is given here.<sup>1</sup> You see that the whole organ has a distinct form and border, and that its carefully carved surface gives origin to wheel-like areolæ which form the bases of delicate hairs. The function of this organ is really unknown. It is known from its position as the *pygidium*; and from the extreme sensitiveness of the hairs to the slightest aerial movement may be a tactile organ warning of the approach of enemies, the eyes have no power to see. But we have not yet reached the ultimate accessible structure of this organ. If we place a portion of the surface under one of the finest of our most powerful lenses, this will be the result.<sup>2</sup> Now, without discussing the real optical or anatomical value of this result as it stands, what I desire to remind you of is (1) the natural size of the flea; (2) the increase of knowledge gained by its general enlargement; (3) the relation in size between the flea and its pygidium; and (4) the manner in which our lenses reveal its structure, not merely amplify its form. Now with these simple and yet needful preliminaries you will be able to follow me in a careful study of the least, the very lowliest

and smallest, of all living things. It lies on the very verge of our present powers of optical aid, and what we know concerning it will convince you that we are prepared with competent skill to attack the problem of the life-histories of the smallest living forms. The group to which the subject of our present study belongs is the Bacteria. They are primarily staff-like organisms of extreme minuteness, but may be straight, or bent, or curved, or spiral, or twisted rods. This entire projection is drawn on glass, with *camera lucida*, each object being magnified 2000 diam., that is to say, four millions of times in area. Yet the entire drawing is made upon an area of not quite three inches in diameter and afterwards projected here. The objects therefore are all equally magnified, and their relative sizes may be seen. The giant of the series is known as *Spirillum volutans*; and you will see that the representative species given become less and less in size until we reach the smallest of all the definite forms and known to science as *Bacterium termo*.

Now within given limits this organism varies in size, but if a fair average be taken its size is such that 50,000,000 laid in order would only fill the one-hundredth of a cubic inch. Now the majority of these forms move with rapidity and grace in the fluids they inhabit. But how? by what means? By looking at the largest form of this group you will see that it is provided with two delicate fibres, one at each end. Ehrenberg and others strongly suspected their existence, and we were enabled, with more perfect lenses, to demonstrate their presence some twelve years ago. They are actually the swimming organs of this Spirillum. The fluid is lashed rhythmically by these fibres, and a spiral movement of the utmost grace results. Then do the intermediate forms that move also possess these flagella? and does this least form in nature, viz. *Bacterium termo*, accomplish its bounding and rebounding movements in the same way? Yes! by a series of resolute efforts, in using a new battery of lenses—the finest that at that time had ever been put into the hands of man—I was enabled to show in succession that each motile form of Bacterium up to *B. lineala* accomplished its movements by fibres or flagella; and that in the act of self-division, constantly taking place, a new fibre was drawn out for each half before separation.

(To be continued.)

### THE PERIPATETIC METHOD OF INSTRUCTION IN SCIENCE AND ITS DEVELOPMENT<sup>1</sup>

THE object of this paper is to plead for the introduction of science as a part of the system of ordinary education in all public elementary schools, and to describe the method by which alone, in the opinion of the writer, it is possible that this should be accomplished. There is a general consensus of opinion that a far larger place than has hitherto been allowed in England should be assigned to science in our national system of education, as well as in our grammar-schools and Universities; but no strong conviction yet exists that a certain amount of strict and definite scientific training should be given to all the scholars in our public elementary schools as soon as they are prepared to receive it, which is practically found to be after they have passed the fourth standard. The extent of this claim for the introduction of science as a part of the ordinary curriculum of a public elementary school must be noted, in order that the worth and importance of the proposed method for securing thoroughly effective teaching may be understood.

The provision of special scholarships for those who possess exceptional intellectual power—admirable and necessary as this is—does not meet the broad claim I make. To furnish stages in the ladder by which a lad of mark, endowed with "five talents," may climb from the elementary school to the science college, is only to offer to the children of the poor opportunities to which they are justly entitled by virtue of the fact that genius, like truth, can neither be bought or sold, and is bestowed upon men entirely apart from any considerations connected with social rank and circumstances. But scholars of average ability, those who have no special endowments qualifying them for exceptional careers, ought not to be kept in ignorance of the fixed laws and the majestic marvels of the world in which they will have to labour, or to be deprived of the practical guidance, the intellectual interests, and the protection against coarse and degrading tastes, which scientific training is capable of bestowing upon

<sup>1</sup> The pygidium of the flea, very highly magnified, was here shown.

<sup>2</sup> An illustration of the pygidium structure seen with 1/35th immersion was given.

<sup>1</sup> Paper read at the Social Science Congress, September 22, by Henry W. Crosskey, LL.D., Chairman of the School Management Committee of the Birmingham School Board.

their lives. Only a few can rise to eminence; and it is an unmitigated misfortune for any lad to be encouraged to trust to his intellectual powers for his daily bread, unless he has a fair chance of becoming eminent; but all may possess the scientific knowledge which will give dignity to their daily toil; and the workshop itself may be ennobled.

Neither does the establishment of higher-grade Board schools, in which scientific instruction is given, meet the necessities of the case. The vexed and complicated questions involved in the general organisation of the very miscellaneous collection of schools now existing in England do not fall within the scope of this paper; but I find that many members of School Boards believe that all that is required for scientific instruction will be done when higher grade Board schools are opened; and, by means of examinations and scholarships, admission is brought within reach of a certain number of poor children unable to pay the fee.

Now, the grading of schools must educationally depend upon the time which the scholars can be expected to devote to education; and each grade of schools ought to have a curriculum, determined in its extent and balanced in its parts, according to the number of years which can be spent upon it. The public elementary school should furnish the completest possible education for those who can remain at school until the age of fourteen or fifteen; the higher-grade schools, which properly belong to the secondary system, should be adapted to the wants of scholars who can be retained a year or two longer. The higher-grade school cannot therefore supply the place of the public elementary school to the poor man, who is obliged to send his children to work at a comparatively early age; the number of subjects taught, and the relative number of hours given to them, will not be balanced in a way to suit his requirements.

My contention is that science ought not to be omitted from the educational training of the poorest of our people. The daily concern of the lives of the poor is with forces and materials upon which science throws the strongest light. Their work is bound up with scientific laws. Want of knowledge often means bad work or want of work; and even the spread of pestilence, disease, and death.

The establishment of higher-grade Board schools ought not, therefore, under any circumstances, to be permitted to lower the standard of education in public elementary schools. I speak emphatically on this point, because I believe that the working men of this country will need to take the most watchful heed lest they should be deprived of the education all their children are capable of receiving by the relegation of scientific subjects to schools placed beyond their reach by high fees, mitigated by only a small proportion of free scholarships.

Neither will the opening of technical schools suffice for the scientific instruction of our people. Technical schools cannot do their proper work if their students have had no preliminary training, and are unfamiliar with at least the elementary principles of physics. Lads who have grown into young men without being carried through any systematic and experimental course of scientific instruction will find it almost impossible, after they have left school, to prepare themselves properly for taking advantage of technical colleges, especially when, as among the working classes, their evenings only are at their own disposal.

In order that science may be effectively taught in public elementary schools, the following conditions must be observed:—

1. *It must be taught experimentally.*—Actual demonstration must accompany the lessons at every stage. At no point at which an experiment is possible must it be omitted. The minds of young lads of the type of those attending public elementary schools will be opened and enlarged by experimental demonstrations, but they will not be reached in any other way. Scholars may be able to pass examinations by getting up textbooks; but unless they are made experimentally familiar with the principles of the science they are studying, their knowledge will hang as a dead weight upon their minds, impeding rather than quickening their intellectual activity. Those who have witnessed, as I have often done, the effect of an experimental lesson in science upon large classes of children, often drawn from the poorest of the poor, will not think this insistence upon a plentitude of experiments exaggerated. The demonstration thoroughly awakens their minds; their eyes glisten; there is a long-drawn "Ha" when the result accords with the theory which the teacher has expounded; and questions will soon show that they are not merely wondering at a conjuring trick, but that a new

world, hidden within the world of machinery with which they are familiar through the daily avocations of their parents, is being revealed to them.

2. Science must not only be taught experimentally, but systematically and continuously. The "getting up" of some branch of science during three or four months as a "specific subject" for examination is of little use. "Passes" may be won; but no scientific training will be given.

From these considerations it directly follows that special science demonstrators must be appointed if our scholars are to receive a scientific training of any worth. It may be asked, cannot the work be done by one of the ordinary masters of the school? I am bound to reply that in my opinion—an opinion not lightly formed, but based on observations extending over a not inconsiderable area—it is absolutely impossible to obtain any training which can be called scientific, and prove of practical value, for the scholars of our public elementary schools, without the appointment of special science demonstrators.

In the first place, no man can be a good science demonstrator who does not devote to the work the greater part of his daily life. To perform experiments well is as much an art to be acquired by continuous study and practice as playing the piano. Fertility of resource, quickness of eye and hand, steadiness of mind, keenness of observation, are qualities essential to the demonstrator, which cannot be acquired without culture or retained without constant employment. The master of a school has many subjects to teach and many duties to discharge. He cannot, by any possibility, give any sufficient proportion of his time to the art and practice of scientific demonstration.

It may be said that an expert cannot be required for scholars of the age of those attending public elementary schools, and that any experiments they can understand can be easily performed by any ordinary teacher. Those who have studied any branch of physical science, however, will, I think, agree with me that no science can be well taught except by a man who has had a special scientific training; and that the simplest experiments are best performed and made the most intelligible by those capable of carrying on the more recondite and difficult investigations.

It is a great mistake to imagine that it is a light and easy matter to experiment before a class of scholars, such as those found in our Board schools. They are on the alert for any mistake; they are ready to raise the most curious and subtle doubts, and to ask the most perplexing questions. The only man capable of dealing with such a class of scholars is a man they are compelled to recognise as a master of the science he is teaching.

In the second place, even if the head master of a public elementary school were a scientific expert and managed to keep abreast with the advance of the scientific knowledge of his day, he would find it completely out of his power to act as a science demonstrator and to conduct the general work of his school. The preparation necessary for giving a good science lesson cannot be made without a larger expenditure of time than the proper management of his school will leave at his disposal. The mechanical arrangements for experiments often demand long-continued and anxious watchfulness and care. Every experiment ought to be tried over, before it is performed in the class, to avoid the risk of failure. The proper selection of experiments, as well as their performance, is in itself an art.

For the teaching of science in public elementary schools, therefore, these things are necessary: (1) sufficient apparatus, and of course a laboratory in which experiments can be prepared; and (2) a staff of special science demonstrators.

The expense of providing apparatus, building a laboratory, and supporting a science demonstrator at every single school in town and country, would be as enormous as unnecessary. By the general adoption, however, of what is known as the "peripatetic" method of instruction, all difficulties can be solved; and science can be effectively taught in every public elementary school. I do not think, indeed, that any other satisfactory method can be devised by which the whole of our elementary schools can be reached and the services of those trained scientific men, whose teaching of the elementary principles of science is alone to be relied upon, be secured for the great mass of our people. The peripatetic method has been adopted in Liverpool and Birmingham, and as I can testify so far as Birmingham is concerned, the results have been as satisfactory as remarkable.

The chief characteristics of this method are extremely simple:—



I. As regards "plant," it involves (1) the building of a laboratory in some central position; (2) the purchase of a stock of apparatus; (3) the provision of a small hand-cart by which boxes containing apparatus can be readily carried from school to school.

II. A special science demonstrator is appointed, with such assistants as the number of schools to be dealt with may require.

III. The duties of the science demonstrator are (1) to prepare a scheme of lessons and arrange the experiments for their illustration: in Birmingham, in the boys' departments, mechanics is taken as a "specific subject," and in some schools magnetism and electricity are added; in the girls' departments, domestic economy is taken, and animal physiology is in some cases added; (2) to visit the schools in succession, and give at each school a lesson profusely illustrated by experiments, the requisite apparatus being brought by the hand-cart from the central laboratory.

IV. The regular staff of the school assists the demonstrator, and is assisted by him in the following ways:—

(1) A teacher on the staff of the school is present at every demonstration, and is thus prepared to enforce and continue its lessons in the intervals elapsing between the demonstrator's visits.

(2) The scholars have opportunity given them during school hours to write answers to questions set by the demonstrator, who examines their papers.

In Birmingham a "demonstration" is given in each department once a fortnight. It would be, however, a great improvement if the demonstrator or one of his staff could visit each school once during every week. The science staff consists of a chief demonstrator (Mr. W. Jerome Harrison, F.G.S., whose services deserve the warmest acknowledgment), three assistant demonstrators, who assist in giving lessons at the schools, and a junior laboratory assistant. Two youths are employed to work the hand-cart. The whole amount of salary paid to this staff amounts to 750*l.* per annum.

Scientific instruction is given by this method in thirty boys' schools and thirty girls' schools, containing about 32,000 scholars, the numbers in the classes and the specific subjects taken being:—

Mechanics	...	...	2400	Boys
Magnetism and Electricity	...	...	300	
Domestic Economy	...	...	1800	Girls
Animal Physiology	...	...	100	"

Objections may possibly be taken to this system in the following directions:—

I. *Its cost.*—It being granted, however, that thorough and systematic scientific instruction ought to be introduced into elementary schools, the peripatetic method is the very cheapest that can be devised. One set of apparatus serves for many schools, and one laboratory suffices for the preparation of the experiments. The services of the staff are utilised to the utmost; and the amount of salary to be charged against each school is trifling. Supposing twenty schools in a town or neighbouring villages to be grouped together, the system might be worked at a very slight expense to each. The investment of capital required would be less than 1000*l.*, viz.:—

Building of Central Laboratory <sup>1</sup>	...	...	£700
Apparatus	...	...	300
			£1000

The annual working expenses would be—

Salaries of science demonstrator and assistant	...	£400
Waste of chemicals, renewal of apparatus, &c.	...	50
Expense of moving apparatus from laboratory to school	...	50
		£500

Ample provision could be made at this cost for twenty schools, each having accommodation for 300 or 400 children, i.e. each of the associated schools could obtain, for about 25*l.* a year, thoroughly good experimental instruction for all scholars who have passed the fourth standard.

II. It may be asked whether, in the short time that can be allowed for any specific subject, it is possible to obtain results of sufficient educational worth to justify the expenditure of labour, thought, and money I am advocating. As a reply to

<sup>1</sup> The Birmingham laboratory cost (with fittings) 1450*l.*, but it has a lecture-room and private room for demonstrator attached.

this objection, I can point without fear to the results actually attained in Birmingham; an hour to an hour and a half a week being all the time which has been spared for science, including the fortnightly demonstration, the recapitulation, and preparation of exercises. The teaching being experimental, an impression is made upon the minds of the scholars which can neither be equalled or measured by the effects of ordinary class teaching, lecturing, or book work. The scholars are induced to think, and read, and prepare models of machines and drawings out of school hours; and during school hours they are found to apply themselves with a will to their scientific exercises. Prof. Poynting (of Mason College) has examined a large number of boys competing for a scholarship, and reported to the Board that "the boys showed that they had seen and understood the experiments which they described, that they had been taught to reason for themselves upon them, and that they were not merely using forms of words which they had learned without attaching physical ideas to them." Specimens of the models made by the children, their drawings, and examination papers, have been exhibited at the International Health Exhibition, of which the subjoined account is given in the *School Board Chronicle* (August 9, 1884):—"The cabinet of machines and models and copies of the science apparatus used by the demonstrators in their experiments is well worthy of a visit. It shows the extent and nature of the interest which the children take in this practical form of education. Most of the models have been made by the children at their homes, and often with very inferior tools. One lad has a copy of the Chinese windlass, another makes a little pile engine, and a third illustrates the inclined plane, a fourth the mariner's compass, and so on through a great variety of objects, until a very tolerable little collection of rough but serviceable apparatus has been brought. In cases extending the length of one of the walls of the room is a collection of specimen papers and drawings, prepared at the demonstrator's fortnightly examination of the results of his preceding lesson, and no further justification of the system than these papers can be needed."

In comparing these models and papers with others, it must be remembered that the Birmingham work was not done in any "higher-grade" institutions, with high fees and picked scholars, but indicates the kind of scientific training that may be given by the help of the peripatetic method in any public elementary school.

III. Great anxiety is felt by many lest the introduction of science into elementary schools should result in mere "cram" and a number of hard technical words be repeated by rote to be forgotten as soon as school is left. It is not unusual to hear a laugh raised by the quotation of some technical word from an examination paper, as though its use reduced the system to an absurdity. Scientific facts are, however, most clearly expressed in scientific language. Even young scholars gain by knowing the *right words* by which physical facts and laws are described, and their intellects are bemuddled by vague expressions. The employment of scientific words is no proof of "cram." I admit, as a matter of course, that the attempt to teach science without demonstrating experimentally every fact and law, must result in cramming of the worst description; but *experimental teaching gives the death-blow to cram.*

IV. Will not, however, it is sometimes asked, the introduction of this system of scientific teaching interfere with the progress of the children in writing, reading, and arithmetic? Will not the elements of ordinary education be neglected because of the attention demanded for such scientific subjects as mechanics, magnetism, and electricity? On the contrary, it is found as a matter of fact, that the intellectual life of the school is quickened in every direction by the study of science. The scholars find that the "three R's" are not dull, dry, and abstract pursuits but keys to a world of new marvels and interests. The school under the Birmingham Board in which there is the keenest interest in science are certain to prove the schools in which the ordinary work is best done. Since 1880, when the science demonstrator was first appointed, the percentage of passes in the "three R's" has steadily increased, as well as the number of passes in specific subjects.

Year	Number of passes in specific subjects	Percentage of passes in the "three R's"
1880	841	84.7
1881	1724	88.4
1882	3114	92.6
1883	3150	89.6

} New Code with higher requirements }

Various causes have, no doubt, contributed to this result; but the proof is positive that the introduction of science *has not interfered*, to say the least, with elementary education in the "three R's."

V. On the first introduction of the system there may be a certain amount of antagonistic feeling aroused amongst some head masters and mistresses. In Birmingham this was indeed to some small extent the case. Some head teachers feared that the demonstrator would prove a new inspector, who, having to discharge duties as a teacher, might unduly interfere with their own functions, and that some conflict of authority might occur. To the best of my knowledge, however, this feeling has entirely disappeared. The only complaints which I hear as Chairman of the School Management Committee, are when the experimental lessons are omitted at any school through any stress of examination work or accidental circumstance. The masters find that the science demonstrators render them valuable assistance and do a work which it is out of their own power to accomplish.

In order to apply the severest test to the peripatetic system, I applied to the head master of a large school, situated in one of the very poorest districts in Birmingham, and attended by children whose social surroundings are, as a rule, almost as unfavourable to intellectual development as they can possibly be. The school has accommodation for 416 boys, and an average attendance of about 350, 414 being sometimes present during the week.

The reply of the head master to my request that he would inform me of the results of the science teaching in his school, lifts the whole question out of the region of controversy.

*Dartmouth Street Boys' Board School,  
Birmingham, September 9, 1884.*

Rev. Sir,—In reply to yours of this morning, I beg to make the following remarks:—

The results from the science lessons given in this school are very gratifying. I have seen results in a variety of ways both in and out of school.

The interest taken in these lessons, both by parents and boys, is surprising. Many a mother has, to my frequent knowledge, inconvenienced herself in her domestic duties on certain days when we have sent word for her boy to be present, as the science demonstrator was expected that morning. The day is well remembered by most of them, and eagerly looked forward to. The attendance in the uppermost class is wonderfully increased on the mornings these lessons are given.

The results in other subjects in those standards where science is taught are none the less satisfactory. A greater intelligence and thought are quickly discovered when we are dealing with the other subjects.

Teachers are more encouraged when brighter material to work with is placed in their hands.

Other important subjects have impressed me very much, viz. the desire of the boys after leaving school to continue to study some science subject at some of our science classes.

Older brothers, too, have been induced to go to science classes through seeing the growth of knowledge in those much younger than themselves.

Many persons who have reason to come in contact with the boys after leaving school, have expressed themselves in tones of great regret that such instruction was not given when they attended school.

I remain, Rev. Sir,  
Your obedient servant,

Rev. Dr. Crosskey. T. H. PURCELL

As a development of the systematic and experimental system of science training I have described—a system only rendered possible of adoption by the employment of the peripatetic method—a new kind of Board school has been opened in Birmingham, for the purpose of enabling the scientific work commenced in the elementary school to be continued by the more advanced scholars before they enter upon their respective employments in workshops and factories.

The arrangements of the peripatetic system will suffice until the sixth standard is passed; but special provision must be made for those lads who can remain a year or two longer at school, and whose future employments render the extension of their scientific training desirable. A large proportion of those who pass the sixth standard are obliged to earn their livings at once; for these various evening classes are available. But a certain number of working men can, by an effort, manage to exempt their children from toil, say for an extra two years.

The question therefore arises whether special provision cannot be made for scholars who must ultimately earn their living as working men, but whose parents can afford to keep them at school for two years after they have passed the sixth standard?

It is evident that for such scholars increased facilities for scientific study will have a peculiar, indeed almost an incalculable, importance.

They have been well grounded in the first principles of science and familiarised with the management of apparatus and the conduct of experiments during their school career. Their work in life will be largely increased, not only in pecuniary and mechanical, but in intellectual and moral value, by scientific knowledge.

To meet the wants of this class, a school has been opened as an experiment, in New Bridge Street, Birmingham, in premises belonging to the Chairman of the Board (Mr. George Dixon), who, at the cost of more than 2000*l.*, has adapted them for the purpose, and placed them rent free at the service of the Board.

The characteristics of this school are the following:—

I. It is especially intended for scholars who will have to become working men, but whose parents can keep them at school after they have passed the sixth standard, and the fee (3*l.* a week) is adapted to their means.

II. While a seventh standard school under the Code, the instruction given is largely scientific and technical; and a special staff of trained scientific men has been appointed. There is a special master for chemistry and metallurgy; another master for mechanics and physics; a drawing master; and a mathematical master; a highly qualified scientific man being placed at the head. Workshop instruction is provided, and includes a knowledge of the chief wood tools, and the properties of materials, while it supplements the mechanical drawing of the schoolroom, and is an aid to the study of theoretical mechanics.

III. The course of instruction is arranged to extend over two years. In the first year the scholars take ordinary standard work, together with mathematics, mechanics, drawing, chemistry, and workshop practice.

In the second year the study of mathematics will be continued, but it is intended that the scholars shall then specialise their studies in one of the following groups: (1) Chemistry and Metallurgy. (2) Mechanics and Machine Drawing. (3) Physics and Geometry.

The peculiarity of this scheme is that it is not an attempt to benefit a few picked scholars or to provide a higher-grade school for those able to pay high fees, but that it is a continuation of the science training given by means of the peripatetic method in every ordinary elementary school under the Board.

It has already been made evident that a large capacity for scientific investigation—amounting, I believe, almost to a special genius for the study of science—exists among our English people, which has never yet received its full and fair development. The country is undoubtedly awakening to the necessity of making better provision for the study of science, in order that our manufacturers may hold their own in the markets of the world. Other and higher blessings will follow in its train. Labour, in being made intelligent, will cease to be so loveless as it often is, and the lives of toiling thousands will be filled with larger interests, guided by finer tastes, and enriched with nobler joys.

#### THE ASSOCIATION OF GERMAN NATURALISTS AND PHYSICIANS

THE annual gathering of this influential Society was held this year at Magdeburg during the week ending September 23, simultaneously with the yearly meetings of the German Botanical and Meteorological Associations. The proceedings were opened by the President, Dr. Gæhde, whose address was followed with a few appropriate remarks by Prof. Hochheim on the services rendered to science by Guericke and other distinguished physicists.

The formal work of the meeting was opened with a paper by Prof. Rosenbach of Göttingen, on the microscopic organisms present in festering wounds. After a brief reference to the discoveries of Koch and Ogston, the author dwelt upon his own investigations, by which he claims to have proved that all purulent matter is primarily due to minute animal organisms. The

most widespread of these germs is a yellow micrococcus, which, owing to its hunchy disposition when seen under the microscope, he has called the "grape coccus." It displays great vitality, and even after twenty or thirty years may give rise to rheumatic affections of the bones and joints. Another common species is the "chain coccus," consisting of small granular bodies strung together and presenting the appearance of chains or wreaths (Pasteur's "*chapelets*").

Owing to the colonial policy at present agitating German political and commercial circles, great interest was taken in a paper by the African explorer, Gerhard Rohlfs, on the position of Africa with regard to Germany. It contained an historic sketch of the relations of Germany with the Dark Continent, recommended the establishment of factories or trading stations in favourable places, but uttered a warning note against any premature scheme of emigration to Africa.

The second general session opened with a memoir by Prof. Braun on the Island of Yesso and its inhabitants, dealing with its geographical features, the character and social usages of its Aino aborigines, and concluding with an expression of confident assurance that sooner or later Yesso must be drawn within the sphere of European culture. Some remarks followed by Dr. Huyssen of Halle on the deep borings in the North German lowlands. A sketch was given of the borings executed since 1868 at the expense of the Prussian Government, with special reference to the results obtained in the gypsum formations at Sprenberg, twenty miles south of Berlin. Here a bed of rock-salt was met at a depth of 283 feet, through which the boring was continued down to 4051½ feet without reaching the bottom of the deposit. An account was given of the new method of boring, by which it became possible to sink a shaft to a depth corresponding to the height of the Brocken in the Harz Mountains. The thermometric observations made in connection with these operations were stated to have fully confirmed previous views regarding the increased rate of temperature from the surface downwards.

Universal attention was attracted by the essay of Dr. Kirchhoff of Halle on "Darwinism and Racial Evolution," in which it was argued that the physical development of peoples was intimately dependent on the natural conditions of their respective surroundings. The inhabitants of northern lands are noted for a preponderance of the pulmonary functions; those of hot, moist, tropical regions for a more marked activity of the liver. Thus the strongest lungs prevail amongst the Mexicans, Peruvians, and Tibetans, who occupy the three highest plateaus on the surface of the globe. That adaptation to the environment is a question, not of "predestined harmony," but of natural selection, is shown by the evolution of the negro, the most perfect type of tropical man, who is found only in the Dark Continent. The daily pursuits of a people are, on the other hand, constantly evoking special organic peculiarities. This is shown most clearly in the keen sense of smell, sight, and hearing observed in all hunting and pastoral tribes of the highlands and steppe-lands, as well as in the sense of locality, and the surprising physical endurance under hunger, thirst, and other privations. Sexual selection, again, operates in the development of the body—head, hair, beard, and the like; in the style of dress and love of ornament; and lastly, in the formation of the national character, valour and ferocity being mainly conditioned in the savage, the economic and domestic virtues in civilised man, by the choice of partners in life, and the rejection of unqualified wooers in the "matrimonial market." But, apart from this consideration, the principle of selection prevails in the moral as well as in the physical order. As mankind pressed northwards, irrepressible spirits alone could sustain life under the depressing influences of bleak, Arctic surroundings. Hence the remarkably cheerful temperament of the Eskimo, who are also bred to peaceful habits, for peacefully-disposed families alone could dwell under a common roof, as the Eskimo are fain to do in the total absence of fuel. Through over-population the Chinese have become the most frugal and industrious of peoples, in recent times emigrating to foreign lands and crowding out all more indolent or pretentious races. In the international struggle for existence physical and moral superiority must always tell in the long run.

Even greater interest was taken in Prof. Finkler's paper, read with demonstrations on the bacillus of cholera and its culture. An outbreak of this epidemic last July at Bonn gave Prof. Finkler and Dr. Prior an opportunity of applying Koch's method to the study of the comma-shaped bacillus, which showed a remarkable resemblance to that of Asiatic

cholera cultivated by Koch. It was found associated with large masses of the spiral-shaped organism, but with no other germ of specific appearance. These forms could not be detected in preparations of normal or any other pathological excreta under the same method of treatment. But after several failures a comma bacillus was obtained, which in its nourishment, period of evolution, and temperature behaved exactly like corresponding cultures obtained by Koch from true cholera. Still differences occurred in respect of the successive stages of evolution, which inferentially affects the question of the permanent form of the germs. After some time they become thicker, and assume somewhat the form of a whetstone, while at both extremities spore-like forms make their appearance, and take the shape of spore-bearers. Both spores are presently extruded from the spore-bearers, and begin to crawl about under the microscope. They assume the form first of straight, then of crooked rods, which develop into spirals of diverse shape, length, and curvature. Becoming thicker and swollen, these spirals in their final evolution seem to consist exclusively of small comma bacilli. But whereas the comma of Asiatic cholera, at least according to Koch's investigations, develops no permanent form, these acquire a stability in the spore state capable of resisting the process of putrefaction. Their behaviour, however, when being desiccated or subjected to chemical agents has not yet been tested by Prof. Finkler. Between the prepared specimens of cholera nostras and true cholera bacilli exhibited under the microscope no optical difference could be detected. Owing to the attitude of most German physicians, who regard it as a patriotic duty to hold Koch's doctrine as unassailable, while the German scientific journals persistently ignore the objections urged by eminent foreign investigators against the theory, Prof. Finkler's statements naturally excited considerable sensation, giving rise to an animated discussion, without however arriving at any positive results. In any case a severe blow was given to the assumption of Koch's infallibility, although Prof. Finkler and Dr. Prior have so far failed to determine the true pathogenetic and pathognostic functions of their cholera nostras comma bacillus, as completely as Koch has for his Asiatic cholera comma bacillus.

In the Section devoted to Mathematics, Astronomy, and Geodesy, Dr. Spörer of Potsdam discoursed on the determination of the elements of rotation in the sun, and on the origin of the solar spots. The theory was advocated of currents setting steadily towards the surface of the sun both from within and without.

Discussing the subject of comets' tails, Dr. A. Marcuse of Berlin assumed that the sun acted like an electro-magnet, and that the normal tails of comets consisted of diamagnetic material (carburets of hydrogen), whereas the abnormal tails, that is, those directed towards the sun, consisted of paramagnetic materials, such as iron.

In the Physical Section papers were read by Prof. Knoblauch of Halle on two fresh attempts to determine the angle of polarisation of metals; by Prof. Overbeck of Halle on galvanic polarisation; by Prof. Ostwald on galvanic resistance, dividing the acids in relation to the velocity of electrolytic-chemical reaction into three sharply separated groups according as they are uni-, bi-, or tri-basic; by Prof. Spörer on eruptions breaking through the nucleus of a solar spot; and by Prof. Recknagel on atmospheric resistance, arguing against Lössel that it increases with the size of the plates when these are circular.

The Meteorological Section, coinciding with the annual meeting of the German Meteorological Society under the presidency of Prof. Neumayer, was unusually well attended. Amongst the foreign honorary members elected on this occasion were Prof. W. Ferrel of Washington, Prof. H. Mohn of Christiania, and Prof. H. Wild of St. Petersburg. In his address on the development of meteorology and its importance to the State and society, Prof. Neumayer dwelt especially on the influence of Dove, Sabine, and other investigators, as well as of the various Polar expeditions and of the British Association on the general advancement of meteorological studies. In a second discourse he referred to the importance of synoptic studies in the South Atlantic Ocean, pointing to the results already obtained from observations taken in high southern latitudes, and urging the necessity of further investigation in the same regions.

Dr. Köppen of Hamburg followed with a paper on the principles determining the distribution of meteorological stations. Discussing the question of atmospheric electricity and lightning, Dr. E. Hoppe of Hamburg argued that the ascent of a warm atmospheric current must give rise to a thunderstorm as soon as it acquires sufficient velocity to prevent the equilibrium of the

electric current generated through the condensation produced by friction. Prof. Kiessling of Hamburg made some remarks on the diffraction colours in artificially-produced fog and their connection with the recent crepuscular phenomena. In the same department papers were submitted by Dr. Münter of Herford, on the cause of winds, and by Dr. Köppen of Hamburg, on barometric disturbances during storms.

In the Chemical Section the chief speakers were: Dr. Frank of Charlottenburg, on the past technical development of the alkali works at Stassfurt, where, in July 1882, 20,000,000 cwts. of carnallite were consumed in the preparation of chloride of potassium; Prof. Poleck and Dr. T. Schiff of Breslau, on the essential oil of *Sassafras officinalis*, Neer; Prof. Poleck, on talapin; Dr. Arrhenius, on the conductive force of the electrolyte; Prof. C. Willöröd of Friburg (Baden), a contribution to the study of acetonebromoforn and acetonechloroforn; Prof. E. Lippmann, on a new method of representing oxygenous compounds; Dr. Leuckart of Göttingen, on a synthesis of aromatic monocarbon acids, dealing with the reciprocal action of aromatic carburets of hydrogen and cyanates in the presence of chloride of aluminium.

In the Geological and Mineralogical Section papers were read by Prof. Lossen of Berlin on the peculiar features of the geology of the Hartz Mountains; by Prof. von Fritsch of Halle on the Cretaceous floras of the Hartz; by Prof. Nehring on the diluvial fauna of the province of Sachsen and conterminous districts; by Dr. Wahnschaffe of Berlin on the Quaternary formations in the neighbourhood of Magdeburg; by Engineer Petsch of Aschersleben on the subsidence of underground waters during the process of freezing.

In the Botanical Section Prof. E. C. Hansen of Copenhagen described some new researches on certain fungi of vinous fermentation found in cow-dung and on sweet succulent fruits; A. Zimmermann, on the action of the optical elastic ellipsoid of vegetable tissues in the process of expansion: from a study of the tissues of *Nitella flexilis* and some other plants, the author concluded against Noegeli that in optical respects no fundamental contrast exists between organic and inorganic substances; W. Detmer on the formation of muriatic acid in plants; Prof. Soraner on the action of artificial freezing, describing the conduct of various vegetable tissues under the freezing process; Dr. Kaiser on the results of the determination of fossil leafy plants.

In the Section for Zoology and Comparative Anatomy, Prof. Landois of Münster spoke on the development of the shell of certain birds' eggs; Dr. H. F. Kessler of Cassel, on the evolution and life-history of the blood parasite, *Schizoneura lanigera*, Hausm.; Prof. Nehring of Berlin, on the skull and skeleton of the Peruvian dogs from the Necropolis of Ancon, with remarks on their origin: on the ground of his comparative studies, the author inferred that these dogs must have sprung from some variety of the North American wolf (*Lupus occidentalis*); Dr. Müllendorf of Berlin, on the importance of the formic acid found in honey: when closing the cells of the honeycomb, the bees mix the honey with formic acid in order to give it greater consistency; Prof. Leuckart of Leipzig, on a new species of Nematode found in the body of *Hyllobius pici*, 3 mm. long, 1 mm. thick, and named *All-niema mirabile*; Prof. W. Blasius, on some fresh data in connection with the remains of *Alea impennis*, Linn.

The excursions with which the proceedings were diversified included visits to the model Meteorological Observatory of the Magdeburg Zeitung, to the neighbouring chemical works of Stassfurt, to the University of Halle, and to the Hartz Mountains.

It was announced that the Association would hold its next annual meeting at Strasburg.

### SCIENTIFIC SERIALS

*Journal of the Franklin Institute*, No. 3, September 1884.—Synchronous-multiplex telegraphy in actual practice, by Prof. Edwin J. Houston (illustrated).—An extraordinary experiment in synchronous-multiplex telegraphy, by Prof. Edwin J. Houston.—On the application of electricity as an illuminating agent in astronomical observatories, by W. S. Franks.—A metastatic heat regulator, by N. A. Randolph, M.D. (one figure).—The drying of gunpowder magazines, by Prof. C. E. Munroe, U.S.N.A.—On an explanation of Hall's phenomenon, by Sheldford Bidwell, M.A., LL.B. (table).—Instruction in mechanical

engineering, by Prof. R. H. Thurston.—Report on the trial of the "City of Fall River," by J. E. Sague, M.E., and J. B. Adger, M.E. (concluded from p. 115) (tables and diagrams).—Report of the Board of Experts on Street-paving (tables).—Surveys for the future water-supply of Philadelphia, by Rupert Hering, C.E. (tables).—Methods in physical astronomy.—Solar motor and solar temperature.—Hirn's actinometer.—Soap-roots.—Aluminium and aluminium-bronze.—Palmieri's atmospheric electricity.—New electro-magnet.—Tanning by electricity.—Gases in steel.—The volcanic ashes of Krakatoa.—Papal Observatory.—Origin of volcanic activity.—Balloon photography.

*Verhandlungen des naturhistorischen Vereins der Rheinlande und Westfalens*, January-June.—Report on the proceedings of the Society during the year 1883.—On the recent chalk and diluvium formations of the Mülheim district, by Dr. Deicke.—On the disposition of the stratified rocks and lias in the neighbourhood of Herford, by H. Monke.—Report on the fossils of the greensand rocks in the district of Aix-la-Chapelle, by J. Böhm.—On the fishes, crustaceans, and flora of the Upper Chalk system in Westphalia, by Dr. Marck.—On the digestive organs of the spider, by Prof. Bertkau.—On the human skull found associated with the mammoth, rhinoceros, and reindeer in the loess of Pollbaba near Prague, by Prof. Schaffhausen.—On some fossil remains from the Devonian rocks of Eifel, by Prof. Schluter.—A contribution to the physiology and anatomy of *Dasyatis hirtipes* (two plates), by Dr. Hermann Müller.—On the diorite of the Upper Ruhr Valley and its association with the argillaceous schist of the same district, by Dr. A. Schneck.—On the causes of the great oscillations and disturbances in the crust of the earth, by F. P. von Dücker.—On the occurrence of fossil wood in the region of the Westphalian Coal-Measures, by W. Wedekind.—On the mutual relations of the Middle Eocene formations of Monte Postale, Ronca, and San Giovanni Marione, by Dr. H. Kauff.

*Rendiconti del R. Istituto Lombardo*, July 31.—Some reflections on the proposed laws for regulating the administration of public and private lunatic asylums in Italy, by Dr. C. Zucchi.—Various researches on the Bacillus of tuberculosis, by Prof. Giuseppe Sormani.—Description of a continuous registrar of electric energy transmitted at any given point of a circuit, by Prof. R. Ferrini.—On the geometrical surface of the third order, by Prof. E. Bertini.—Remarks on the Turin Gloss on the Institutions and Paraphrase of Pseudotheophilus, by Prof. C. Ferrini.—Meteorological observations made at the Brera Observatory, Milan, during the month of July 1884.

*Rivista Scientifico-Industriale*, August 15.—Results of experiments on the variations of electric resistance of argentan wire subject to tension, by Dr. Sebastiano L. Angelini.—Experiments on the compressibility of fluids, and especially of water, by Prof. Pagliani and Dr. S. Vicentini.—Observations on the struggle for existence between *Staphylinus olens* and *Lumbricus agricola*, by Silvio Calloni.

August 30.—Description of a universal anemometrograph (wind-gauge) recently invented by Prof. Michele Cagnassi.—Remarks on an elementary demonstration relating to the theory of the potential, by Giuseppe Vanni.—Remarks on the variations in the electric resistance of solid and pure metal wires under changes of temperature, by Prof. Angelo Emo.

*Bulletin de la Société des Naturalistes de Moscou*, 1883, No. 4.—On the seeming anomalies in the structure of the great comet of 1744, by Th. Bredichin (in French), with plates. It appears from calculations, illustrated by a plate, that the strips observed on this comet correspond to the "synchrocal" curves of the author deduced in the hypothesis of repulsive force.—Some remarks on comets, by the same. The initial speed of their appendages towards the sun is approximately deduced at 2000 m. per second.—On the tail of the first type of the comet 1858 V., by A. Sokoloff (in French), being a calculation of "synchrocal" curves according to Bredichin's method.—On *Cosmos pinitorquum*, A. Br., by Ed. Kern (in German), with 4 plates.—Remarks on the geological map of the Vetluga region, by H. Trautschold.—A new Pleurotoma (*Renardii*) from the Miocene of Italy, by De Gregorio.—A new demonstration of the theorem of Lambert, by N. Joukovsky (in French); it is based on the formula of variation of action.—Materials for the geology of the Crimea, by W. Sokoloff (in Russian), being notes on the Jurassic and Neocomian deposits in the neighbourhood of Simferopol.—On the recent work of the United States geologists, by H. Trautschold.—Letter from Dr. Regel, from Tashkend.

## SOCIETIES AND ACADEMIES

PARIS

**Academy of Sciences, October 13.**—M. Rolland, President, in the chair.—Note on the theory of the figure of the earth, by M. F. Tisserand.—On the decomposition of the oxide of copper by heat, by MM. Debray and Joannis.—Note on the sulphuret of carbon, and the application of a solution of this substance in water to the treatment of the vine attacked by phylloxera, by M. Eug. Peligot. Its solubility in water is shown to be considerably greater than that recently determined by M. Ckiandi. At the ordinary temperature water dissolves 3.5 c.c. per litre, or 4.52 grm., its density being 1.293. Its antiseptic properties have also been fully confirmed by the further investigations of M. Pasteur, who anticipates that it will become the most efficacious of all antiseptics, it being also the cheapest, costing only a few centimes per litre. It is, moreover, the best known insecticide, and has already rendered great services in the destruction of phylloxera. At present 30,000 hectares of vineyards are yearly treated with over four million kilogrammes of the sulphuret of carbon with excellent results. When applied in the form of a sulphocarbonate of potassium it has a double action, the sulphuret killing the insect, and the potassa, an essentially fertilising element, enriching the soil.—On the nitrates present in plants (continued), by MM. Berthelot and André. Their distribution during the various periods of vegetable growth, and their relation to the total proportion of the fundamental elements, potassium and nitre, contained simultaneously in the leaves, stem, root, and flower, are discussed by the authors.—Observations made at the Observatory of Marseilles during the recent total eclipse of the moon, by MM. Stéphan and Borely. The occultations of several stars contained in the list supplied for the purpose by M. Struve of the Pulkowa Observatory were observed.—Note on the map of the erratic phenomena and ancient glaciers on the northern slope of the Swiss Alps and of the Mont Blanc range, by M. Alph. Favre. This map, drawn to the scale of 1 : 250,000, indicates the extreme development of the old glaciers, and, as far as possible, the glacial drift, erratic boulders, and moraines deposited in this region during the period of glaciation. The glacier basins, marked in different colours, by no means coincide with the present hydrographic systems of the country. Six great glaciers are enumerated: that of the Arve, stretching from Mont Blanc to Lake Bourget; that of the Rhone, running from Furca in one direction to Lyons, in another to the Rhine near Laufenburg; that of the Aar, extending from the glaciers of that name to Berne; that of the Reuss, issuing from Mont Saint-Gothard and terminating near the Rhine; that of the Limmat, stretching from the Glaris highlands to the Rhine; lastly, the vast glacier of the Rhine issuing from the Grisons, traversing Suabia, and terminating near Sigmaringen on the left bank of the Danube.—Observations made at the Observatory of Marseilles of the planets 240 and 241, and of Max Wolf's new comet, by M. Stéphan.—Description of a new galvanometer with astatic needles (one illustration), by M. E. Ducretet.—Note on the mechanical dislocation of the persistent images left on the retina of the eye after gazing on highly illuminated bodies (one illustration), by M. F. P. Le Roux.—Note on a preparation of trichloruretted camphor, by M. Cazeneuve.—Description of the first larva from the egg of *Epicauta verticalis*, by M. H. Beauregard.—Note on two new species of simple Ascidians (family of the Phallusiadæ), by M. Roule.—On the anatomical structure of *Auchynia rubra*, by M. N. Wagner.—Account of a new insect of the genus Phylloxera (*Phylloxera salicis*, Lichtenstein), by M. J. Lichtenstein.—Note on a meteor recently observed near Royan, by M. Chapel.—Remarks on M. Paul Venukoff's new work "On the Deposits of Devonian Formation in Russia," by M. Daubrée.—Note on a block of pumice found on April 13, fifteen miles off the Madagascar coast, in 14° 35' S. lat., 48° 2' E. long., and supposed to have come from the Krakatoa eruption, by M. Alph. Milne-Edwards.

STOCKHOLM

**Society of Natural Sciences, September 20.**—Prof. Sandahl, President, in the chair.—Dr. Wille gave an account of his researches this summer at the zoologico-botanic station established at Dr. Regnell's expense at Kristineberg, in the province of Bohus, as to the mechanical power of the higher Algae to endure strain, and thereby resist the swell of the sea. He described his method, and gave an account of the strain which strips of Algae of certain lengths and thicknesses could bear. He found that they possessed a very high degree of

resistance and elasticity, but that when the weight was removed they retained some of the additional length caused by the strain. As might be expected, the power of resistance was greater in the lower than the upper parts, as the former suffer a far greater strain than the latter from the swell of the sea. He further referred to the anatomical causes of this, which were due to the circumstance that the specific mechanical cells which had to resist the strain were preferably developed in the lower parts, and to the fact that, as the plant grew, special organs of strengthening—they might be called moorings—were successively dropped to the bottom from the sides of the Algae, and in some cases even developed through the membrane downwards. The lecture was illustrated by means of drawings.—Dr. Thedenius exhibited a specimen of the moss *Riccia natans*, taken by him the same day at Sundbyberg, the only spot in Scandinavia where it grows. He also exhibited a hitherto unknown hybrid of *Trapozoon porrifolius* and *T. minor*, which had grown in his garden this summer, where both grow, and referred to the hybrid of *T. porrifolius* and *T. pratensis* found some time ago at Karlskrona. He also exhibited *Bryonia dioica*, a species never before grown in Sweden, which he had found in his garden.—The Secretary referred to an article forwarded to the Society on the East Indian plant *Abrus precatorius*, according to which a particular variety of Bacillus had been discovered in the poisonous infusion of its seed, which demonstrated that infectious diseases could be transmitted by plants, and pointed out that Dr. Widmark, a Swedish botanist, had recently shown that the Bacteria were not originally in the infusion in question, but that it only served to sustain the Bacteria which had immigrated thither from the air. He concluded by mentioning the well-known but inexplicable phenomenon of *Pinguicula vulgaris* having the effect of curdling milk when the vessels containing the latter had been rubbed with the butterwort, which was most probably due to microbes.

**Botanical Society, September 27.**—Prof. V. B. Wittrock, President, in the chair.—The meeting was the first one of the winter term.—On the diseases of cultivated plants in Sweden, by Herr J. Eriksson.—On the geographical extension of some rare Swedish Phanerogams, by the President.—On the 13th and 14th fasciculæ of the work "Algae aquæ dulcis, exsiccatae, quas distribuerunt Veit Wittrock et Otto Nordstedt," which had recently appeared, by the same.

## CONTENTS

	PAGE
Field and Garden Crops. By George Murray . . .	605
Our Book Shelf:—	
Cory's "How to Foretell the Weather with the Pocket Spectroscope"	606
Lynn's "Celestial Motion: A Handy Book of Astronomy"	606
Casey's "First Six Books of the Elements of Euclid, and Props. i.-xxi. of Book xi."	606
Letters to the Editor:—	
The Sky-Glows.—E. Brown; J. Edmund Clark .	607
Cole's Flits.—Joseph Stevens . . . . .	607
Circular Rainbow.—W. Symons . . . . .	607
The New Geological Map of Russia . . . . .	608
Earthquakes. By Dr. H. J. Johnston-Lavis. (Illustrated)	608
International Weights and Measures . . . . .	612
Notes . . . . .	613
Our Astronomical Column:—	
Wolf's Comet . . . . .	615
The November Meteors . . . . .	615
New Southern Double-Stars . . . . .	616
The Total Solar Eclipse of 1816, November 19 . . . . .	616
Chemical Notes . . . . .	616
American Ornithologists' Union . . . . .	616
The Capillary Constants of Liquids at their Boiling-Points . . . . .	618
Researches on the Origin and Life-Histories of the Least and Lowest Living Things. By Rev. W. H. Dallinger, LL.D., F.R.S. (Illustrated)	619
The Peripatetic Method of Instruction in Science and its Development. By Henry W. Crosskey, LL.D. . . . .	622
The Association of German Naturalists and Physicians . . . . .	625
Scientific Serials . . . . .	627
Societies and Academies . . . . .	628

THURSDAY, OCTOBER 30, 1884

## THE CHOLERA EPIDEMIC OF 1884

THE reappearance of cholera in an epidemic form in European countries after a comparatively long absence is a matter of considerable concern, not only on account of the severity of the existing epidemic but also in connection with the prospects which are in view with respect to the coming year. A great westward diffusion of cholera in the Eastern Hemisphere began in 1863, it was continued almost uninterruptedly to 1873, and the disease not only clung with considerable tenacity to certain towns and districts for two and three years at a time, but in some cases after it had apparently subsided for good, there came recrudescences of the disease after long intervals. From 1873 to the present year the greatest danger which Europe has incurred as regards cholera was during the Egyptian epidemic in 1883, but there is no reason to believe that the outbreak which is still prevailing in Southern Europe was in any way connected with that epidemic. On the contrary the evidence tends to show that it was imported by means of an imperfectly disinfected vessel, the *Sarthe*, on which cases of cholera had occurred.

Toulon was first infected about June 18, and from that date up to the present time, when only occasional deaths take place, nearly 880 fatal cases have been officially recorded there. The first cholera deaths in Marseilles occurred on June 27, the disease spread with great rapidity, reached its most fatal stage about the middle of July, and, including the few deaths that are now and again still registered there, the total mortality, according to official records, has fallen but little short of 1700. During the third week of July scattered cholera deaths occurred in a large number of the southern departments, in many localities the disease spread widely, and even during the earlier part of the present month, fresh deaths were still recorded from the department of the Pyrénées Orientales. In all, the French cholera mortality which has been recognised in official publications has, during the present year, not fallen far short of 3500.

Towards the third week in July cholera had made its appearance in Italy, and it spread with great rapidity during the month of August through the north-western part of the kingdom. Towards the end of the month several places in the south, including Naples, became infected. During September the diffusion in the north, as also in and around Naples, greatly increased; the mortality in certain towns, such as Naples, Spezia, Busca, and Genoa being very heavy. A general subsidence of the disease has now set in, but the published mortality already reaches nearly 10,300, over 6500 of the deaths having taken place in the city of Naples.

In Spain the epidemic was first officially recognised during the first week of September; it has been to a large extent limited to the province of Alicante, which abuts on the Mediterranean, and since the middle of October no further cholera deaths have been recorded. Some 100 fatal attacks are, however, known of. But whether it be Spain, Italy, or France that is in question, it is more than doubtful whether the statistics hitherto published by

any means include the total deaths that have occurred. The French records are probably the most correct, but these will have to be revised before they can be regarded as in any way accurately representing the extent of the epidemic.

The very general subsidence of the epidemic which has now set in suggests two questions which are of great international importance. In the first place:—What experience has the epidemic afforded as to the measures which should properly be taken to stay the spread of cholera? The system of sanitary defence which has been adopted by France, Italy, and Spain has been quarantine; the energies of all three countries have been engaged in enforcing the system of land quarantine, with its sanitary cordons, its lazarettos, and its fumigations; and that system has utterly broken down at all points. In France the absolute impossibility of maintaining it and the uselessness of adhering to it only in part led, early in the course of the epidemic, to its abandonment, except in so far as the maintenance of certain processes of fumigation, in order to satisfy the public, are concerned. But with Italy the matter was different. No advantage had been taken of the lesson taught and bitterly enforced during the previous Italian epidemics, as to the intimate connection which exists between cholera and the retention about human dwellings of those conditions which befoul both air and water; filth abounded in by far the majority of her cities, towns, and villages; her only chance was to trust in that which had failed her before, and she clung to her cordons of troops and other allied measures with a tenacity that could not well be exceeded. But, as was pointed out by Mr. Simon many years ago, quarantine is impracticable except when planned with the precision of a scientific experiment and conducted with extreme rigour, and even then it is not conceivable as a system of national defence for the purposes of countries communicating with each other by means of great highways of traffic and of commerce. And so it has turned out. Cholera took no heed of the lines of troops, whether at the frontier or around the infected districts; it diffused itself along the lines of human intercourse as if without let or hindrance, and the very cordons and lazarettos assisted in the process of the spread; for the fear of the cordons led to the flight of an infected population before the line of bayonets could be established, and the lazarettos became, by the mere aggregation of sick and healthy under conditions as unwholesome as can well be conceived, fresh centres of infection. If it were not that the prejudices of an ignorant public had to be taken into account, land quarantine in Western Europe would probably never be heard of again. So far as measures of sea quarantine are concerned, it suffices to say that, according to the *Revue d'Hygiène*, Algeria became infected early in October by means of its communications with the southern ports of France, and the diffusion of the disease to Spain must be regarded as having taken place by means of the sea-port of Alicante. In short, everything that has occurred during the present epidemic, including such occasional importations of choleraic cases into our ports as occurred last month at Cardiff, has gone to show that the substitution by this country of a system of medical inspection and of isolation in the place of quarantine has, both in its direct application and by the

removal of an untrustworthy system of defence, materially added to our national safety against the importation of infection.

The second question which suggests itself is:—What are the cholera prospects for Europe and this country during 1885? This question is one which it is by no means easy to answer, for to a great extent it must necessarily depend on the action that may have been and still will be taken for the removal of the conditions which are favourable to the diffusion of cholera. From the middle of 1865 to the beginning of 1869 there was probably no time when Europe could be regarded as free from the disease, and it was doubtless only a recrudescence of the same disease that led to the five years' outbreak which, commencing during the summer of 1869, was destined to prevail in one or other part of Europe up to 1874. Or to take individual countries and towns. According to the report of the late Mr. Netten Radcliffe, all the Italian provinces which suffered from cholera in 1865, with three exceptions, were again affected in 1866; the epidemic culminated in 1867, and only came to an end in January 1868. Again, the disease was more extensively diffused through France in 1866 than even in 1865; in 1867 it continued in departments previously infected, and it reappeared in some where it had ceased. In the province of Naples, cholera, commencing in 1865, did not cease until 1867. But fortunately such maintained and recurring prevalences are not the invariable rule, and even the last Neapolitan epidemic of 1873 was of much shorter duration than the earlier ones had been. The common theory that a cholera outbreak in one year is almost certain to be followed by a second one the next year is not a law of epidemics; the fact is rather due either to the failure to remove infected matter left over from the first epidemic, or, as in the case of England in 1865-66, to fresh importation of infection. In brief, it is the sanitary state of Naples, Spezia, parts of Toulon and Marseilles, and such like places, that mainly affords grounds for the fear that no intervention of winter weather can, apart from the adoption of sanitary measures on a wide scale, free the infected places from a contagium which, if left behind, may renew its activity next season. On the other hand, the maintenance of conditions of wholesome cleanliness should give a guarantee that even a fresh importation may fail to spread. Numerous importations took place into this country in 1873, and all proved abortive. Our sanitary authorities can insure a like success in 1885, even if the disease be either maintained or reappear next year in Southern Europe.

#### DYNAMO-ELECTRIC MACHINERY

*Dynamo-Electric Machinery.* By Prof. Silvanus P. Thompson. (London: E. and F. N. Spon, 1884.)

PROF. SILVANUS P. THOMPSON has undertaken the task of filling up a most important want in our scientific and technical literature; and he is to be congratulated and warmly thanked for the manner in which the task has been performed. Of the want of a scientific and practical work on dynamo-electric machinery there can be no question. The subject is at present exciting more general attention than was, perhaps, ever before given to any invention, not even excluding the steam-

engine or the electric telegraph. The electric light effects are fascinating to a degree; and in these days of exhibitions and displays the natural interest in one of the most beautiful inventions has been fostered even beyond that which is natural: while speculation and even the promises of "electric light in our homes" have led to excitement which has been equally disastrous to the hopes of the many and to the progress of electric lighting itself. We are now entering it is to be hoped, or indeed have already entered, upon a more satisfactory state of things, in which hard and steady work and careful scientific investigation of every point on which efficiency and advantage in electric lighting depends will quietly bring forth an appropriate reward; and will gradually sweep away the painful impressions left by the failures of would-be electricians and of bubble companies.

Information on the subject of dynamo-electric machinery up to the present time has been very much diffused and not convenient for access, and there was great need of a careful hand to bring together as much of it as was really valuable. It consisted chiefly of a multitude of articles in the two English and two or three foreign electrical journals, and a few papers to the learned societies, generally on some special class of machine. (Of English books we have scarcely any of importance except those of Mr. James Dredge and of Mr. J. E. H. Gordon, useful in their way as very handsome picture-books, and the former affording admirable detailed and figured diagrams, and a complete list of the legion of recent electric patents. A book of moderate dimensions, and written from a scientific point of view, will be welcomed alike by practical men and by theoretical students of this subject.)

In Prof. Thompson's "Dynamo-Electric Machinery" we find, in five preliminary chapters, a satisfactory description of the properties of the magnetic field and of the effect of moving a coil within it; of ideal simple dynamos of different forms, accompanied by curves showing the electromotive forces produced by the rotation of rudimentary coils, the effect of superposition of electromotive forces, and the effect of the commutator. The series dynamo, shunt dynamo, and the compound-wound dynamo are likewise described in simplified form in these preliminary chapters, and likewise the various effects of electro-magnetic induction; and from these preliminary remarks there follows a long list of practical conclusions.

Chapter VI. is devoted to the government of dynamos, a subject which has engrossed a large share of the attention of practical inventors during the last four or five years. So long as electric lighting was carried on with arc lamps alone, and when the arc lamps were so imperfect as they were at that period, irregularities in the action of the dynamo machine were little noticeable in comparison with the irregularities of the arc itself. The use of the incandescent lamp, however, soon made these irregularities only too apparent; and attempts to rectify this defect in the dynamo have given rise to improvements of a very substantial character, not only as to regularity but in economy, and also in other and less important matters.

Following these preliminary chapters we find a very full and very interesting description of all the really important existing dynamos, with an account of their peculiarities and of the purposes for which each is specially

adapted. Prof. Thompson has chosen to classify dynamos according to the nature of the field of force and the manner in which the armature moves in the field of force. It is doubtless difficult to find any very satisfactory mode of classification of these machines: but the reason for the particular classification adopted here is certainly not apparent in the descriptive chapters, in which the nature and effect of the field in the various machines is perhaps the point on which a great deal of information would be desirable. The diagrams and figures in these chapters are all that could be wished for. They are admirably chosen and are well executed.

The mathematical theory of the dynamo machine has of late received considerable accessions; though much yet remains to be done in working out a satisfactory theory by mathematics and experiment combined. The fundamental principles are well known. The experiments of Faraday and Joule, and the mathematical investigations of Helmholtz, Sir William Thomson, and Clerk-Maxwell have formed a good foundation; and considerable advances have recently been made by the labours of Joubert, Mascart, Hopkinson, and Marcel Deprez. The invention by Hopkinson of the "characteristic curve" is a most important step; and the study of these curves is at the present time doing for the dynamo machine the same thing that the study of Watt's indicator diagram does for the steam-engine.

Prof. Thompson devotes a considerable number of chapters to the mathematical theory of the dynamo, and his treatment of the subject is on the whole satisfactory. There are, however, a few points on which in our opinion it requires revision. (One of these is the notation; and it would be a great satisfaction if mathematicians and electricians could by some means—for instance, by appointing a committee for the purpose—agree upon some standard notation which would be convenient, and which would harmonise with notations commonly employed in dynamics and in general physics. In several points we could wish to see Prof. Thompson's notation different. It seems, to say the least, a very great pity to use the letter *H* in mathematical writing connected with magnetism for any purpose besides Earth's Horizontal Force, while the use of the letter *i* for strength of the current is only a perpetuation of French want of logic.

Prof. Thompson's formulas on the subject of efficiency of a motor are not satisfactory; and it is most unfortunate that he has allowed himself to be misled by his friend, Mr. W. M. Moorsom, into fancying an error in the fundamental equation of Joubert for an alternate-current dynamo. The investigation of Appendix IV. and the physical assumption that the coefficient of self-induction for the armature and the coefficient of mutual induction for the armature and electromagnets are approximately equal in all dynamos will not bear examination. It is more than doubtful whether there is any dynamo in which this is approximately true. Certainly it would not be true for the Siemens alternate-current machine, with which M. Joubert concerned himself. M. Joubert did not leave the matter as a question of supposition; but showed by experiment that the term which is concerned with mutual induction is unimportant, and that on this account the differential equation in question becomes manageable.

One other blemish we cannot pass over. It is the introduction of two or three new words which have been adopted without due weighing of the consequences. That mathematicians have been too slow to form words for new ideas we quite admit; and of the advantage of good words to express clear ideas there can be no question. Witness the comfort of having such words as "radian" for the unit angle, of "volt," "ampere," "watt." But word-making may be carried too far unless caution and judgment be used; and that words so grotesque as "torque" and as "gausses" should be adopted into the English language would be, to say the least, a very great misfortune.

The faults which we have found are, however, few, and not of vital importance, and in conclusion we must once more express our gratitude to Prof. Thompson for a very valuable work. We feel confident that it will find a very wide circle of usefulness and of appreciation.

#### OUR BOOK SHELF

*An Elementary Treatise on Conic Sections and Algebraic Geometry, with Numerous Examples and Hints for their Solution, especially designed for the Use of Beginners.* By G. Hale Puckle, M.A. (London: Macmillan & Co., 1884.)

WE are not often called upon to notice the fifth edition of a school text-book, but now that we have examined this one and compared it with our familiar third edition copy (issued in 1868) we are glad to be able to say that, though new editions have not appeared with the sensational rapidity of some similar works of late, yet with the steady advance in public favour there has been an evident desire on Mr. Puckle's part to bring up his work to the level of other treatises on the subject. Contrasting the two editions, we find there has been an increase from 343 to 379 pages, and not only has there been careful revision, but also an addition of very many articles of interest. It is to be borne in mind that no attempt is made to bring out a work which shall satisfy the requirements of a University man who is "reading high," but the writer's aim has throughout been to write a purely elementary treatise on the lines of Dr. Salmon's "Conics." Mr. Puckle rightly acknowledges his great indebtedness to this now classic work, and on the other hand it should be borne in mind that the first edition came out at a time when Salmon was not openly used as a *College* text-book at Cambridge. We are very glad to notice that Mr. Puckle has, in this last edition, adopted the notation of the general equation of the second order, according to Salmon. It is quite time that this notation should be adopted in all our text-books, for it is a needless burden upon the memory to get up the several conic formulæ under different forms. A useful addition has been made to the number of worked-out exercises. A result of the book's having reached a fifth edition is that we have not noted any errata in the text.

#### LETTERS TO THE EDITOR

[The Editor does not hold himself responsible for opinions expressed by his correspondents. Neither can he undertake to return, or to correspond with the writers of, rejected manuscripts. No notice is taken of anonymous communications.]

[The Editor urgently requests correspondents to keep their letters as short as possible. The pressure on his space is so great that it is impossible otherwise to insure the appearance even of communications containing interesting and novel facts.]

#### The Cretaceous Flora of North America

In the abstract of a paper on the above subject by Mr. J. Starkie Gardner in NATURE of September 25 (p. 528), it is stated that "the lowest beds (of the American Cretaceous) are



distinguished by the presence of well-developed dicotyledonous leaves"; and further on these are said to occur at "the very base" of the formation. Now though such statements are sometimes loosely made, it should be understood that American geologists generally acknowledge that the base of their Cretaceous is, in some localities at least, only equivalent to the base of the Upper Cretaceous of Europe. In Canada, at least, the strictly Mesozoic flora of the Lower Cretaceous has been clearly distinguished from the angiospermous flora of the middle and upper parts of the series.

The oldest Cretaceous beds known in Canada are, I believe, those of the Queen Charlotte Islands, referred by Mr. Whiteaves, on the evidence of animal fossils, to the Neocomian age. The flora of these, consisting of cycads and conifers only, without any trace of dicotyledonous leaves, was described by me in the Report of the Geological Survey for 1873, and I remarked at the time on its decidedly Mesozoic aspect. It will be seen by reference to my memoir on the Cretaceous floras of British Columbia and the North-West Territories, in the *Transactions of the Royal Society of Canada* for 1883, that the oldest angiospermous flora known at that time in Western America is that of the Dakota group, described by Lesquereux and supposed to be of Cenomanian age. We have not yet found any dicotyledonous leaves quite so old in Canada. Our oldest angiospermous flora occurs in beds referred by Dr. G. M. Dawson and Mr. Whiteaves to the Niobrara group, which is approximately of the age of the Chalk Marl of England, in so far as can be judged by its animal fossils. A detailed table of the beds is given in the memoir above referred to, and the facts are stated in general terms in the "Descriptive Sketch" of the geology of Canada which was distributed to the members of the British Association (p. 51).

It will thus be seen that, though our angiospermous flora may possibly have appeared somewhat earlier than that of Europe, the discrepancy is by no means so great as stated in the abstract referred to. The correct statement would be, in so far as Canada and the western parts of the United States are concerned, that the oldest angiosperms known in America are probably of Cenomanian age, and that the older Cretaceous contains only, so far as known, a flora of Mesozoic character. Concerning the limits of the Cretaceous and the Eocene on the one hand, and the limits of the Cretaceous and Jurassic on the other, there are no doubt some unsettled questions; but these do not affect the facts above stated.

J. WM. DAWSON

Montreal, October 9

SIR J. W. DAWSON'S correction only applies to the published abstract of my paper. The editor of the *Geological Magazine* having kindly offered to publish the full text, it will be seen that its scope was limited to Cretaceous dicotyledonous floras, and the older ones, to which Sir John calls attention, were purposely excluded. The title "Cretaceous-Eocene" was intended to imply that the subject was the border-land of these two formations; but I am greatly obliged for the note and the copy of the work which accompanied it.

J. S. G.

#### Palæolithic Implements from Cambridge

ONLY two implements of Palæolithic age have been recorded from the neighbourhood of Cambridge. One of these is a rude form picked off a heap of gravel near the Observatory, and the other was bought from some workmen, and was said by them to have come from the Barnwell gravel. There is therefore considerable interest attached to the discovery of an implement of this age on the plateau between Upper Hare Park and the Cambridge Newmarket Road. This plateau is part of one of the old river terraces which formerly abutted against the hills on the east, but is now cut off from them by the valley along which the railroad to Newmarket runs. It belongs to an earlier period than that of the Barnwell gravel.

Further to the south, near Lark's Hall, in gravels which probably belong to the same set of river terraces, remains of rhinoceros, &c., have been found, but hitherto no implements or other traces of the existence of Palæolithic man have been brought to light in that district.

The plateau near Upper Hare Park is all unfenced arable land, and the implement which I found buried in the surface soil with only a small part of its thicker end visible, had probably been turned up out of the gravel by the plough, its surface having the same general appearance as the flints derived from the gravel. It is of the tongue-shaped St. Acheul type, and has

a fine patinated surface. It measures  $5\frac{1}{4}$  inches in length, 3 inches across its broadest part, and nearly  $1\frac{1}{4}$  at its thickest. One end is rounded so as to be easy to hold in the hand, and from this it tapers gradually with a sharp cutting edge to the point. On each side of the implement the edge is curiously rough and shattered, owing to the original quality of the flint and the way in which the flakes broke off when it was being made.

Not very far from the spot where it was found, skirting the carriage-drive which leads up to the house, are several small hollows from which gravel has most likely been dug. In these hollows and all round their margin the ground is covered with flints belonging to the gravel, and amongst them I found quantities of flint chips, one or two very nicely-dressed flakes, and several scrapers.

Similar dressed flakes and scrapers are found in the caves of the South of France associated with implements of Palæolithic age; but in the case of those found near Upper Hare Park there is not sufficient evidence to prove whether they belong to the period of the gravel or were manufactured on its surface at some later period.

M. C. HUGHES

#### The Recent Lunar Eclipse

I WONDER whether any of the readers of *NATURE* who were witnesses to the almost total annihilation of the moon on Saturday night, October 4, noticed a rather strange peculiarity which was visible at about 10.50 p.m., both before and after second internal contact with shadow. When the peculiarity first appeared I cannot myself say, but I noticed it first at 10.43 when I went out to look for the almost invisible moon with the aid of a good opera-glass. In the accompanying diagram, which I have constructed from the data given in the almanacs, the moon is represented as just having emerged slightly from the shadow at 10.50 or so, when the peculiarity showed very distinctly, the moon having the appearance which is roughly represented

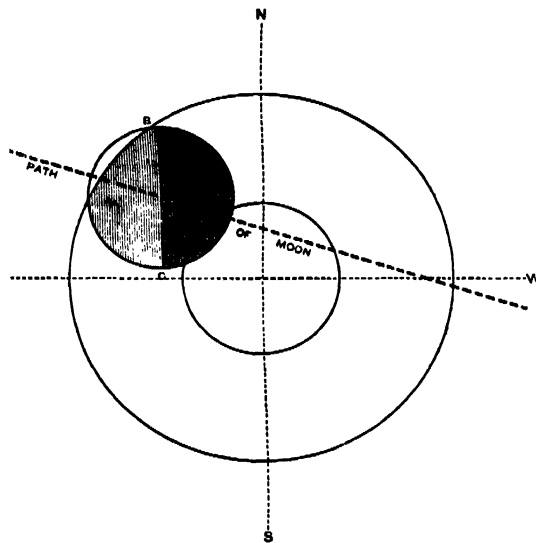

in the diagram, being apparently divided into two halves by a tolerably distinct line of demarcation (*bc*) running north and south (or towards the celestial pole), the right hand or westerly half appearing much darker than the left or easterly half. It is evident that an appearance like this, so striking when once noticed, could be produced in two ways, first, by the western hemisphere of the moon being actually darker than the left or eastern half; in which case the moon would have exhibited this appearance more or less throughout totality; but it did not, as I noticed nothing of the sort at 10.15, when looking through the same glasses, so that the second explanation must be resorted to. In the diagram the larger outer circle represents the border of the earth's shadow (in the case of this eclipse about 5750 miles in diameter) which is cast by the earth, irrespective of its atmosphere. The inner circle represents the border of an inner and darker shadow of the earth, cast by those of the sun's

rays which succeed in being refracted or bent round through our atmosphere (the amount of bending of the light extending to a maximum of about 70° in the lowest strata of the atmosphere). Into this inner circle, in this case about 2525 miles in diameter at the distance of the moon, no rays of light can stray except those which are scattered by our atmosphere as a sun-illuminated envelope. It is now very evident that the position of the dark patch bordered by the line (*b-c*) and lying partly over the western half of the moon, with respect to the earth's shadow, is very anomalous. If the line (*bc*) had been curved concentrically to the centre of the shadow, it would have been less surprising. The only way in which it can be accounted for is by supposing the earth's atmosphere to have been very opaque about the regions of the earth within the Arctic circle, allowing very little light, if any, to be refracted, and, tracing southwards that meridian along which the moon would be setting at the time, the atmosphere getting clearer and clearer, first in the upper strata and then in the lowest as we go southwards, until the equator is nearly reached. At 10.50 the moon would be illuminated by solar rays refracted by the earth's atmosphere and tangential to the earth's surface along the meridian 105° east of Greenwich (or thereabouts), which passes through Irkutsk (in Siberia), Mongolia, Tonquin, and Siam, along which line the inhabitants would see the moon going down veiled in its mysterious obscurity. It would be interesting to know whether any observers noticed, at about the middle of the eclipse, any contrast between the inner and darker shadow, in which the moon would be largely immersed, and the outer regions of the shadow which are illuminated dimly by both refracted and scattered light. The unusual darkness of this eclipse, surprising, as it must have done, all spectators, must be taken as a strong indication of great opacity in our atmosphere. Another noticeable feature was the unsymmetrical appearance of the illuminated crescent at 10.50, when the northern cusp (*b*) exhibited a bluish-white, shading off gradually from the brilliant white to the obscurity of the shadow, while the other cusp seemed quite sharp and distinct. Observing the eclipse both with the naked eye and through a 4½" equatorial, neither my fellow observers nor myself noticed any other indication of a blue fringe than that appearing just at *b*, which seemed to me therefore to be a real appearance, and not a subjective effect of contrast, as there was not complementary copper colour anywhere on the moon sufficiently strong to suggest the blue, and if there had been I ought to have noticed the blue fringe all along the edge of the shadow bordering on the crescent, but it appeared to me of a neutral grey.

Heworth Green, York

II. DENNIS TAYLOR

### The Red Light round the Sun—The Sun Blue or Green at Setting

I CAN confirm Mr. Backhouse's and Mr. E. D. Archibald's impression about the colour now and for some time past seen round the sun; that it first appeared about November last and has been more or less visible ever since. The colour was then, and still is, sometimes rose, sometimes amber or buff. It is best observed, when the sun on bright days is behind a cloud, round that cloud, in the place where, at other times, broken beams of shadow, thrown out from the cloud like a row of irregular palings and deepening the blue of the sky, are to be seen. Towards sunset it becomes glaring, and white and sallow in hue. Something of a circular shape may then perhaps be made out in it, but it does not seem to me that it ought to be called a halo. A halo, as I understand, is a ring, or at least a round space inclosed by a ring. This appearance has no ring round it. Also in a halo (I have seen numbers) it is the ring that is coloured—either throughout, or at four places where the ends of the four arms of a cross would rest upon it; and the inclosed field is uncoloured or coloured like the rest of the sky: here there is an uninclosed but singularly-coloured field.

But whether we call the appearance a halo or not is perhaps only a question of terms: to call it a corona, as Mr. Leslie does, is another, and, as it seems to me, a hazardous thing, because it would imply that what we are looking at is an appendage of the sun's own (and that too at a time when it is strongly doubted if the sun has a corona of any sort of all), instead of what is much easier to suppose, a terrestrial or atmospheric effect. If there is going on, as Mr. Leslie thinks, an "increase of sun power," this ought to be both felt and measured by exact instruments, not by the untrustworthy impressions of the eye. Now Prof. Piazz-Smyth says that sunlight, as tested by the spectroscope, is weaker, not stronger, since the

phenomena of last winter began. To set down variations in light and heat to changes in the sun when they may be explained by changes in our atmosphere, is like preferring the Ptolemaic to the Copernican system.

It is, however, right and important to distinguish phenomena really new from old ones first observed under new circumstances which make people unusually observant. A sun seen as green or blue for hours together is a phenomenon only witnessed after the late Krakaton eruptions (barring some rare reports of like appearances after like outbreaks, and under other exceptional conditions); but a sun which turns green or blue just at setting is, I believe, an old and, we may say, ordinary one, little remarked till lately. I have a note of witnessing it, with other persons of a company, in North Wales on June 23, 1877, the sunset being very clear and bright. It is, possibly, an optical effect only, due to a reaction (from the red or yellow sunset light, to its complementary colour) taking place in the over-strained eye at the moment when the light is suddenly cut off, either by the sun's disappearance or by his entering a much thicker belt of vapour, which, foreshortened as the vapour is close to the horizon, may happen almost instantaneously. And this is confirmed by a kindred phenomenon of sunset. If a very clear, unclouded sun is then gazed at, it often appears not convex, but hollow; swimming—like looking down into a boiling pot or a swinging pail, or into a bowl of quicksilver shaken; and of a lustrous but indistinct blue. The sky about it appears to swell up all round into a lip or brim, and this brim is coloured pink. The colour of the light will at that time be (though the eye becomes deadened to it) between red and yellow. Now it may be noticed that when a candle-flame is looked at through coloured glass, though everything else behind the glass is strongly stained with the colour, the flame is often nearly white: I suppose the light direct from the sun's disk not only to master the red and yellow of the vapour medium, but even, to the eye, to take on something of the complementary blue.

Even since writing the above I have witnessed, though slightly, the phenomenon of a blue setting. The sunset was bright this evening, the sun of a ruddy gold, which colour it kept till nothing was left of it but a star-like spot; then this spot turned, for the twinkling of an eye, a leaden or watery blue, and vanished.

There followed a glow as bright almost as those of last year. Between 6.15 and 6.30 (Dublin time) it was intense: bronzy near the earth; above like peach, or of the bluish colour on ripe hazels. It drew away southwards. It would seem as if the volcanic "wrack" had become a satellite to the earth, like Saturn's rings, and was subject to phases, of which we are now witnessing a vivid one.

G. M. H.

Dublin, October 19

### The Volcanic Dust (?) Phenomena

THE changeableness of the wisps of this dust (?) is surprising. On the 19th inst., near sunset, they were conspicuously visible in all parts of the great corona round the sun, being definite in form—narrow, and about 5° long; it was the first time I had seen them since (I believe) May 18, when they were only just perceptible. During the intervening period the film or portion of the atmosphere on which the universal sky phenomena have appeared has been perfectly uniform in texture. On the 20th inst. they were again conspicuous about sunset, extending faintly even beyond the great corona; they appeared horizontal in the north-west. They were more or less visible about the same time on the 23rd and 26th, on which latter date they could be distinguished faintly in the semicircle opposite the sun at 7.30 a.m. and 4.8 p.m.

It would be interesting to know how far the changes in their visibility are simultaneous over large districts: it appears that they are not universal, for Mr. R. Leslie (*NATURE*, October 16, p. 583) describes them as distinct though very small in the early part of July this year, at which period I never perceived a trace of them in Switzerland. I take the "cloud forms" Mr. Leslie describes to have been the same I am alluding to, though the colour seems to have then been too faint to be perceptible at Southampton. I cannot attempt to explain how the glare round the sun was visible to him in 1882 or earlier, when the red part of what seems to be the same phenomenon did not appear till so long after.

Observations on the motion of the wisps would be very useful in showing the movements of the upper currents of the atmosphere. I have made a few, but they are not very satisfactory.

The suggestion of Prof. E. Douglas Archibald (October 9, p. 560) that the dimensions of the great corona prove it to be caused by hexagonal prisms, as is the ordinary solar halo, is surely not tenable when its entirely different appearance and colour are considered; and it must arise from a different cause as hinted by Prof. Le Conte (vol. xxix. p. 403). The solar halo is a narrow ring brightest at a distance of about  $23^\circ$  from the sun; whereas this corona is brightest close to the sun, fading continuously, and at first rapidly, as the distance from the sun increases. It varies somewhat in colour, depending on the sun's altitude and other causes, but is always greenish or bluish near the sun, and at an estimated distance of  $7^\circ$  to  $10^\circ$  therefrom, rather abruptly changes to reddish or brownish. This colour is nearly the same for a great distance, though inclining to orange towards the sun, and to pink in its outer part. When seen under favourable circumstances (e.g. in Visp-thal) I have traced it faintly to a distance of fully  $75^\circ$ . The solar halo, on the other hand, is usually dull orange on the edge next the sun, and bluish towards the outside; and when its colours are very distinct, all the prismatic colours are visible, the red always being next the sun: so that the colours are in reverse order in the two phenomena, so far as they occur. Whether there is any ice concerned in the production of the corona or not, it cannot be in the form of hexagonal crystals, for there is no trace of the ordinary halo in connection with the corona; and whenever the two phenomena are visible together, the halo is always on true clouds.

Sunderland, October 27

T. W. BACKHOUSE

#### After-Glow

THE after-glow here on Sunday night, the 26th, at 6.45 p.m., was wonderfully grand, intensely bright golden colour extending from horizon to about  $45^\circ$ , and graduated into delicate rose, again graduating to pale ashy gray. Indeed at no period since first observing these after-glows (now over one year) have I seen one brighter.

Falmouth, October 28

ROBERT D. GIBNEY

#### The Distribution of Scientific Works Published by the British Government

RECENTLY I have enjoyed an opportunity of visiting a number of the scientific institutions of America, but it was with a feeling of humiliation that I learnt that several of the best-known and most important of them have to pay for works like the various Survey and Challenger Reports which are published by the British Government. It would have been possible perhaps to have obtained some statistics on the subject, but I must confess to having been restrained by a feeling of shame from making direct inquiries; what I did hear about it merely reached me in the course of casual conversation.

There are few of your readers probably who do not know of the extraordinary liberality of the American Government with reference to their publications, and when speaking of it to Major Powell, Director of the United States Geological Surveys, I was told by him that in his department it was considered that the cause of education, the spread of knowledge, and their own immediate objects were most effectually aided by a widespread distribution of their publications.

We owe much of this liberality, no doubt, to the forthright and generosity of our own countryman Smithson, the principal function of the Institution founded by him being to arrange for the exchange and despatch of books and specimens.

There are perhaps few directions in which the cause of science would be more directly benefited just now than by the establishment of an institution in England which would undertake the management of the exchanges of the scientific Societies of the United Kingdom. I am aware that there are paid agencies for the purpose, but what is wanted is a free agency which would undertake the duty for the large Societies and relieve those that are struggling from charges which now press heavily on their resources.

The great desideratum, however, is a man like Smithson, who, possessing wealth, would be willing to give or bequeath it for the purpose of founding such an institution. Here is an opportunity for any person of capital desirous of doing good and preserving his name to all posterity by one and the same act.

To return, however, to the main object of this letter, cannot anything be done to increase the "free list" of Government publications? Surely there must be stored away vast quantities of Survey and other serial publications which, if they were

handed over to the Smithsonian Institute, would, I feel certain, be gratefully accepted and judiciously distributed among the libraries of America.

V. BALL

Science and Art Museum, Dublin, October 25

#### Insect Pests in Ceylon

AMONGST the "Notes" in your last issue, p. 615, is an extract from a Ceylon paper of a report by Dr. Trimen as to an insect "which has caused much alarm by its depredations on cacao and cinchona plantations," and that Dr. Trimen thinks "the only serious damage to cacao comes from the *Helopeltis antonii*, which appears to be a recent importation to Ceylon, although well known in Java."

Quite recently I received from my friend Mr. R. McLachlan some fragments of several specimens of a Hemipteron which he had received from Ceylon, identified as *Helopeltis antonii*, and said to be causing damage to the planters' crops, and my correspondent, having doubts as to the proper identification, had forwarded the specimens (!) for my examination.

Before stating that an error of identification had been made, it is necessary to say what *Helopeltis antonii* really is. That species described by Dr. Signoret is a member of the Capsidæ, possesses nodulose or incrassated femora, and of course, like other members of that family, may be considered as injurious to some kind of vegetation. The specimens I received (sans head and pronotum) had also nodulose or incrassated femora, and though somewhat similar also in colour to the *Helopeltis antonii*, clearly belonged to the family Reduviidæ, whose habits and food are of a totally dissimilar character. It is therefore possible that both species occur in Ceylon; the one is being frequently mistaken for the other, a matter of some moment to the planter, as in destroying the Reduviid he may be at the same time killing the worst enemy of the real pest.

W. L. DISTANT

Russell Hill Road, Purley, Surrey

#### The Pentacrinoid Stage of *Antedon rosaceus*

I WAS somewhat surprised at finding this summer, in Lamlash Bay, on the east coast of Arran, *Antedon rosaceus* in the pentacrinoid stage readily obtainable up to the end of September, and would be glad to hear from others who have been observing *Antedon*, their experience of the duration of the stalked condition. It is well known that the adult *Antedon rosaceus* is abundant at Lamlash, and that young specimens in the pentacrinoid stage are common on *Laminaria* in the earlier part of the summer; but I have always found the "pentacrinoids" rare or absent during August, and I have certainly never before found one in September. I find that the late Sir Wyville Thomson states, in his memoir "On the Embryogeny of *Antedon rosaceus*" (*Phil. Trans.* 1865, p. 513), that the ova are mature towards the end of May or beginning of June, and that, although the time spent in the larval stages may be to a certain extent shortened or prolonged by surrounding conditions, the disengagement of *Antedon rosaceus* from its stalk "constantly occurs between the middle of August and the middle of September" (p. 517). From this one would not expect to find any specimens in the pentacrinoid stage after the middle of September. This season, however, while dredging chiefly in the southern part of the bay near King's Cross Point, I obtained young stalked *Antedons* nearly every day between September 15 and 25. I generally got one, two, or three specimens in a forenoon's dredging (usually four or five hauls of the dredge). On September 27, the last day I dredged, I found, on some *Fucus* brought up from six or seven fathoms at the south entrance to the bay, upwards of twenty specimens of "pentacrinoids." They were of all sizes, from 3 mm. up to 1 cm. in length of stalk. The last were evidently just ready to be set free, and in fact several of them became disengaged from their stalks while I was watching them in a glass dish during the afternoon. The smaller specimens obtained that day were, from their structure, evidently very much younger, and could not have become free for a considerable time: how long I do not know, and would be glad to learn. Probably they would still have been in the pentacrinoid condition had they lived.

W. A. HERDMAN

University College, Liverpool, October 21

#### Curious Phenomenon

A VERY curious phenomenon has just come under my notice, which is, I think, not unworthy of being put on record. I have

been staying for ten days in London, and two long white paraffin candles have been standing on the drawing-room chimney-piece all the time. We have not been using the candles; but the wicks were ignited before we came to the rooms, as it is very common to do with new candles. I noticed two days ago that the wicks were all covered over with what I at first took to be some kind of mouldy growth, but what I now find is dust which has attached itself in fine hair-like tufts to the wicks of the candles, sticking out in all directions exactly like the tufts of iron filings on a powerful magnet.

I am well acquainted with this phenomenon in the vicinity of an electric machine which is kept working continuously. For example, we find it constantly in the neighbourhood of the electrifying machine of Sir W. Thomson's siphon-recorder, where the insulating supports collect great quantities of dust, and generally in these curious forms. From the appearance of the deposits on the wicks of the candles I have very little doubt that somehow or other electric attraction has played an important part in the collecting of the dust and the formation of the filaments. But whence the electrification has come I am unable to say, unless it be that a warm current of air, which I find is always passing upwards past the candles from a wooden mantel-piece warmed by the fire, electrifies the paraffin candles and causes the phenomenon I have described.

J. T. BOTTOMLEY

39, Eastbourne Terrace, London, W.,  
October 25

#### Simson's Line

MR. J. S. MACKAY of the Edinburgh Academy, though not able to trace "Simson's line" to Simson's works (see my notice of Dr. Casey's "Euclid," NATURE, October 23, p. 607), has furnished me with the following account, which may be of general interest:—"The theorem that the orthogonal projections of a point on the circumference of a circle upon the sides of an inscribed circle are collinear is ascribed to Robert Simson by Catalan in his 'Théorèmes et Problèmes de Géométrie Élémentaire,' and he speaks several times of 'la droite de Simson.' This book of Catalan's is, I fancy, better known in the United Kingdom than many other Continental works where the same statement is made; and I conjecture that we have adopted the name from Catalan. It may, however, be the case that we have taken the information from Poncelet's 'Propriétés Projectives,' § 468, where it is said that Servois attributes the theorem to R. Simson. The passage where Servois makes this ascription occurs in Gergonne's 'Annales de Mathématiques,' vol. iv. p. 250, and it is unsatisfactory enough: 'La méthode qui vient d'être indiquée suit haut pour déterminer le point C repose sur le théorème suivant, qui est, je crois, de Simson.' I cannot carry the ascription of the theorem to Simson farther back than to Servois, and though I am not positive that Servois has made a mistake, yet I think it highly probable. The extension of the theorem to the oblique projections is attributed by Catalan to Chasles. It is due to Poncelet, and is given in the section quoted above."

THE WRITER OF THE NOTICE

October 27

#### A Rainbow after Sunset

ON the evening of August 29 the almanac sunset for Ireland south is placed at 6h. 51m. Happening to look out to south-south-east I saw a well-marked, though not very brilliant, portion of a rainbow in a shower cloud just above the horizon. It was not a perfect bow, but what sailors call a *dog*. I looked at the clock and saw that it was 7.15 p.m. Knowing that the sun had set, and being curious to see what could have produced the bow, I immediately went out and examined the western sky. The sun had indeed set, but there was a bright red glow and some flocculent clouds were tinged strongly with a brilliant rosy red. It was plain that the rainbow was caused by reflected light.

. Stonyford, Co. Kilkenny

JAMES GRAVES

#### TROPICAL AFRICAN MOUNTAIN FLORA

A VERY interesting collection of plants has been brought to Kew by that intrepid African explorer Mr. Joseph Thomson, made during his late journey into the Masai country. They have been examined by Prof. Oliver, and consist of about thirty-five species from Kili-

manjaro at 9000 to 10,000 feet of elevation; a few from a crater near Lake Nairasha at 7000 to 8000 feet elevation; thirty-four from the Kapté plateau at 5000 to 6000 feet; and fifty-eight from Lykipia at 6000 to 8000 feet.

These collections exhibit the mingling of North Temperate types with others characteristic of Southern Africa, for which previous discoveries had prepared us. Of these the most interesting are, as new to Tropical Africa, an Anemone, a Delphinium (very different from the Abyssinian *D. dasycaulon*), and a Cerastium of remarkable habit. Of South African forms the most striking is the handsome arborescent Rutaceous plant, *Calodendron capense*, the "wild chestnut" of Natal, to the north of which it had not previously been found. Of northern forms is a Juniper, another genus unknown to Tropical Africa, and which was found forming groves at an elevation of 6000 to 8000 feet, and itself attaining a height of 100 feet! It is the *J. procera* of Abyssinia. A *Podocarpus* gathered along with the Juniper, and also attaining 100 feet in height, is probably the *P. elongata* of Abyssinia, which, or a near ally, also occurs in South Africa. The only other Conifer previously found in the equatorial regions of Africa is the *Podocarpus Mannii* from the peak of St. Thomas in the Gulf of Guinea.

J. D. HOOKER

#### AN ELECTRO-DYNAMOMETER WITH EXTREMELY LIGHT SUSPENDED COIL

IN my former communications to NATURE it has, I believe, appeared (1) that the induction currents used by Du Bois-Reymond, Duchênne, and other observers for physiological and therapeutical purposes were only arbitrarily and very insufficiently measured; (2) that the simplest and most practical instrument for their measurement is a delicate electro-dynamometer; (3) that in consequence of their extreme smallness, every available method must be employed to reduce the sluggishness of such an instrument without impairing its accuracy; (4) that an instrument of this character, shown by me before the Physical Society at Oxford in June 1882, had answered very well, indeed better than a more expensive apparatus designed by Prof. Kohlrausch for larger currents.

It was, however, objected that there is an insurmountable difficulty in keeping a good contact between the aluminium and silver-gilt wires used in it for suspended coil and suspending wire respectively.

At the British Association meeting in Montreal I was able to show an improved form of the contrivance, in which this difficulty was surmounted; and, in addition, a method of damping the oscillations, which, while improving the insulation, enabled the weight of the suspended coil, on which the force of the torsion couple depends, to be varied between limits practically infinite.

The contact difficulty is met by taking a small plate of ebonite 3 mm. by 5 mm. in size, and tapping into it two small gold screws, long enough to project through, and carry two little nuts on the opposite sides. To the two screw heads the ends of the aluminium coil, bent into rings and filed flat, are firmly screwed; under the two nuts are twisted the ends of the gilt-silver suspension wires; the nuts are then similarly screwed home. Ebonite is elastic enough to render the junction air- and fluid-proof.

The second requirement was attained by coiling the aluminium wire on a thin tube of cork, and immersing it in a vessel filled with petroleum oil. Aluminium is about two and a half times heavier than water, nearly three times the specific gravity of this oil; whereas cork floats on it. Consequently, by properly proportioning the amount of cork relatively to the wire coiled on it, any desired specific gravity from absolute flotation to that of aluminium itself can be obtained. It is even practicable to load the coil, like a Sykes's hydrometer, by dropping

glass beads on a vertical aluminium wire in the axis of rotation. Here they have scarcely any influence on the swing of the coil. The damping effect of the oil, which is contained in a small globular receptacle, like a fish-bowl, between the fixed coils, is very complete and satisfactory. I had the pleasure of presenting the first rough instrument thus made to Prof. Johnson for the physical laboratory of McGill College.

W. H. STONE

### LIBRARY CATALOGUES<sup>1</sup>

THERE is a wide difference in function between the old "literary and philosophical" libraries, such as are now dying out in various parts of the country, and the "free public" libraries which are steadily, though remarkably slowly, on the increase in England—libraries which lay before readers of all classes Mr. Herbert Spencer's denunciations of what an evil sign of the times their organisation for the diffusion of knowledge is, compared with Lord Brougham's old Society for the same purpose.

The old library was in principle a museum of books, where, after a few readers who might be trusted to handle the choice volumes cautiously and reverently had enjoyed the luxury of making themselves acquainted with their contents, each of such volumes was put up in its place to form part of the "collection" of which the librarian was proud, and from which he was as little anxious to promote abundant issues as the proprietor of Dickens's old curiosity shop was to make sales of its contents!

But the other—the modern—type of library, is a stock of the literature for which either the public itself manifests the greatest appetite, or philanthropists and public educators are most desirous to disseminate and cultivate a taste: the happiest fate wished for any book in such a store being that it should be fairly thumbed to death. The new library is worked on the principle of the city warehouse where the whole stock should be turned over several times in the year; and anything which cannot be "moved" is an incubus upon which the manager's eye falls day after day with more and more impatient determinations.

The catalogues of the respective types of library accordingly should be widely different productions. That of the former should be an accurate register of sizes, dates, and editions; the compiler fairly taking it for granted that its consulter is intimate with the subject he is inquiring upon, and that a difference, even in the edition, from the one sought, may make the book as far from what he wants as Blackstone's "Commentaries" from Cæsar's.

But the main object of the catalogue of the new library is again like that of the commercial advertisement. Its consulters are not such as know exactly what they want, and its maker is anxious to display in it his books and their contents to the best advantage; like the salesman, his greatest triumph being, not to supply a customer with the article most in demand, but to allure him to higher qualifications and raise a new taste which will lead him along tempting paths of expenditure. In drawing it up, accordingly, the librarian will hardly take a better example than that of the commercial world in its advertisements of books; to be followed soberly, however, for it would doubtless raise a distrust in catalogues if they heaped up the favourable critiques which are to be found there. Nor, again, are the frequenters of a free library able to judge from titles which pleased authors' fancies what those authors' books contain, and an important matter is to bring within their ken the contents of volumes many of whose titles are indefinite, some figurative, and not a few positively misleading or absurd.

<sup>1</sup> "Catalogue of the Halifax Public Library, Lending and Reference Departments." (Halifax, 1882.)

In such an institution, therefore, where the books may not be examined before taking out, or the librarian have a literary discussion with each applicant, time can hardly be better spent than in making the catalogue supply as much as possible this information.

The handsome and carefully-printed catalogue now under notice, giving 100,000 references to 25,000 volumes, has carried this out to a very creditable extent; under most collected essays and doubtful titles giving a list of the subjects and the ground gone over, and under each subject-head referring the reader to the principal works where it is treated upon, or from which information may be picked up, whereas many other catalogues have placed together only those books in whose titles the name of such subject occurs. Thus under the head of Canada, while thirteen titles are quoted containing the name, there are also placed before the reader thirty-two titles which do not contain it. Although there is no book upon a special subject like "Carpets," he is referred to "Manufacturing Industries"; and under that burning subject, "Capital and Labour," though not a book bearing the title is to be found, master or man is referred to sixteen books on political economy. A danger in attempting this is shown, however, by comparing any two such catalogues together. Not half of the books in a large library bearing upon any great subject can be thus quoted, and a very intimate knowledge is required to select those of most general superiority; and even then a shade is unfairly thrown over books of nearly equal ability. Why, for instance, should only four of Hugh Miller's books be quoted under the head of Geology, and only two of those of the Geikies?

Of course this mischief increases as the greatness and importance of the subject increases. It is easy to cite all the books devoted to an account of New Zealand, but useless to attempt to give a full list of those which bear upon Europe or Asia. This catalogue carefully divides Africa into Central, East, North, South, and West, and quotes ninety-four works upon it, while upon America seventy-four make up the selection. The literature of Edward IV. may be fully compiled in a few titles, yet the forty-five works relating to Charles I. and II. do not nearly exhaust the books directly touching upon matters of that period, and sixteen works upon the English Commonwealth is not a great number to refer readers to.

Such a collection of books as the Halifax Library must have its deficiencies. Why are there only two books on the cruise of the *Challenger*, neither of them Sir Wyville Thomson's, whose name is not to be found? And if Lavdner's *Cyclopædia* entire is not now thought indispensable, surely Thirlwall's "Greece" and some of his later books ought not to have been passed over.

It is difficult to see the advantage of the puzzling substitution in this catalogue of *A* for 10,000. It saves nothing till 10,000 is reached, and as soon as 11,000 is reached it takes up more room than the figure which requires no explanation. We are told that the Catalogue enumerates 25,000 vols., but not what substitute is made or to be made for 20,000. Again, if a — is used to save printing an author's name a second time, why should "Capital and Labour" be printed in full nineteen times, or "United States" 125.

The printing has been unusually well corrected, but we are inclined to ask, were the "wines of Cyprus" in the head of the compiler when he quoted Mr. "Cyprus" Redding as the author of "Modern Wines"?

The date of 1882 on the title-page, while the quarterly reviews come down to the bound vols. for 1883 with tables of their contents, is explained by the first part of the work, consisting of a catalogue of the novels and books in the juvenile department which were "most in demand," being issued at the earliest date possible, Part II. containing all the more important classes not being completed till this

year. It leads to a reflection on the inevitable incompleteness of a catalogue. There is no pause in the publication of books. In spite of the most careful filling up of the lists of missing books by the librarian, and the most liberal expenditure by the Committee, hundreds of new books must have come out, and a large proportion of them added to a library, between the time when the last title is handed to the printer, and the time when the first outsider can purchase his catalogue and examine what are the treasures kept in store for him. And in no production of industry, not even in ladies' adornments, is novelty so important a recommendation as in literature. The disheartening reduction of prices in secondhand catalogues, not of three-volume novels only, but of laborious and important works, is a proof of this. A greedily read daily press makes it inevitable. Any printed catalogue, therefore, with all the books in due order, must be deficient of the favourite, if not of the most important books which the library contains. Catalogues therefore in general should be printed like the most fugitive of literature, and be renewed as frequently as possible. A card-catalogue alone can be kept on a level with the stock of books. A frequent publication by a large library of a list of its new purchases, sold at a remunerative price to students and luxurious readers, would make a library popular among those with a strong appetite for reading, while it would not lead to the older tenants of the shelves being forsaken by the crowd.

In most public libraries an effort is made to combine the functions of the old collection of books with that of the dispensary of useful or pleasing thought, by having two departments. The books more deserving of the old feeling of preservation are wisely placed apart with real works of reference to form the Reference Department. A mischievous result of this arrangement usually is that it makes books of greatest intrinsic value and forbidding costliness least available to the impecunious student. The Halifax Catalogue avoids this by arranging all together in one alphabetical list, marking each of the reference books with an *R*, and leaving the question of lending them out practically to the discretion of the librarian or Committee. We strongly approve of this method and of liberality in working it, and recommend it to the notice of other libraries. W. ODELL.

### THE "IDENTISCOPE"

IT appears from the *Pall Mall Gazette* of October 21 that there is a prospect of "a campaign being run in the country" on behalf of the "Claimant" by "six of the best orators whom money can collect, . . . supplied with a hundred identiscopes." These are optical instruments, containing on the one side a drawing made from a portrait of the undoubted Roger Tichborne, and on the other side a drawing made from an equally undoubted portrait of the Claimant taken nineteen years later, and the arrangement is such that on looking into the instrument the drawing combine into one. This, it is maintained, leaves no doubt that the two portraits are those of me and the same individual.

The more important of the questions raised by this announcement is whether the fact of two genuine portraits blending harmoniously into a single resultant is stringent evidence that the portraits refer to the same person. Those who have examined the optical combinations and photographic composites that I have exhibited at various times will know that this is not the case. Those who have not seen them and care to know more about the subject should look at my "Inquiries into Human Faculty." (Let me take his opportunity of correcting an error there. The full and rofile composite labelled "two sisters," in the middle of the upper row of the frontispiece, is really one of three sisters. I had made many composites of the family, and

by mistake sent the wrong one to the printer.) The reason why photographic portraits blend so well together is that they contain no sharp lines, but only shades. The contour of the face is always blurred, for well-known reasons dependent on the breadth of the object-glass; even the contour of the iris in an ordinary photographic print looks very coarse and irregular when it is examined by a low-power microscope. On superimposing a second portrait, the new shades fall in much the same places as the former ones; wherever they overlap they intensify one another; where they do not overlap they leave a faint penumbra which has usually a soft and not unpleasing effect. Judging from abundant experience, there would be no difficulty in selecting photographs of many different persons that should harmonise with the photograph of the Claimant, and it would be amusing to try strange combinations. I could suggest one that I think would succeed excellently: it is of a certain distinguished member of Her Majesty's—but I must be discreet, though probably if I ever come into possession of suitable photographs I may make a private experiment.

It seems, however, that the identiscope is not intended to be used to combine reproductions of the actual photographs, but only drawings in bold lines that have been made from them. The photographs, it is to be presumed, do not agree in aspect, so drawings are made from them that do so, the diameter of the iris being used as the scale unit of the breadth and length of the features, in making the drawings. Although the diameter of the iris is spoken of as an invaluable unit for exact reduction, its disadvantages appear to be great: (1) Its vertical diameter was, I suppose, not used, because in the large majority of cases the upper part of the iris is covered by the eyelid. (2) The horizontal diameter is unavailable unless the eye of the sitter was directed straight at the camera; otherwise the iris is seen in perspective, and its breadth is reduced by an unknown amount. (3) One eye is perspectively larger than the other, unless the face was set truly square to the optical axis of the lens; if not, it would be necessary to measure both eyes and to take a mean; this is a requirement to which I have as yet seen no allusion. (4) The diameter of the iris is only about 1/25th part of the length between the chin and the vertex of the head, consequently any minute error in its measurement would be largely multiplied when applying it as a unit. (5) The diameter of the iris in a photographic print does not, as I have already implied, admit of accurate measurement. The identiscope appears to be the same as an instrument sold some years ago, and of which I have one now by me. The description printed on it is "E. Wolf and Sons' patent Limnoscope, for copying drawings, designs, &c." I bought it for the purpose of experiments with composites, and tried many modifications of its principle, but other plans proved so much better that I discarded it. The principle is easily realised by any one who cares to place a table by a closed window and then to go out-of-doors with an open book in his hand, which he must hold horizontally by the side of the window, at the level of the table. He will then see through the glass an image of the book (a "Pepper's ghost," in short) resting on the table. The reflected image is so faint that the direct image has to be dimmed. Yellow glass serves this purpose. The limnoscope is not suitable for combining ordinary photographs because the reflected portrait is reversed; the left side of one face is combined with the right of the other. Much better instruments exist for making optical combinations; I have described them in my book.

I conclude as follows. First, that the fact of two photographic portraits blending harmoniously is no assurance of the identity of the persons portrayed. Secondly; when drawings made from portraits are shown to blend it does not follow that the portraits from which they were drawn would blend equally well. And lastly, the photo-

graphic print of the iris of the eye does not afford a trustworthy unit of measurement.

FRANCIS GALTON

### ON THE ALGIC FLORA OF THE ARCTIC SEAS

**A**MONG the fields of research opened to science by the Swedish Arctic expeditions of recent years the botanical one is that which has been cultivated the most assiduously and with the best results. The contributions which Swedish men of science have made to our knowledge of the flora of the Arctic regions are varied as well as important. They embrace the higher as well as the lower forms, both the species invisible to the naked eye as well as those of greater size, and the varieties hidden in the lap of the ocean as well as those which the student encounters on *terra firma*. Swedish botanists have particularly increased our knowledge of the remarkable flora of the sea. Thus instead of, as only a few years ago, our being ignorant as to whether there really was a flora at the bottom of the Arctic seas or not, we are now more familiar with the algæ flora of these regions than many another in far more southern latitudes.

Of the Swedish botanists who have particularly devoted their time and energy to the study of the flora of the Arctic seas I must mention the following gentlemen, members of the Royal Academy of Science of Stockholm: Messrs. J. G. Agardh, P. T. Cleve, F. R. Kjellman, and E. G. Kleen. The reason which specially prompts me to discuss this subject here is the recent appearance of an important work by one of these algologists, Prof. Kjellman, viz. "Norra Ishafvets Algflora," with thirty-one illustrations, which forms part of Nordenskjöld's "*Vega*-expeditionens vetenskapliga iakttagelser," a work which has from time to time received favourable mention in this journal.

Prof. Kjellman has, as the representative of botany, and particularly the branch termed algology, participated in four Arctic expeditions, during which he has visited Finmarken, Spitzbergen, Novaya Zemlya, in Europe, and long stretches of the coast of Siberia, in Asia. Two of these expeditions, the one to Spitzbergen, 1872-73, and the *Vega* Expedition, 1878-80, were attended by winterings in the Arctic regions, during which time Prof. Kjellman enjoyed an opportunity, never before accorded to an algologist, viz. that of studying the flora of the sea at all seasons. His algæ flora, in consequence, not only forms a complete index of the species and varieties of the algæ of the Arctic seas, their form, construction, and geographical distribution, but it gives us also an insight into the vital functions of these plants, and explains to us the conditions under which they exist. I intend in this paper to refer briefly to the present position of this science, to which Prof. Kjellman has contributed such a great share.

The Arctic Ocean covers, geographically speaking, the sea north of the Polar Circle. Within this area there is, however, a vast tract of sea where there is no ice either winter or summer. This is the sea around Northern Norway through which the Gulf Stream flows. On the other hand, there are tracts south of the Polar Circle which rival the coldest parts of the Arctic Ocean on the point of ice. To these belongs, in the first instance, the part of the Atlantic washing the south-eastern shores of Greenland, which receives from the north a cold Polar current full of icebergs.

From a hydrographical point of view, however, the Arctic Ocean is far more naturally limited if we deduct from it the part around Northern Norway and add to it the sea around Southern Greenland. From a botanical point of view, too, the Arctic Ocean is thus limited in a more natural manner. To the part of the Arctic Ocean cut off by this arrangement Prof. Kjellman proposes to assign the name "The Norwegian Polar Sea," and in the work

referred to above he deals with the algæ flora of the true Arctic Ocean, according to the hydrographical and botanical theories, as well as that of the Norwegian Polar Sea. As the conditions under which the flora of the true Arctic Ocean lives lend to the same a heightened interest, I will discuss this flora at more length, and finally add some words on that of the Norwegian Polar Sea.

In a sea like the Arctic Ocean, where ice is found in large quantities all the year round, it seems, at first sight, that no flora could exist, and it is, indeed, true that great parts of the Arctic Ocean are, botanically speaking, mere deserts, but this is not caused, as I will presently show, by the low temperature of the sea, but by other causes. Strangely enough, some algæ have become accustomed to be surrounded by a medium the temperature of which never, or at all events but seldom, rises above freezing-point, and in many instances they have indeed flourished greatly therein, of which their luxuriant growth bears evident proof.

When I just said that large tracts of the Arctic Ocean are botanically deserts, I did not thereby mean that the deepest parts of the sea were void of flora, as this is really the case in all, even the warmest, parts of the oceans of the globe. The algæ flora is only to be found within a smaller or larger belt along the coasts of the continents and islands, and even within this belt, where the depth does not prevent the existence of algæ, they are not found everywhere. Another condition too must be present for the existence of algæ, viz. that the bottom be rock, boulders, or marine shells, in brief, formed of large objects which can serve as "moorings" for them. Thus, where the bottom is sand or clay the regular algæ flora is absent. In the eastern parts of the Arctic Ocean the latter kind of bottom is very common. Nearly along the entire coast of Siberia, and in long stretches near Novaya Zemlya and Spitzbergen, the bottom is formed of fine sand and clay. Algæ are here sought in vain, as they are, in fact, in localities with a similar bottom all over the world. Only on the north and north-western coasts of Spitzbergen, and in several places along the west coast of Greenland, the bottom consists of such hard materials as are favourable to a copious algæ flora.

This explains to a great extent the existence of the botanical deserts, referred to above, in the Arctic Ocean, but there are also other causes. Before I deal with these, however, I must explain the manner in which the bottom of the Arctic Ocean is divided according to the flora at various depths, as suggested by Prof. Kjellman.

He distinguishes between three bottom regions, viz. the *littoral*, or what may be called the upper shore-belt, the *sub-littoral*, or lower shore-belt, and the *clittoral*, or deep-sea belt. The upper shore-belt embraces that part of the bottom which lies between the neap and high tides, the lower shore-belt the part that stretches from the former down to a depth of 36 metres, and the deep-sea belt the part below the latter depth.

Of these three belts, one, the upper belt, contributes greatly, and in a striking manner, to make parts of the Arctic Ocean flora-less. Within far the largest parts of the ocean this belt is void of all vegetation, and the cause of this is easily discovered. It lies in the ice. Thus every winter a girdle of coarse, firm ice is formed along the coast, and near the shore reaches to the bottom. In some places this ice lies all the year round, and in others it certainly disappears, but generally late in the season. At Cape Chelyuskin during the *Vega* Expedition the "ice-foot," viz. the shore-ice, was lying firm at the end of August. Where the land-ice thus remains throughout the summer no algæ can, of course, develop, and where it disappears only in the autumn the time is too short to allow of any growth.

Nearly as detrimental to the flora as the land-ice are the broken-up ice-masses, which during the summer are driven hither and thither by winds and waves. These

drift-ice masses grind the upper shore-belt to such an extent that every vestige of vegetation is decimated, if not entirely destroyed. The tide contributes also greatly to increase the disturbing influences of the ice, as by this phenomenon the area of shore exposed to the action of the ice becomes greatly increased, and by the circumstance that the ice-masses are thereby kept in constant motion. Not even in the winter are the ice-masses at rest along the shore. During the wintering of the Swedish expedition at Spitzbergen at the northernmost promontory of that island the sea outside the station, Mossel Bay, was covered with hard, coarse ice, some twenty miles in breadth. Still throughout the wintering a grating sound was heard from the ice, caused by the rubbing of the ice-floes and icebergs against each other as they moved backwards and forwards, or rose and fell. That a similar action would greatly affect the bottom of the sea is quite evident, particularly as most of the shores of the Arctic Ocean are void of the protection afforded by islands and fjords. The latter contribute to increase the detrimental effect of the ice on the algæ flora. On an open coast the action of the ice is, of course, more violent than where it is protected by islands. For this reason the upper shore-belt is nearly everywhere in the Arctic Ocean void of algæ where there are no protecting islands, as, for instance, on the shore of North-Western Spitzbergen, on a few places at Novaya Zemlya, and particularly at the west coast of Greenland.

Another circumstance which greatly contributes to the poorness of the algæ flora in several parts of the Arctic seas north of Asia is the brackishness of the water, caused by the great Siberian rivers. The water of the surface here consists of two parts river-water and one part seawater, a condition which is very detrimental to the development of algæ.

The total absence of light in certain parts of the Arctic regions during a very great part of the year also arrests the growth of certain algæ which love the light. The scarcity of green algæ is, no doubt, due to this circumstance.

It is natural to assume that the temperature of the Arctic seas is low, but it is really lower than is generally believed. Thus, during the warmest part of the year, in the month of July, the mean surface temperature is from  $+0^{\circ}11$  C. in the American Arctic Sea to  $+3^{\circ}3$  and  $4^{\circ}33$  in the sea around Spitzbergen and the Murman coast, and it decreases greatly with the depth. At the depths at which the algæ flora is richest, it never rises above  $0^{\circ}$  C. That many species of algæ are excluded from the Arctic seas by this low temperature is evident. It is, indeed, to be wondered at that there are algæ in these icy waters at all; but that there are really many I will presently show.

From what I have thus said, it appears that the algæ-covered spots in the Arctic seas are, so to speak, oases in the great Polar water desert. Let us now examine the conditions of the flora in these oases. Most of them have at a poor and sparse vegetation. This is particularly the case in the Siberian seas and the eastern part of the Aral Sea, and, to some extent, in the western part of the Aral Sea, the eastern part of the Murman Sea, the Spitzbergen Sea (the sea to the east of Spitzbergen), and the Greenland Sea (the sea between Greenland and Spitzbergen). Even where the quantity of algæ is greatest within this area, it is much less than in the richest parts of the Atlantic Ocean. In the western part of the Murman Sea and the White Sea the vegetation is not so poor (according to Chr. Gobi, "Die Algen flora des Weissen Meeres der demselben zunächst liegenden Theile des nördlichen Eismeeres," 1878). It is richest in Baffin's Bay, the west coast of Greenland. The greatest authority on the natural history of Greenland says on this point: "Just inside the coast of Greenland the sea-bottom is covered with a forest of giant algæ, with leaves from 12 to 16 feet length and half a foot in width, besides which the

stones are everywhere covered with coral-like layers (coral algæ)." The algæ flora in this spot is, therefore, copious, and is far in advance of those in other parts of the Arctic Ocean.

I have already said that the bottom of the Arctic Sea may be divided botanically into three belts, viz. the upper shore, the lower shore, and the deep-sea belt. Of these the first-named is the poorest, the algæ oases here being few and limited, the vegetation poor in individuals, and the algæ very small. The west coast of Greenland, with its fjords and islands, alone forms an exception in this respect. The upper belt here often produces brown algæ of considerable size (*Fucacea*), while even green and red are not wanting. The deep-sea belt is, like the upper one, poor in species and individuals. During the Swedish Arctic expeditions only six species have been discovered in this belt, and all of these lived at a considerable depth, one (*Phylota pectinata*, Gunn.) even at a depth of 270 metres. The principal flora of the Arctic Sea belongs, however, to the lower shore-belt. This belt everywhere possesses the largest and the greatest number and variety of algæ. Its characteristic forms are two, viz. leaf-weed algæ (*Laminariæ*) and coral algæ (*Corallinacæ*). They cover large areas of the bottom, and appear in close masses rich in individuals, which attain a great size. The leaf-weed algæ make the greatest impression; they derive their name from the circumstance that they carry a large leaf at the top, which is shed and renewed annually. All species belonging to this family are large algæ, some of them attaining a length of 4 metres, and the top leaf a width of 1 metre. They are the trees of the sea, and resemble those on land by growing together in forests. These are the algæ which in the Arctic Ocean attain the greatest size and cover the largest area, and so greatly contribute to the general habitus of the flora of this ocean that one might justly call it the "Ocean of the Laminariæ."

Next to the Laminariæ the Corallinacæ are the most important. These algæ form one of the wonders of the terrestrial flora. Any one who thus sees them for the first time would think that they were real corals or some kind of stone. They are—as they appear in the Arctic seas—perfectly hard, being impregnated with chalk, and have a peculiar soft rosy or grayish-red colour. In form they vary between the laminated and the bushy. Often, too, they appear as detached balls which have on their surface shorter or longer branch-like projections. These balls may attain a diameter of 20 centimetres, as, for instance, in *Lithothamnion glaciale* (Kjellm.), and appear in certain places in the Arctic seas in enormous quantities. On the shores of Spitzbergen and Novaya Zemlya, for instance, the bottom of the sea is for miles covered by deep layers formed of such balls, which, as Prof. Kjellman remarks, must be of great importance in forming fresh earth-crusts. All the other species of algæ play a very subordinate rôle compared with the Laminariæ and Corallinacæ. They are certainly, as regards variety of forms, superior to these latter, as the leaf-weed algæ possess only twenty species and the coral algæ nine, while other Arctic algæ—with the exception of Diatomacæ—have as many as 145 species. In spite, however, of the abundance of the species of the latter, they make but little impression in the algæ flora, as they are either too small, or too few in the number of individuals. This being the case, it is only natural that the Arctic sea-flora, particularly owing to the predominance of the Laminariæ, is monotonous in its appearance. This does not indeed apply to form alone, but also to colour. The colour is really sombre, the brown colour of the Laminariæ predominating. The lighter-brown shades are almost entirely wanting. The red algæ (*Floridæ*) are not very prominent, with the exception of the coral algæ within their special sphere, and their colour is not, as I have observed, of the strongest or purest. The chlorophyll algæ are very insignificant. The many variations of green—from the freshest



grass green to the white and yellow green—which give such richness of colour to the vegetation in the Atlantic Ocean, are almost entirely absent in the Arctic seas.

I have already mentioned that leaf-weed and coral algæ attain a great size in the Arctic Ocean. This is also the case with a considerable number of other Arctic algæ. Thus, the brown algæ, e.g. *Desmarestia aculeata*, L., and *Dichloria viridis*, Müller, and the red algæ, *Delesseria sinuosa*, G. and W., and *Halosaccion ramentaceum*, L., as well as the green algæ, *Monostroma Blyttii*, Aresch., and *Chatomorpha melagonium*, W. and M., show a high degree of development; a fact which proves that these algæ not only endure, but are quite at home in, the Polar water.

Another feature of great interest relating to the subject are the biological conditions of the algæ flora. Algæ which conclude their existence in a single year are either wanting, or at all events very few. Nearly all Arctic algæ live several years, and in order that they may be able to effect the work of propagation and nourishment with the little supply there is of heat and light, their organs are in operation during the dark as well as the light season. Whilst wintering at the northernmost part of Spitzbergen in 1872-73, Prof. Kjellman observed in the middle of the winter, viz. at a time when the sun was lowest and the darkness therefore most intense, that a considerable development and growth of the organs of nourishment took place, while, as regards the organs of propagation, he found that it was just at this season that they were most developed. Spores of all kinds were produced and became mature, and they developed into splendid plants. The Arctic algæ therefore present the remarkable spectacle of plants which develop their organs of nourishment, and particularly their organs of propagation, all the year round, even during the long Polar night, growing regularly at a temperature of between  $-1^{\circ}$  and  $-2^{\circ}$  C., and even attaining a great size at a temperature which never rises above freezing-point.

The result at which Prof. Kjellman arrived with regard to the development of the Arctic flora was this, that the algæ flora of the Arctic Ocean is, contrary to the Phanerogamic flora, not an immigrant flora, but that its origin lay in the Polar Sea itself. This theory is, he believes, proved by the facts that (1) the Arctic algæ flora is rich in endemic species, these being not fewer than 37, or 22 per cent. of the whole flora; and that (2) there are many species found both in the Northern Atlantic and the Pacific Oceans a large percentage of which reaches very far north in the Arctic Sea, and which have attained a high degree of development there, being characteristic algæ of the Arctic Ocean. That the endemic species owe their origin to the Arctic Ocean cannot be doubted; and that the species referred to under (2) have been originated there and gradually spread to the other two oceans is more than probable. If this be so, Prof. Kjellman estimates the number of species whose origin must be referred to the Arctic Ocean at 100, i.e. about 60 per cent of the entire algæ flora.

There remain now but a few remarks to make on the algæ flora of that part of the Arctic Ocean which has been named the Norwegian Polar Sea.

If sufficient notice be taken of the geographical position, this sea may be said to be the most favoured on the globe in the way of temperature. Although north of the Polar Circle, and reaching thence to  $72^{\circ}$  N. lat., it is never frozen, not even along the coasts. The mean temperature of the sea at the North Cape during the coldest season, viz. March, April, and May, is  $+3^{\circ}$  C., and during the true winter months, December to February,  $+3^{\circ}03$  C. If to this be added that the water is very salt, and that the bottom nearly everywhere consists of rocks or boulders, and that the coast is full of fjords and islands, every condition for the development of a rich algæ flora is present. And indeed the flora here is more copious than in the

true Arctic Ocean. There are no large deserts here. The upper shore-belt is covered with algæ, while brown algæ (*Fucaceæ*) are found everywhere, sometimes less, sometimes more mixed with red and green ones. The lower belt is the home of the leaf-weed algæ, most of which belong to other species than those of the true Arctic Sea. The coral algæ, too, are well represented, and even these differ from those of the true Arctic Sea in possessing brighter colours. The number of red algæ belonging to other groups is also greater than in the true Arctic Sea. The total number of algæ species in the Norwegian Polar Sea is 194, a number which is very great when we remember its limited area. There are in the true Arctic Sea, which is so much larger, only 174 species.

With regard to the general character of the algæ flora of the Norwegian Polar Sea, it must be described as a mixed flora, made up of species belonging partly to the Arctic and partly to the Atlantic Oceans, and some endemic ones. Prof. Kjellman believes, and in this I entirely concur, that the former are the original species characteristic of the spot, and that they are remnants from the time when the Arctic Ocean was larger than it is at present, i.e. during the Glacial period. The Atlantic species have immigrated during more recent times with the Gulf Stream, as they have by degrees become so prominent that the algæ flora of the Norwegian Polar Sea must, on the whole, now be referred to the Atlantic Ocean.

It has already been said that the algæ flora of the west coast of Greenland occupies a transitory position between that of the North Atlantic and that of the true Arctic Ocean. According to W. G. Farlow ("Marine Algæ of New England and Adjacent Coasts," 1881) this is far more the case with the algæ flora of the northern parts of the United States, and it may be of interest to note that by the aid of the Polar current flowing there a considerable number of true Arctic algæ have succeeded in penetrating to the forty-second degree of latitude, i.e. the latitude of Central Italy, or perhaps, more correctly speaking, have remained on the shores of New England from the very period when the Arctic Ocean extended thither at the time of the Glacial Age.

VEIT BRECHER WITTRÖCK

Academy of Science, Stockholm

## NOTES

WE are glad to learn that the trustees have appointed Prof. Newcomb Professor of Mathematics and Astronomy in the Johns Hopkins University, and that he has agreed to accept the position. The University begins the session with 273 students, of whom 160 are graduates, and the attendance is distributed well through all the departments. Sir William Thomson's lectures, as might be expected, were a great success.

THE following changes are proposed to be made in the Council of the London Mathematical Society for the ensuing session:—Prof. Sylvester, F.R.S., and Prof. Greenhill are nominated to fill up the places vacated by the late Prof. Rowe and Mr. W. D. Niven, F.R.S. Mr. J. W. L. Glaisher, F.R.S., has been selected for the Presidentship, while Dr. Henrici, F.R.S., Prof. Sylvester, F.R.S., and Mr. J. J. Walker, F.R.S., have been nominated Vice-Presidents. In consequence of Dr. Henrici's not having yet returned from his visit to Canada and California, it is not yet certain whether he will deliver his retiring address at the annual meeting (November 13), or defer its delivery to a later date in the session. It is proposed to present the De Morgan Memorial Medal to Prof. Cayley, F.R.S., its first recipient, at the annual meeting.

LORD M'ILAREN and Mr. JOHN MURRAY, two of the directors of the Ben Nevis Observatory, ascended Ben Nevis last week

and inspected the new buildings which have been erected during the summer, and which were now declared open. The new buildings include additional bedrooms and observing rooms, a tower for exit during winter and for self-registering wind instruments, and a tourists' shelter, the whole having cost over 2000*l*. The Observatory is now very completely equipped. Provisions and stores for a year have been conveyed to the top, and the observers are now fully provided for in their long winter residence. It is just a year since the Observatory was opened, and during this time hourly observations have been taken day and night without a single break. Over 2000 persons have ascended the mountain during the summer, and 1046 telegrams have been despatched by tourists to their friends in various parts of the world.

THE list of awards, medals, &c., made by the International Juries of the Health Exhibition have been announced. The total number of gold medals awarded is 278; the Society of Arts present 11 medals. The Society's Siemens Prize for the best application of gas to heating and cooking has been awarded to Mr. Thomas Fletcher. Medals for meteorological instruments, diagrams, models, &c., have been awarded to Messrs. Casella, Negretti and Zambra, Richard Frères, and Richardson and Co. For science teaching the Japanese schools have carried off medals, as well as Allan Glen's Institute, Glasgow, the Oldham School of Science, and the École Lemonnier, Paris. The Brothers of the Christian Schools have obtained in the Educational Section two gold and two silver medals and two diplomas of honour.

WE regret to announce the death of Mr. Robert Sabine, C.E., the son-in-law of Sir Charles Wheatstone. Mr. Sabine, as our readers know, has done good work in connection with the applications of electricity.

MUCH interest is manifested, both in Canada and the United States, in the enterprise of Lieut. W. R. Gordon, who was selected by the Canadian Meteorological Service for the expedition to Hudson's Bay, to establish stations for scientific observations. The work has already begun, and at each of the seven stations selected the usual meteorological observations will be made. Heavy tides will be measured; the drift of water will be noticed; and the conditions and state of the ice. Cape Hope is the most important station, and here a temporary magnetic station has been opened. This first expedition has been provided for by votes of 70,000 dollars by the Dominion Government for the purpose of obtaining reliable information as to the navigation of the Strait to the Bay, and to decide upon the feasibility of the adoption of the route as a summer outlet for the produce of the North-West. Each station party consists of two men and an Esquimaux interpreter, besides the officer in charge, and sufficient provisions and fuel for fifteen months are supplied. Lieut. Gordon, the head of the present Expedition in the *Neptune*, has been for ten years in the British Navy and five years in that of Canada. He is accompanied by Dr. Robert Bell, geologist, Charles R. Tuttle, of Winnipeg, historiographer, and seven officers. The seven stations are to be established in the following places, six on the Strait and one on the west shore of Hudson's Bay:—The first at Cape Chadley, the second on Resolution Island, the third at Cape Hope, the fourth on the north bluff of the mainland or on one of the Upper Savage Islands, the fifth on the south-east end of Nottingham Island, the sixth on the south side of Mansfield Island, and the seventh at Fort Churchill, on the mouth of the Churchill River.

IN the course of a lengthy communication to Sir Arthur Gordon, the Governor of Ceylon, suggesting improvements in the public instruction of that colony, the Rev. S. Langdon advocates the establishment of a University in Colombo, on the ground that the Universities for which Singhalese youth are now

prepared are ill adapted to the requirements of Ceylon. The English University examinations are, he says, intended for a different class of candidates. They tend to a total separation of the scholarly youth of Ceylon from their own classics in favour of those of Greece and Rome. The physical science references are to examples found commonly in the British Islands, but rarely in Ceylon. With regard to the Cambridge Local Examinations, the science master of the colonial Royal College points out that in botany the Ceylon students are placed at considerable disadvantage compared with those in England, and suggests that the Cambridge Syndicate be requested to arrange that plants of tropical well-known orders of equal structural value be substituted for those given in England, and that answers to general questions, such as those referring to useful timber-trees, useful vegetables, and other plants of economic use, be recognised, if correctly given for Ceylon, as of equal value with English answers. He then selects, as an illustration of the difficulty under which a Ceylon candidate labours, questions such as these:—Compare the daisy with the dandelion; compare the rose with the buttercup; describe a fir cone, &c.; all easy enough for an English but not so for a Ceylon boy. This objection is stated to be true not only of botany, but also of other branches of natural science. The complaint is that the higher examinations for which alone the youth of the colony can be prepared are destitute of all local references, and are therefore neither calculated to develop or test an intelligent acquaintance with the subject. Besides, as the masters can prepare for any one of four foreign Universities (London, Cambridge, Calcutta, or Madras), there is little unity in the system of higher education. Moreover the expense of residing at one of these Universities deters many students from taking a University degree at all. On the whole, the case made out by Mr. Langdon in favour of a local University is, regarded from the purely educational point of view, a very strong one. He sums up this portion of his report by stating that the advantages of such a University would be—(1) unity of higher education, (2) a higher education adapted to Ceylon rather than to English requirements, (3) the correction of many present defects, especially the neglect of practical and technical studies, (4) the granting of degrees not only attainable with much expense, (5) the encouragement of vernacular education.

COMMANDER CRAWFORD PASCO, R.N., writing from Elsterwick, Victoria, N.S.W., says:—"If at all coast stations (light-houses, &c.) the tide was as regularly recorded as the barometer, &c., ascertaining, where practicable, its force as well as direction, and, monthly, one simultaneous observation made at a given time, to be called a *term* day, similar to that at magnetical observatories where the clocks were set to Göttingen mean time, and for tidal purposes may be Greenwich, Washington, or any other meridian, I feel sure valuable results would be obtained."

WITH reference to the recent experiments on directing balloons, M. W. De Fonvielle explained in a recent paper, with the aid of diagrams, an elongated balloon which could be steered to the extent of being kept with the longest axis in the direction of a given current, and could be made to ascend or descend by the use of horizontal propelling screws. He further explained an adaptation he proposed of M. Dupuy de Lome's device of placing an air pouch in the balloon to compensate for loss of gas so as to form ballast air-chambers in the elongated machine.

IT will be seen from our advertising columns that some friends and fellow-workers of the late Frank Hatton desire to perpetuate his memory in the creation of an annual prize in a branch of chemistry in which he had distinguished himself at home. We heartily commend the scheme to our readers.

IN the last number of the *Agricultural Students' Gazette*, edited by students of the Royal Agricultural College, Cirencester,

will be found, besides the usual College news, "Observations on the *Cestrada* commonly known as Bot-Flies," or warble flies, by Miss E. A. Ormerod, one of the lecturers of the College; also an interesting account of an excursion to Sir J. B. Lawes's experimental farm at Rothamsted. This little periodical holds a good place among college magazines, by the interest and value of its articles.

FROM a report by the head of the Japanese Meteorological Department on the two typhoons of August last, which caused much loss of life and damage to property, it appears that the Japanese have not had to wait long for a practical demonstration of the wisdom of their recent step in increasing the number of telegraphic weather reports from their meteorological stations to three daily. Although the second storm travelled nearly 800 miles in the course of twenty-four hours, the parts of the coasts threatened received, under the most unfavourable circumstances, several hours' warning. Mr. Knipping takes advantage of the occasion to recommend an addition to the number of signal stations which would bring them up to 150 or 200, and also to point out that Japan's most recent possession, the Loochoo Islands, is a most important meteorological outpost, for about 90 per cent. of the typhoons which ravage these regions are noticed there a day earlier than in Japan.

IN reference to a recent note on the subject, Mr. W. Mattieu Williams writes that in his "Through Norway" (published in 1877) he stated on page 108 that "the North Cape is usually described as the northernmost extremity of Europe; but this is not quite correct. There is a low glaciated tongue of rock, called *Knivskjerodden* or *Knivskjælodden*, about a mile to westward of North Cape, which projects farther north than the Cape itself." "It is a misnomer," he states, "to call this a 'Cape,' especially in the presence of magnificent capes which abound thereabouts. (The perpendicular face of North Cape is 974 feet high; others are above 1000 feet.) It should not be forgotten that neither North Cape nor this little ambitious out-poke is the northernmost point of the European continent. This distinction belongs to Nord Kyn, the North Cape and *Knivskjælodden* being on Magerö, an outlying island."

THE authorities of the University of Tokio have, we observe, instructed one of their officers to devote himself wholly to the study of seismic phenomena. The gentleman selected for this purpose, Mr. Sekiya, is the Japanese Secretary to the Seismological Society of Japan, and has already had much experience in earthquake observation, which has thus become an official study in that country.

A WRITER in a recent issue of the *North China Herald* discusses the early Chinese notions of immortality. In the most ancient times ancestral worship was maintained on the ground that the souls of the dead exist after this life. The present is a part only of human existence, and men continue to be after death what they have become before it. Hence the honours accorded to men of rank in their lifetime were continued to them after their death. In the earliest utterances of Chinese national thought on this subject we find that duality which has remained the prominent feature in Chinese thinking ever since. The present life is light; the future is darkness. What the shadow is to the substance, the soul is to the body; what vapour is to water, breath is to man. By the process of cooling steam may again become water, and the transformations of animals teach us that beings inferior to man may live after death. Ancient Chinese then believed that as there is a male and female principle in all nature, a day and a night as inseparable from each thing in the universe as from the universe itself, so it is with man. In the course of ages, and in the vicissitudes of

religious ideas, men came to believe more definitely in the possibility of communications with supernatural beings. In the twelfth century before the Christian era it was a distinct belief that the thoughts of the sages were to them a revelation from above. The "Book of Odes" frequently uses the expression "God spoke to them," and one sage is represented after death "moving up and down in the presence of God in heaven." A few centuries subsequently we find for the first time great men transferred in the popular imagination to the sky, it being believed that their souls took up their abode in certain constellations. This was due to the fact that the ideas of immortality had taken a new shape, and that the philosophy of the times regarded the stars of heaven as the pure essences of the grosser things belonging to this world. The pure is heavenly and the gross earthly, and therefore that which is purest on earth ascends to the regions of the stars. At the same time hermits and other ascetics began to be credited with the power of acquiring extraordinary longevity, and the stork became the animal which the Immortals preferred to ride above all others. The idea of plants which confer immunity from death soon sprang up. The fungus known as *Polyporus lucidus* was taken to be the most efficacious of all plants in guarding man from death, and three thousand ounces of silver have been asked for a single specimen. Its red colour was among the circumstances which gave it its reputation, for at this time the five colours of Babylonian astrology had been accepted as indications of good and evil fortune. This connection of a red colour with the notion of immortality through the medium of good and bad luck led to the adoption of cinnabar as the philosopher's stone, and thus to the construction of the whole system of alchemy. The plant of immortal life is spoken of in ancient Chinese literature at least a century before the mineral. In correspondence with the tree of life in Eden there was probably a Babylonian tradition which found its way to China shortly before Chinese writers mention the plant of immortality. The Chinese, not being navigators, must have got their ideas of the ocean which surrounds the world from those who were, and when they received a cosmography they would receive it with its legends.

MR. SIDNEY OLLIFF has been appointed Assistant Curator of the Australian Museum, Sydney, New South Wales.

THE additions to the Zoological Society's Gardens during the past week include a Vervet Monkey (*Cercopithecus landanii* ♂) from South Africa, presented by Mr. Thomas Eley; a Grivet Monkey (*Cercopithecus griseo-viridis* ♂) from West Africa, presented by Mrs. K. E. Villiers; a Common Paradoxure (*Paradoxurus typus*) from India, presented by Mrs. L. McArthur; a Hedgehog (*Eriacus europæa*), British, presented by Mr. C. G. Hopkins; a Laughing Kingfisher (*Dacelo gigantea*) from Australia, presented by Mrs. A. M. Packard; two — Seed-eaters (*Criothaga* —) from South Africa, presented by Mr. W. B. Cheadle, F.Z.S.; a Mute Swan (*Cygnus olor* ♂), European, presented by Lady Siemens; a Common Chameleon (*Chamaeleon vulgaris*) from North Africa, a Common Viper (*Vipera berus*), British, presented by Mr. F. H. Jennings; a Proteus (*Proteus anguinus*), European, presented by Mr. W. J. Miles; three Common Marmosets (*Hapale jacchus*) from Brazil, six Canadian Beavers (*Castor canadensis*) from Canada, two Lesser Sulphur-crested Cockatoos (*Cacatua sulphurea*) from the Moluccas, deposited; a Talapoin Monkey (*Cercopithecus talapoin*), an Allen's Galago (*Galago alleni*), a Thick-billed Pigeon (*Treron macrorhyncha*), a River Jack Viper (*Vipera rhinoceros*) from West Africa, two Horrid Rattlesnakes (*Crotalus horridus*) from Florida, purchased; four Hardwick's Mastigures (*Uromastix hardwickii*) from India, two Bengal Monitors (*Varanus bengalensis*) from Bengal, a Nilotic Crocodile (*Crocodilus vulgari*) from Africa, received in exchange.

## OUR ASTRONOMICAL COLUMN

**VARIABLE STARS.**—Minima of the short-period variable S Cancri may be expected about November 8, 9h. 5m.; November 27, 8h. 21m.; and December 16, 7h. 36m. The latest observations upon record were made by Schmidt in 1883: he found the star faint on March 12 at 7<sup>h</sup>.2h. and March 31 at 12<sup>h</sup>.8h. mean time at Athens. The star does not appear to have been much observed of late years, and further observations are needed as a check upon the period. An abstract of Prof. Schönfeld's discussion on the fluctuations of this variable will be found in vol. ix. of the *Vierteljahrsschrift der Astronomischen Gesellschaft*, p. 226; he there gives as elements

Minimum = 1867 August 31, 14h. 12<sup>m</sup>.4m. Paris M.T. +  
(9d. 11h. 37<sup>m</sup>.75m.) E.

The diminution of light appears to commence about 8½ hours before the minimum; about 13 hours after minimum the star attains its usual brightness. It is therefore a variable of the Algol type. The abstract of Prof. Schönfeld's memoir referred to above is a pretty full one: the memoir itself is not to be found in the libraries either of the Royal or Royal Astronomical Societies.

Considering the great loss which this branch of observational astronomy sustained in the death of Prof. Schmidt, it is very satisfactory to find that observations of variable stars are systematically made at several Continental observatories, including the important physical establishment at Potsdam, where Dr. Wilsing is giving much attention to the subject. In the year 1883 he made upwards of 380 series of observations on 38 stars, including 24 of R Coronæ, a star which has been too much neglected. Prof. Safarik, Director of the Observatory at Prague, made numerous determinations of the brightness of some fifty stars during the same year: he mentions two *maxima* of U Geminorum, which we take to be a clerical error for *minima*. He further states that the companion of S Orionis 10<sup>h</sup>.11 m., was invisible at the beginning of 1883, and continued so until April; in August it was again visible, and slowly attained 10<sup>h</sup>.9 m., so that it is variable to the extent of several magnitudes, and Prof. Safarik adds, "möglichlicherweise alterniren seine Erscheinungen mit jenen von S Orionis." If there is reason to suspect this, the star will obviously deserve close attention. The companion precedes 2<sup>h</sup>.5s., and is south 0<sup>h</sup>.4.

The positions of S Cancri and S Orionis for 1885<sup>o</sup> are:—

	R.A.		N.P.D.
	h.	m. s.	
S Cancri ...	8	37 22	70 33 <sup>o</sup> 1
S Orionis ...	5	23 20	94 46 <sup>o</sup> 9

Reference was made in a former column to the approaching maximum of  $\chi$  Cygni about the middle of November.

**WOLF'S COMET.**—A circular of the Vienna Academy contains elliptical elements of this comet by Dr. Zelbr, which confirm generally the calculations of Prof. Krueger and Mr. S. C. Chandler; the period of revolution is found to be 6.76 years, the perihelion passage November 17<sup>h</sup>.67.39 Greenwich M.T. At midnight on that date the comet will be in R.A. 341<sup>o</sup> 50', N.P.D. 92<sup>o</sup> 8, distant from the earth 0.979.

**THE SOLAR ECLIPSE OF MARCH 16, 1885.**—The commencement of this eclipse will be visible just before sunset on the west coast of Ireland. So far as we are aware, the only astronomical observatory at which it will be observable is that of Col. Cooper at Markree, which is in charge of Mr. Marth. The first contact takes place there at 5h. 43m. 58s. Markree M.T. at 86° from north point towards west, for direct image. At Valentia the eclipse begins at 5h. 40m. 22s. local mean time, at 82° from north towards west. Particulars of the track of the annular eclipse across the United States and Canada have already appeared in this column.

## GEOGRAPHICAL NOTES

An interesting pamphlet, on the systems of writing used by the various races which inhabited or still inhabit the Philippine Islands, has just been published by Señor Pardo de Tavera under the title "Contribucion para el estudio de los Antiguos Alfabetos Filipinos." It is illustrated with plates containing the alphabets discussed, which include those of the Tagals, Visayas or Bisayas, and the Battas. This archipelago offers a comparatively virgin field to students in almost every branch of inquiry.

Prof. Blumentritt of Leitmeritz has devoted much study and research to the early history of the Spanish occupation of Luzon, and to the settlements of the Chinese and Japanese there during the sixteenth and seventeenth centuries, but since the publication of Jagor's work nearly thirty years ago little that is generally known in Europe has been done to solve the various problems which the languages, races, and geography of the islands present. In Spain there exists an important literature, chiefly of the last century, on the subject, and the works of Fray Gaspar, Argensola, Bravo, and others should be a mine for the modern student. The ethnology of the Negritos of the Philippines has been discussed in Germany by Dr. Mundt-Lauf; but of the wild mountain tribes of the interior, and of those who are in a state of chronic war with the Spaniards to the south of Iloilo, hardly anything is known. There is a vague surmise that some of them (the Igorrotes of Luzon, for example) are descendants of Chinese pirates of the latter end of the sixteenth century, who having attacked the Spanish settlements were defeated, and fled to the mountains, where they took themselves wives of the natives and became the progenitors of a new race.

THE last number of the *Zeitschrift der Gesellschaft für Erdkunde zu Berlin* contains a long paper by Prof. Blumentritt on the Island of Mindanao, the second largest of the Philippine Islands, accompanied by an excellent map, based on numerous Spanish maps. The writer enters at length into the geography and ethnology of the island, dealing in successive sections with the mountains, hydrography, political divisions, population, and the eighteen tribes which inhabit it. With regard to the last section of his subject, Prof. Blumentritt says that if we omit the few Europeans, Creoles, Mestizos, and Chinese, the natives of Mindanao may be divided into Negritos and Malays. The former are subdivided into Mamanuás and Atas, while the latter are composed of a series of tribes which may be approximately placed according to their religion under three heads: (1) the Visayas, or "Old Christians"; (2) the mountain tribes, who are either Pagans or Conquistas; (3) the Moros (Moors), who are Mohammedans. The Visayas and Moors are late-comers; the former arrived within the period of Spanish rule in the island from the archipelago lying to the north, which at present bears the name of the Visaya Islands; the Moros also came recently from Borneo and Ternate. Our knowledge of the mountain tribes, says Prof. Blumentritt, is not sufficient to enable us to state definitely what relation they bear to the Visayas, or to the head-hunters of Borneo and Luzon. In the following sections of his paper the writer gives all the information available respecting these tribes, his sources being chiefly the reports of Spanish missionaries. In many cases this information is of the vaguest possible description. In addition to the eighteen tribes here mentioned, there are no fewer than fourteen States with independent Sultans amongst the Moros of Mindanao.

THE same number of the *Zeitschrift* also contains a paper (with a map) on the Loochoo Islands, by Herr Müller-Beeck. It appears to be wholly taken from reports furnished to the Japanese Government by an official who visited the archipelago several times for the purpose of investigation. The paper adds little to our knowledge of the islands, because there is probably not a great deal to know about them geographically. By the way, Herr Müller-Beeck is in error in attributing the name Lin-choten, as applied to the seven islands of the northern group called Shichi-to, to the English. This corruption is due to the Dutch, and like many similar corruptions still retains its place in our Admiralty charts as the name by which the islands are known to European navigators.

M. BRAU DE SAINT-POL LIAS, who, as recently mentioned in NATURE, has been commissioned by the French Minister of Public Instruction to make a natural history collection in Sumatra and Java, is an experienced traveller in those regions. Not long since he published a work on Perak, in the Malay Peninsula, and the tribes inhabiting it. He has now issued another small volume on the Acheenese, under the title of "Chez les Atchés-Lohong" (Paris, Plon). Having made friends with the head-man of Lohong, he was able to travel freely in that portion of Sumatra, and to observe the customs of the natives. Not long before, two of his countrymen were murdered in neighbouring territory, through which, however, M. Lias was allowed to pass. He appears also to have travelled near the now notorious Tenom, where the unfortunate crew of the *Nisero* were so long confined, and on the whole to have enjoyed advantages for obtaining information about this little-known region—although

it lies within a few miles of the path of the greater part of the trade of Europe with the Far East—than any previous traveller. The apparently interminable war between the Dutch and the natives of Sumatra renders travelling or investigation in that marvellous island all but impossible to Europeans.

AT a meeting of the Society for Commercial Geography of Paris, held on the 21st inst. under the presidency of M. Meurand, Dr. Neis, of the Naval Medical Service, recounted the incidents of a recent journey from Saigon to the frontiers of Tonquin, and thence to Bangkok. He travelled from the basin of the Meikong to that of the Meinam, and referred in his paper to the various tribes met on the frontiers of Tonquin and Cambodia, and to the progress of England in Siam and Burmah. The Society, we observe, now numbers 1000 members.

The following is a list of the papers arranged to be read before the Society for Commercial Geography of Oporto during the ensuing winter session:—Useful animals of Portugal and its possessions, by M. Torgo, jun.; crime from climatological and ethnological points of view, by M. Veloso; the geography of the Azores, by M. Silva; the exportation of national products to Brazil and the Portuguese colonies, by M. Gonsalvez; the climatological geography of the Portuguese colonies, by M. Monteiro; recent colonial treaties with England, by M. de Souza.

*Petermann's Mittheilungen* for October contains an article on the south-western portion of the province of Ciudad-Real, in Spain, with a map, by Herr Otto Neussel; one by Dr. Roukis, on the ethnography and statistics of Albania, based on a series of articles contributed to the Athens journal *Acropolis*, under the title of "The Present and the Future of Albania," by the late Greek Consul-General in that country; a third paper on Terek is a translation of one read before the Caucasian section of the Russian Geographical Society by Herr Dinnik. The "Recent Information from Corea" is that published in English Blue-books as reports from various consular officials who have lately visited the peninsula.

#### NOTES ON NITRIFICATION<sup>1</sup>

IN the following brief notes I propose to consider in the first place the present position of the theory of nitrification, and next to give a short account of the results of some recent experiments conducted in the Rothamsted Laboratory.

*The Theory of Nitrification.*—The production of nitrates in soils, and in waters contaminated with sewage, are facts thoroughly familiar to chemists. It is also well known that ammonia, and various nitrogenous organic matters, are the materials from which the nitric acid is produced. Till the commencement of 1877 it was generally supposed that this formation of nitrates from ammonia or nitrogenous organic matter was the result of simple oxidation by the atmosphere. In the case of soil it was imagined that the action of the atmosphere was intensified by the condensation of oxygen in the pores of the soil; in the case of waters no such assumption was possible. This theory was most unsatisfactory, as neither solutions of pure ammonia, or of any of its salts, could be nitrified in the laboratory by simple exposure to air. The assumed condensation of oxygen in the pores of the soil also proved to be a fiction as soon as it was put by Schloesing to the test of experiment.

Early in 1877, two French chemists, Messrs. Schloesing and Müntz, published preliminary experiments showing that nitrification in sewage and in soils is the result of the action of an organised ferment, which occurs abundantly in soils and in most impure waters. This entirely new view of the process of nitrification has been amply confirmed both by the later experiments of Schloesing and Müntz, and by the investigations of other chemists, amongst which are those by myself conducted in the Rothamsted Laboratory.

The evidence for the ferment theory of nitrification is now very complete. Nitrification in soils and waters is found to be strictly limited to the range of temperature within which the vital activity of living ferments is confined. Thus nitrification proceeds with extreme slowness near the freezing-point, and increases in activity with a rise in temperature till 37° are reached; the action then diminishes, and ceases altogether at 55°. Nitrification is also dependent on the presence of plant-

food suitable for organisms of low character. Recent experiments at Rothamsted show that in the absence of phosphates no nitrification will occur. Further proof of the ferment theory is afforded by the fact that antiseptics are fatal to nitrification. In the presence of a small quantity of chloroform, carbon bisulphide, salicylic acid, and apparently also phenol, nitrification entirely ceases. The action of heat is equally confirmatory. Raising sewage to the boiling-point entirely prevents its undergoing nitrification. The heating of soil to the same temperature effectually destroys its nitrifying power. Finally, nitrification can be started in boiled sewage, or in other sterilised liquid of suitable composition, by the addition of a few particles of fresh surface soil, or a few drops of a solution which has already nitrified; though without such addition these liquids may be freely exposed to filtered air without nitrification taking place.

The nitrifying organism has been submitted as yet to but little microscopical study; it is apparently a micrococcus.

It is difficult to conceive how the evidence for the ferment theory of nitrification could be further strengthened; it is apparently complete in every part. Although, however, nearly the whole of this evidence has been before the scientific public for more than seven years, the ferment theory of nitrification can hardly be said to have obtained any general acceptance; it has not indeed been seriously controverted, but neither has it been embraced. In hardly a single manual of chemistry is the production of saltpetre attributed to the action of a living ferment existing in the soil. Still more striking is the absence of any recognition of the evidence just mentioned when we turn to the literature and to the public discussions on the subjects of sewage, the pollution of river water, and other sanitary questions. The oxidation of the nitrogenous organic matter of river water is still spoken of by some as determined by mere contact with atmospheric oxygen, and the agitation of the water with air as a certain means of effecting oxidation; while by others the oxidation of nitrogenous organic matter in a river is denied, simply because free contact with air is not alone sufficient to produce oxidation. How much light would immediately be thrown on such questions if it were recognised that the oxidation of organic matter in our rivers is determined solely by the agency of life, is strictly limited to those conditions within which life is possible, and is most active in those circumstances in which life is most vigorous. It is surely most important that scientific men should make up their minds as to the real nature of those processes of oxidation of which nitrification is an example. If the ferment theory be doubted, let further experiments be made to test it, but let chemists no longer go on ignoring the weighty evidence which has been laid before them. It is partly with the view of calling the attention of English and American chemists to the importance of a decision on this question that I have been induced to bring this subject before them on the present occasion. I need hardly add that such results as the nitrification of sewage by passing it through sand, or the nitrification of dilute solutions of blood prepared without special precaution, are no evidence whatever against the ferment theory of nitrification. If it is to be shown that nitrification will occur in the absence of any ferment, it is clear that all ferments must be rigidly excluded during the experiments; the solutions must be sterilised by heat, the apparatus purified in a similar manner, and all subsequent access of organisms carefully guarded against. It is only experiments made in this way that can have any weight in deciding the question.

Leaving now the theory of nitrification, I will proceed to say a few words, firstly, as to the distribution of the nitrifying organism in the soil; secondly, as to the substances which are susceptible of nitrification; thirdly, upon certain conditions having great influence on the process.

*The Distribution of the Nitrifying Organism in the Soil.*—Three series of experiments have been made on the distribution of the nitrifying organism in the clay soil and subsoil at Rothamsted. Advantage was taken of the fact that deep pits had been dug in one of the experimental fields for the purpose of obtaining samples of the soil and subsoil. Small quantities of soil were taken from freshly-cut surfaces on the sides of these pits at depths varying from 2 inches to 8 feet. The soil removed was at once transferred to a sterilised solution of diluted urine, which was afterwards examined from time to time to ascertain if nitrification took place. These experiments are hardly yet completed; the two earlier series of solutions have, however, been examined for eight and seven months respectively. In both these series the soil taken from 2 inches, 9 inches, and

<sup>1</sup> A Paper by R. Warington, read before the Chemical Section of the British Association at Montreal.

18 inches from the surface has been proved to contain the nitrifying organism by the fact that it has produced nitrification in the solutions to which it was added; while in twelve distinct experiments made with soil from greater depths no nitrification has yet occurred, and we must therefore conclude that the nitrifying organism was not present in the samples of soil taken. The third series of experiments has continued as yet but three months and a half; at present no nitrification has occurred with soil taken below 9 inches from the surface. It would appear, therefore, that in a clay soil the nitrifying organism is confined to about 18 inches from the surface; it is most abundant in the first 6 inches. It is quite possible, however, that in the channels caused by worms, or by the roots of plants, the organism may occur at greater depths. In a sandy soil we should expect to find the organism at a lower level than in clay, but of this we have as yet no evidence. The facts here mentioned are in accordance with the microscopical observations made by Koch, who states that the micro-organisms in the soils he has investigated diminish rapidly in number with an increasing depth; and that at a depth of scarcely 1 metre the soil is almost entirely free from bacteria.

Some very practical conclusions may be drawn from the facts now stated. It appears that the oxidation of nitrogenous matter in soil will be confined to matter near the surface. The nitrates found in the subsoil and in subsoil drainage waters have really been produced in the upper layer of the soil, and have been carried down by diffusion, or by a descending column of water. Again, in arranging a filter-bed for the oxidation of sewage, it is obvious that, with a heavy soil lying in its natural state of consolidation, very little will be gained by making the filter-bed of considerable depth; while, if an artificial bed is to be constructed, it is clearly the top soil, rich in oxidising organisms, which should be exclusively employed.

*The Substances susceptible of Nitrification.*—The analyses of soils and drainage waters have taught us that the nitrogenous humic matter resulting from the decay of plants is nitrifiable; also that the various nitrogenous manures applied to land, as farmyard manure, bones, fish, blood, rape-cake, and ammonium salts, undergo nitrification in the soil. Illustrations of many of these facts from the results obtained in the experimental fields at Rothamsted, have been published by Sir J. B. Lawes, Dr. J. H. Gilbert, and myself, in a recent volume of the *Journal* of the Royal Agricultural Society of England. In the Rothamsted Laboratory, experiments have also been made on the nitrification of solutions of various substances. Besides solutions containing ammonium salts and urea, I have succeeded in nitrifying solutions of asparagine, milk, and rape-cake. Thus, besides ammonia, two amides, and two forms of albuminoids have been found susceptible of nitrification. In all cases in which amides or albuminoids were employed, the formation of ammonia preceded the production of nitric acid. Mr. C. F. A. Tuxen has already published in the present year two series of experiments on the formation of ammonia and nitric acid in soils to which bone-meal, fish-guano, or stable-manure had been applied; in all cases he found the formation of ammonia preceded the formation of nitric acid.

As ammonia is so readily nitrifiable, we may safely assert that every nitrogenous substance which yields ammonia when acted on by the organisms present in soil is also nitrifiable.

*Certain Conditions having Great Influence on the Process of Nitrification.*—If we suppose that a solution containing a nitrifiable substance is supplied with the nitrifying organism, and with the various food-constituents necessary for its growth and activity, the rapidity of nitrification will depend on a variety of circumstances:—(1) The degree of concentration of the solution is important. Nitrification always commences first in the weakest solution, and there is probably in the case of every solution a limit of concentration beyond which nitrification is impossible. (2) The temperature has great influence. Nitrification proceeds far more rapidly in summer than in winter. (3) The presence or absence of light is important. Nitrification is most rapid in darkness; and in the case of solutions, exposure to strong light may cause nitrification to cease altogether. (4) The presence of oxygen is of course essential. A thin layer of solution will nitrify sooner than a deep layer, owing to the larger proportion of oxygen available. The influence of depth of fluid is most conspicuous in the case of strong solutions. (5) The quantity of nitrifying organism present has also a marked effect. A solution seeded with a very small amount of organism will for a long time exhibit no nitrification, the organism being (unlike some

other bacteria) of very slow growth. A solution receiving an abundant supply of the ferment will exhibit speedy nitrification, and strong solutions may by this means be successfully nitrified, which with small seedings would prove very refractory. The speedy nitrification which occurs in soil (far more speedy than in experiments in solutions under any conditions yet tried) is probably owing to the great mass of nitrifying organisms which soil contains, and to the thinness of the liquid layer which covers the soil particles. (6) The rapidity of nitrification also depends on the degree of alkalinity of the solution. Nitrification will not take place in an acid solution, it is essential that some base should be present with which the nitric acid may combine; when all available base is used up nitrification ceases. It appeared of interest to ascertain to what extent nitrification would proceed in a dilute solution of urine without the addition of any substance save the nitrifying ferment. As urea is converted into ammonium carbonate in the first stage of the action of the ferment, a supply of salifiable base would at first be present, but would gradually be consumed. The result of the experiment showed that only one-half the quantity of nitric acid was formed in the simple urine solution as in similar solutions containing calcium and sodium carbonate. The nitrification of the urine had evidently proceeded till the whole of the ammonium had been changed into ammonium nitrate, and the action had then ceased. This fact is of practical importance. Sewage will be thoroughly nitrified only when a sufficient supply of calcium carbonate, or some other base, is available. If, instead of calcium carbonate, a soluble alkaline salt is present, the quantity must be small, or nitrification will be seriously hindered. Sodium carbonate begins to have a retarding influence on the commencement of nitrification when its amount exceeds 300 milligrammes per litre, and up to the present time I have been unable to produce an effective nitrification in solutions containing 1000 grammes per litre. Sodium hydrogen carbonate hinders far less the commencement of nitrification. Ammonium carbonate, when above a certain amount, also prevents the commencement of nitrification. The strongest solution in which nitrification has at present commenced contained ammonium carbonate equivalent to 368 milligrammes of nitrogen per litre. This hindrance of nitrification by the presence of an excess of ammonium carbonate effectually prevents the nitrification of strong solutions of urine, in which, as already mentioned, ammonium carbonate is the first product of fermentation. Far stronger solutions of ammonium chloride can be nitrified than of ammonium carbonate, if the solution of the former salt is supplied with calcium carbonate. Nitrification has in fact commenced in chloride of ammonium solutions containing more than 2 grammes of nitrogen per litre.

The details of the recent experiments, some of the results of which we have now described, will, it is hoped, shortly appear in the *Journal* of the Chemical Society of London.

Harpenden, July 21

## RESEARCHES ON THE ORIGIN AND LIFE-HISTORIES OF THE LEAST AND LOWEST LIVING THINGS<sup>1</sup>

II.

**B**UT the point of difficulty was *B. termo*. The demonstration of its flagella was a task of difficulty which only patient purpose could conquer. But by the use of our new lenses, and special illumination we—my colleague and I—were enabled to demonstrate clearly a flagellum at each end of this least of living organisms, as you see, and by the rapid lashing of the fluid, alternately or together, with these flagella, the powerful, rapid, and graceful movements of this smallest known living thing are accomplished. Of course these fibres are inconceivably fine—indeed for this very reason it was desirable, if possible, to measure it, to discover its actual thickness. We all know that, both for the telescope and the microscope, beautiful apparatus are made for measuring minute magnified details. But unfortunately no instrument manufactured was delicate enough to measure directly this fibre. If it were measured it must be by an indirect process, which I accomplished thus:—The diameter of the body of *B. termo*, i.e. from side to side, may in different forms vary from the 20- to the 50-thousandth of an inch. That is a measurement which we may easily make directly with a micrometer. Having ascertained this, I deter-

<sup>1</sup> By Rev. W. H. Dallinger, LL.D., F.R.S., F.L.S., Pres. R.M.S. Continued on p. 622.

mined to discover the ratio of thickness between the body of the Bacterium and its flagellum—that is to say, to discover how many of the flagella laid side by side would make up the width of the body.

I proceeded thus. This is a complicated microscope placed on a tripod, so arranged that it may be conveniently worked upright. There is a special instrument for centering and illuminating. On the stage of the instrument, the Bacterium with its flagellum in distinct focus is placed. Instead of the simple eyepiece a camera lucida is placed upon it. This instrument is so constructed that it appears to throw the image of the object upon the white sheet of paper on the small table at the right hand where the drawing is made, at the same time that it enables the same eye to see the pencil and the right hand. In this way I made a careful drawing of *B. termo* and its flagellum, magnified 5000 diameters. Here is a projection of the drawing made. But I subsequently avoided paper, and used under the camera a most carefully prepared surface of ground glass. When the drawing was made I placed on the drawing a drop of Canada balsam, and covered it with a circle of thin glass, just like any other microscopic mounted object. This is a micro-slide so prepared. Now you can see that I only have to lay this on the stage of a microscope, make it an object for a low power, and use a screw micrometer to find how many flagella go to the making of a body. The result is given in the figure: you see that ten flagella would fill the area occupied by the diameter of the body.

In the case chosen the body was the  $1/204000$ th of an inch wide, and therefore, when divided by ten, gave for the flagellum a thickness of the  $1/204000$ th of an English inch. In the end I made fifty separate drawings with four separate lenses. I averaged the result in each fifty; and then took the average of the total of 200, and the mean value of the width of the flagellum was the  $1/204700$ th of an English inch. It will be seen, then, that we are possessed of instruments which, when competently used, will enable us to study the life-histories of the putrefactive organisms, although they are the minutest forms of life. I have stated that they were the inevitable accompaniments of putrescence and decay. You learned from a previous illustration the general appearance of the Bacteria: they are the earliest to appear whenever putrefaction shows itself. In fact, the pioneer is this—the ubiquitous *Bacterium termo*. The order of succession of the other forms is by no means certain. But whenever a high stage of decomposition is reached a group of forms represented by these three will swarm the fluid. These are the Monads, they are strictly putrefactive organisms, they are midway in size between the least and largest Bacteria, and are, from their form and other conditions, more amenable to research, and twelve years ago I resolved, with the highest power lenses and considerable practice in their use, to attack the problem of their origin; whether as physical products of the not-living, or as the natural progeny of parents.

But you will remember that only a minute drop of fluid containing them can be examined at one time. This minute drop has to be covered with a minute film of glass not more than the  $200$ th of an inch thick. The highest lenses are employed, working so near as almost to touch the delicate cover. Clearly, then, the film of fluid would rapidly evaporate and cause the destruction of the object studied. To prevent this an arrangement was devised by which the lens and the covered fluid under examination were used in an air-tight chamber, the air of which was kept in a saturated condition; so that being like a saturated sponge unable to take in any more it left the film of fluid unaffected. But to make the work efficient I soon found that there must be a second observer. Observation by leaps was of no avail. To be accurate it must be unbroken. There must be no gap in a chain of demonstration. A thousand mishaps would occur in trying to follow a single organism through all the changes of successive hours to the end. But, however many failures, it was evident we must begin on another form at the earliest point again, and follow it to the close. I saw soon that every other method would have been merely empirical, a mere piecemeal of imagination and fact. When one observer's ability to continue a long observation was exhausted, there must be another at hand to take up the thread and continue it; and thus to the end. I was fortunate indeed at this time in securing the ready and enthusiastic aid of Dr. J. J. Drysdale, of Liverpool, who practically lived with me for the purpose and went side by side with me to the work. We admitted nothing which we had not both seen, and we succeeded each other consecutively, whenever

needed, in following to the end the complete life-histories of six of these remarkable forms.

I will now give you the facts in relation to two which shall be typical. We obtained them in enormous abundance in a maceration of fish. I will not take them in the order of our researches, but shall find it best to examine the largest and the smallest. The appearance of the former is now before you. It is divergent from the common type when seen in its perfect condition, avoiding the oval form, but it resumes it in metamorphosis. It is comparatively huge in its proportions, its average extreme length being the  $1,000$ th of an inch. Its normal form is rigidly adhered to as that of a rotifer or a crustacean. Its body-substance is a structureless sarcode. Its differentiations are a nucleus-like body, not common to the monads; generally a pair of dilating vacuoles, which open and close like the human eyelid, ten to twenty times in every minute; and lastly, the unusual number of four flagella. That the power of motion in these forms and in the Bacteria is dependent upon these flagella I believe there can be no reasonable doubt. In the monads, the versatility, rapidity, and power of movement are always correlated with the number of these. The one before us could sweep across the field with majestic slowness, or dart with lightning swiftness and a swallow's grace. It could gyrate in a spiral, or spin on its axis in a rectilinear path like a rifled bullet. It could dart up or down, and begin, arrest, or change its motion with a grace and power which at once astonish and entrance. Fixing on one of these monads then, we followed it doggedly by a never ceasing movement of a "mechanical stage," never for an instant losing it through all its wanderings and gyrations. We found that in the course of minutes, or of hours, the sharpness of its outline slowly vanish, its vacuoles disappear, and it lost its sharp caudal extremity, and was sluggishly amoeboid. This condition intensified, the amoeboid action quickened as here depicted, the agility of motion ceased, the nucleus body became strongly developed, and the whole sarcode was in a state of vivid and glittering action.

If now it be sharply and specially looked for it will be seen that the root of the flagella splits, dividing henceforth into two separate pairs. At the same moment a motion is set up which pulls the divided pairs asunder, making the interval of sarcode to grow constantly greater between them. During this time the nuclear body has commenced and continued a process of self-division; from this moment the organism grows rapidly rounder, the flagella swiftly diverge. A bean-like form is taken; the nucleus divides, and a constriction is suddenly developed; this deepens; the opposite position of the flagella ensues, the nearly divided forms now vigorously pull in opposite directions, the constriction is thus deepened and the tail formed. The fibre of sarcode, to which the constricted part has by tension been reduced, now snaps, and two organisms go free. It will have struck you that the new organism enters upon its career with only two flagella and the normal organism is possessed of four. But in a few minutes, three or four at most, the full complement were always there. How they were acquired it was the work of months to discover, but at last the mystery was solved. The newly-fissioned form darted irregularly and rapidly for a brief space, then fixed itself to the floor or to a rigid object by the ends of its flagella, and, with its body motionless, an intense vibratory action was set up along the entire length of these exquisite fibres. Rapidly the ends split, one half being in each fibre set free, and the other remaining fixed, and in 130 seconds each entire flagellum was divided into a perfect pair.

Now the amoeboid state is a notable phenomenon throughout the monads as precursive of striking change. It appears to subserve the purpose of the more facile acquisition and digestion of food at a crisis. And this augmented the difficulty of discovering further change; and only persistent effort enabled us to discover that with comparative rareness there appeared a form in an amoeboid state that was unique. It was a condition chiefly confined to the caudal end, the sarcode having become diffuent, hyaline, and intensely rapid in the protrusion and retraction of its substance, while the nuclear body becomes enormously enlarged. These never appear alone; forms in a like condition are diffused throughout the fluid, and may swim in this state for hours. Meanwhile, the diffuence causes a spreading and flattening of the sarcode, and swimming gives place to creeping, while the flagella violently lash. In this condition two forms meet by apparent accident, the protrusion touch, and instant fusion supervenes. In the course of a few

seconds there is no disconnected sarcode visible, and in five to seven minutes the organism is a union of two of the organisms, the swimming being again resumed, the flagella acting in apparent concert. This may continue for a short time, when movement begins to flag and then ceases. Meanwhile, the bodies close together, and the eye-nots or vacuoles melt together, the two nuclei become one and disappear, and in eighteen hours the entire body of "either has melted into other," and a motionless, and for a time irregular, sac is left. This now becomes smooth, spherical, and tight, being fixed and motionless. This is a typical process; but the mingled weariness and pleasure realised in following such a form without a break through all the varied changes into this condition is not easily expressed.

But now the utmost power of lenses, the most delicate adjustment of light, and the keenest powers of eyesight and attention must do the rest. Before the end of six hours the delicate glossy sac opens gently at one place, then there streams out a glairy fluid densely packed with semi-opaque granules, just fairly visible when their area was increased six millions of times, and this continued until the whole sac was empty and its entire contents diffused. To follow with our utmost powers these exquisite specks was an unspeakable pleasure, a group seen to roll from the sac, when nearly empty, were fixed and never left. They soon palpably changed by apparent swelling or growth, but were perfectly inactive; but at the end of three hours a beaked appearance was presented. Rapid growth set in, and at the end of another hour, how has entirely baffled us, they acquired flagella and swam freely; in thirty-five minutes more they possessed a nucleus and rapidly developed, until at the end of nine hours after emission a sporule was followed to the parent condition and left in the act of fission. In this way, with what difficulties I need not weary you, a complete life-cycle was made out.

And now I will invite your attention to the developmental history of the *most minute* of the six forms we studied. In form it is a long oval, it is without visible structure or differentiation within, and is possessed of only a single flagellum. Its utmost length is the 500th of an inch. Its motion is continuous in a straight line, and not intensely rapid, nor greatly varied, being wholly wanting in curves and darts. The copiousness of its increase was, even to our accustomed eyes, remarkable in the extreme, but the reason was discovered with comparative ease. Its fission was not a division into two but into many. The first indication of its approach in following this delicate form was the assumption rapidly of a rounder shape. Then followed an amœboid and uncertain form, with an increased intensity of action which lasted a few moments when lassitude supervened, then perfect stillness of the body, which is now globular in form, while the flagellum feebly lashed, and then fell upon and fused with the substance of the sarcode. And the result is a solid, flattened, homogeneous ball of living jelly.

To properly study this in its further changes, a power of from three to four thousand diameters must be used, and with this I know of few things in the whole range of minute beauty more beautiful than the effect of what is seen. In the perfectly motionless flattened sphere, without the shimmer of premonition and with inconceivable suddenness, a white cross smites itself, as it were, through the sarcode. Then another with equal suddenness at right angles, and while with admiration and amazement one for the first time is realising the shining radii, an invisible energy seizes the tiny speck, and fixing its centre, twists its entire circumference, and endow it with a turbinated aspect. From that moment intense interior activity became manifest. Now the sarcode was, as it were, kneading its own substance, and again an inner whirling motion was visible, reminding one of the rush of water round the interior of a hollow sphere on its way to a jet or fountain. Deep fissures or indentions showed themselves all over the sphere; and then at the end of ten or more minutes all interior action ceased, and the sphere had segmented into a coiled mass. There was no trace of an investing membrane; the constituent parts were related to each other simply as the two separating parts of an ordinary fission; and they now commenced a quick, writhing motion like a knot of eels, and then, in the course of from seven to thirty minutes separated, and fully endowed with flagella swam freely away, minute but perfect forms, which by the rapid absorption of pabulum attained speedily to the parent size.

It is characteristic of this group of organic forms that multi-

plication by self-division is the common and continuous method of increase. The other and essential method was comparatively rare and always obscure. In this instance, on the first occasion the continuous observation of the same "field" for five days failed to disclose to us any other method of increase but this multiplication, and it was only the intense suggestiveness of past experience that kept us still alert and prevented us from inferring that it was the *only* method. But eventually we perceived that while this was the prevailing phenomenon, there were scattered amongst the others forms of the same kind *larger* than the rest, and with a singular granular aspect towards the flagellate end. It may be easily contrasted with the normal or ordinary form. Now by doggedly following one of these through all its wanderings a wholly new phase in the morphology of the creature was revealed. This roughened or granular form seized upon and fastened itself to a form in the ordinary condition. The two swam freely together, both flagella being in action, but it was shortly palpable that the larger one was absorbing the lesser. The flagellum of the smaller one at length moved slower, then sluggishly, then fell upon the sarcode, which rapidly diminished, while the bigger form expanded and became vividly active until the two bodies had actually fused into one. After this its activity diminished, in a few minutes the body became quite still, leaving only a feeble motion in the flagellum, which soon fell upon the body-substance and was lost. All that was left now was a still spheroidal glossy speck, tinted with a brownish yellow. A peculiarity of this monad is the extreme uncertainty of the length of time which may elapse before even the most delicate change in this sac is visible. Its absolute stillness may continue for ten or more hours. During this time it is absolutely inert; but at last the sac—for such it is—opens gently, and there is poured out a brownish glairy fluid. At first the stream is small, but at length its flow enlarges the rift in the cyst, and the cloudy volume of its contents rolls out, and the hyaline film that inclosed it is all that is left.

The nature of the outflow was like that produced by the pouring of strong spirit into water. But no power that we could employ was capable of detecting a *granule* in it. To our most delicate manipulation of light, our finest optical appliances, and our most riveted attention, it was a homogeneous fluid and nothing more. This for a while baffled and disturbed us. It lured us off the scent. We inferred that it might possibly be a fertilising fluid, and that we must look in other directions for the issue. But this was fruitless, and we were driven again to the old point, and having once more obtained the emitted fluid, determined to fix a lens magnifying 5000 diameters upon a clear space over which the fluid had rolled, and near to the exhausted sac, and ply our old trade of *watching*-unbroken observation.

The result was a reward indeed. At first the space was clear and white, but in the course of a hundred minutes there came suddenly into view the minutest conceivable specks. I can only compare the coming of these to the growth of the stars in a starless space upon the eye of an intense watcher in a summer twilight. You knew but a few minutes since a star was not visible there, and now there is no mistaking its pale beauty. It was so with these inexpressibly minute sporules; they were not there a short time since, but they grew large enough for our optical aids to reveal them and there they were. Such a field after one hour's watching I present to you. And here I would remark that these delicate specks were unlike any which we saw emerge directly from the sac as granules. In that condition they were always semi-opaque, but here they were transparent, and a brown yellow, the condition always sequent upon a certain measure of growth.

To follow these without the loss of an instant's vision was pleasure of the highest kind. In an hour and ten minutes from their first discovery they had grown to oval points. In one hour more the specks had become beaked and long. And this pointed end was universally the end from which the flagellum emerged. With the flagellum comes motion, and with that abundant pabulum, and therefore rapid growth. But when motion is attained we are compelled to abandon the mass and follow one in all its impetuous travels in its little world; and by doing so we are enabled to follow the developed speck into the parent condition and size, and not to leave it until it had, like its predecessors, entered on and completed its wonderful self-division by fission.

It becomes then clearly manifest that these organisms, lowly and little as they are, arise in fertilised parental products. There is no more caprice in their mode of origin, than in that of a crustacean or a bird. Their minuteness, enormous abundance, and universal distribution, is the explanation of their rapid and



practically ubiquitous appearance in a germinating and adult condition. The presence of putrefiable or putrescent matter determines at once the germination of the always-present spore. But a new question arises. These spores are definite products. In the face of some experimental facts one was tempted to inquire, have these spores any capacity to resist heat greater than the adults? It was not easy to determine this question. But we at length were enabled to isolate the germs of seven separate forms, and by means of delicate apparatus, and some twelve months of research, to place each spore sac in an apparatus so constructed that it could be raised to successive temperatures, and without any change of conditions examined on the stage of the microscope.

In this way we reached successive temperatures higher and higher until the death point—the point beyond which no subsequent germination ever occurred—was reached in regard to each organism. The result was striking. The normal death point for the adult was 140° F. One of the monads emitted from its sac minute mobile specks—evidently living bodies—which rapidly grew. These we always destroyed at a temperature of 180° F. Three of the sacs emitted spores that germinated at every temperature under 250° F. Two more only had their power of germination destroyed at 260° F. And one, the least of all the monad forms, in a heat partially fluid and partially dry, at all points up to 300° F. But if wholly in fluid it was destroyed at the point of 290° F. The average being that the power of heat resistance in the spore was to that of the adult as 11 to 6. From this it is clear that we dare not infer spontaneous generation after heat until we know the life-history of the organism.

In proof of this I close with a practical case. A trenchant and resolute advocate of the origin of living forms *de novo*, has published what he considers a crucial illustration in support of his case. He took a strong infusion of common cress, placed it in a flask, boiled it, and, whilst boiling, hermetically sealed it. He then heated it up in a digester to 270° F. It was kept for nine weeks and then opened, and, in his own language, on microscopical examination of the earliest drop "there appeared more than a dozen very active monads." He has fortunately measured and roughly drawn these. A facsimile of his drawing is here. He says that they were possessed of a rapidly moving lash, and that there were other forms without tails, which he assumed were developmental stages of the form. This is nothing less than the monad whose life-history I gave you last. My drawings, magnified 2500 diams., of the active organism and the developing sac, are here.

Now this experimenter says that he took these monads and heated them to a temperature of about 140° F., and they were all absolutely killed. This is accurately our experience. But he says these monads arose in a closed flask, the fluid of which had been heated up to 270° F. Therefore, since they are killed at 140° F., and arose in a fluid after being heated to 270° F., they must have arisen *de novo*! But the truth is that this is the monad whose spore only loses its power to germinate at a temperature (in fluid) of 290°, that is to say, 20° F. higher than the heat to which, in this experiment, they had been subjected. And therefore the facts compel the deduction that these monads in the cress arose, not by a change of dead matter into living, but that they germinated naturally from the parental spore which the heat employed had been incompetent to injure. Then we conclude with a definite issue, viz., by experiment it is established that living forms do not now arise in dead matter. And by study of the forms themselves it is proved that, like all the more complex forms above them, they arise in parental products. The law is as ever, only that which is living can give origin to that which lives.

### WHIRLWINDS AND WATERSPOUTS<sup>1</sup>

WHIRLWINDS, whether on sea or on land, have their characters in great part alike. For simplicity it will be convenient to begin by taking up only the case of whirlwinds on sea, as thus the necessity for alternative expressions to suit both cases, that of sea and that of land, will be avoided.

It may be accepted as a fact sufficiently established, both by dynamic theory and by barometric observations, that at the sea-level the pressure of the air is less in the neighbourhood

of the axis of whirl than it is at places farther out from the axis, though within the region of the whirl. The apocentric force (centrifugal force) of the rapidly-revolving air resists the inward pulsive tendency of the greater outer than inner pressure. But close over the surface of the sea there exists necessarily a lamina of air greatly deadened as to the whirling motion by fluid friction, or resistance, against the surface of the sea; and all the more so because of that surface being ruffled into waves and often broken up into spray. This frictionally-deadened lamina exerts, because of its diminished whirl speed, less apocentric force than the quicker-revolving air above it, and so is incapable of resisting the inward pulsive tendency of the greater outer than inner pressure already mentioned. Hence, while rushing round in its whirl, the air of that lamina must also be flowing in centreward.

The influx of air so arriving at the central region cannot remain there continually accumulating; it is not annihilated, and it certainly does not escape downwards through the sea. There is no outlet for it except upwards, and as a rising central core it departs from that place. This is one way of thinking out some of the conditions of the complex set of actions under contemplation; but there is much more yet to be considered.

Hitherto, in the present paper, nothing has been said as to the cause or mode of origin of the diminished barometric pressure which, during the existence of the whirlwind, does actually exist in the central region. Often in writings on this subject the notion has been set forth that the diminished pressure is caused by the rapid gyratory motion of the whirling air; but, were we to accept that view, we would have still to ask, How does the remarkably rapid whirling motion receive its own origin? The reply must be that the view so offered is erroneous; and that, in general, a diminished pressure existing at some particular region is the cause rather than the effect of the rapid whirling motion; though in some respects indeed these two conditions can be regarded as being mutually cause and effects, each being essential to the maintenance of the other, while there are also some further promoting causes or conditions not as yet here mentioned.

It seems indubitably to be the truth that ordinarily for the genesis of a whirlwind the two chief promoting conditions are: firstly, a region of diminished barometric pressure, this diminution of pressure being, it may be presumed, due to rarefaction of the atmosphere over that region by heat, and sometimes, further, by its condition as to included watery vapour; and, secondly, a previously existing revolutionary motion, or differential horizontal motion, of the surrounding air, such revolutionary or differential motion being not necessarily of high velocity at any part.

The supposed accumulation of air rarefied by heat or otherwise, for producing the abatement of pressure may, the author supposes, in some cases extend upwards throughout the whole depth of the atmosphere; and in some cases may be in the form of a lower warm lamina which somehow may have been overflowed or covered by colder air above, through which, or into which, it will tend to ascend: or the lower lamina may in some cases be warmed in any of several ways, and so may get a tendency to rise up through the colder superincumbent atmosphere. On this part of the subject the author believes there is much scope for further researches and advancements both observational and considerational;—that is to say, by encouragement of a spirit towards accurate observation; and by collector and scrutiny of observed facts and appearances; and by careful theoretical consideration founded on observational results or suppositions.

To the author it seems probable that the great cyclones may have their region of rarefied air extending up quite to the top of the atmosphere; while often whirlwinds of smaller kinds, many of the little dust whirlwinds, for instance, which are frequent to be seen, may terminate, or gradually die out, at top in layer or bed of the atmosphere different in its conditions, both as to temperature and as to original motion, from the lower layer in which the whirlwind has been generated. In many such cases the upper air may probably be cooler than the lower air in which the whirlwind originates.

On the subject of the actions going on at the upper parts or upper ends of whirlwind cores in most cases, the author feels that he is able to offer at present little more than suggestions and speculative conjectures. In very many descriptions of the appearances presented by those whirlwinds with visible revolving cores, which are called waterspouts, it is told that the first appearance of the

<sup>1</sup> Paper by James Thomson, LL.D., D.Sc., Professor of Civil Engineering and Mechanics in the University of Glasgow, read in Section A, at the British Association meeting at Montreal, on Monday, September 1.

so-called waterspout consists in the rapid shooting down from a dense cloud of a black cloudy streak, seemingly tortuously revolving and swaying more or less sidewise. This is said rapidly to prolong itself downwards till it meets the surface of the sea; and the water of the sea is often imagined and described as rising up bodily, or as being drawn up, into the partial vacuum or central columnar place of diminished pressure. The frequently entertained notion—a notion which has even made its way into writings by men of science and of authority in meteorology—that the water of the sea is sucked up as a continuous liquid column in the centre of waterspout whirlwinds, is by some writers and thinkers repudiated as being only a popular fallacy, and it is affirmed that it is only the spray from the broken waves that is carried up. In this denial of the supposition of the water being sucked up as a continuous liquid column the author entirely agrees, and he agrees in the opinion that spray or spindrift from the sea set into violent commotion by the whirlwind is carried up in a central ascending columnar core of air.

On the other hand, the commonly-alleged inception of the visible waterspout phenomena, in a descending, tortuously-revolving, and laterally-bending or swaying cloudy spindle protruding from a cloud, the author supposes to be so well accredited by numerous testimonies that it must be seriously taken into account in the development of any true theory and explanation of the physical conditions and actions involved. He ventures to hazard a suggestion at present—perhaps a very crude and rash one. It is that the rising central core may perhaps, in virtue of its whirling motion and centrifugal tendency, afford admission for the cloudy stratum to penetrate down as an inner core within that revolving ascending core now itself become tubular. The cloudy stratum may be supposed not originally to have been endowed with the revolutionary motion or differential horizontal motion with which the lower stratum of thermally expanded air has been assumed to be originally endowed. The upper stratum of air from which the cloudy spindle core is here taken to protrude down into the tubular funnel is not to be supposed to be cold enough to tend to sink by mere gravity. Though it were warm enough to allow of its floating freely on the thermally expanded air below, it could still be sucked down into the centre of the revolving ascending core of the whirlwind.

Not to proceed further on this occasion with attempts towards explanation of the difficult subject of the actions at the upper ends of waterspout whirlwinds, the author wishes to have it understood that his main object in proceeding to prepare the present paper was to put forward clearly the theory he has given as to influx at the bottom in consequence of abatement of whirl in the lamina close to the sea-surface by frictional resistance there.

*Addendum.*—A few brief explanations and references will now be added to assist in the understanding of some of the principles assumed in what has been already said. It is to be clearly understood that, in a whirling fluid, even if the velocity of the whirling motion be very small at great distances from the axis, if the fluid be impelled inwards by forces directed towards the axis, the absolute velocity will greatly increase with diminution of distance from the axis. Thus in the *whirlpool of free mobility*, in which the particles are perfectly free to move outward or inward, the velocities of the particles are inversely proportional to the distances from the axis, the fluid being understood to be inviscid or frictionless. On this subject reference may be made to a paper by the author on "Whirling Fluids," published in the British Association volume for the Belfast Meeting, 1852. Again, as to the inward flow caused in a frictionally retarded bottom lamina of a whirlwind or whirlpool with vertical axis, by the frictional retardation from the bottom on which the whirling fluid rests, reference may be made to a paper by the author, "On the Grand Currents of Atmospheric Circulation" in the British Association Report, Dublin Meeting 1857, part ii. p. 38. On another case of the manifestation of the same principle, reference may be made to a paper by the author in the *Proceedings of the Royal Society* for May 1876, in respect to the "Flow of Water round Bends in Rivers, &c.," with reference to the effects of frictional resistance from the channel in the bends; and to another paper by him, on the same subject in the *Proceedings of the Institution of Mechanical Engineers* (August 1879, p. 456), where the inward flow is explained experimentally exhibited.

*Postscript of date August 16.*—Prof. James Thomson wishes now to offer in continuation of his paper on "Whirlwinds and Waterspouts," despatched two days ago for Montreal the follow-

ing postscript, which will extend the considerations there already put forward, and will tend to modify or amend some of them; but will leave unchanged the theory as to influx of the bottom lamina of the whirlwind towards the central region in consequence of the frictional resistance offered by the surface of the sea to the air whirling in close contiguity upon that surface.

He wishes to put forward the question as to whether it may not be possible, in some cases of whirlwinds, for the barometric pressure in the central or axial region to become abated through the combined influences of rarefaction by heat (increased, perhaps, by conditions as to included moisture) on the one hand, and the whirling motion on the other hand, very much beyond the abatement that could be due to heat, or heat and moisture, alone, without the whirling motion. He thinks it very likely that in great whirlwinds, including those which produce the remarkable phenomena called waterspouts, it may be impossible for the whirling action to be confined to the lower region of the atmosphere; but that, even if commenced there, it would speedily be propagated to the top. It seems also not unlikely, and in some trains of thought it comes to appear very probable, that the whirling fluid, ascending by its levity, would drive outwards from above it all other air endowed with less whirling energy, and would be continually clearing away upwards and outwards the less energetic axial core which enters from below, and any, if such there be, that has entered from above. He is unable at present to offer much in further elucidation (possibly it might only prove to be in further involvement) of this very difficult subject. He thinks the question should at least be kept open as to whether the whirling and scouring action may not go forward growing more and more intense, promoted always by energies from the thermal sources which have produced differences of temperature and moisture in different parts of the atmosphere, and that thus a much nearer approach to vacuum in the centre may be caused than would be due merely to the levity of the superincumbent air if not whirling.

He also wishes to suggest that the dark and often frightful cloud usually seen in the early stages of whirlwinds and waterspouts, and the dark columnar revolving core often seen apparently protruding downwards from the cloud, may be due to precipitation of moisture into the condition of fog or cloud, on account of abatement of pressure by ascension in level, and environment with whirling air, which by its centrifugal tendency acts in protecting the axial region from the pressure inwards of the surrounding atmosphere.

#### UNIVERSITY AND EDUCATIONAL INTELLIGENCE

CAMBRIDGE.—Dr. Besant and Mr. C. H. Prior are appointed Moderators, and Messrs. C. Graham and A. J. C. Allen Examiners, in the Mathematical Tripos for the year beginning May 1, 1885.

The following Natural Science Examiners have been appointed:—Physics: Prof. A. Schuster and Mr. W. N. Shaw; Chemistry: Messrs. A. Scott and M. Pattison Muir; Mineralogy: Prof. Lewis and Mr. H. P. Gurney; Geology: Messrs. R. D. Roberts and J. J. H. Teall; Botany: Messrs. F. Darwin and H. M. Ward; Zoology: Prof. A. M. Marshall and Mr. A. Sedgwick; Human Anatomy: Prof. A. Macalister and Mr. A. Hill; Physiology: Prof. Michael Foster and Mr. J. N. Langley.

St. John's College offers for competition in December next a large number of Open Scholarships, Exhibitions, and Sizarships. Natural Science is one of the subjects which, taken singly, may lead to election to any of these. The subjects are in general those of the Natural Sciences Tripos; but every candidate in Natural Science must show a competent knowledge of two at least of the following subjects:—Physics, Chemistry, and Biology, all in an elementary sense. A candidate, however, may be elected on the ground of special proficiency in any one of the subjects of examination. There will be both papers and practical work in all subjects. Further information may be obtained from the tutors.

Trinity College Examinations begin on December 11. Major and Minor Scholarships, Exhibitions, and Sizarships may be given for Natural Science. One Exhibition at least, of the value of 50<sup>s</sup>., will be given for Natural Science to a candidate not yet in residence at the University.

King's College offers an Exhibition of 60<sup>s</sup>. per annum for Natural Science: examination on December 11.

Emmanuel College holds its Entrance Scholarship Examination conjointly with Christ's and Sidney-Sussex Colleges. The subjects in Natural Science are Chemistry, Physics, Elementary Biology, and Geology and Mineralogy. In all branches of Natural Science there is a practical examination. The examinations will begin on January 6 next. A candidate for a Scholarship at one of the above Colleges may be elected to a Scholarship at either of the others in default of better qualified candidates.

Mr. Lea will lecture on Chemical Physiology this term at the New Museums.

Mr. Sedgwick has arranged for a repetition class in Elementary Biology in the Morphological Laboratory, to be superintended by Mr. Weldon.

OWENS COLLEGE, MANCHESTER.—At a recent meeting of the Council, on the recommendation of the Senate, made the following appointments to the three vacant Berkeley Fellowships:—In Chemistry, Dr. L. Claisen, formerly First Assistant in Organic Chemistry to Prof. Kekulé of Bonn. In Zoology, Dr. John Beard, of the University of Freiburg, and formerly of Owens College. In Philosophy, Mr. W. E. Johnson, B.A., of King's College, Cambridge. The Berkeley Fellowships are for the encouragement of original research, and the holders are required to reside in Manchester during term time.

### SCIENTIFIC SERIALS

*Bulletins de la Société d'Anthropologie de Paris*, tome vii, fasc. 2, 1884.—This number contains several more than usually interesting communications regarding French palæontological inquiry.—M. D'Acy's paper on the silex of the Chelles Station, which was begun in a previous number, shows that we must regard the Chelles deposits as belonging to two distinct formations: the old Quaternary, or true Chellean, containing remains of *Elephas antiquus* and *Rhinoceros merkiti*, and the later Quaternary, or mousterian period, represented as usual by *Elephas primigenius*.—Baron de Baye communicates the discovery in the Neolithic caverns at Petit Morin (Marne) of transversely cut arrow-heads similar to those found in large quantities in Denmark, but hitherto undetected in France. They were intermixed with numerous ordinarily shaped arrow-heads, fragments of Neolithic pottery, and roughly-cut flints, and deposited in a cavity on the summit of a hill, while a vertebral bone (apparently of a badger), which was found in a grotto at a distance of 250 m. from the deposit, still retained a portion of a similarly shaped arrow-head.—M. Gustave Chauvet announced the discovery, in a tumulus on the right bank of the Charente, of a curiously ornamented bronze chariot, similar to those found in Mecklenburg and in Scandinavia. The tumulus, which is situated near Charroux (Vienne), and locally known as "Le Gros-Guignon," contained a vaulted recess in which the body had rested, and on either side of which lay wheels with detached ornaments, as circles and spheres, and bronze and iron nails, together with two urns undoubtedly Gallic.—M. Nicaise reported the discovery of another chariot-bier in a tumulus at Septaulx (Marne), on which the body had been laid. In front of the right wheel lay the skeleton of a boar, between whose ribs a long knife was embedded. To this report the writer has added many interesting details in regard to several funeral chariots found in other parts of Marne, more especially in the Gallic cemetery of Varilles, where three skeletons (one adult and two children) had been interred in the same chariot. The weapons, horse-bits, bronze rings, &c., inclosed in these tumuli indicate their Gallic origin.—On the sepulchral grotto of Rousson, near Alais, by M. Charvet. This cave, which was opened in 1883, was found to contain a large number of skulls, mostly dolichocephalic, together with other human bones, and pins and beads of a metal regarded by French palæontologists as copper rather than bronze, and similar to that of various objects found in the Baume des Morts Cavern of Dürfort, first explored in 1869, and regarded as belonging to a mixed Celto-Ligurian race.—On a series of explorations at Plouhinec, by M. Gaillard. Four tumuli opened in March 1884 contained cinerary urns, four human skulls, and other bones, flint lance- and arrow-heads, and broken pottery.—A communication by M. Kerckhoffs concerning the lacustrine station lately brought to light near the alluvial beds, in which the notable Maestricht jaw was discovered in 1823. The recent explorations of this interesting site have been conducted by M. Ubaghs, who has found a well-preserved dolichocephalic cranium, together with the bones of *Bos primigenius*, the horse, stag, beaver, dog,

&c., with bone instruments, remains of coarse pottery, &c.—On human sacrifices and anthropophagy among the Vaudous or serpent-worshippers of Haiti, by M. Dehoux.—On the settlements of the Canadian Redskins, and the fluctuation in their numbers, by M. Petitot. The author considers that the solar and demon worship, and the chief social institutions of the Sioux, Hurons, and other North American tribes indicate their affinity with the Dravidian races of India.—The report of a discussion raised by M. Beaugerard on the correctness of his views regarding the Dardous, which had been called in question by M. de Ujfalvy.—On the Cachmiris and Pandits, by M. de Ujfalvy. The former he regards as a mixed Mongol and Aryan race, while in the latter he believes we have the representatives of a primitive North-West Indian Aryan type.—On the pretended Eastern origin of the Algonquins, by M. Petitot; and on the diffusion of analogous myths in different lands, by M. Luys.—On dynamometric errors, by Dr. Manouvrier, having special reference to the inexactness of instruments, and the discrepancies between the modes of gradation observed by different instrument-makers.—On the ethnographic researches of M. Quesde in the Antilles, by M. Hamy. The presence of cut flints, although there are no indications of any siliceous rock-formations, points to primitive commercial relations with the mainland.—On the methods of measuring the circumference of the head, by M. le Bon.—A new classification of the pelvis considered from an obstetric point of view, and with special reference to racial distinctions, by Dr. Verrier.—On the traditions and tribal divisions of the Somalis, by M. Bardey. Their legends include one in which Abel is represented as the black and evil brother, while Kahlil is white-skinned and good, while the people profess to derive their descent from two men miraculously saved with their wives from an inundation which engulfed all the inhabitants of the lands near the Mount Taizz, sixty miles east of Mocha, on the summit of which they remained till the waters subsided.

*Bull. tin de l'Académie Royale de Belgique*, July 5.—Monograph on the central nervous system of adult Ascidians, and its relations to that of the Urodele larvæ (four plates), by MM. Ed. Van Beneden and Ch. Julin.—Note on the calculation of averages; application of a new principle of probabilities, by E. Catalan.—Remarks on the ventral disk of the sea-snail, *Liparis barbatus* (one plate), by Maurice Stuckens.—On the respiration of bats during the period of hibernation, by E. Delsaux.—Anatomy of the cephalic kidney of the larva of *Polygordius*; a contribution to the history of the excreting apparatus of worms, by Julien Fraipont.—On the central and surface nervous systems of the Archannelids (*Protodrilus*, *Polygordius*); a contribution to the history of the origin of the nervous system in these worms, by Julien Fraipont.—On a theorem in mechanics applicable to systems whose movement is periodical, by E. Ronkar.

August 2.—Note on two remarkable experiments in capillary attraction, by G. van der Mensbrugge.—On the theory of elliptical functions, by P. Mansion.—On the remainder in Taylor's formula, and on the binomial theory, by P. Mansion.—Chemical analysis of a rich phosphate recently discovered in the neighbourhood of Havré near Mons, by C. Blas.—On the conductivity of gaseous bodies for heat, by E. Ronkar.—On the theoretic relations between the coefficients of expansion, the internal heat of vaporisation, and the specific heats of bodies in the liquid and gaseous states, by P. de Heen.—Description of a new apparatus for determining the coefficient of diffusion of salts in solution, and the variations experienced by this quantity according to the temperature, by P. de Heen.—On the generation of certain surfaces by means of quadrilinear groups, by C. Le Page.—Researches on the production of cyanhydric acid in the vegetable kingdom, by A. Jorissen.—Historic note on Stephen Dushan, Emperor of Servia, and the Balkan Peninsula in the fourteenth century, by Emile de Borchgrave.—Discourse pronounced at the obsequies of M. Alexandre Pinchart, by M. Silngeneyer.

### SOCIETIES AND ACADEMIES

#### LONDON

**Mineralogical Society**, October 21.—Anniversary meeting.—The Rev. Prof. Bonney, F.R.S., President, in the chair.—The Hon. Sec., Mr. R. H. Scott, read the Report of the Council.—The scrutineers reported that the following were elected Officers and Council:—President: Rev. Prof. T. G. Bonney, D.Sc., LL.D., F.R.S., F.S.A., Pres.G.S.; Vice-Presidents: Rev. S. Haughton, M.D., F.R.S., W. H. Hudde-

ston, J.P., F.R.S.; Council: T. W. Danby, M.A., F.G.S., J. J. Dobbie, D.Sc., L. Fletcher, M.A., Prof. W. J. Lewis, M.A.; Treasurer: R. P. Greg, F.G.S., &c.; General Secretary: H. Scott, M.A., F.R.S.; Foreign Secretary: T. Davies, F.G.S.—The President delivered an address, in which he commended the Society on the satisfactory character of the Report presented by the Council. This mentioned three topics, all of congratulation: First, it announced that the fusion of the Society with the Crystallogical, thanks to the good offices of the Honorary Secretary, had been accomplished. Next, it announced that the finances of the Society, which three years ago were in a condition far from satisfactory, were now restored to a healthy tone. Lastly, it spoke of the great success which had attended the meeting held in Edinburgh last June. He trusted that in future one of the meetings of the Society would always be held in Scotland. He then proceeded to criticise two defects which in his opinion existed in systematic mineralogy as set forth by many authors. To some extent these were questions of nomenclature, but in his opinion they involved questions of principle. The one was the extreme proneness of mineralogists to give distinctive names to slight and often very ill-defined varieties of existing species, thus leading students to mental habits of dissociation rather than of correlation. The other at first sight appeared exactly the converse of this, namely, the laxity with which certain substances were classed as minerals. For instance, obsidian, pitchstone, &c., were often placed in text-books under the head of orthoclase feldspar, but they could not be brought under any received definition of a mineral. He pointed out how, in consequence as he believed, of the defective habits of reasoning thus engendered, the contributions to petrology, even of skilled mineralogists, were sometimes of little value.—Mr. R. H. Solly read a paper on five specimens of lilac calcite from Tankerville Mine, Natal.—Mr. Semmons read some further notes on "Euargite."—M. Guyot de Grandmaison exhibited a very fine crystal of "Parasite."—Mr. Rudler and Mr. T. Davies also exhibited several interesting minerals.

## SYDNEY

Linnean Society of New South Wales, August 27.—C. S. Wilkinson, F.G.S., F.L.S., President, in the chair.—Dr. Otto Finsch was introduced as a visitor.—The President announced that, at the last meeting of the Council, F. Jeffrey Bell, M.A., Professor of Comparative Anatomy at King's College, London, had been elected a Corresponding Member of the Society.—The following papers were read:—New fishes in the Queensland Museum, No. IV., by Charles W. De Vis, M.A. The families Gobiidae and Blenniidae form the subject of this paper; thirty-one new species are described.—Notes on the eyes of deep-sea fishes, by Dr. von Lendenfeld. In this paper the author combats the views expressed by Mr. Archer of New Zealand, in opposition to his (Dr. Lendenfeld's) theory as regards the eyes of *Lepidodus caudatus*.—The insects of the Maclay coast, by William Maclay, F.L.S. The "Maclay Coast," so named after the distinguished traveller Baron N. de Mikluho-Maclay, who resided there for nearly three years, is a portion of Astrolabe Bay, on the North Coast of New Guinea, and the insects collected there, and now enumerated, are of interest as being the only ones ever received from that portion of the island. The collection is very small, and the species have been for the most part previously described from Dorey and New Ireland.—Notes on the zoology of the Maclay Coast, New Guinea: (i.) on a new sub-genus of *Perameledae*, by N. de Mikluho-Maclay. Baron Maclay gives to the bandicoot here described the name of *Brachymedus garagassi*. The sub-genus is characterised by having four upper incisors instead of five (in which character it resembles *Perameles dorreanus*, Quoy and Gaimard, and *P. cockerelli*, Ramsay), in having very short limbs and in having the hair on the back very bristly. A stuffed specimen was exhibited, which Dr. Otto Finsch pronounced to be distinct from his New Britain species.—Descriptions of Australian Micro-lepidoptera, No. XI., by E. Meyrick, B.A. Mr. Meyrick continues the *Ecophoridae*, describing in detail over 100 species, bringing the number of that family up to nearly 400.—Critical list of Mollusca from the north-west coast of Australia, by John Brazier, C.M.Z.S., &c. Fifty species are here enumerated, with the geographical range and synonymy of each correctly defined.—Synonymy of some New Guinea land shells, by John Brazier, C.M.Z.S., &c. Mr. Brazier accompanied the reading of this paper with the exhibition of the following species: *Helicidae*:—*Helix broadbenti*, Braz.; *H. (Obba) goldiei*, Braz.; *(Geotrochus) seno*, Braz.; *H. (Geotrochus) tapperonii*, Smith;

*H. (Geotrochus) tayloriana*, Ad. and Reeve; *H. (Sphaerospina) gerrardi*, E. A. Smith; *H. (Planispina) corniculum*, Hombr. and Jacq.; *Nanina (Xesta) vitrina*, Linn.—The time of the Glacial period in New Zealand, by R. von Lendenfeld, Ph.D. The results of the author's survey in the New Zealand Alps, partly corroborating and partly extending the results of Dr. von Haast's surveys, showed that the present glaciers are as large and extend down as far as those in Norway, where the mean annual temperature is 3° C., whilst in New Zealand it is 11° C. The greater expanse of water in the southern hemisphere and the consequently greater amount of humidity in the air, and more copious rain and snowfall are considered to be the cause of this. The sounds in the south-west coast are similar to the fjords in Norway, and the alluvial deposits at their upper ends are small. Scooped out originally by flowing water, these sounds remained unchanged during the period of subsidence of the land, and were not filled up with debris, because large glaciers occupied them during that time. As soon as these glaciers disappeared, the formation of the alluvial deposits commenced, and from the fact that the latter are small and increasing rapidly in size from year to year, the author considers that the Glacial period in New Zealand must have been very recent.—List of papers and works relating to the mammalian orders Marsupialia and Monotremata, by J. J. Fletcher, M.A., B.Sc. The aim of this catalogue, which contains the titles and references of several hundred papers, &c., is to do for the student of these two interesting and peculiarly Australian orders of the Mammalia what Etheridge and Jack's Catalogue has done for the student of Australian geology. It includes all papers dealing with the anatomy of these groups, all descriptions of new species since the publication of Gould's work, and a few papers on palaeontology, omitted from Etheridge and Jack's Catalogue, together with a few published since that appeared. Mr. Fletcher exhibited a number of the rarer papers enumerated in the list.—On two new birds from the Austro-Malayan region, by E. P. Ramsay, F.R.S.E. The species here described are: (1) *Pitta finschii*, sp. nov., allied to *Pitta macklotii*, but distinct in having no red nape patch, and the whole of the upper surface except the head blue, instead of green. (2) *Halcyon albonotata*, sp. nov. This species comes under the sub-genus *Cyanalcyon*; it is allied to *Halcyon maclayi* and *H. diope*, but differs from all in having the whole of the back and upper tail-coverts white.

## PARIS

Academy of Sciences, October 20.—M. Rolland, President, in the chair.—Note on the conditions of the existence of equal roots in Hamilton's equation of the second degree, and on a general method of resolving a unilateral equation of any degree in matrices of any order, by Prof. Sylvester.—On the alkaline hydrates, third memoir: hydrates of potassa and soda, by M. E. J. Maumené.—Note on the effects of tar-wash on vines attacked by Phylloxera, by M. Balbiani. A decisive experiment recently made by the author on a young plantation near Montpellier showed the possibility of utterly destroying the winter eggs deposited in any given vineyard by the application of a coal-tar wash. But all the plants subjected to this treatment arrived at maturity a fortnight or three weeks later than any others. This result was attributed to the obstacle opposed to the evaporation by the coating thus formed round the stem of the plant.—Occultation of stars by the moon observed at Toulouse during the recent lunar eclipse, by M. Baillaud.—Observations of the same eclipse made at the Observatory of Bordeaux, by MM. Doublet, Flamme, and Courty. These observations, made under rather favourable atmospheric conditions with the 8-inch and 14-inch equatorials, were directed chiefly to some of the stars indicated in M. Struve's list. It was ascertained that none of the stars disappeared at the exact moment of its occultation, almost implying that the edge of the lunar disk is transparent.—Observations of Wolf's comet (1884), made with the meridian circle of the Observatory of Bordeaux, by M. Courty. The brightness of the comet appears to have slightly increased since the first observations, although the nucleus still remains comparable to a star of the ninth magnitude.—Observations of the new planet 244, made at the Observatory of Algiers (0.50 m. telescope), by M. Rambaud.—Observations of the late total eclipse of the moon at Orgères (Eure-et-Loir), M. Edm. Lescaubault.—Note on the determination of the orbits of heavenly bodies by three observations, by M. R. Radau.—Observations made on the intensity of terrestrial magnetism in European Russia, by Gen. A. de Tillo.—Note on the elementary force of solar induction, whose periodical duration

is a mean day, by M. Quet.—On the disruptive discharges of Holtz's electric machine, by M. l'Abbé Maze.—On the trifluoride of phosphorus, by M. H. Moissan.—On the results obtained from the application of potash manures to certain hitherto unreclaimed lands in Brittany, by M. G. Lechartier.—Fresh comparative experiments with the rabbit and guinea-pig inoculated with the virus of human scrofula and tuberculosis, by M. S. Arloing.—Note on the character and constitution of the light fleecy clouds present in the upper regions of the terrestrial atmosphere, by M. A. Badoureau. In these regions the author assumes that the temperature falls to absolute zero, and although the pressure is also reduced to zero, it seems probable that the carbonic acid, nitrogen, and oxygen are here successively condensed into clouds analogous to those formed lower down by vapour. To the clouds formed by these elements might be attributed the phenomenal solar halos recently described by M. Cornu.

## BERLIN

**Meteorological Society, October 7.**—Dr. Hellmann gave a short report of the proceedings of the annual meeting of the German Meteorological Society, which held its sitting at Magdeburg from September 18 to 22, simultaneously with that of the German Natural Science Association. Communications on the scientific inquiries and observations having been delivered in the Meteorological Section of the Natural Science Association, it was only matters connected with organisation which occupied the attention of the Meteorological Society, and the most important of the conclusions arrived at by them formed the substance of Dr. Hellmann's address.—Prof. Börnstein spoke on rain measurement, and, after a concise historical review of the more important observations of earlier times, on the dependence of the readings of rain-gauges on their position and exposure, and on the attempts made to explain that fact, he reported observations of his own which he had made for the purpose of testing the influence which, according to assertions by many savants, the wind exercised on the readings of rain-gauges. Mr. Nipher, as was known, had in 1878 proposed, as a counteractive to the influence of the wind, to surround the collecting cylinder of the rain-gauges with a protective funnel. Beside a Nipher rain-gauge of this construction Prof. Börnstein had set another rain-gauge which was surrounded with a reversed funnel, and must necessarily show the influence of the wind in increased measure. By a comparison of the measurements of these two gauges from January to July of this year, he ascertained that the latter regularly collected less rain than the former. The difference was greatest in the case of snow falling, less in the case of a drizzling rain, still less during an ordinary shower of rain, and least of all with a heavy downpour. On comparing the readings of the two rain-gauges, according to the strength of the winds prevailing at the times of the different rainfalls, it appeared that, when the strength of the wind was 0, the differences were least of all; greater differences appeared when the strength of the wind was 1, still greater when its strength was 2, and the greatest when it rose to 3. Winds of greater violence than 3 came too seldom to allow of correct determinations regarding their influence on the rain-gauges.—In connection with this address Dr. Hellmann stated that at the Prussian stations it was sought to abate the influence of the wind by placing the rain-gauges one metre above the ground, and surrounding them with a hedge one metre and a half in height and at a distance of two metres. He then explained several models of rain-gauges.—Prof. Förster reported several series of experiments on the measurement of heat carried out by the Normal Standard Commission under his direction. As a result of these investigations it appeared that the possible errors of even the best mercurial thermometers were very considerable. In the first place, the successive expansion of the glass, if repeatedly heated up to 100° C., might be very great, to the extent even of displacing the fixed points by several degrees. The amount of this change was dependent on the chemical composition of the glass. According to Herr Wiebe's measurements those were the worst glasses in this respect which were markedly rich in potassium and sodium, especially those containing equal quantities of these substances. Happily glass factories were beginning to take account of this circumstance in their supply of glasses for instruments of precision. The expansion coefficients of the glass, and the relation of the glass to the quicksilver expansion, was another source of error, producing important deviations from the readings of the gas thermometer. In the latter case, likewise, the chemical composition of the glass played a part which would require

to be more particularly determined, and it was to be hoped that the investigations now in progress would soon settle the corrections imposed by that factor in the case. The gas thermometer was itself not absolutely trustworthy, as had been shown by the most recent experiments, which had demonstrated that all gases employed were more or less absorbed by the glass, and the more so the longer the gas remained in contact with the walls of the thermometer. That this absorption prejudicially affected the readings of the thermometer, if only to hundredths of a degree, had been already proved. Continued experiments with nitrogen and carbonic acid thermometers in vessels of glass and platinum-iridium would bring to light the corrections to be applied; these in conjunction with the other corrections would alone render the thermometer a true scientific instrument.—Dr. Kayser has photographed flashes of lightning, and obtained the ramified lightning-pictures now universally known. One flash, however, which he showed to the Society, was distinguished by the fact that it presented four unramified, irregularly undulatory lines running in exact parallels from top to bottom. These four lightning-lines must, by reason of their parallelism, have arisen simultaneously or immediately after one another in order that their discharges should have pursued the same lightning-track. The first flash was further distinguished by a series of light-layers attached to one side of it. Dr. Kayser was of opinion that a double discharge was here pictured, going and coming, the course of which had been displaced by a strong wind (thirty metres per second). The amount of the displacement could be approximately calculated, and so the time between the first and second discharge might be estimated to within some hundredths of a second.

## CONTENTS

	PAGE
The Cholera Epidemic of 1884 . . . . .	62c
Dynamo-Electric Machinery . . . . .	63c
Our Book Shelf:—	
Puckle's "Elementary Treatise on Conic Sections and Algebraic Geometry" . . . . .	631
Letters to the Editor:—	
The Cretaceous Flora of North America.—Sir J. Wm. Dawson; J. S. G. . . . .	631
Palaeolithic Implements from Cambridge.—M. C. Hughes . . . . .	632
The Recent Lunar Eclipse.—H. Dennis Taylor. (Illustrated) . . . . .	632
The Red Light round the Sun.—The Sun Blue or Green at Setting.—G. M. H. . . . .	633
The Volcanic (Dust?) Phenomena.—T. W. Backhouse . . . . .	633
After-Glow.—Major Robert D. Gibney, R.A. . . . .	634
The Distribution of Scientific Works Published by the British Government.—Prof. V. Ball, F.R.S. . . . .	634
Insect Pests in Ceylon.—W. L. Distant . . . . .	634
The Pentacrinoid Stage of <i>Antedon roseus</i> .—Prof. W. A. Herdman . . . . .	634
Curious Phenomenon.—J. T. Bottomley . . . . .	634
Simson's Line.—The Writer of the Notice . . . . .	634
A Rainbow after Sunset.—James Graves . . . . .	634
Tropical African Mountain Flora. By Sir J. D. Hooker, F.R.S. . . . .	634
An Electro-Dynamometer with Extremely Light Suspended Coil. By Dr. W. H. Stone . . . . .	634
Library Catalogues. By W. Odell . . . . .	634
The "Identiscope." By Francis Galton, F.R.S. . . . .	634
On the Algal Flora of the Arctic Seas. By Veit Brecher Wittrock . . . . .	634
Notes . . . . .	64
Our Astronomical Column:—	
Variable Stars . . . . .	64
Wolf's Comet . . . . .	64
The Solar Eclipse of March 16, 1885 . . . . .	64
Geographical Notes . . . . .	64
Notes on Nitrification. By R. Warington . . . . .	64
Researches on the Origin and Life-Histories of the Least and Lowest Living Things, II. By Rev. W. H. Dallinger, LL.D., F.R.S. . . . .	64
Whirlwinds and Waterpots. By Prof. James Thomson, LL.D., D.Sc. . . . .	64
University and Educational Intelligence . . . . .	64
Scientific Serials . . . . .	65
Societies and Academies . . . . .	65





























