

始

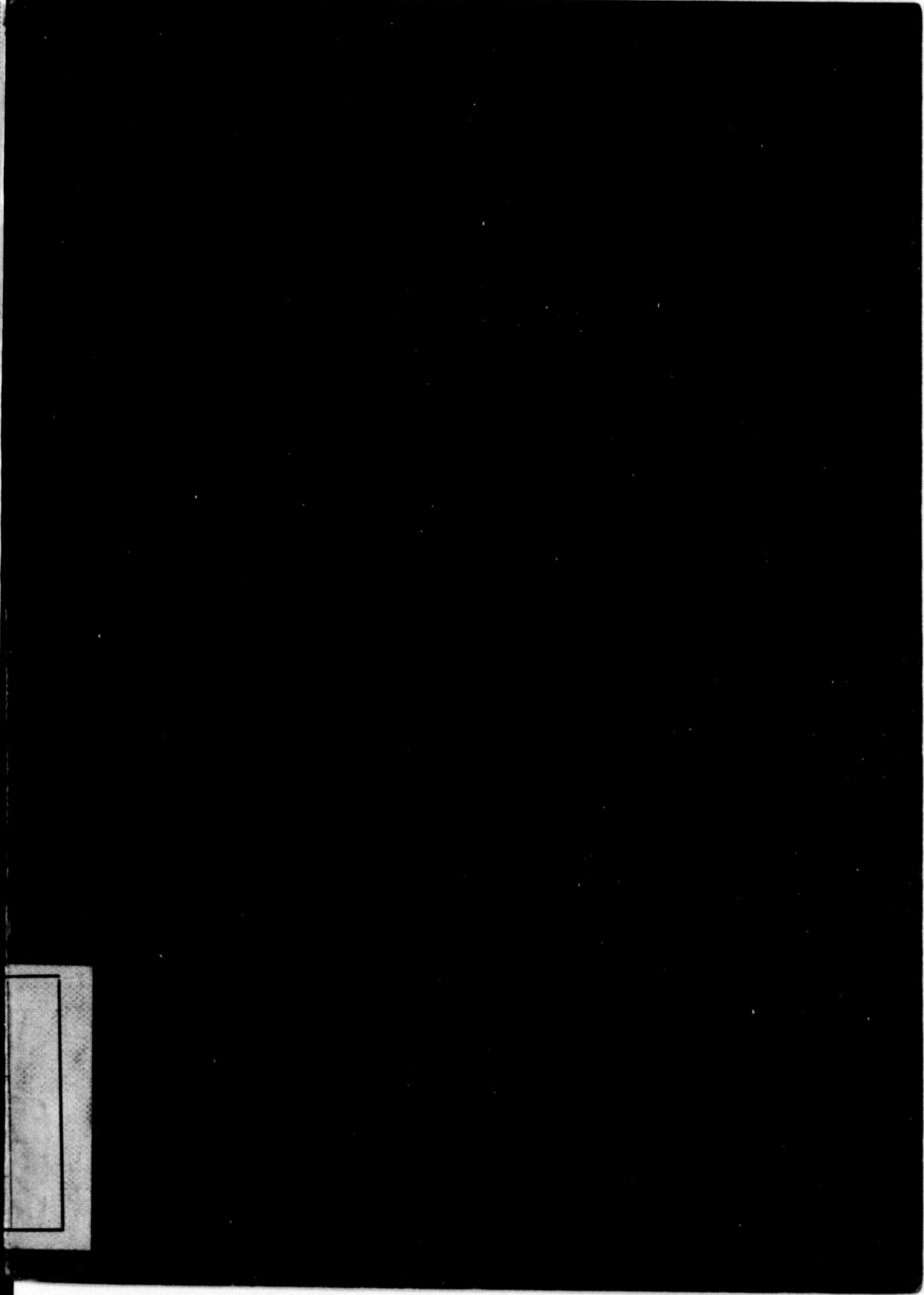
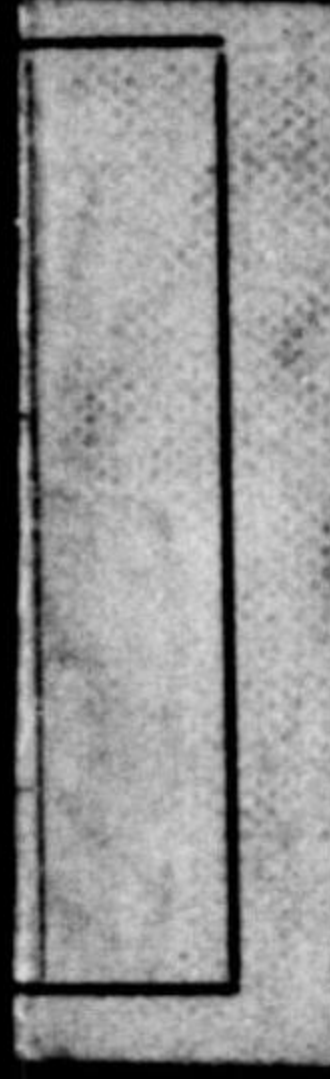

航 用 測 器 學
附 圖

東京高等師範學校教授

井 原 實 著

930
166

558.2
I.98
2

航 用 測 器 學
附 圖

東京高等商船學校教授

井 關 貢 著

改 訂 新 版



發 行 所

海 文 堂 出 版 部

第一圖(甲)

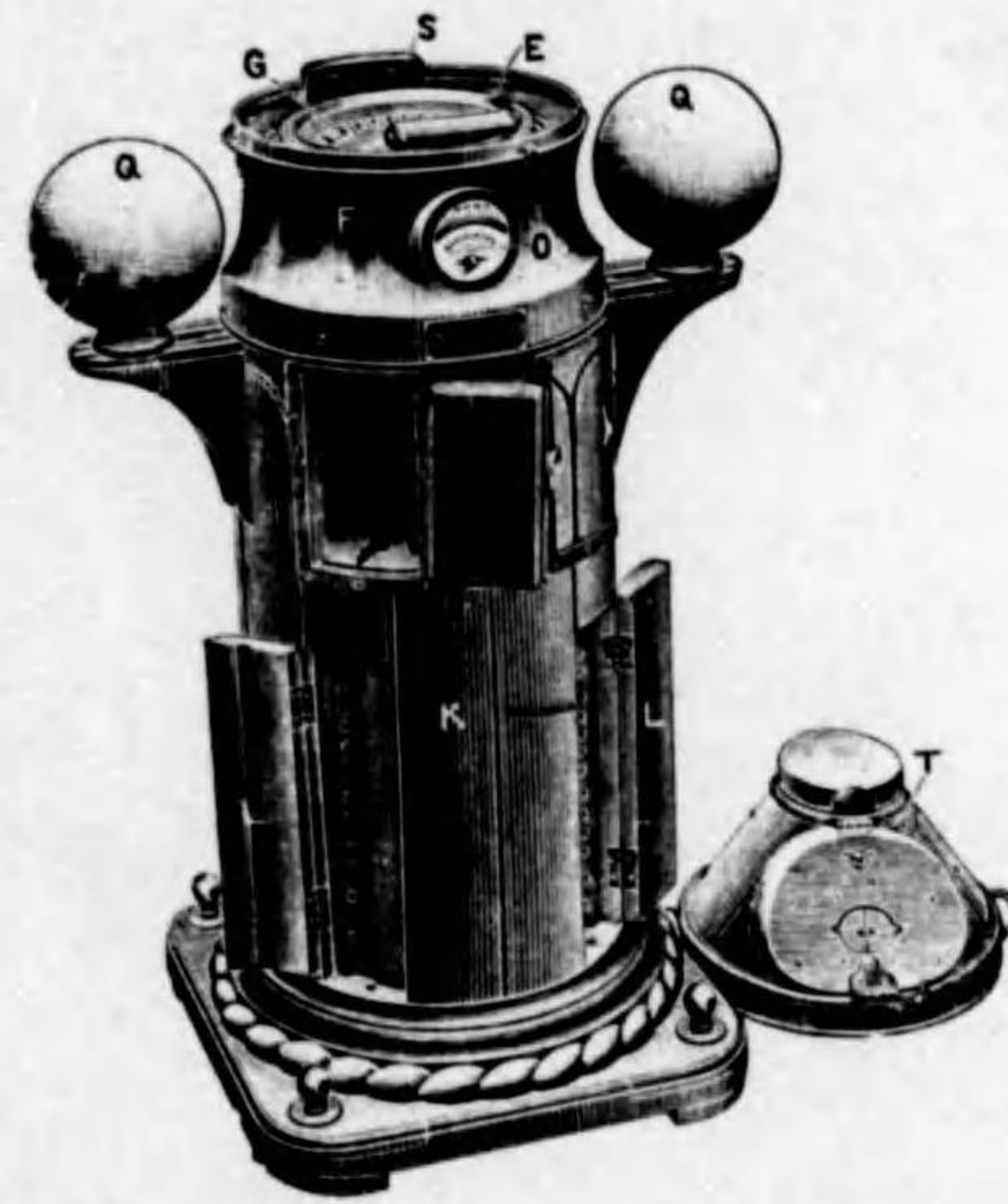

第一圖(乙)

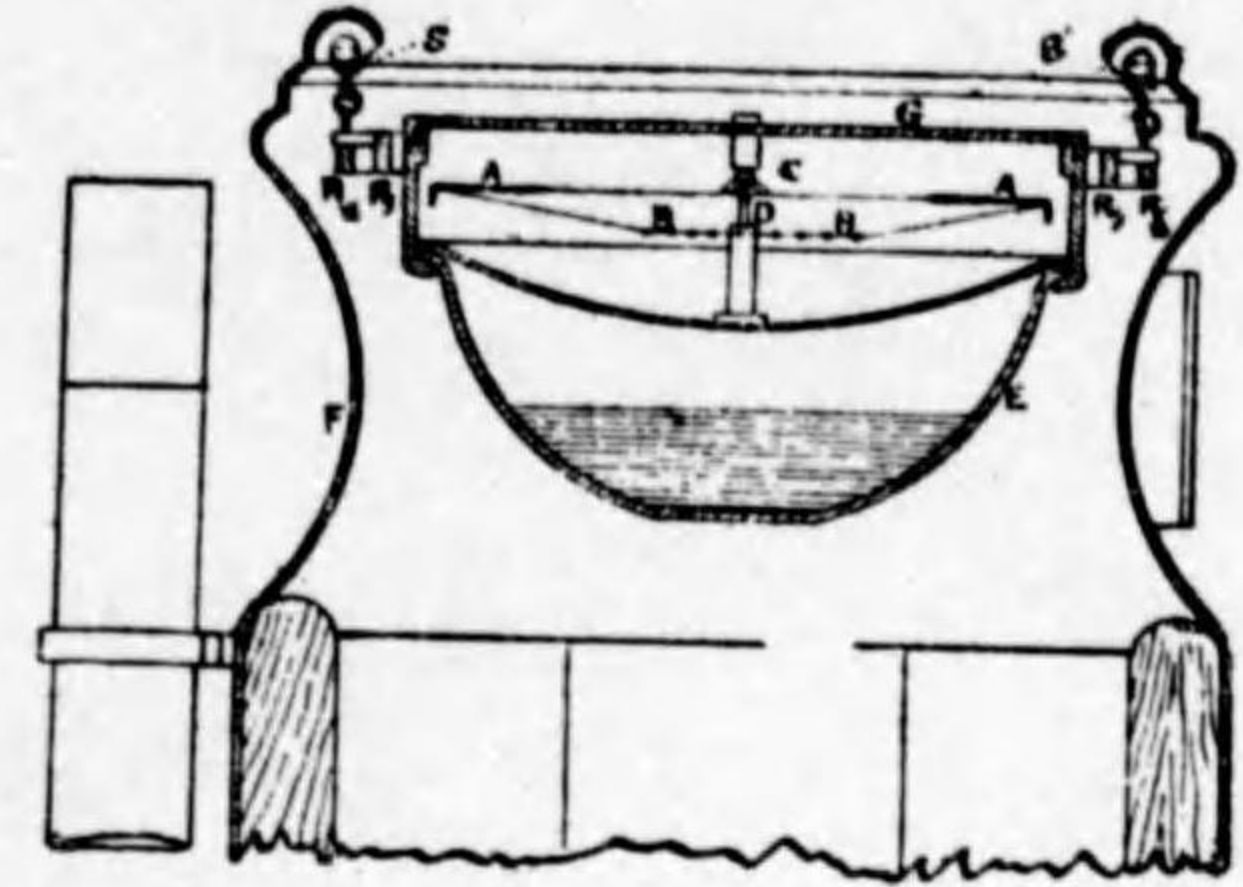

第一圖(丙)



第一圖(丁)



第二圖(甲)



第二圖(乙)



第二圖(丙)

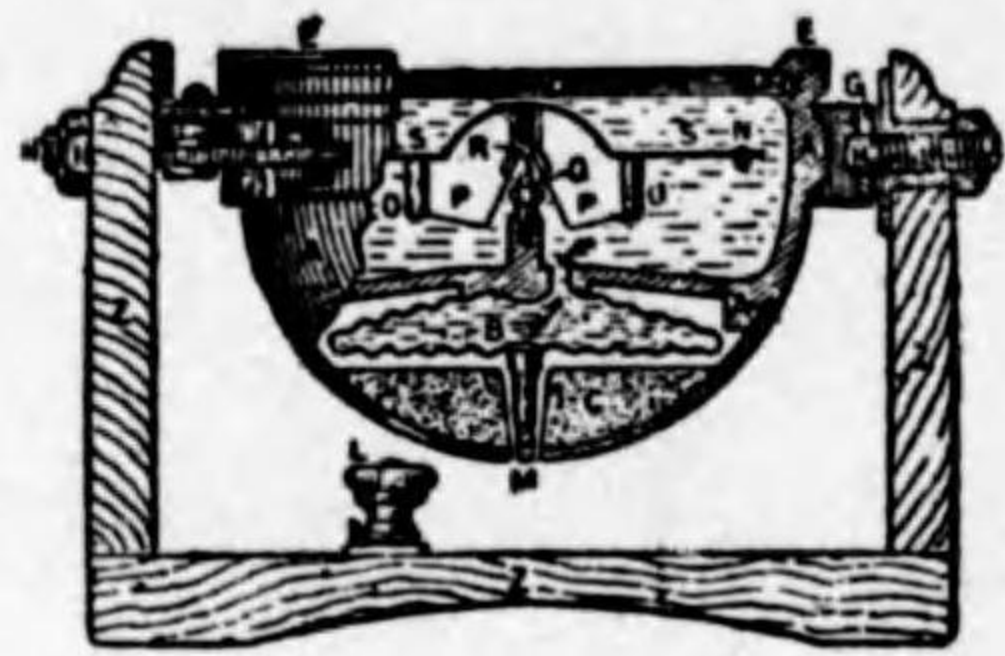

第三圖(甲)

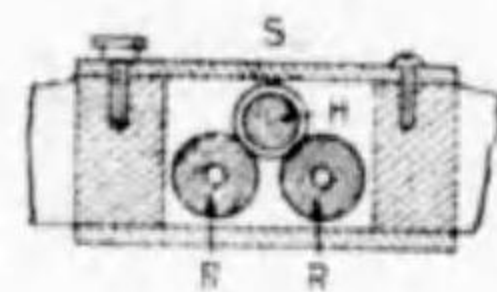
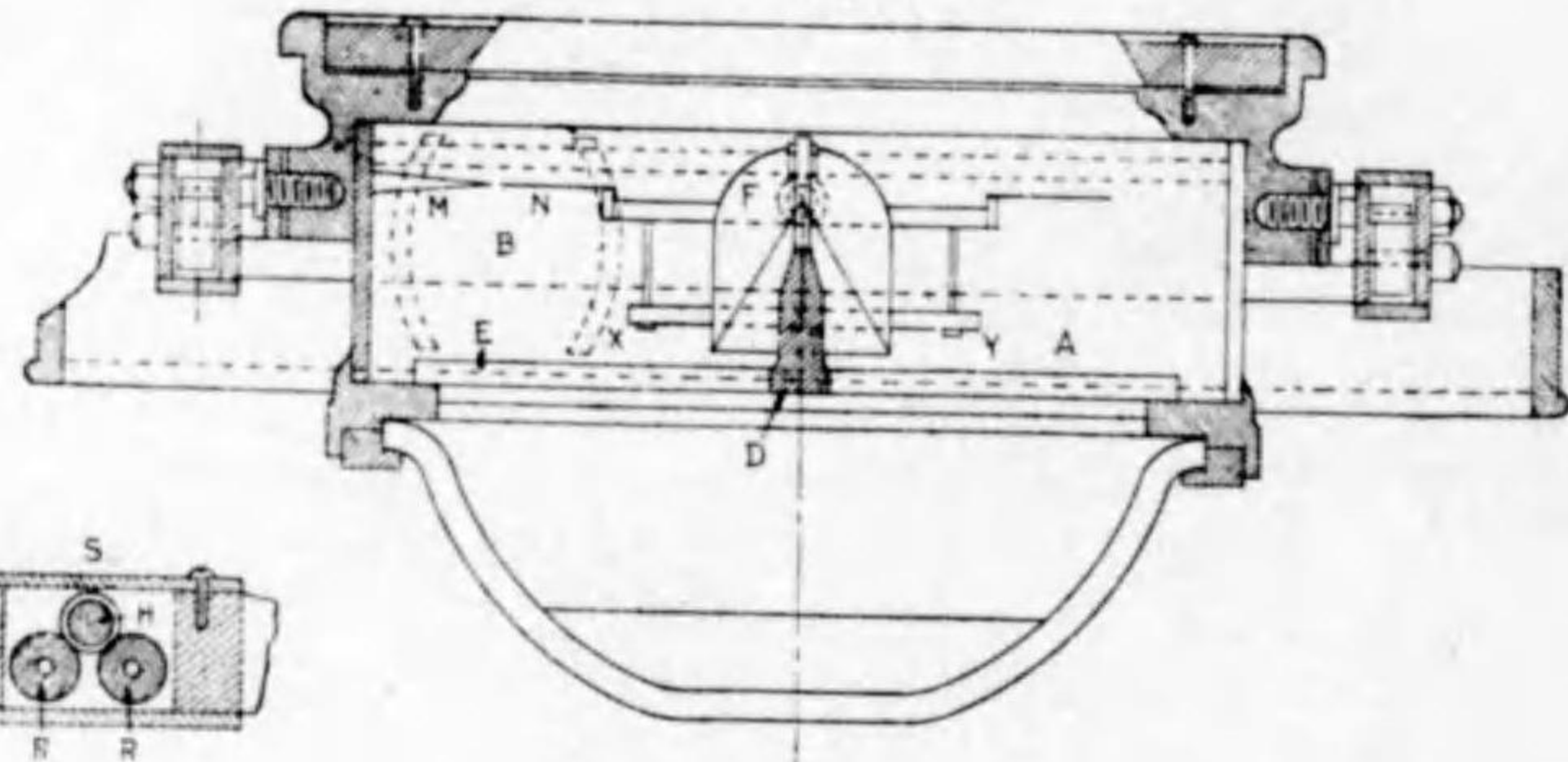

第三圖(乙)



第三圖(丙)

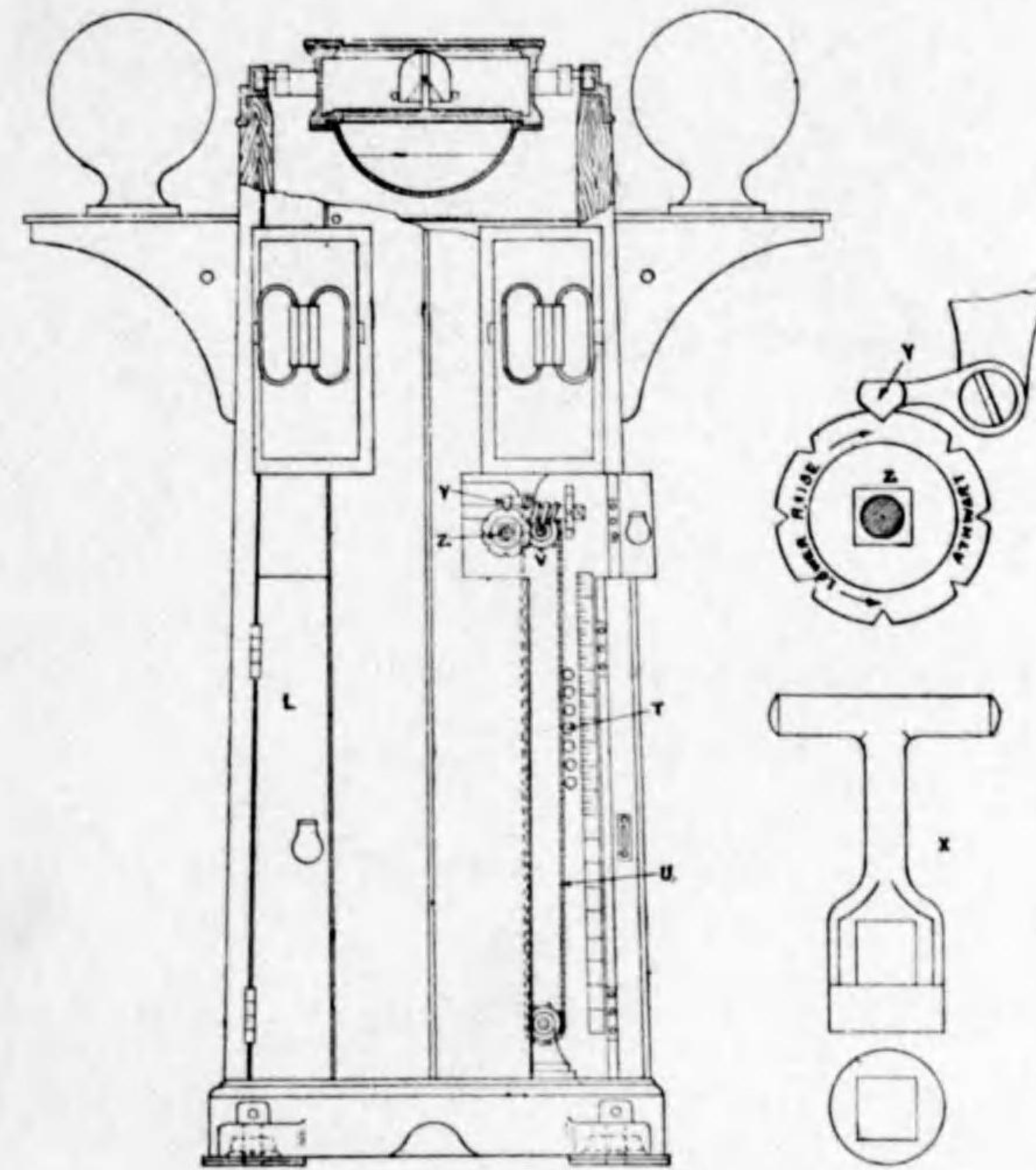

第三圖(丁)

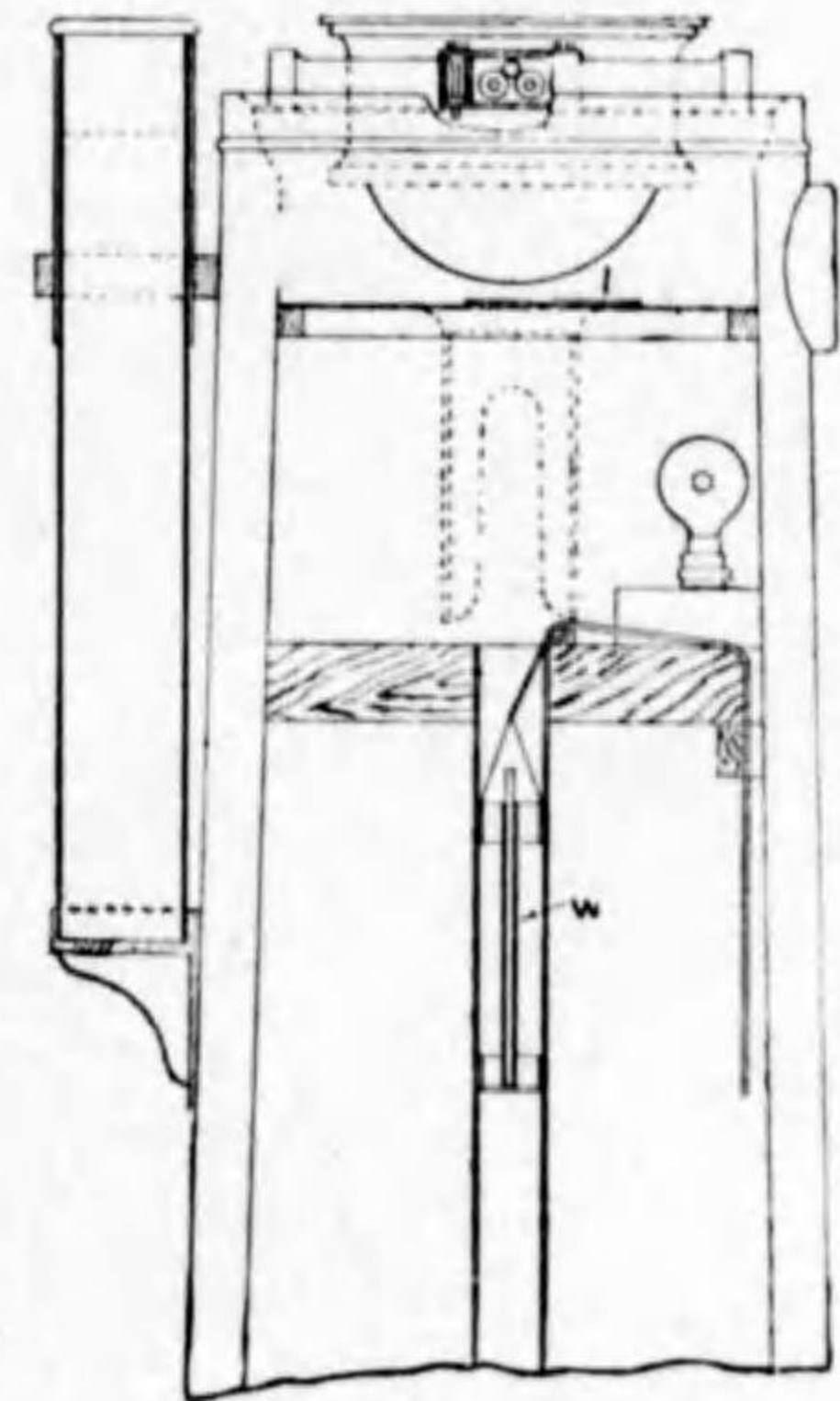

第三圖(戊)

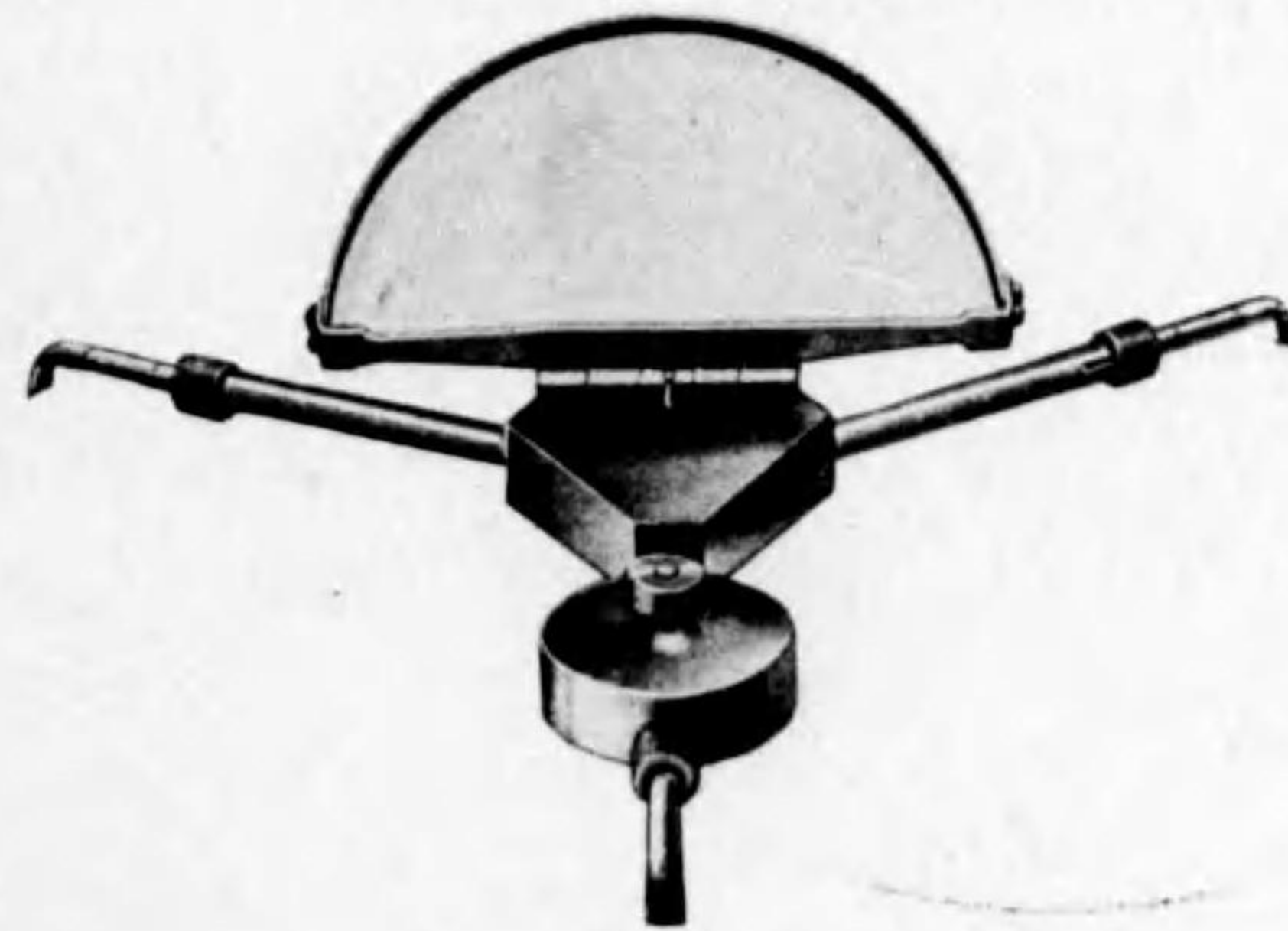

第四圖

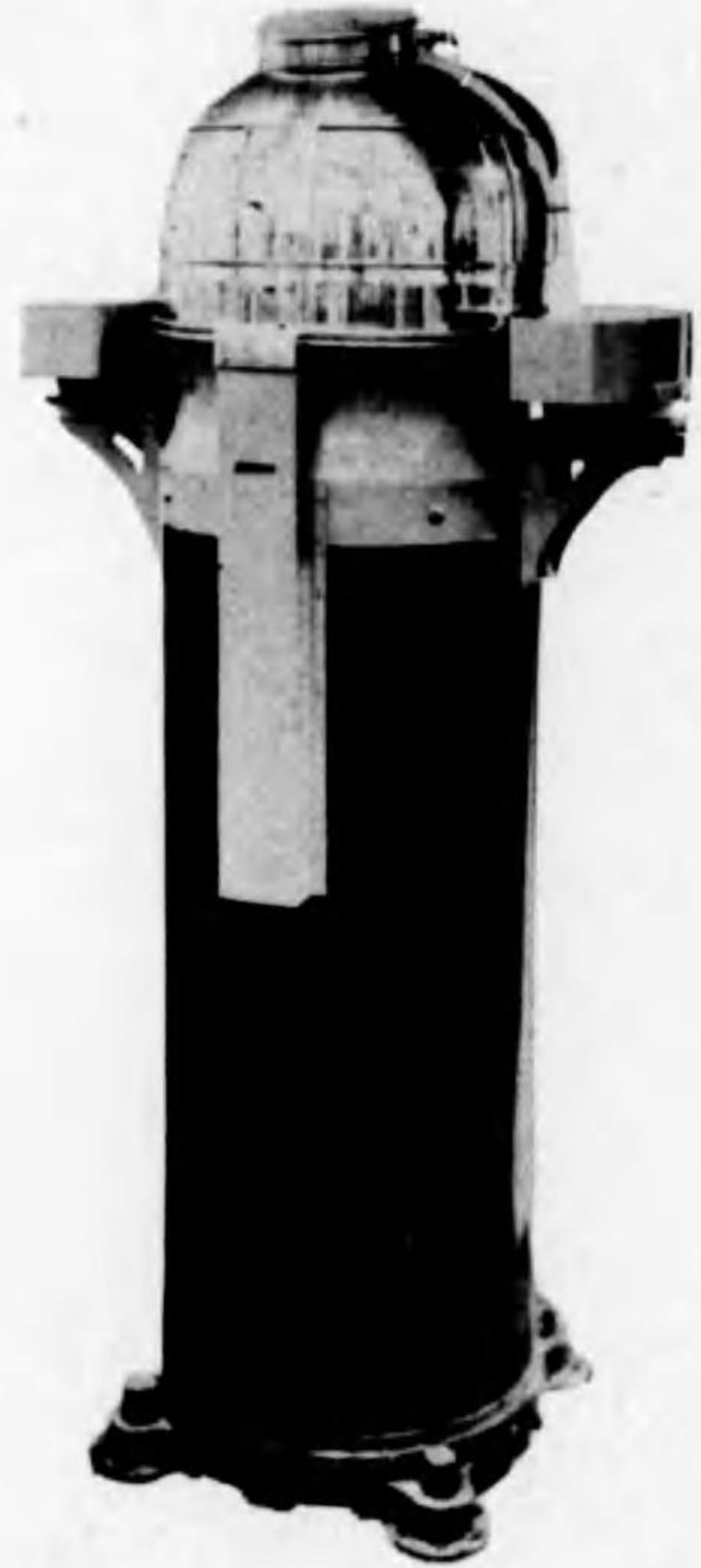

第五圖(甲)

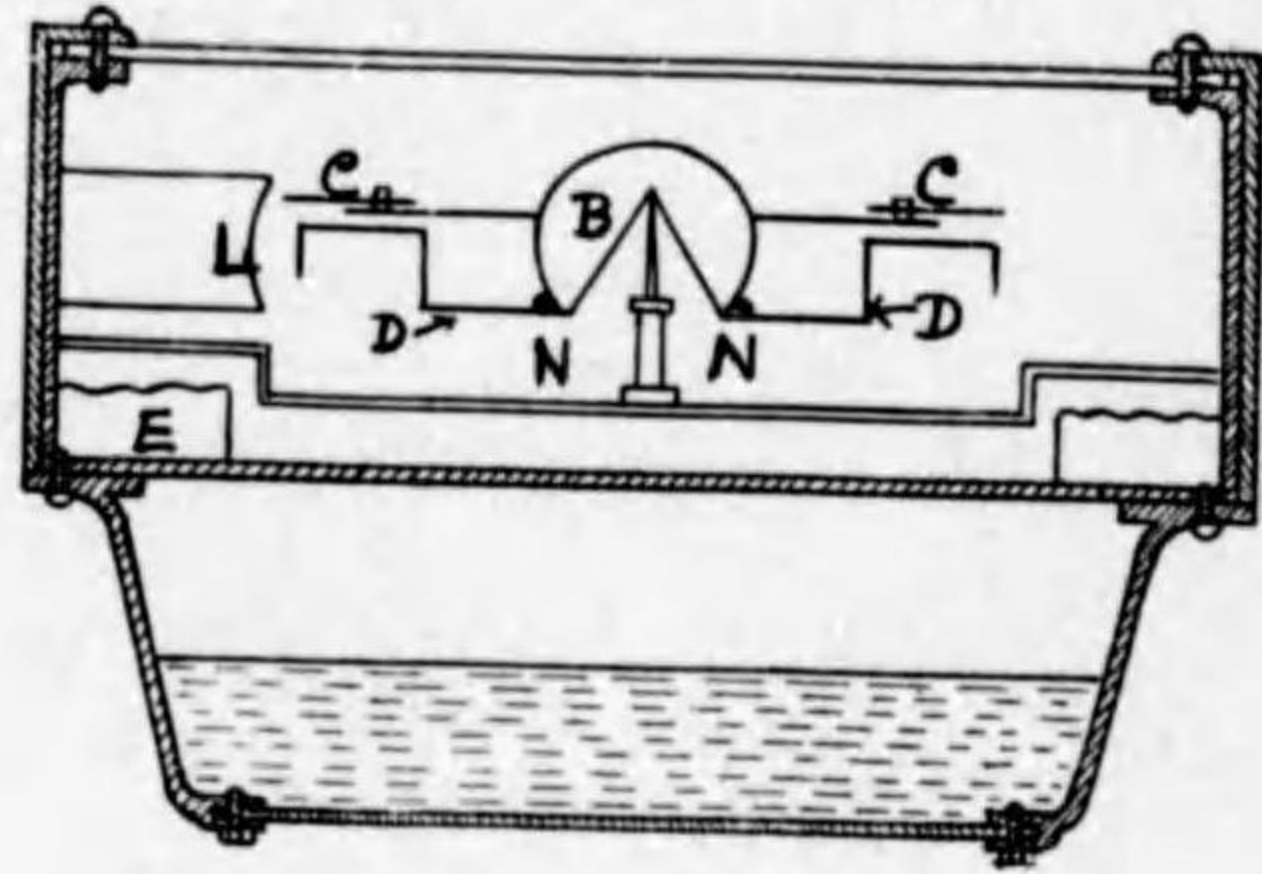

第五圖(乙)



第五圖(丙)

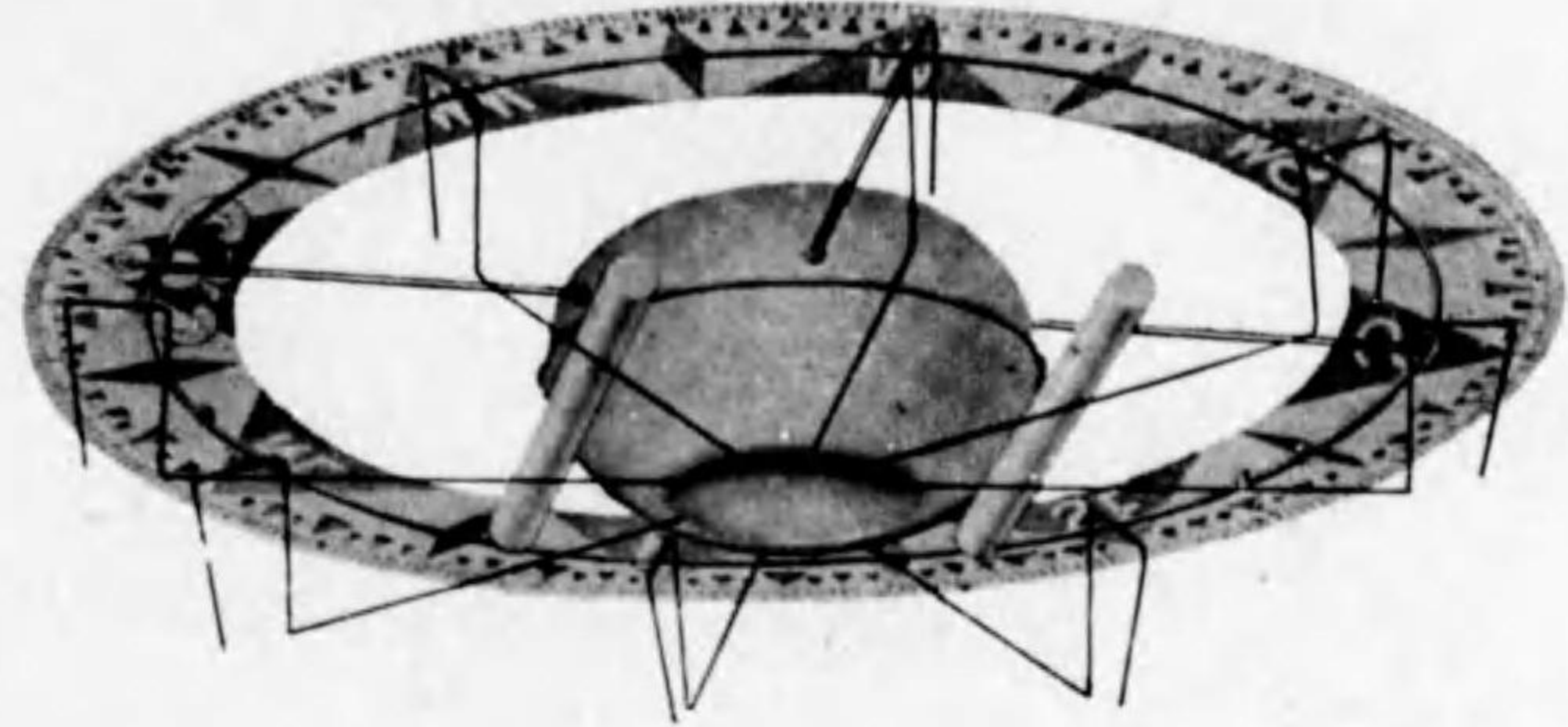

第五圖(戊)

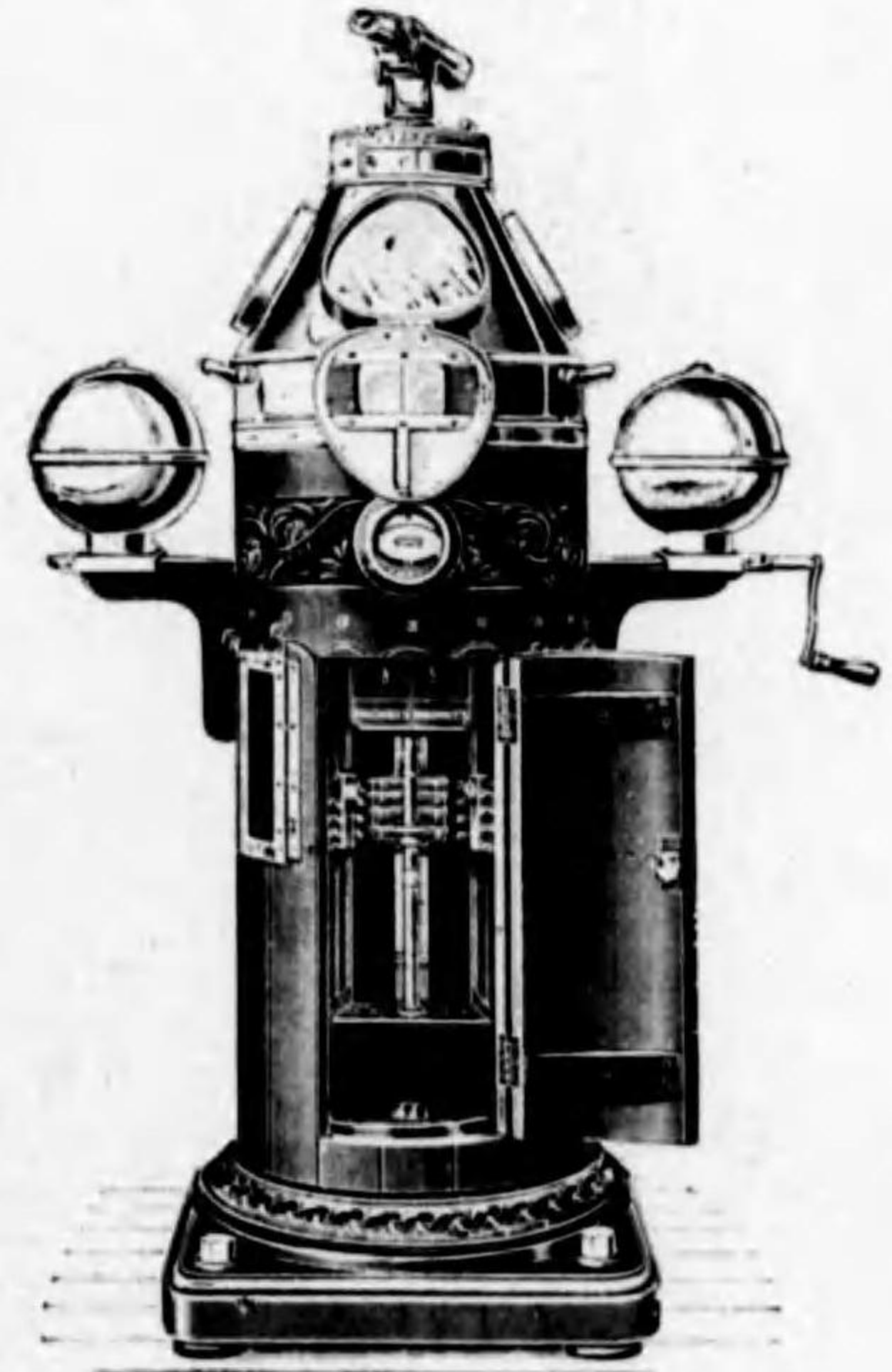

第五圖(丁)



第六圖(甲)

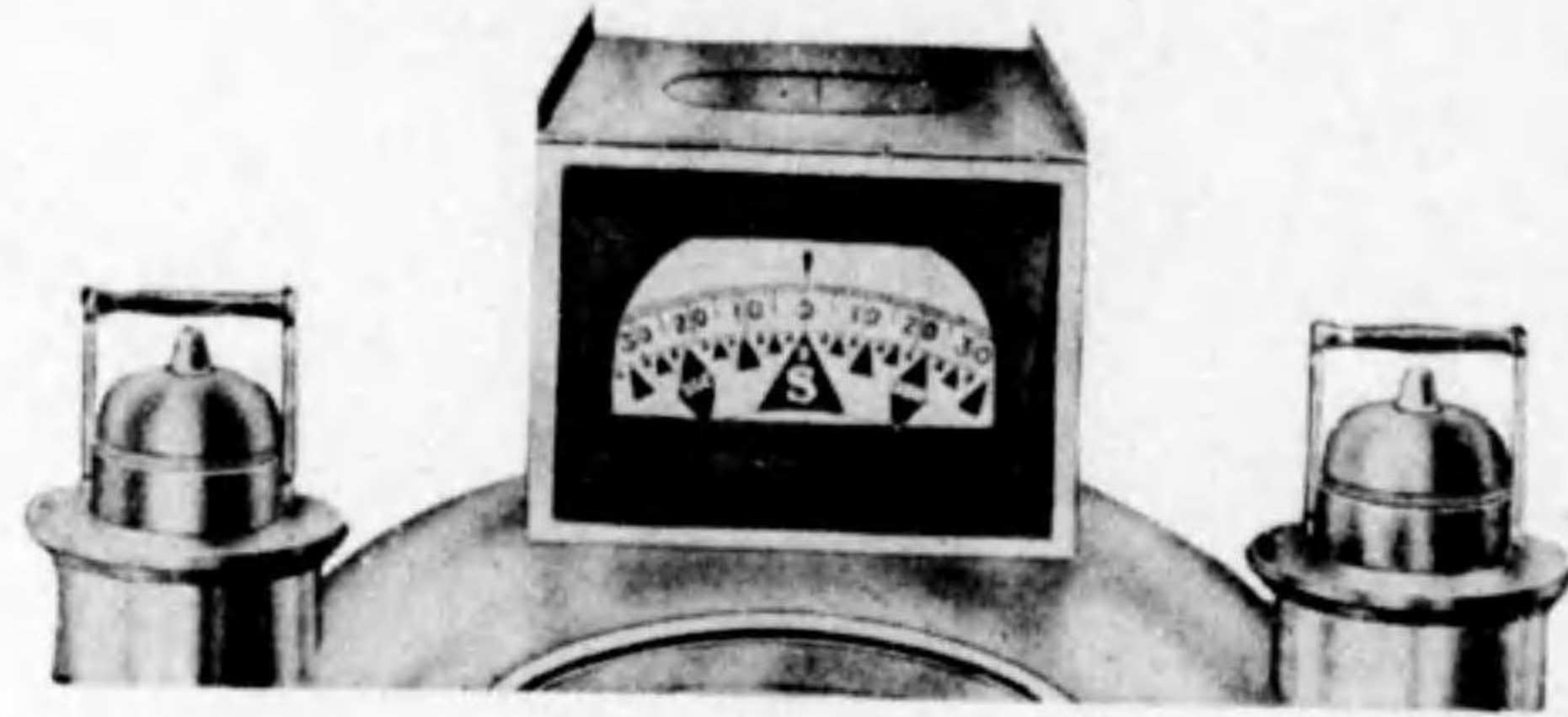

第六圖(乙)

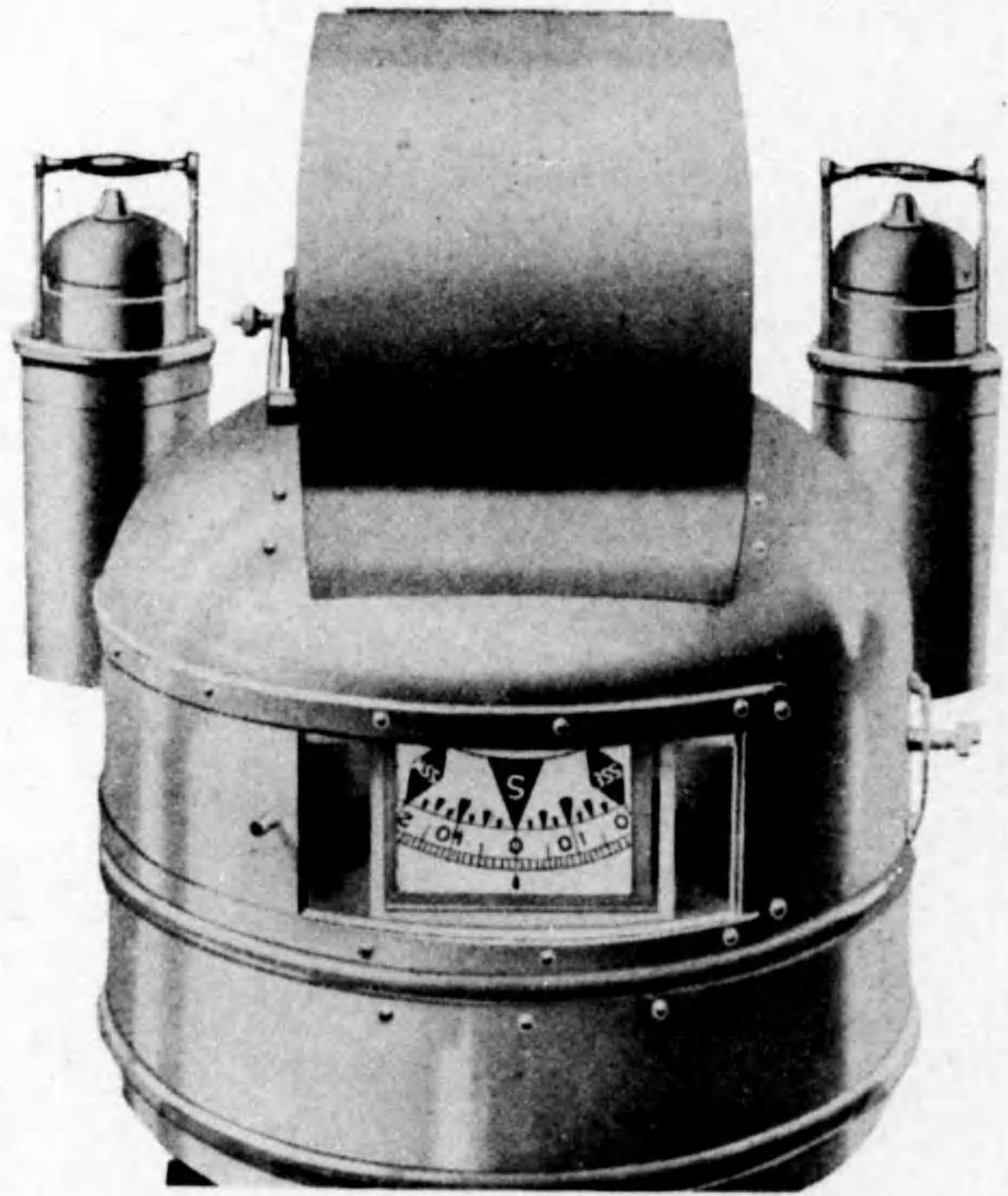

第七圖(甲)

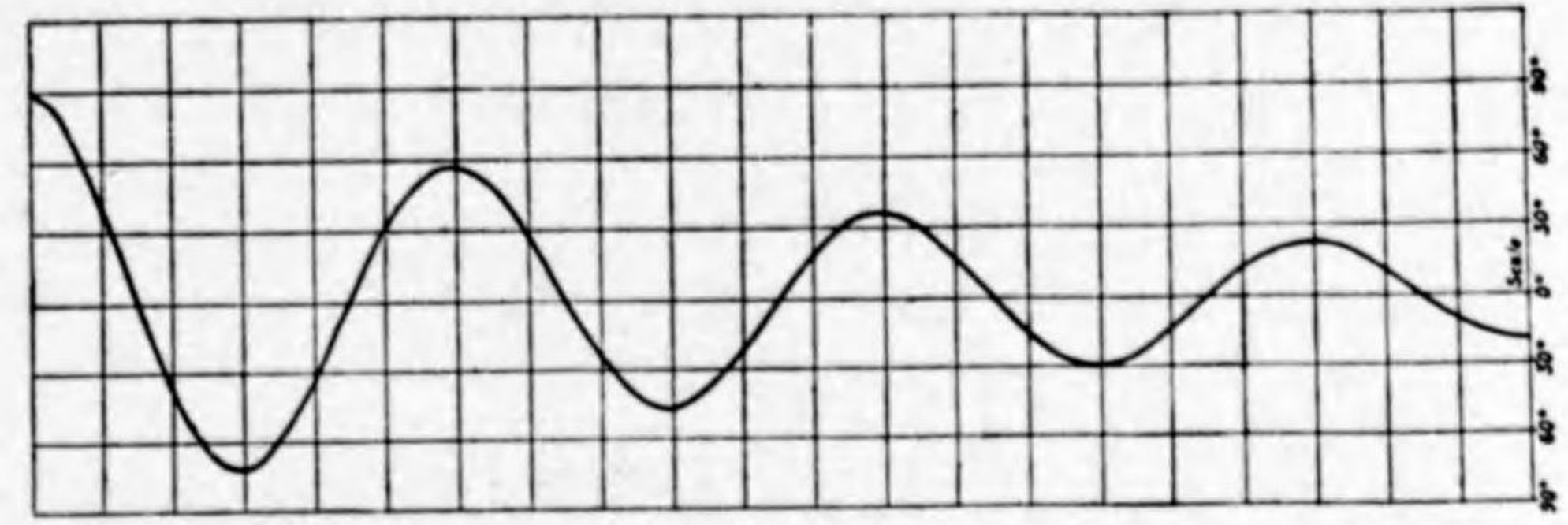

第七圖(乙)

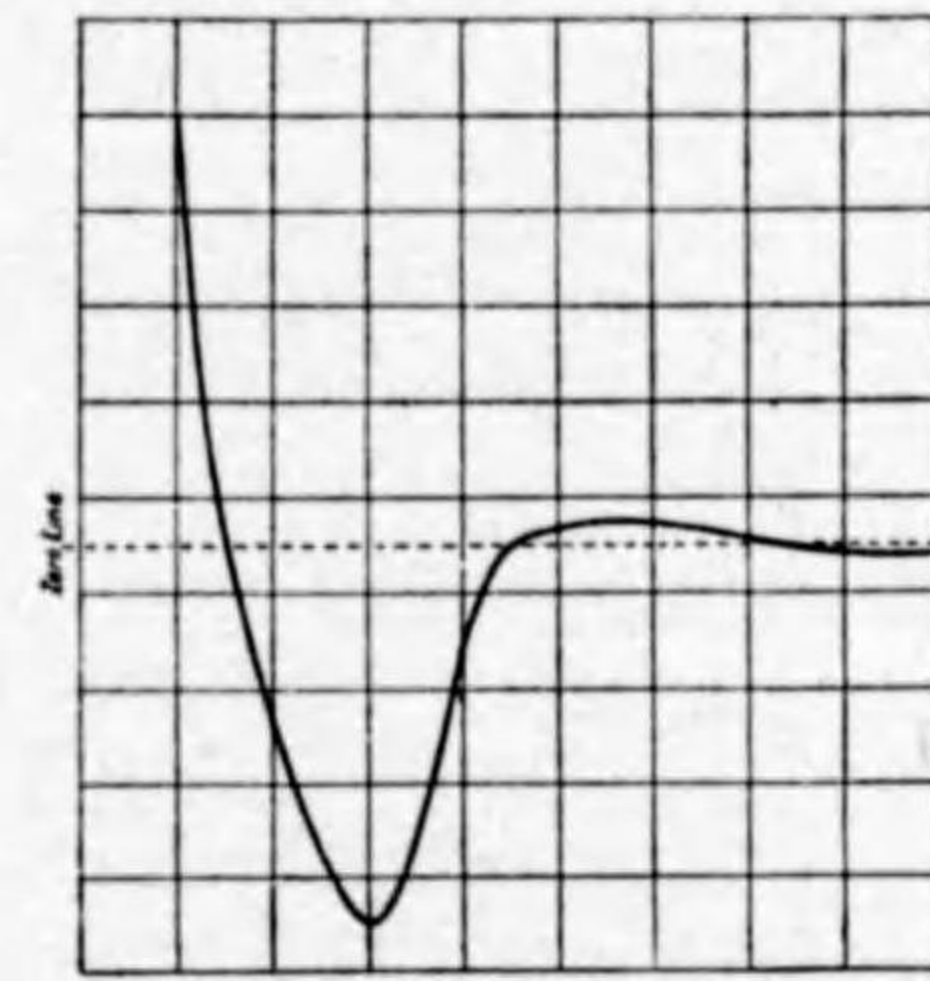

Scale
24° 18° 12° 6° 0° 6° 12° 18° 24°

第七圖(丙)

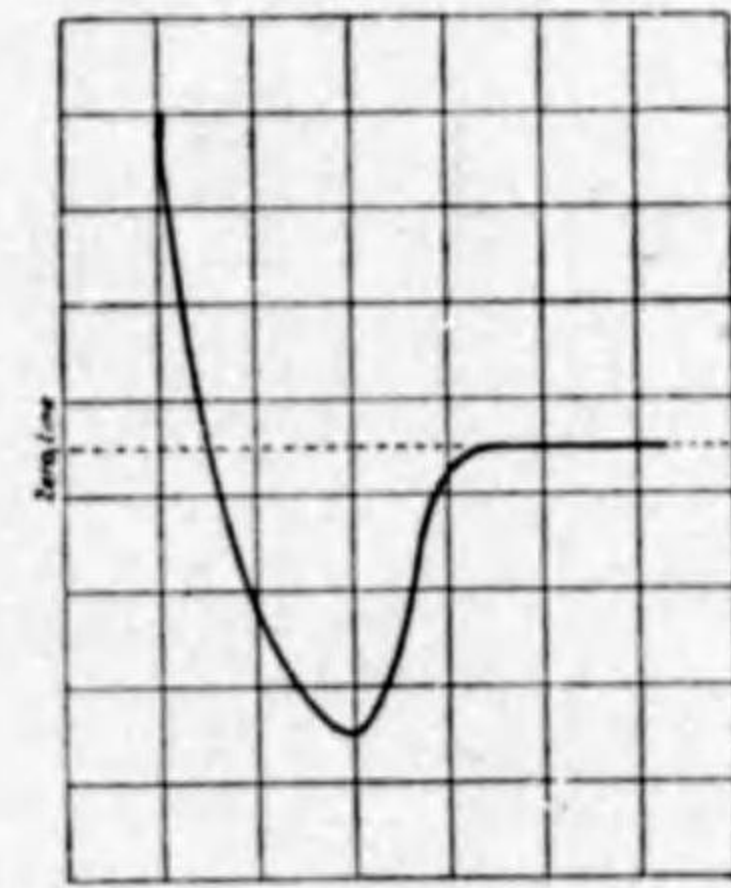

Scale
24° 18° 12° 6° 0° 6° 12° 18° 24°

第八圖

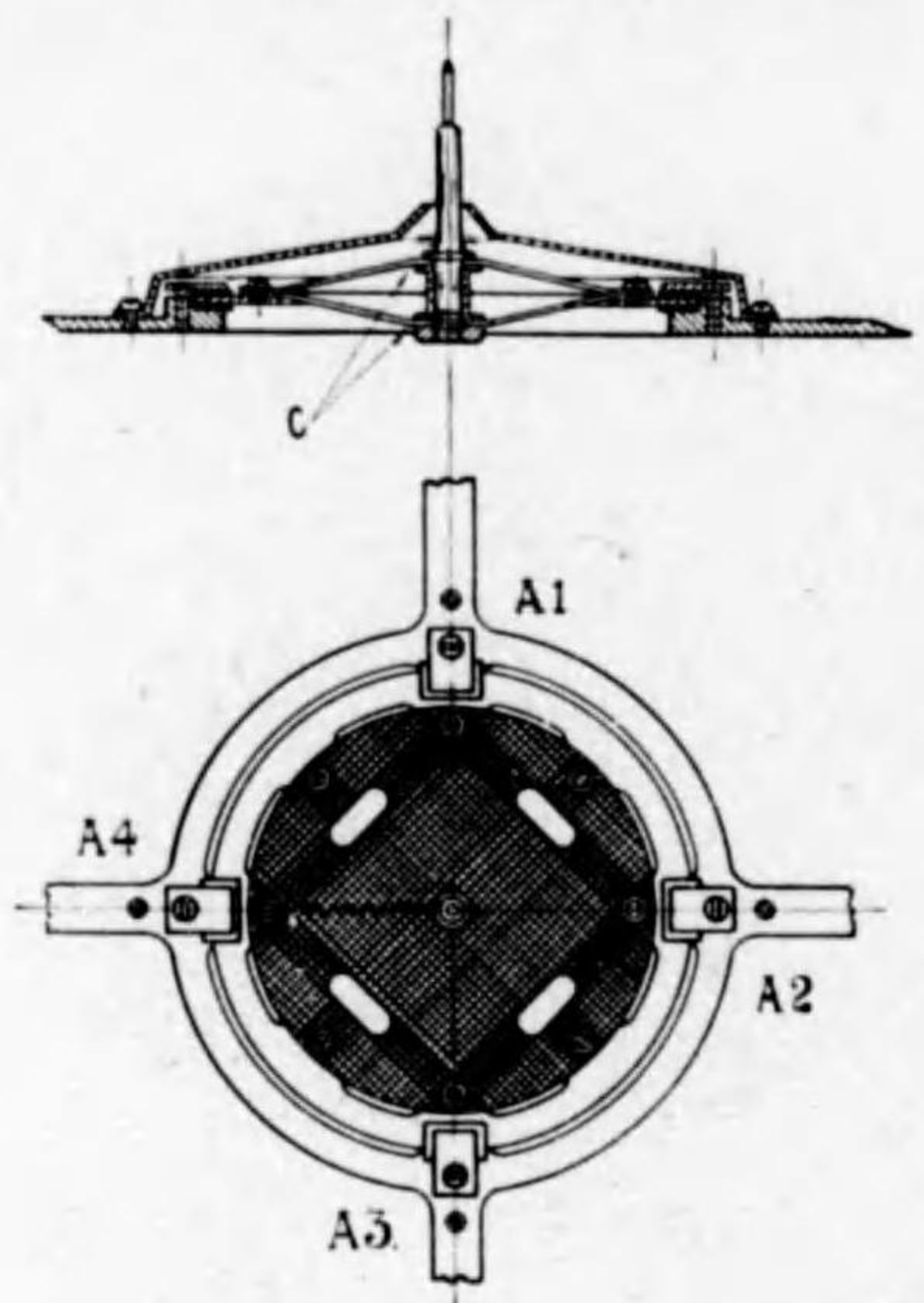

第九圖

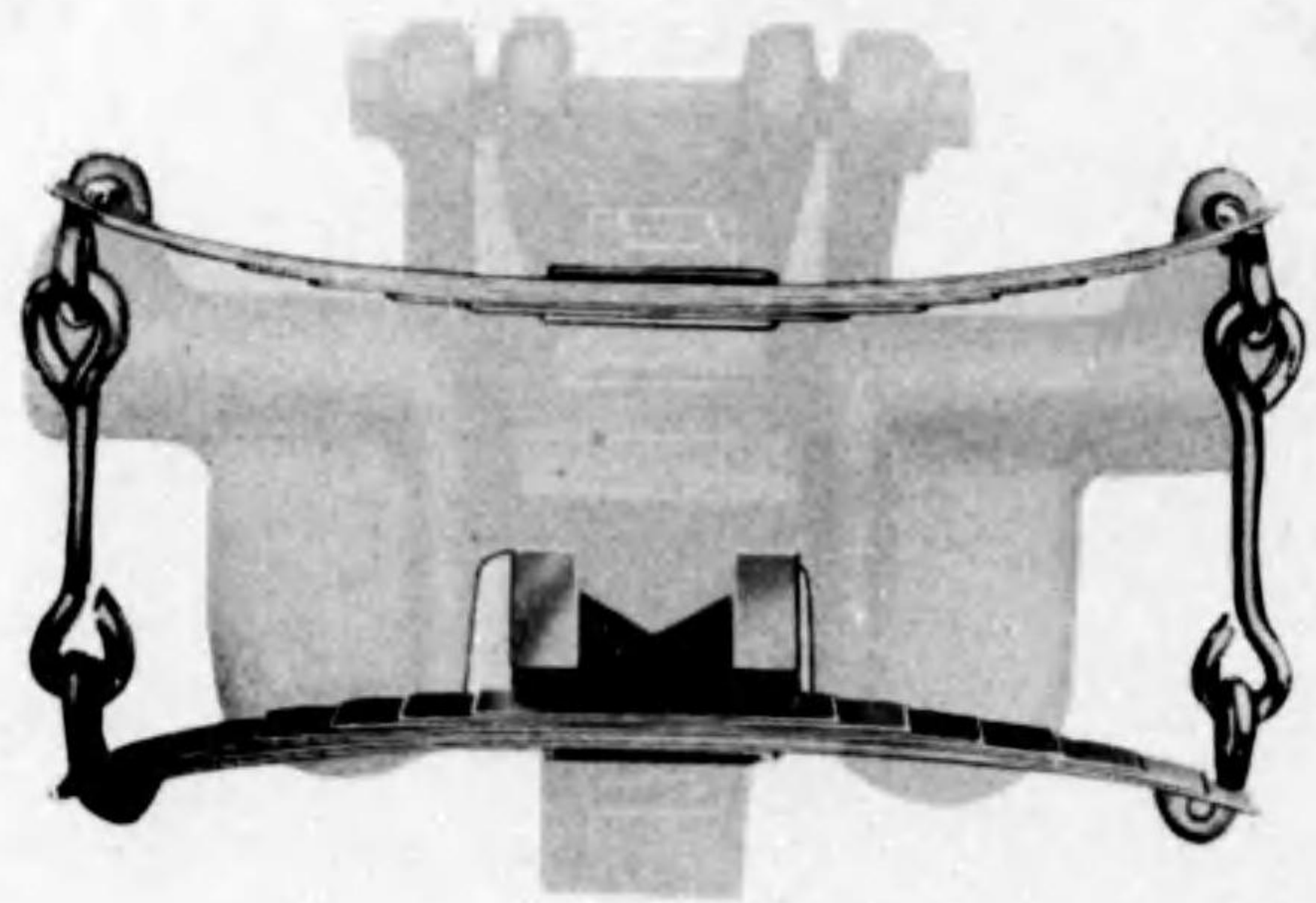

第十圖(甲)

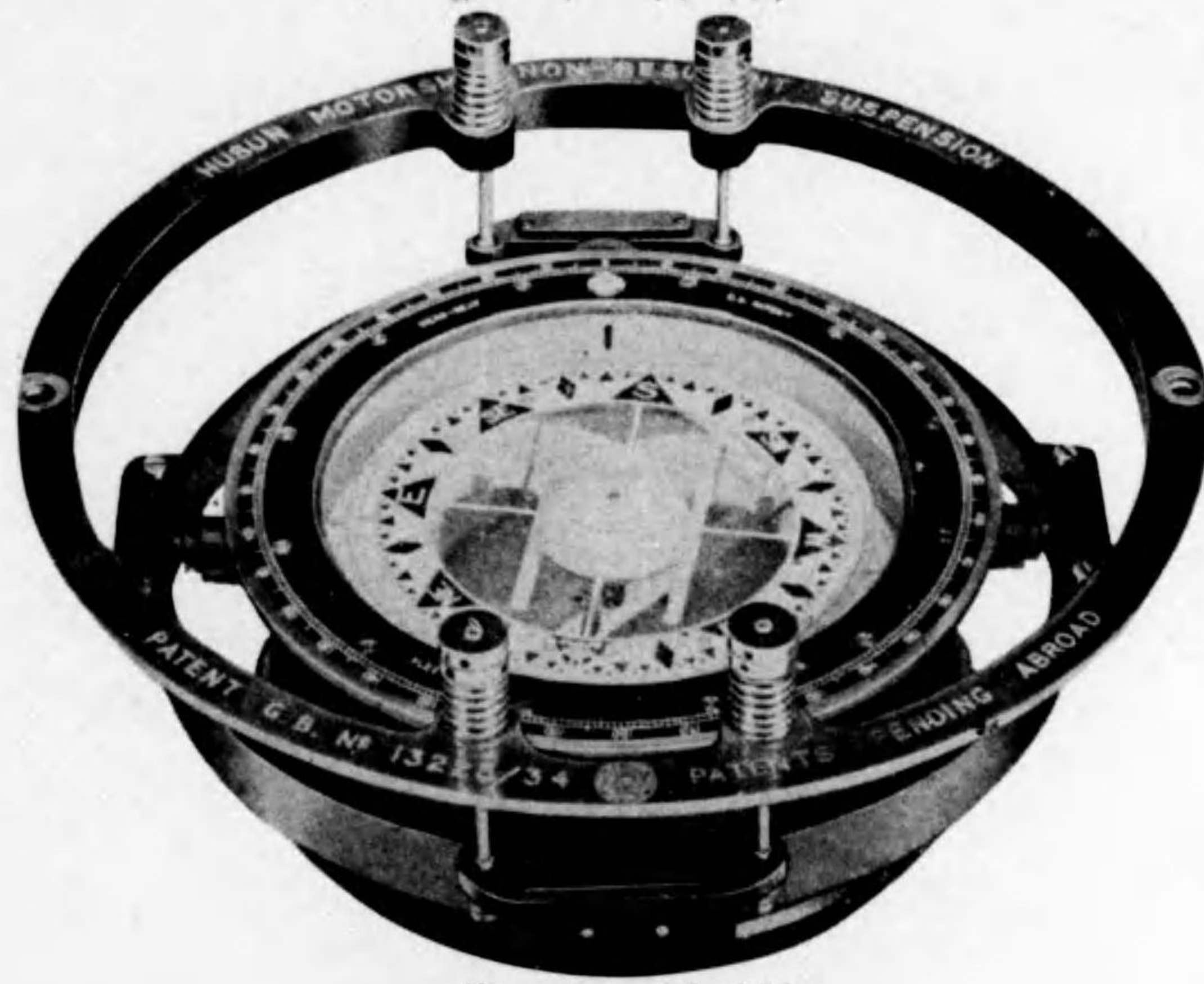

第十圖(乙)

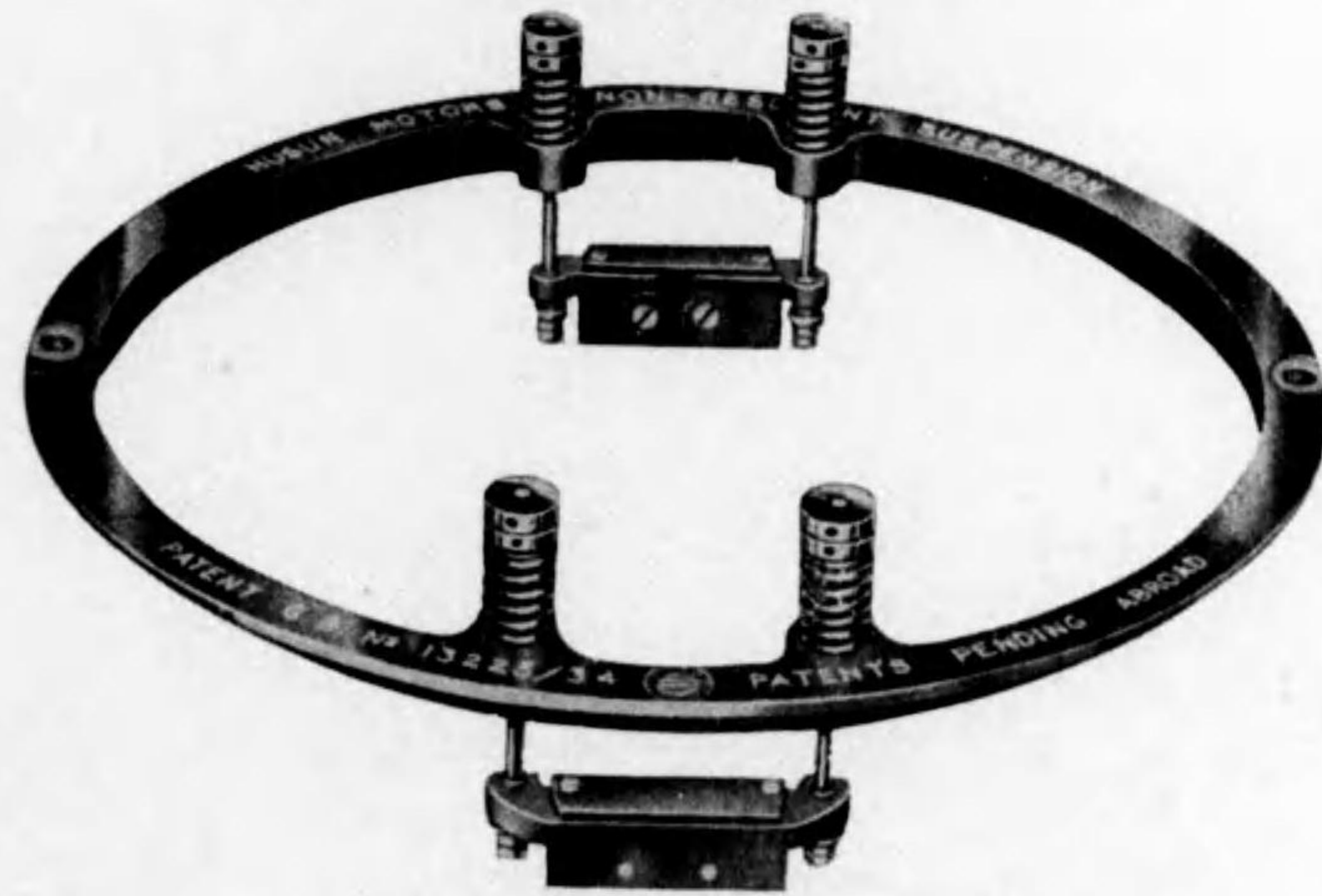

第十一圖

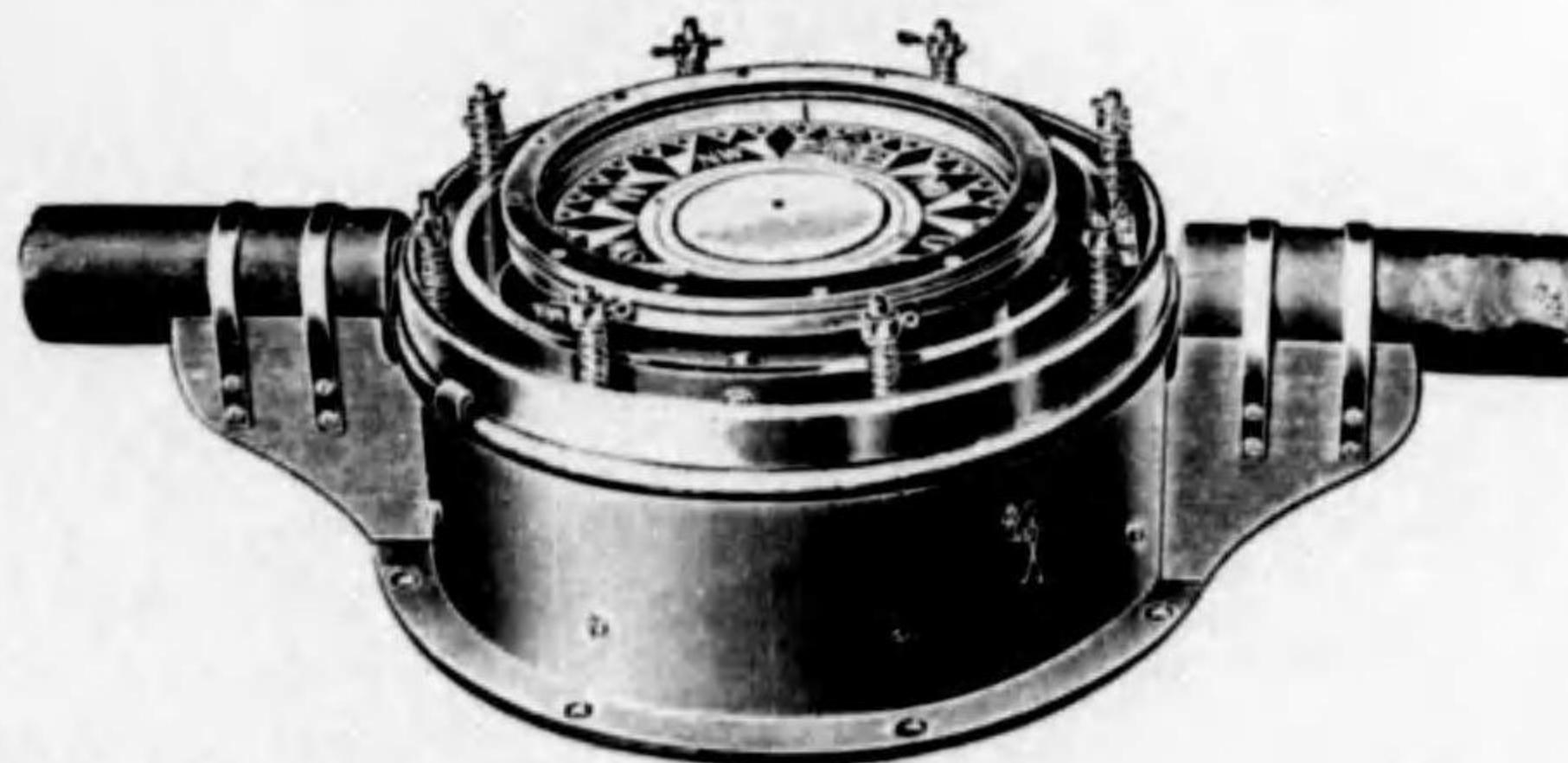

第十二圖(甲)

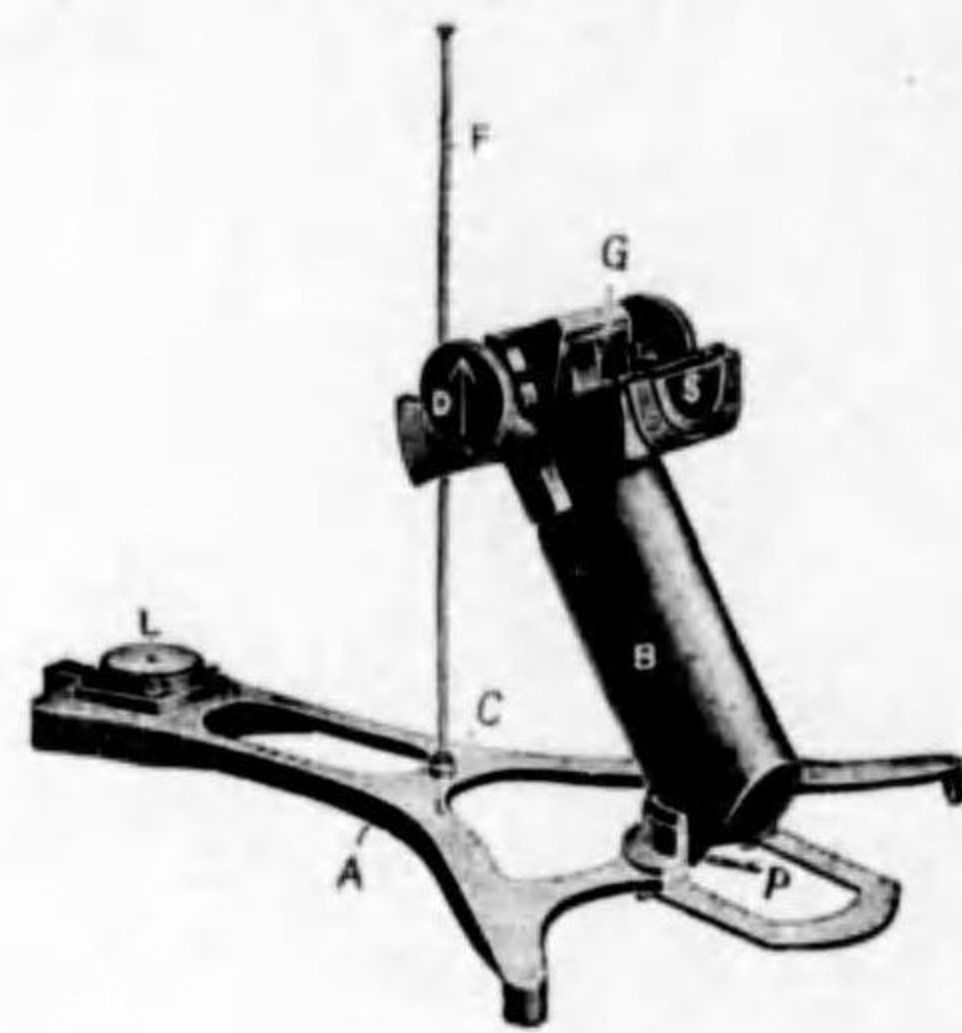

第十二圖(乙)



第十二圖(丙)

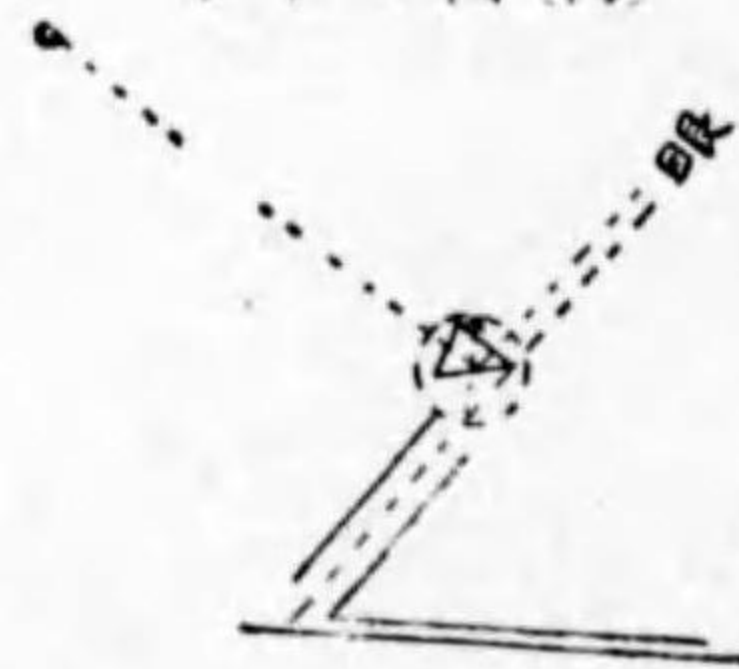

第十二圖(丁)

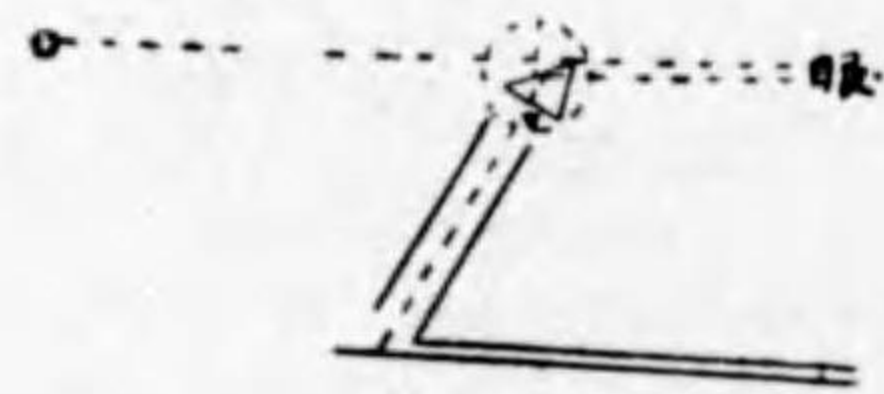

第十三圖

第十二圖(戊)

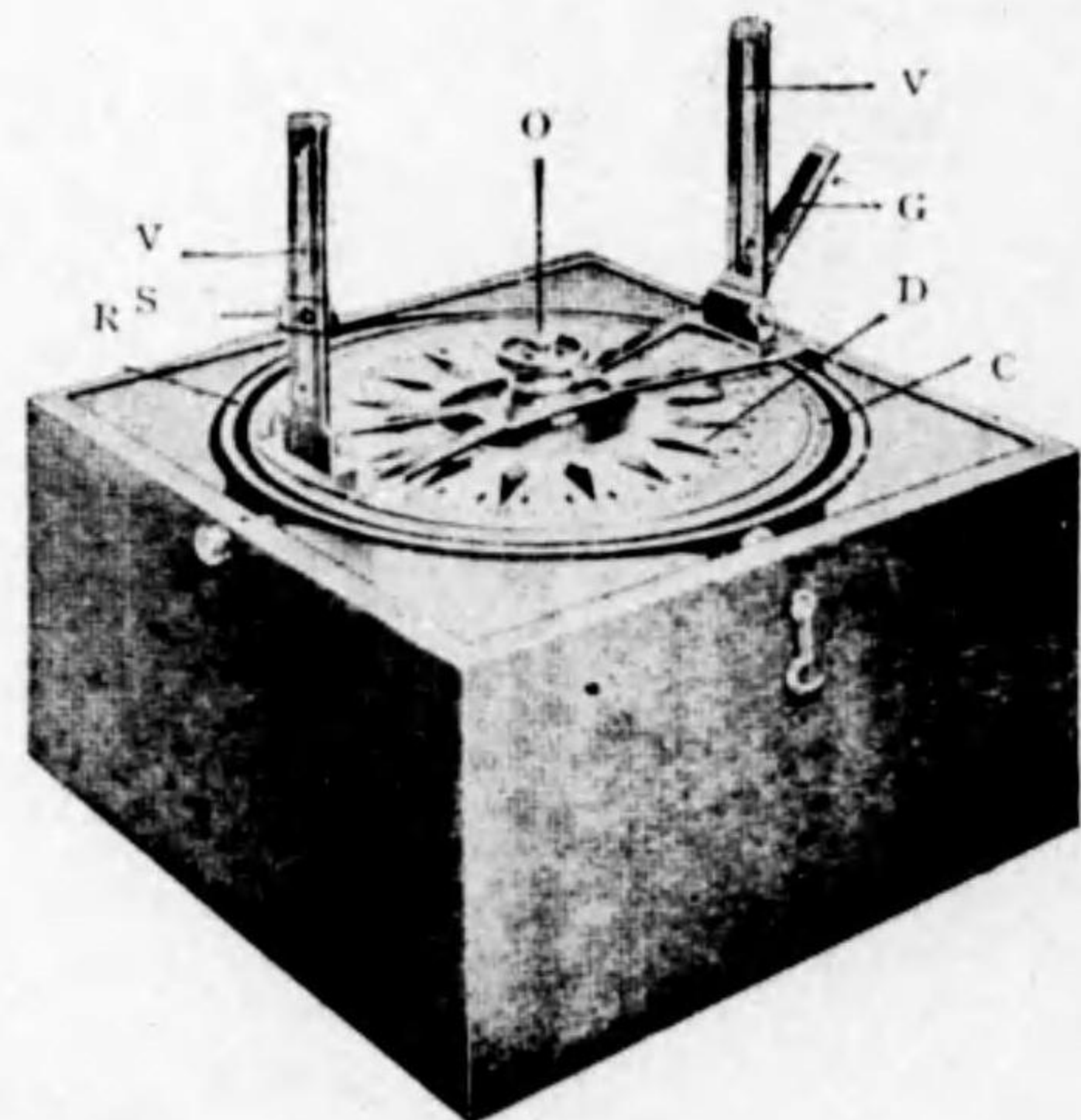
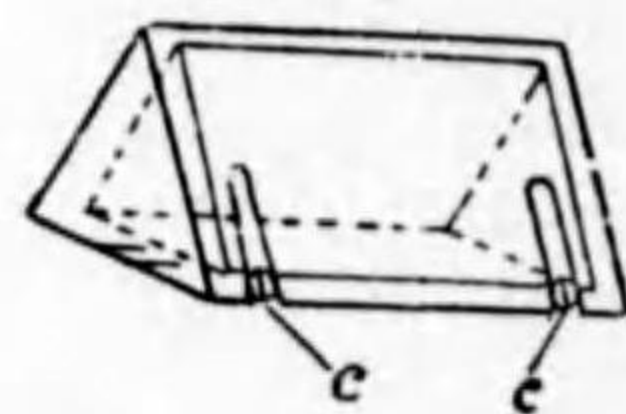

第十四圖

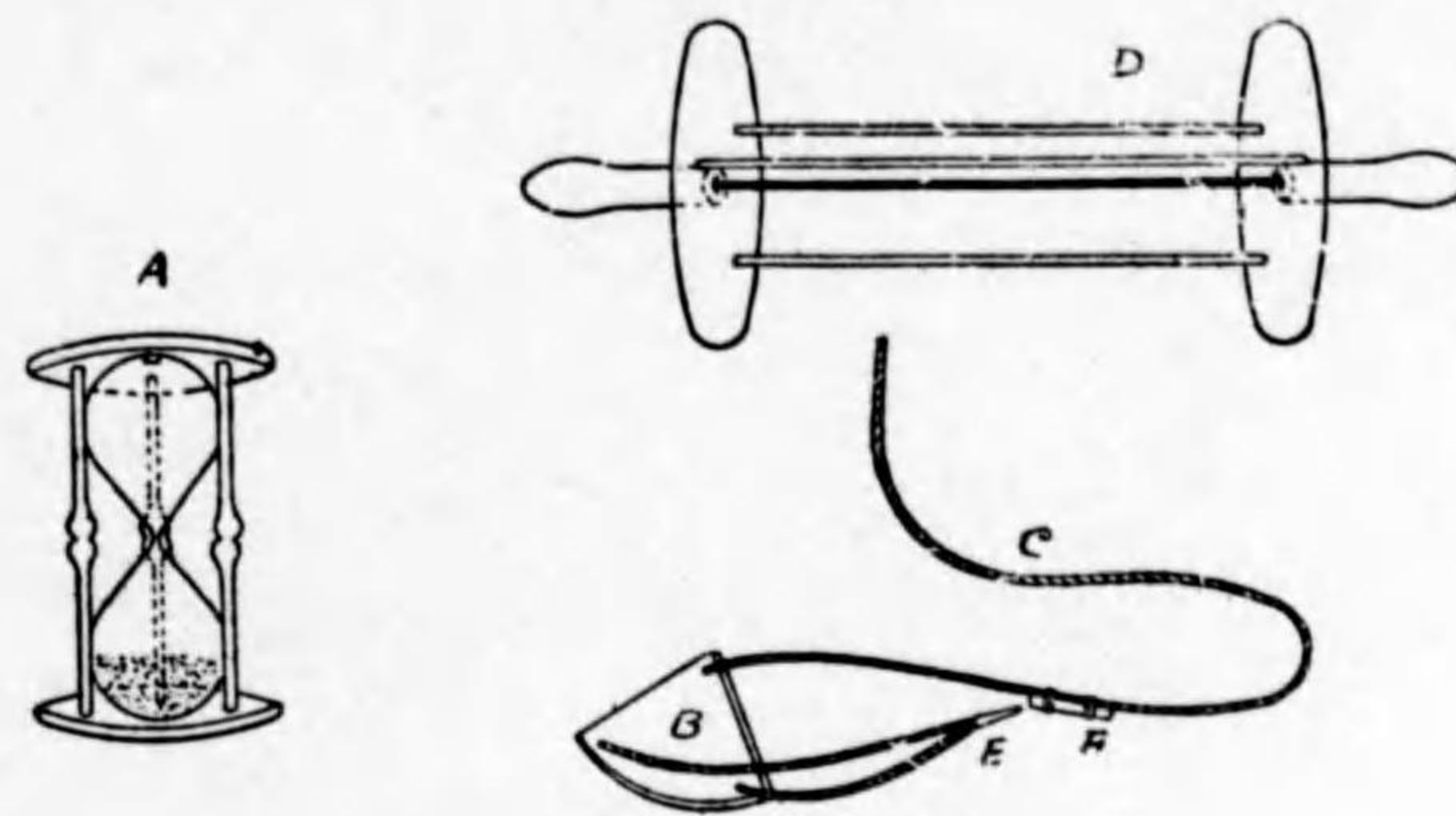

第十五圖(甲)

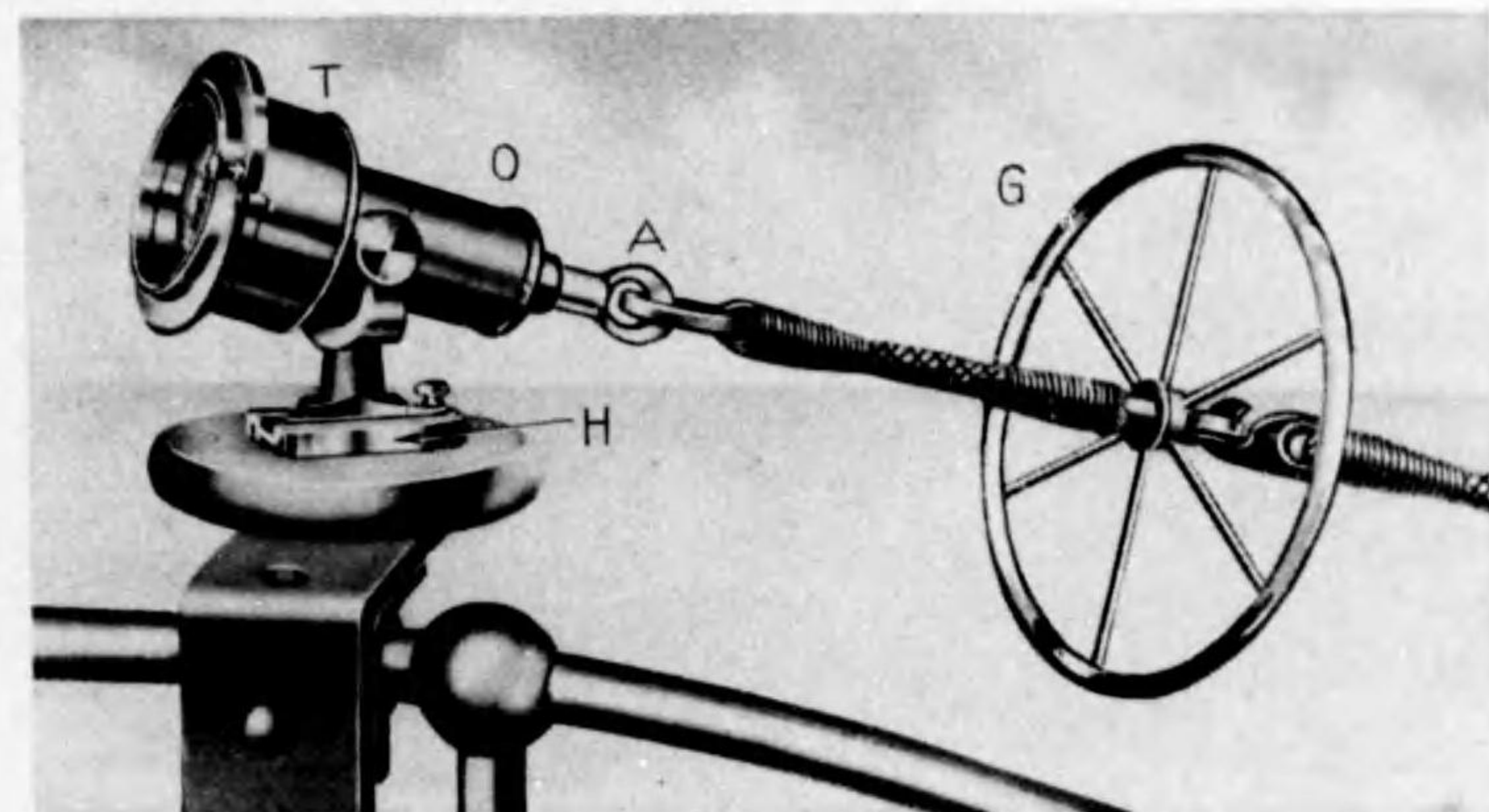

第十五圖(乙)

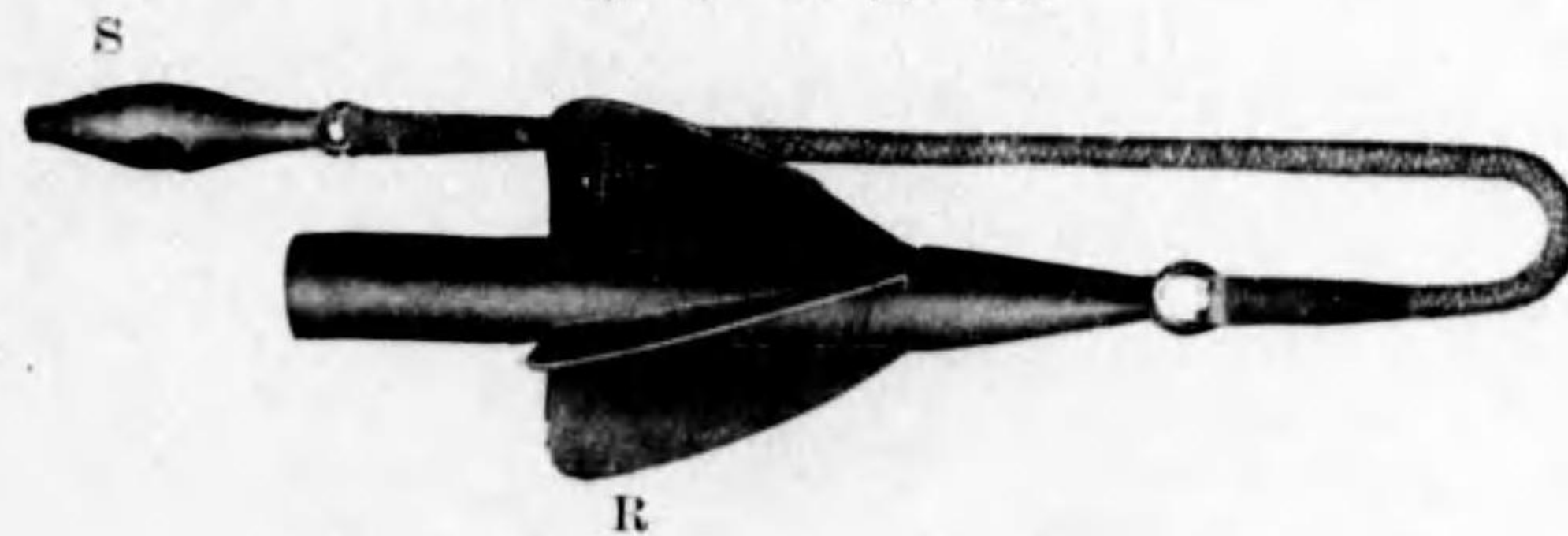

第十六圖(甲)

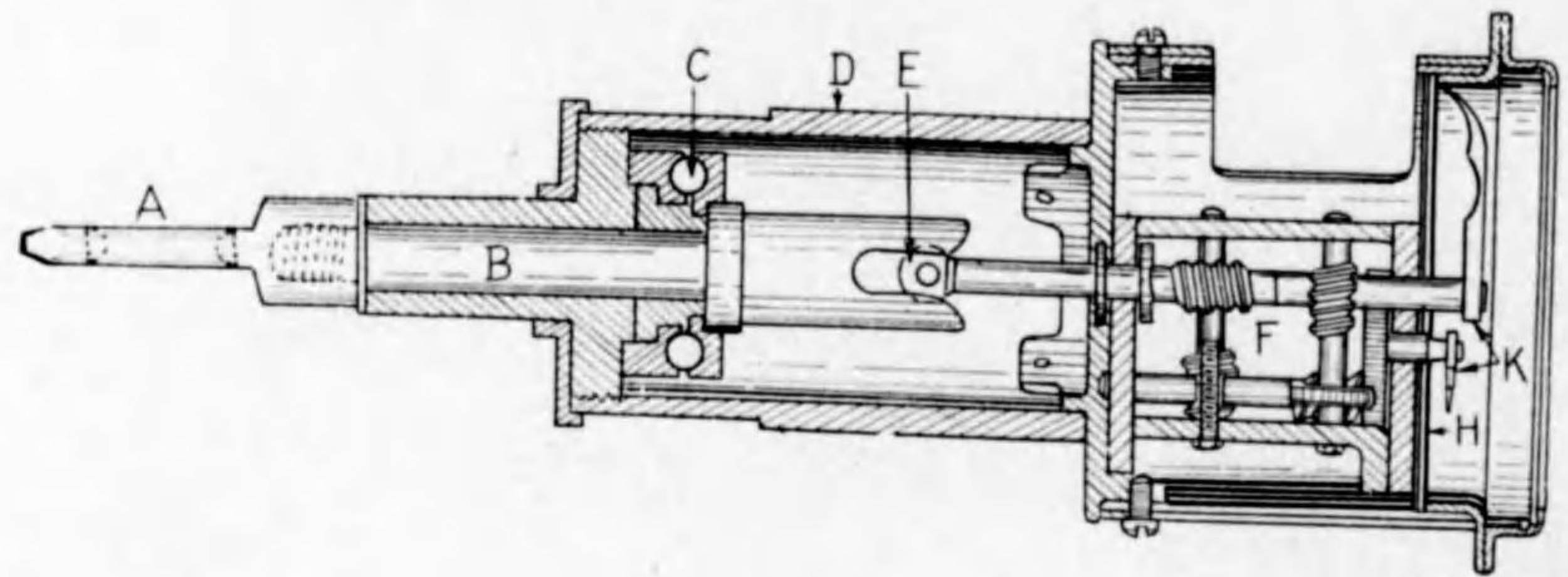

第十六圖(乙)



第十七圖(乙)

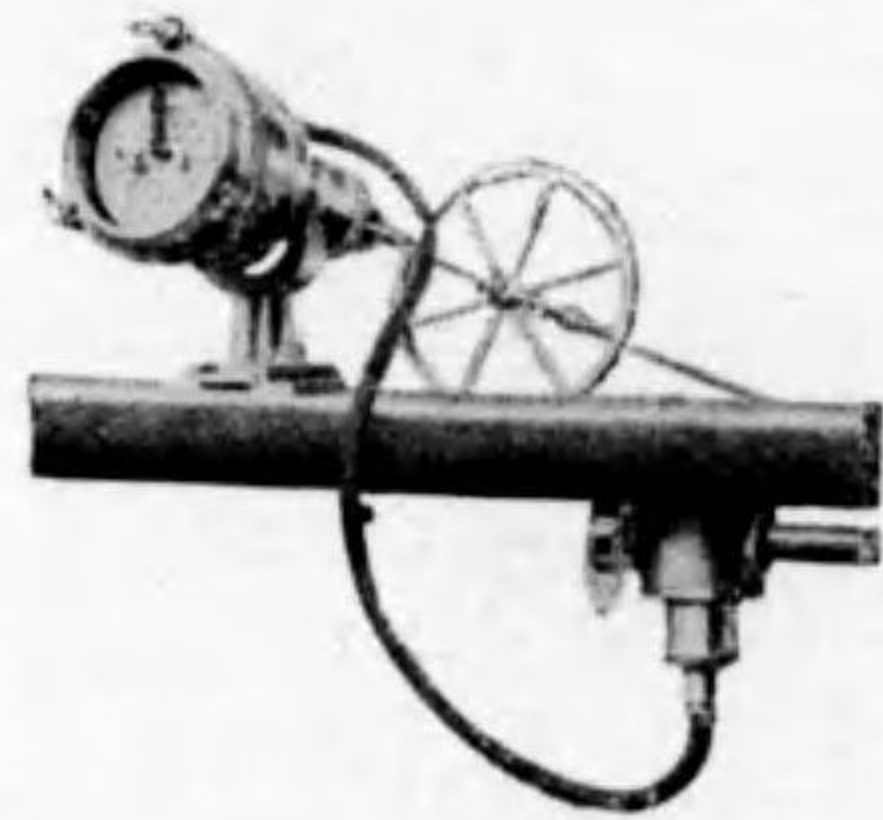

第十七圖(甲)

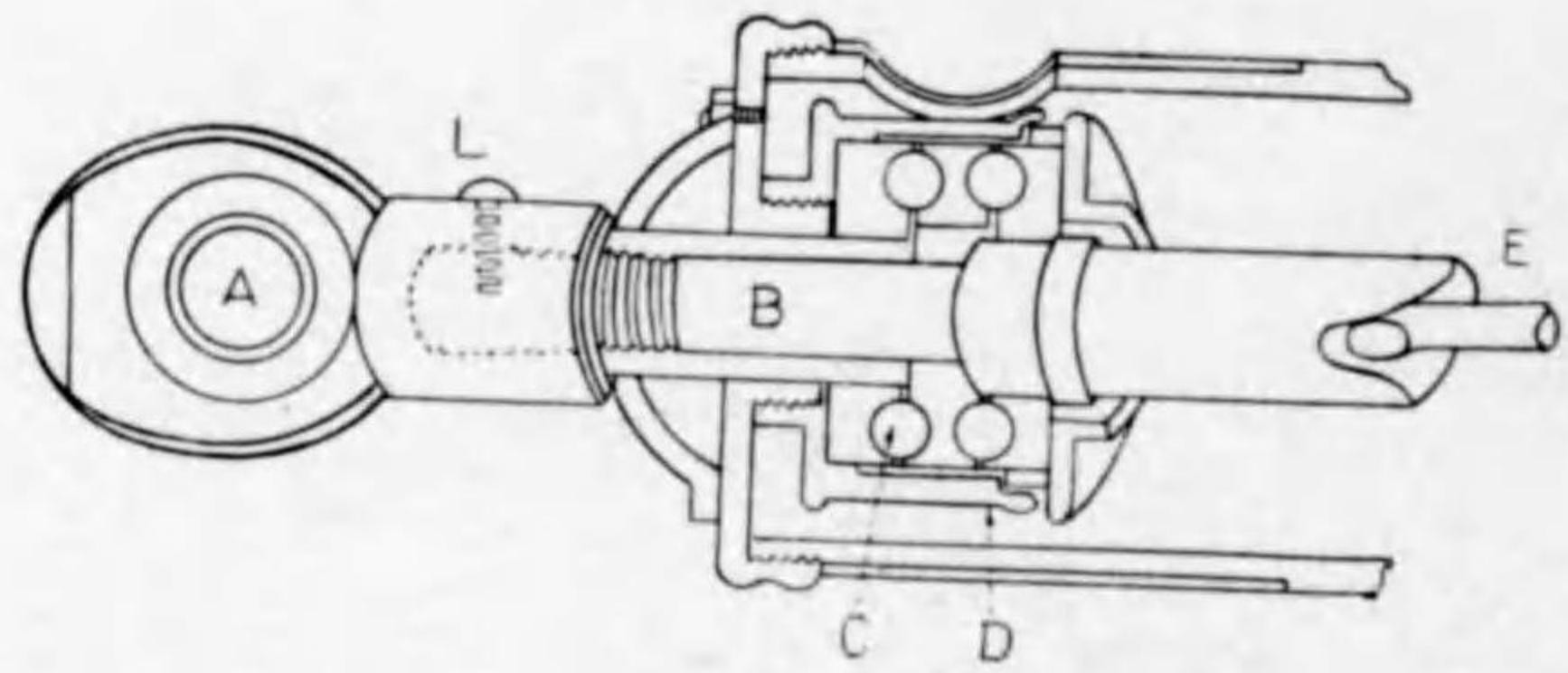

第十七圖(丙)

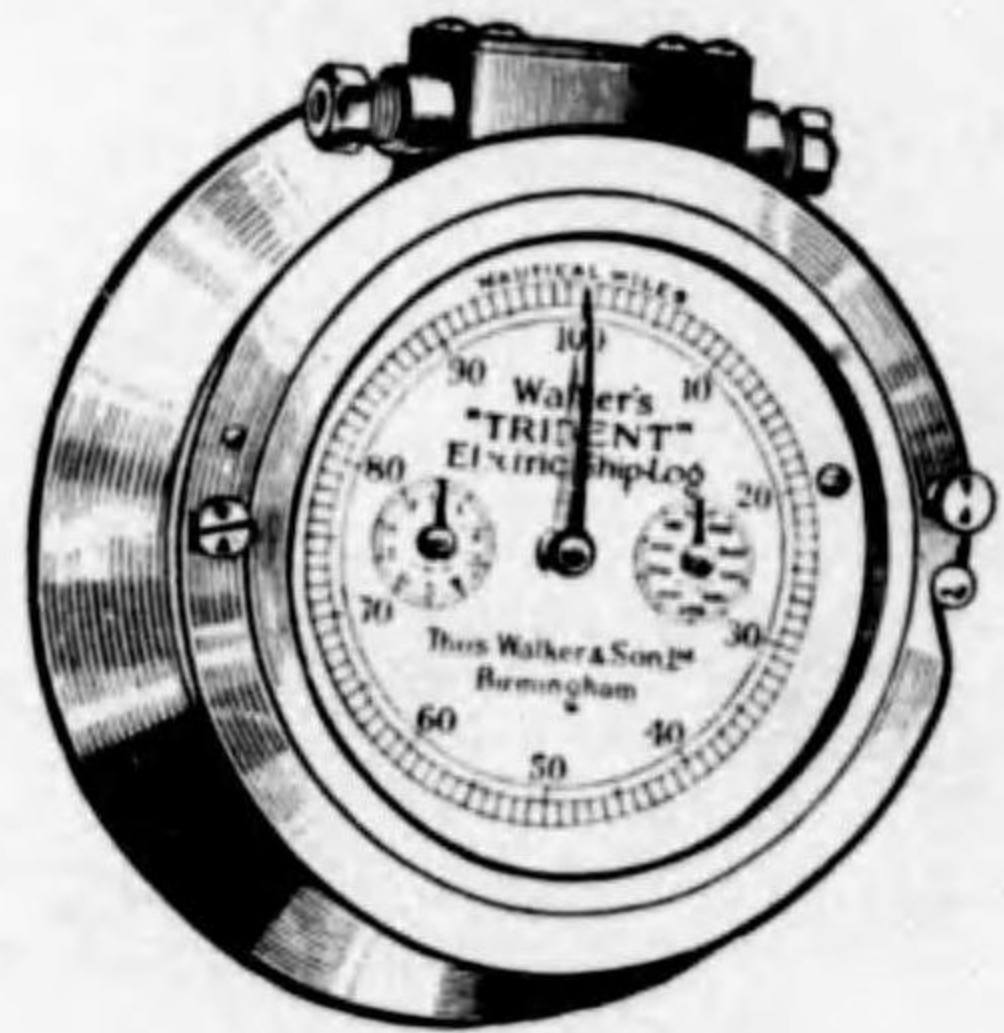

第十七圖(丁)

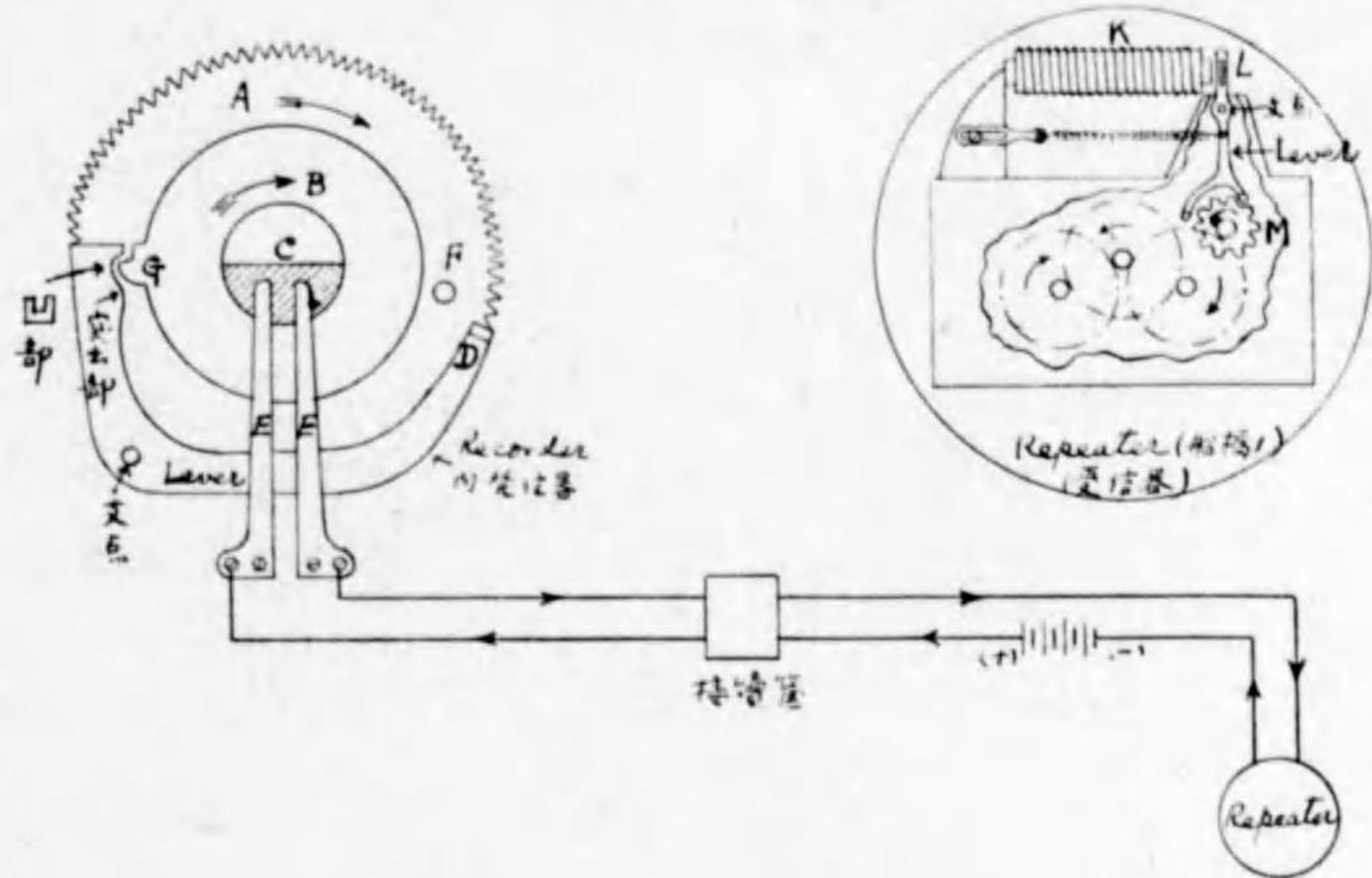

第十七圖(戊)

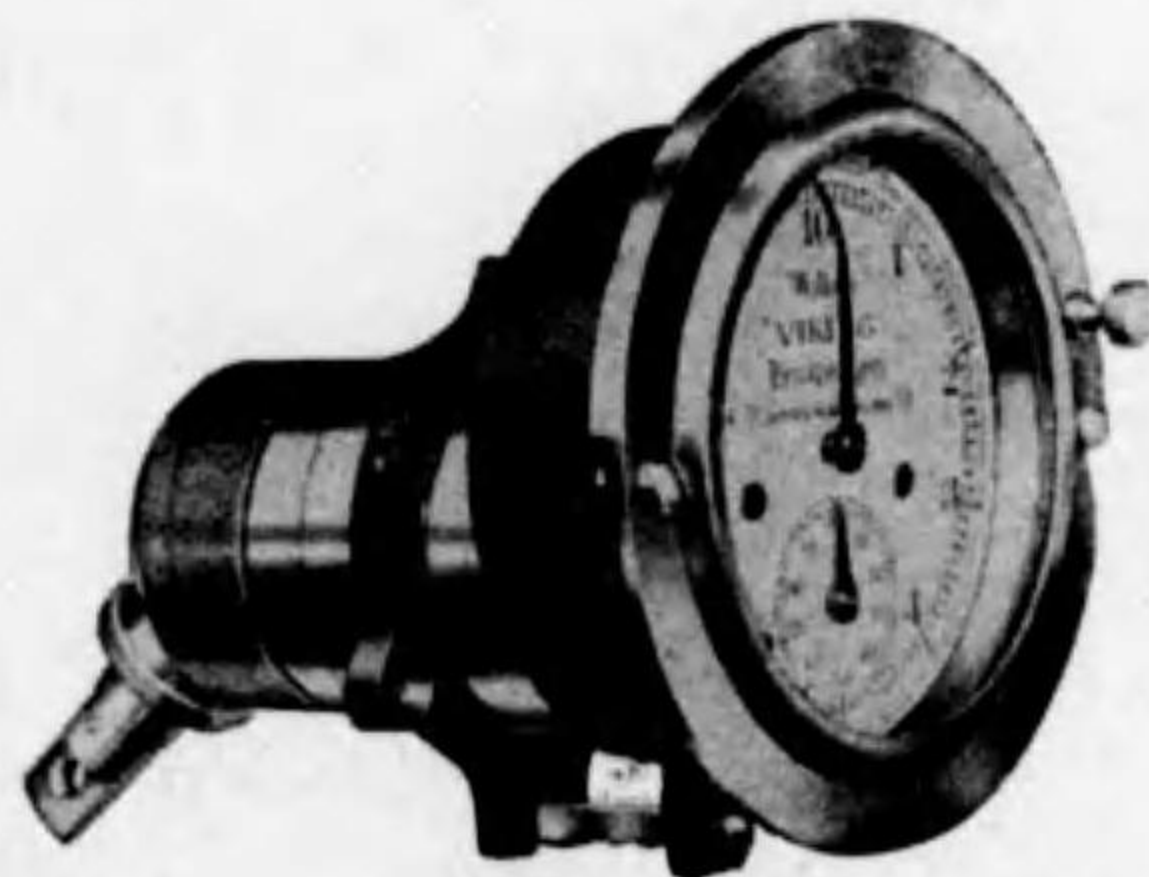

第十八圖(乙)

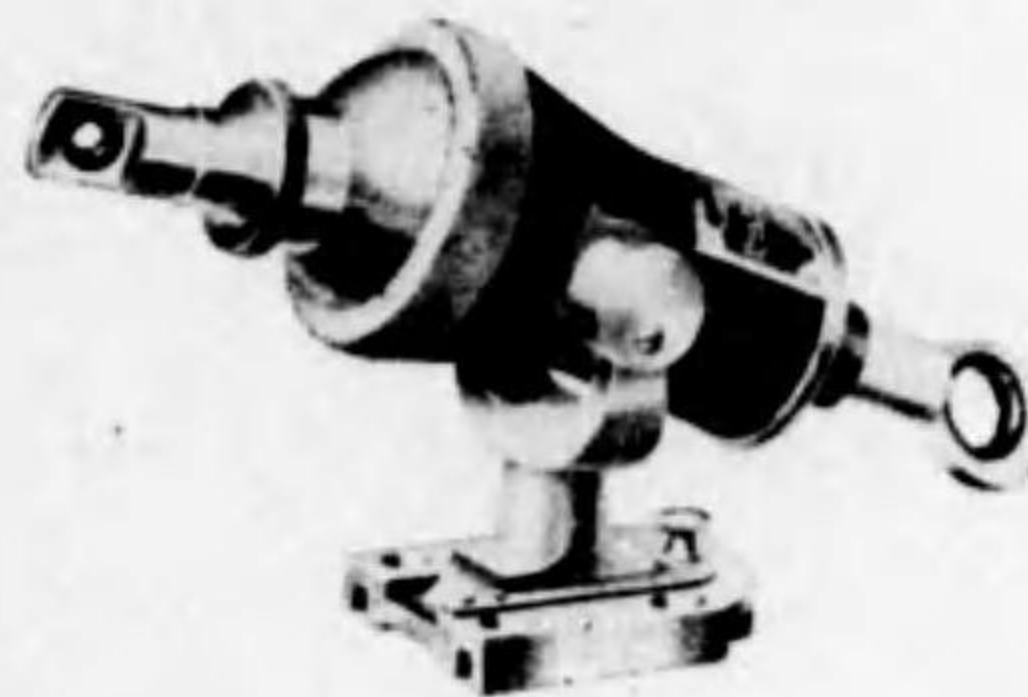

第十八圖(甲)

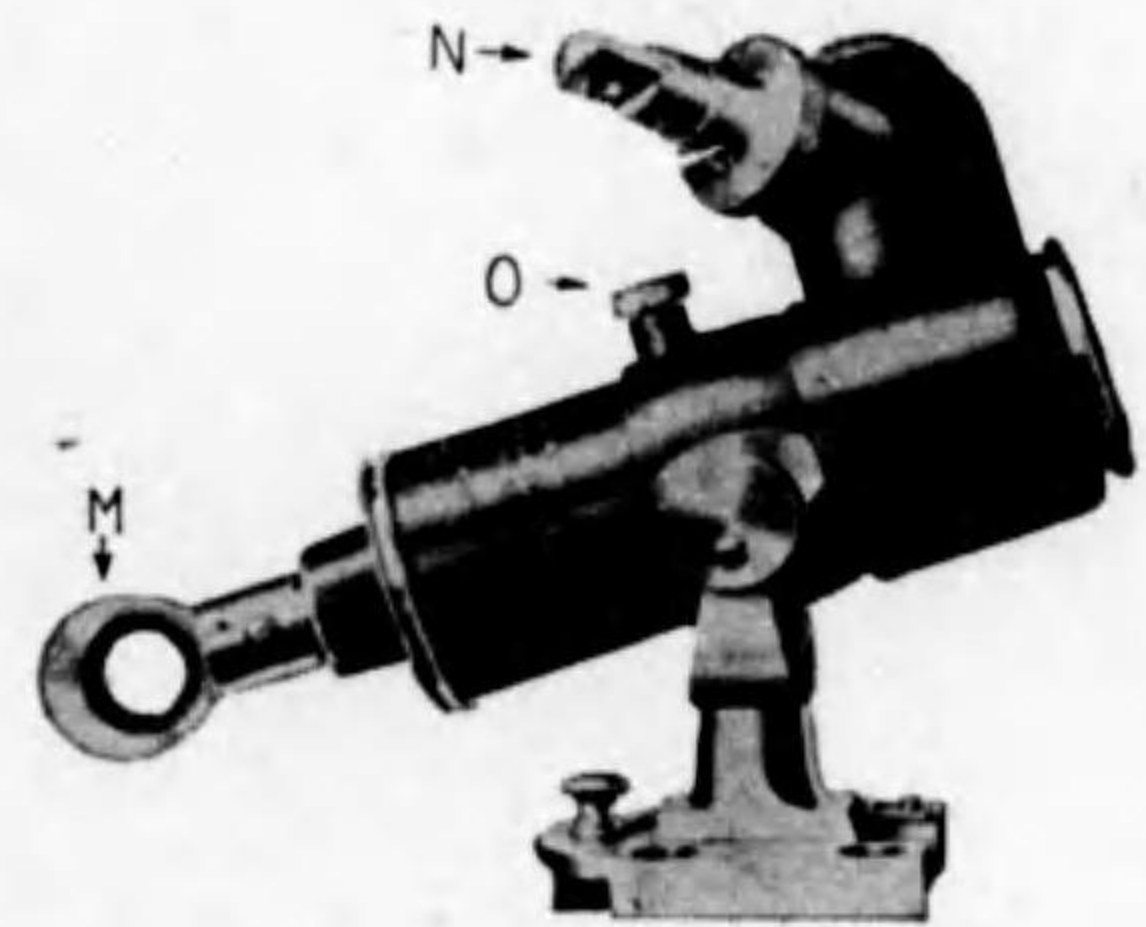

第十八圖(丙)

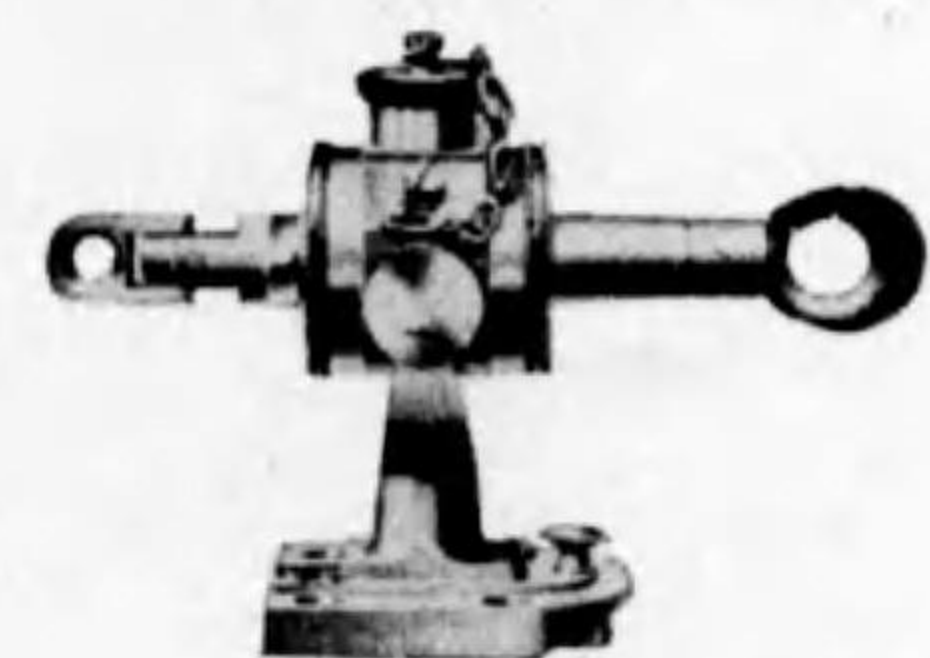

第十九圖

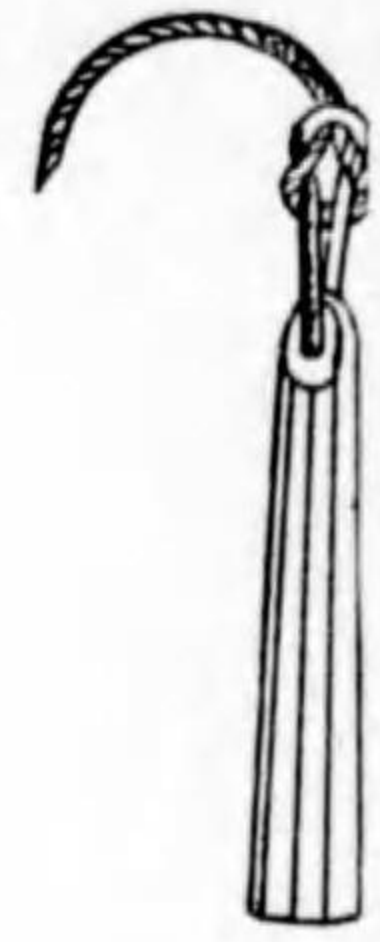

第二十圖(甲)

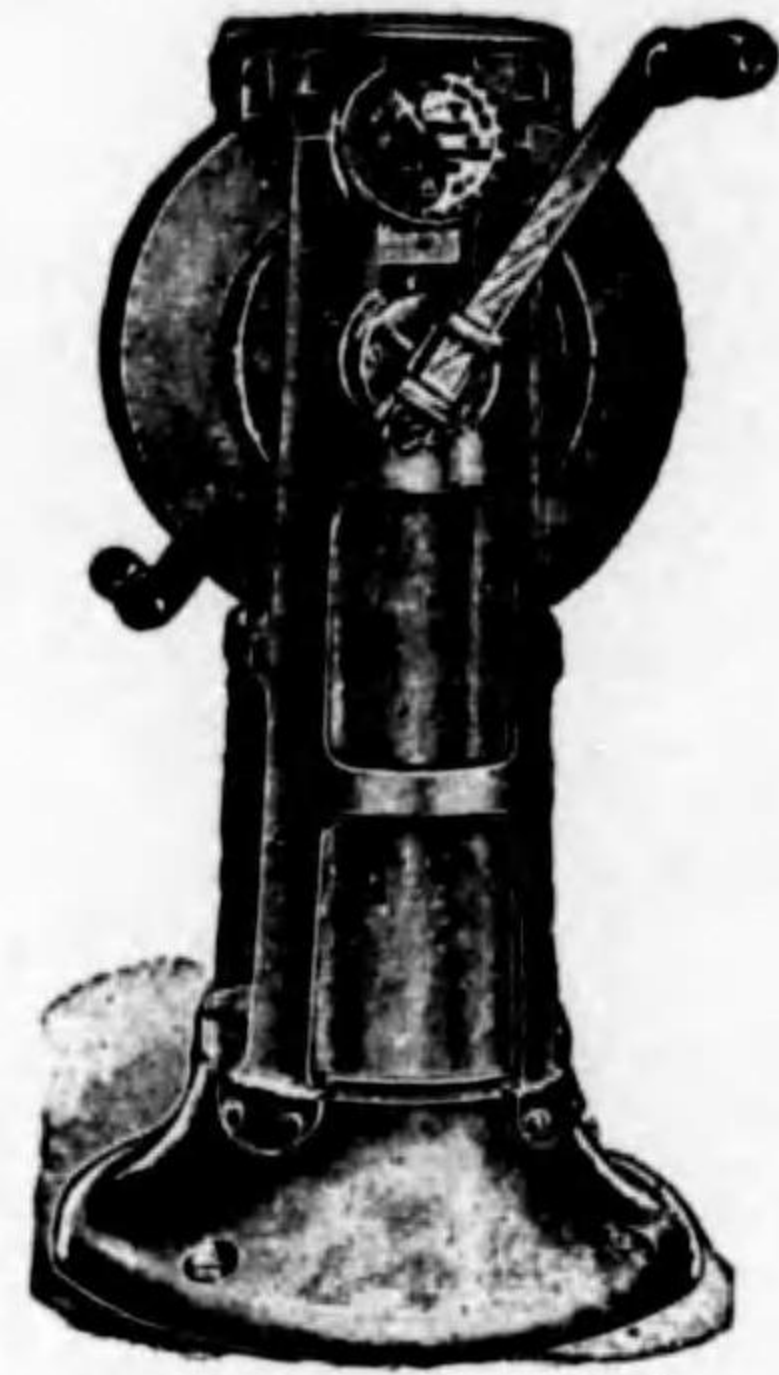

第二十圖(乙)

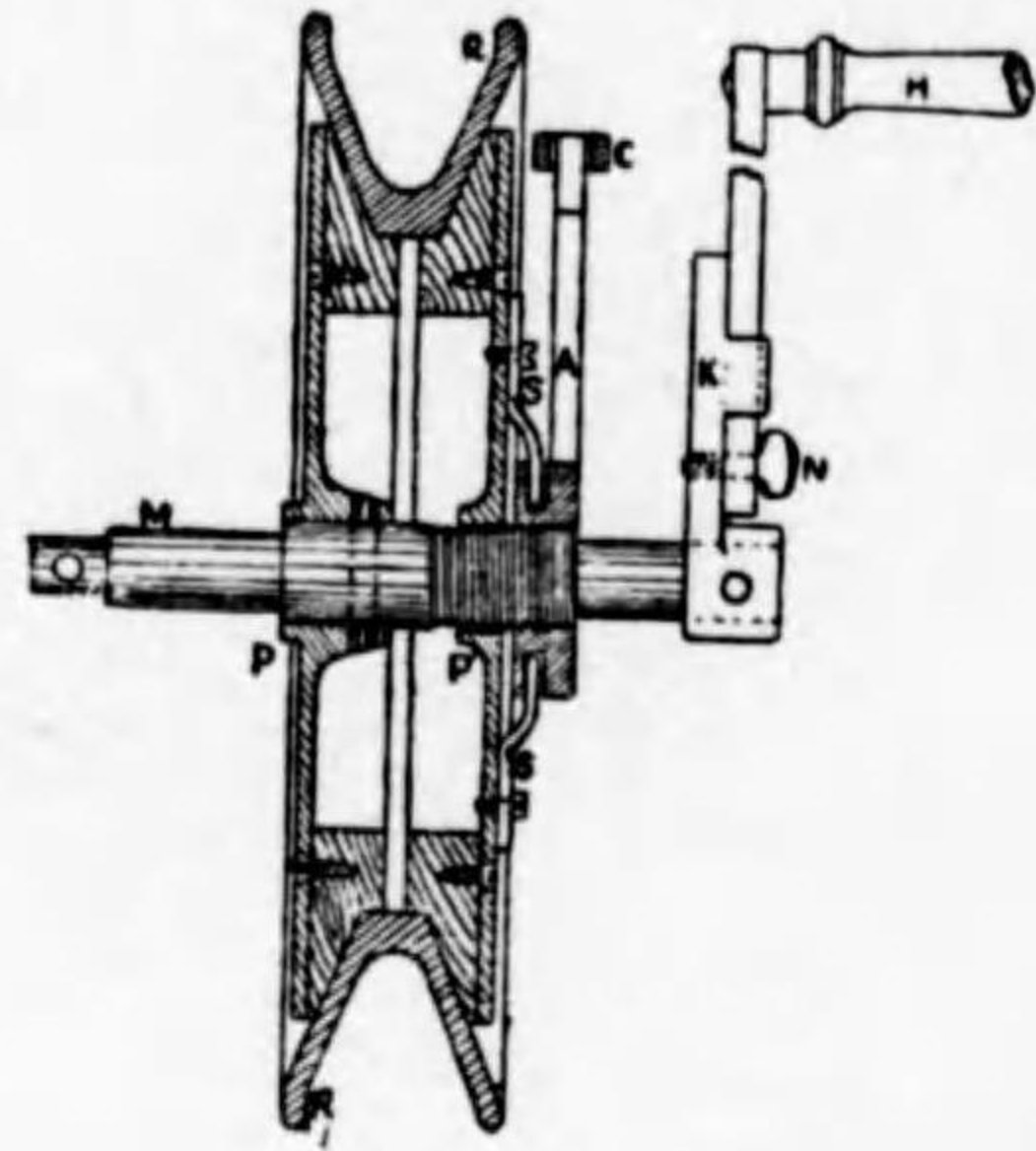

第二十一圖

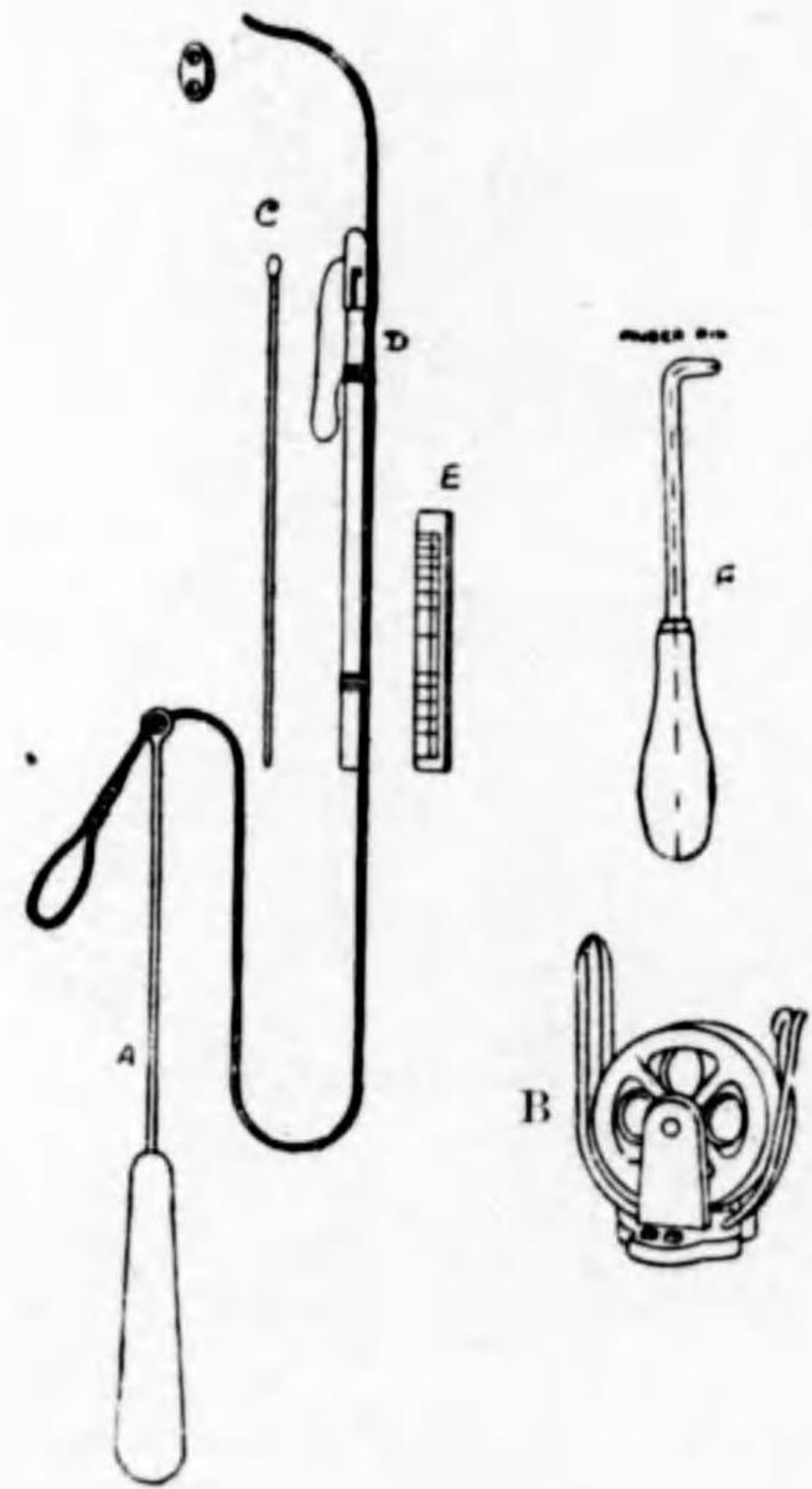

第二十二圖

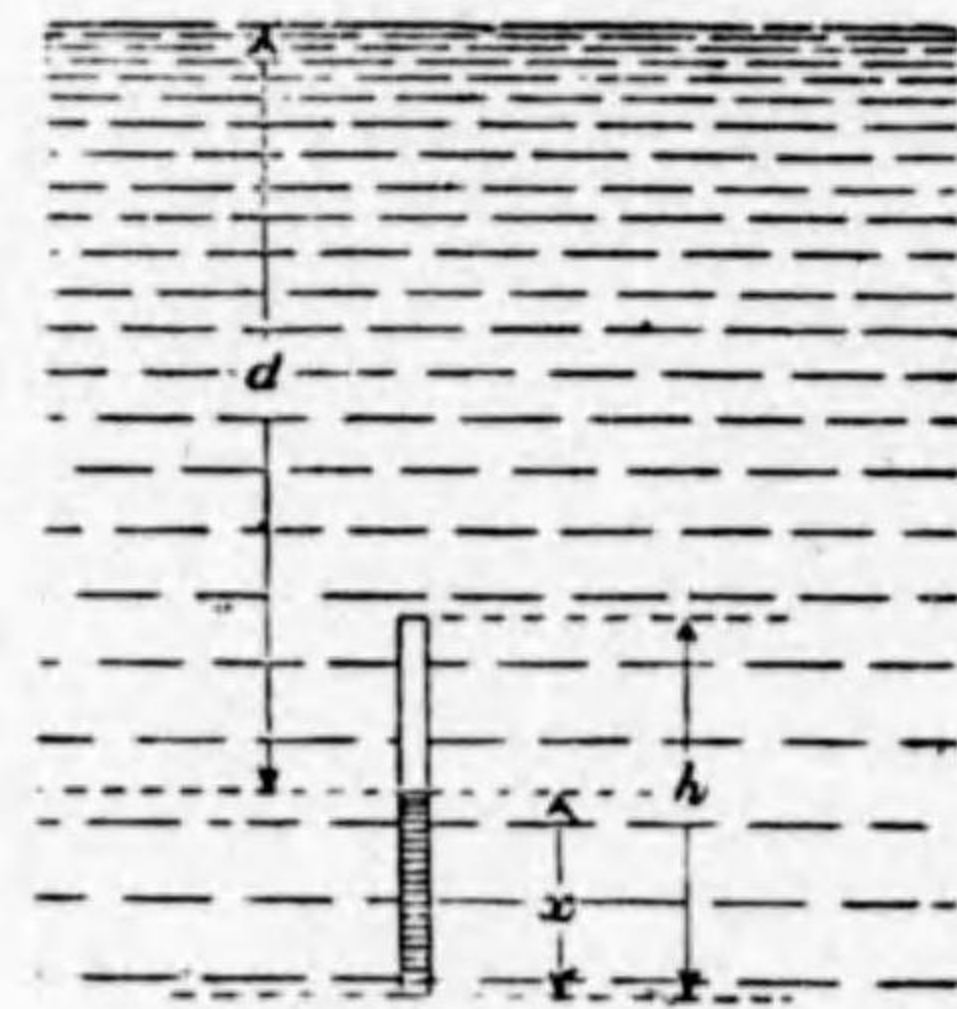

第二十三圖

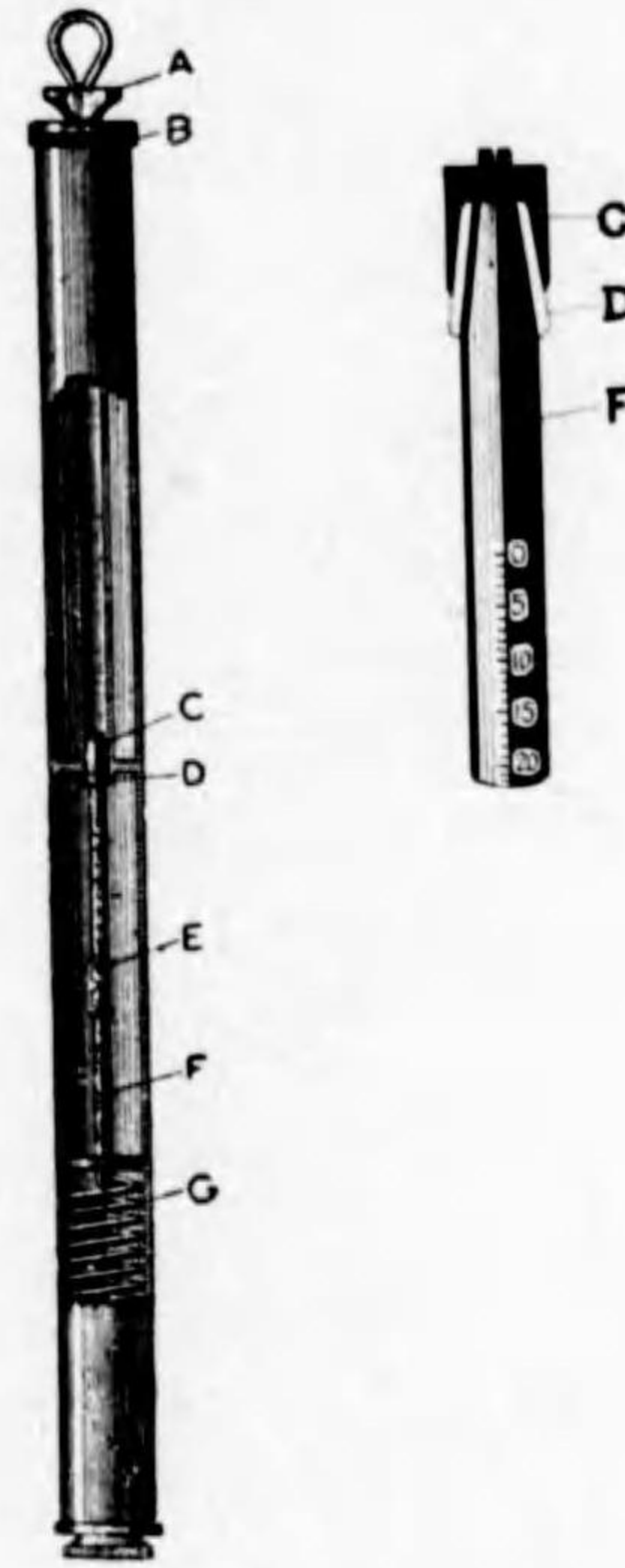

第二十四圖(甲)

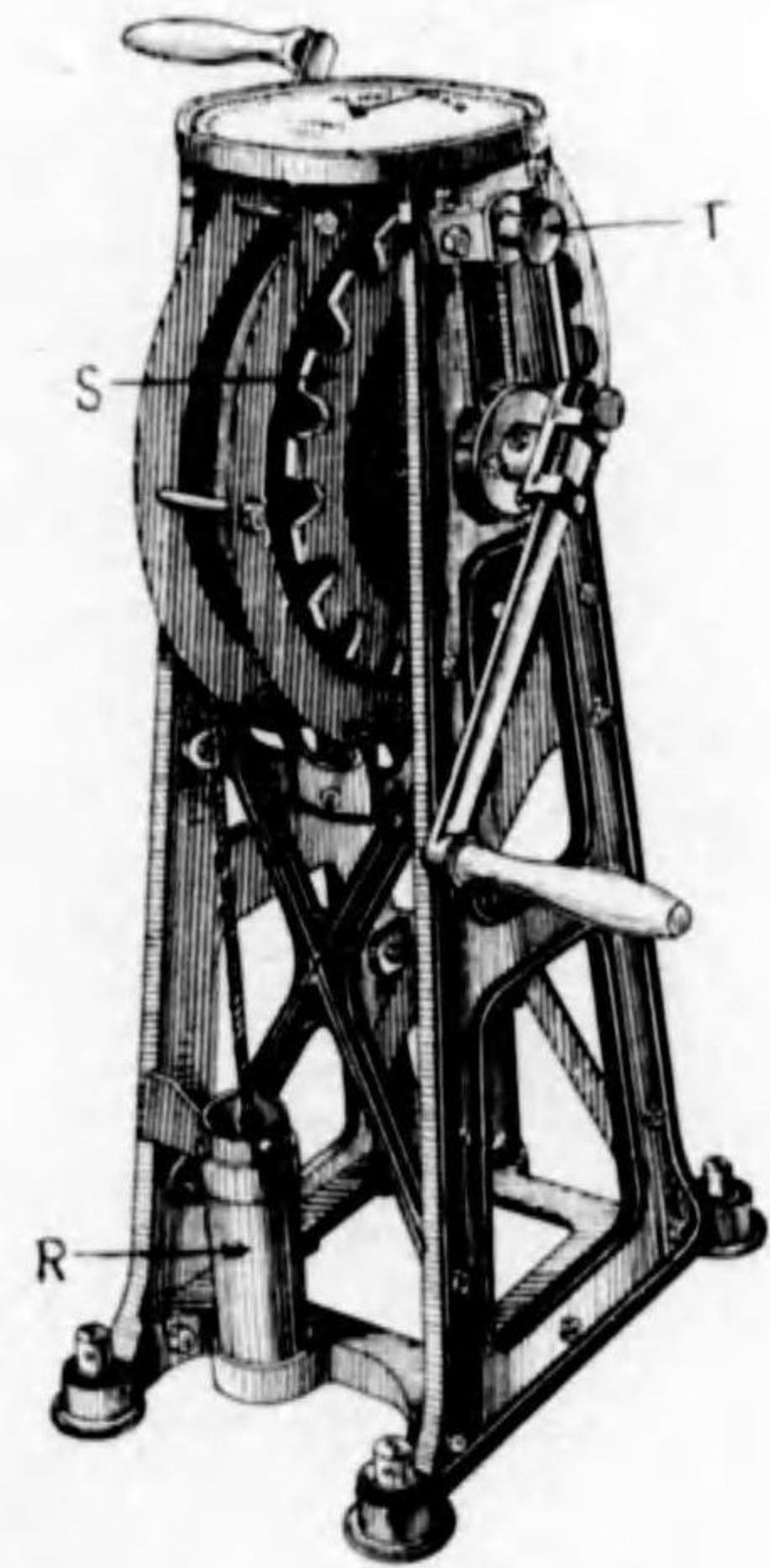

第二十四圖(乙)

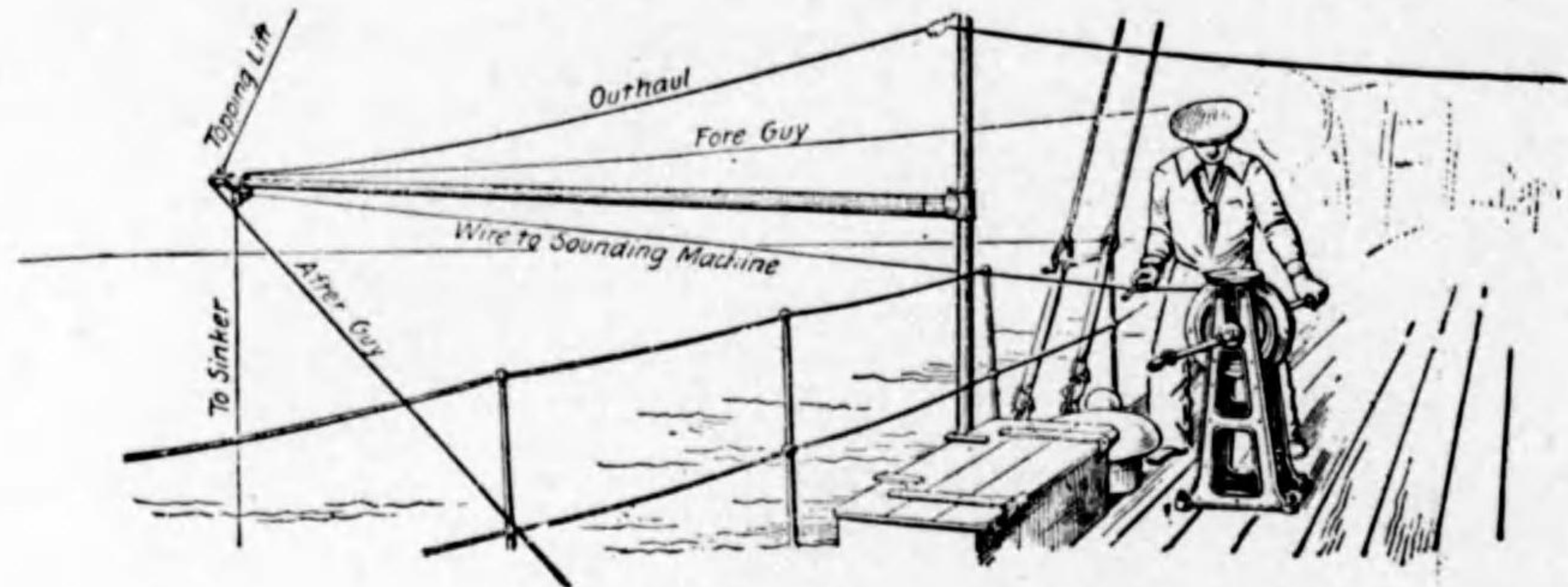

第二十四圖(丙)

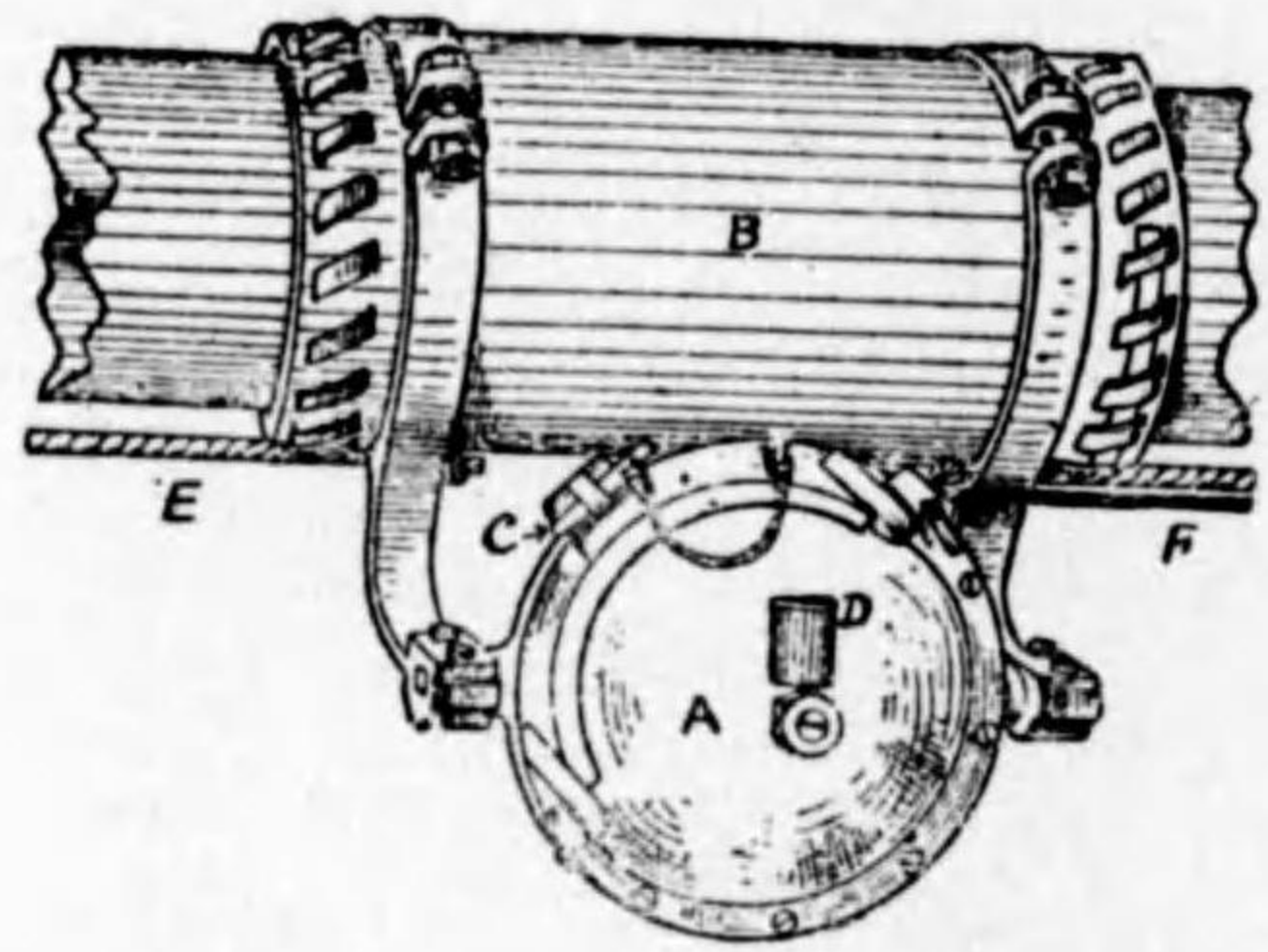

第二十五圖(甲)

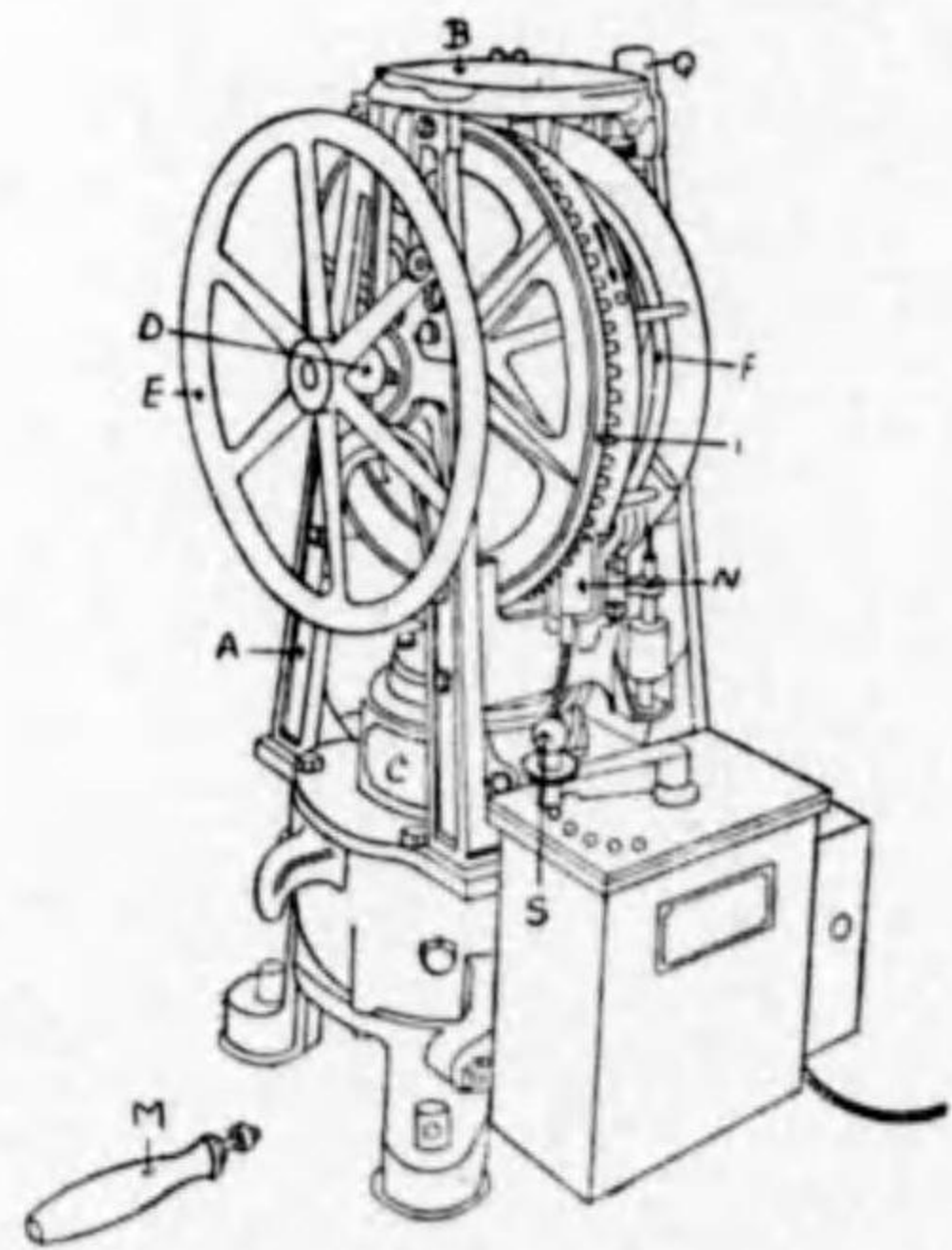

第二十五圖(乙)

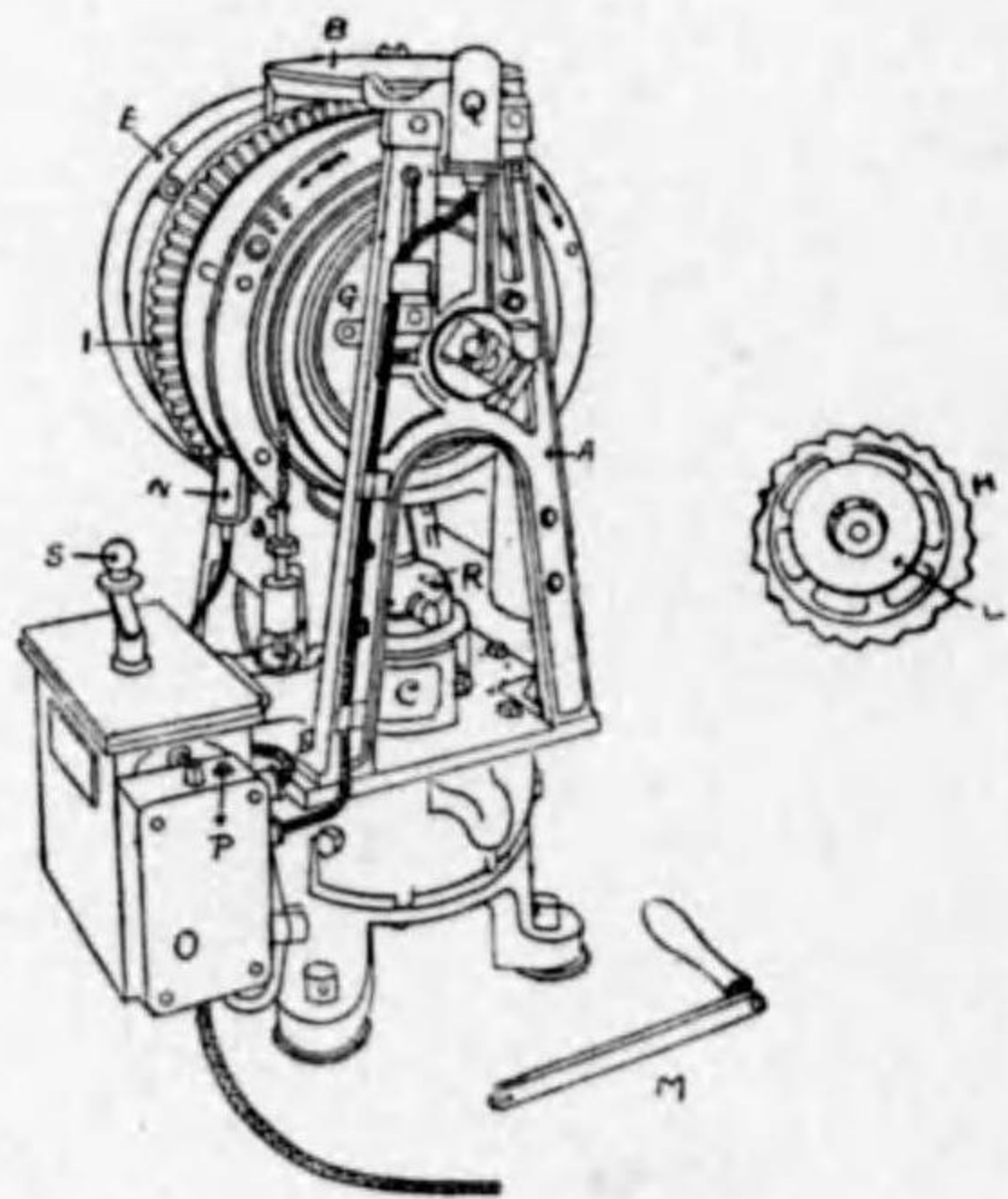

第二十五圖(丙)

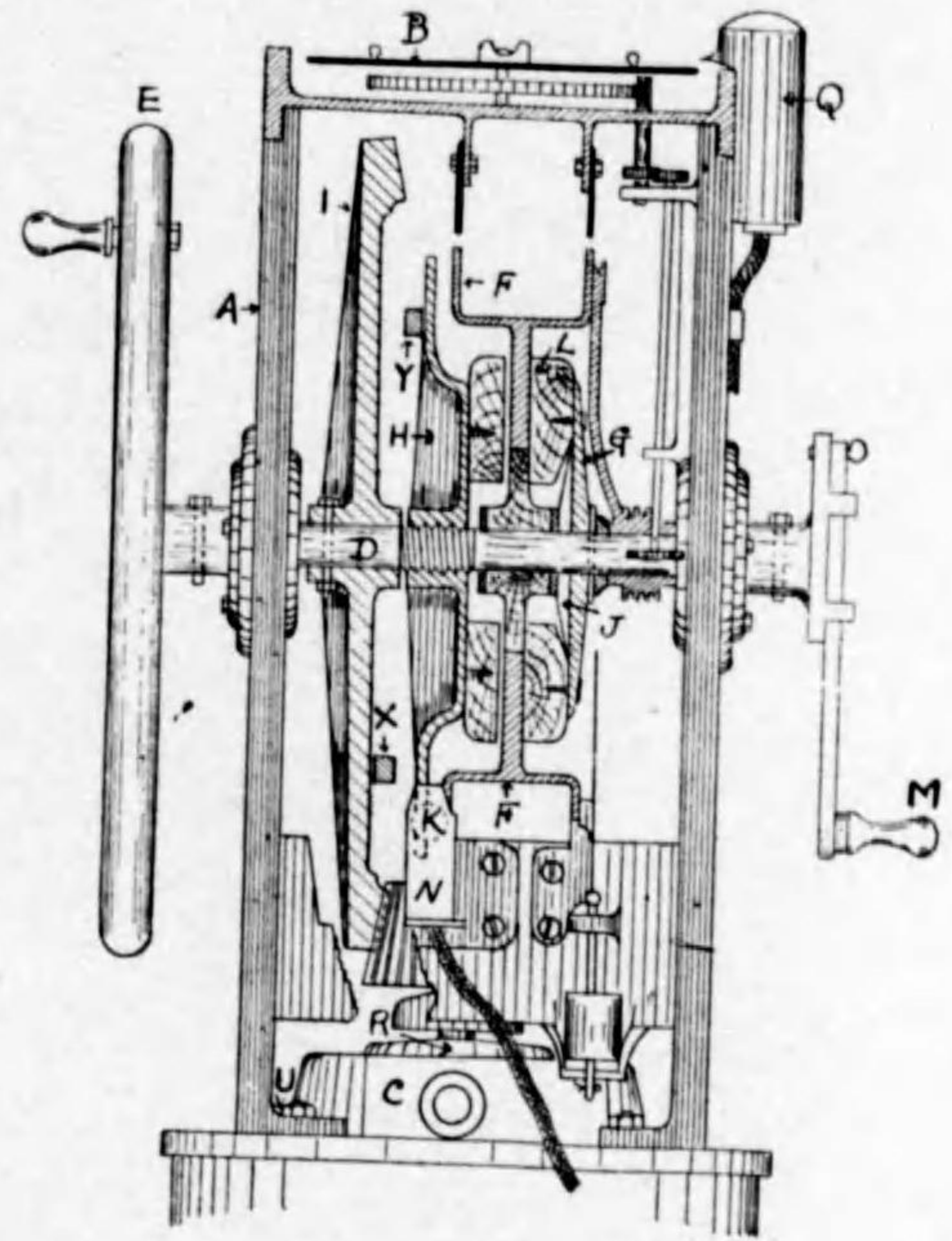

第二十五圖(丁)

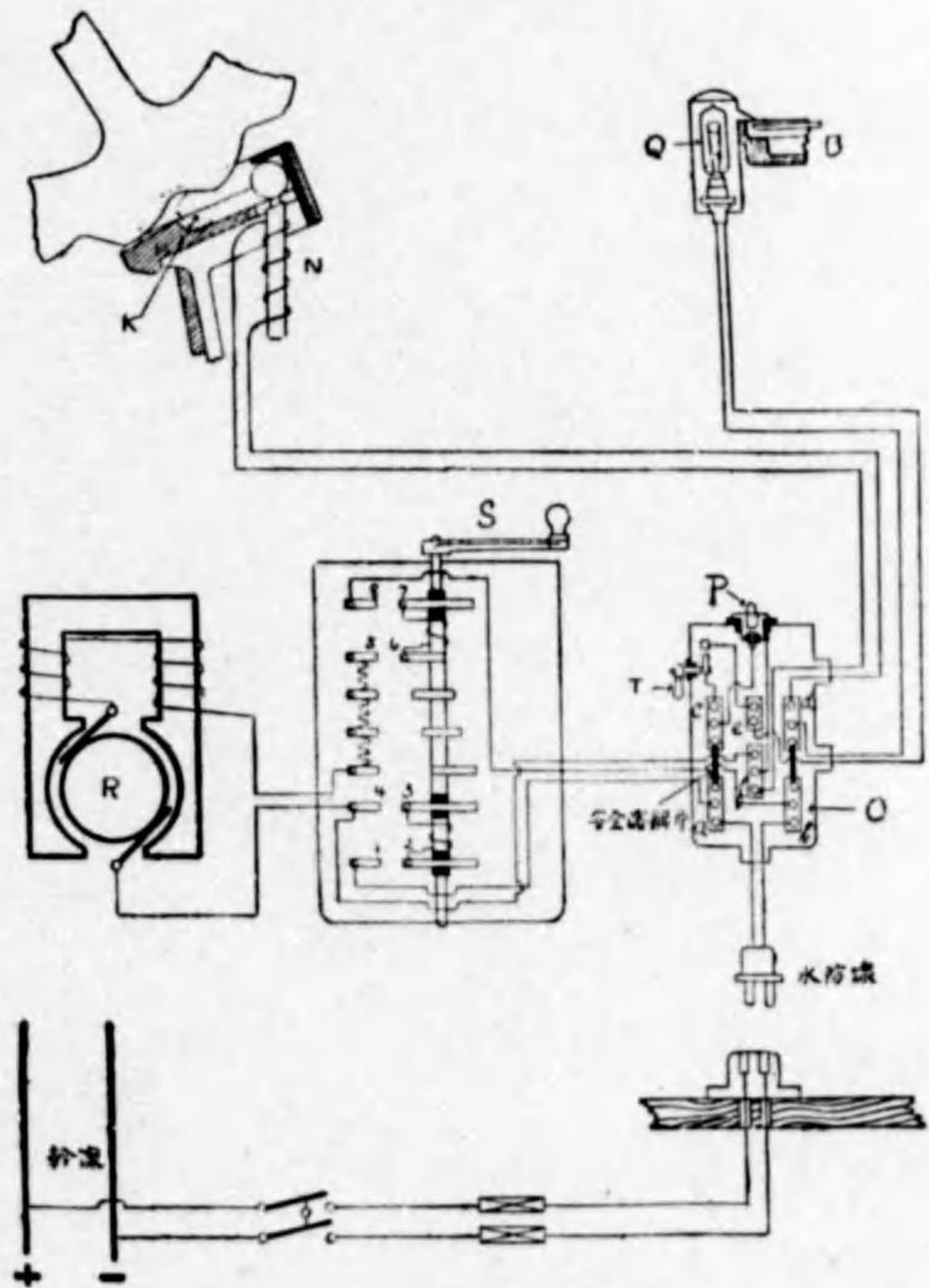

第二十六圖

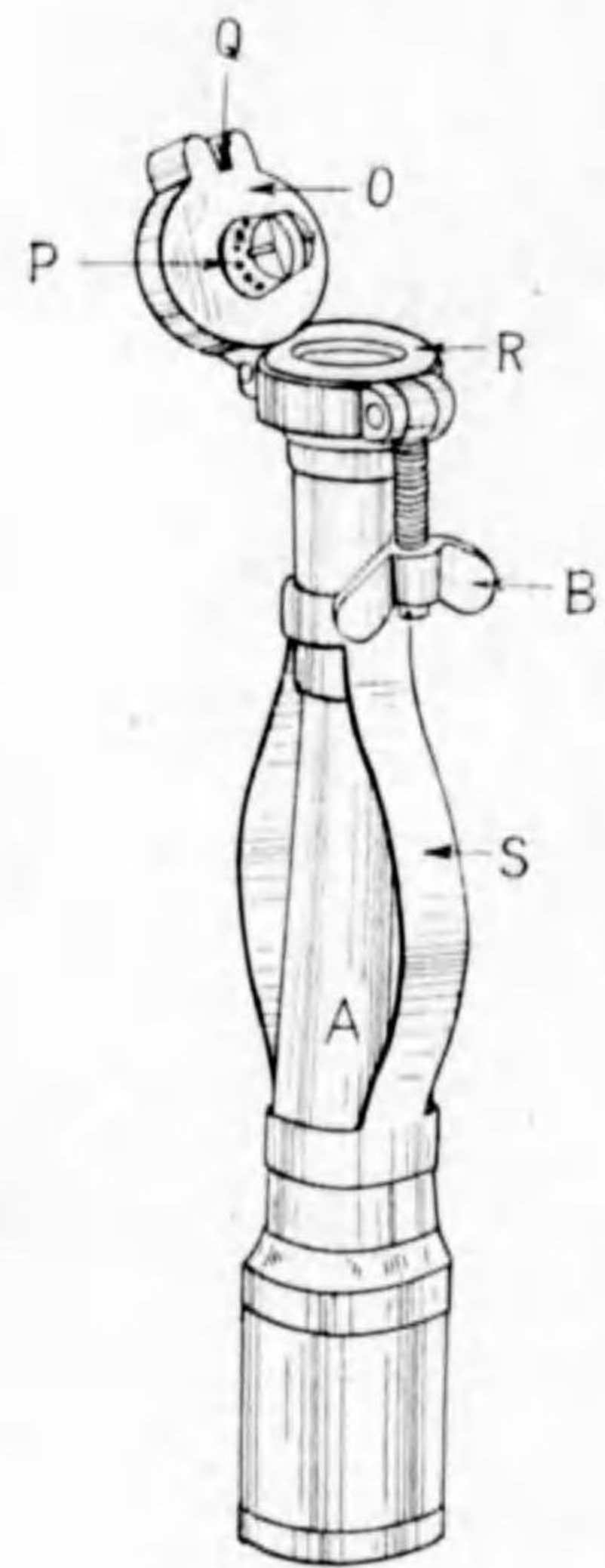

第二十七圖

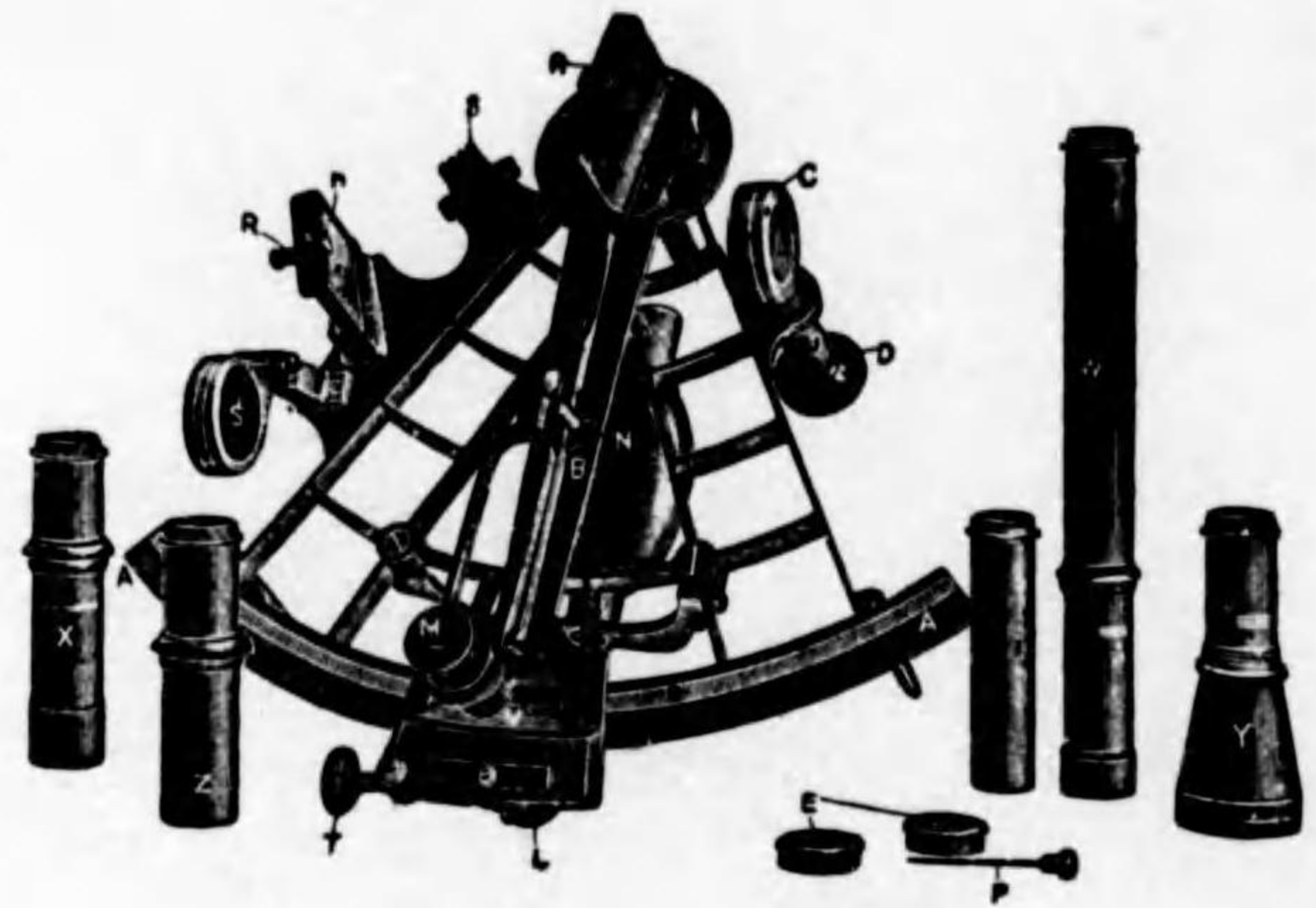

第二十八圖

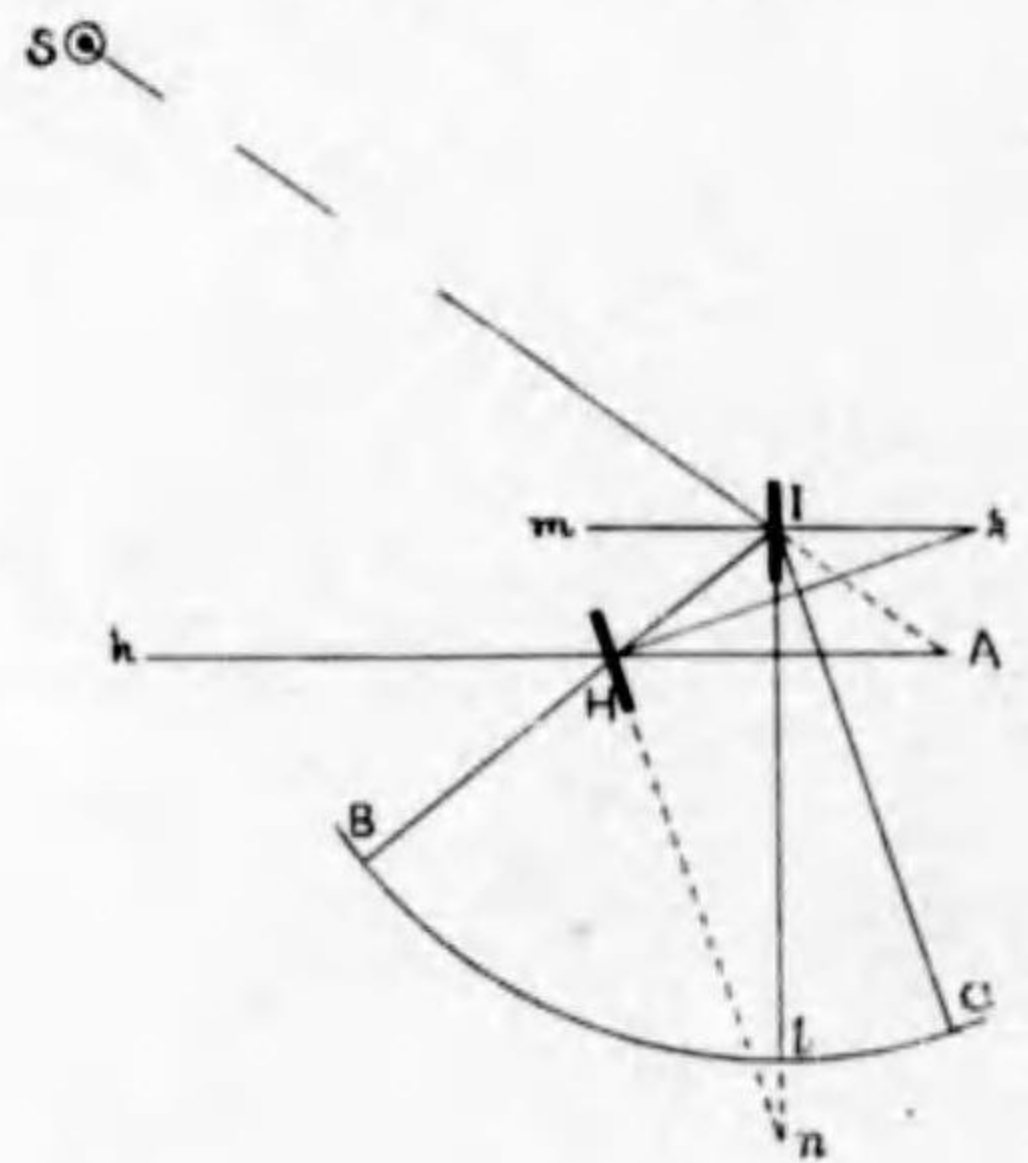

第二十九圖

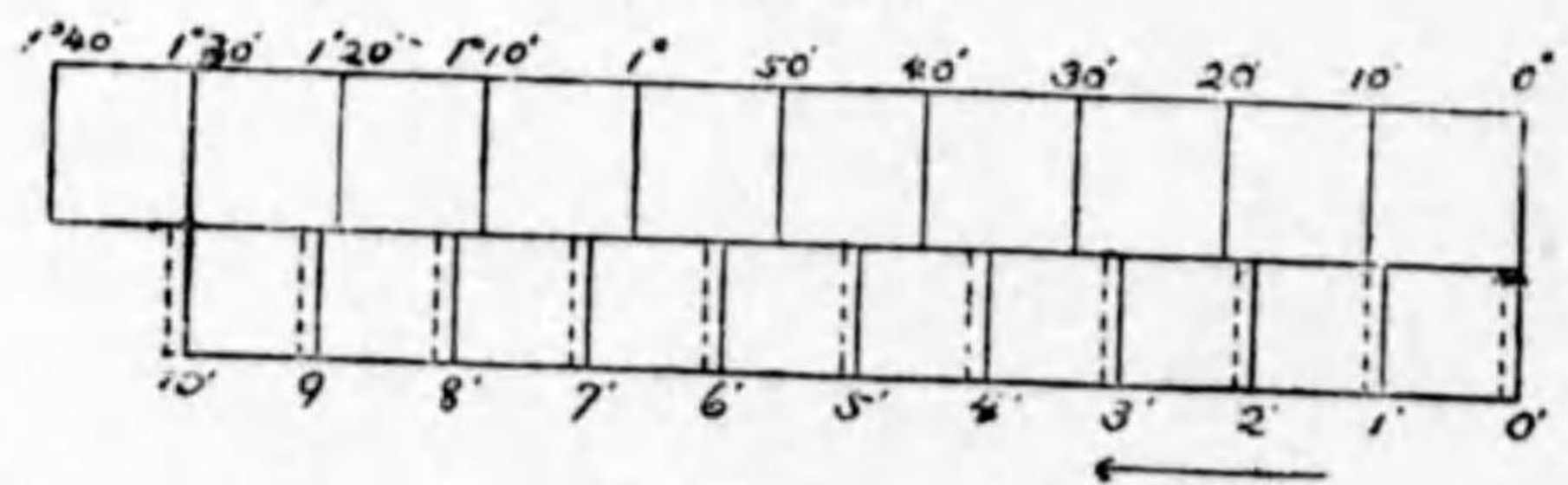

第三十圖 (甲)

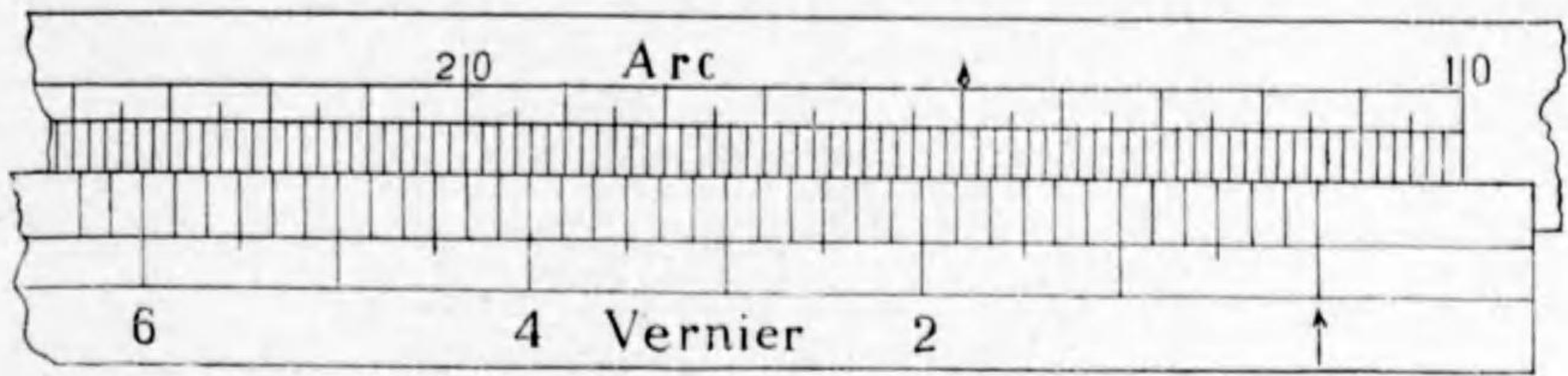

第三十圖 (乙)

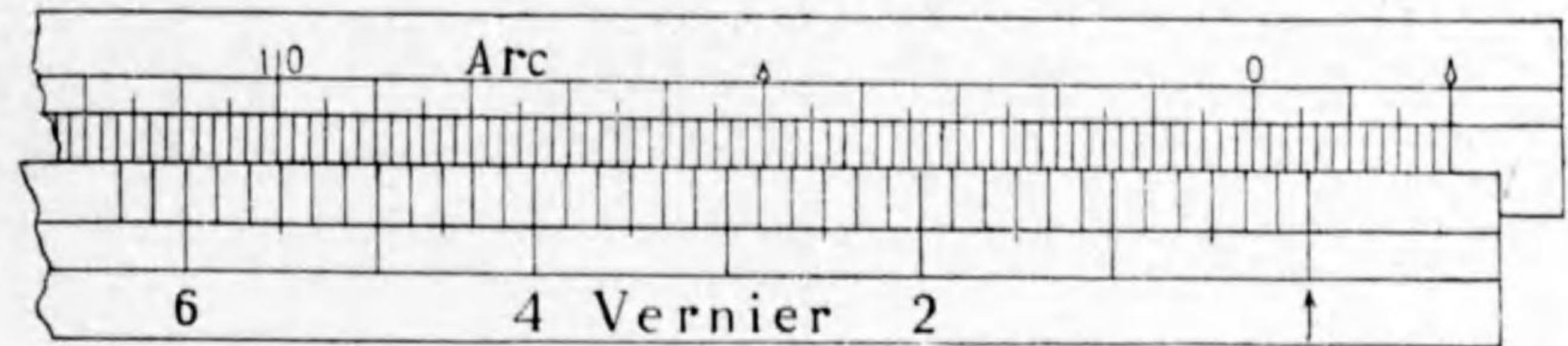

第三十一圖

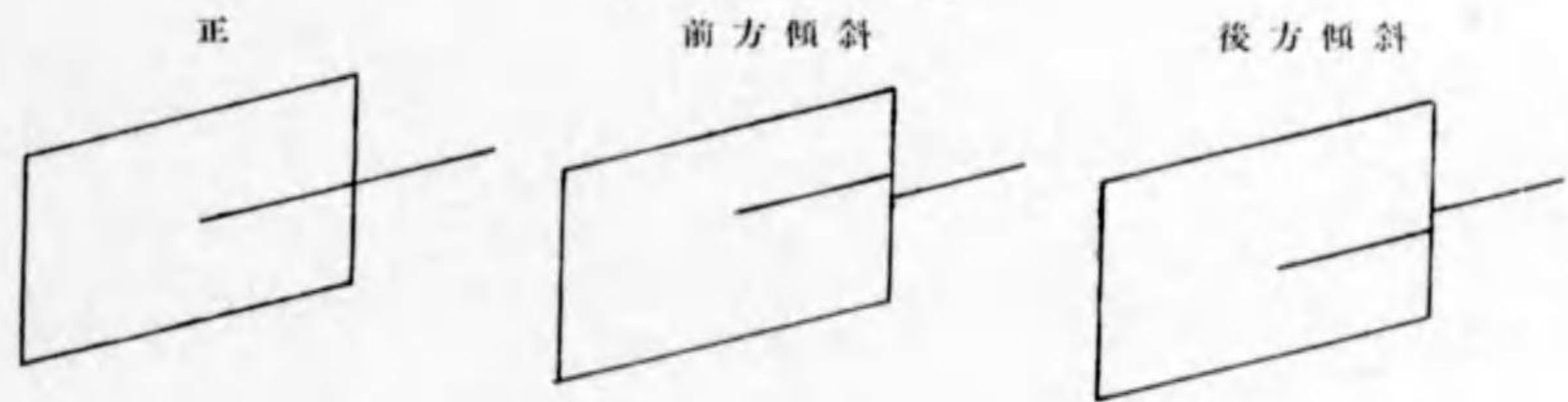

第三十二圖

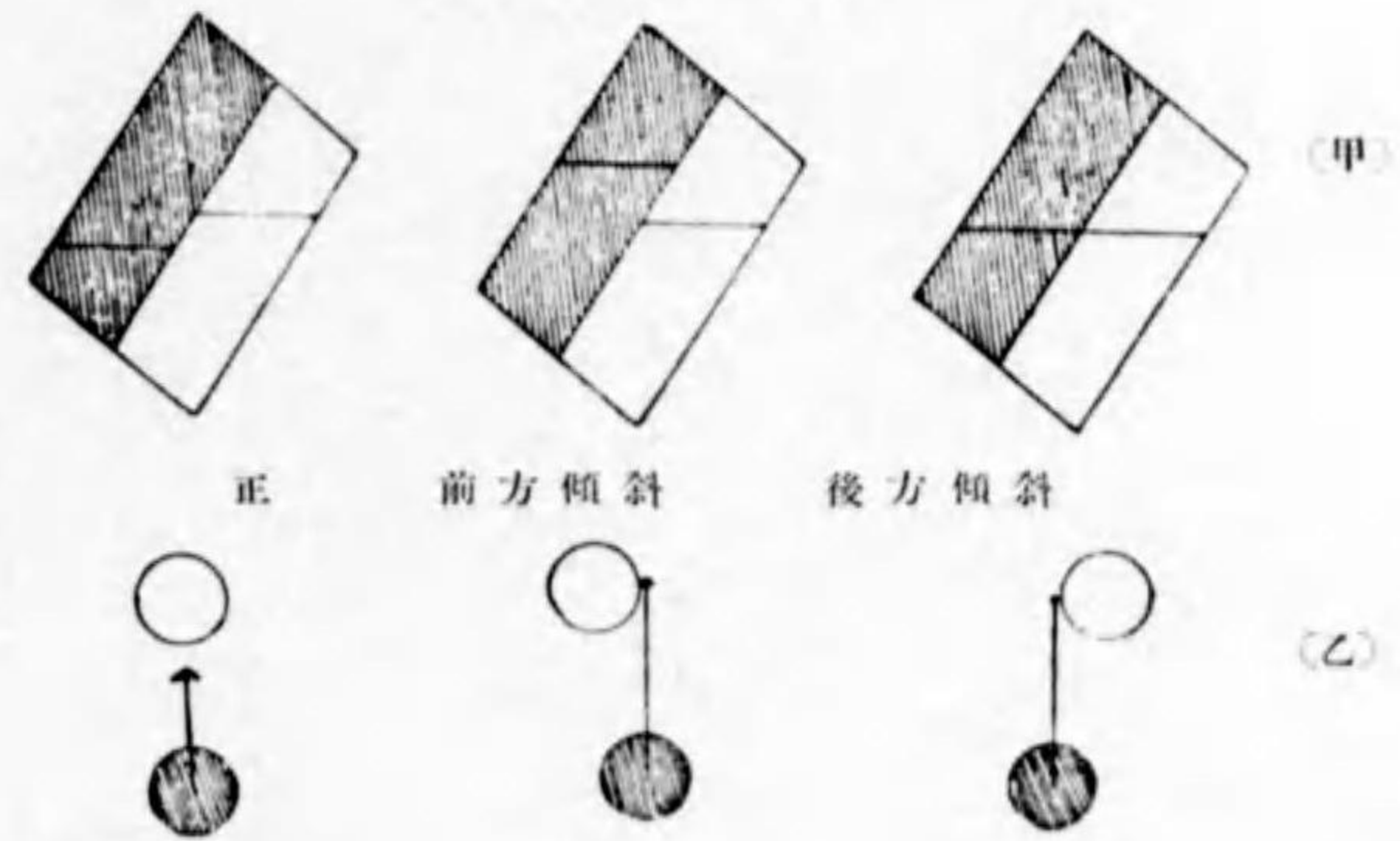

第三十三圖

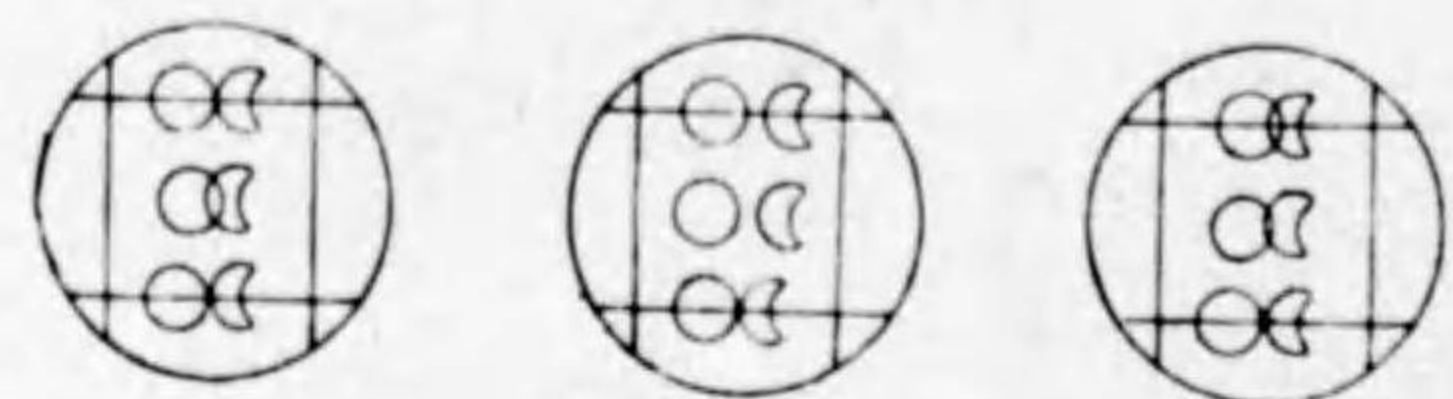

第三十四圖(乙)

第三十四圖(甲)

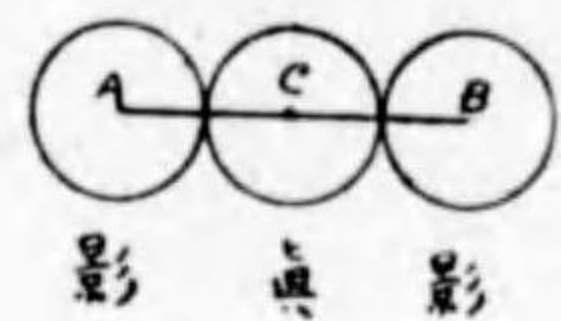

第三十五圖(甲)

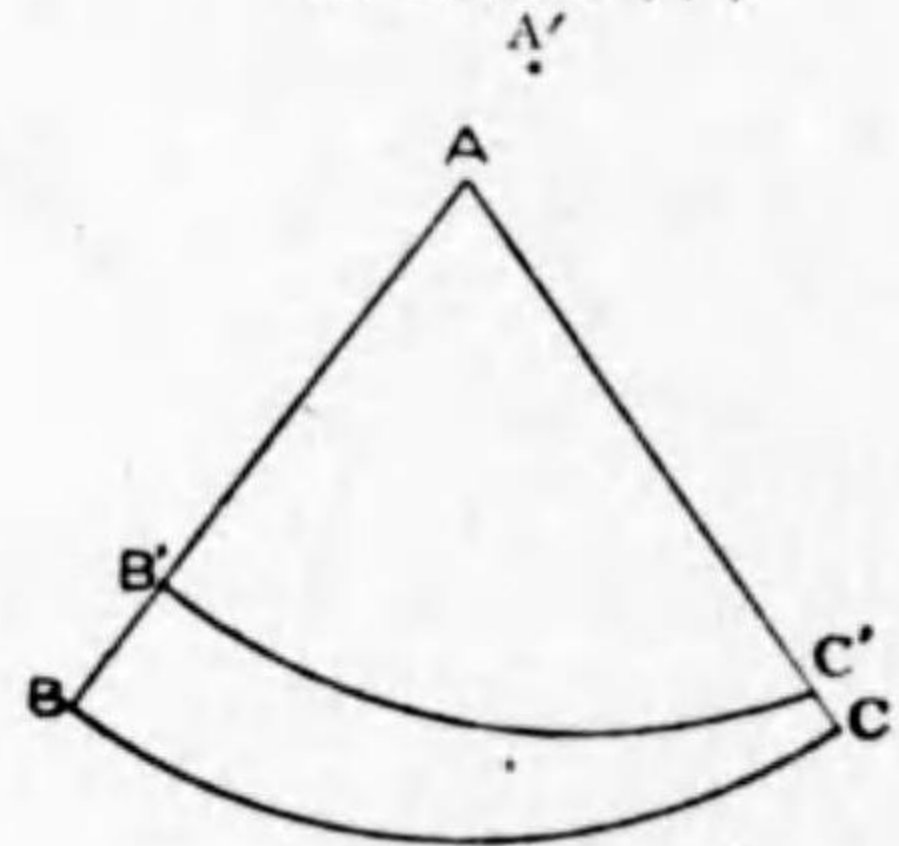

第三十六圖

第三十五圖(乙)

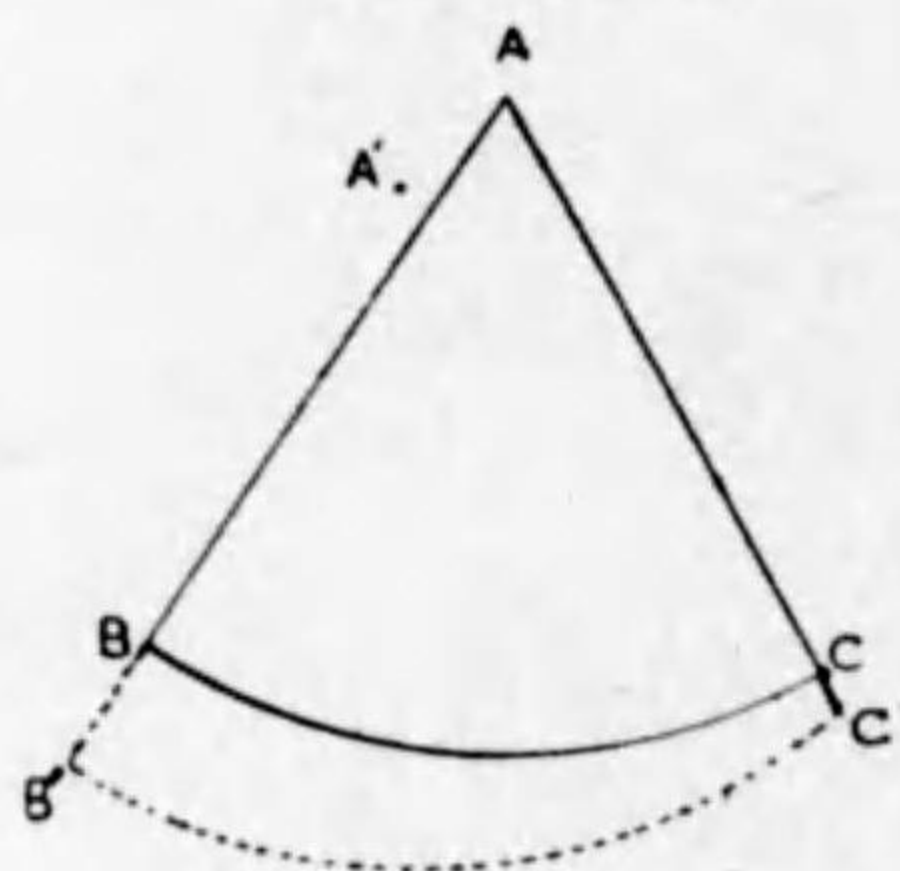

第三十七圖

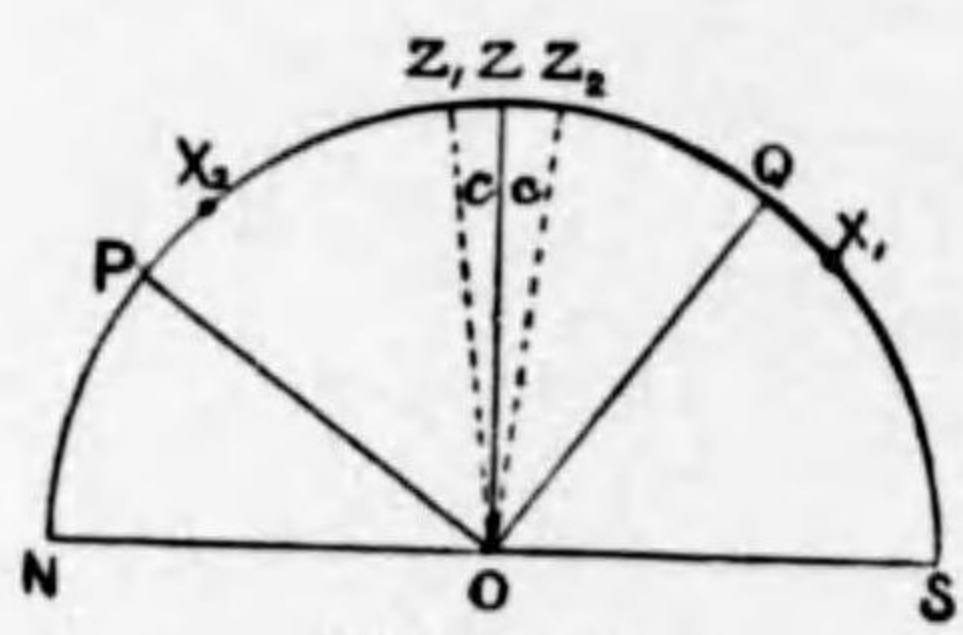
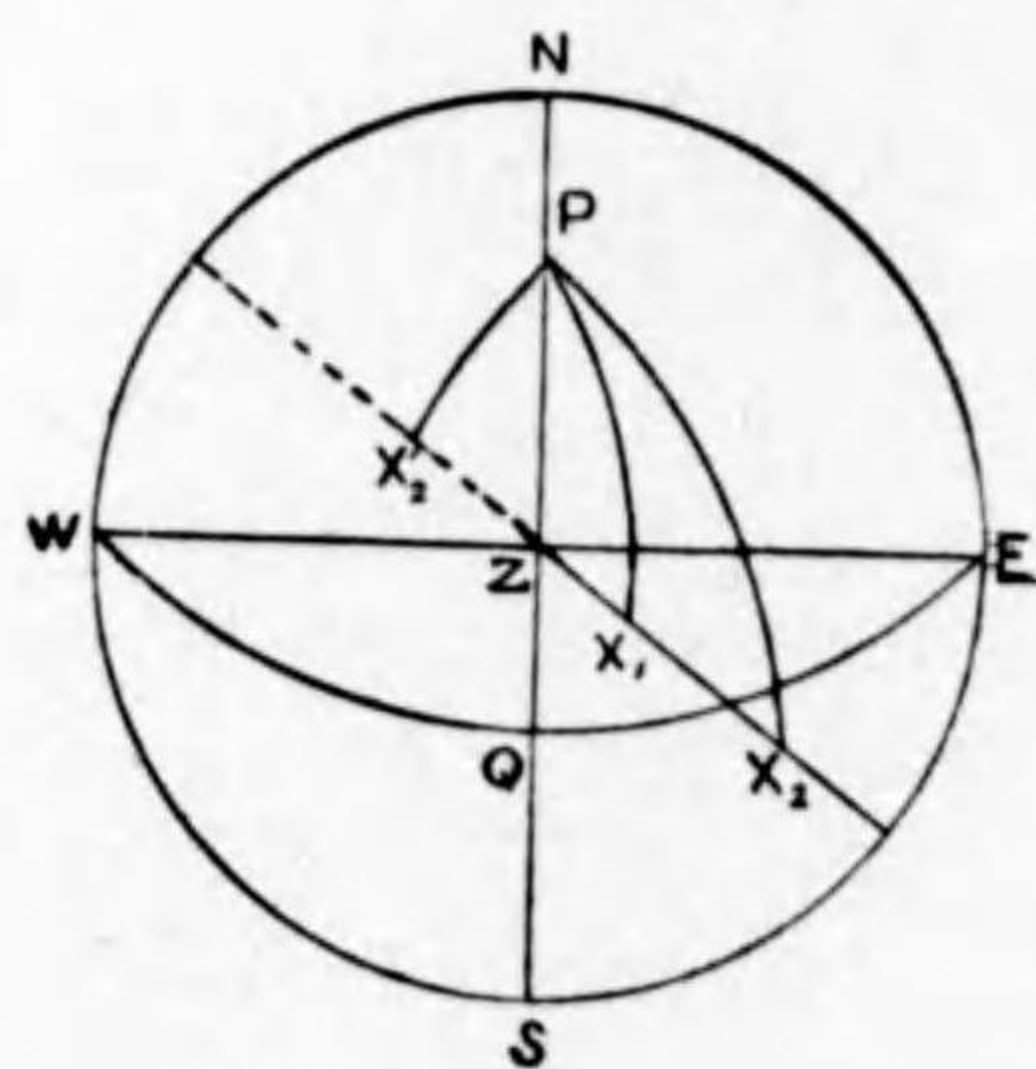

第三十八圖

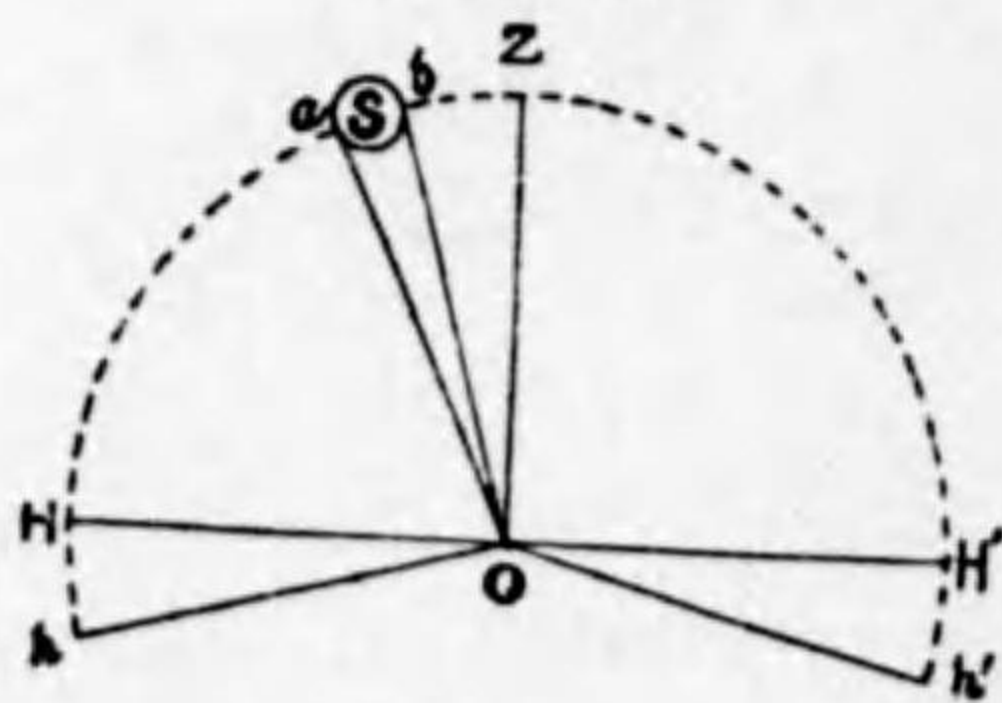

第三十九圖(甲)

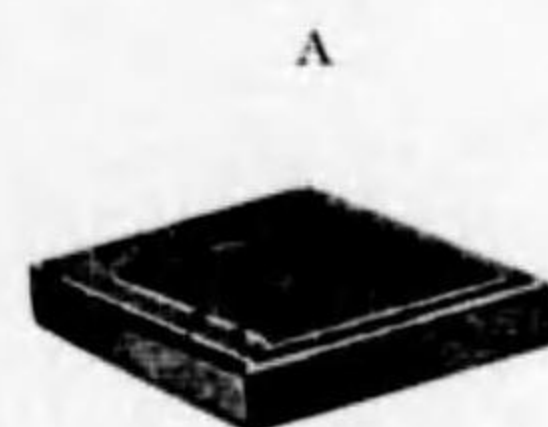
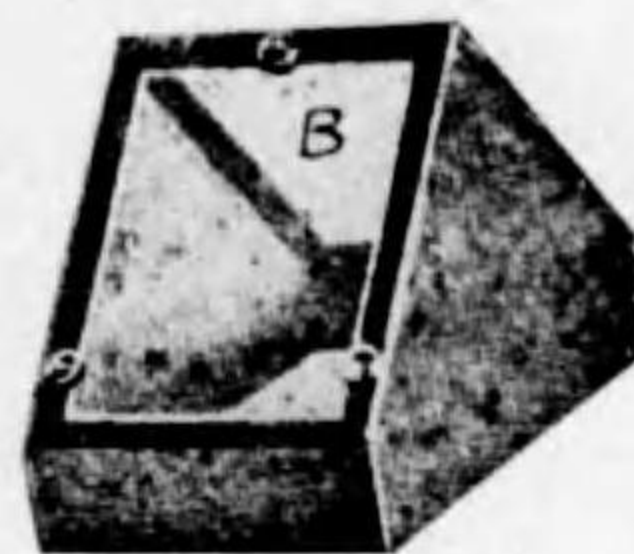
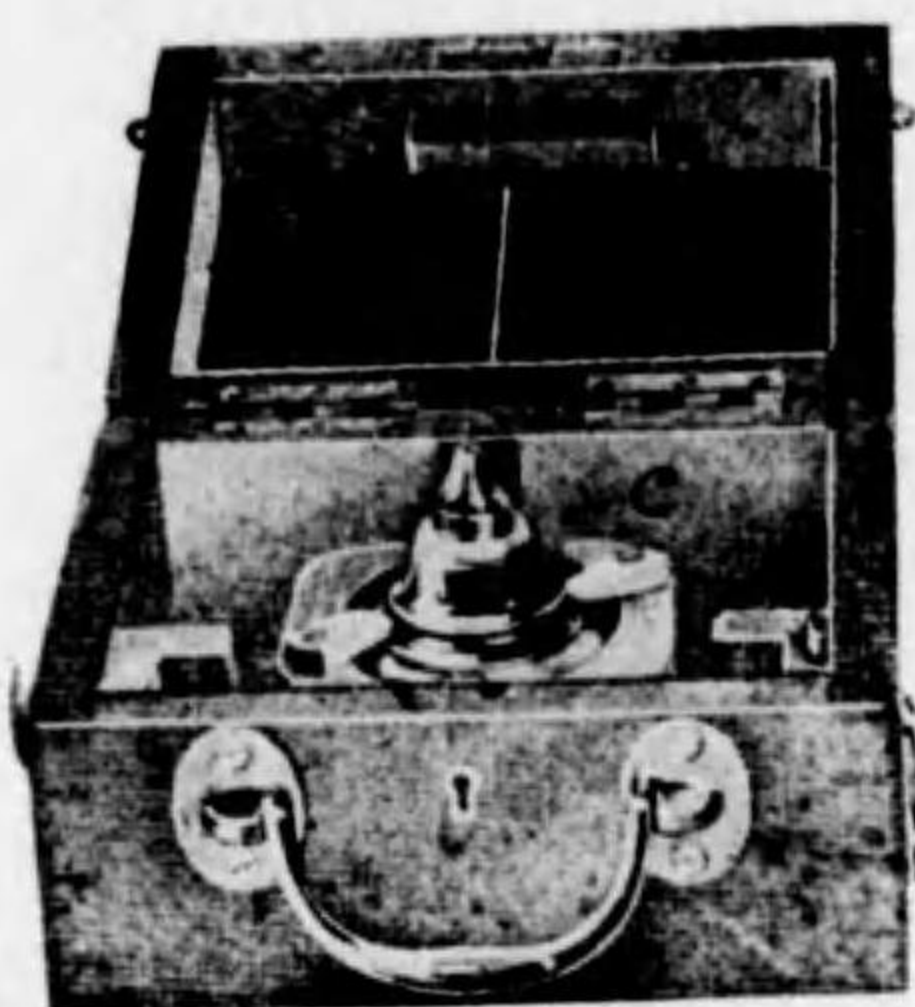

第三十九圖(乙)



第四十圖

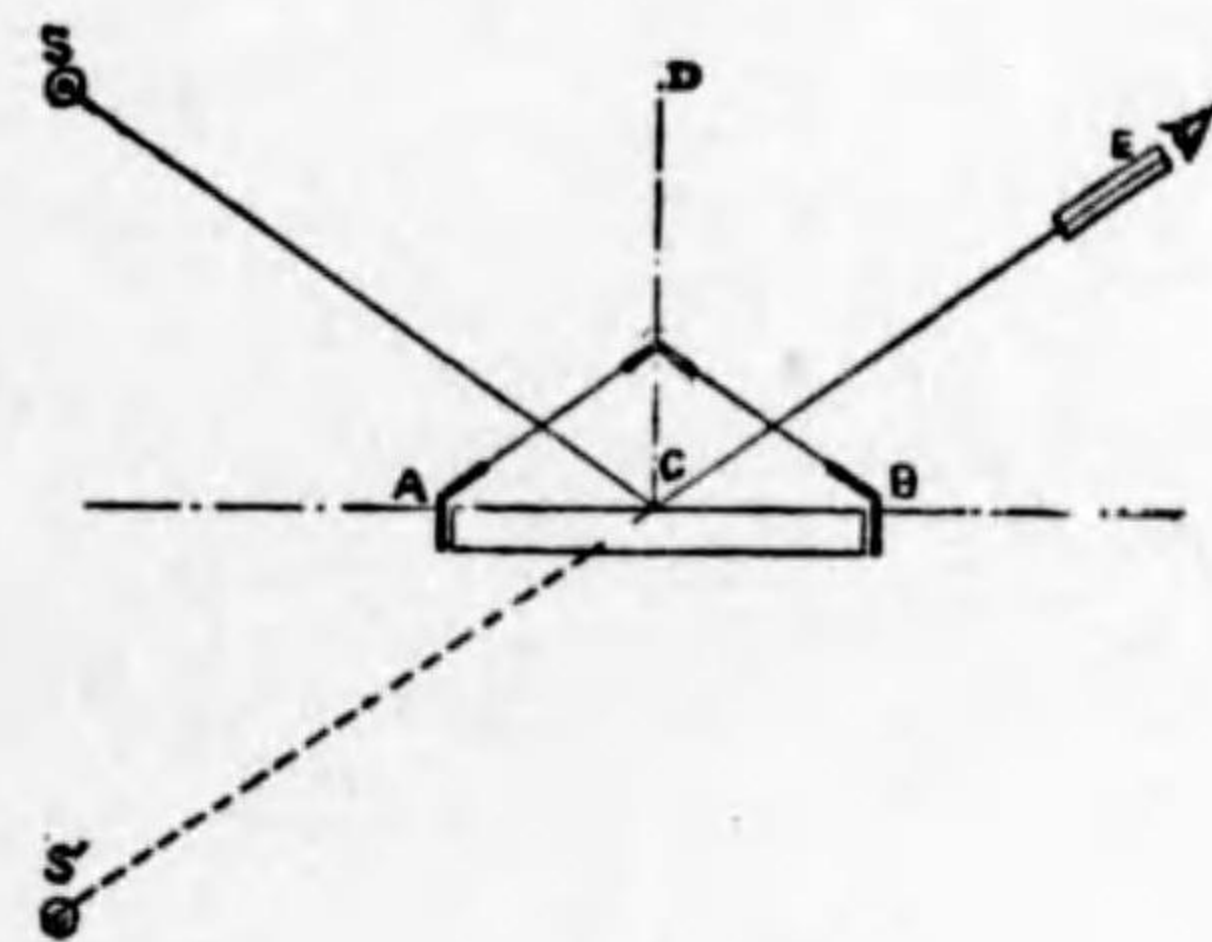

第四十一圖

午前

午後

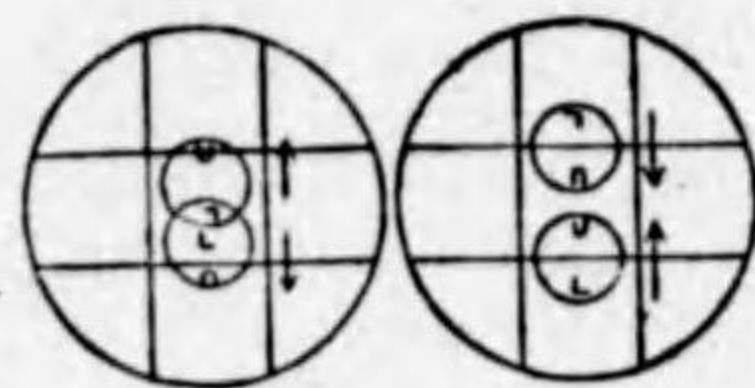

下邊

上邊

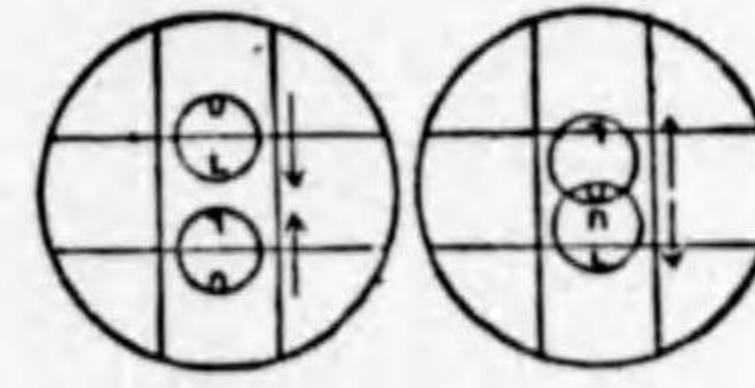

下邊

上邊

第四十二圖(甲)

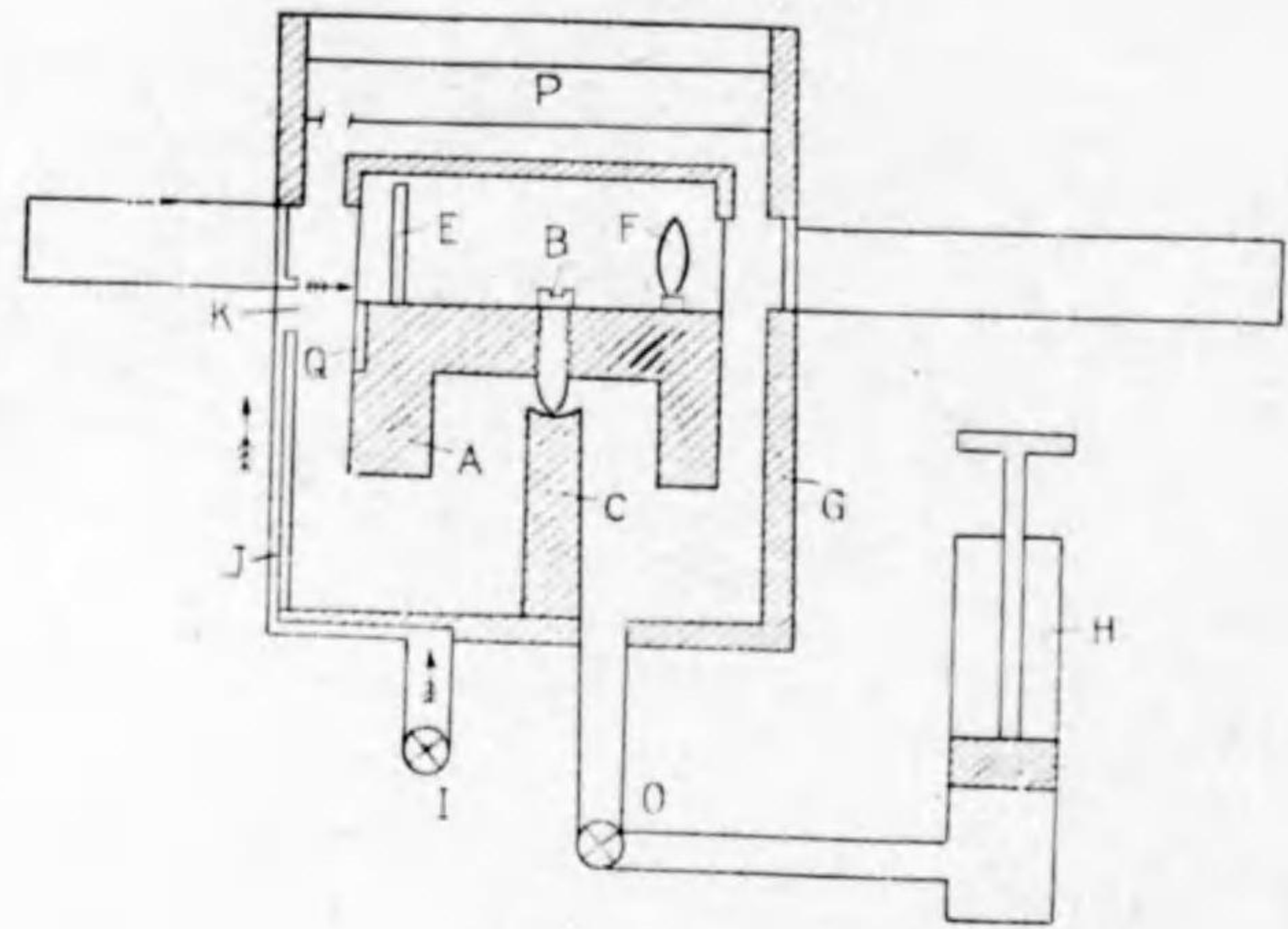

第四十二圖(乙)

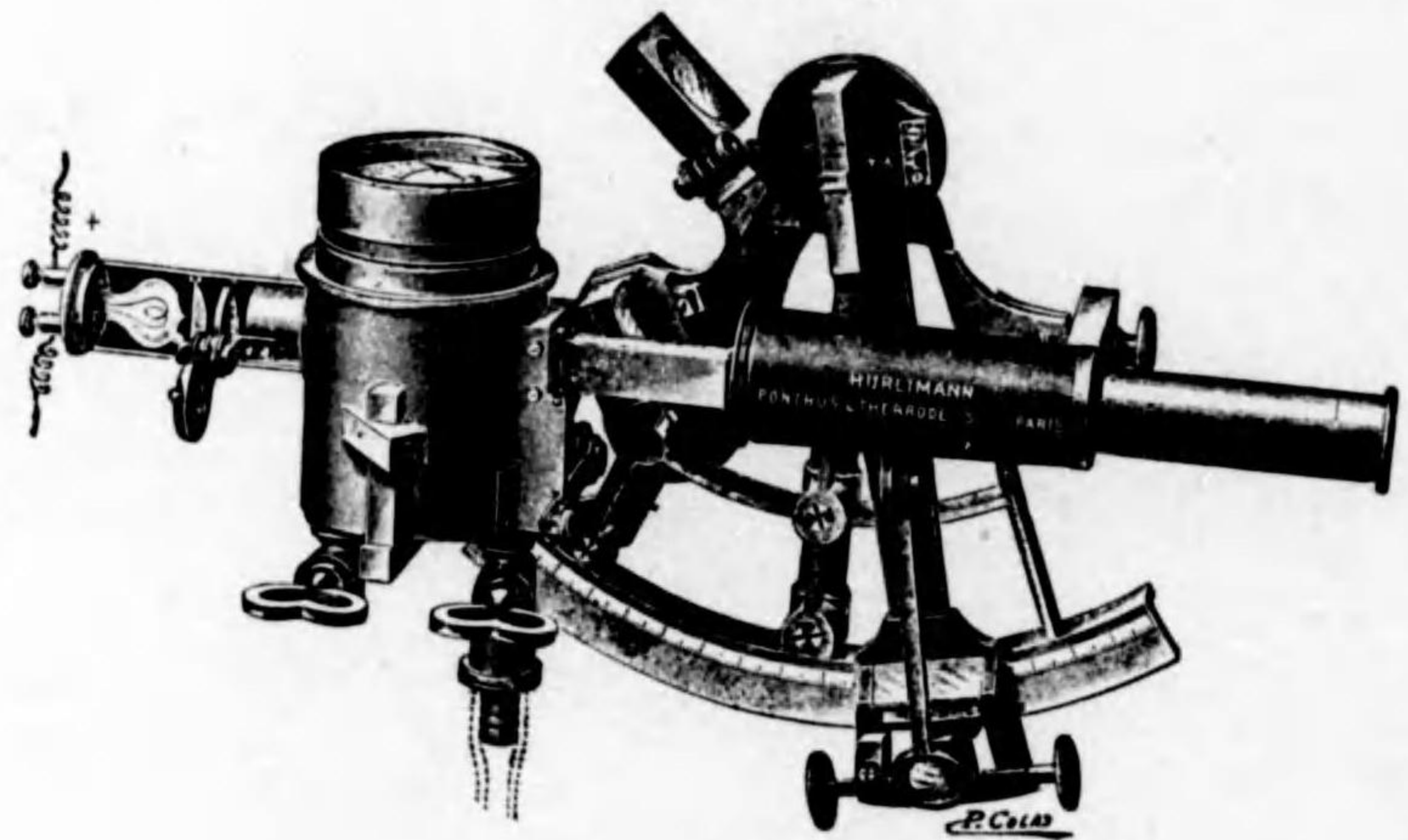

第四十三圖(甲)

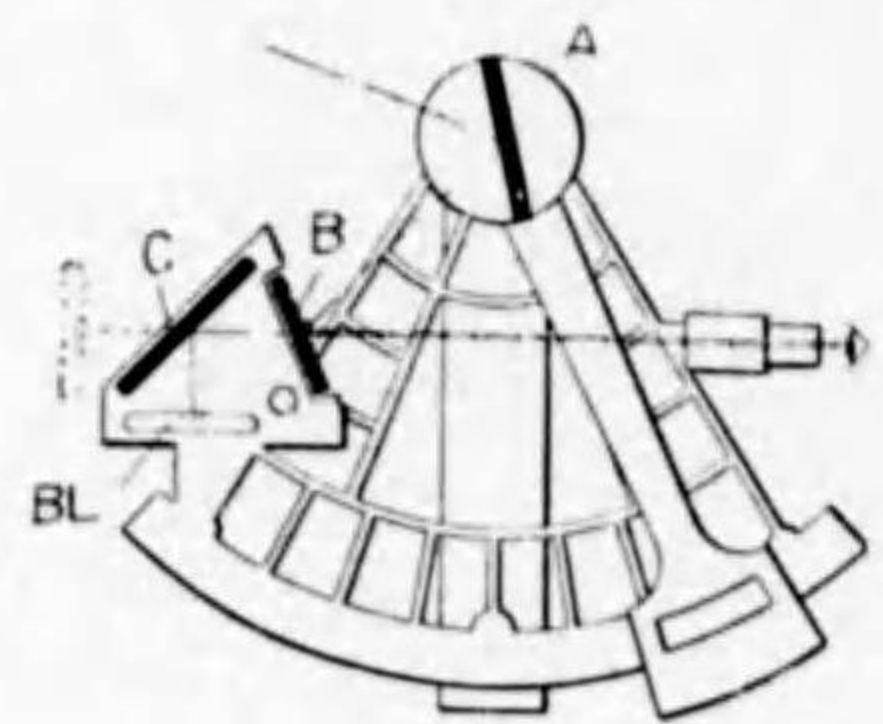

第四十四圖

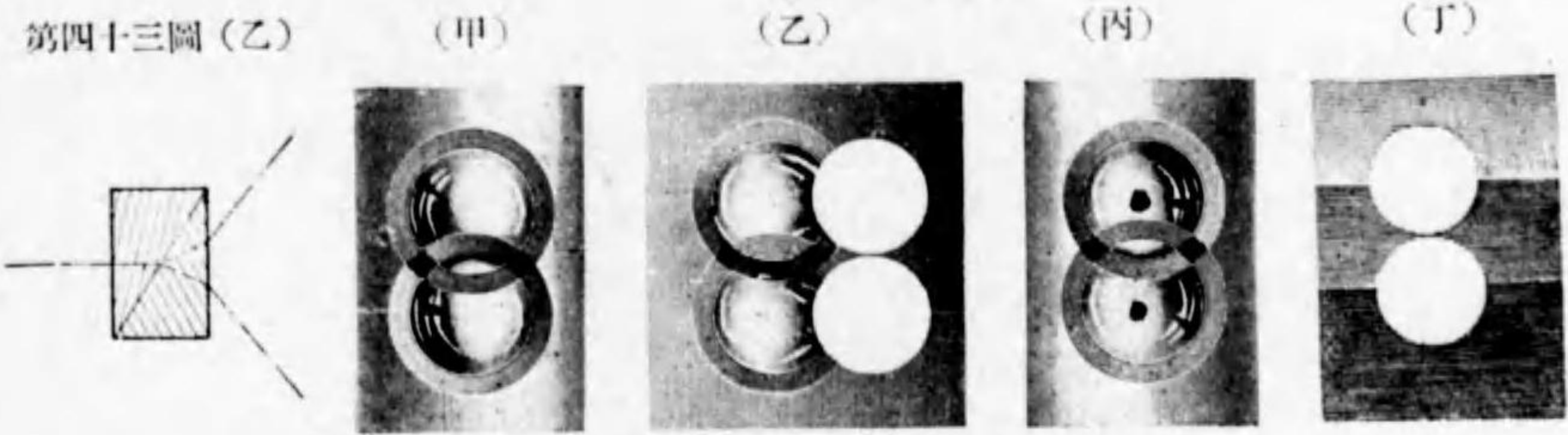

第四十五圖(甲)

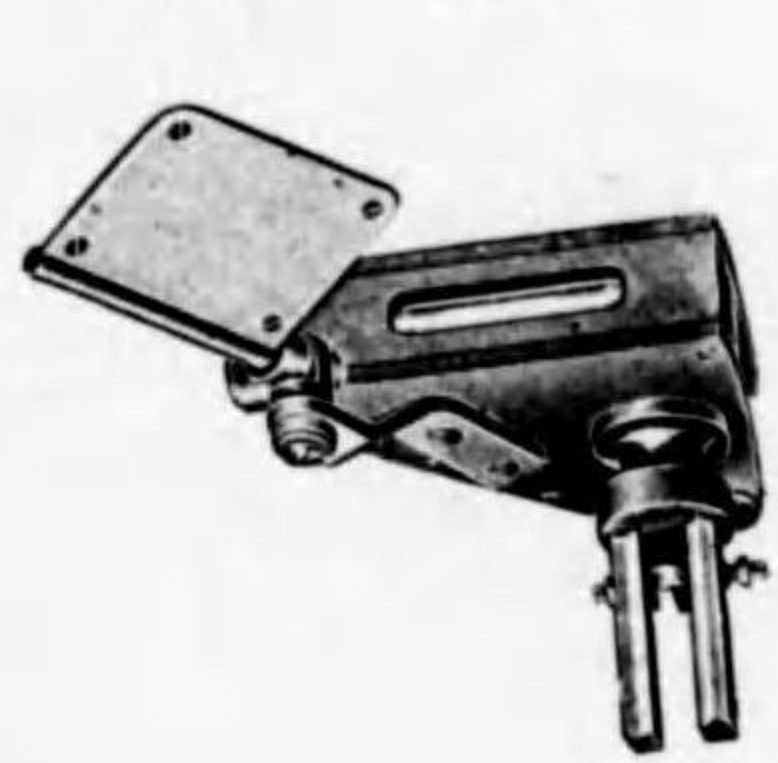

第四十五圖(乙)

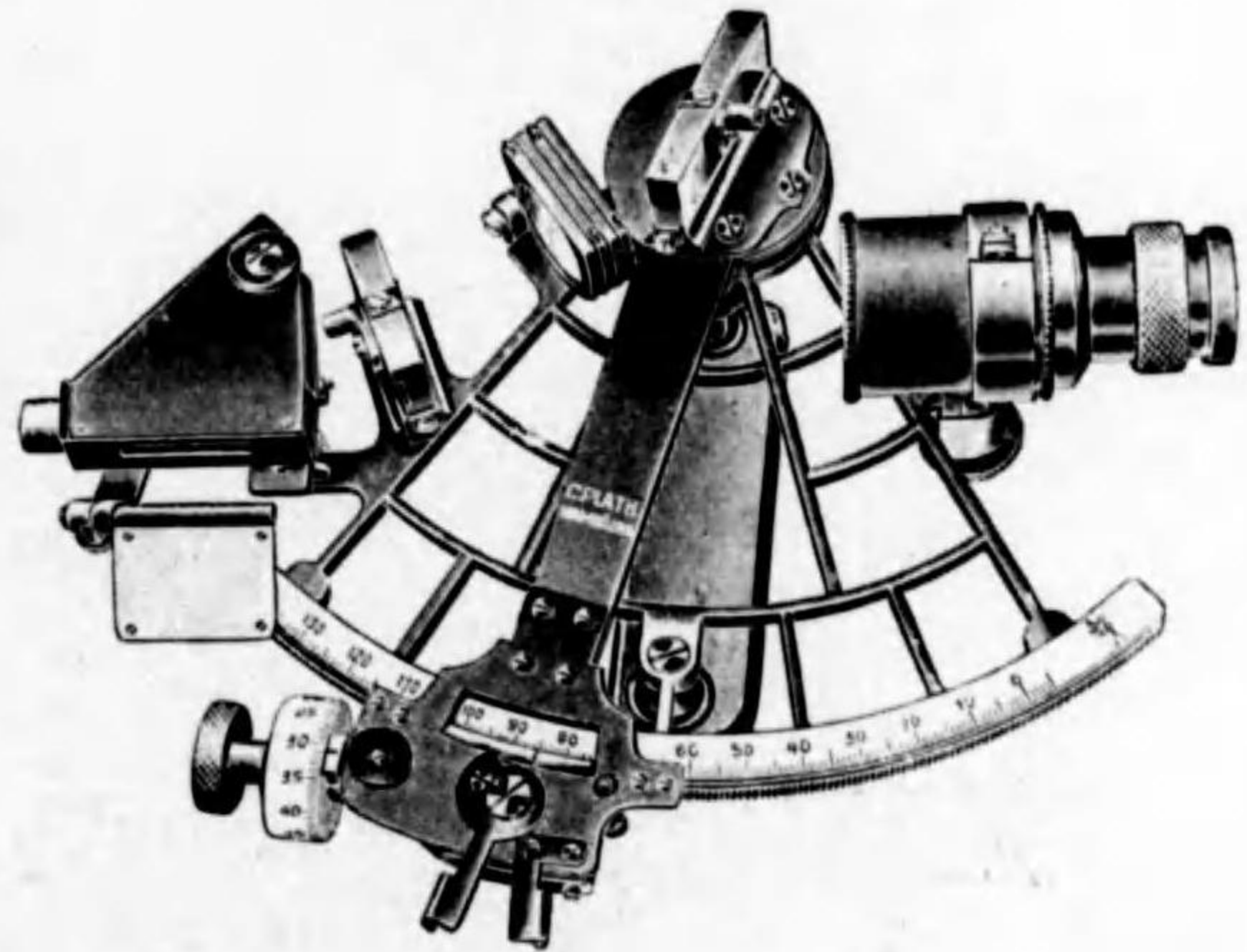

第四十六圖

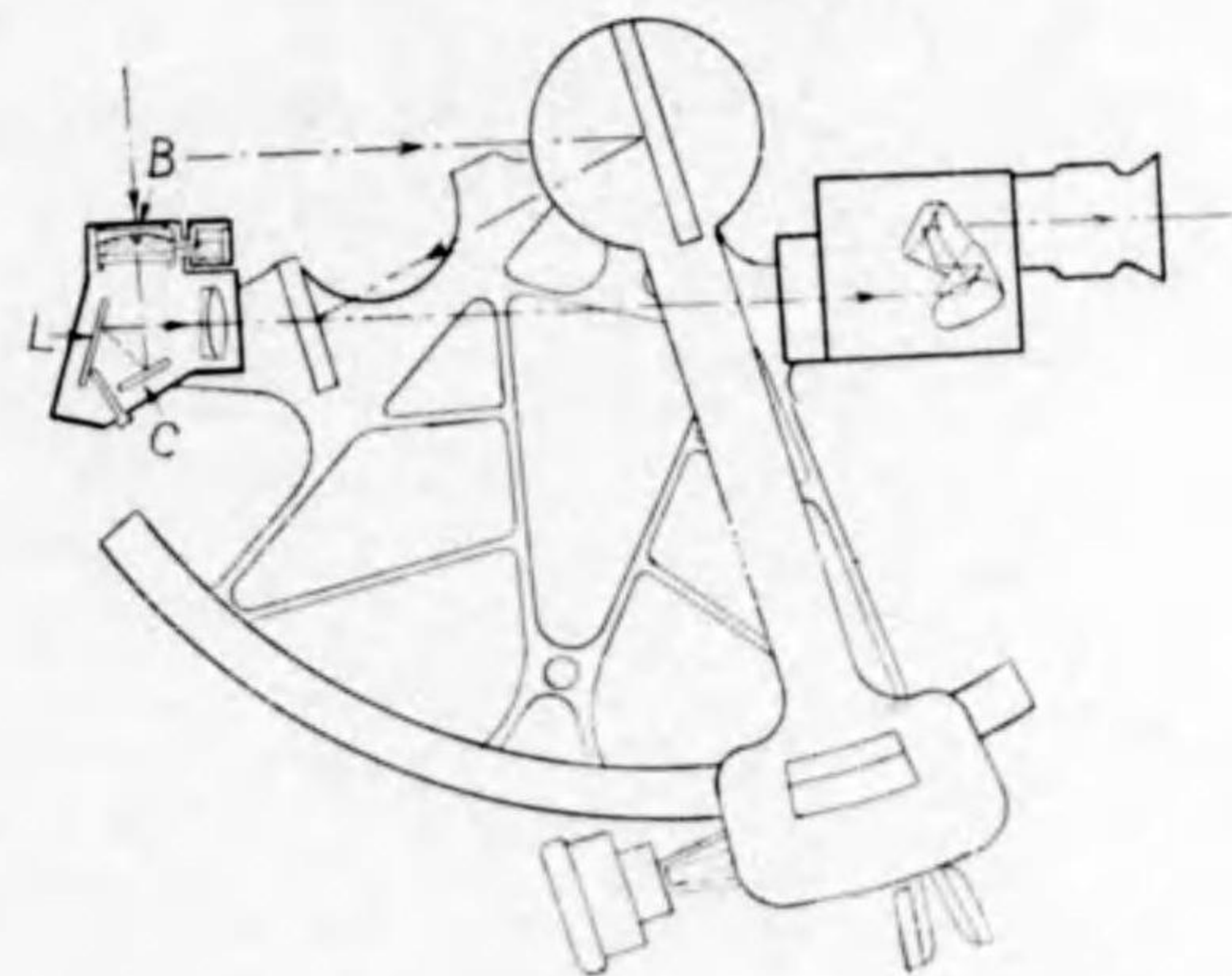

第四十七圖

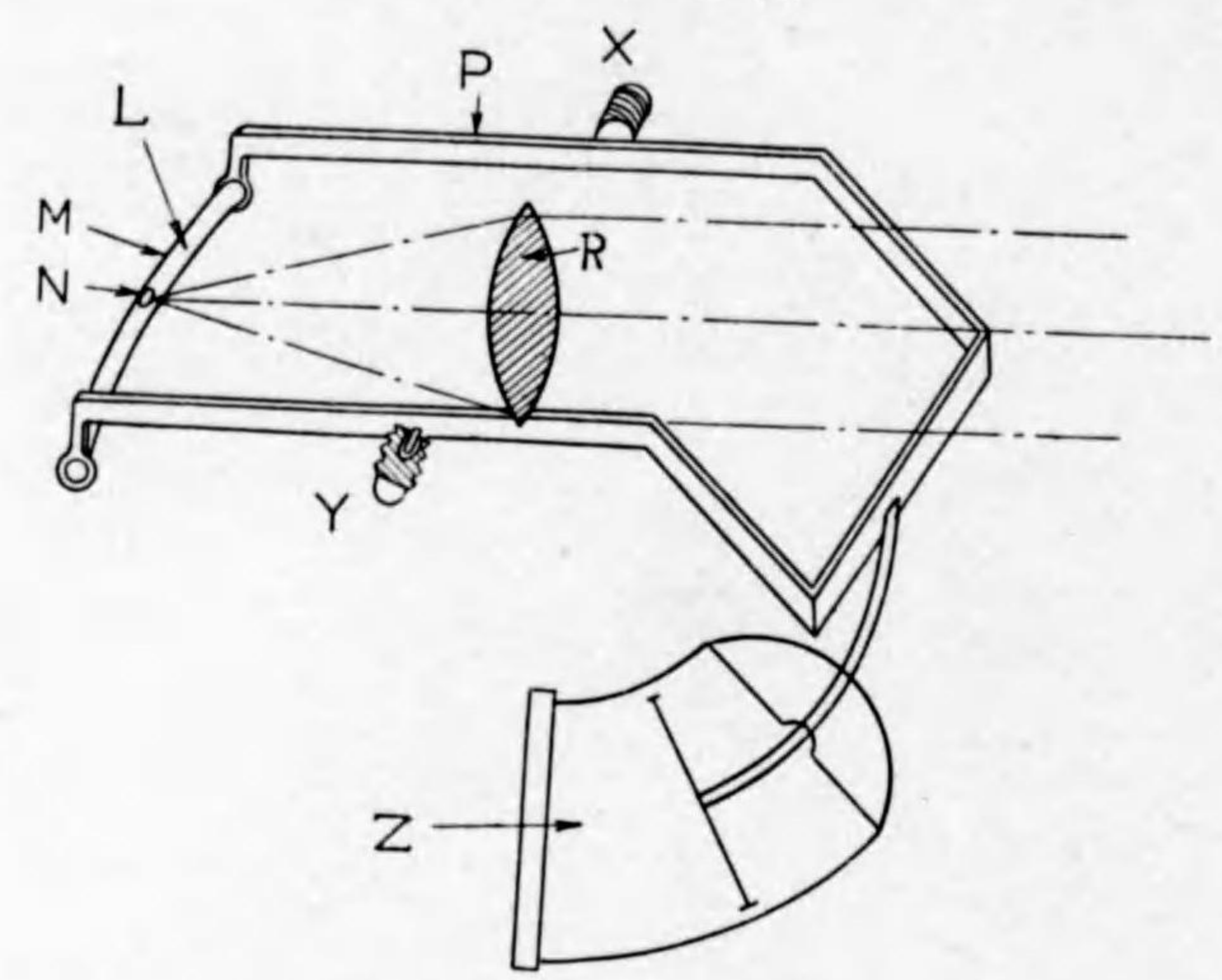

第四十八圖

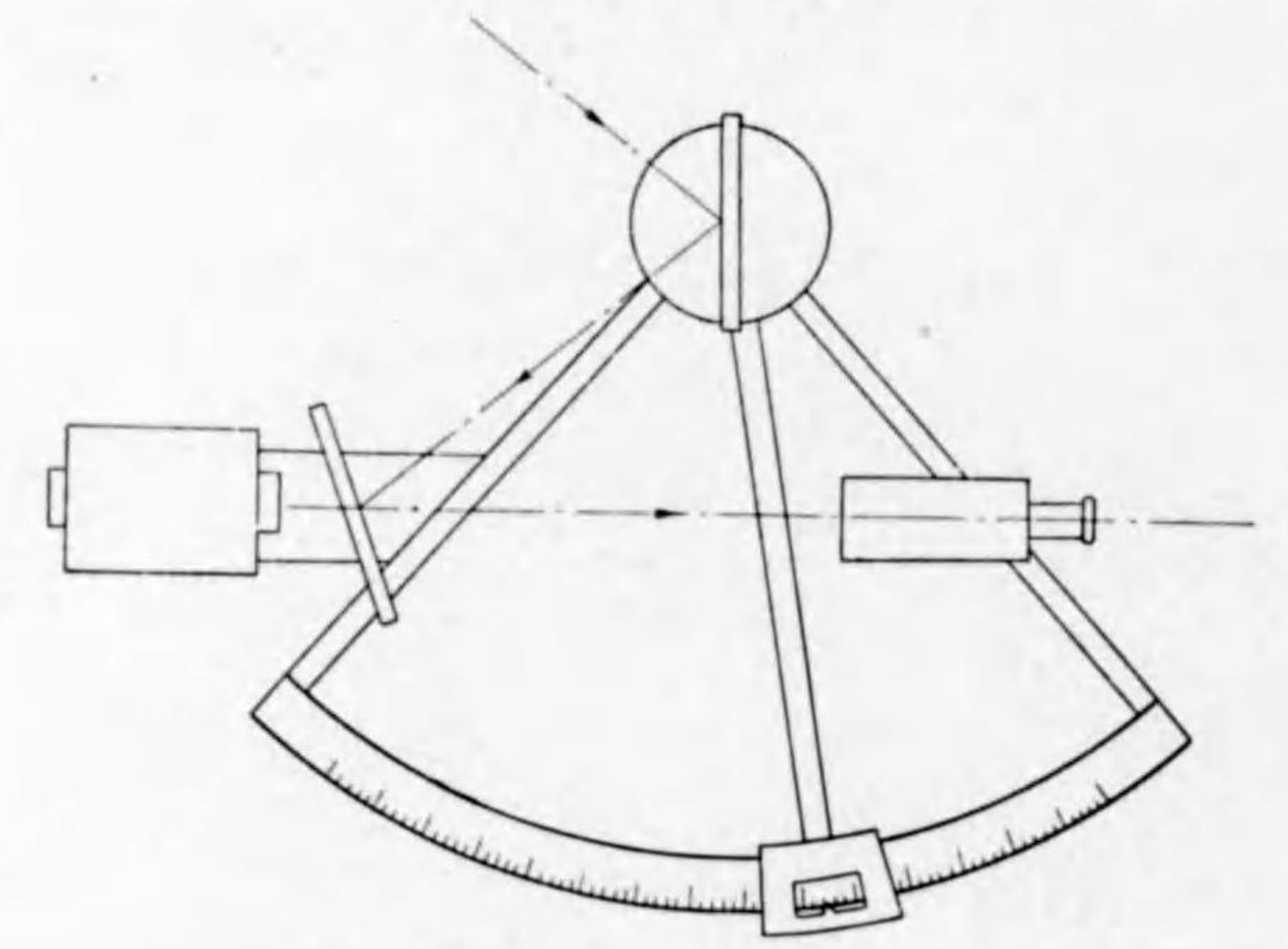

第四十九圖

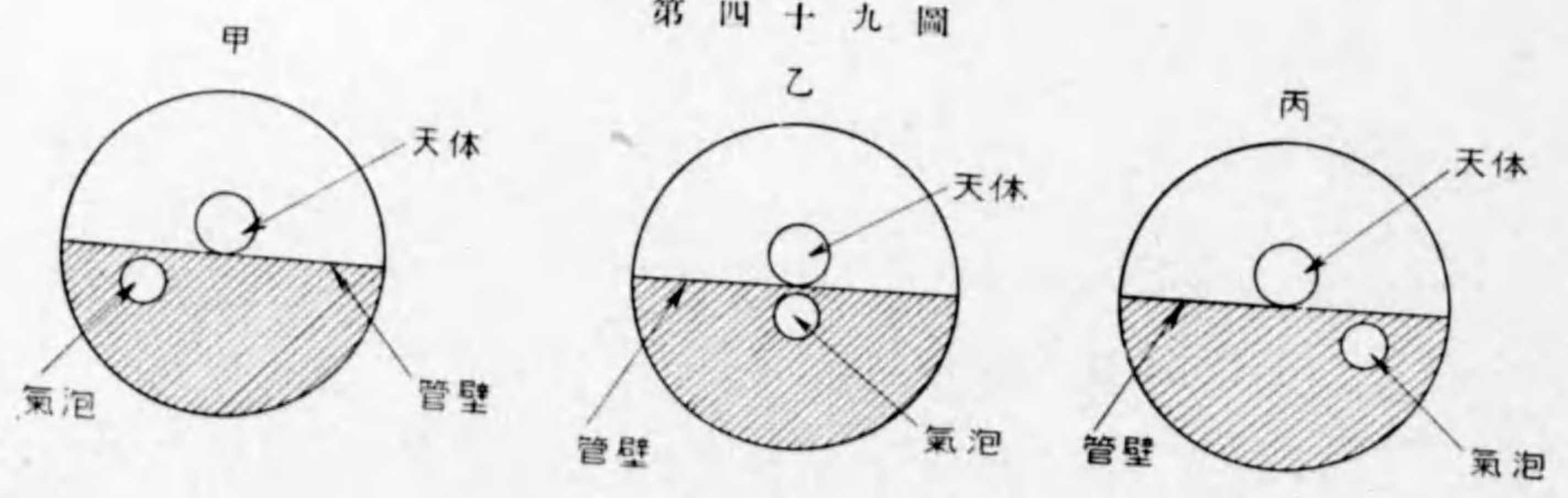

第五十圖(甲)

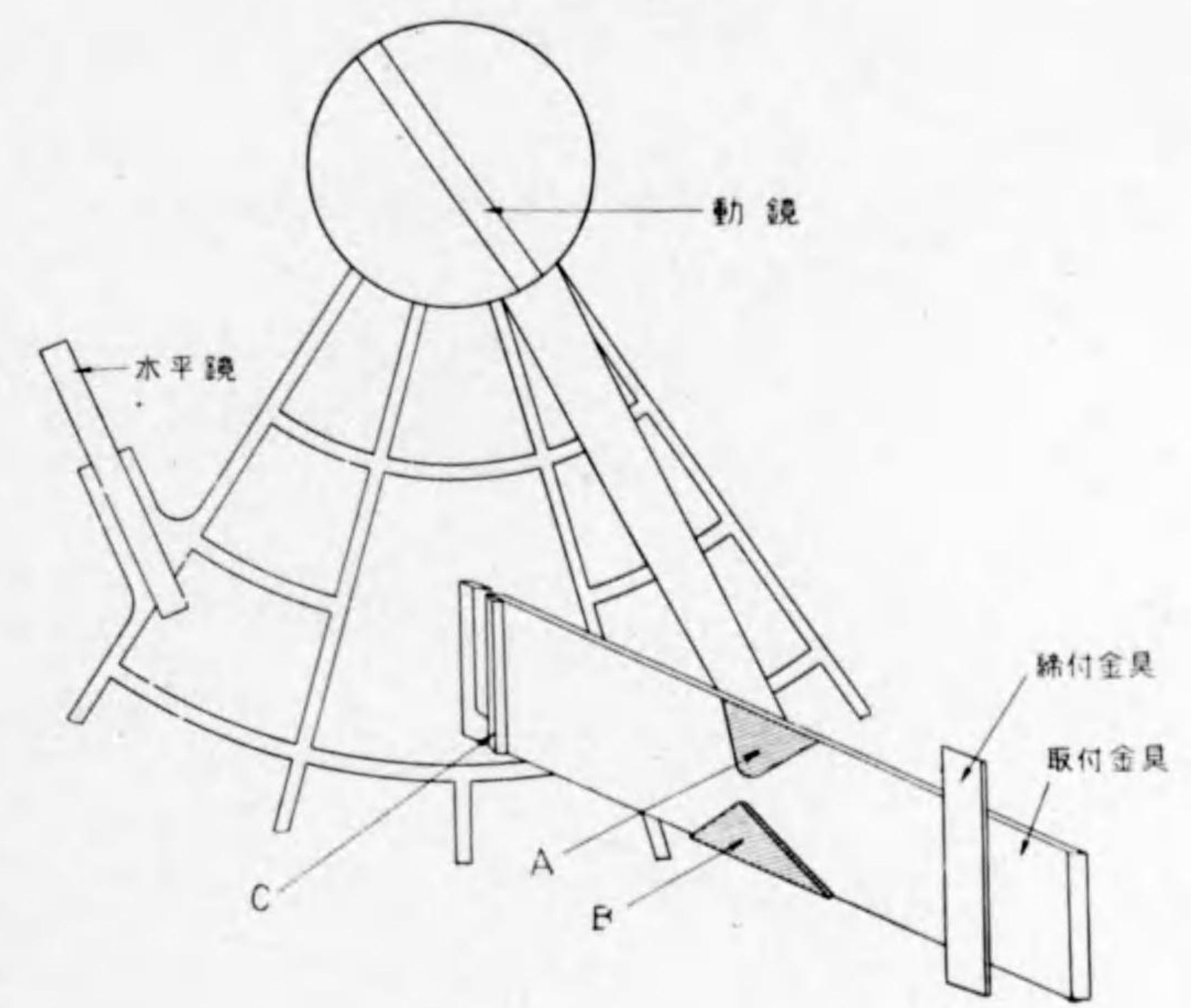

第五十圖(乙)

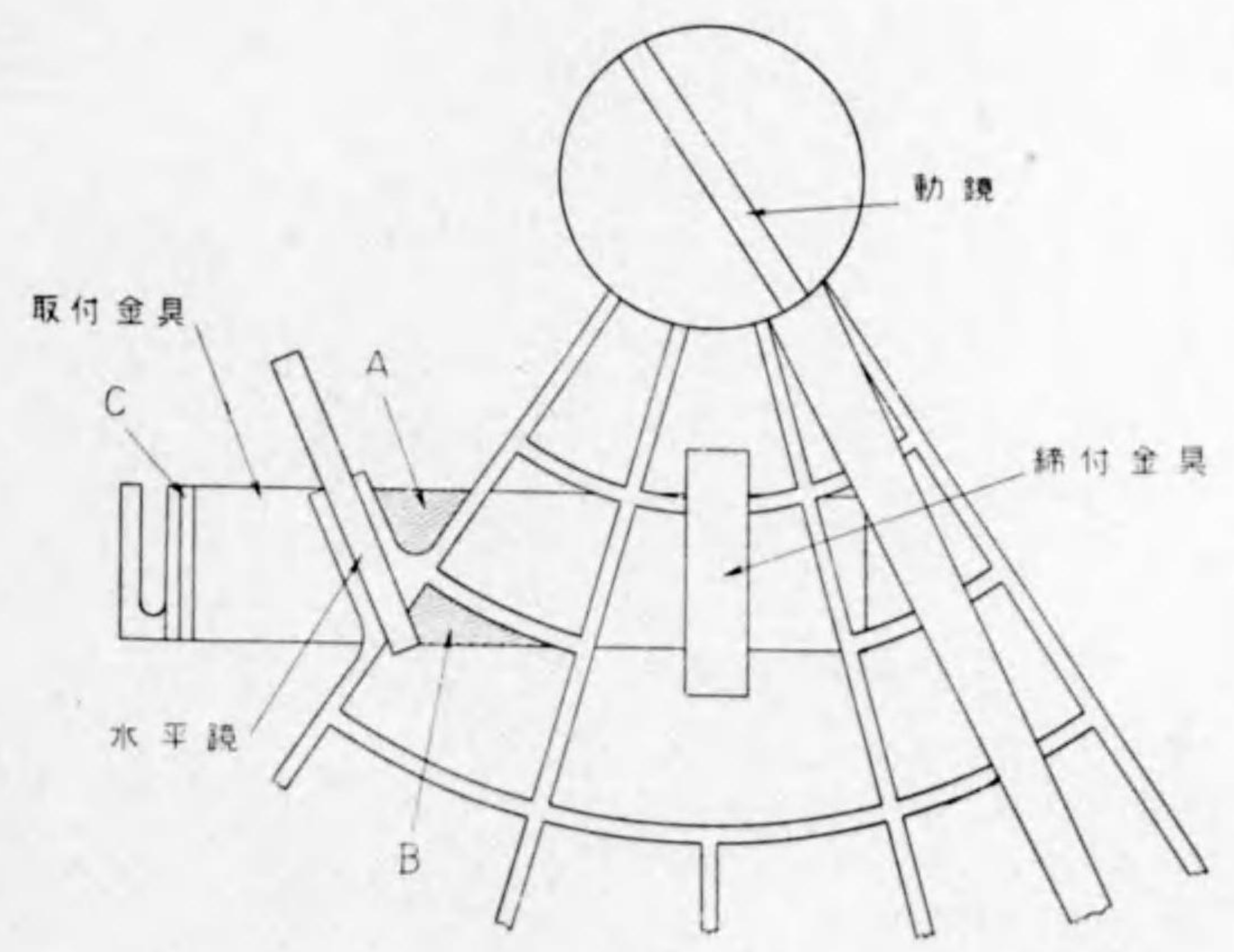

第五十圖(丙)

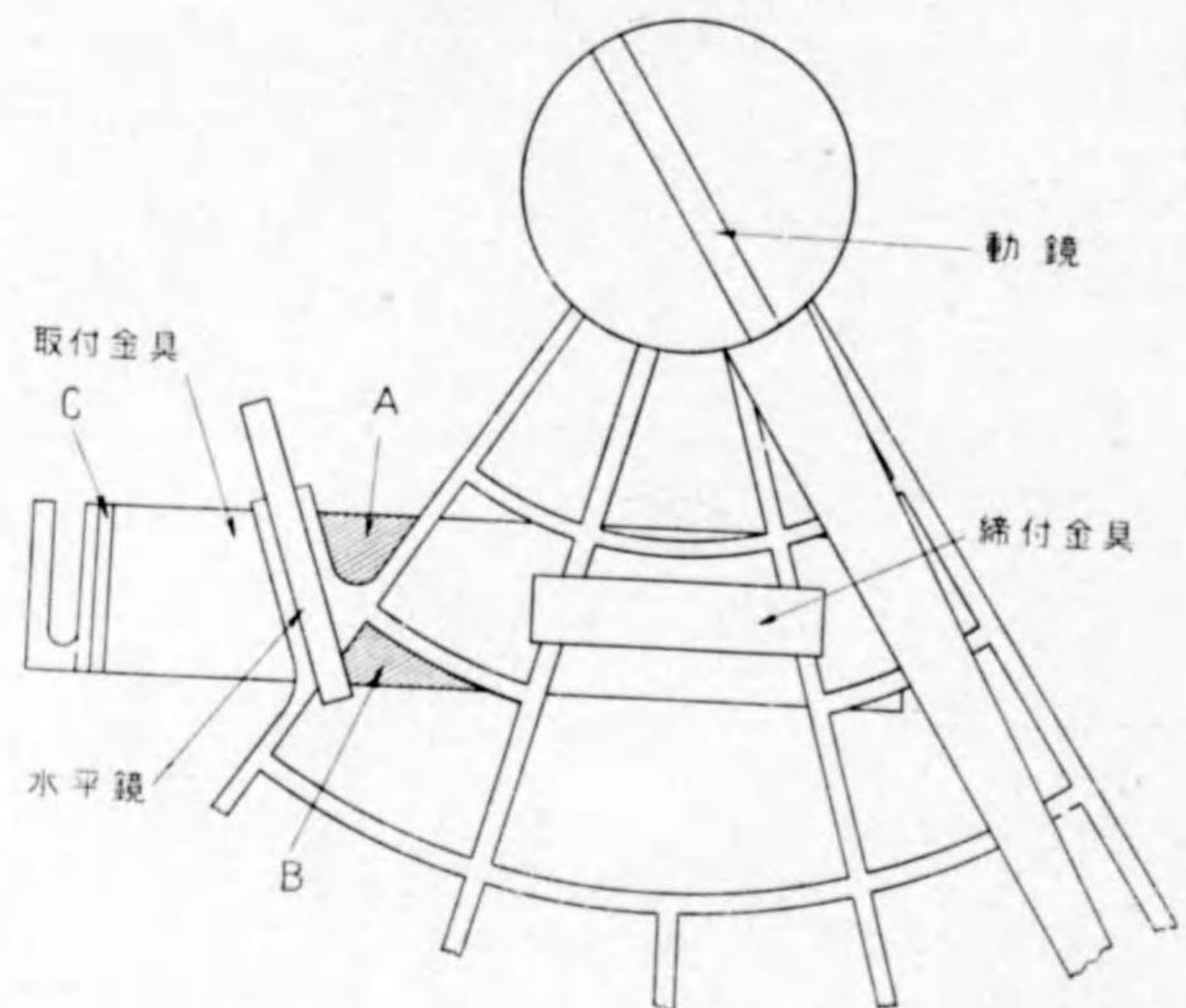

第五十圖(丁)

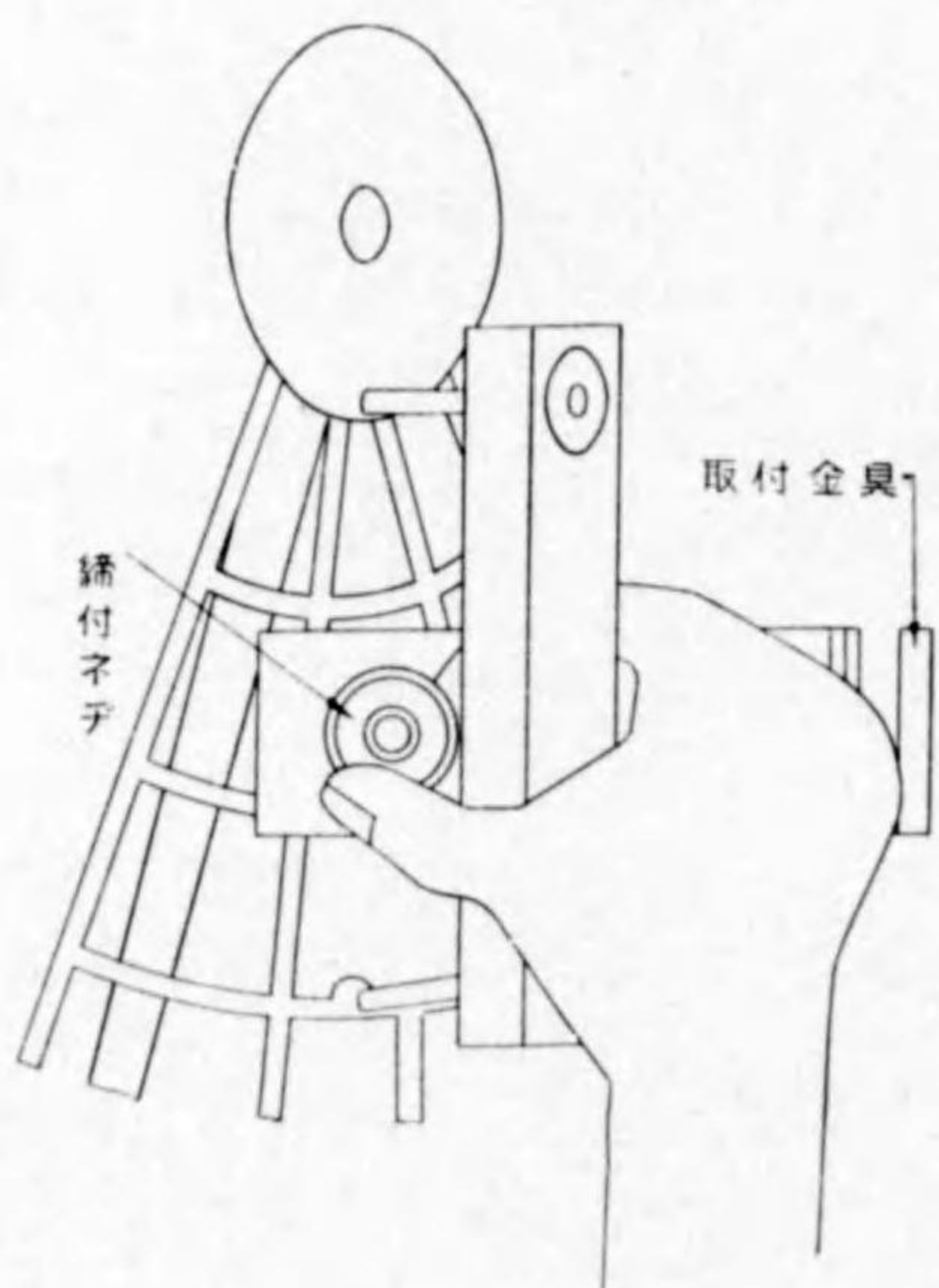

第五十一圖(甲)

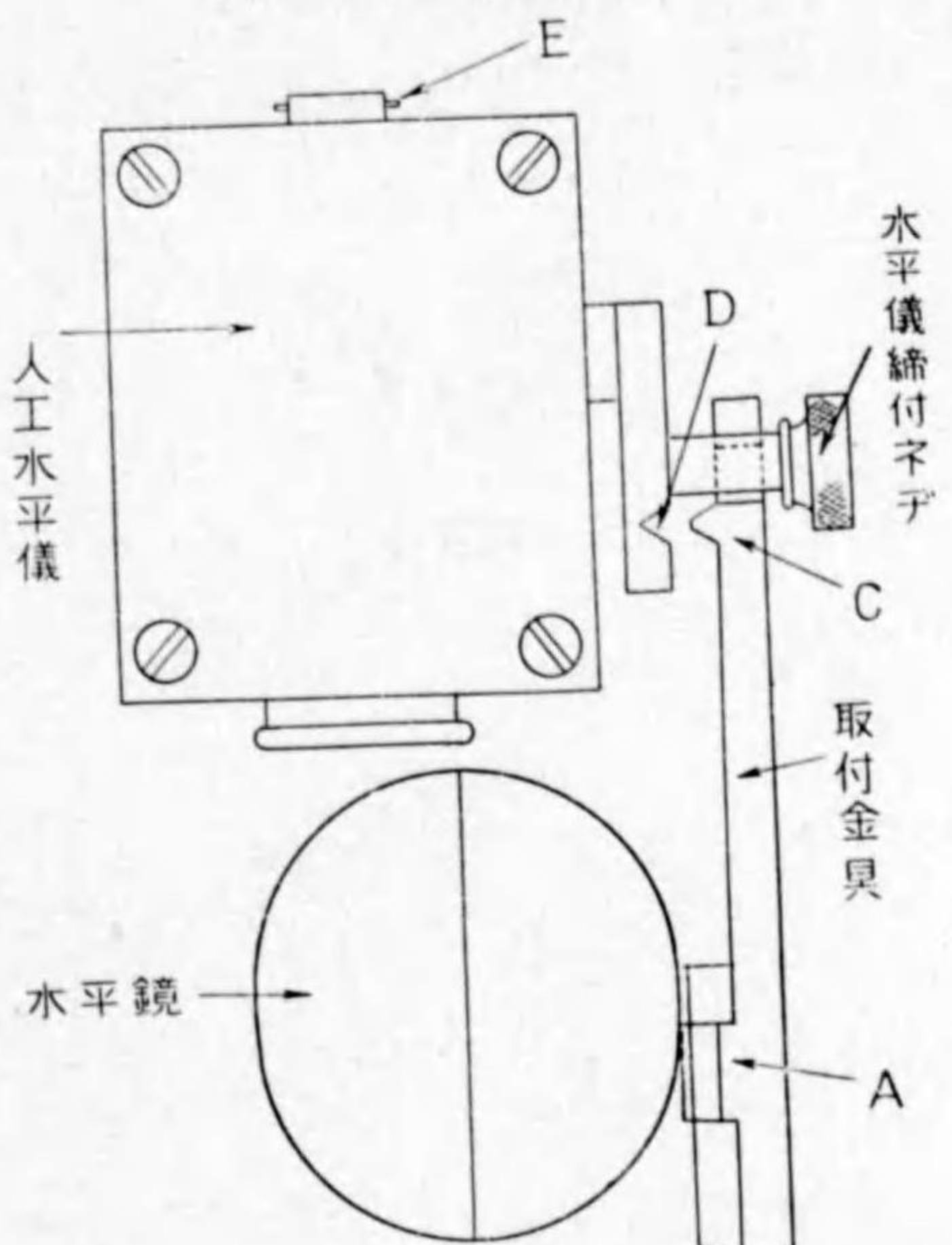

第五十一圖(乙)

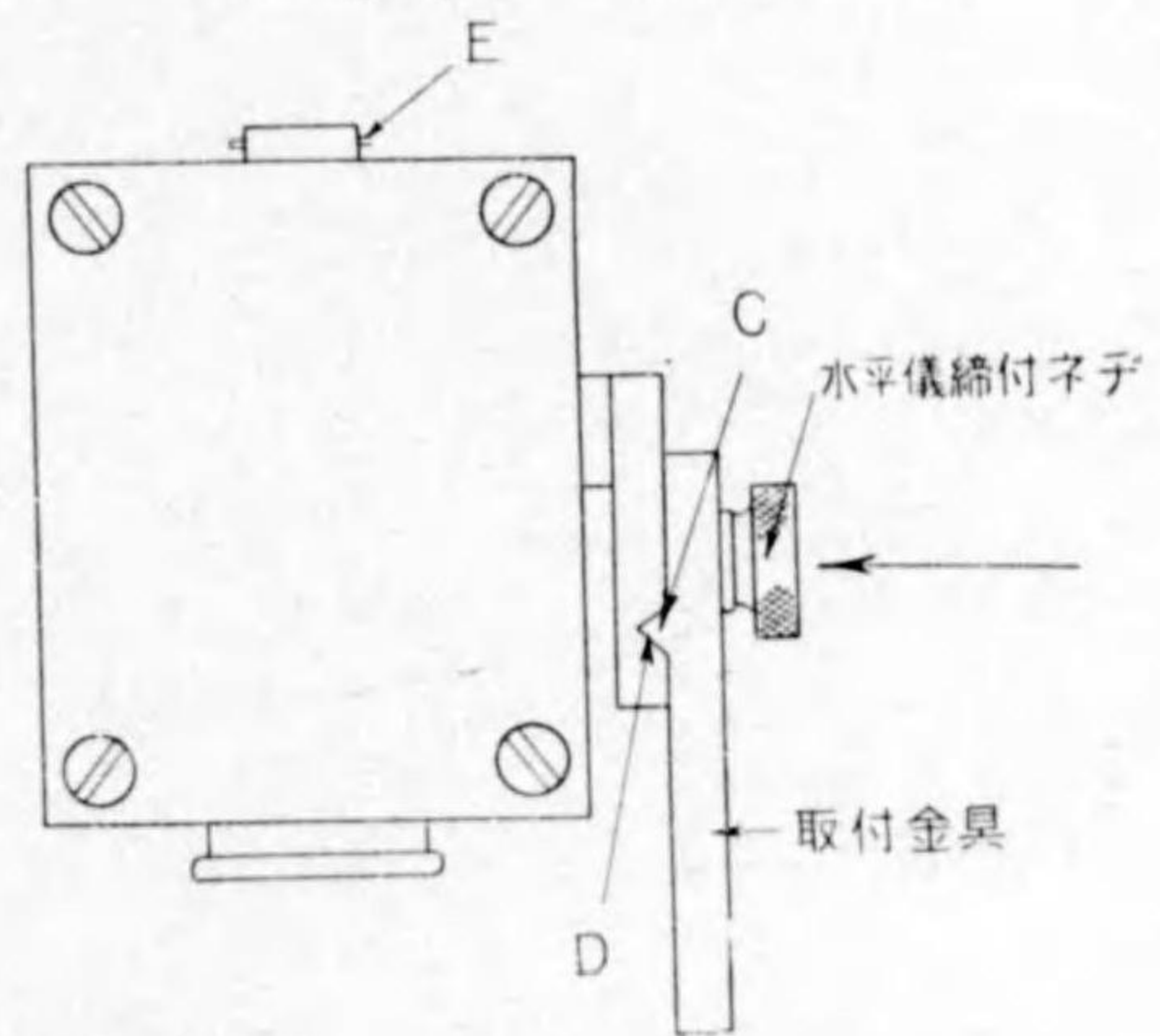

第五十一圖(丙)

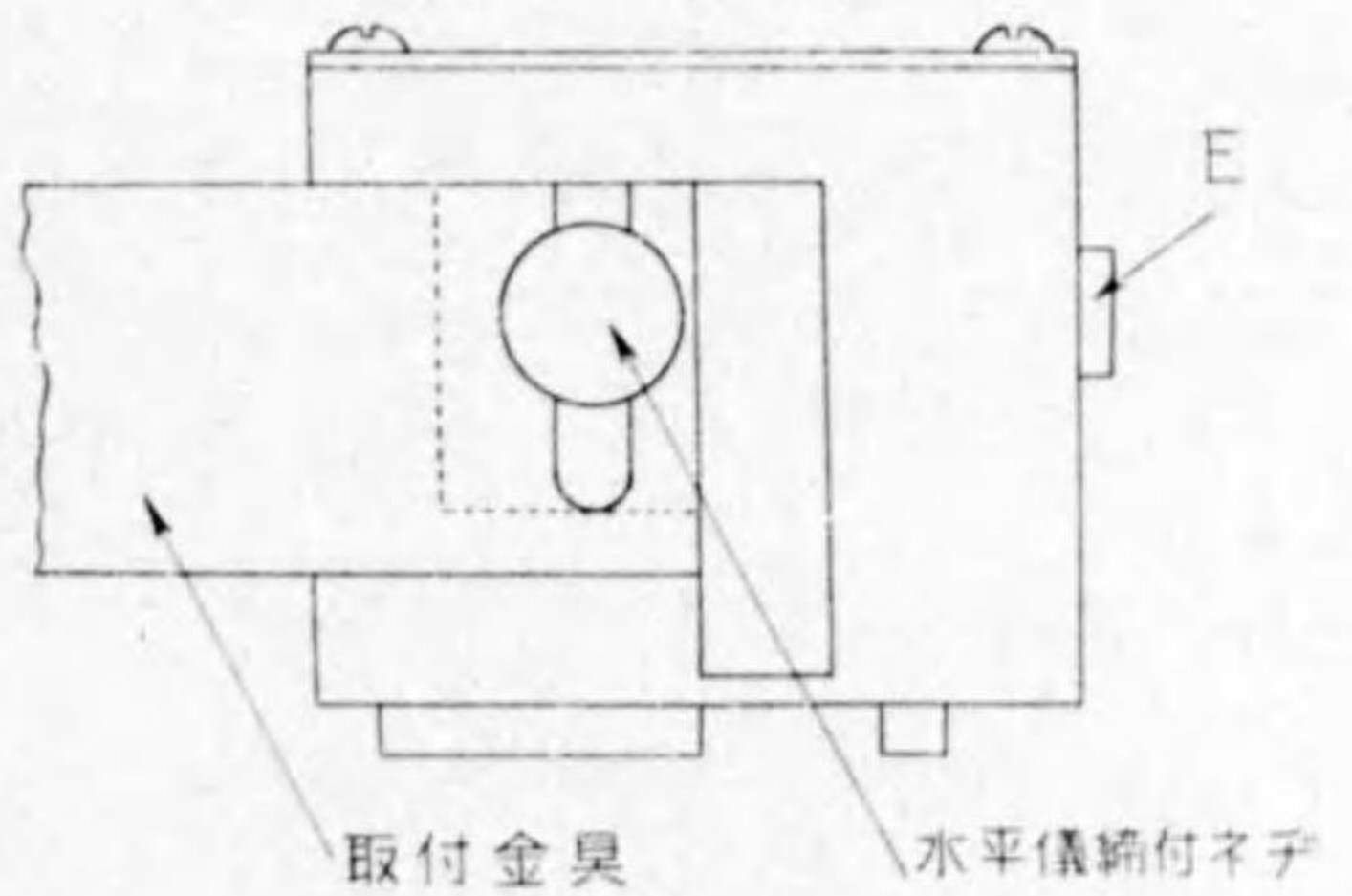

第五十一圖(丁)

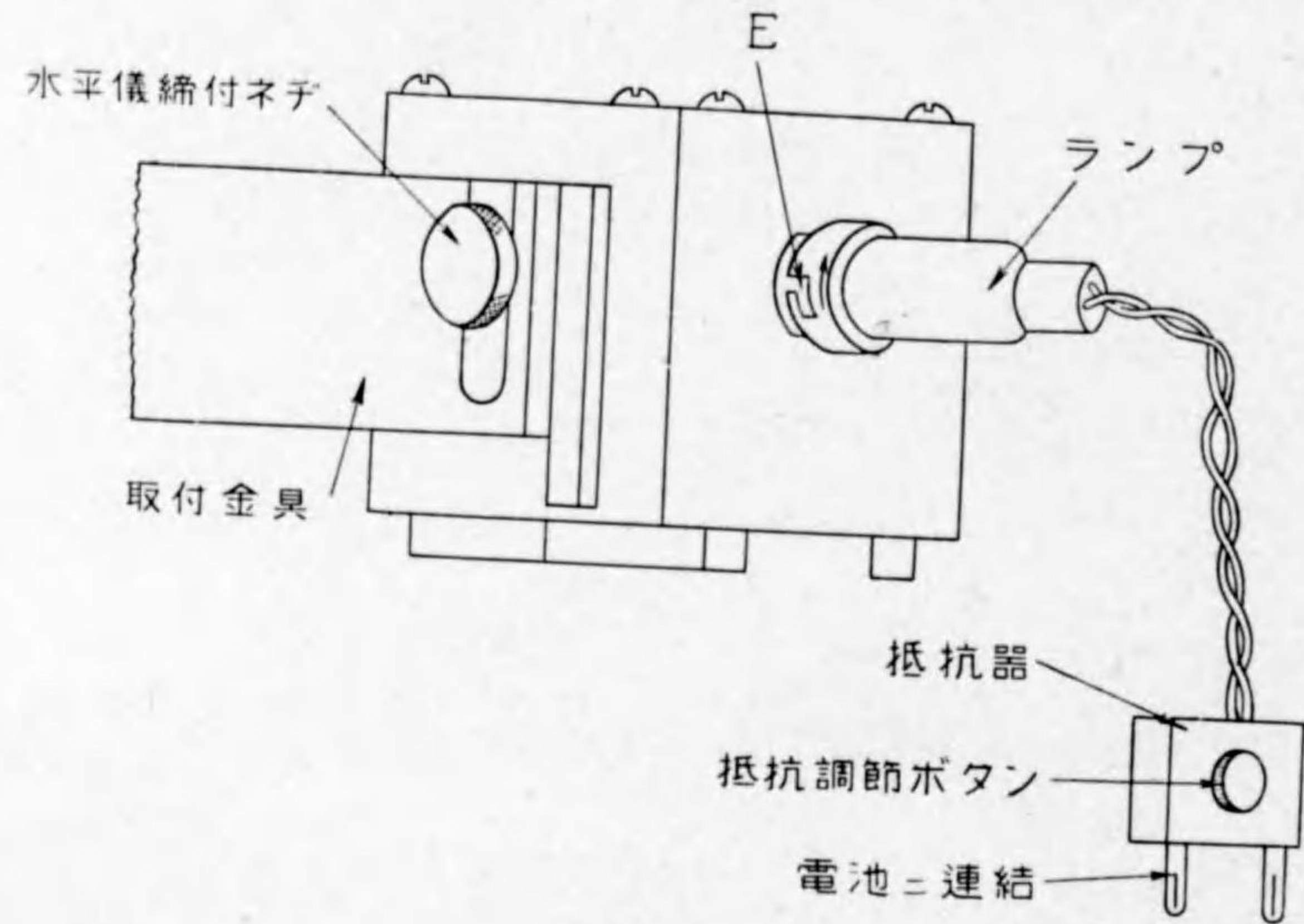

第五十二圖

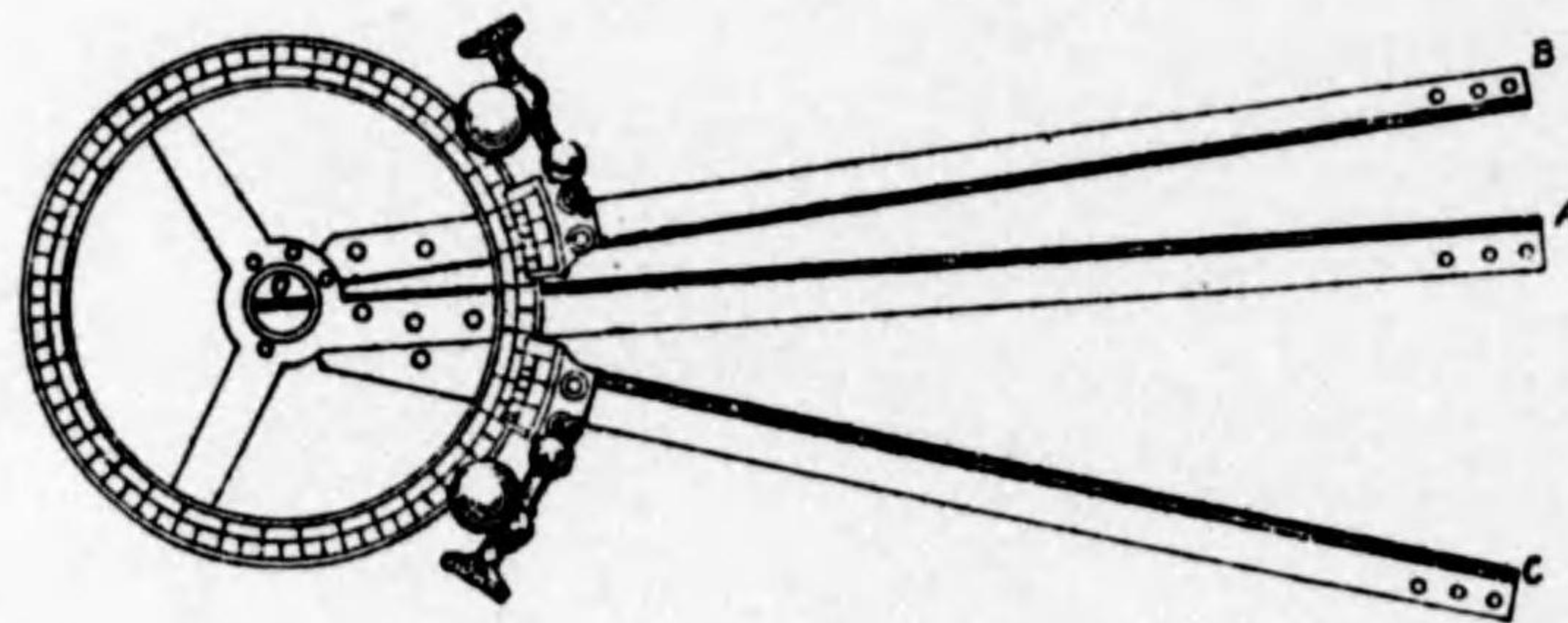

第五十三圖

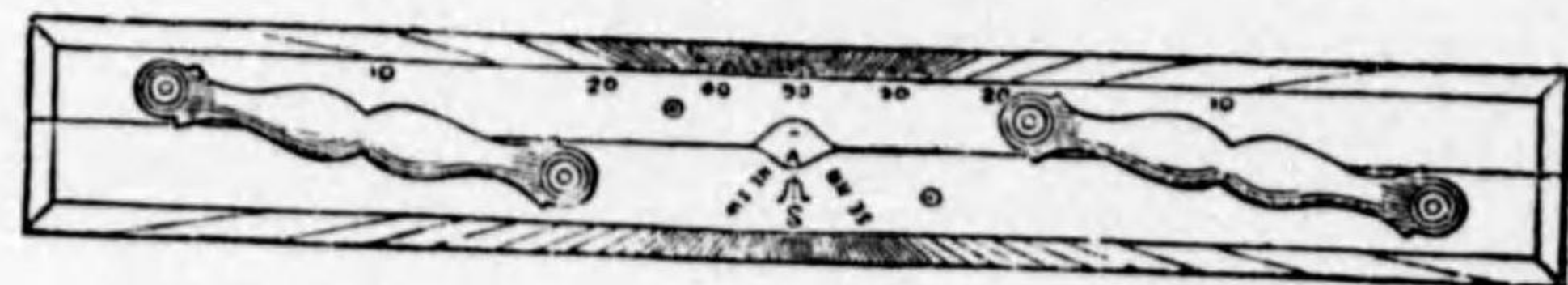

第五十四圖

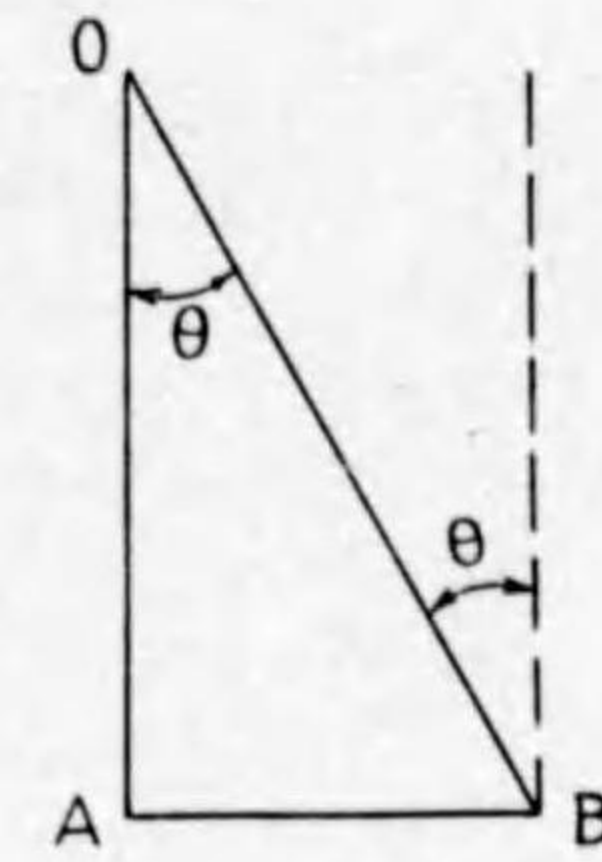

第五十五圖

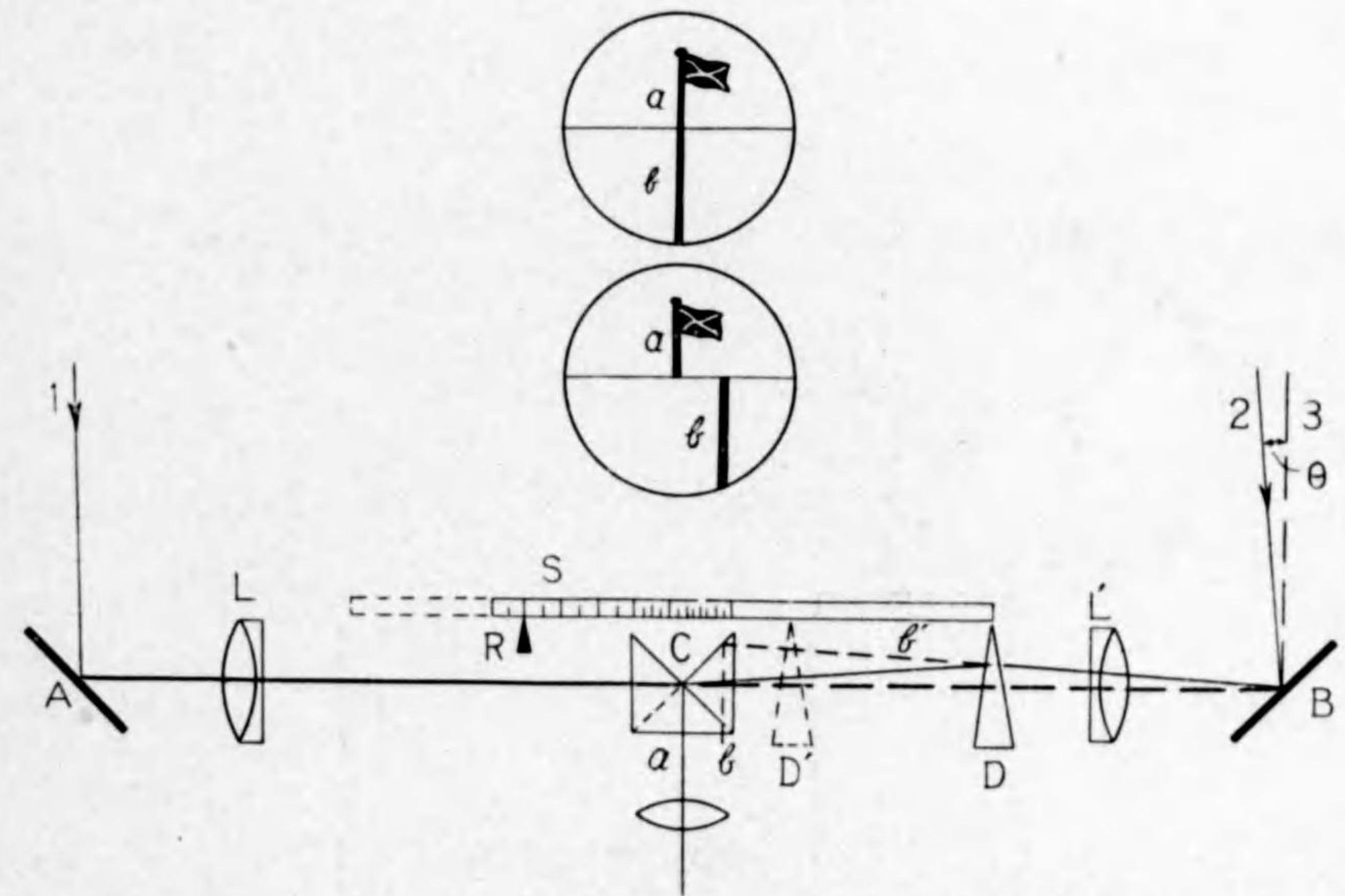

第五十六圖

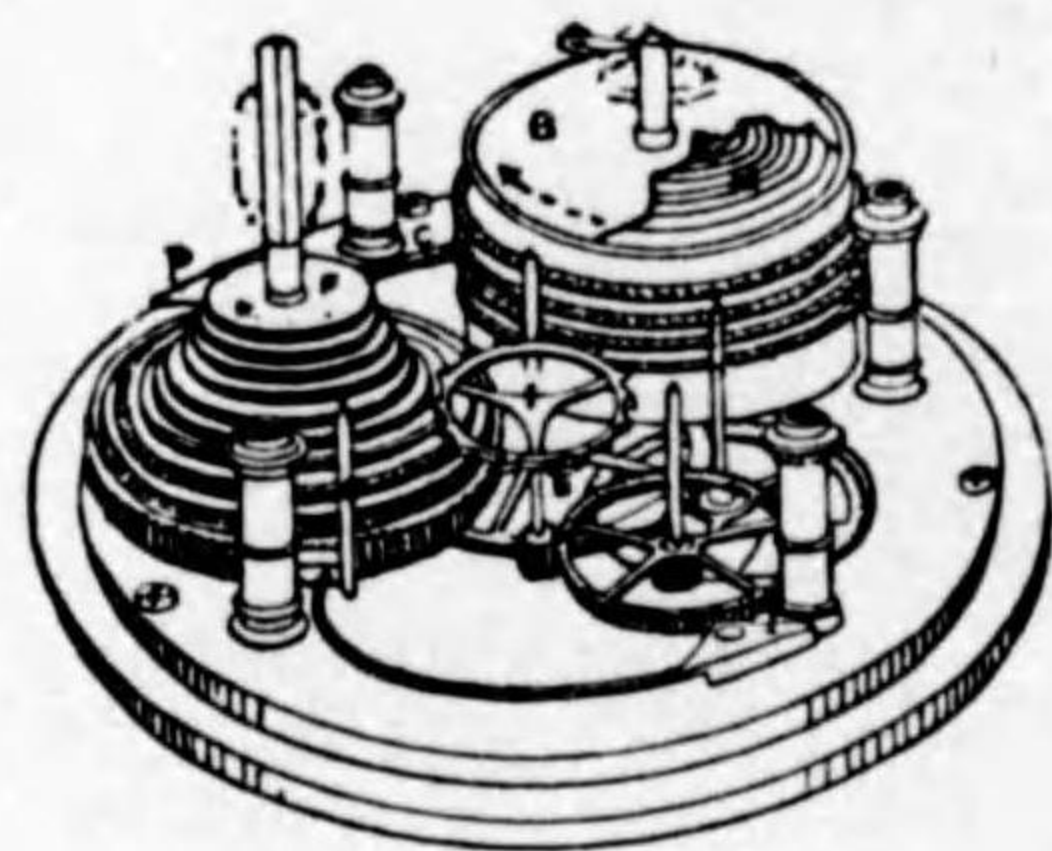

第五十七圖

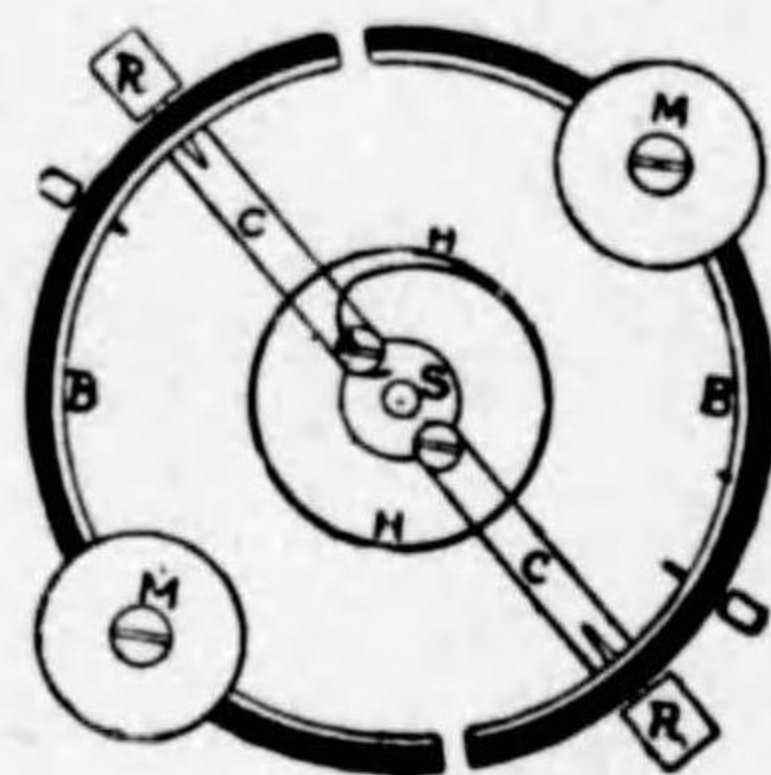

第五十八圖

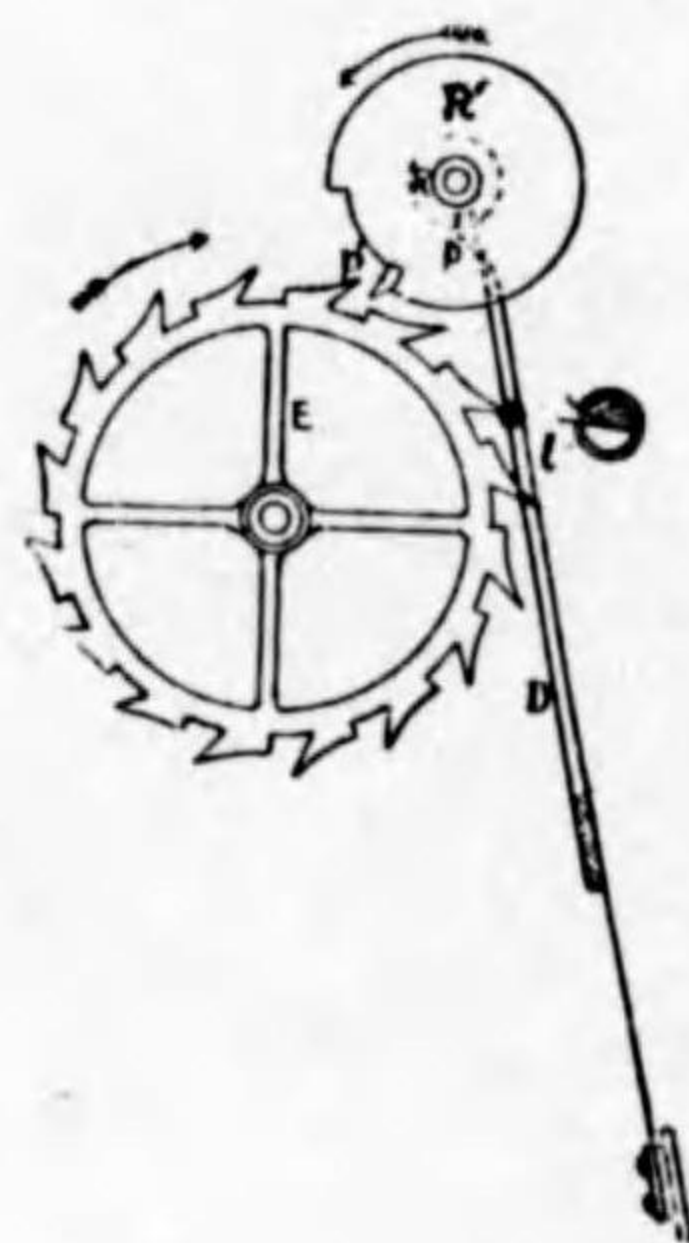

第五十九圖

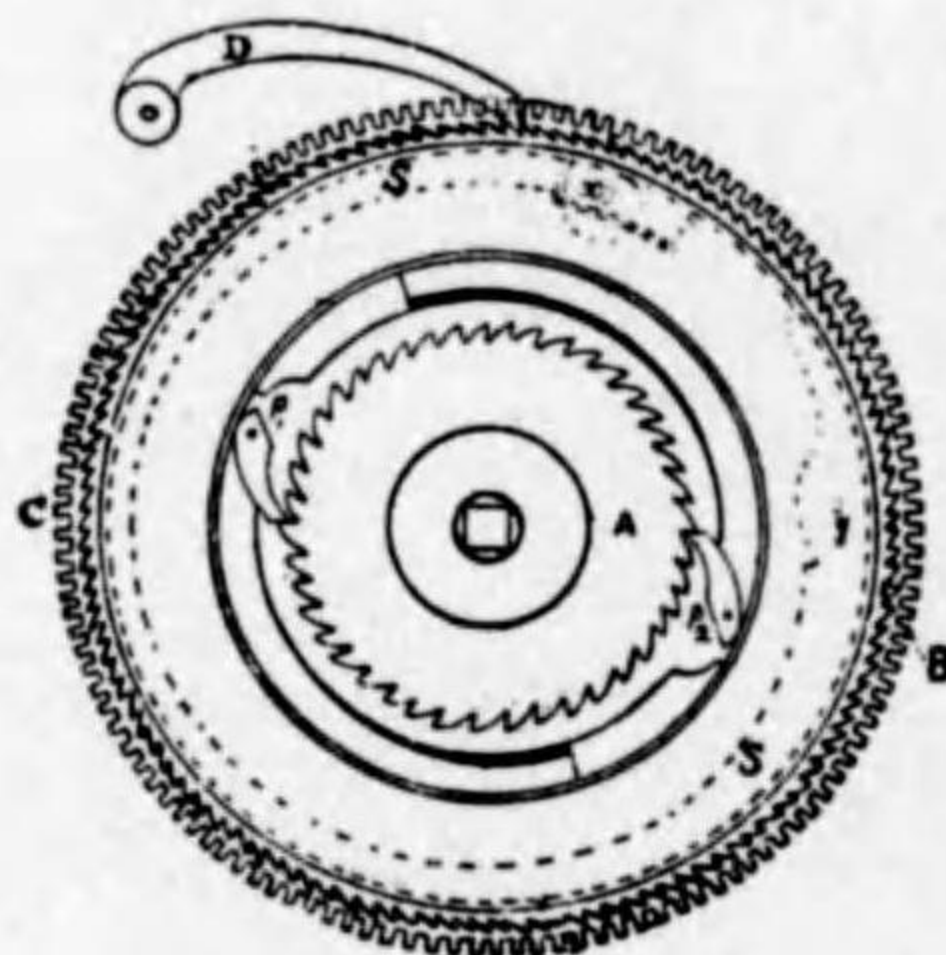

第六十圖



第六十一圖



第六十二圖

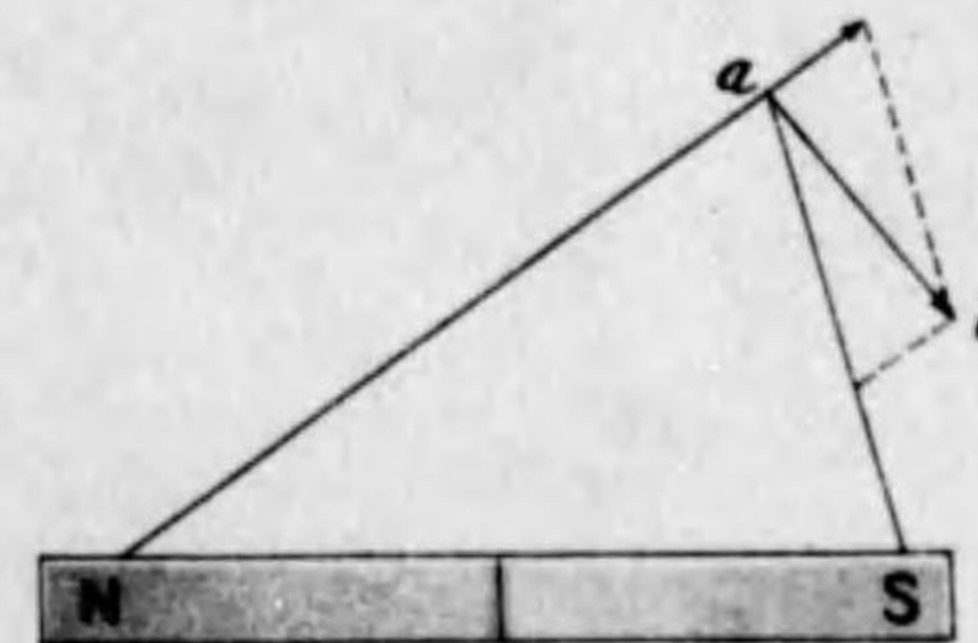

第六十三圖

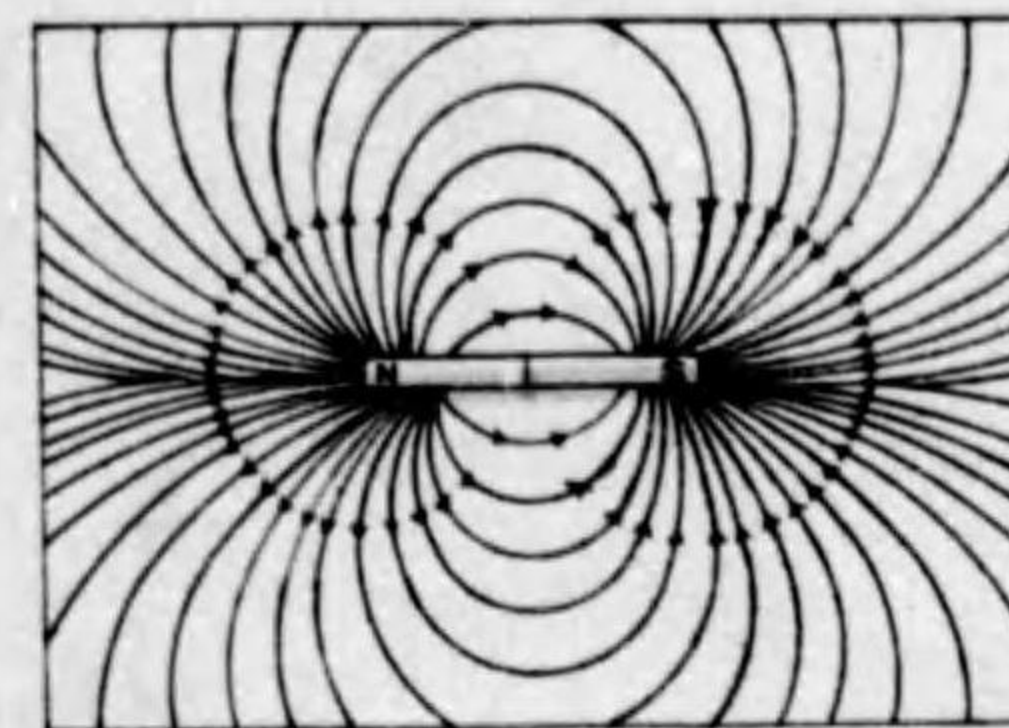

第六十五圖

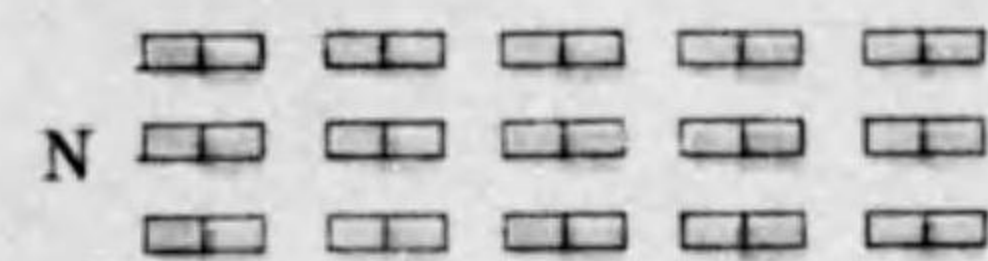

第六十四圖

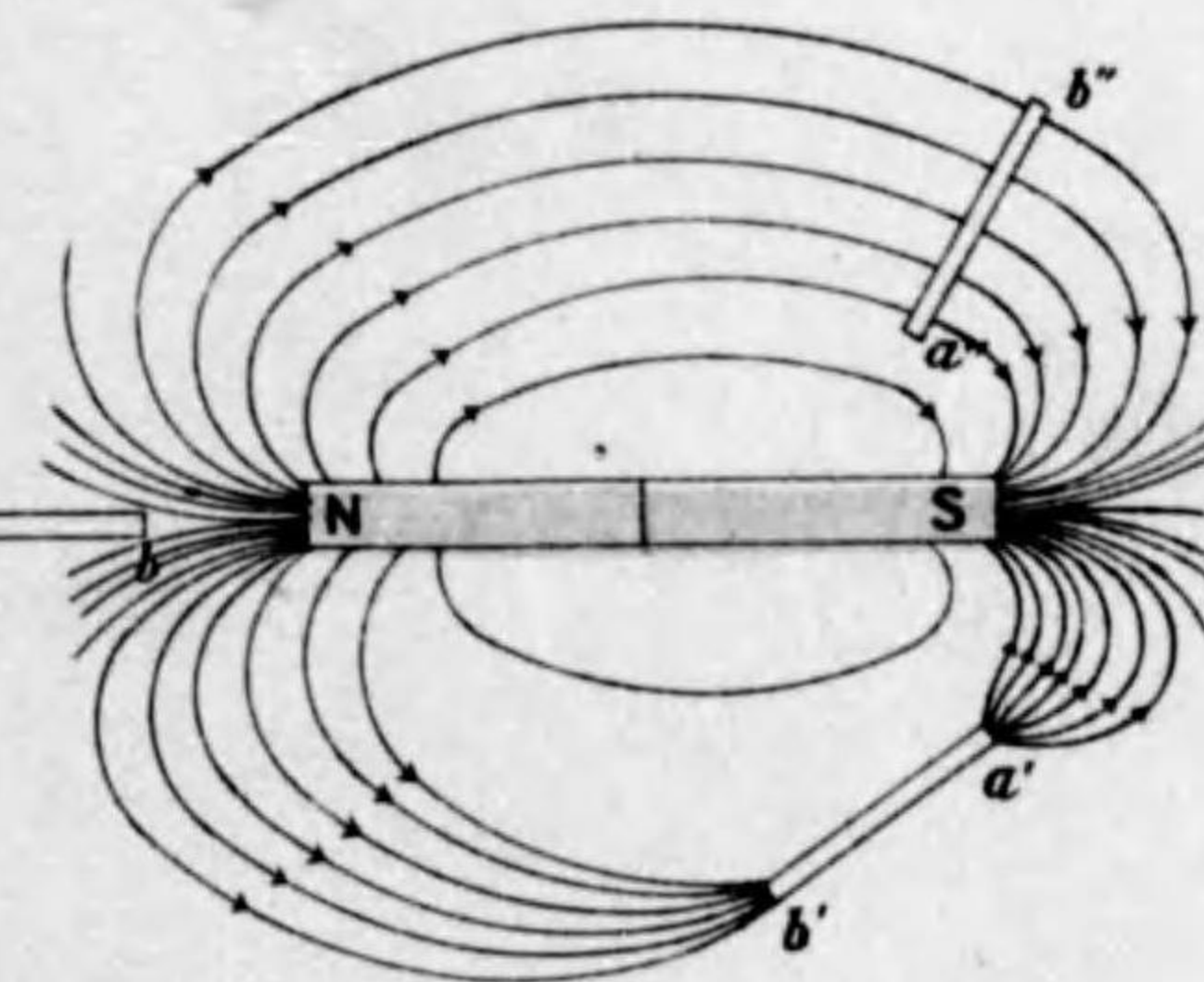

第六十六圖

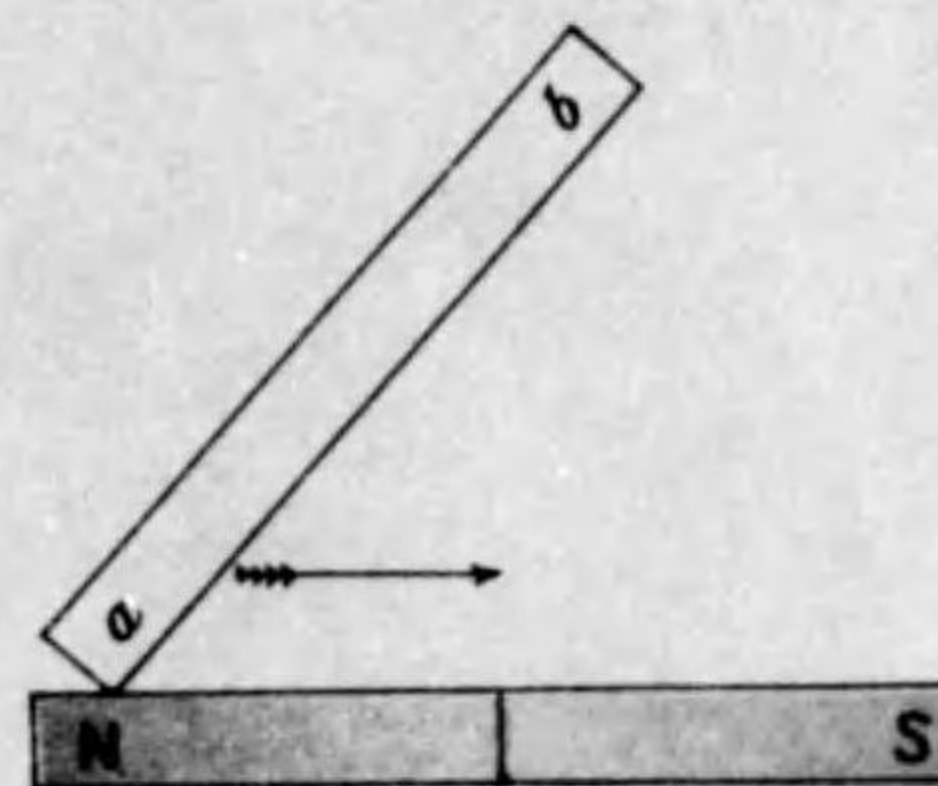

第六十七圖

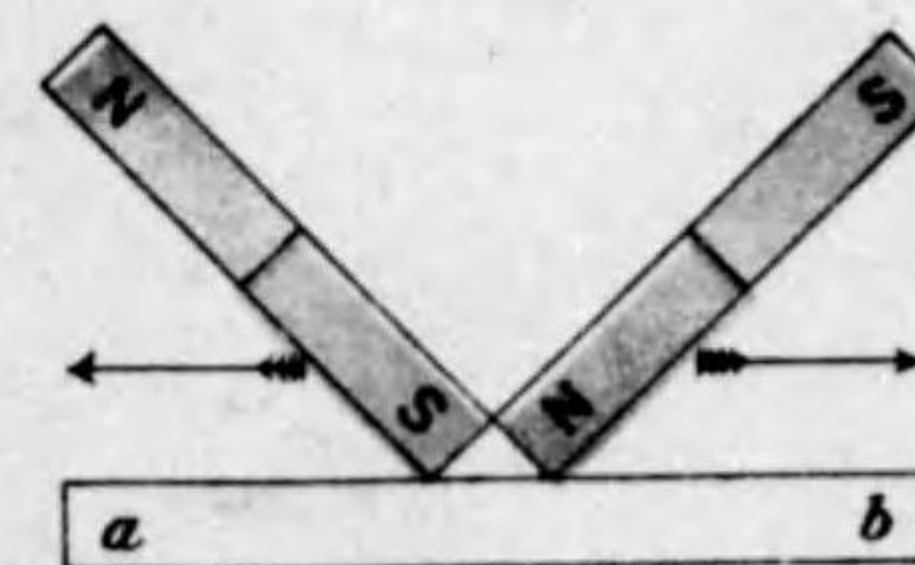

第六十八圖



第六十九圖

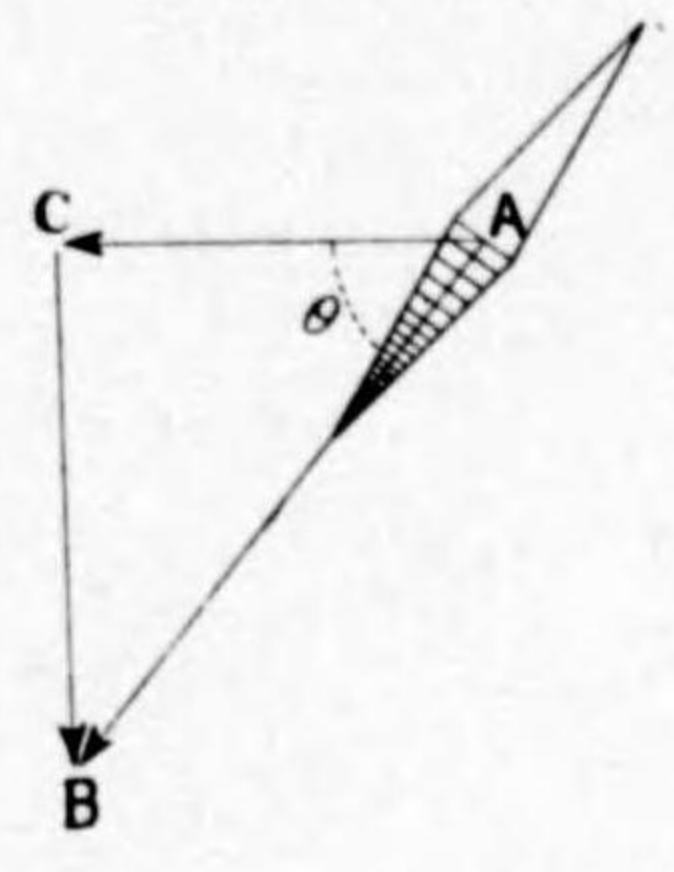

第七十圖

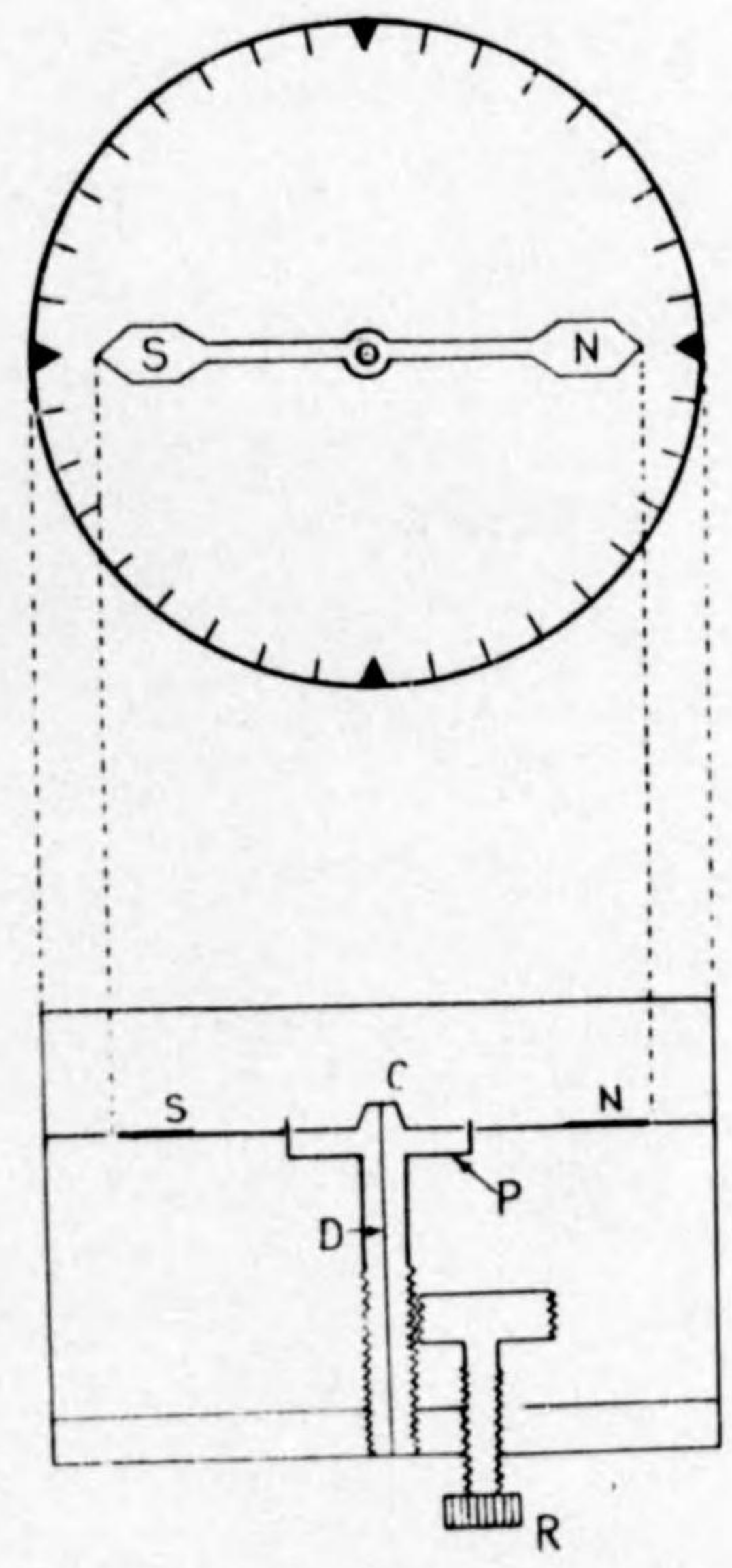

第七十一圖 等偏差線圖 (Lines of equal variation)

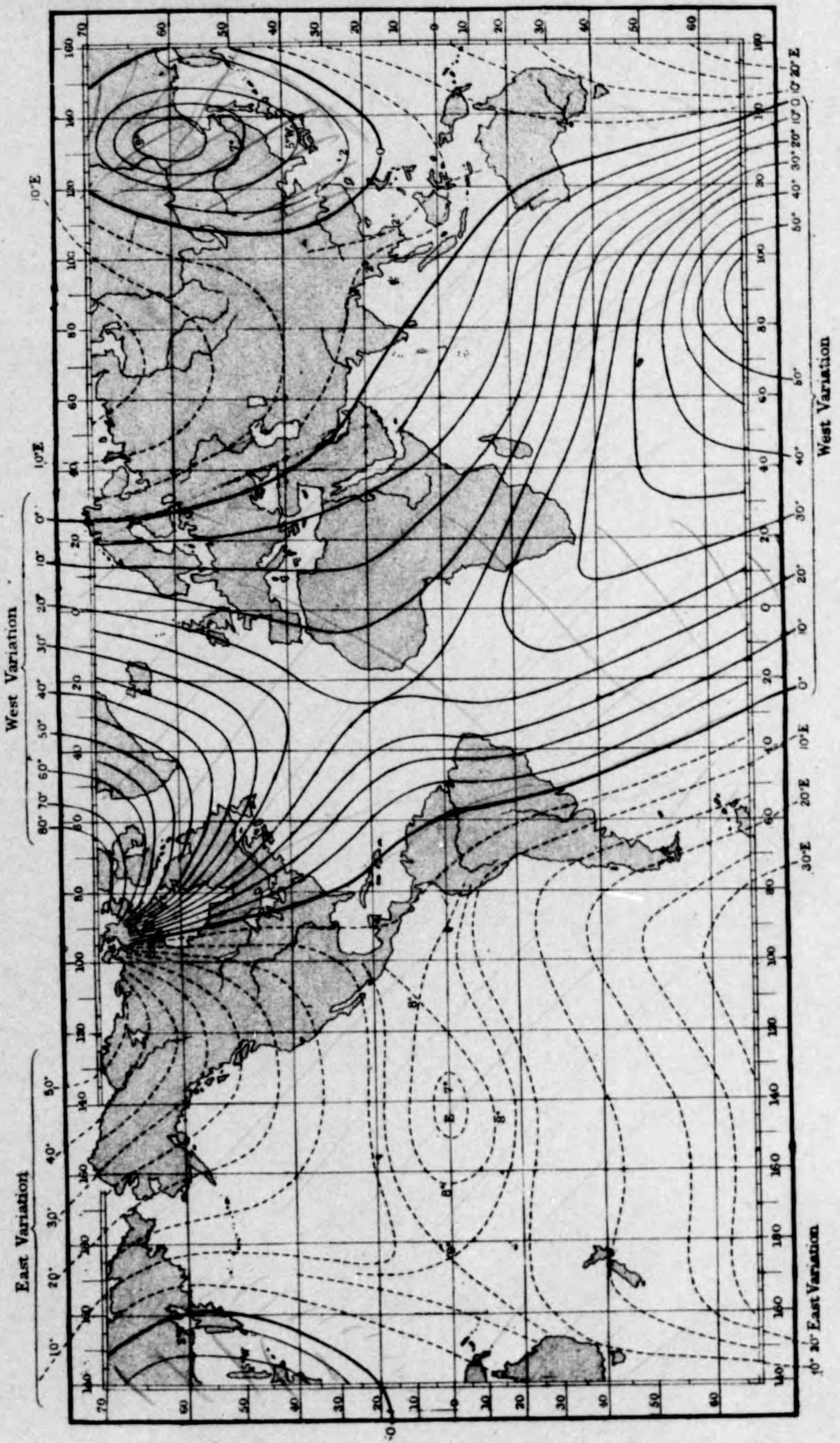

第七十二圖 等傾差線圖 (Lines of equal dip.)

Nat. Tangt
of
DIP.

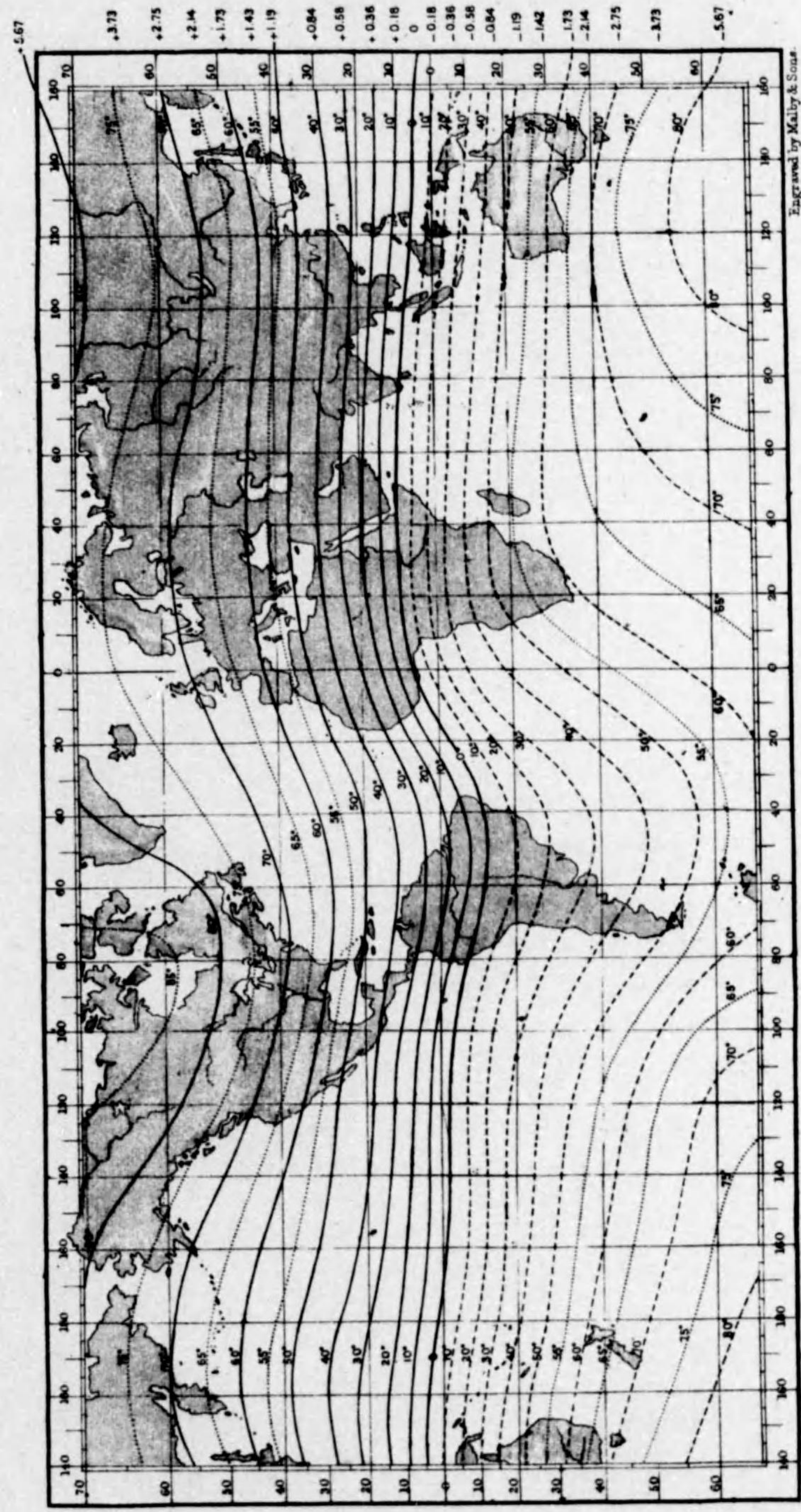

Engraved by Malby & Sons

第七十三圖 等水平力線圖 (Lines of equal horizontal force)

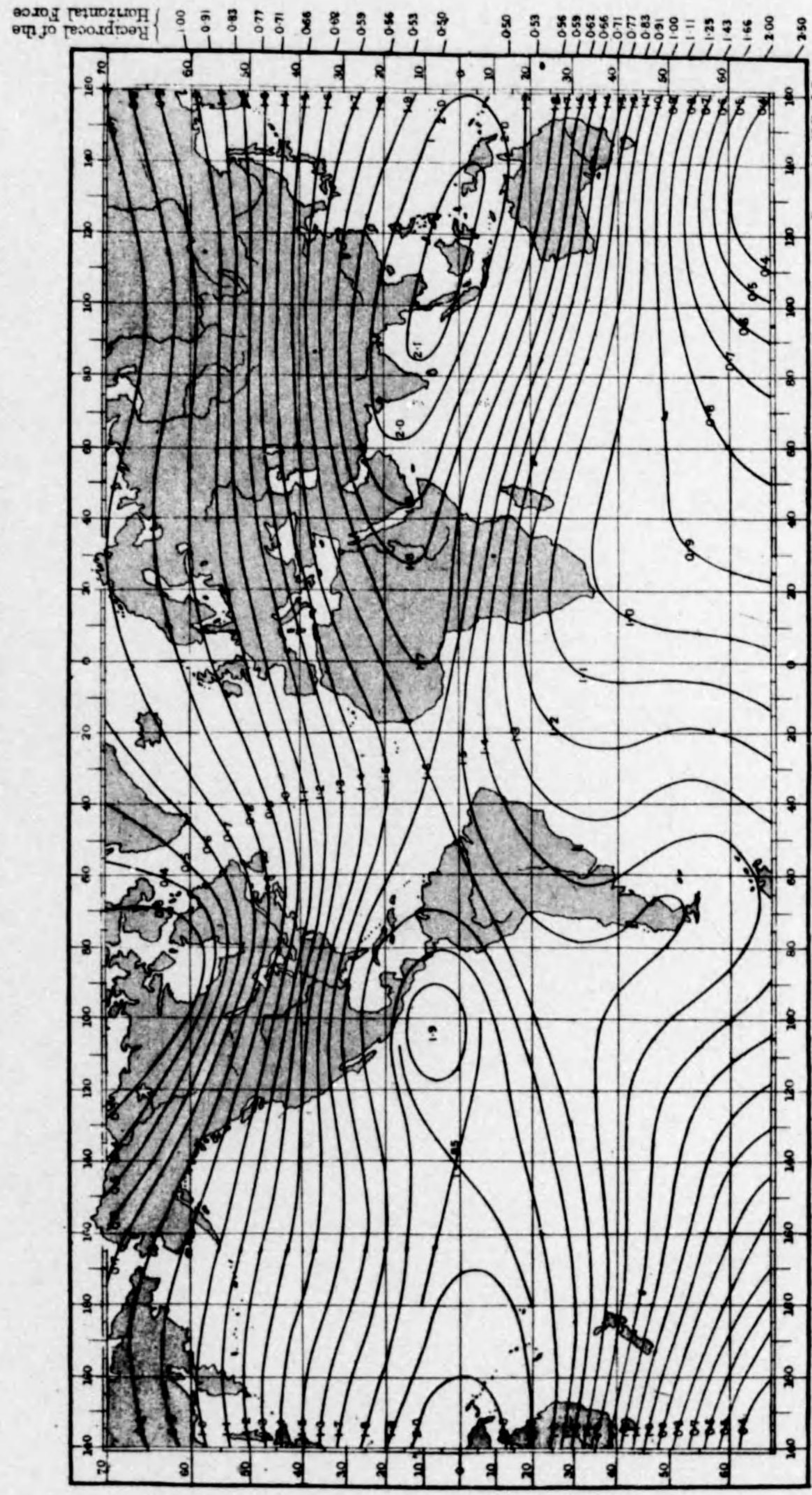

第七十四圖 等垂直力線圖 (Lines of equal vertical force)

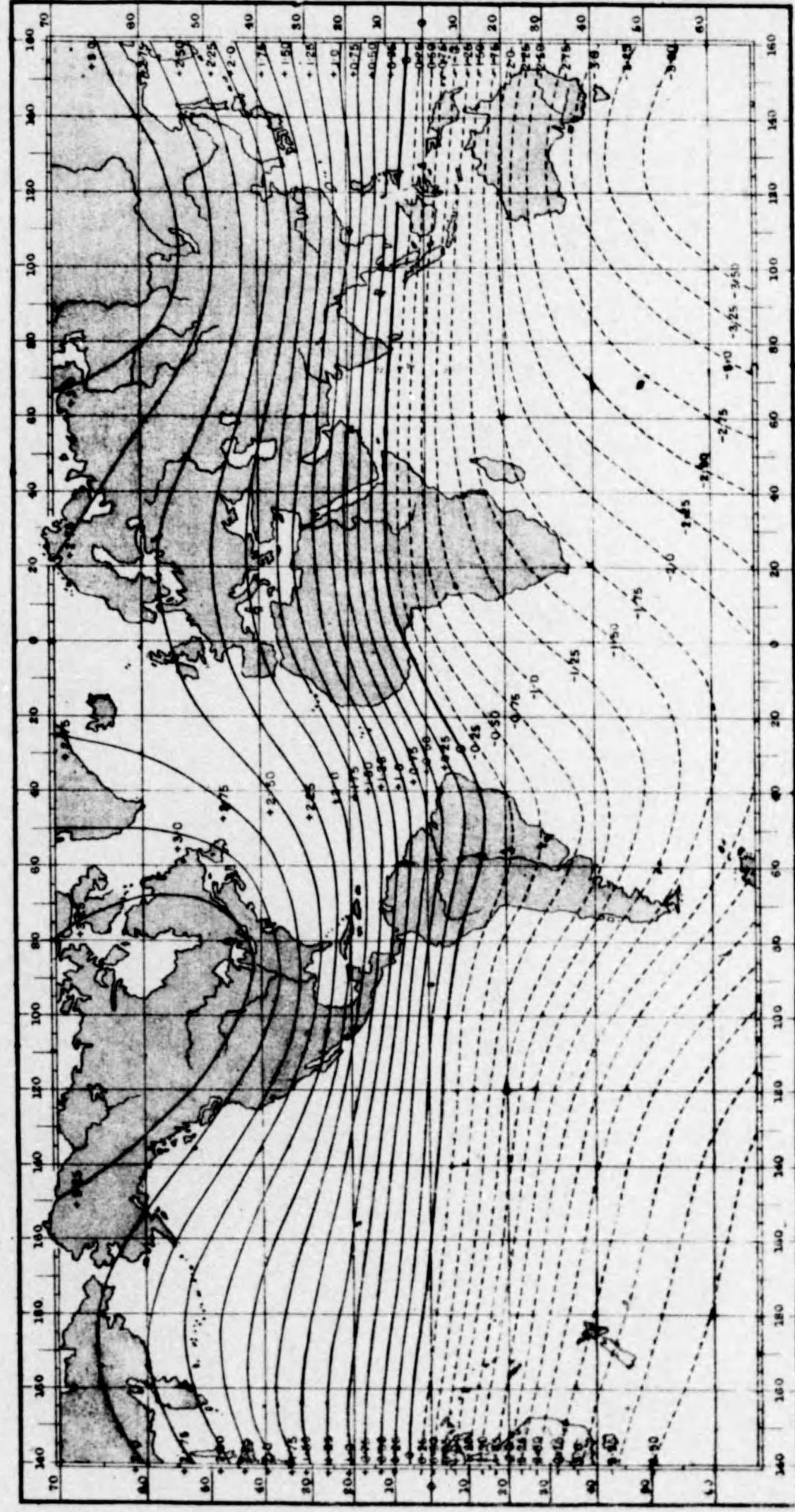

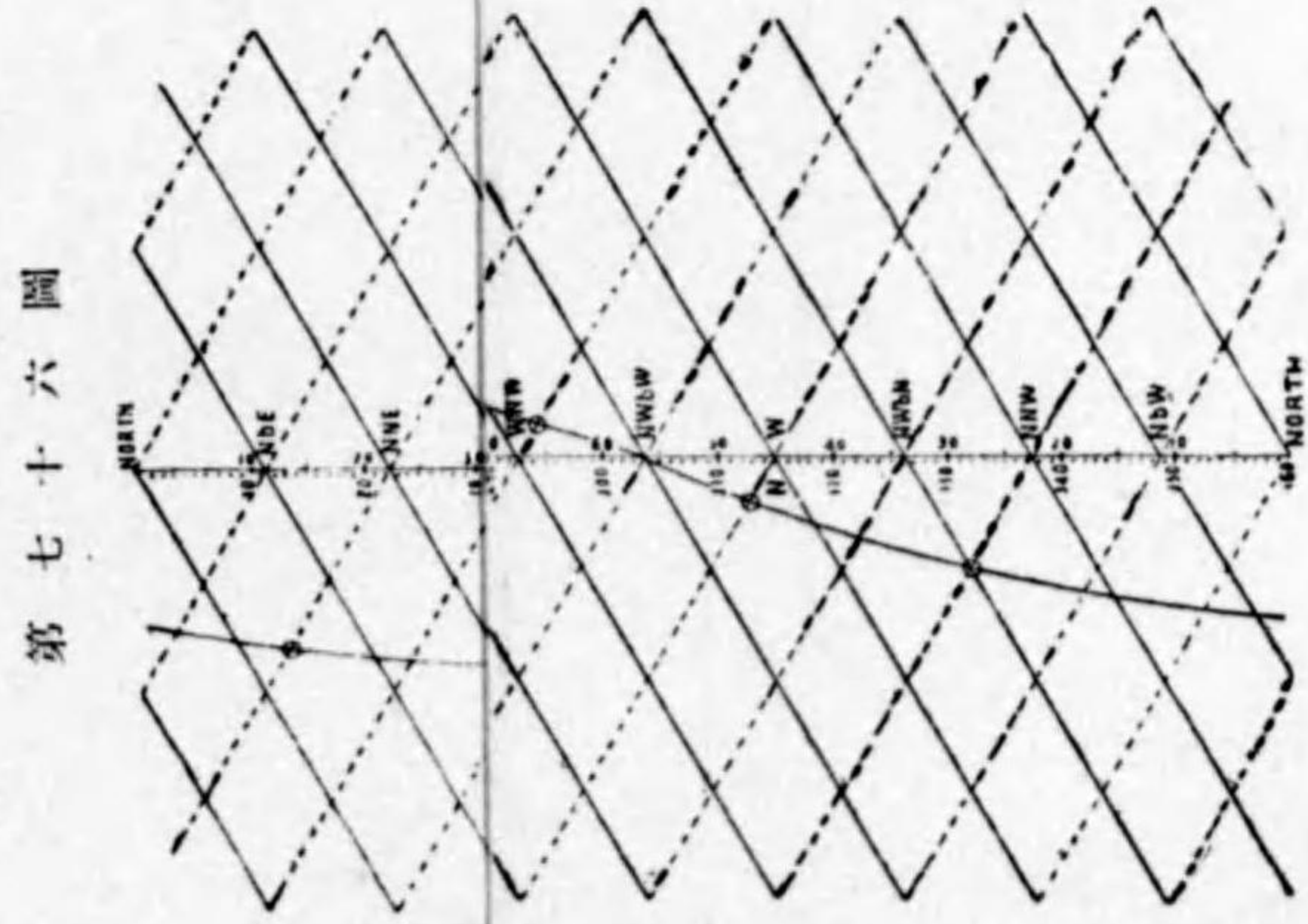

第七十六圖

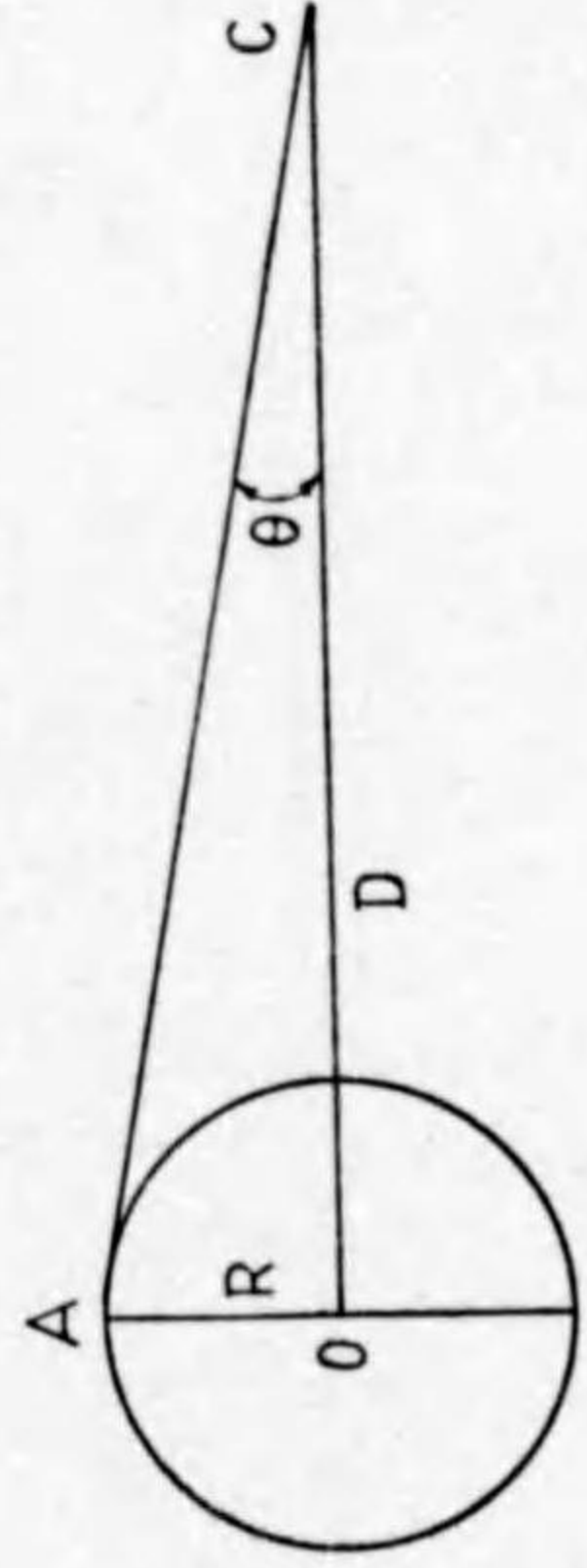

第七十五圖(甲)

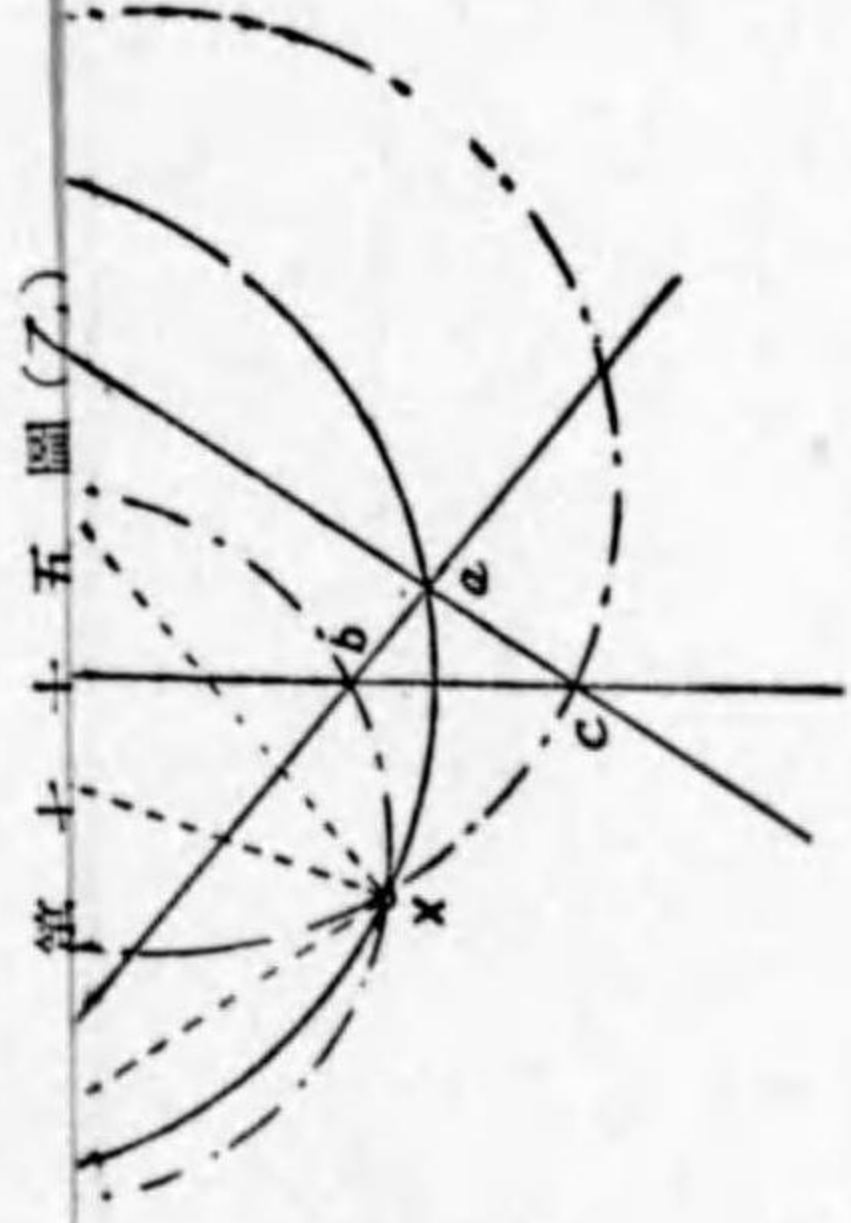

第七十五圖(乙)



第七十九圖

第七十六圖

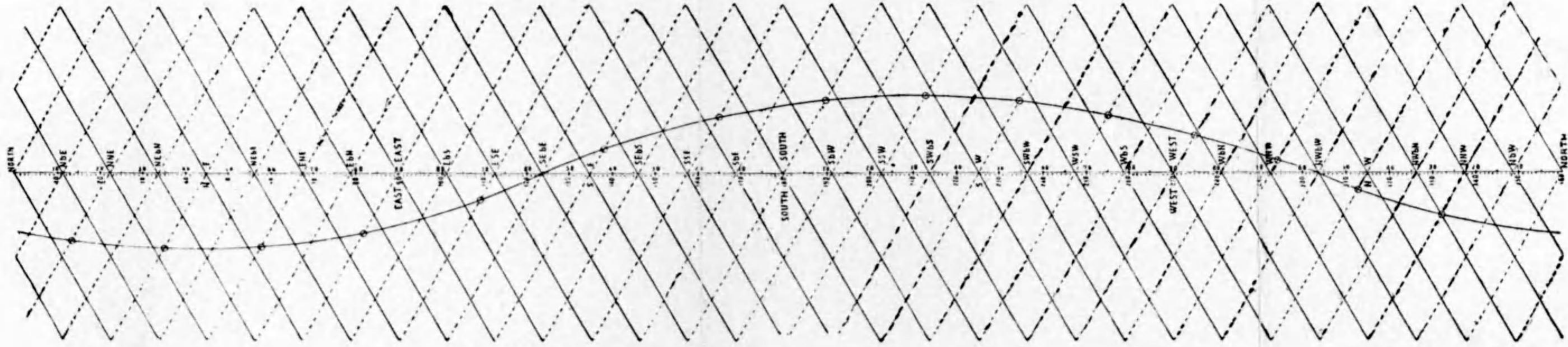

第七十五圖(甲)

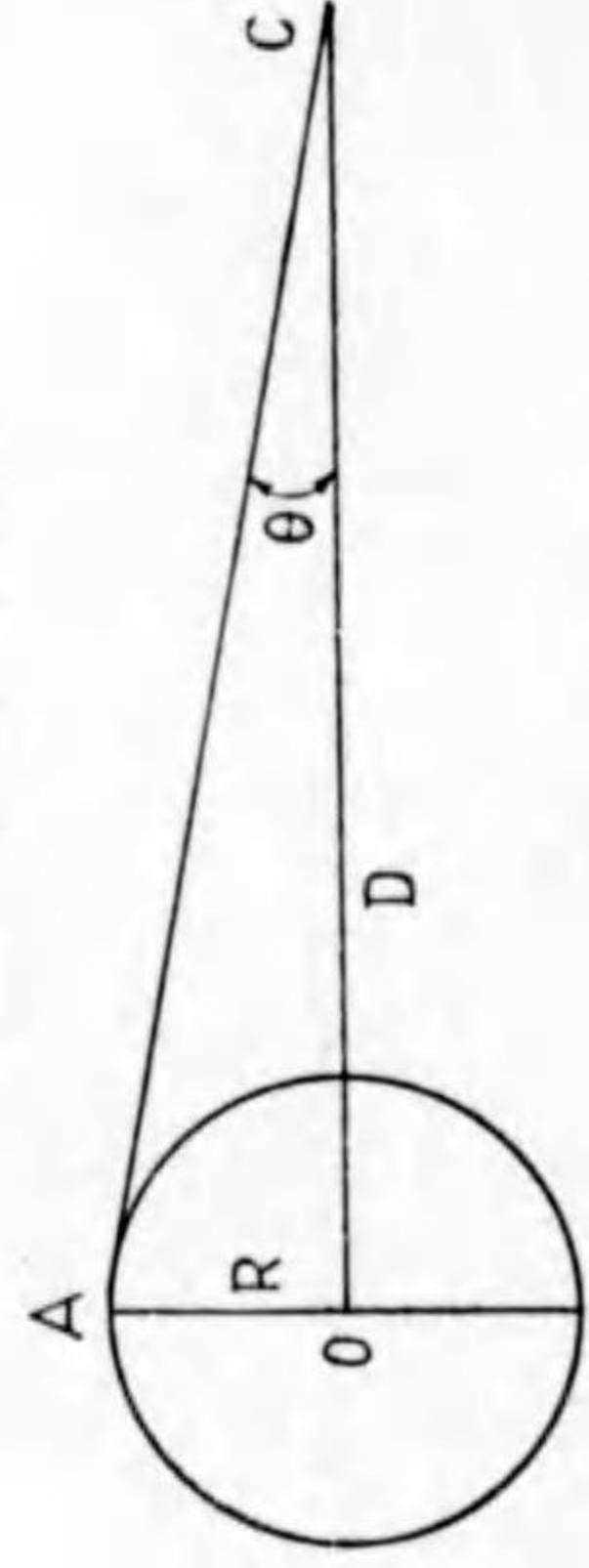

第七十五圖(乙)

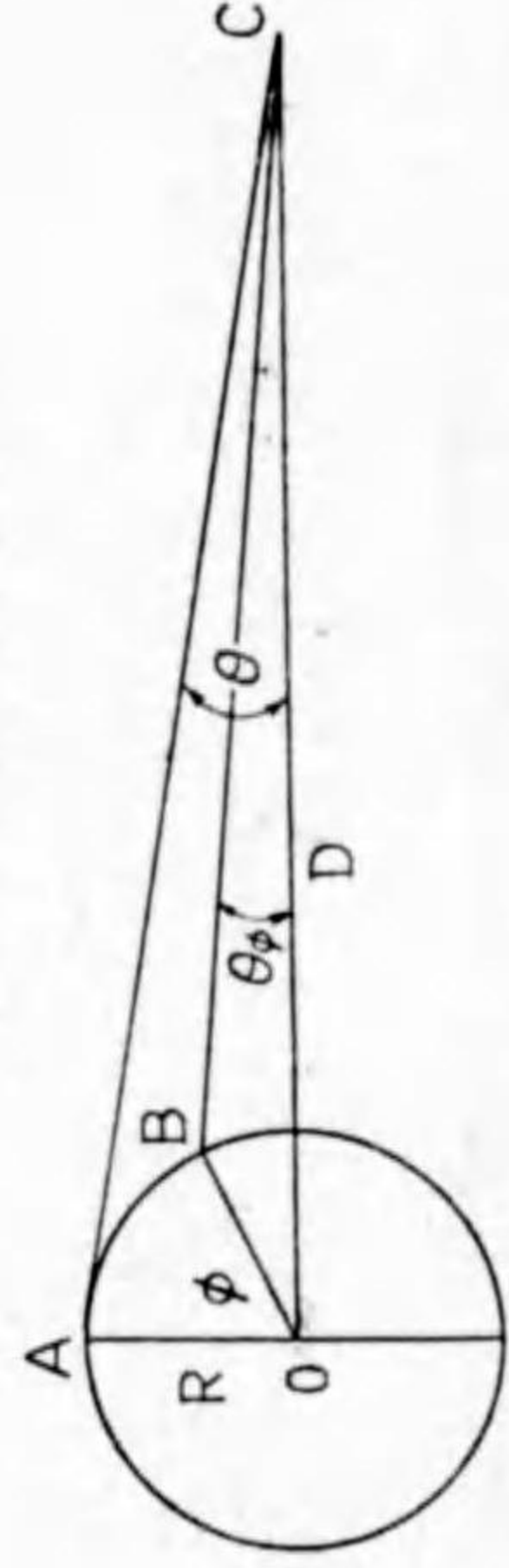

第七十七圖

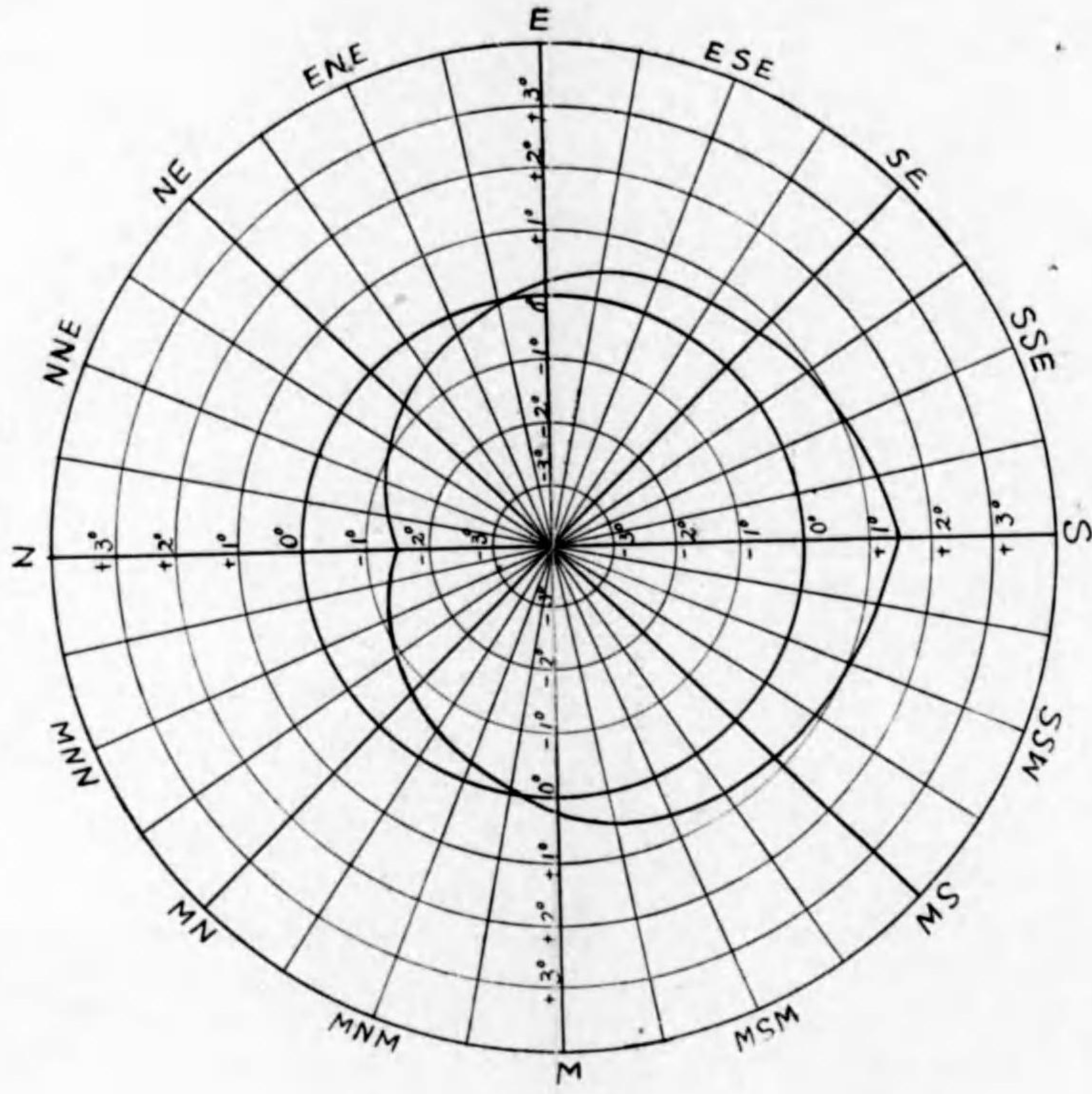

第七十八圖

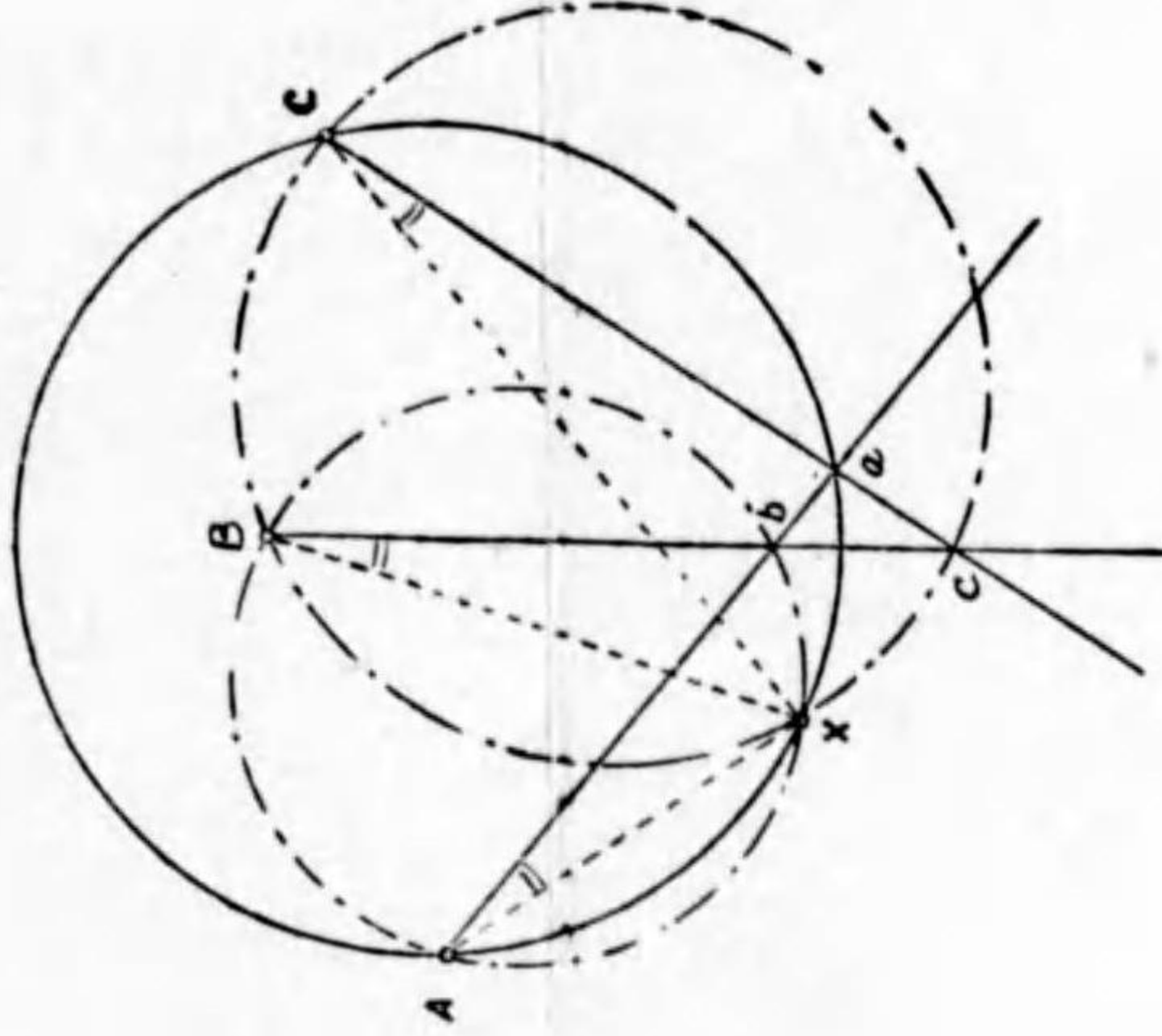

第七十九圖



第八十圖

(1) Ship built head South
on Magnetic Equator

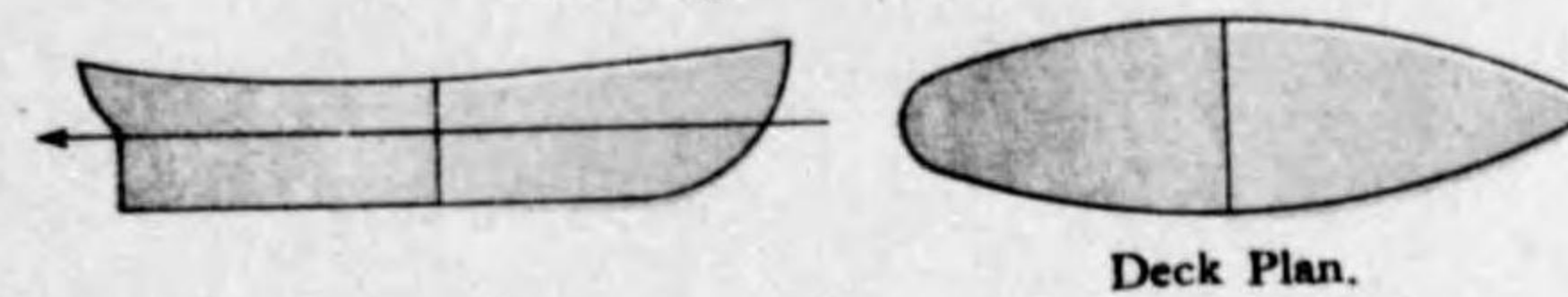

(2) Ship built head North
in Japan.



(3) Ship built head East
in Japan. Dip +50°

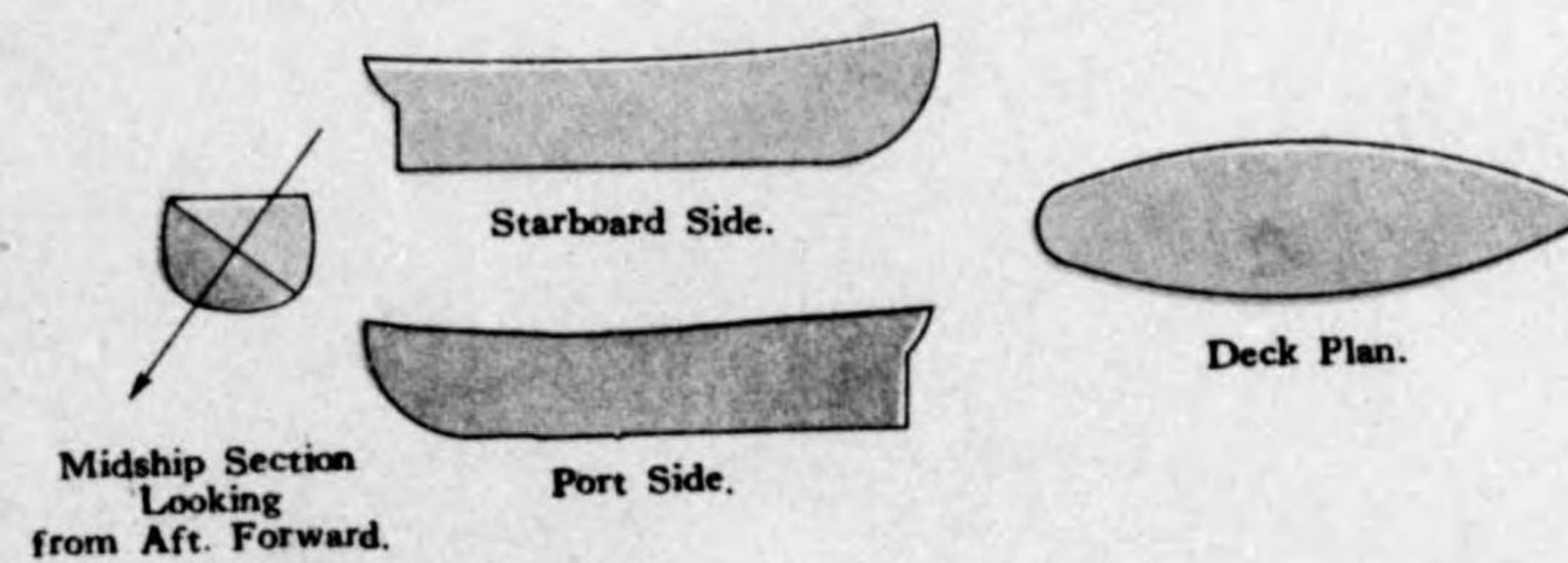

(4) Ship built head N.W.
in Japan.

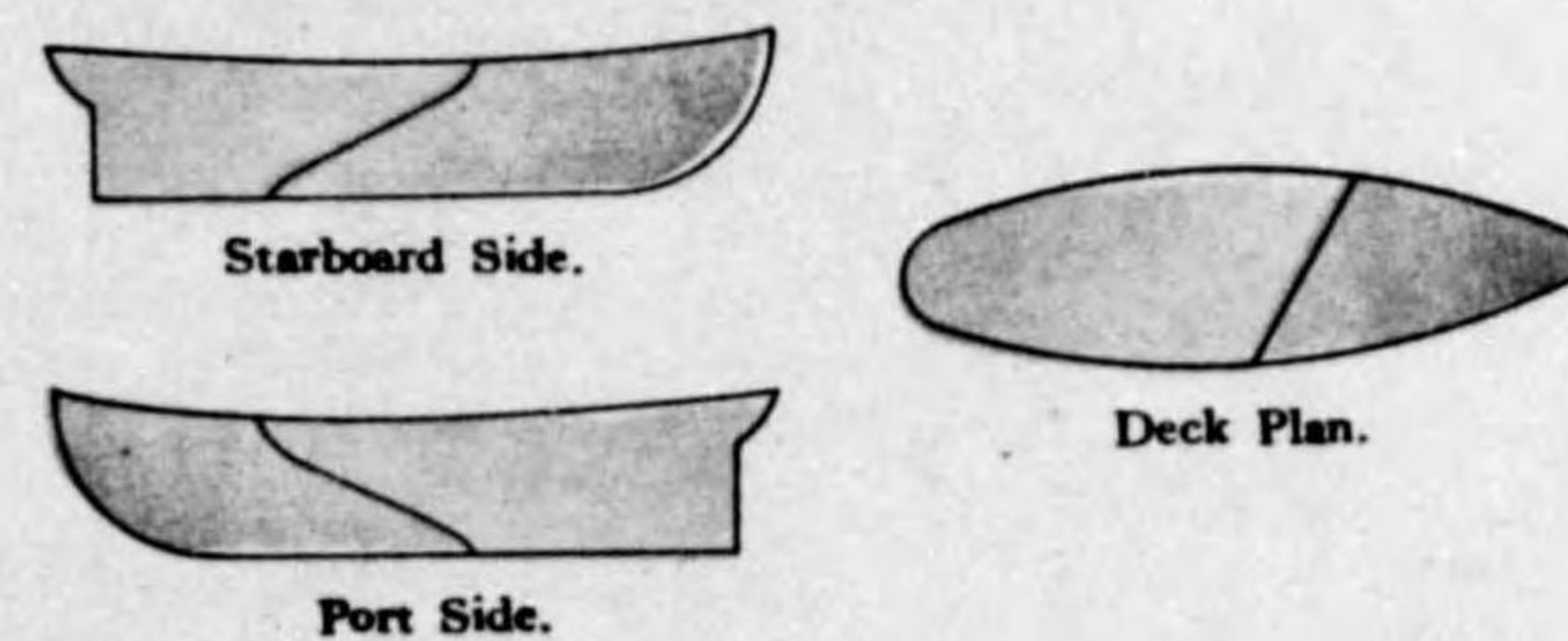

第八十一圖

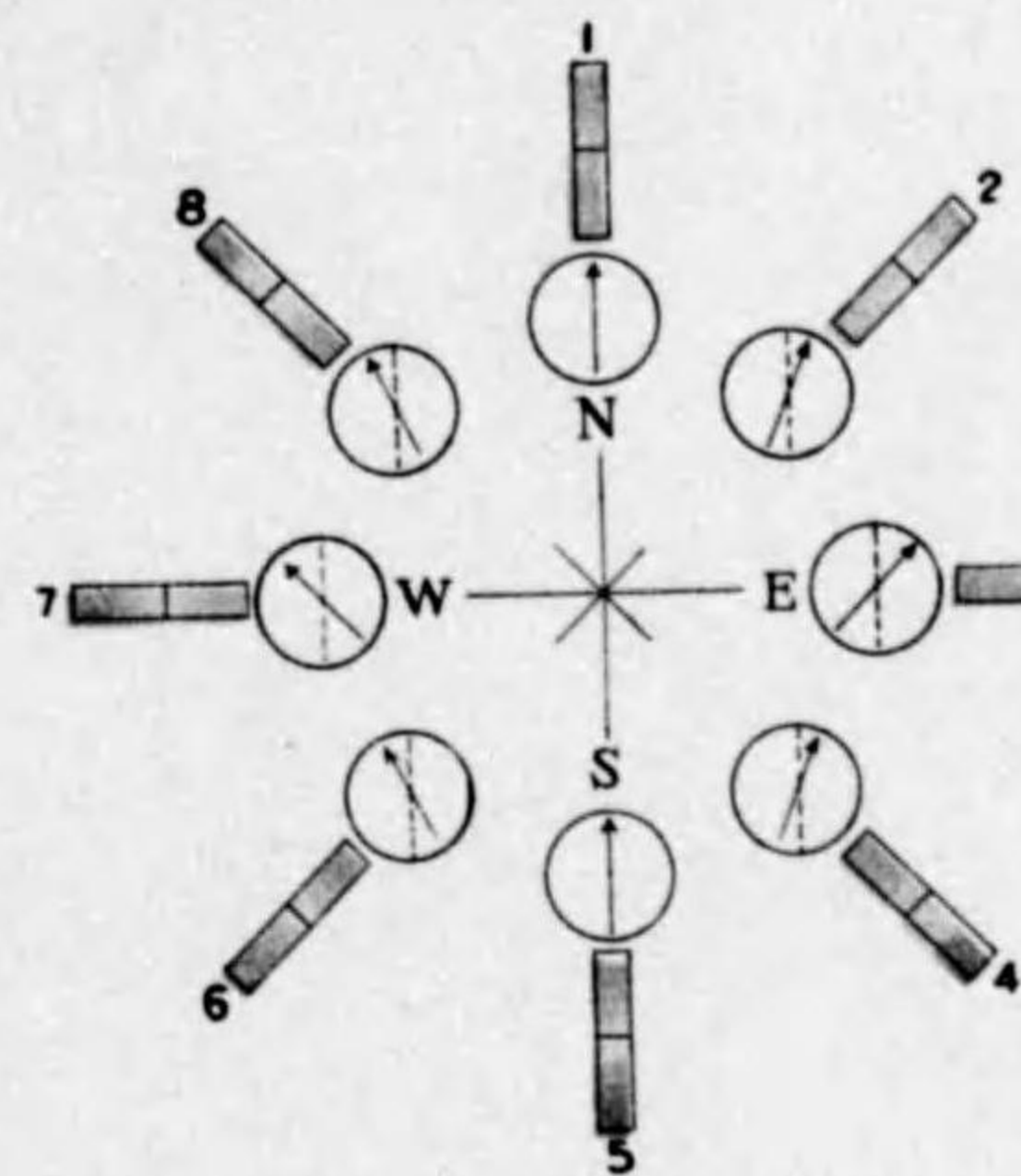

第八十二圖

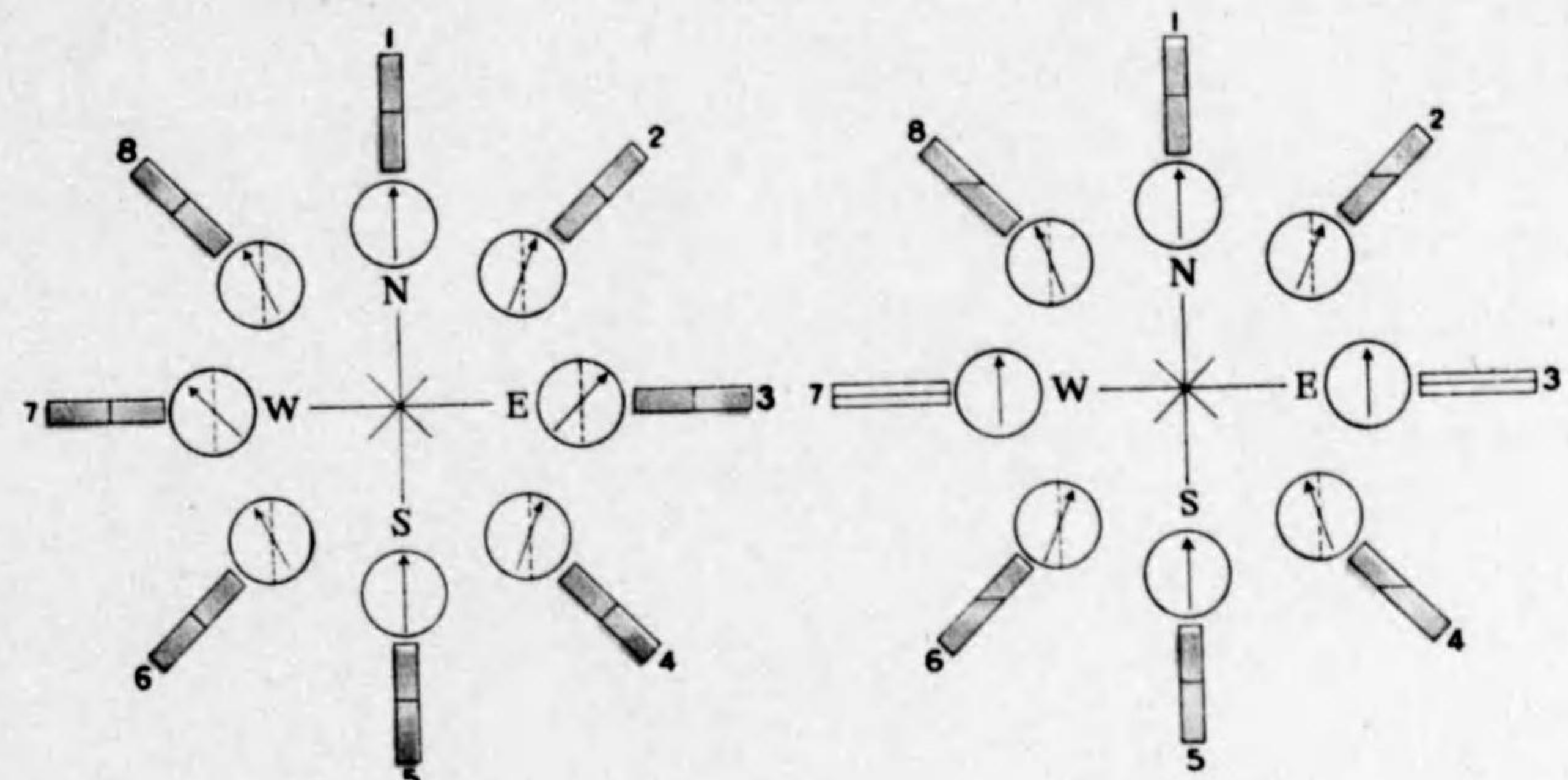

第八十三圖甲

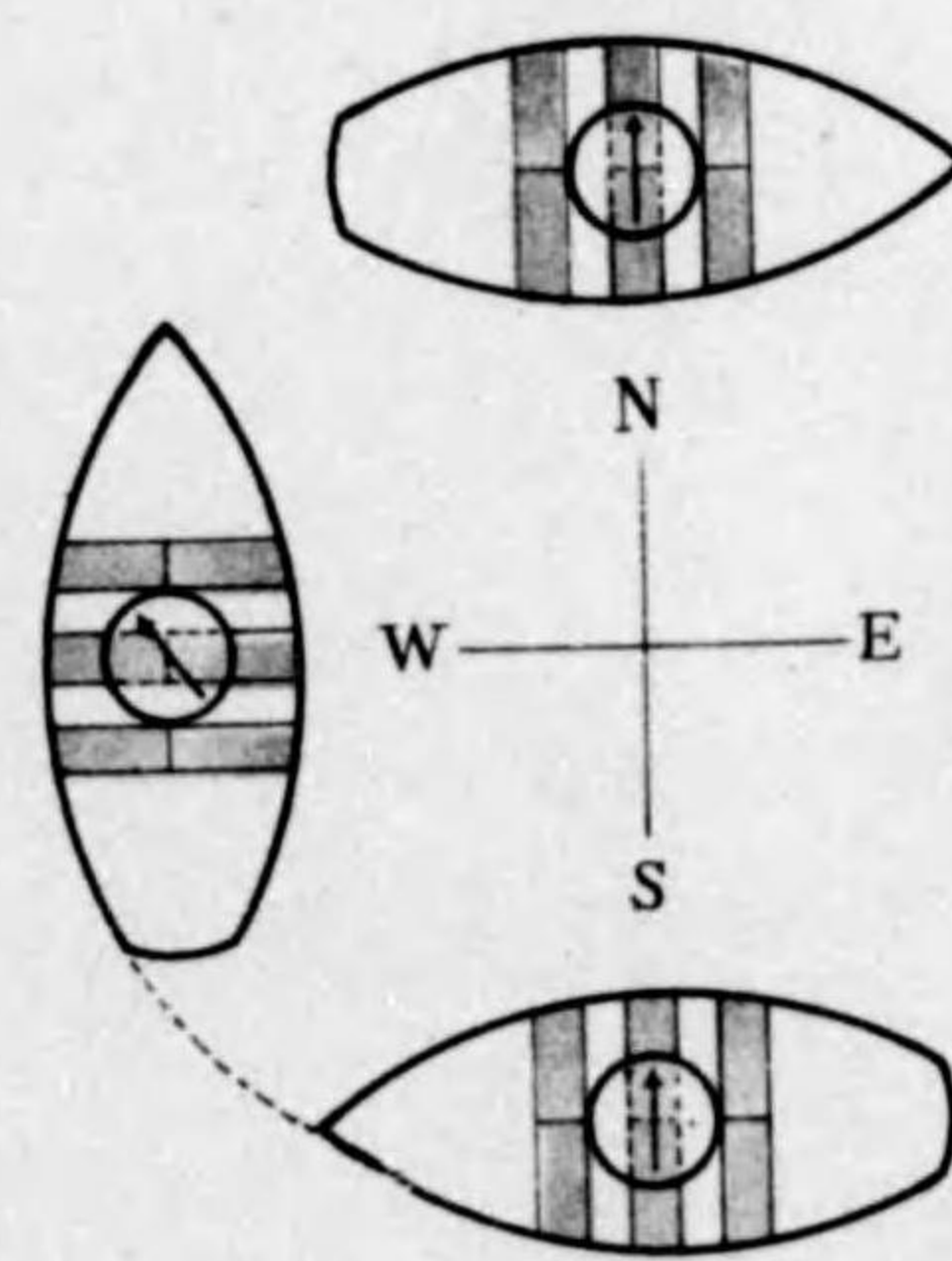

第八十三圖乙

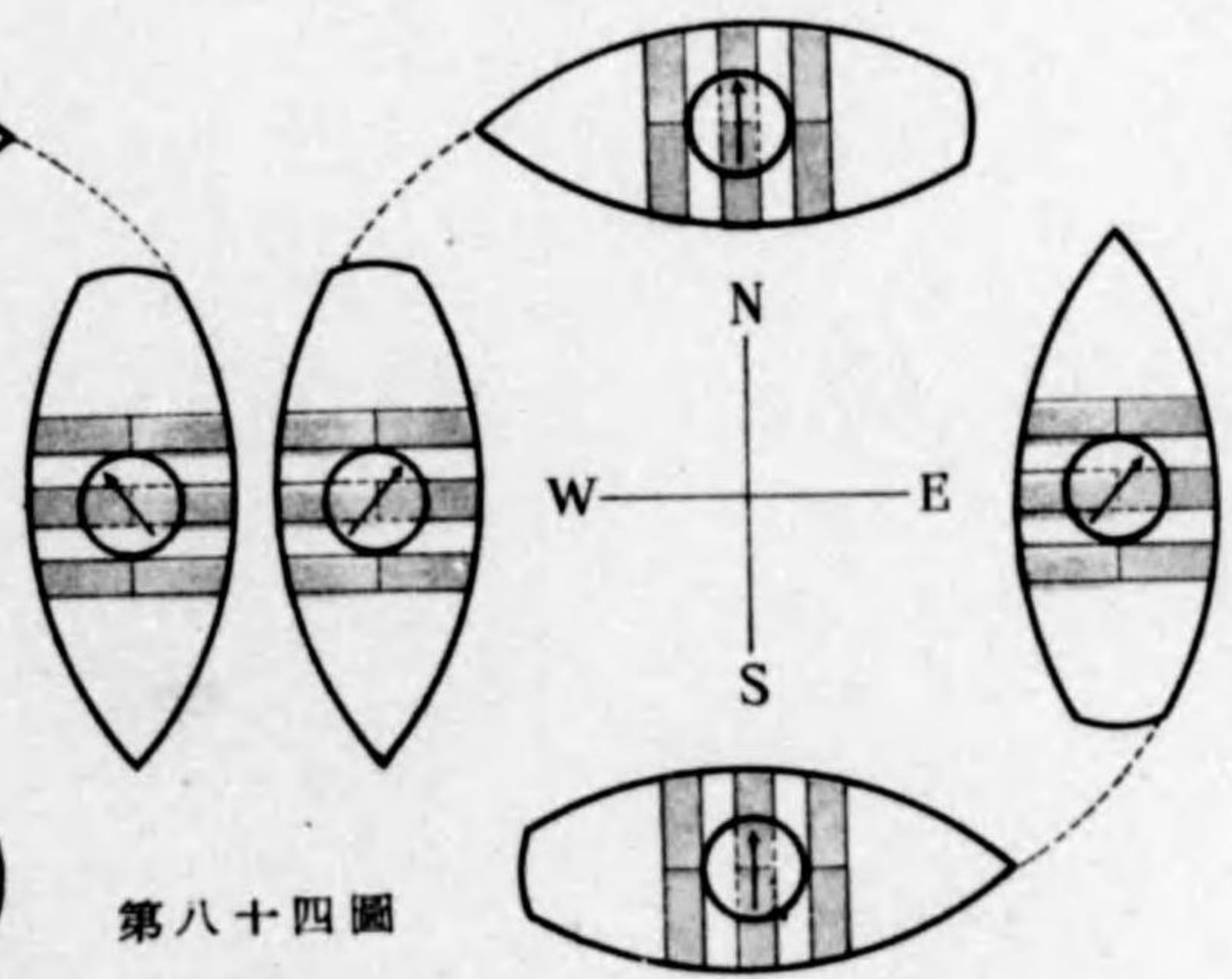

第八十四圖

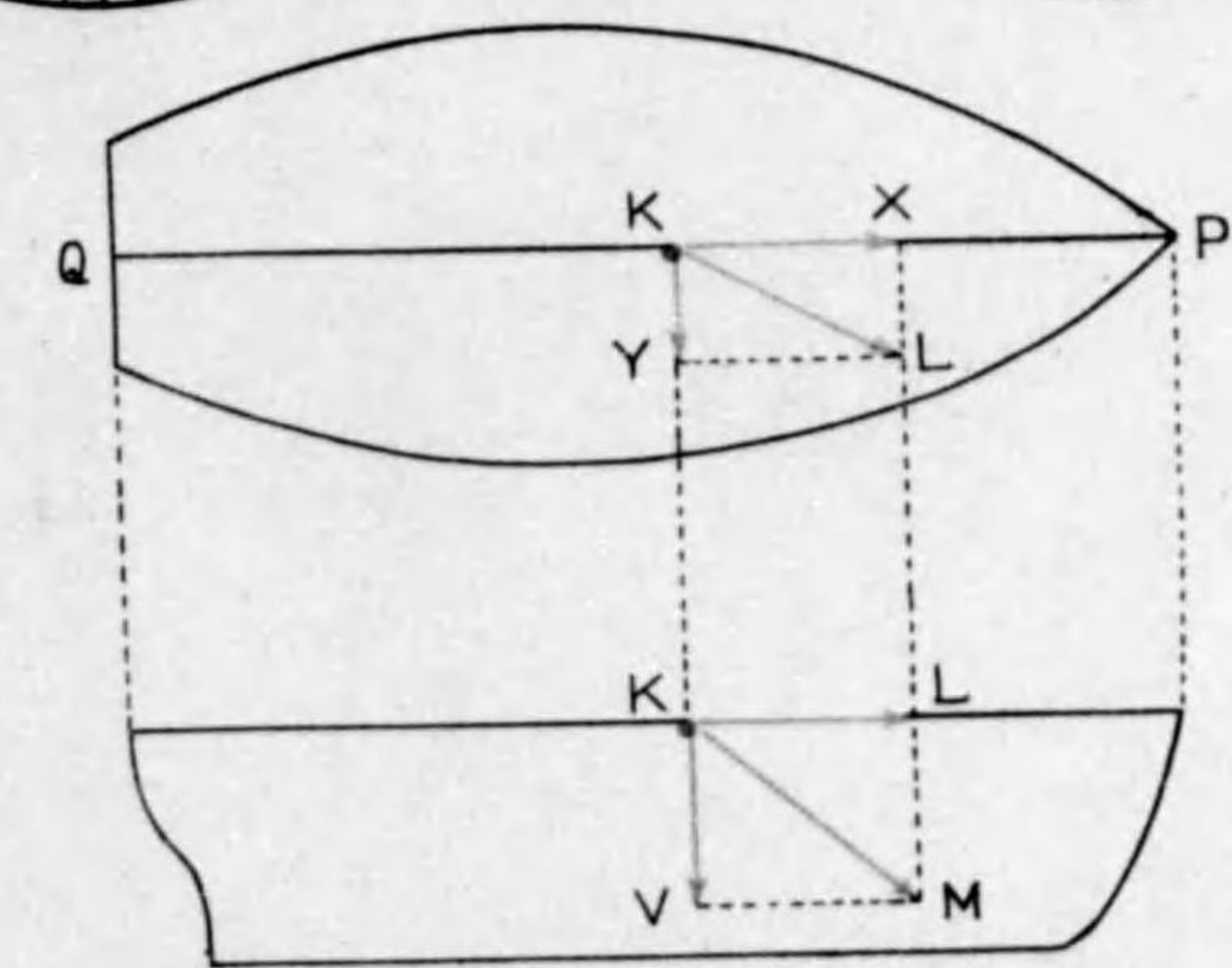

+ B 第八十五圖甲

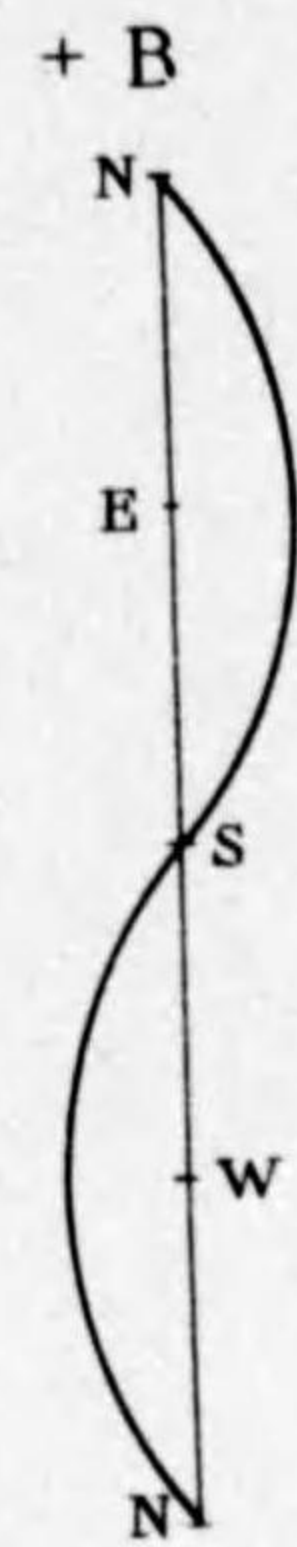
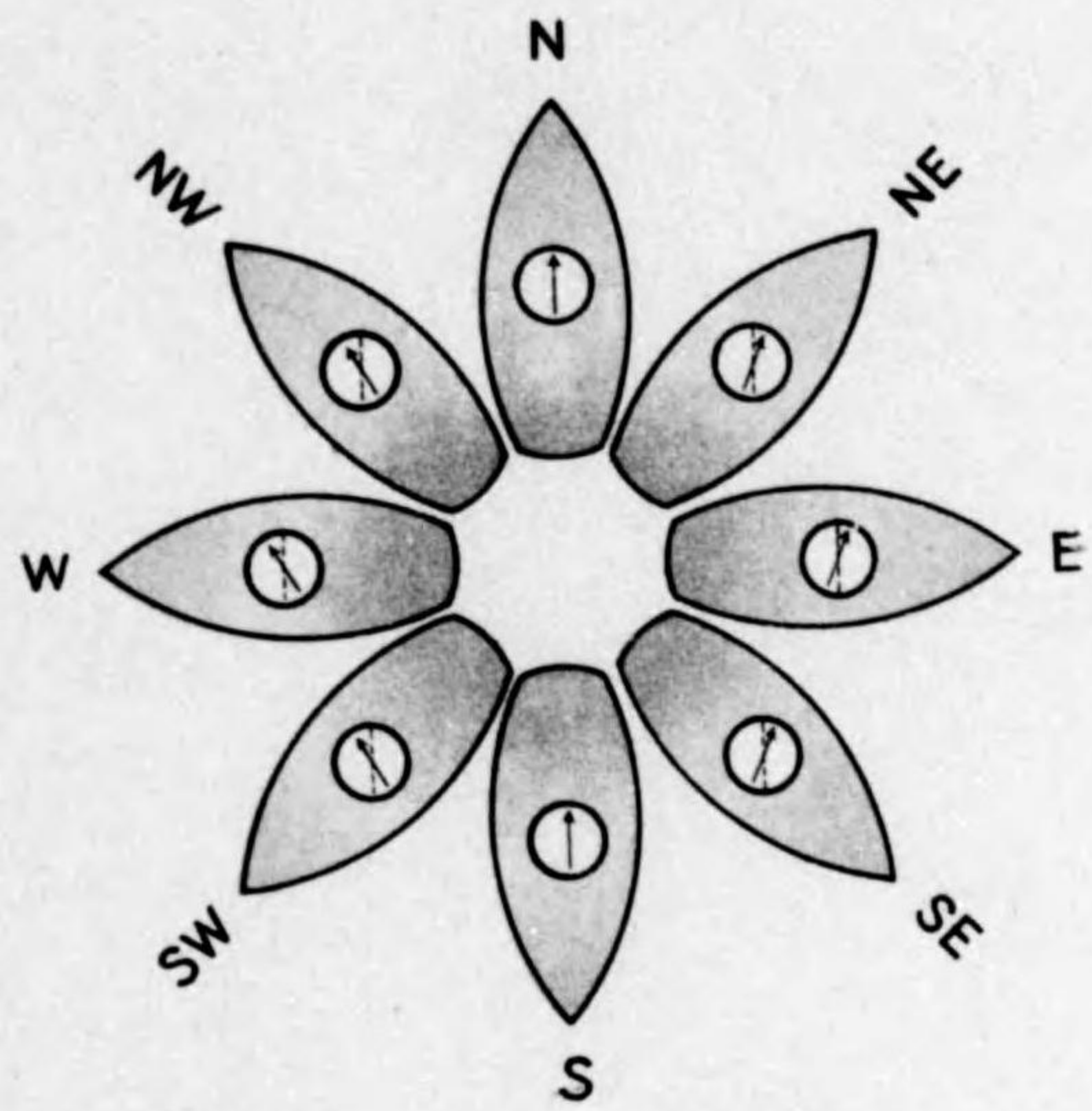

- B 第八十五圖乙

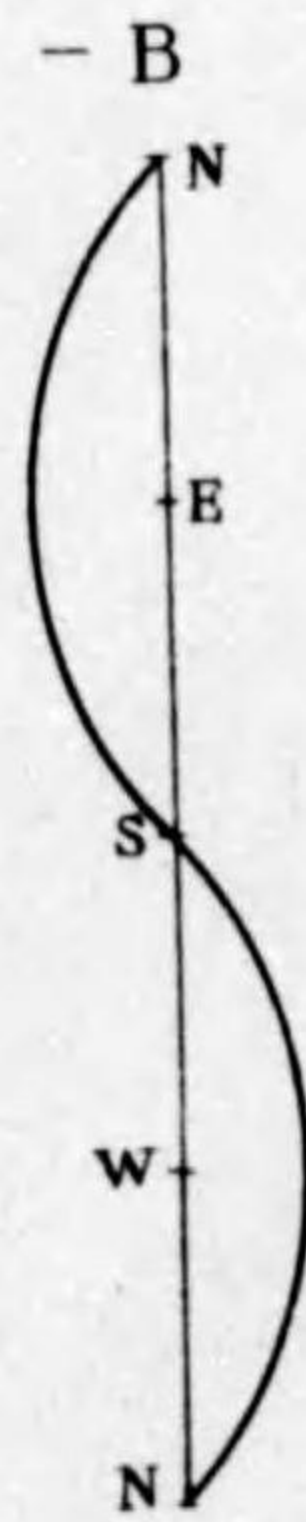
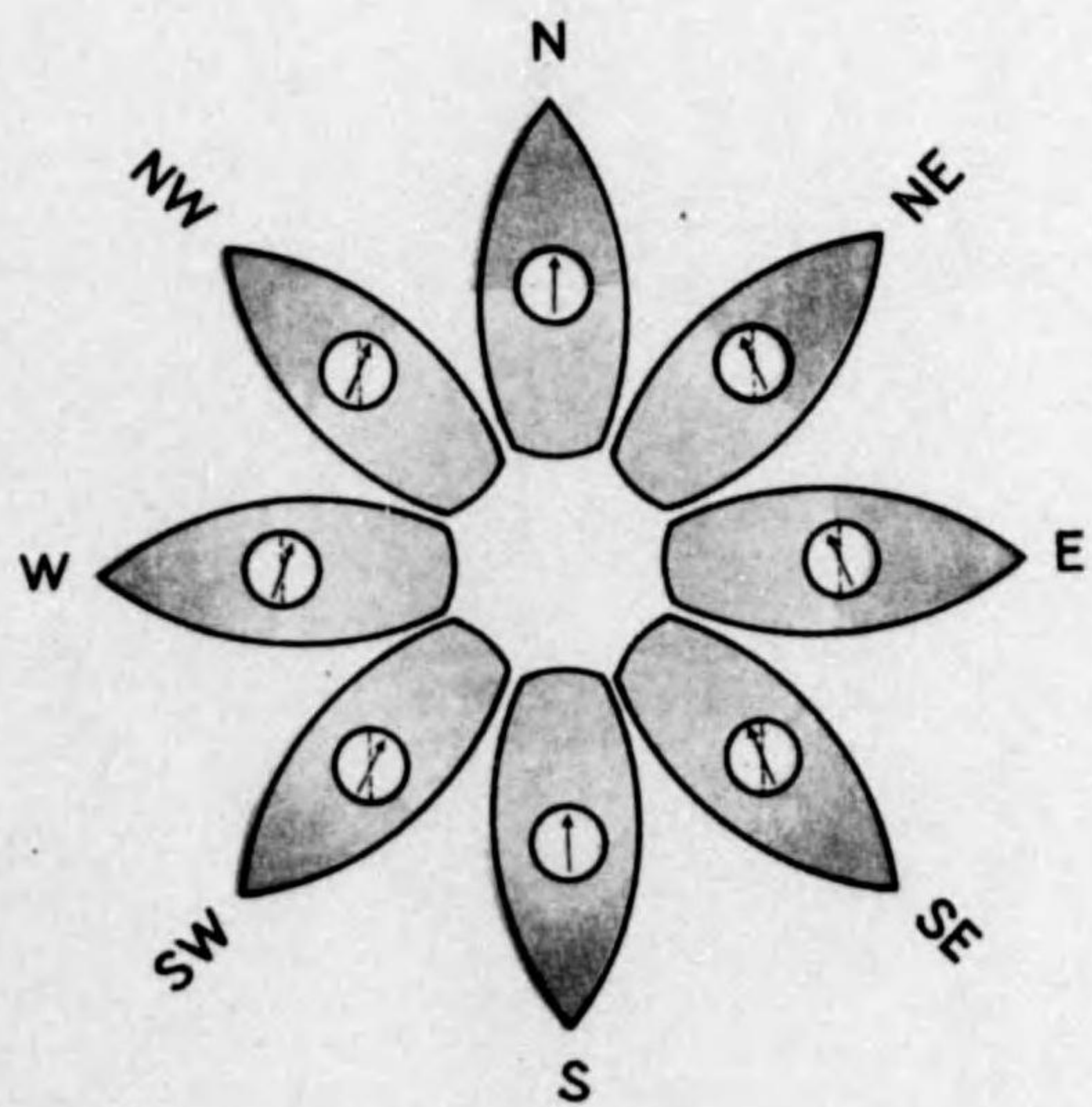

- B 第八十六圖甲

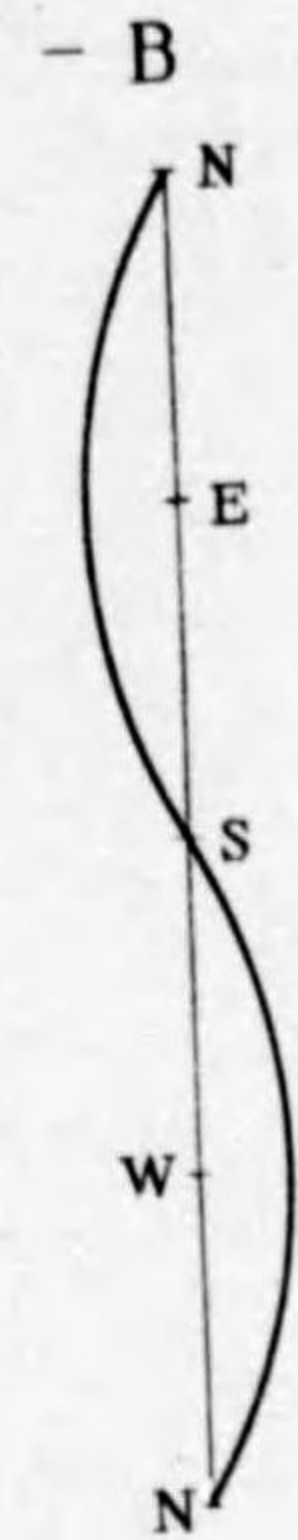
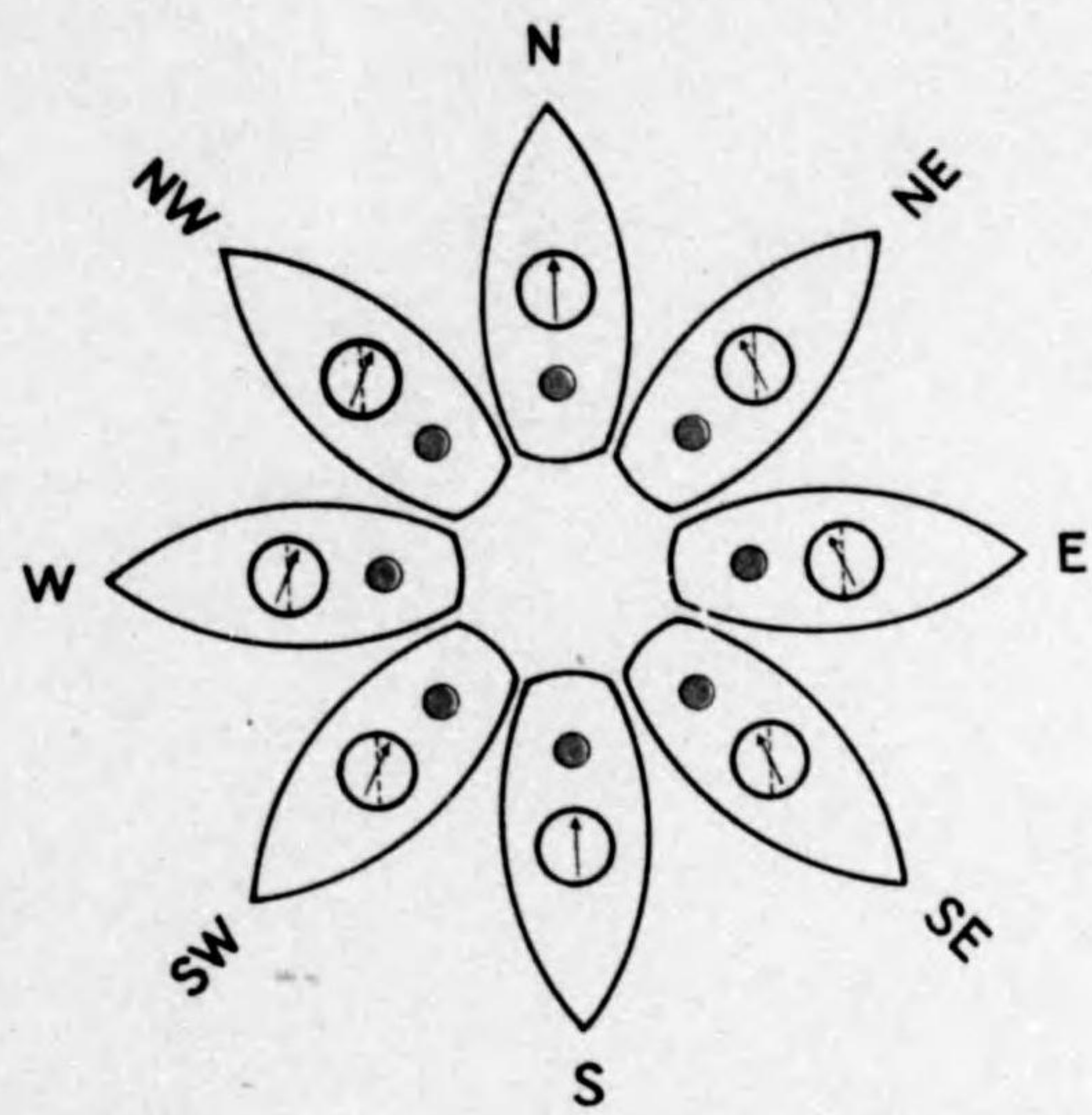

+ B 第八十六圖乙

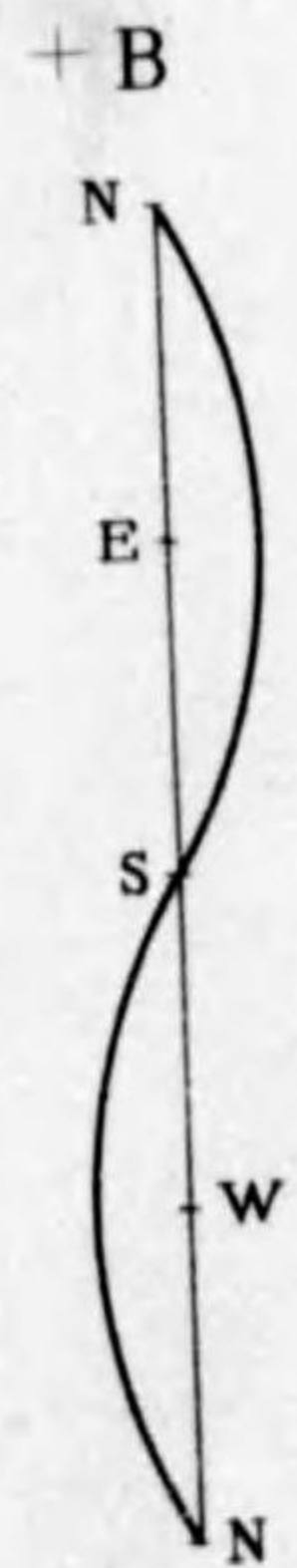
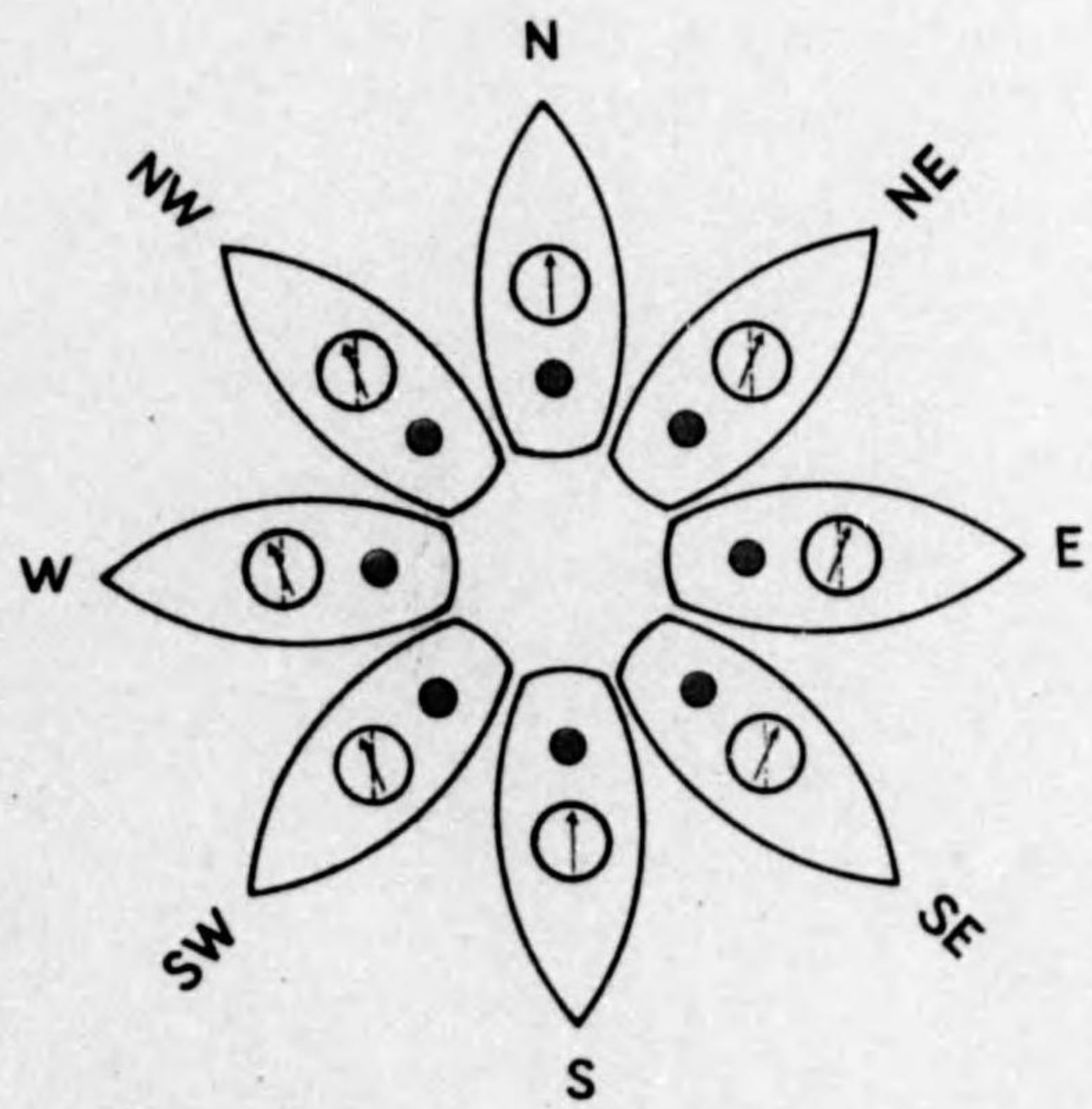

+ C 第八十七圖甲

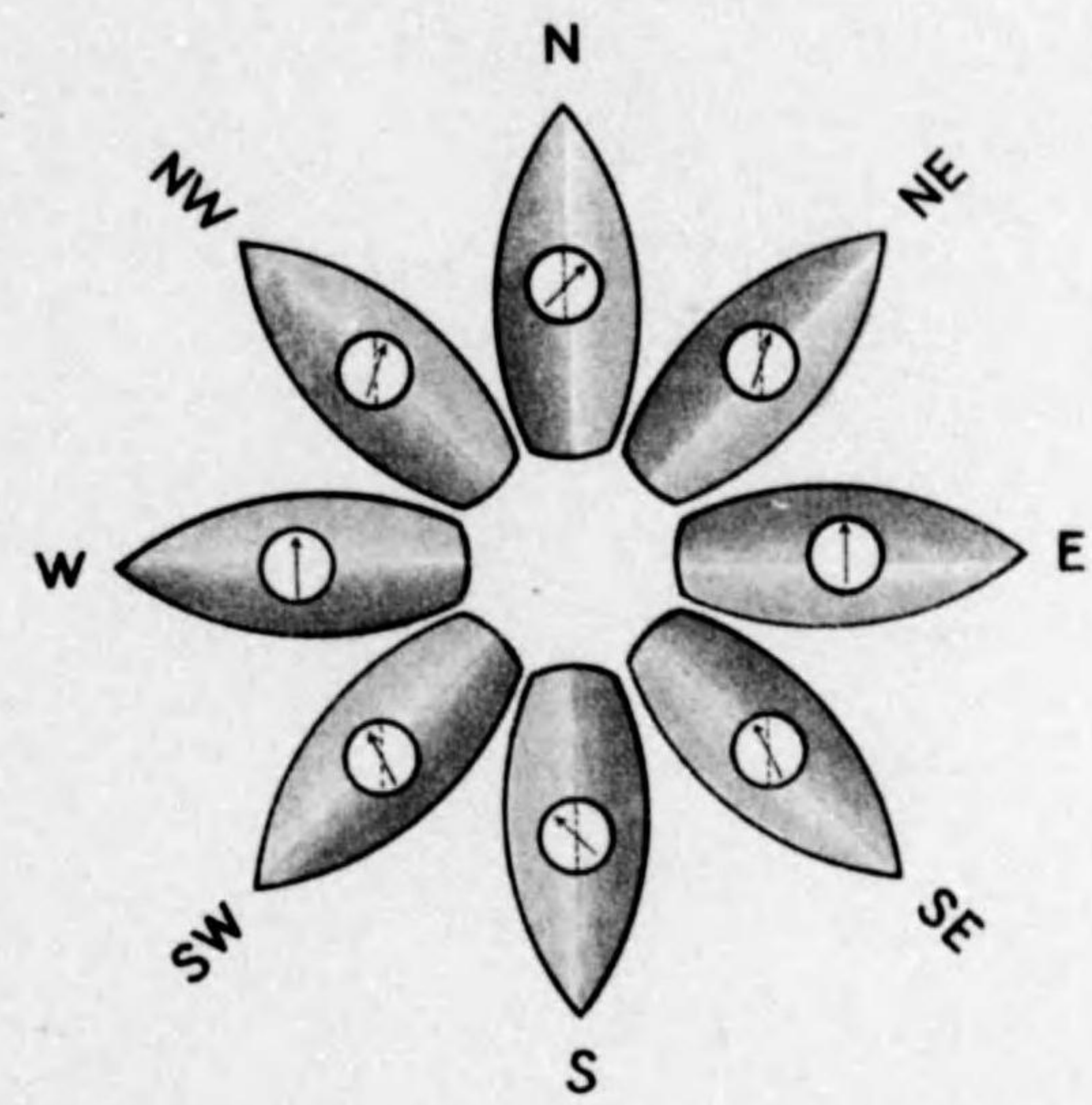

+ C

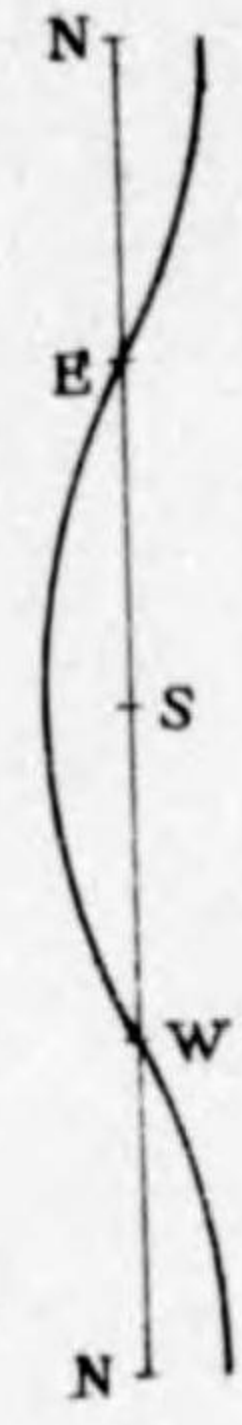

- C 第八十七圖乙

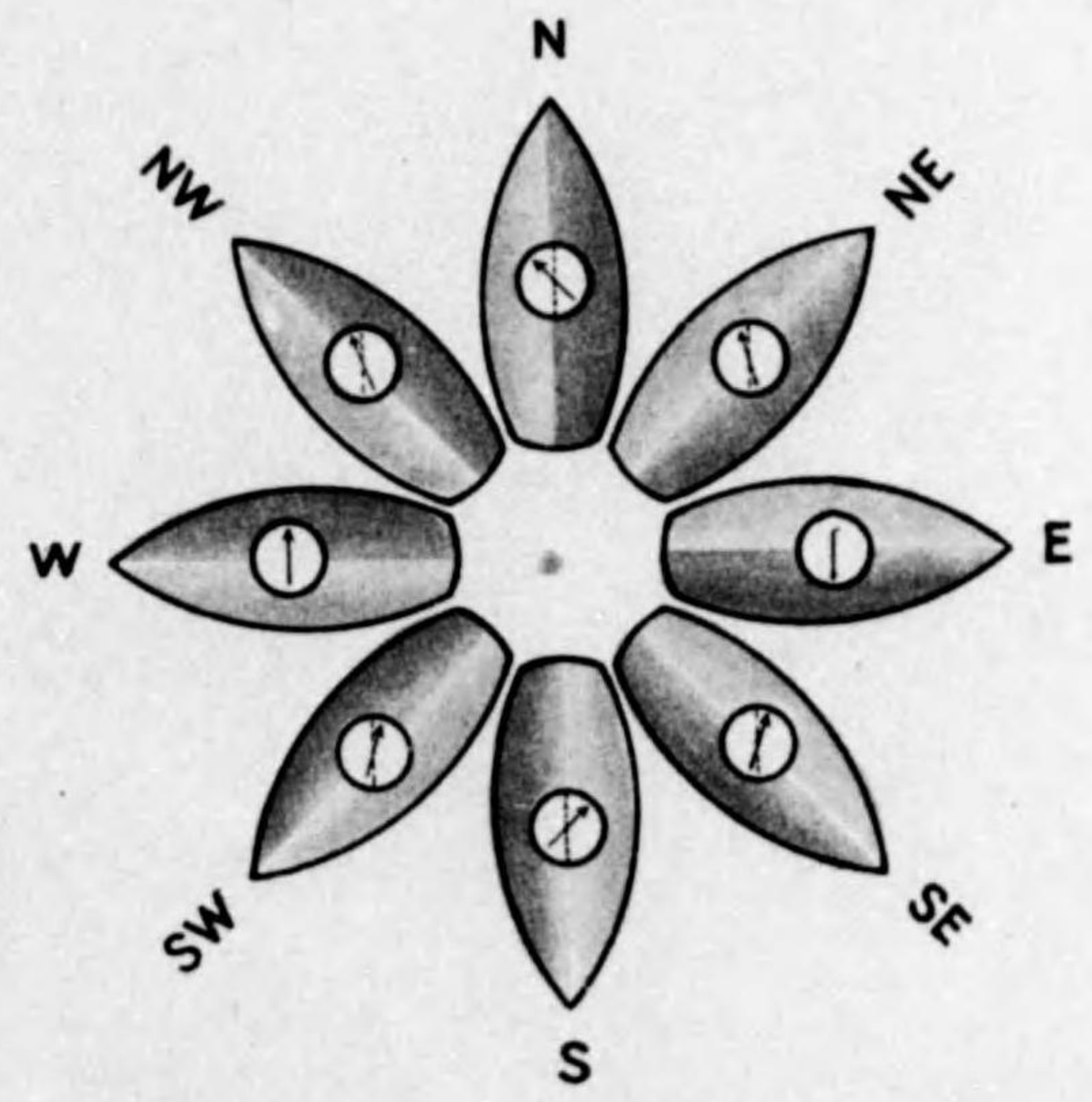

- C



+D 第八十八圖甲

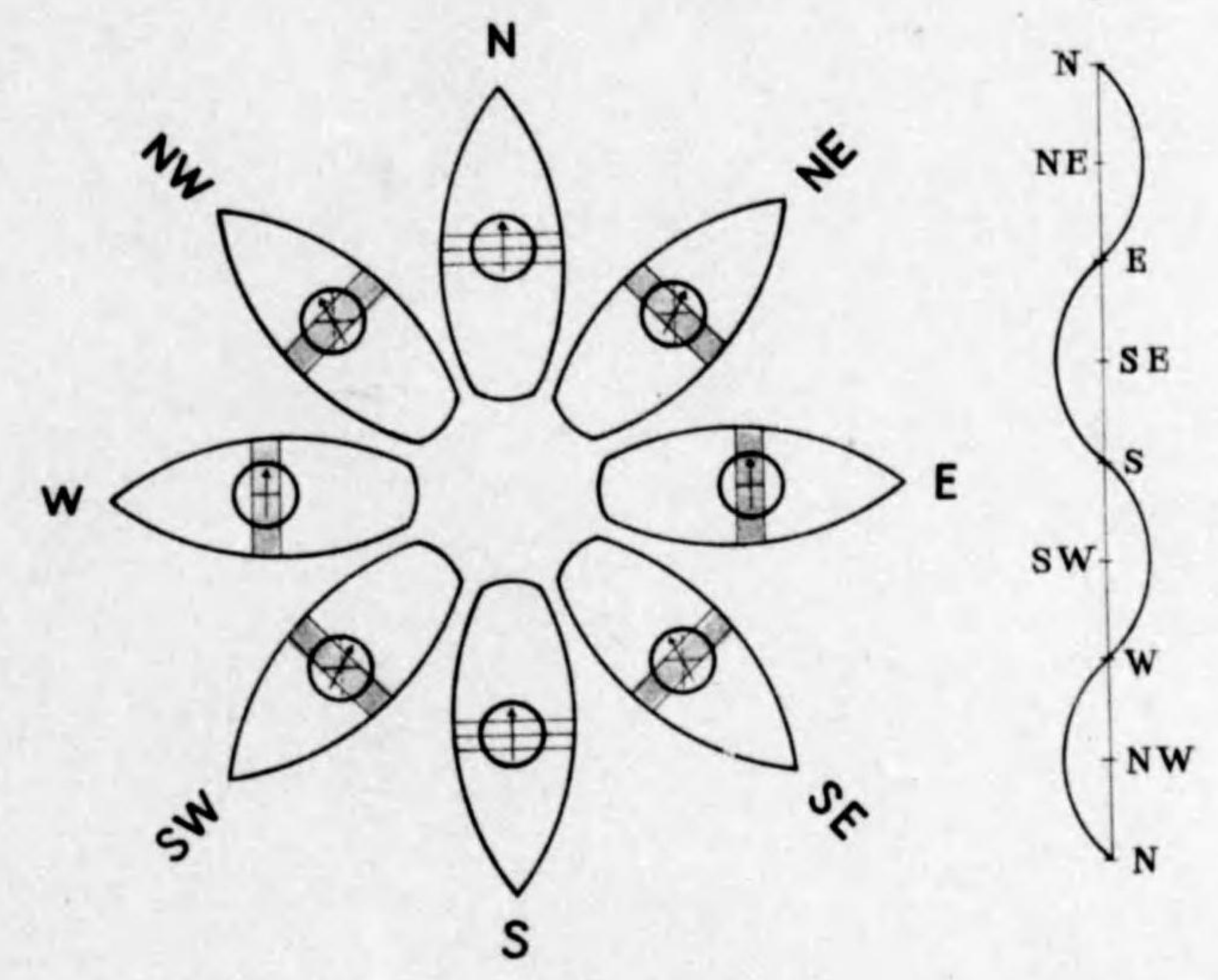

-D 第八十八圖乙

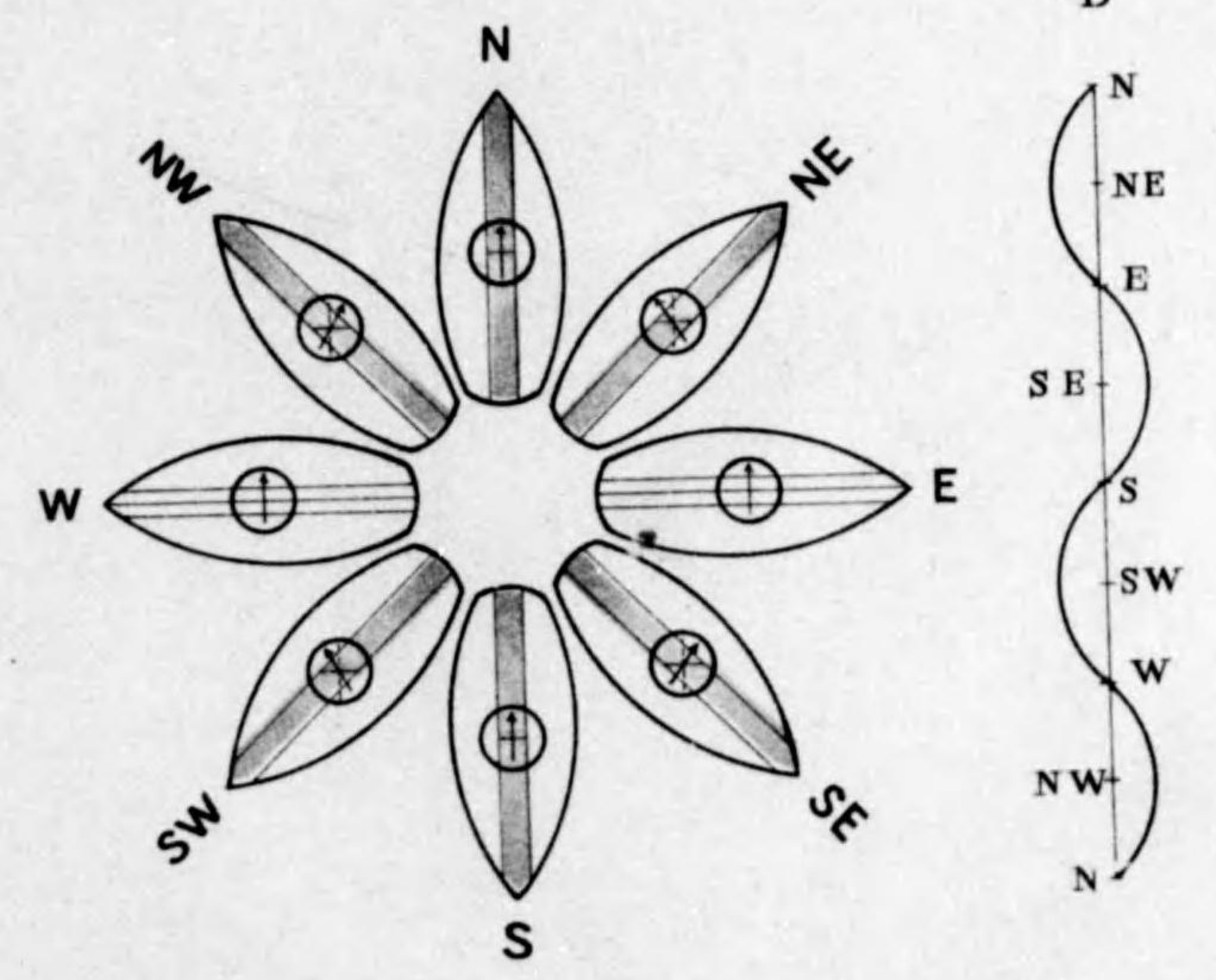

第八十九圖甲

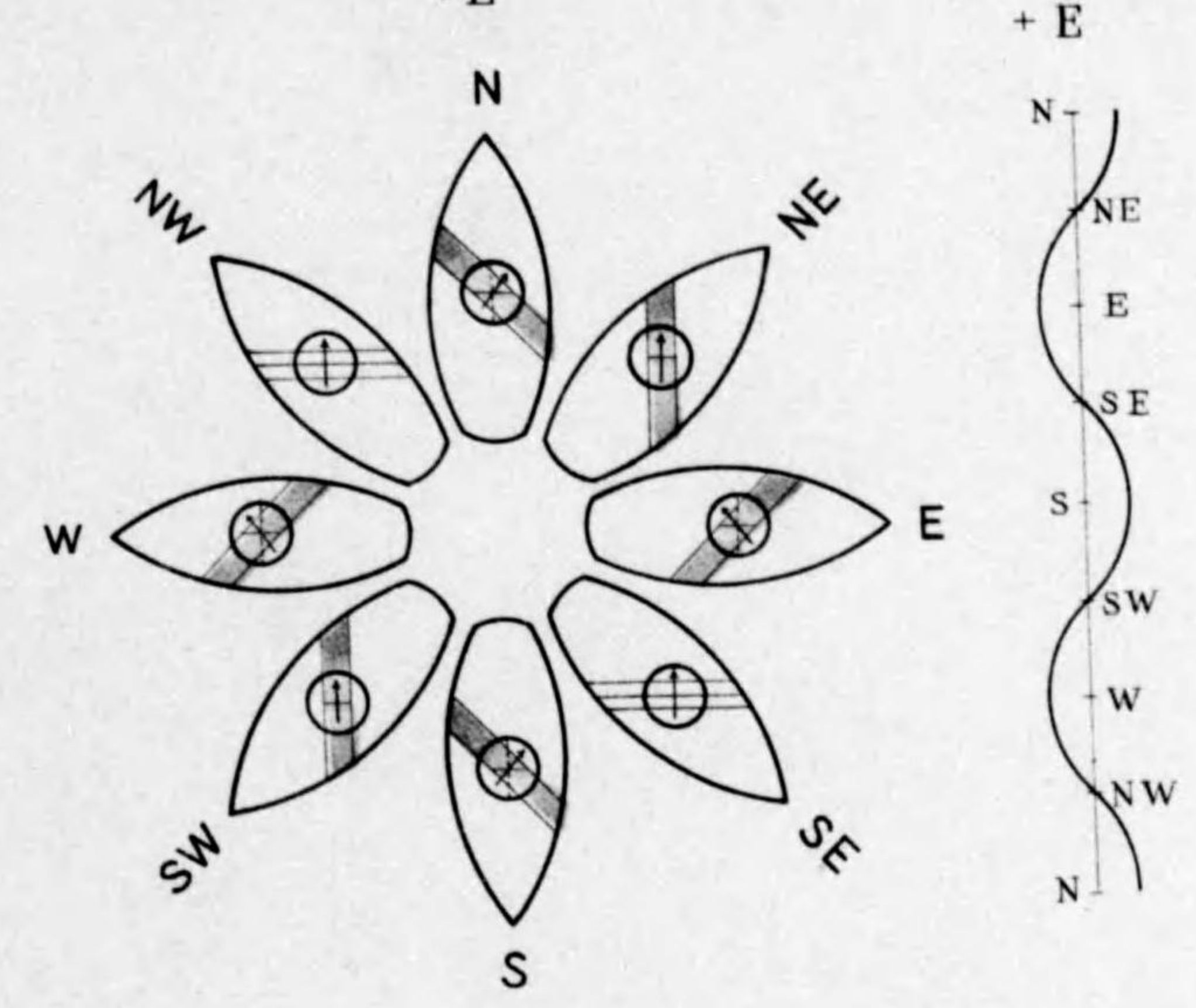

第八十九圖乙

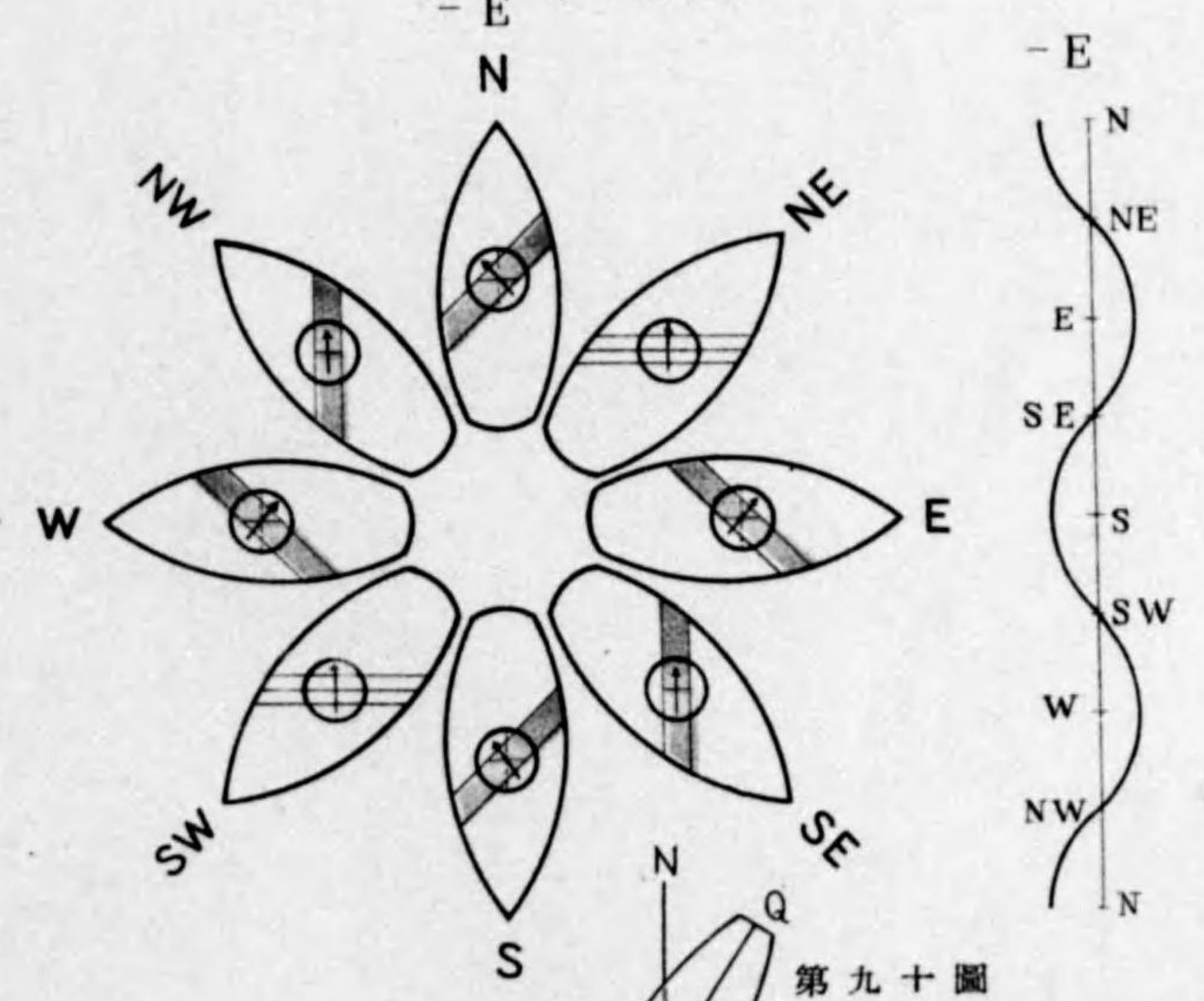

第九十圖

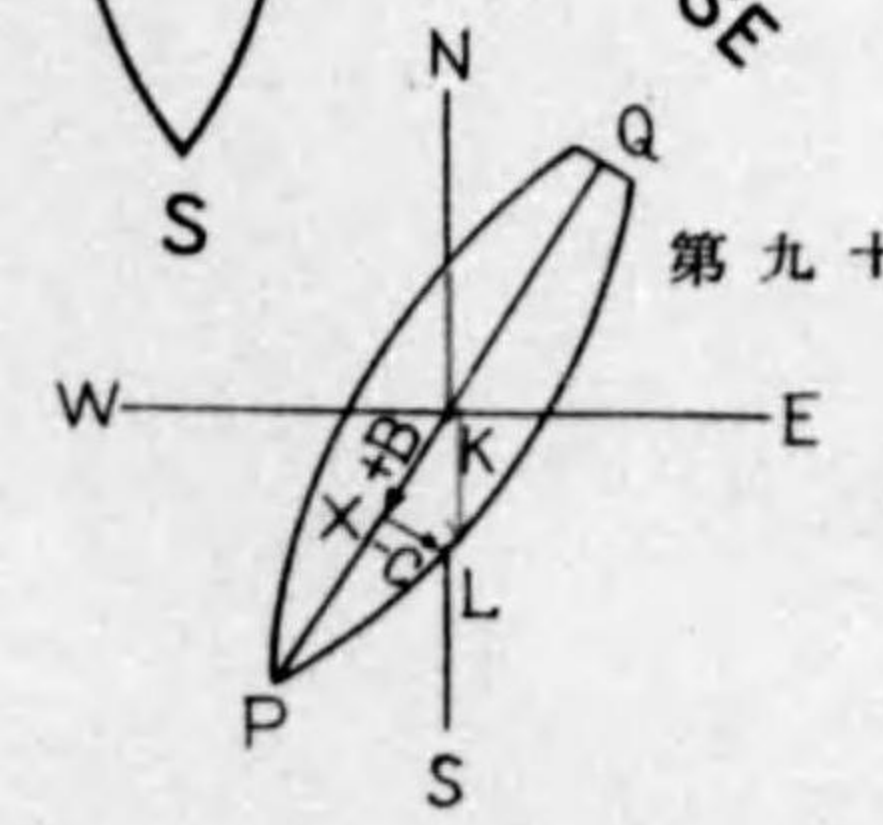

第九十一圖

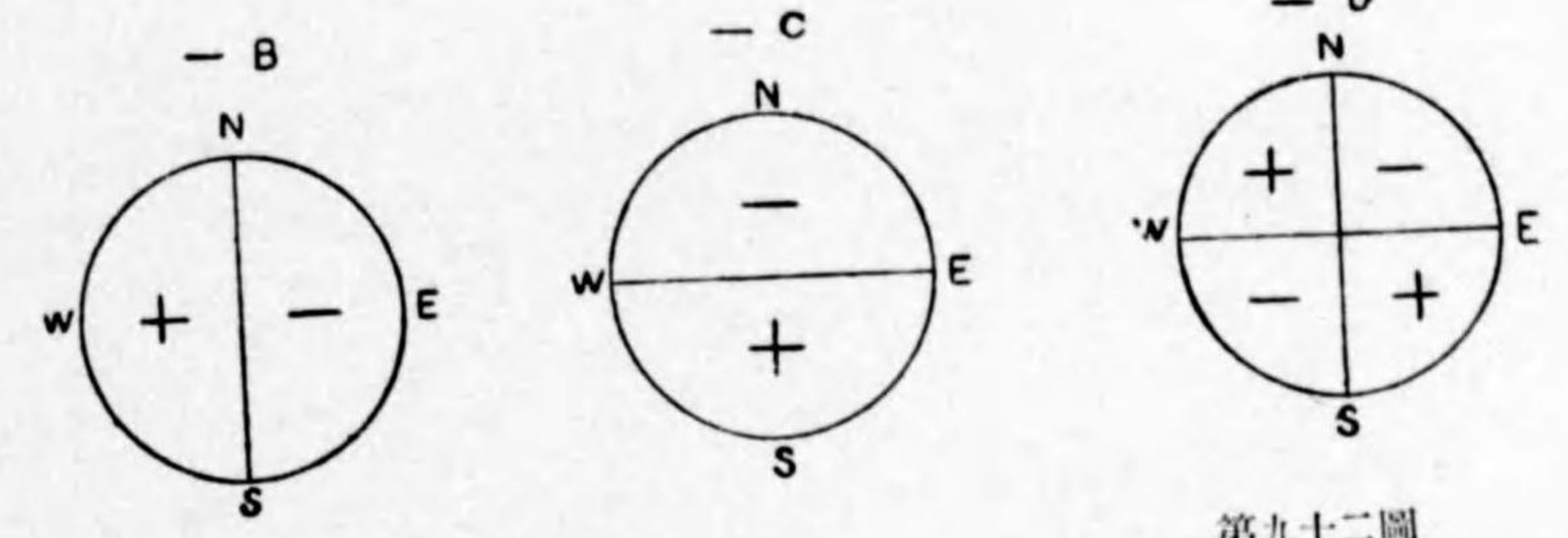
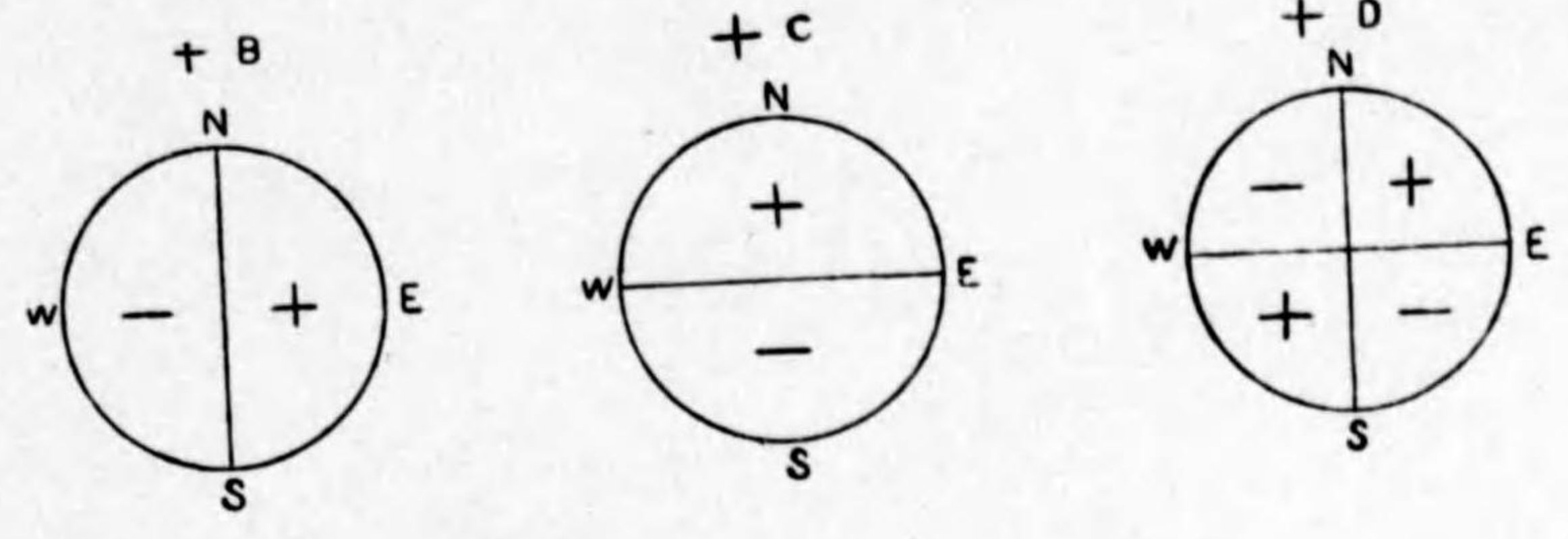

第九十二圖

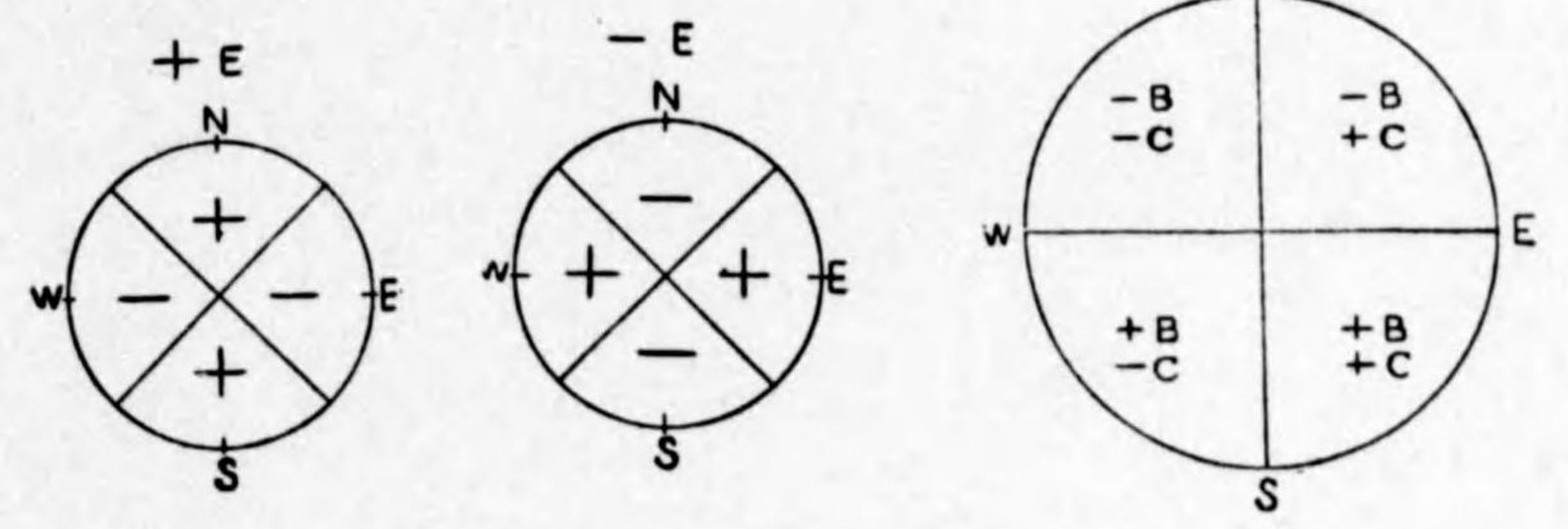

第九十三圖

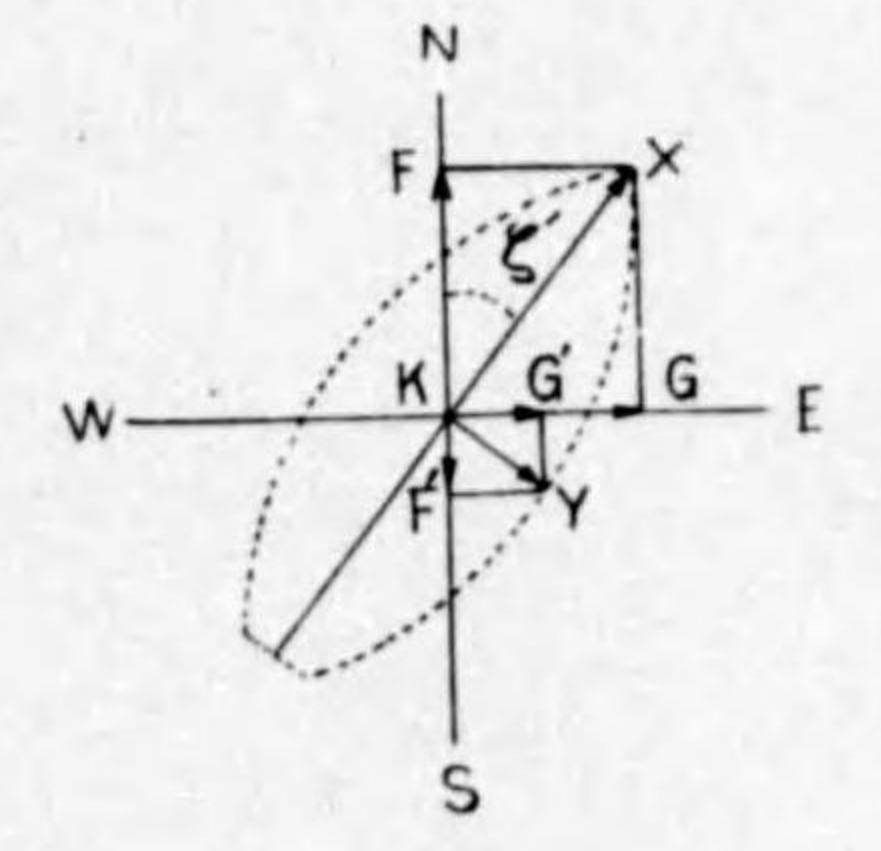

第九十四圖

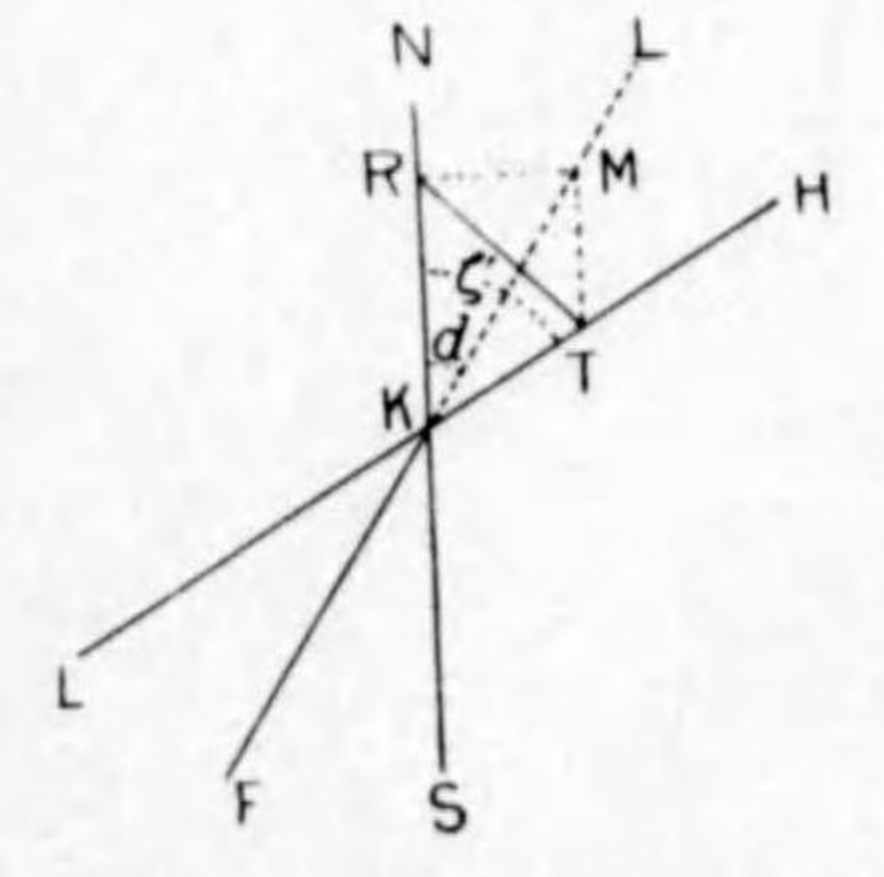

第九十五圖

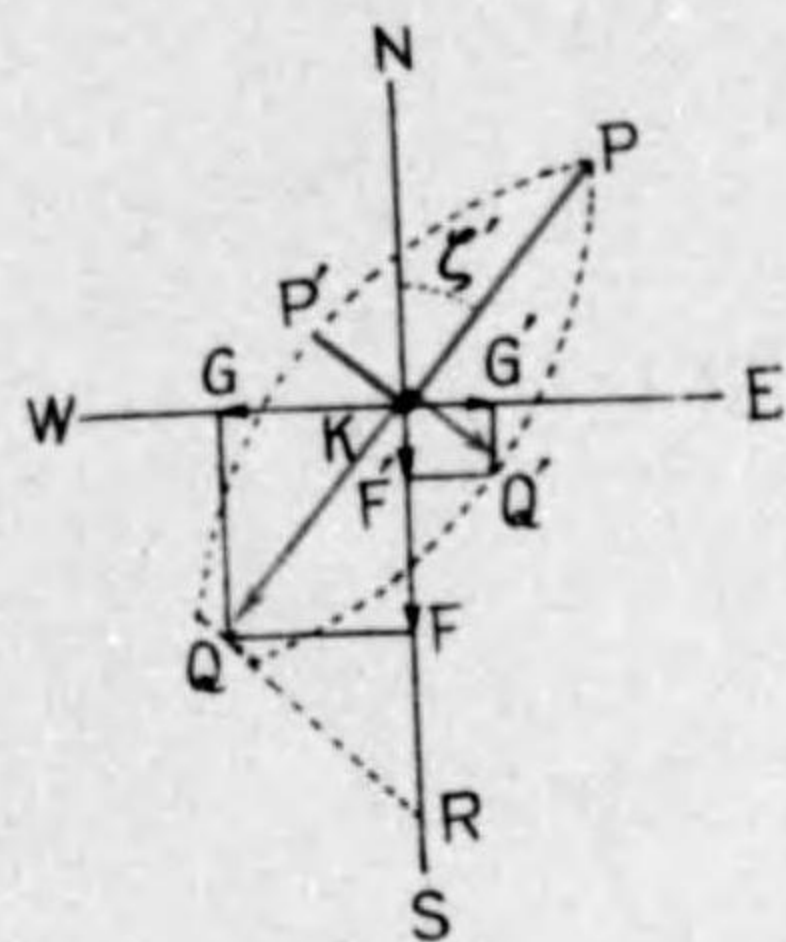

第九十六圖

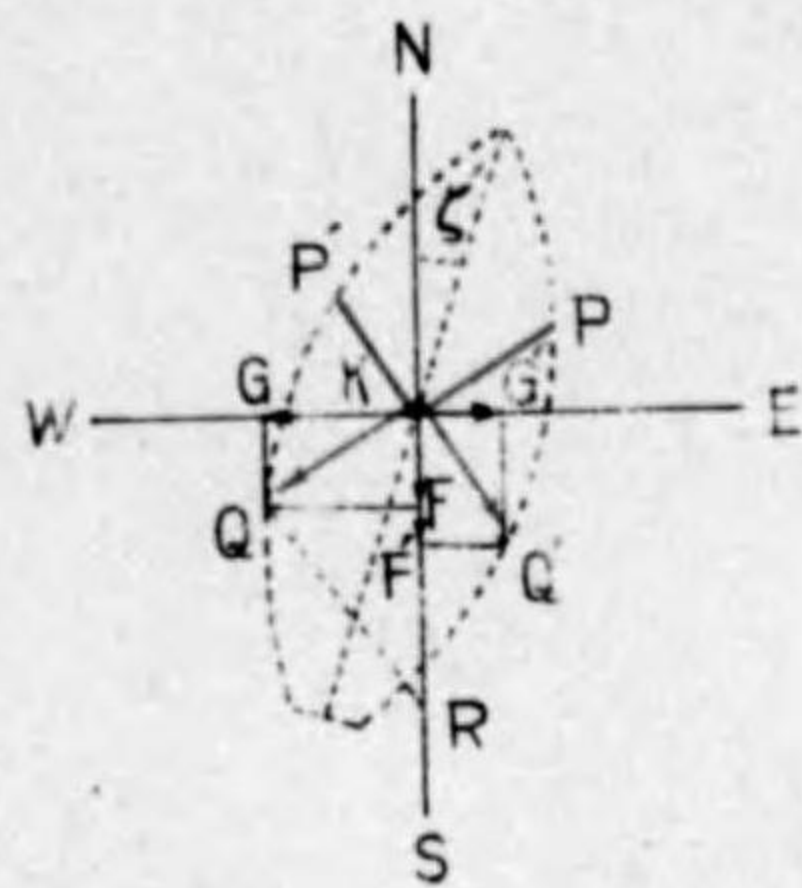

第九十七圖

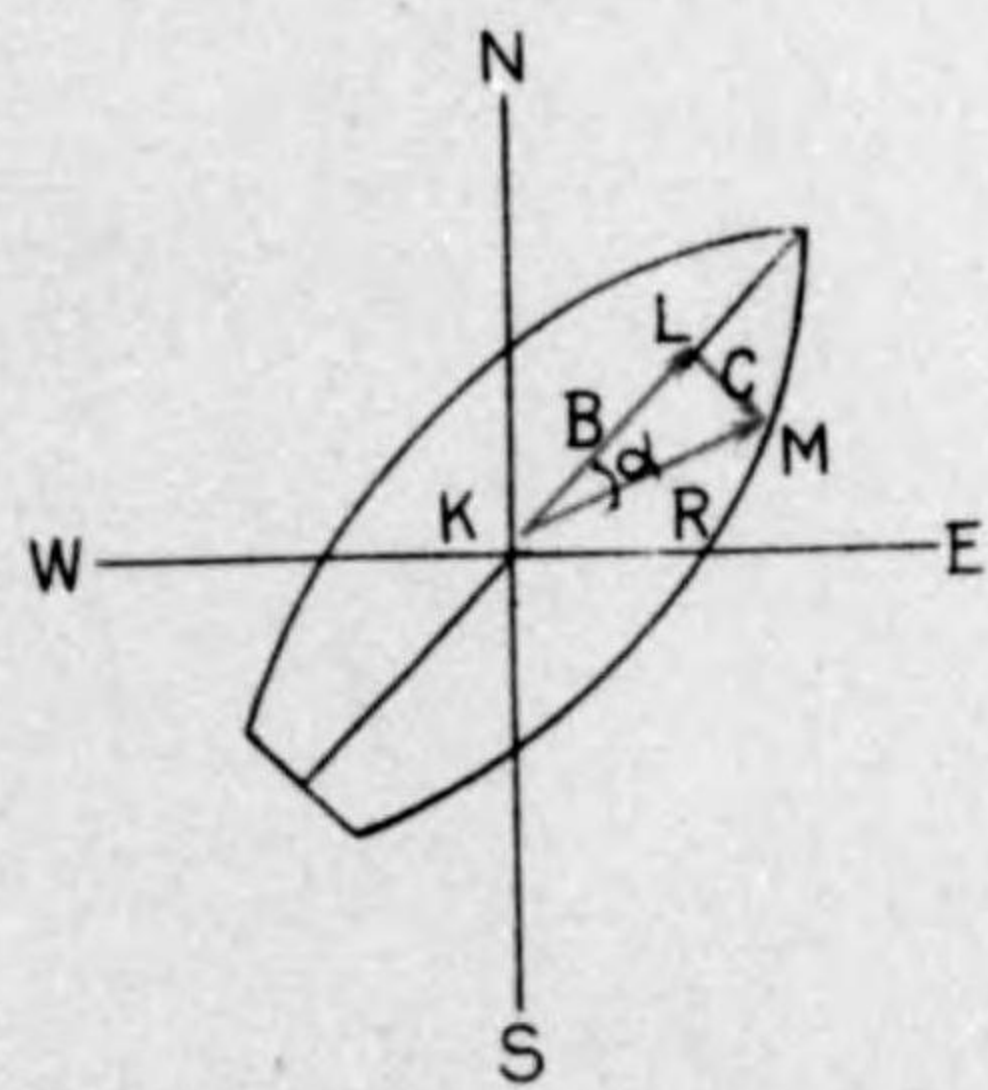

第九十八圖

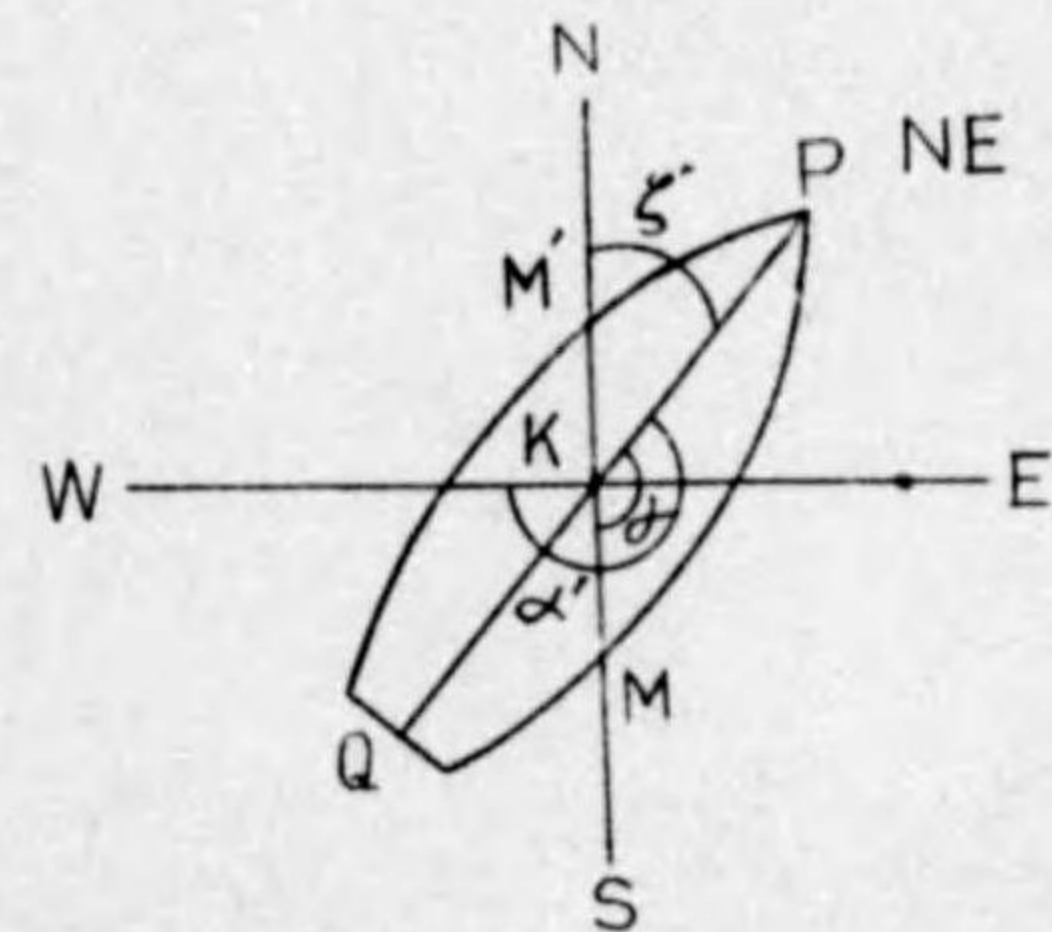

第九十九圖

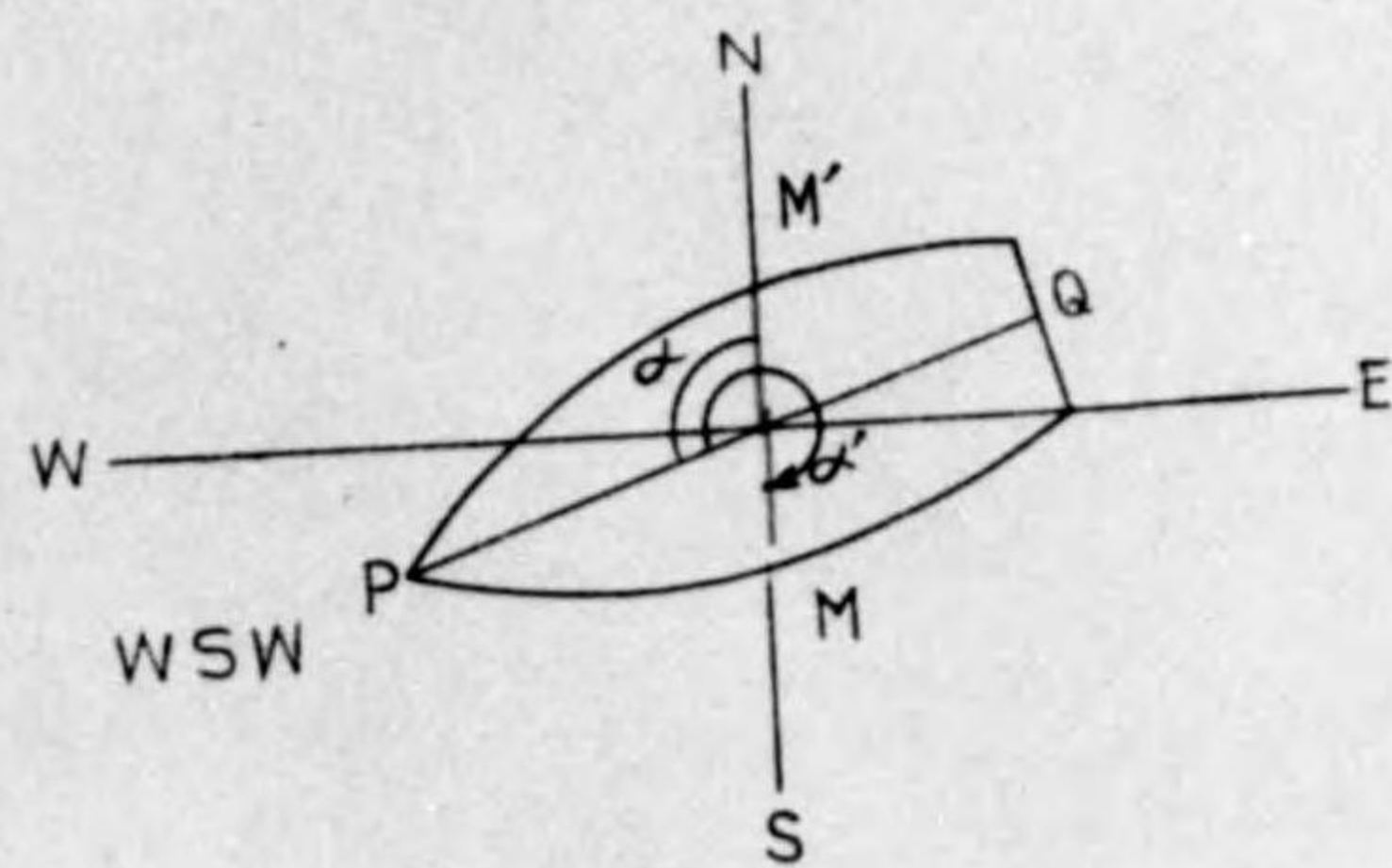

第一百圖

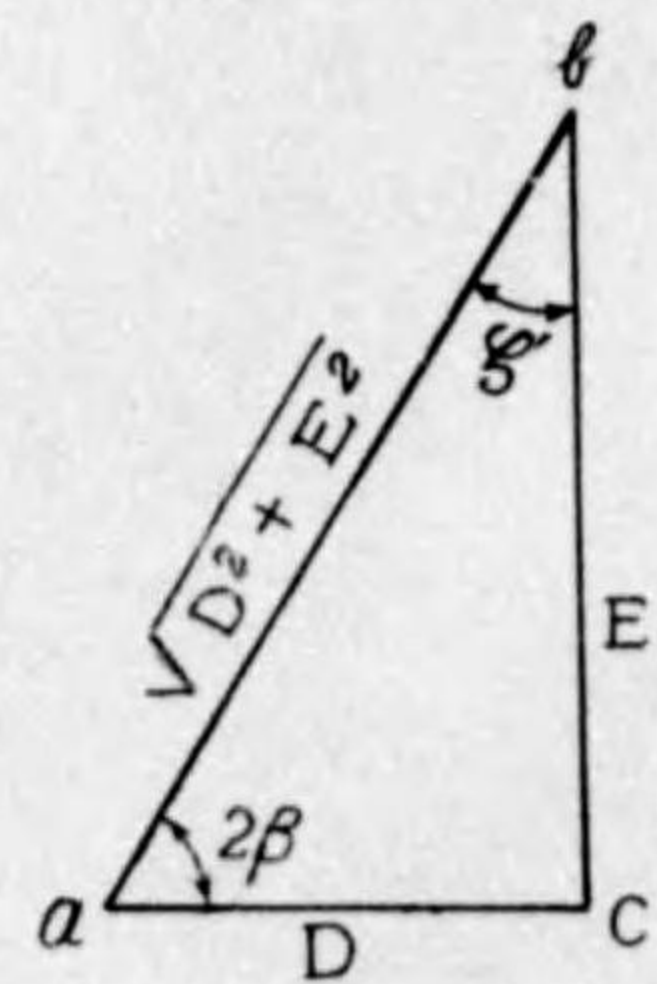

第一百圖(甲)

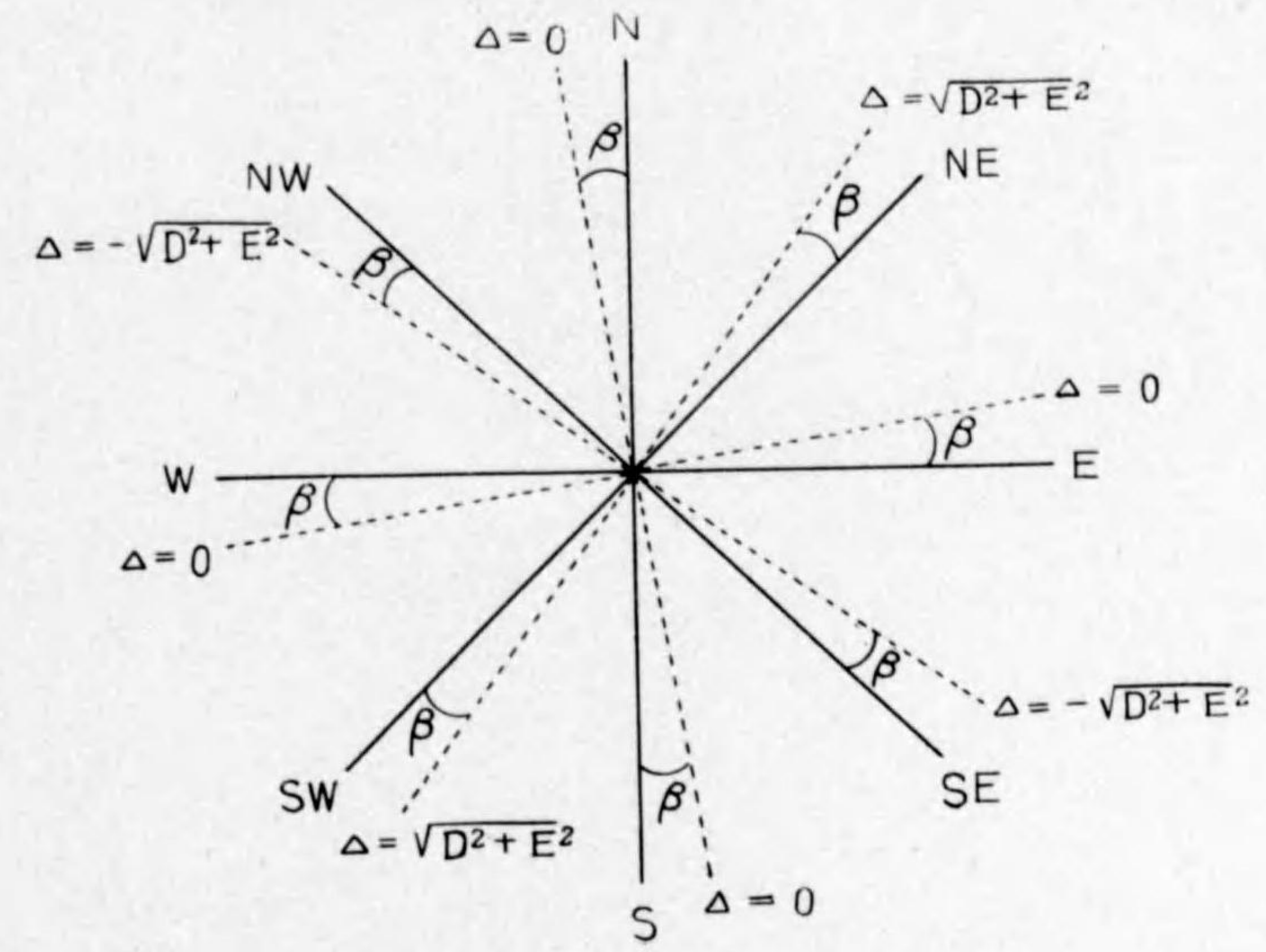

第一百圖(乙)

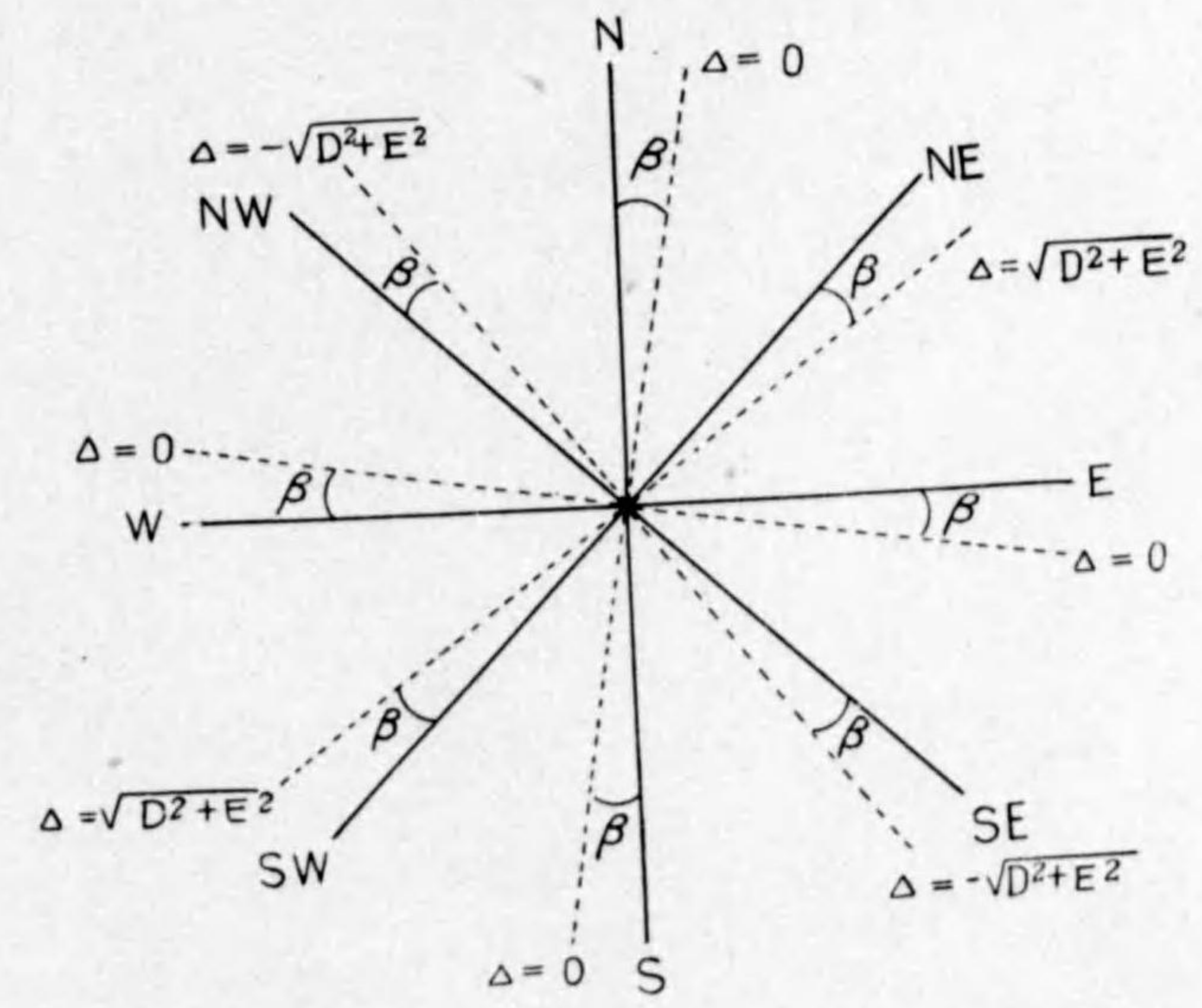

第一百圖(丙)

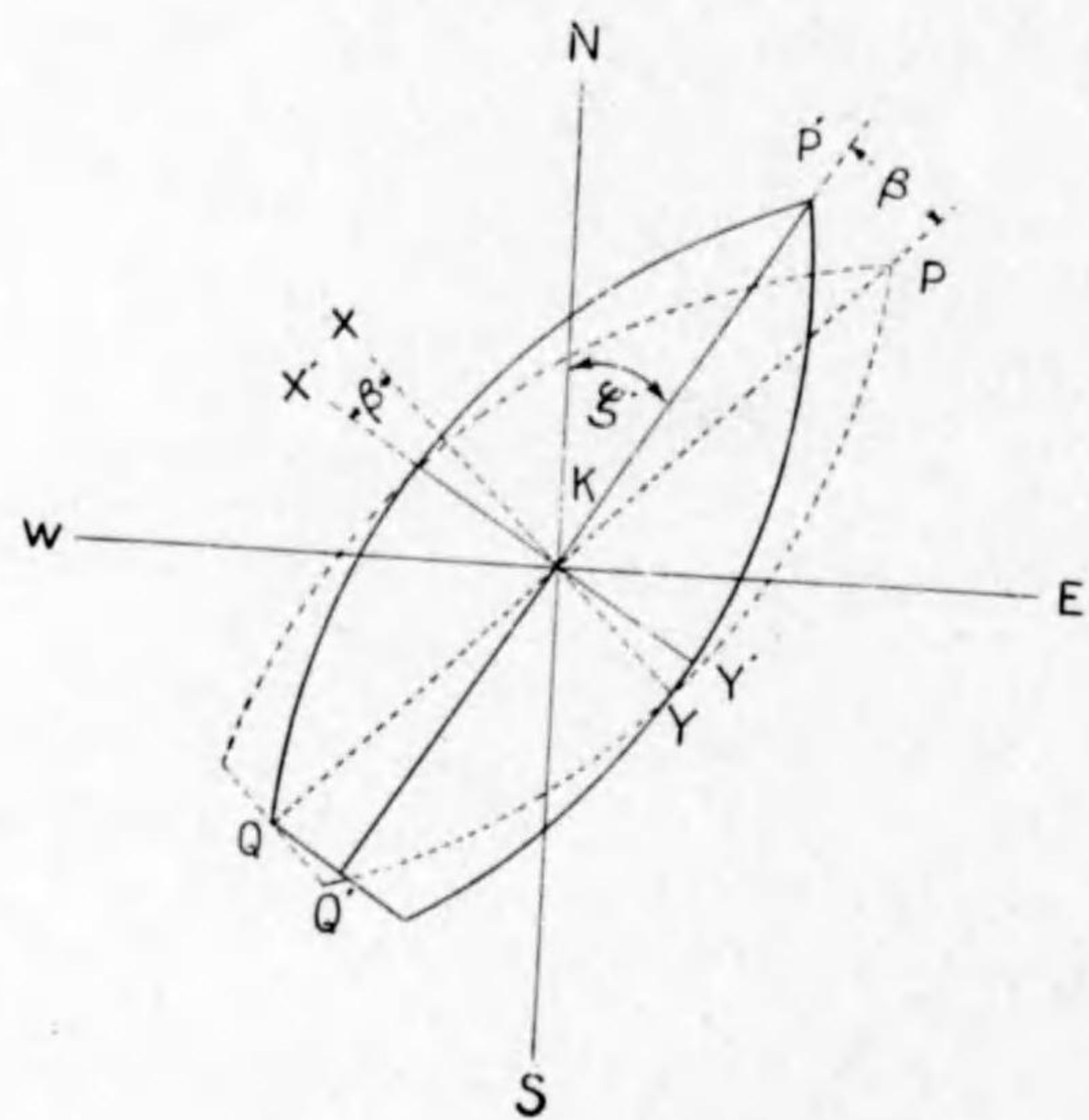

百二圖

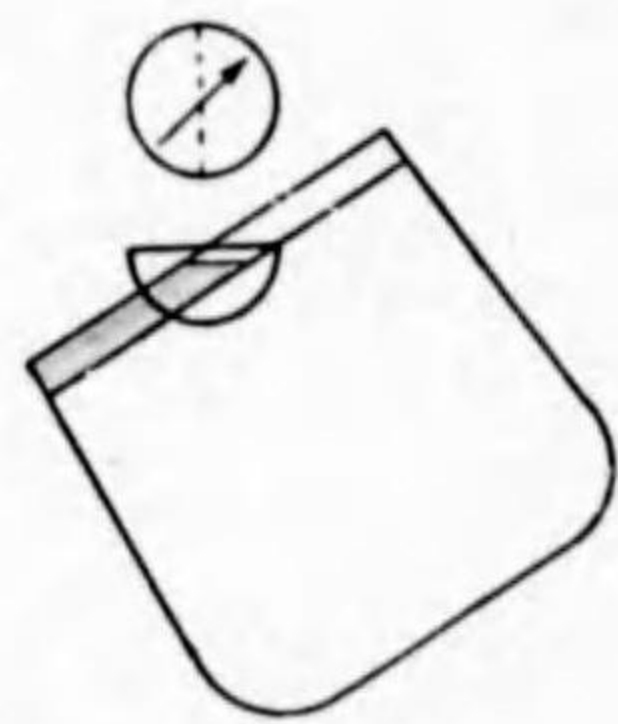

第一百三圖

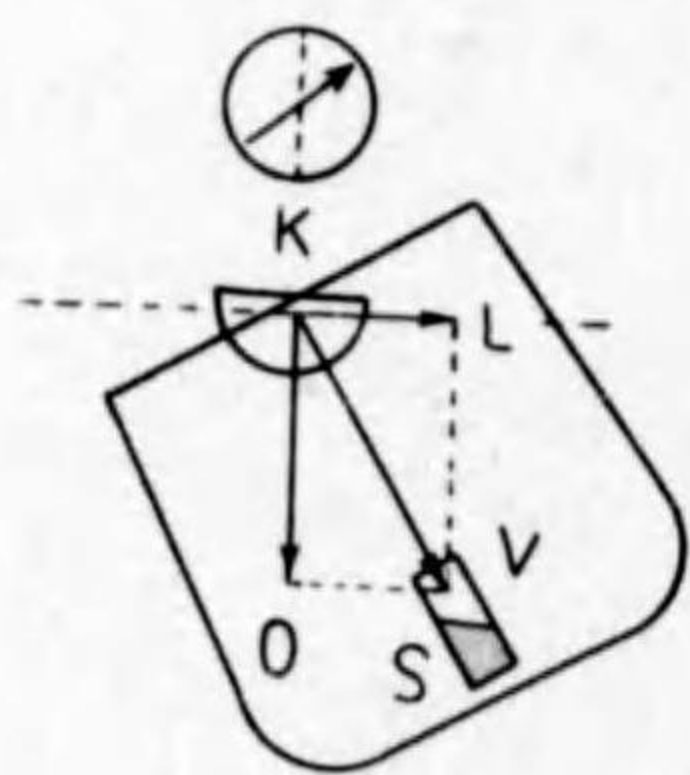

第一百四圖

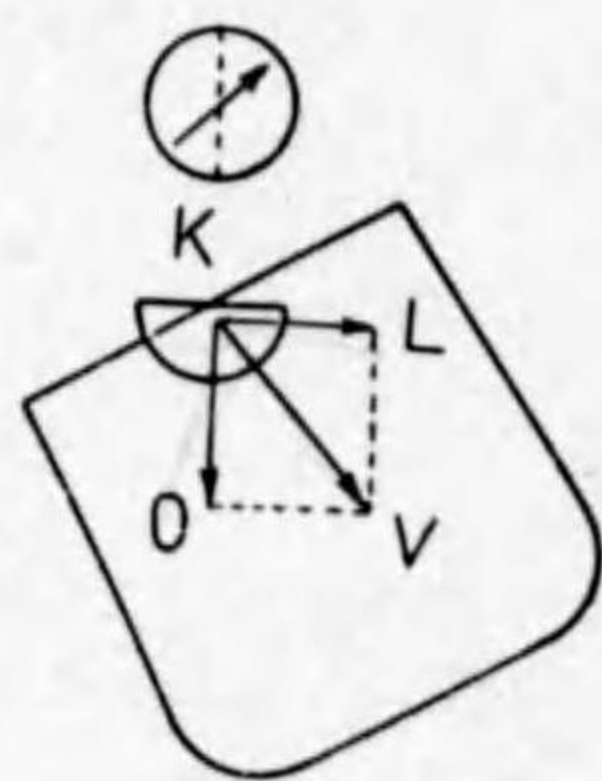

第一百五圖甲

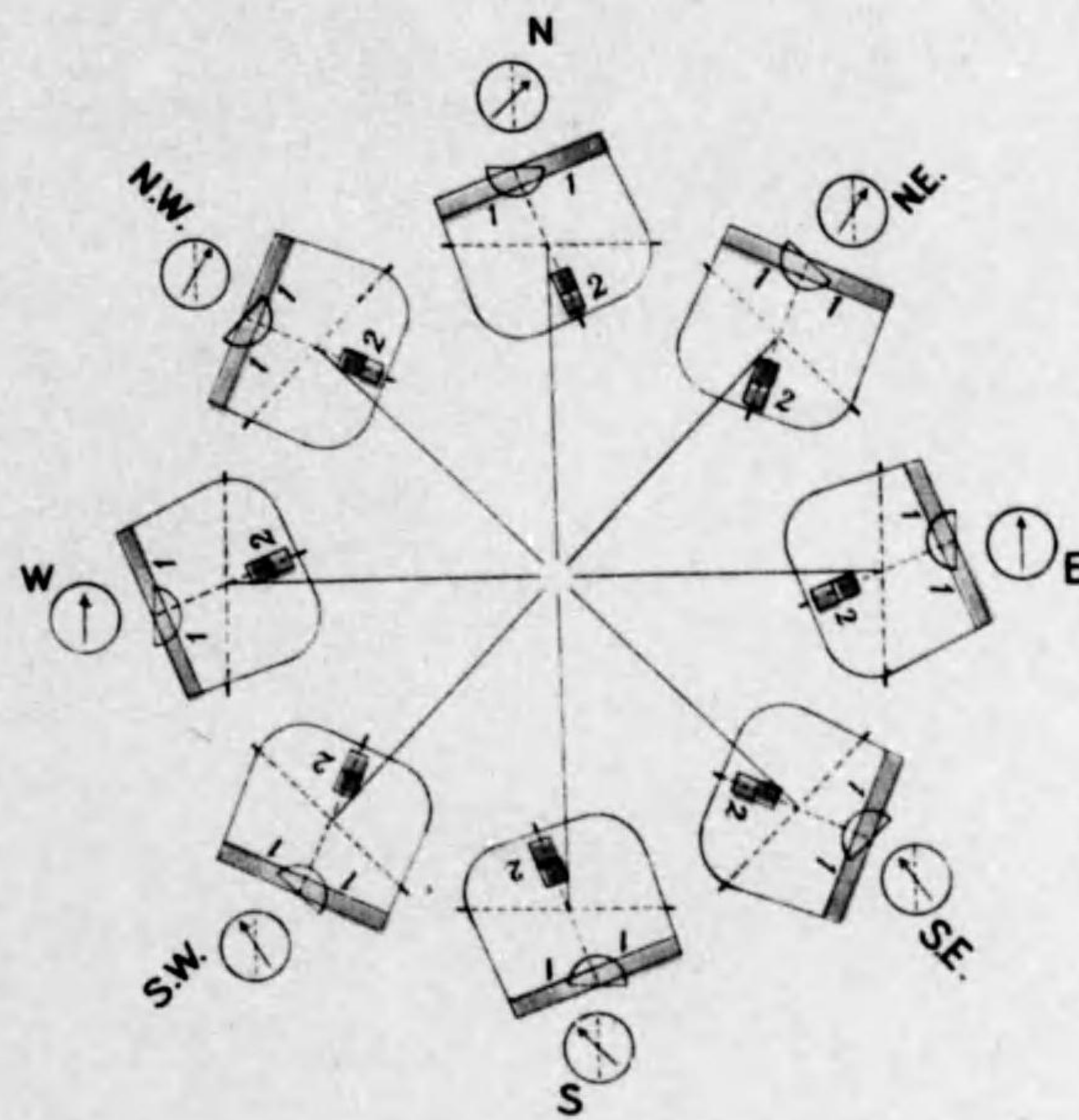

第一百五圖乙

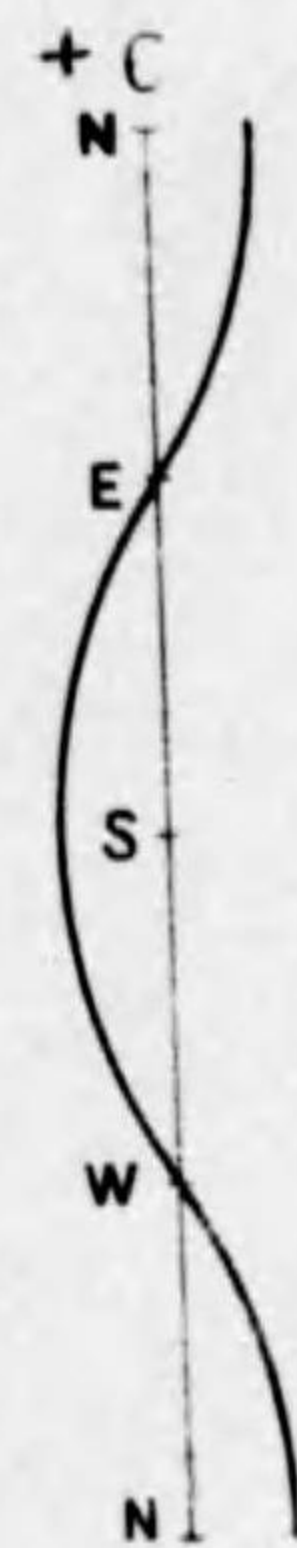
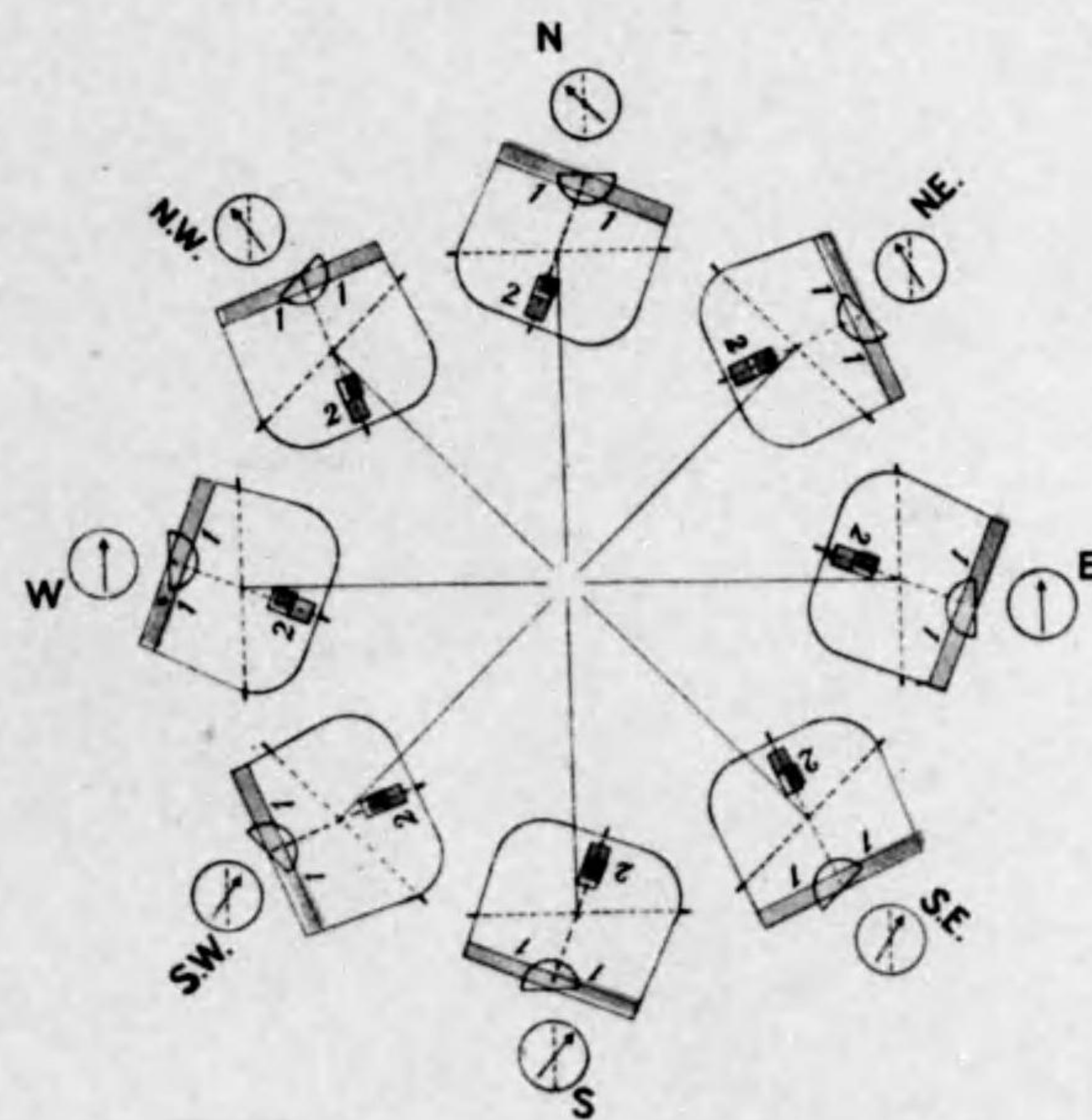

第一百六圖

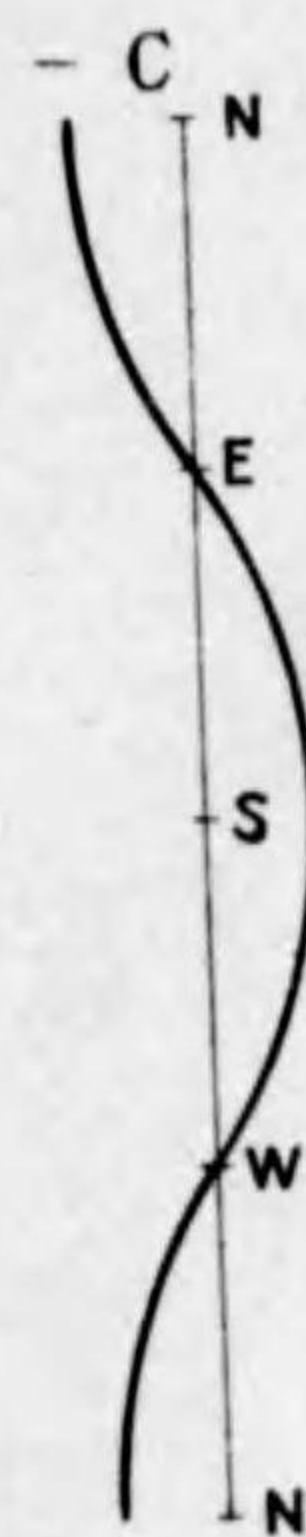
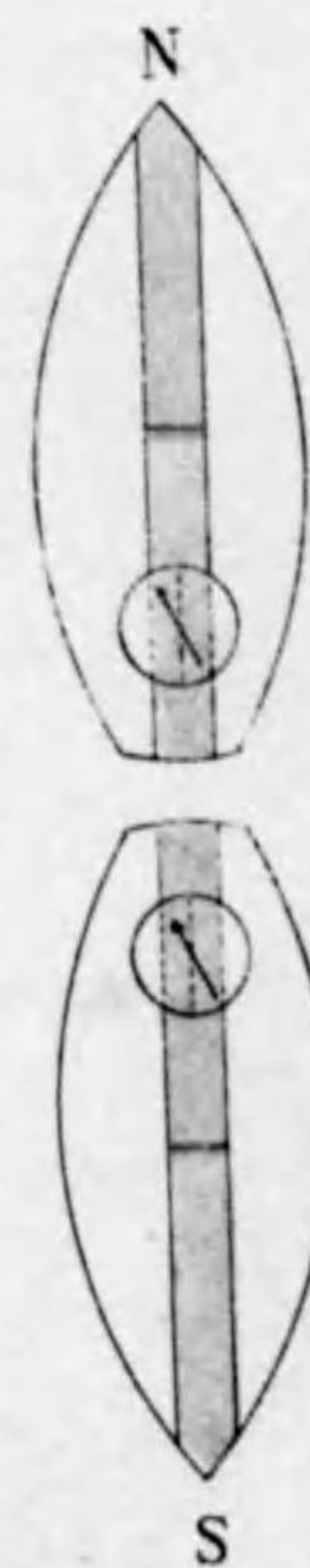

第七百圖

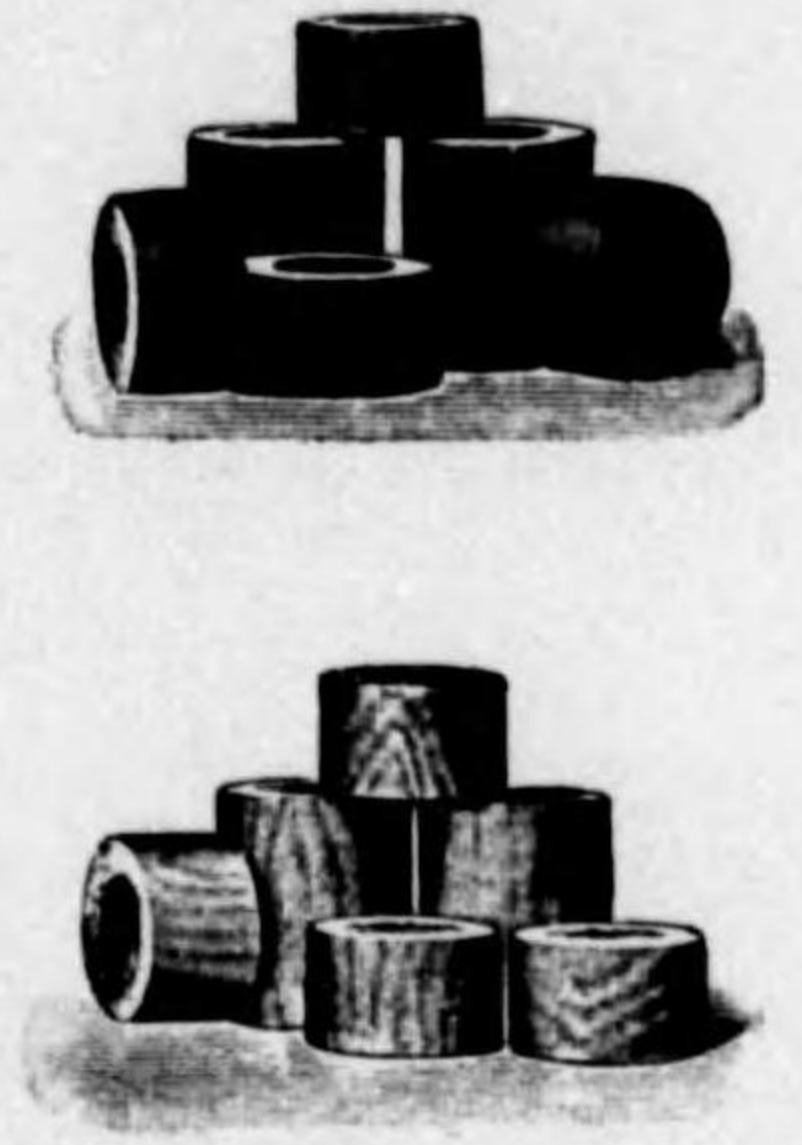

第八百圖
BOW

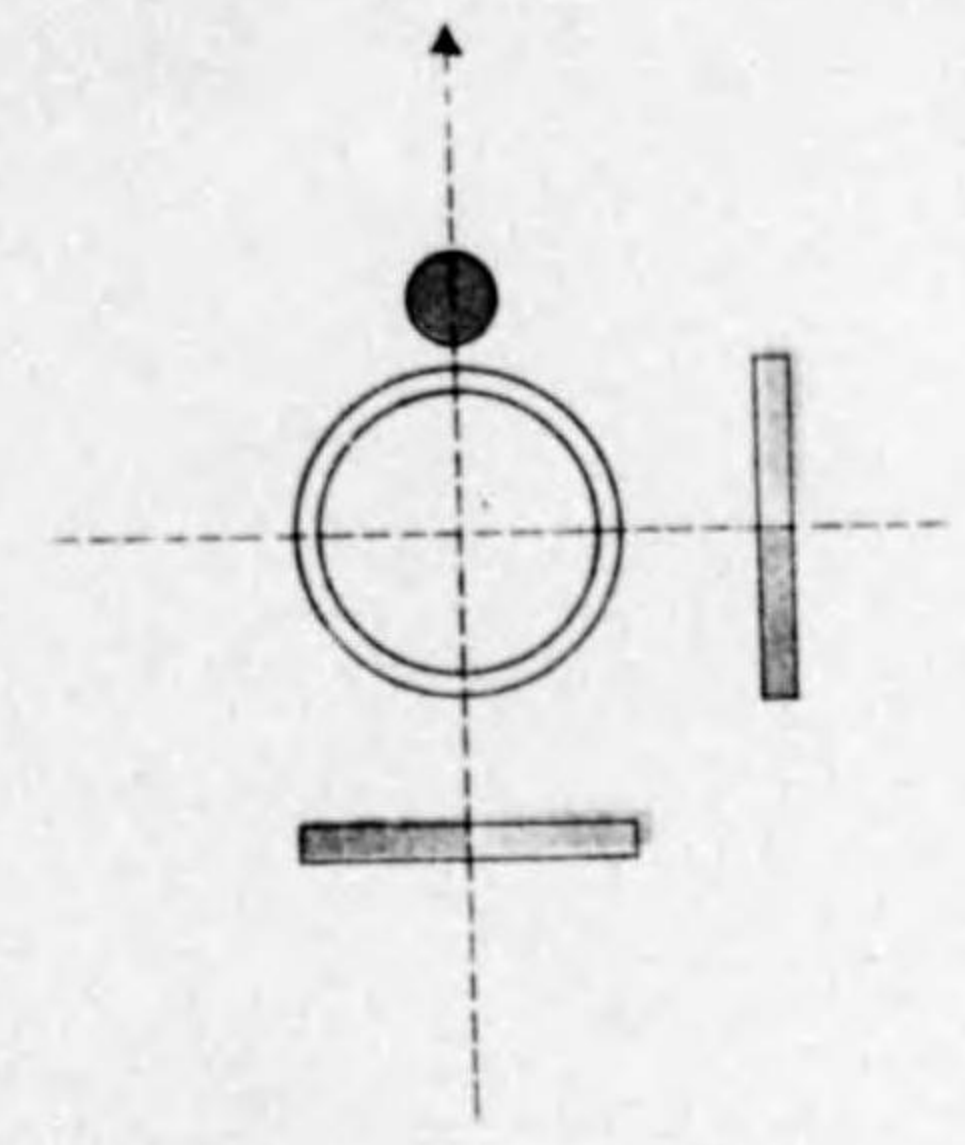

第九百圖
N

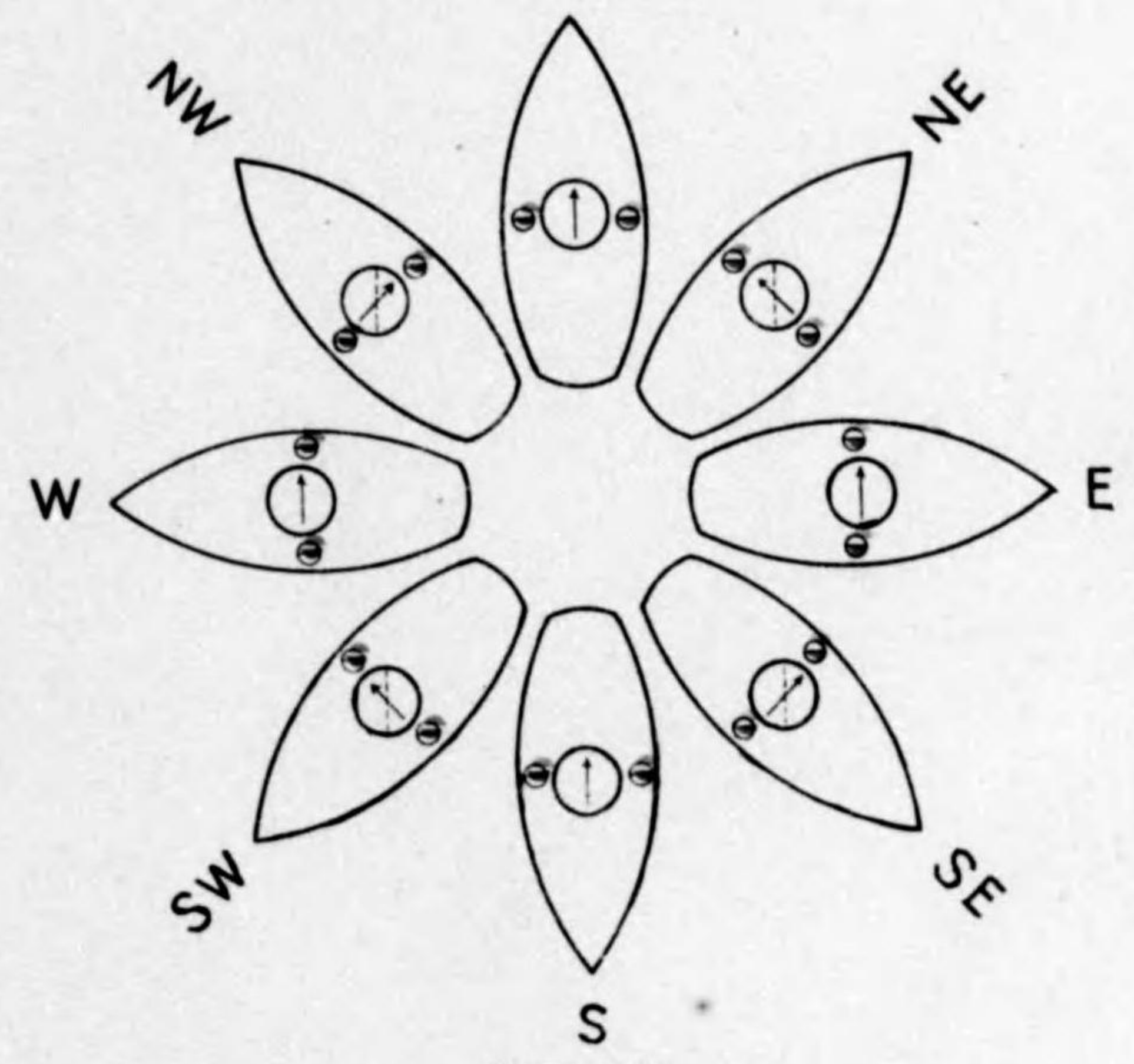

第十百圖

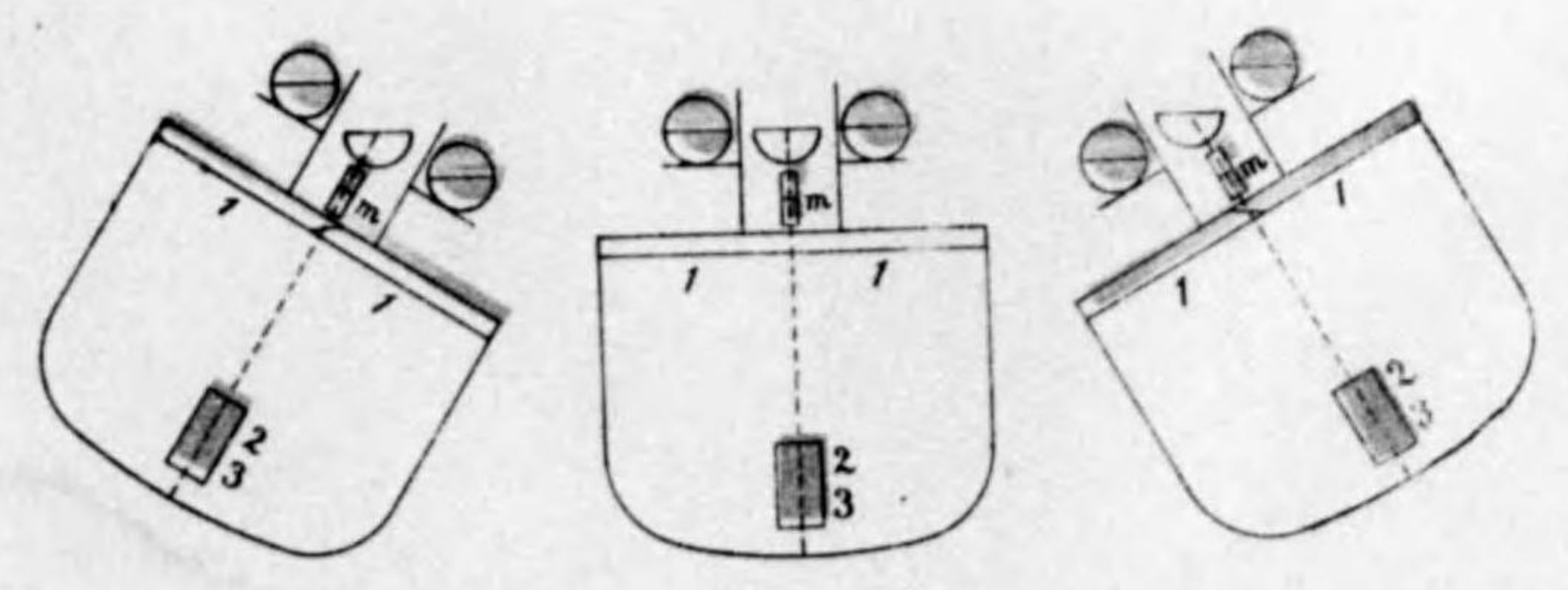

第一百十圖

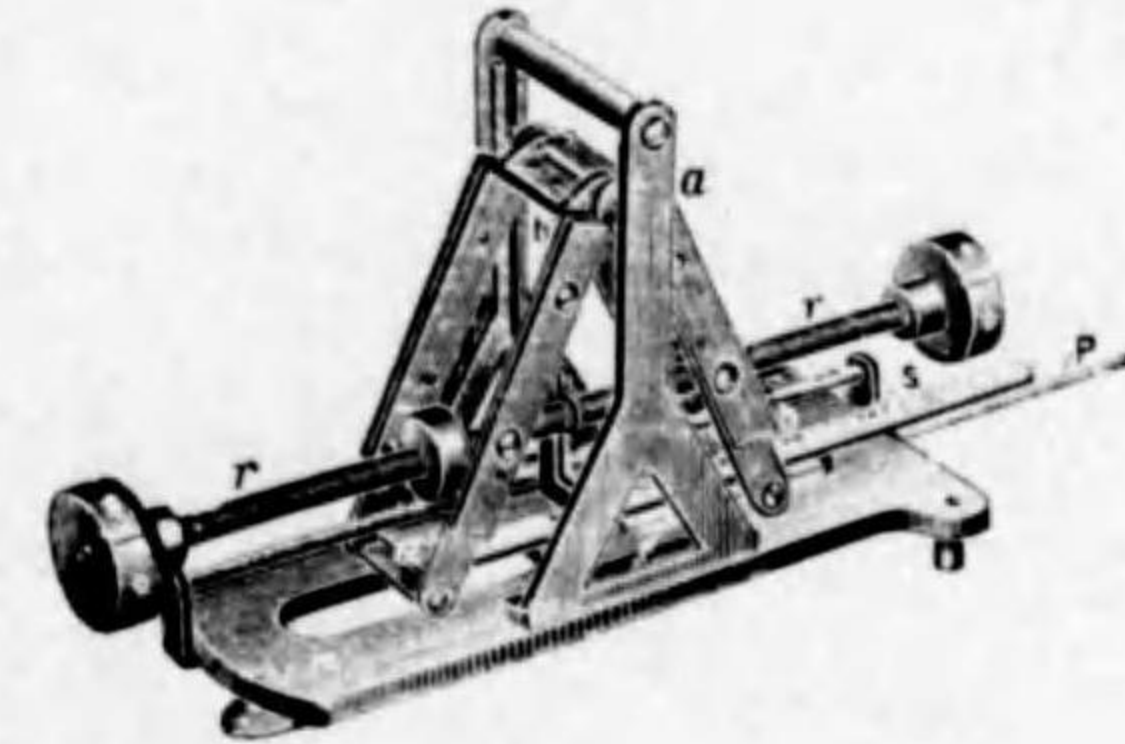

第一百十二圖

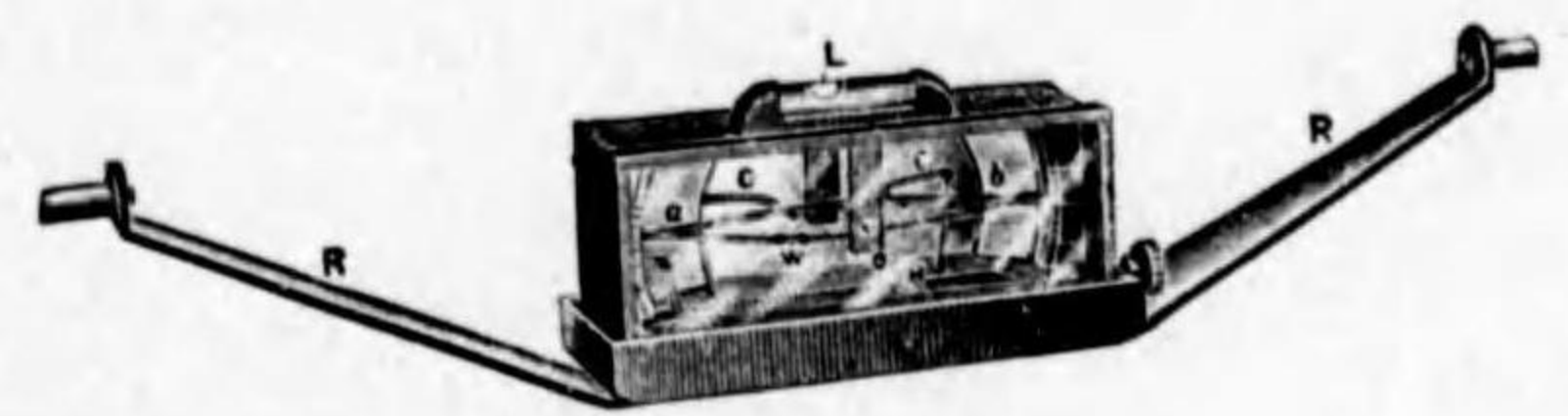

第一百十四圖

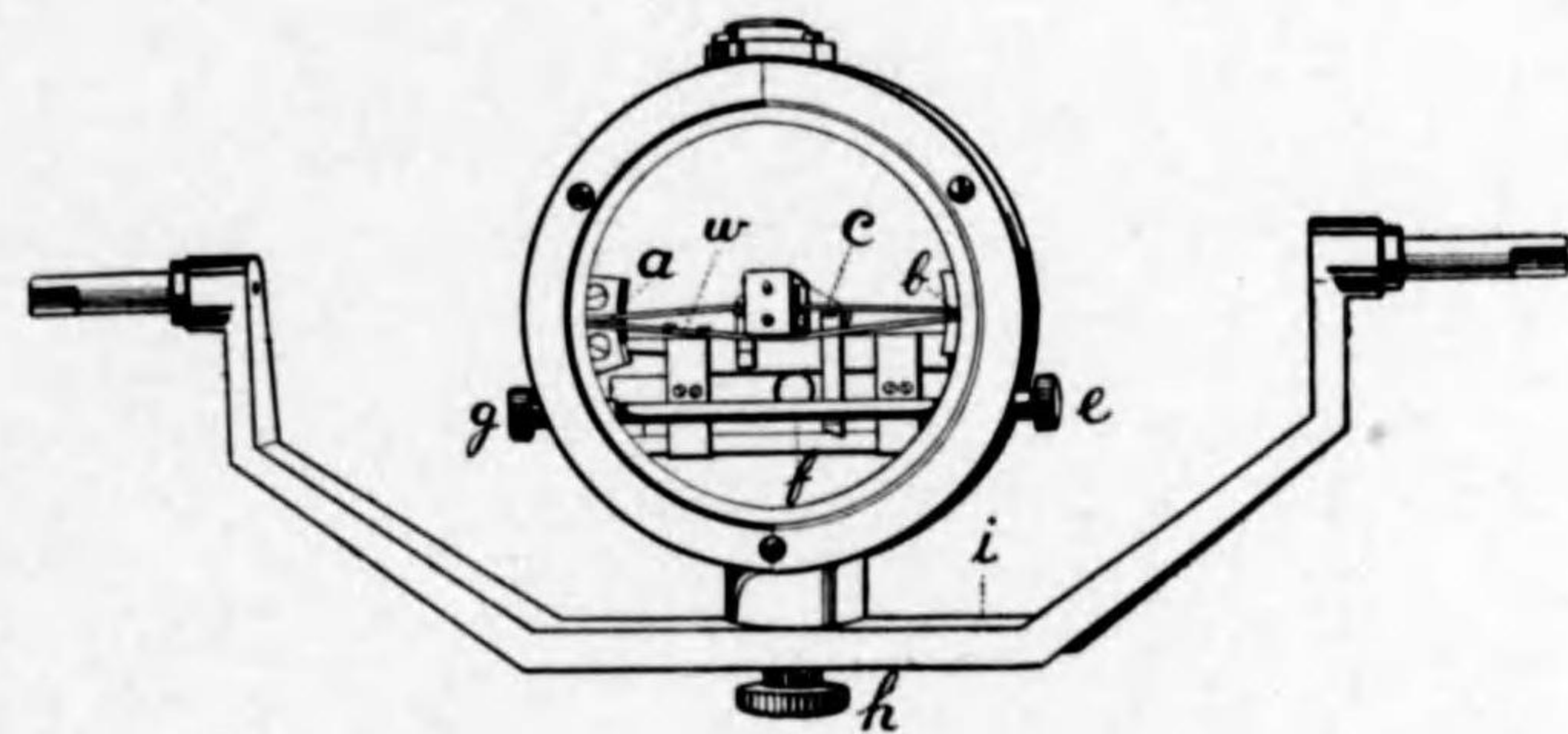

第一百十三圖

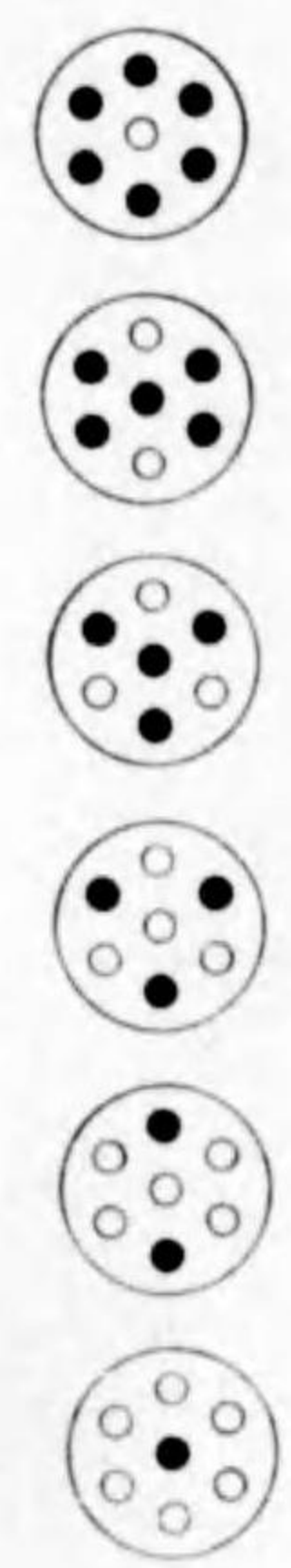

第一百十五圖

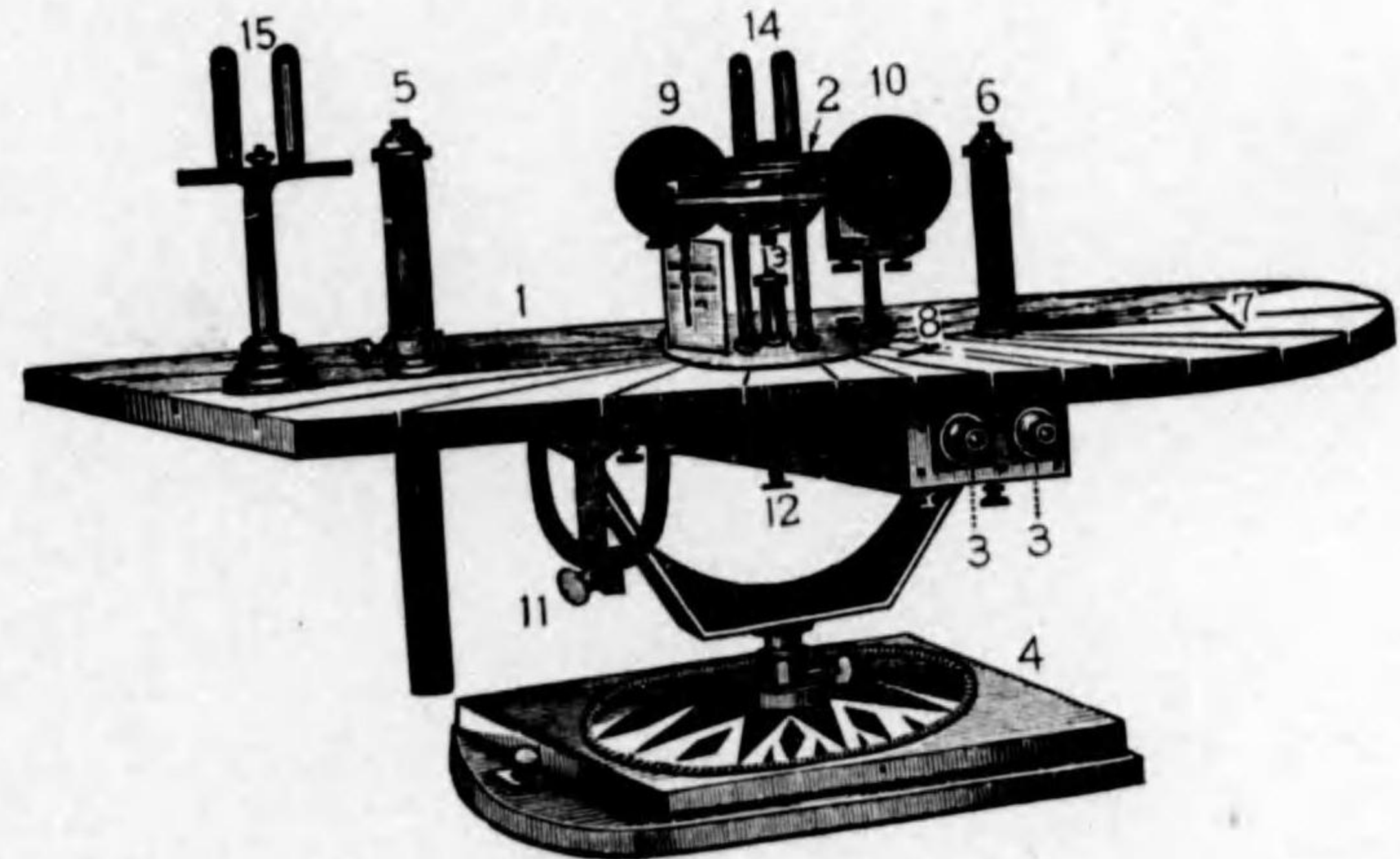

第一百十六圖(甲)

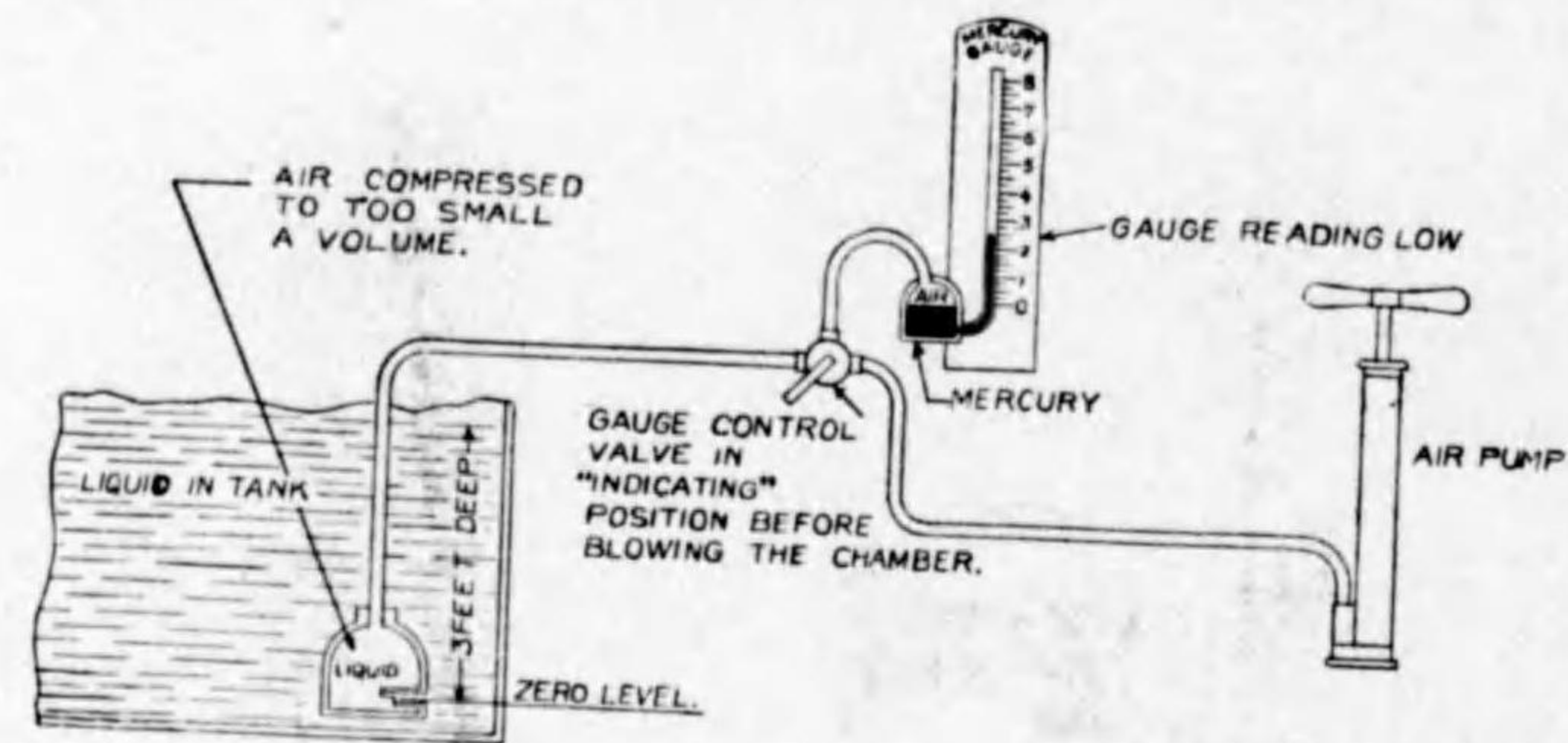

第一百十六圖(乙)

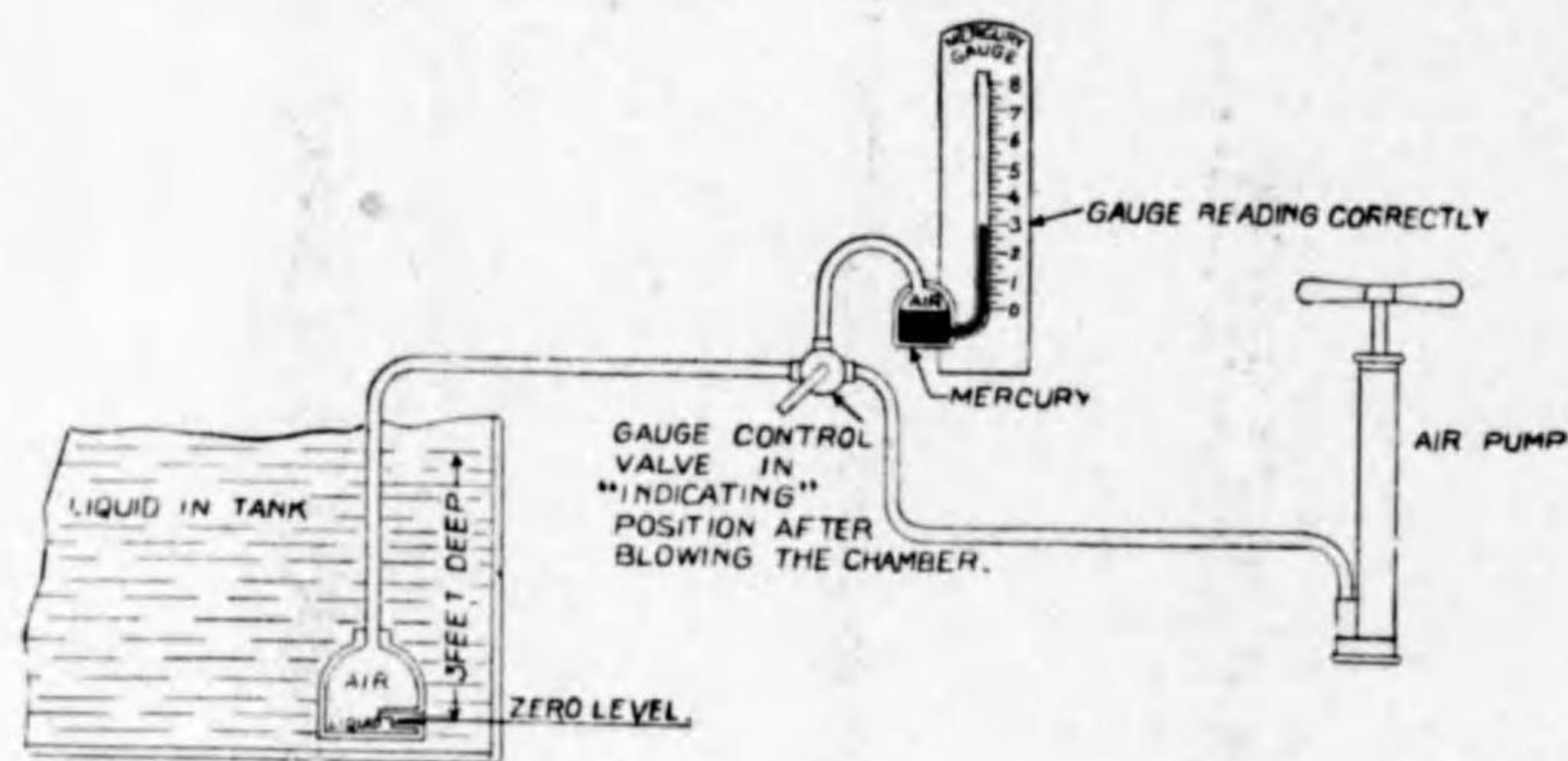

第一百十六圖(丙)

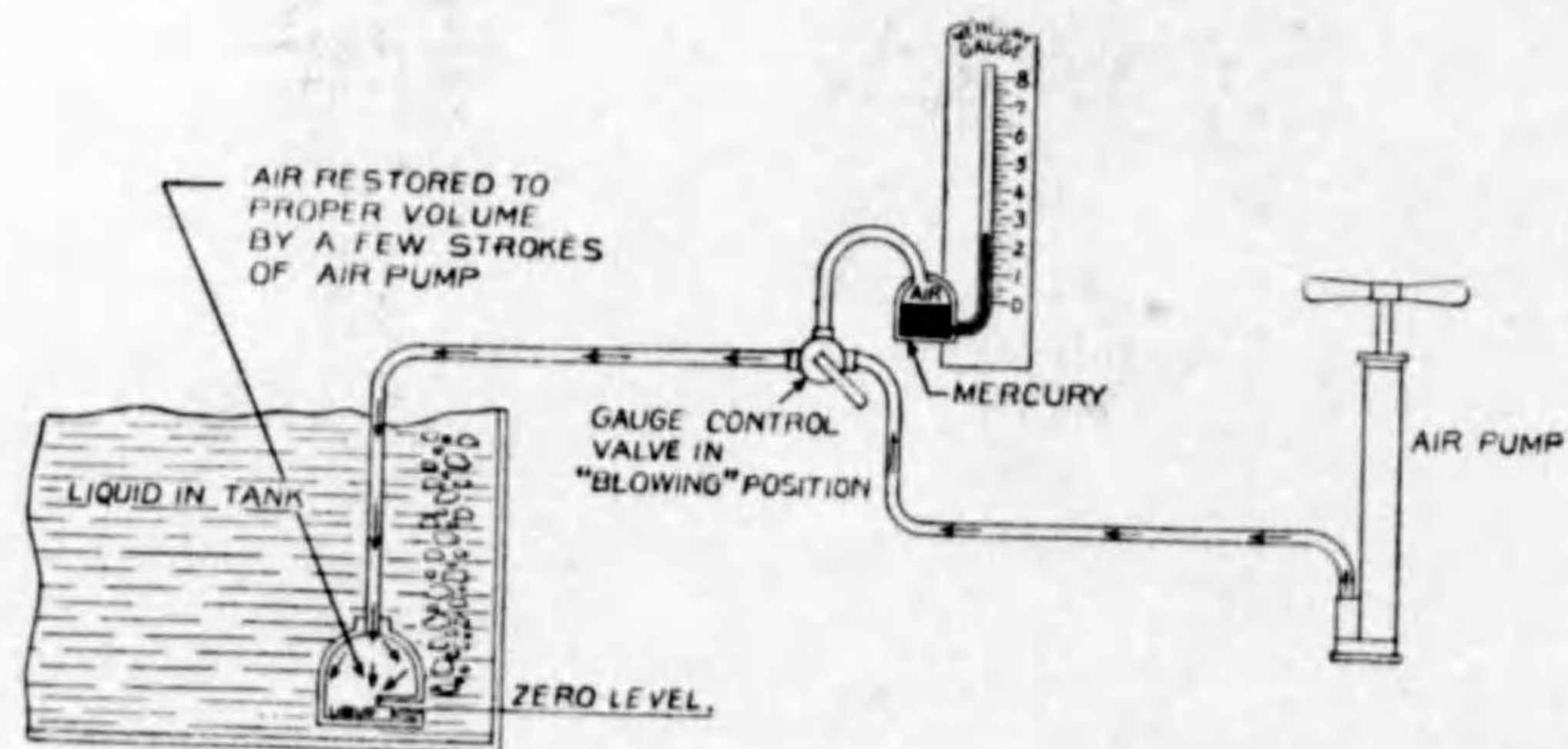

第一百十六圖(丁)

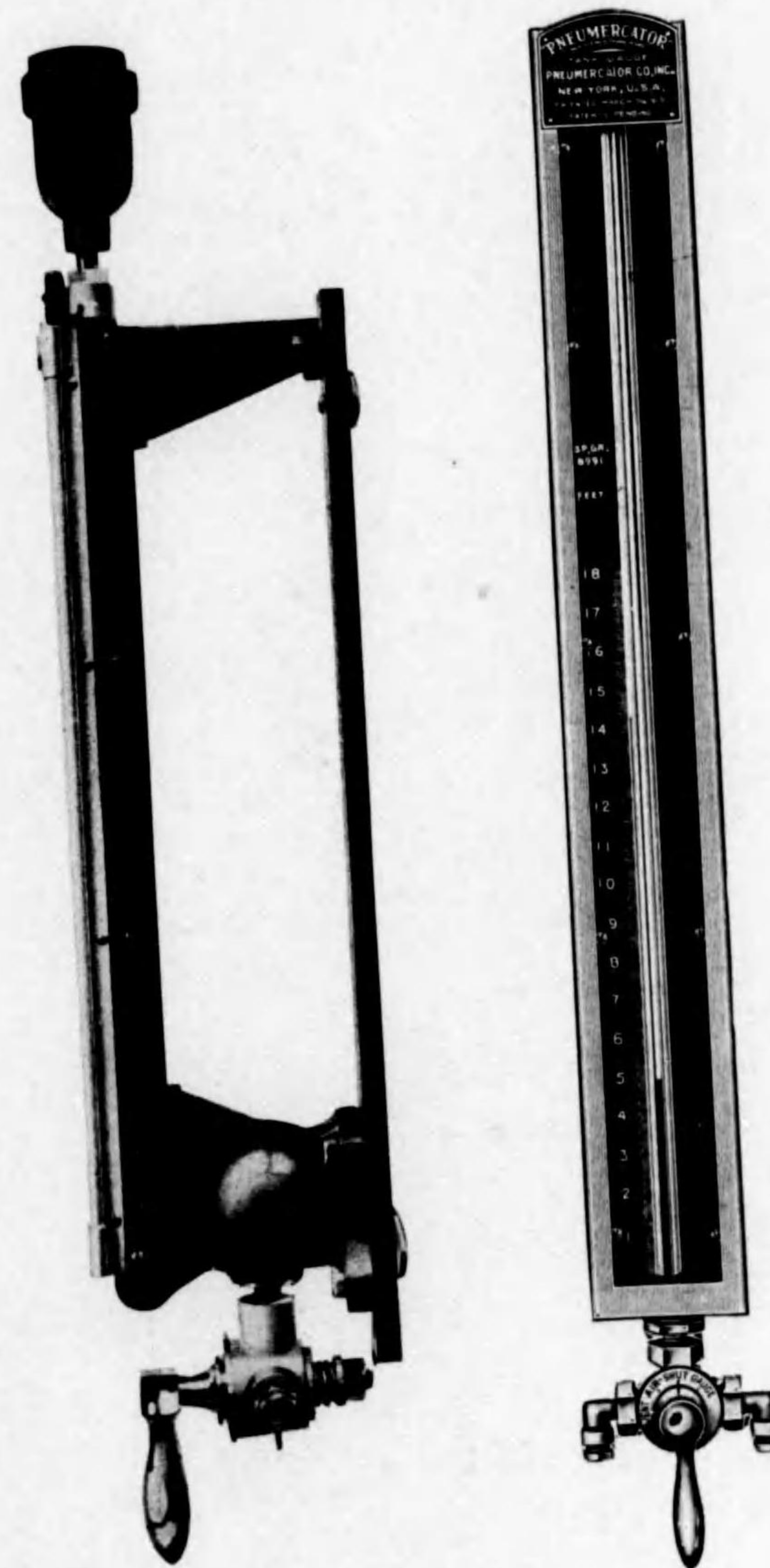

第一百十六圖(戊)



第一百十七圖(乙)

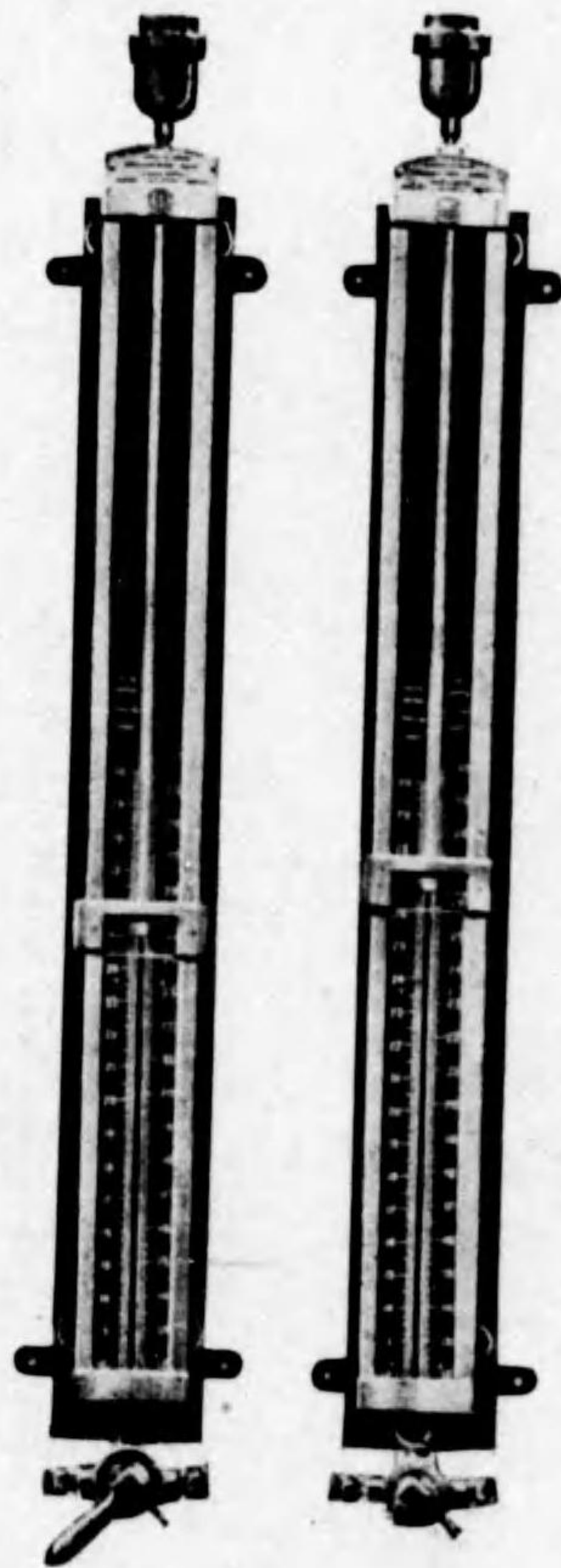

第一百十七圖(甲)

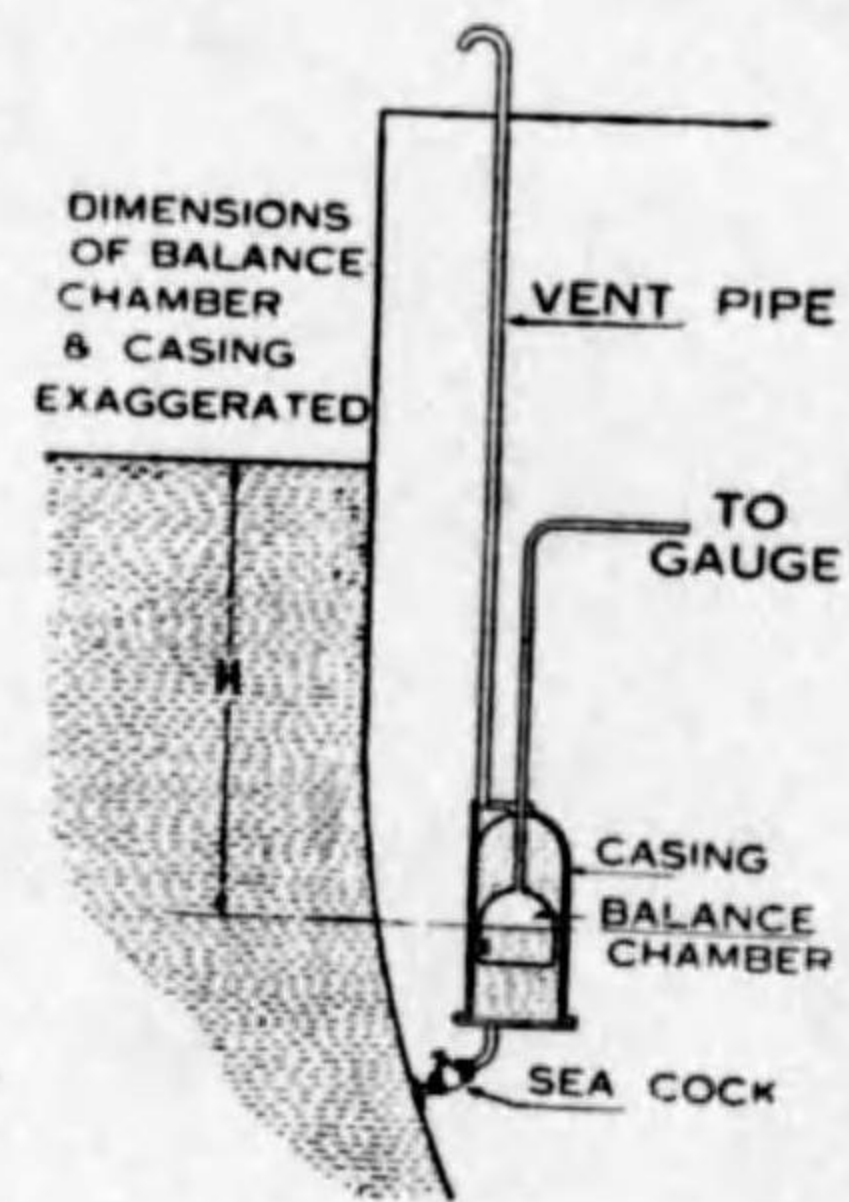

第一百十七圖(丙)

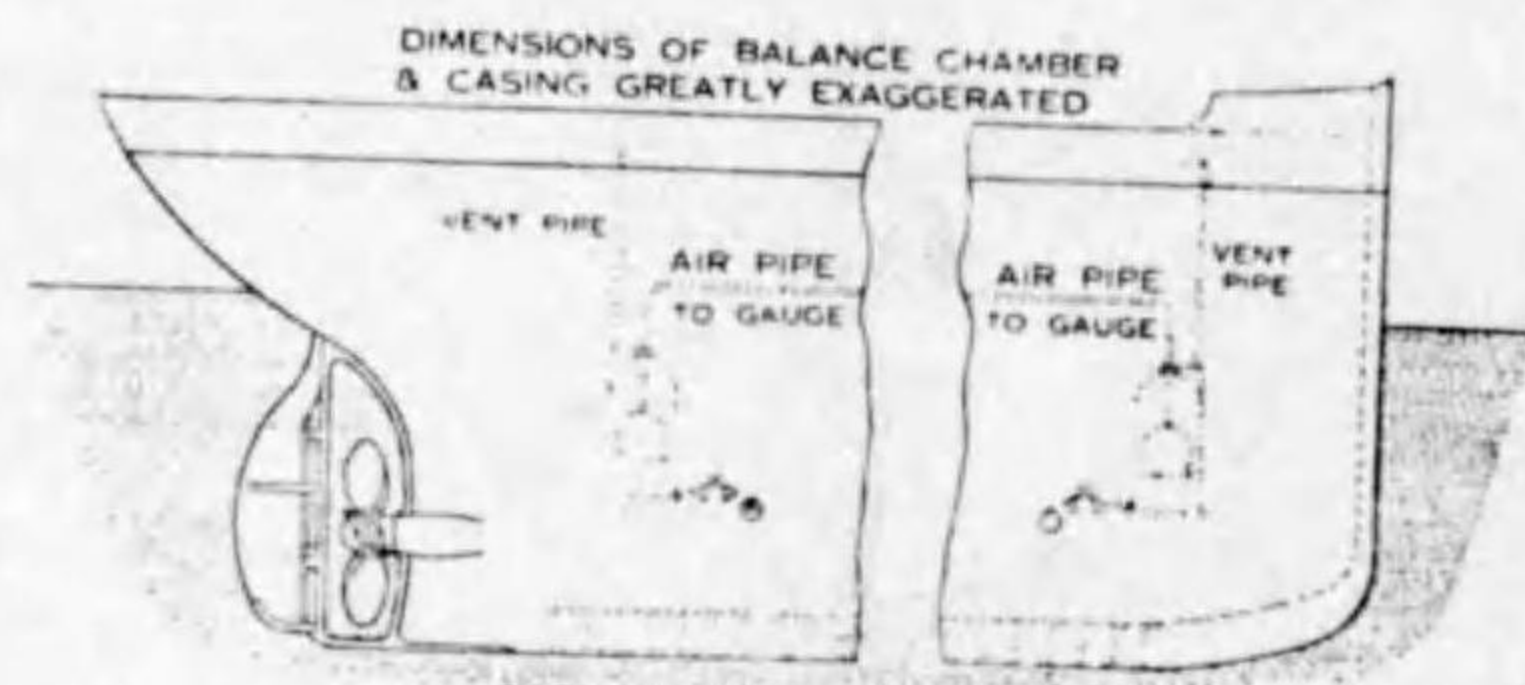

第一百十七圖(丁)

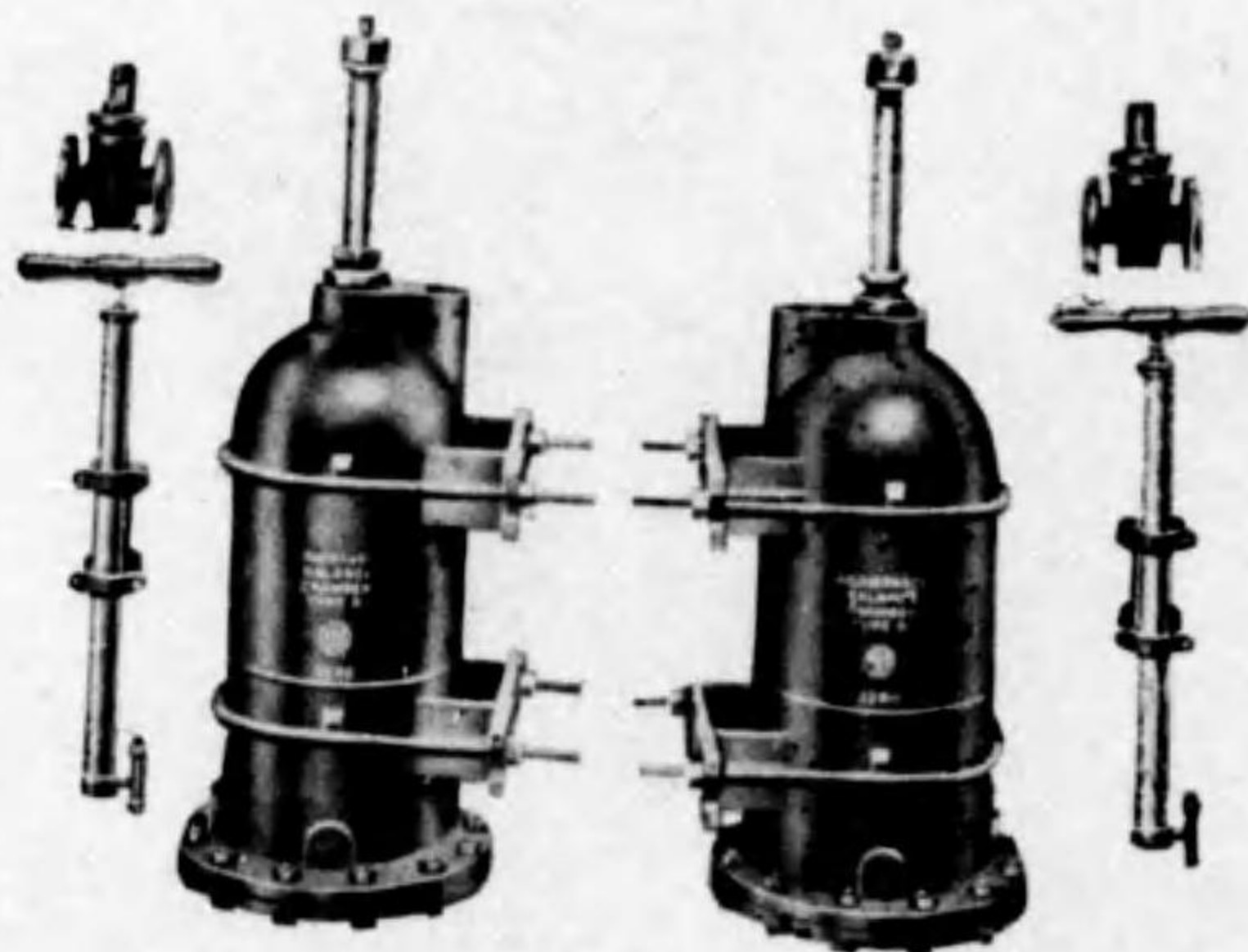

昭和十七年六月二十三日改訂新版第一版印刷
昭和十七年六月二十八日改訂新版第一版發行

複製
ア
許
サ
ズ

改航用測器學附圖

著者 井 關 實
發行所 賀 集 計 一
印刷者 川 橋 源 三 郎
神戸市神戸元町通三丁目三四〇ノ一
文部省登録第106528番
東京市京橋區地蔵堂丁十四

發行所
海文堂出版部

神戸市神戸元町通三丁目
電話三宮③ 2023 番 振替神戸 815 番

配給元
日本出版配給株式會社
東京市神田區淡路町二ノ九

(仁川堂・川橋印刷所・印刷)

558.2-198-27



1200500746538

5582
1.98
2

終