

LIBRARY OF  
THE NEW YORK BOTANICAL GARDEN

*Purchased*

1915

September 1899

R. W. Gibson, Inc.



















THE

JOURNAL

OF THE

ROYAL AGRICULTURAL SOCIETY

OF ENGLAND.

VOLUME THE FIFTH.

1845.

---

PRACTICE WITH SCIENCE.

---

LIBRARY  
NEW YORK  
BOTANICAL  
GARDEN.

LONDON:

JOHN MURRAY, ALBEMARLE STREET.

---

MDCCCXLV.

THESE EXPERIMENTS, IT IS TRUE, ARE NOT EASY; STILL THEY ARE IN THE POWER OF EVERY THINKING HUSBANDMAN. HE WHO ACCOMPLISHES BUT ONE, OF HOWEVER LIMITED APPLICATION, AND TAKES CARE TO REPORT IT FAITHFULLY, ADVANCES THE SCIENCE, AND, CONSEQUENTLY, THE PRACTICE OF AGRICULTURE, AND ACQUIRES THEREBY A RIGHT TO THE GRATITUDE OF HIS FELLOWS, AND OF THOSE WHO COME AFTER. TO MAKE MANY SUCH IS BEYOND THE POWER OF MOST INDIVIDUALS, AND CANNOT BE EXPECTED. THE FIRST CARE OF ALL SOCIETIES FORMED FOR THE IMPROVEMENT OF OUR SCIENCE SHOULD BE TO PREPARE THE FORMS OF SUCH EXPERIMENTS, AND TO DISTRIBUTE THE EXECUTION OF THESE AMONG THEIR MEMBERS.

VON THAER, *Principles of Agriculture.*

## CONTENTS OF VOLUME V.

ARTICLE	PAGE
I.—On the Farming of Essex. By Robert Baker, of Writtle. Prize Report . . . . .	1
II.—On the Jersey, misnamed Alderney, Cow. By Colonel Le Couteur, of Belle Vue, in the Island of Jersey . . . . .	43
III.—Further Account of the Tussac Grass. In a Despatch from the Governor of the Falkland Islands. Communicated by Lord Stanley . . . . .	50
IV.—An Essay on the Comparative Advantages in the Employment of Horses and Oxen in Farm Work. By James Cowie, of the Mains of Haulkerton, Laurencekirk, N.B. Prize Essay . . . . .	52
V.—The Farming of Cheshire. By William Palin. Prize Report	57
VI.—Method of Growing Beans and Cabbages on the same Ground. By the Earl of Lovelace . . . . .	112
VII.—On the Improvement of Cold and Heavy Soils by the Application of Burnt Clay. By Charles Randell . . . . .	113
VIII.—1. On the Influence of Water on the Temperature of Soils. 2. On the Quantity of Rain-Water and its Discharge by Drains. By Josiah Parkes, Consulting Engineer to the Society . . . . .	119
IX.—On Preparation for the Wheat Crop in Cornwall. By J. H. Tremayne . . . . .	158
X.—Farming of Wiltshire. By Edward Little, of Lower Sheldon Farm, Chippenham. Prize Report . . . . .	161
XI.—Observations on the Natural History and Economy of the Insects called Wireworms, affecting the Turnips, Corn-Crops, &c.; also of their Parents the Elaters or Beetles, called Skip-jacks, Click-beetles, &c. By John Curtis, F.L.S., Corresponding Member of the Imperial and Royal Georgofili Society of Florence, &c. Paper VI. . . . .	180
XII.—On the Building of Cottages for Farm-Labourers. By John Grey . . . . .	237
XIII.—An Essay on Fat and Muscle. By W. F. Karkeek, Veterinary Surgeon, Truro. Prize Essay . . . . .	245
XIV.—Experiments with Salt and other Manures upon Oats, Barley, and Wheat. By John Hannam . . . . .	267
XV.—On the Agriculture of Norfolk. By Barugh Almack . . . . .	307
XVI.—On White Mustard. By George Jesty . . . . .	358

MAR 17 1915

ARTICLE	PAGE
XVII.—On the Growing of White Mustard as a Green Crop for Sheep. By John Gray, Agent of F. H. Dickinson, M.P. . . . .	360
XVIII.—Report on the Exhibition of Implements at the Southampton Meeting in 1844. By Josiah Parkes, Consulting Engineer to the Society . . . . .	361
XIX.—On the Allotment System. By Sir Henry E. Bunbury, Bart. . . . .	391
XX.—Trial of several Artificial Manures. By William Miles, Esq., M.P. . . . .	394
XXI.—Some Account of the Process of Warping. By Ralph Creyke . . . . .	398
XXII.—On the occurrence of Phosphorite in Estremadura. By Charles Daubeny, M.D., F.R.S., F.G.S., Professor of Chemistry, &c., Oxford; and Captain Widdrington, R.N., F.R.S., F.G.S., &c. &c. . . . .	406
XXIII.—Instance of the advantage of Subsoil-ploughing in addition to Draining. By George Turner . . . . .	418
XXIV.—A few Remarks on the large Hedges and Small Enclosures of Devonshire and the adjoining Counties. By John Grant, Surveyor and Land Agent . . . . .	420
XXV.—On the Indications of Fertility or Barrenness of Soils, whether of Colour, Consistence, or Vegetation. By John Arkell . . . . .	429
XXVI.—On the Use of Bones as a Manure with Sulphuric Acid . . . . .	443—468
1. Experiments at the Home Farm of Gordon Castle, Morayshire, in 1813, with the effect on the crop in 1814. From the President, His Grace the Duke of Richmond.	
2. On the Use of Bones with Sulphuric Acid. By E. Wagstaff.	
3. On Bones with Sulphuric Acid and other Manures. By R. W. Purchas.	
4. Report by the Committee appointed by the Morayshire Farmer Club to examine the Experiments made by Candidates for the Premiums offered for the Growth of Turnips by new Manures—Season 1843. Communicated by the President, His Grace the Duke of Richmond.	
5. On the Action and Application of Dissolved Bones. By John Hannam.	
XXVII.—Observations on the Natural History and Economy of various Insects affecting the Corn-Crops, many of them improperly called Wireworms; including Ground-beetles, Chaffers, or May-bugs, also the Caterpillars of a Moth and Saw-fly, and the Larvæ of some minute Flies. By John Curtis, F.L.S., Corresponding Member of the Imperial and Royal Georgofili Society of Florence; of the Academy of Natural Sciences of Philadelphia; &c. Paper VII. . . . .	469
XXVIII.—On Peat Charcoal as a Manure for Turnips. By W. Uppley . . . . .	507

ARTICLE	PAGE
XXIX.—On the Breeding and Management of Horses on a Farm. By John Burke, Jun. . . . .	508
XXX.—On the Cultivation of Flax. By G. Nicholls, Esq. . . . .	547
XXXI.—On the cheapest Method of making and burning Drain- ing Tiles. By T. Law Hodges . . . . .	551
XXXII.—On the Indications which are practical Guides in judg- ing of the Fertility or Barrenness of the Soil. By John Bravender, F.G.S., Land-Surveyor, Cirencester. Prize Report . . . . .	559
XXXIII.—Addition to Mr. Hannam's Paper on Sulphuric Acid, &c.	594

## MISCELLANEOUS COMMUNICATIONS AND NOTICES:—

I.—Experiment on Manures. By Sir William Heathcoté, Bart. M.P. . . . .	277
II.—On the Bathing of Lambs as a Cure for the Scour. By Richard Fisher . . . . .	279
III.—Experiment on the Use of Charcoal as a Manure. By the Earl of Essex . . . . .	280
IV.—On White Carrots. By Sir Charles Burrell, Bart. . . . .	281
V.—Statement of the Situation of the Labourers in the Village of Saxby, on the Lincolnshire Wolds. By John Horsley . . . . .	282
VI.—Chesterman's newly-invented Portable Steaming Apparatus, for Steaming Potatoes or any other Vegetable Roots for Cattle . . . . .	283
VII.—Extract of a Letter from Governor Grey, dated Adelaide, South Australia, December 18, 1843 . . . . .	284
VIII.—On the Italian Rye-grass. From Joshua Rodwell . . . . .	284
IX.—Mode of procuring Water for Irrigation in Affghanistan . . . . .	287
X.—On the Analysis of Guano. By Andrew Ure, M.D., F.R.S., &c. . . . .	287
XI.—Thin-Sowing of Wheat . . . . .	597
XII.—On Grafting Turf. By B. Baker . . . . .	600
XIII.—On the Application of Sulphate of Ammonia to Wheat. By John Barton . . . . .	601
XIV.—On Socket Drain-Pipes. By H. Dixon . . . . .	603
XV.—Experiments on the Use of old Hop-bines as Manure in Hop-Gardens. By Sir John M. Tylden . . . . .	604
XVI.—Trial of Superphosphate and other Manures. By Edward Strouts . . . . .	605
XVII.—On Medical Treatment for Sick Trees. By Sir C. Lemon, Bart., M.P. . . . .	606

ARTICLE	PAGE
XVIII.—A Plan to prevent the Waste of Manure in Rivers which flow through Towns. By W. Popham, Esq., B.A., Oriel College . . . . .	610
XIX.—On the Hainault Scythe. By the Right Hon. Sir G. H. Rose, Bart. . . . .	611
XX.—On the Analysis of Soils. By Andrew Ure, M.D., F.R.S. &c. . . . .	614
XXI.—On Stacking Sainfoin. By the Earl of Essex . . . .	622
XXII.—Experiment on Manures. By Isaac Everitt . . . . .	623

## APPENDIX.

Council and Officers of the Royal Agricultural Society of England	i
Honorary Members . . . . .	ii
Report of the Council (General Meeting, Dec. 9, 1843) . . . .	iii
General Meetings of 1844-5 . . . . .	ix
Statement of Receipts and Payments . . . . .	x
Report of the Council (General Meeting, May 22, 1844) . . . .	xii
Prizes for the Shrewsbury Meeting . . . . .	xix
Prizes for Essays and Reports . . . . .	xxiv
Laws, Bye-Laws, and Regulations . . . . .	xxvii
Council and Officers of the Royal Agricultural Society of England	xxxix
Honorary Members . . . . .	xl
Report of the Council (General Meeting, Dec. 14, 1844) . . . .	xli
Statement of Accounts . . . . .	xlvi
Statement of Receipts and Payments at Southampton . . . .	xlvii
Award of Prizes at the Southampton Meeting . . . . .	xlviii
Commendations . . . . .	lv
Prizes for the Shrewsbury Meeting, 1845 . . . . .	lviii
Essays and Reports on Various Subjects . . . . .	lxiii
Rules of Competition for Prize Essays . . . . .	lxvi
General Meetings of 1845 . . . . .	lxviii

## LIST OF PLATES.

Plate J., Insects affecting Turnips, Corn Crops, &c., to face page . . . . .	236
„ K., Insects affecting the Corn-Crops, to face page . . . . .	506
Plates (2) of Agricultural Weeds, to face page . . . . .	573

## DIRECTIONS TO BINDER.

The Binder is desired to place all the Appendix matter, with Roman numeral folios, at the *end* of the Journal, excepting Titles and Contents—which are in all cases to be placed at the *beginning* of the Part or Volume.



THE  
JOURNAL

OF THE  
ROYAL AGRICULTURAL SOCIETY  
OF ENGLAND.

VOLUME THE FIFTH.  
1844.

PART I.

---

PRACTICE WITH SCIENCE.

---

LONDON:  
JOHN MURRAY, ALBEMARLE STREET.

---

MDCCCXLIV.

THESE EXPERIMENTS, IT IS TRUE, ARE NOT EASY; STILL THEY ARE IN THE POWER OF EVERY THINKING HUSBANDMAN. HE WHO ACCOMPLISHES BUT ONE, OF HOWEVER LIMITED APPLICATION, AND TAKES CARE TO REPORT IT FAITHFULLY, ADVANCES THE SCIENCE, AND, CONSEQUENTLY, THE PRACTICE OF AGRICULTURE, AND ACQUIRES THEREBY A RIGHT TO THE GRATITUDE OF HIS FELLOWS, AND OF THOSE WHO COME AFTER. TO MAKE MANY SUCH IS BEYOND THE POWER OF MOST INDIVIDUALS, AND CANNOT BE EXPECTED. THE FIRST CARE OF ALL SOCIETIES FORMED FOR THE IMPROVEMENT OF OUR SCIENCE SHOULD BE TO PREPARE THE FORMS OF SUCH EXPERIMENTS, AND TO DISTRIBUTE THE EXECUTION OF THESE AMONG THEIR MEMBERS.

VON THAER, *Principles of Agriculture.*

## CONTENTS OF PART I., VOLUME V.

---

ARTICLE	PAGE
I.—On the Farming of Essex. By Robert Baker, of Writtle. Prize Report . . . . .	1
II.—On the Jersey, misnamed Alderney, Cow. By Colonel Le Couteur, of Belle Vue, in the Island of Jersey . . . . .	43
III.—Further Account of the Tussac Grass. In a Despatch from the Governor of the Falkland Islands. Communicated by Lord Stanley . . . . .	50
IV.—An Essay on the Comparative Advantages in the Employment of Horses and Oxen in Farm Work. By James Cowie, of the Mains of Haulkerton, Laurencekirk, N.B. Prize Essay . . . . .	52
V.—The Farming of Cheshire. By William Palin. Prize Report	57
VI.—Method of Growing Beans and Cabbages on the same Ground. By the Earl of Lovelace . . . . .	112
VII.—On the Improvement of Cold and Heavy Soils by the Application of Burnt Clay. By Charles Randell . . . . .	113
VIII.—1. On the Influence of Water on the Temperature of Soils. 2. On the Quantity of Rain-Water and its Discharge by Drains. By Josiah Parkes, Consulting Engineer to the Society . . . . .	119
IX.—On Preparation for the Wheat Crop in Cornwall. By J. H. Tremayne . . . . .	158
X.—Farming of Wiltshire. By Edward Little, of Lower Sheldon Farm, Chippenham. Prize Report . . . . .	161
XI.—Observations on the Natural History and Economy of the Insects called Wireworms, affecting the Turnips, Corn-Crops, &c.; also of their Parents the Elaters or Beetles, called Skip-jacks, Click-beetles, &c. By John Curtis, F.L.S., Corresponding Member of the Imperial and Royal Georgofili Society of Florence, &c. Paper VI. . . . .	180
XII.—On the Building of Cottages for Farm-Labourers. By John Grey . . . . .	237
XIII.—An Essay on Fat and Muscle. By W. F. Karkeek, Veterinary Surgeon, Truro. Prize Essay . . . . .	245
XIV.—Experiments with Salt and other Manures upon Oats, Barley, and Wheat. By John Hannam . . . . .	267

### MISCELLANEOUS COMMUNICATIONS AND NOTICES:—

I.—Experiment on Manures. By Sir William Heathcote, Bart., M.P. . . . .	277
---	-----

ARTICLE	PAGE
II.—On the Bathing of Lambs as a Cure for the Scour. By Richard Fisher . . . . .	279
III.—Experiment on the Use of Charcoal as a Manure. By the Earl of Essex . . . . .	280
IV.—On White Carrots. By Sir Charles Burrell . . . . .	281
V.—Statement of the Situation of the Labourers in the Village of Saxby, on the Lincolnshire Wolds. By Mr. John Horsley	282
VI.—Chesterman's newly-invented Portable Steaming Apparatus, for Steaming Potatoes or any other Vegetable Roots for Cattle . . . . .	283
VII.—Extract of a Letter from Governor Grey, dated Adelaide, South Australia, December 18, 1843 . . . . .	284
VIII.—On the Italian Rye-grass ( <i>Folium Trefolium</i> ). From Joshua Rodwell . . . . .	284
IX.—Mode of procuring Water for Irrigation in Affghanistan . . . . .	287
X.—On the Analysis of Guano. By Andrew Ure, M.D., F.R.S., &c.	287

#### APPENDIX.

Council and Officers of the Royal Agricultural Society of England	i
Honorary Members . . . . .	ii
Report of the Council (General Meeting, Dec. 9, 1843) . . . . .	iii
General Meetings of 1844-5 . . . . .	ix
Statement of Receipts and Payments . . . . .	x
Report of the Council (General Meeting, May 22, 1844) . . . . .	xii
Prizes for the Shrewsbury Meeting . . . . .	xix
Prizes for Essays and Reports . . . . .	xxiv
Laws, Bye-Laws, and Regulations . . . . .	xxvii

#### DIRECTIONS TO BINDER.

The Binder is desired to place all the Appendix matter, with Roman numeral folios, at the *end* of the Journal, excepting Titles and Contents—which are in all cases to be placed at the *beginning* of the Part or Volume.

# JOURNAL

OF THE

## ROYAL AGRICULTURAL SOCIETY OF ENGLAND.

---

---

I.—*On the Farming of Essex.* By ROBERT BAKER, of Writtle.  
PRIZE REPORT.

ESSEX is exceedingly well situated as an agricultural county, not only from its neighbourhood to the metropolis, but also as being, upon nearly one half of its whole boundary, surrounded by the German Ocean and the River Thames, whence the inland navigation is materially advanced by the Stour, Colne, Blackwater, Crouch, and other rivers, intersecting or bounding it, and by an extension of the Blackwater, by the Chelmer inland navigation to Chelmsford; by the Colne to Colchester, as well as by the Stour (dividing Essex from Suffolk); by the Crouch to Battles Bridge, and by various canals from the Thames to Stratford and its vicinity.

Perhaps no other county has such excellent roads, not only turnpike, but even parish highways, which are almost equal to the turnpike roads in other counties.

The soil in Essex varies so greatly, that as much difference of system is required in its culture as between counties remotely situated. The principal substratum is chalk passing beneath nearly the whole extent of the county, and cropping out at Saffron Walden northward, and at Grays Thurrock, upon the Thames, southward, at which latter place are extensive lime works. Upon the chalk rests the London clay, a strong tenacious soil lying from 100 to 300 feet in thickness, also cropping out about three miles south-east of Chelmsford, and extending towards the south; upon which, diluvium consisting of beds of tenacious clay, loam, gravel, sand, and various other strata rest, either in beds uninterrupted for considerable space, or in every variety of admixture in the

same field; in the valleys near the principal rivers fine alluvial soil abounds.

As the system of cultivation pursued upon these different varieties of soil differs so greatly, I shall divide them into classes, and shall mention various parishes and farms that come under each denomination of soil: conceiving that the system pursued in the cultivation forms the main intention of these essays.

### *Division of the County.*

1st. Subsoil—chalky clay, with good depth of soil lying direct upon the clay, or upon beds of strong loam intervening.

2nd. Subsoil—chalky clay, or strong tenacious loam; London clay, or beds of gravel and sand in alternate veins, running for the most part from north to south, but near the large rivers parallel with the same; rich alluvial soil resting upon tender loam, absorbent.

3rd. Subsoil—London clay, with more or less of yellow clay, and sand in admixture with various loams forming the upper soil.

Rich alluvial soil, mixed with greater or lesser proportions of sand or gravel, forming those portions called the light lands of the county.

### *First, or Chalky-Clay District.*

This comprises a large portion of the county, and taking Dunmow as the centre, extends to Cambridgeshire, Hertfordshire, Epping, and nearly to Chelmsford; although the general character is subject to occasional variation in parts of the district.

The parishes of Stebbing and Dunmow, together with all that district called the Roothings, are comprised under this head.

The system of cultivation that has been long pursued is that called the crop and fallow system, by taking fallow and grain crops in alternate years; or by what is termed the *four-course shift*, having equal proportions of fallow, barley, clover, peas or beans, and wheat in each year.

By the former mode.

First year—Fallow.

Second year—Barley.

Third year—Fallow.

Fourth year—Wheat.

By the latter mode.

First year—Fallow, with turnips or cabbages in small portions.

Second year—Barley.

Third year—Clover or peas, beans or tares.

Fourth year—Wheat.

This soil requires considerable attention in management, as it becomes tenacious and compact if trodden or ploughed whilst in a

wet state, and does not recover this poaching (as it is termed) until again pulverised by frost. The nature of the soil almost of necessity precludes the growth of green winter crops for cattle, not from the soil being incapable of producing them, but because the damage caused to the land by removing them in winter is so great as almost to prevent their being grown to advantage; and it is only within a few years that the attempt has been made; but since early swede turnips and mangold-wurzel have become more frequent in cultivation on clay land, they have to some extent been introduced into these districts, and upon some of the soils of deepest staple succeed well; white turnips are also grown to some extent, and of late the cattle kept, which are few in comparison with those upon districts of lighter land, have advantages beyond their predecessors of the last century; for at that period barley-straw formed almost the only staple of cattle food from November to May, not only for neat stock, but for horses also. A better system of management is now generally introduced; the growth of root crops, the yard feeding of sheep in winter, and the consumption of green crops in summer, added to a system of burning the soil (now prevalent throughout the district), has, in many instances, changed the nature of the soil, and in no part of the kingdom can any be found that will make a greater return for high farming. The application of manure, whether from the farmyard or otherwise, increases not only bulk in straw, but quantity and quality also in the grain, and, from the retentive nature of the soil, manure continues to benefit for several years after its application.

The soil is, from the great quantity of calcareous matter it contains, particularly adapted for the growth of barley, which for quality and malting properties is not excelled by any in the kingdom. This barley is principally sold to maltsters at Stortford, Sawbridgeworth, &c., and is sold in London under the denomination of Ware malt, taking that name from Ware in Hertfordshire, a market town standing in a district of similar soil.

The wheat grown in this district is mostly of the coarser description, and is either the common red or brown wheat in all its varieties, or the revit or bearded wheat, of which there are also several varieties; the latter is of a coarse description, but more productive than either of the varieties of common wheat, and succeeds the others in ripening; it was at one period in repute for making a description of flour called "cowens," used by the bakers for making up their dough, and also by millers for mixing with other descriptions of wheat, as might be requisite in particular seasons, as from its lateness in coming to the sickle it has not unfrequently happened that whilst the earlier wheat has been affected by wet harvests, this variety has escaped, in which case it becomes valuable; the price it produces at market has also of late years

approached nearer to the price of red wheat, and from being more productive in the proportion of one in five, the value of the description of land of which we are treating has been enhanced proportionably.

The varieties of red wheat principally grown are the Syer, golden drop, American, Burwell, Russell, and Smoothy; the two last are new varieties, having the character of some of the preceding. The Syer is a variety producing an abundance of straw. The golden drop, wheat with long and also very stiff straw, not easily lodged, and very productive in dry seasons. The Burwell, a variety of fine red wheat grown at Burwell in Cambridgeshire, from whence its name; and the Russell and Smoothy, a close compact-eared wheat of the American character, and also very productive upon the best descriptions of land. White wheat is grown of good quality, but only to a limited extent.

Peas are grown to some extent, and are frequently sown with oats as food for horses. This crop is denominated bullimong, and probably answers on some descriptions of soil; but the practice should be exploded, as the land cannot be so much benefited as it would be by taking the crops separately in proper succession.

Beans are not much grown, but upon the more heavy tenacious clay soils they are produced with success; whilst upon the chalk-clay subsoils, with thin staple, they do not succeed so well as peas; the latter also are grown in limited quantities.

Clover is grown only once in six or eight years, for if sown oftener, it is apt to fail in plant; and even when in plant it is not very productive, unless highly manured, which is done upon the young plants in the autumn; in that case it is mostly afterwards mown; but the usual practice is to feed with sheep through the summer, or to feed close until the 1st of June, when the stock is removed, and the clover is reserved for seed, producing from two to eight bushels per acre; four bushels may, however, be considered an average crop. The expenses attendant upon thrashing and preparing for market are so great as frequently to leave the producer a loser; these expenses being, upon an average, about 4*s.* to 7*s.* per bushel of 70*lb.* weight.

Tares or vetches are grown to a considerable extent, as the comparative scarcity of pasture land renders it imperative upon the farmer to produce artificial green crops as a substitute for grass in summer, and hay in winter, as well as for the improvement of the land by feeding with sheep or folding in yards in the summer months.

Small patches of pasture land (for the most part) only are to be found upon farms in this district; but in the vicinity of Ongar, Epping, and Harlow, nearly one half is of pasture, excellent in quality, though not productive in quantity. Dairying was formerly



very prevalent in this district, but is now almost discontinued, the suckling of calves and grazing having in a material degree superseded it; but the butter, when produced, is of fine flavour and quality, and bears a high price in the London market.

The system of management pursued appears well adapted to the district, as abundant crops of barley and wheat are produced upon the system of alternate naked fallows; and although it may appear not so profitable, still when put into competition with the four-course shift, less difference, upon calculation, becomes apparent than might be at first supposed; this arises from the greatly diminished expenses of cultivation, as by a continuous system of farming upon this principle weeds become almost eradicated, and in many portions of the district under good management are hardly to be found in the eddishes, with the exception of the yellow charlock, which appears in the barley crop, and, in the spring, sometimes prevails so much as to render the fields one continuous mass of bright orange colour, undoubtedly injuring the crop, but certainly not to the extent that a casual observer would imagine.

The system as carried out is upon ridges of four furrows only, five of which ridges in width make about a rod, or 3 feet  $3\frac{1}{2}$  inches each. These, in the first instance, are what is termed sized; that is, if the land is harrowed or scarified down flat, the ploughman sizes them by going one bout, or by once going and returning up the field; which an experienced hand can effect with the utmost precision. The next operation is called four-furrowing; the ridge being ploughed in a neat compact manner with two bouts or four furrows: these, again, are either struck down with two furrows, as in the first instance, and again four-furrowed, or four-furrowed in succession, the tilths being given at intervals of about one month, and from three to four altogether during the summer; three and half (or twice four-furrowed, and three times struck or sized) constituting what is termed a clean summer's fallow.

The land lies in this state either (as it is termed) upon the round ridge ploughed with four furrows, or upon the flat ridge ploughed with two furrows, until the following spring, when in the month of March it is either scarified and drilled, or the barley is sown by three operations, and partly ploughed and partly harrowed in with a very light pair of harrows. Four ploughs and a pair of harrows, with one seedsman, will put in from five to six acres per day, and the neatness with which it is executed exceeds description, as upon an acre scarcely a clod of two inches' diameter can be seen, and the finest tilth imaginable is produced by the action of the frost during the winter.

When the scarifier is adopted, the drill becomes necessary, and as this mode in the majority of seasons succeeds best, it is now be-

coming exceedingly prevalent, as the land is not so likely to reunite should excessive rain succeed, nor so liable to be affected by drought should dry seasons follow. A saving is also effected in expense and seed; the former mode requiring four bushels per acre, but the drill requiring only three bushels per acre. The produce may be estimated from four to six quarters per acre, and five quarters may be taken as the full average crop of the district. The difference in expense by the two modes would stand as follows:—

*First Mode.*

	£	s.	d.
First year making the fallow, three whole tilths, and one strike, at 8s. . . . .	1	8	0
Two harrowings . . . . .	0	1	4
Seed tilth . . . . .	0	8	0
Harrowing . . . . .	0	1	4
Seed, four bushels . . . . .	0	16	0
Sowing . . . . .	0	0	4
	<hr/>		
	£2	15	0

*Second Mode,**By the scarifier, as follows:—*

First year fallow . . . . .	1	9	4
Scarifying . . . . .	0	2	9
Harrowing . . . . .	0	0	8
Seed, three bushels . . . . .	0	12	0
Drilling . . . . .	0	2	6
	<hr/>		
	£2	7	3

Gain by latter process, 7s. 6d. per acre.

The barley is seldom interfered with until the following harvest, the clean state of the land not requiring the hoe, and the yellow charlock usually appearing in such quantities as to defy it; but by a perseverance for a succession of years in hand-weeding it out of the crop, it may be entirely eradicated, and has upon some farms belonging to and occupied by the owners been thus got rid of, but as leases are not sufficiently extended so as to repay the tenant his expense in effecting so desirable an object, it is seldom attempted.

In the third year the same routine of fallowing again takes place, and the wheat is ploughed in beneath the furrow, and left without harrowing, an operation effected at so little expense as to put those lands beyond comparison in that respect with any others in the kingdom, as the whole operation of ploughing and putting in the seed does not exceed 8s. 9d. per acre; the quantity of seed mostly sown is  $2\frac{1}{2}$  bushels per statute acre.

	£.	s.	d.
Brought down making fallow . . . . .	1	9	4
Seed tith . . . . .	0	8	0
Sowing and preparing seed . . . . .	0	0	6
Water-furrowing, &c. . . . .	0	0	3
Weeding . . . . .	0	1	0
2½ bushels of seed at 50s. per qr. . . . .	0	15	7½
	£2 14 8½		
Add two years' rent . . . . .	1	16	0
Rate . . . . .	0	8	0
Rent-charge . . . . .	0	10	0
Harvesting with beer . . . . .	0	12	0
Thrashing 4 quarters at 3s. . . . .	0	12	0
Marketing and carriage . . . . .	0	6	0
	4 4 0		
	£6 18 8½		
Brought down . . . . .	6	18	8½
Incidental fencing, windrows, &c. . . . .	0	5	0
Draining 3 <i>l.</i> per acre for 14 years } 10 per cent. . . . . }	0	6	0
Interest of capital, 2 years . . . . .	0	12	0
	£8 1 8½		

Produce of 4 quarters . . . . . 10 0 0

Leaving 1*l.* 18*s.* 4*d.* for implements, wear and tear, assessed and property tax, and for 2 years profit.

It is usual after the fallow in the fifth year to introduce clover, which is sown either at the time of sowing the barley, or about one month afterwards, at the time of rolling the land with a light roller, to make the surface smooth for the better enabling the mowers in the succeeding harvest to mow off the crop evenly; the clover is usually fed with horses and sheep, and, from the absence of other pasture, frequently with cows and other neat stock. Upon the better descriptions of land the clover is mown for hay, but upon the poorer soils the crop is of the meanest description, the stalk of the clover becoming of a dark purple colour, or, as the farmers term it, "red-shanked;" and upon such lands the crop is almost valueless, as neither sheep nor horses will eat it readily, as it is supposed a bitter flavour is imparted from the soil, to which they have an utter aversion, and will starve in the midst apparently of plenty. Tares, both winter and spring, are grown for green food, but are considered not to improve this description of soil, making it so light and porous that neither wheat nor barley succeeds well after them. Beans are sometimes taken, and peas at this time, and upon the land most suitable (such as has sufficient depth of staple) succeed tolerably well. The estimate

upon the best lands cannot, however, be taken at more than 32 bushels per acre, and upon the inferior lands at about 18 bushels.

The routine of farming presents so little variety upon soils cultivated upon this system, and the active management is reduced into such narrow limits, that during the winter months it very little engages the attention of the farmer beyond that of merely attending to the thrashing and marketing his grain, and carrying out his draining, which, however, requires his close inspection, for unless this department is well looked to (being task-work), the labourers will not execute it properly; and instead of benefiting their employer, will for the sake of the trifling difference in wages that they can thus obtain, produce more mischief than they effect good. The best mode is to let the cutting of the drains by task-work, for which from 2s. 6d. to 3s. 6d. per score rods is paid; a confidential man is employed to fill and complete them, for which he is paid by the day; but upon small occupations this department is undertaken by the farmer himself, or his sons, who attend in the afternoon, and, after having seen that the drains are properly cut, commence filling them with wood and straw. It is presumed draining has been carried on in this district longer than in any other part of the kingdom, evidence of its having been practised for upwards of one hundred years being found from old entries of labour paid; but the supposition is that it has been in use from about 1700, that is, nearly 130 years after Tusser published his "500 Poyntes of Husbandry," in which work he makes no mention of the practice. The process as carried out is simple and effective, and of little expense in comparison with that practised in other districts; several methods are prevalent, of all of which sufficient notice will be taken to show their comparative merits.

The oldest and still most prevalent mode is by ploughing out the drains transversely to the ridges, or rather diagonally of the field, taking care to give them sufficient fall or draught for the water. They are usually ploughed parallel to each other at distances varying from 5 to 7 yards apart, those soils where the greater quantity of chalk abounds not requiring them to be so near to each other as where the stiffer loam prevails. The ploughman first opens his work with a larger and stronger description of plough than the common foot plough used in the district for ordinary purposes; this he does by ploughing out four furrows, commencing on the outside, leaving what is called a baulk in the middle, which is also ploughed out by two furrows more; the plough is then brought back in the bottom of the last ploughed furrow, and by one or two operations a depth of 6 or 8 inches is obtained. Sometimes a second plough is used of peculiar construction, having a narrow ground and light breast, which takes

out the last furrow clean; the next operation is to plough out the leaders or main drains at the lowest end of the transverse drains, and an opening to about every 100 rods of common drain is made into the ditch surrounding the field (which it is necessary to have well made previously to commencing the operation); these necks, as they are termed, to the main drain or leaders are cut into the open ditch, on whichever side of the bank it may happen to be: the workman then proceeds to dig out the main drain, which he does with a spade about 10 inches long and about  $3\frac{1}{2}$  inches wide at the point; a boy follows with a small shovel and casts out the loose mould; after having completed a few rods, he is followed by another drainer, or he returns and with another spade longer and narrower than the last cuts out the next spit or lower part of the drain, either leaving a shoulder or not on each side, as may be required; but for the ordinary mode of filling no shoulder is left, but the drain is cut with the utmost precision, not perpendicular but slanting about 3 inches; the drain is cleaned out with a scoop, termed a hoe, and when the drainer arrives at one of the drains that enter the leader, he commences upon it by necking it in, before taking out all the soil on each side of the point of intersection. This he does to prevent the edges being broken down by the operation, and thus proceeds with all the drains successively, taking care not to open more of the main drain than he requires to enable him to proceed with the cross drains. The main drains are usually dug out to a depth of 22 inches, and the cross drains 20 inches beneath the ploughing, so that their depth is about 26 and 30 inches respectively. After his work has proceeded, so as to enable him to fill in with the materials necessary, which consist of wood covered with straw, or with thorns and straw, or straw alone, either twisted into long bands or not, or, in the absence of either, stubble gathered from the field; but the work is considered best done when proper wood is selected, of which the common hazel-nut wood and sallow are best, or thorns that are long, clear, and straight; he then commences at the point where he left digging, and puts in the wood compactly and neatly at the bottom of the drain, cutting it into proper lengths, and weakening it "with a cut half through at the crooked parts so as to enable him to fill" the drain about 3 inches high, keeping the largest wood at the top and pressing it down closely piece by piece with a small crotch-stick, the ends of the last put in lengths lying upon those put in first, so that the whole may gradually overlap the last, as at B, that running water may meet with no obstruction by the ends of the pieces of wood meeting it, which would be the case if the filling commenced at the part first dug. The workmen prefer the latter mode, and unless watched closely will adopt it, as it gives them less trouble; but an inspection of

the two modes in the annexed diagram will show the superiority of the first-described plan:—

Position of wood.



Course of the water from A to B.

After the wood is placed, the straw, which should be long and straight, is placed upon the top about 3 inches thick, and firmly trod down by the workmen passing along upon it, putting it down at the sides of the drain, with both hands at the same time, which he effects as he walks along. The drain is then filled in with the soil that was taken out, unless it is stiff, tenacious loam, which is cast aside and supplied by the upper surface-soil; but if the soil is white chalk-clay, it is best to put it direct upon the straw, as it forms an arch more substantial than soil of a porous quality. Some persons have the wheel of a heavily loaded cart drawn along the drain, whilst others condemn the practice altogether; but my own observation has led me to approve of the plan, unless the soil should be of an extraordinarily stiff character. Care should be taken to put larger wood at the ends of the main drains, so that they may be afterwards easily found; and to prevent rabbits, moles, rats, and other vermin destroying them, which they will do unless great care is taken to prevent it; but the better plan is to fill them for about 3 feet with 2-inch earthen pipes, by which security is obtained against such accidents.

Other methods are prevalent, and one most in use is by having a piece of wood, about 6 feet in length and three inches in depth, and made to fit the bottom of the drain in width; this is wetted, and placed at the bottom of the drain, upon which the soil taken out is rammed to the thickness of 3 or 4 inches. By the assistance of a lever attached to a chain fastened to this plug, as it is termed, it is drawn forward as the work proceeds, and thus a hollow drain is left, equal to about 3 inches diameter, which answers extremely well upon sound chalky clay soils, but should never be adopted upon very stiff loams, as the ramming of such descriptions of soil would cause it to become so compact as to prevent the water finding admission into the drains at all. These two methods are more prevalent than any others, and indeed are almost the only ones adopted in this district; and, if well executed, will continue to act well for fourteen or twenty years. It is necessary that the drains should be cut transversely with the stiches, to prevent the horses, during wet seasons, treading them in, which they most certainly would do if the drains were cut in the direction in which the horses walk during the ploughing of the land.

Another system is introduced with excellent success; viz., by

the windlass mole-plough, which presses out a drain, of about  $2\frac{1}{2}$  inches in diameter, at 12 or 14 inches below the depth ploughed; exactly as for the spade drains. So the leaders or main drains are mostly dug as before described, and filled with wood and straw, and are made either before the ditches are mole-ploughed or not; but it is most important to have men to work upon them during the same time the ploughing is going on, for should heavy rain fall before the main drains are cut, it would destroy the ploughed drains altogether by the deposit that would be left after the water had drawn off. A mole-plough drawn by twenty horses is also used; but the windlass mole-plough, from its steady action, and requiring but two horses, succeeds better. Drains effected in this way are found to run well for ten to fourteen years upon the chalk clay, but upon loamy soils they soon close in, by the loam, after a short time, again uniting and filling up the drain.

The cost of the two operations differs so much in amount, that the latter mode is superseding the former to a considerable extent—very much depriving the labourers of winter work, which was provided in a great measure by the former mode.

The cutting and filling the drains 22 inches deep costs from 3s. to 4s. per score rods; but, probably, on sound clay, not exceeding the former sum. About 8 score rods are put in each acre; this, at 3s., would be 24s. per acre; if wood and straw are used, about 24s. more; but if thorns or haulm only, about half that sum. The labour in cutting drains, and for hire of mole-plough horses and driver's time, will not exceed 15s. per acre for the same quantity of drains. The charge for the man and plough is from 8d. to 12d. per score rods, or about 6s. per acre over and above the additional sum for the horses' time and for cutting the main drains.

When the land is regular in descent, and all the drains run in one direction, the better way is, in the second ploughing of the fallow, to put the stetches in the direction of the drains, and to make them of the same width as the drains require to be from each other; thus nearly all the labour may be saved of ploughing out the drains, and again ploughing them in after the operation, as the merely ploughing of the stetches will effect that object in the ordinary way; care should, however, be taken always to plough over the drain as soon as it can be done, for in the event of heavy rain falling the drains would be injured by the soil washing into them; and care should be taken to prevent the drains uniting with the main drains at less than an angle of  $60^\circ$ , as the accumulation of soil carried down by the water would be prevented escaping when the drains are first made, and probably spoil them altogether.

The process of burning the soil for purposes of manure being peculiar to this district, it will not be out of place to give a description of it here.

Two methods prevail—the one the burning in large masses, and the other in small heaps; and two descriptions of soil are collected for that purpose, the one consisting of the green strips of uncultivated land lying round the sides of arable fields, which are dug up in spits, about 8 inches in depth, and partially dried by the sun and air before burning; by the other, the whole surface of the field is ploughed up, with as thin a furrow as possible from a grass, sainfoin, lucerne, or other layer, upon which a large quantity of vegetable matter has accumulated, this, being partially dried by exposure during summer, is collected into heaps containing about 4 square perches, and by a process peculiar to the district is burned so as to be reduced about one half in bulk; the ashes and unconsumed matter being carefully spread afterwards as manure for the succeeding crops. The labourer commences by placing some large pieces, by which he frames an artificial furnace, open to the windward side; he then places some dry stubble and ordinary wood or thorns upon the top, and partially covers with some of the driest of the collected earth; the fire is then applied, and as it progresses the whole is speedily covered with the earth, and by degrees the remaining earth is applied; taking care not to allow the fire to burn through to the external surface of the heap without applying a fresh supply of the earth, and at the same time avoiding laying it on too thickly, so as to press down the heap closely in the first instance. With attention and assistance, many of these fires are kept burning at once, night and day, until the whole field is gone over; and, with proper skill and attention on the part of the workmen, very little escapes the action of the fire in the first instance, but should any escape it is collected and carried forward to the next succeeding row and there consumed. It is difficult to burn the earth collected from around the sides of fields in the same manner, and the heaps are therefore increased to a larger size, the same process only being necessary of constantly applying fresh matter wherever the fire is seen bursting through, for should that be the case to any extent, unless fresh wood is applied and relighted, the fire of the whole soon becomes extinguished. The objection to burning in large heaps arises from the strength of the fire being so much increased as to burn the earth *red*, and sometimes almost as hard as brick. Attempts have been made in districts where gravel is scarce to burn it for the purposes of road making, but the action of the frost soon reduces it to its original state, so as to make it in the end totally useless, unless a coating of gravel is afterwards applied.



The advantages attending this process have long been canvassed by agriculturists; the objections taken by landlords and their agents are, that by continual repetition it reduces the staple of the soil, and by concentrating the salts and other matter enables the tenant to avail himself of all their fertilizing properties at once, to the injury of his successors; but on the other hand it is contended that, as the application of the system enables the tenant to produce excellent crops of vegetables upon a soil where none were originally grown, he is enabled to keep an increased quantity of stock, and thus more than repay by manure what he had exhausted by the fire. It is not the intention here to discuss the question, but to state a few facts that elucidate the point; the process undoubtedly when carried on in small heaps does not waste the soil as much as when in large heaps; the direct advantages are the destruction of the coarse vegetable matter it contains, thus preventing the injurious effects from wireworm and other insects, by killing their larvæ, the production also of a clean surface, and the being enabled at once to bring the land into cultivation for rape, turnips, mangold-wurzel, and cabbages, all of which succeed well after burning without the aid of farm-yard manure. The land to which the ashes are applied becomes for several years afterwards more easy to pulverize; and the first grain crop succeeding the application is frequently increased in quantity and quality 20 to 25 per cent. Barley certainly partakes of the benefit more than any other crop, and the clover generally succeeds well afterwards.

These are all advantages; and as to the disadvantages they cannot be met better than in the statement of Mr. Litchfield Tabrum, formerly of High Roothing, Bury, an extensive clayland farm: for upwards of twenty-five years the system was carried out by him in the most perfect manner, and the sums paid for labour were very great; but from the fact of the number of sheep and neat stock being increased six-fold at the latter portion of his term, and the productiveness of the farm so greatly increased as to induce the succeeding tenant to give a very considerably increased rent, we may infer that the advantages far outbalanced all those objections raised against its practice; and from the high eulogiums passed upon the system by Mr. Tabrum, and the success that attended his exertions throughout, added to his afterwards carrying out the same process upon his succeeding occupation with equal success, no one acquainted with him, or the facts attendant, can doubt of the benefit to be derived from his course of practice: other experienced farmers in the district, of whom Mr. Saltmarsh, of High Easter, stands most prominent, carry out the system with the same advantages. One point I omitted to mention is, that the quality of the barley as well

as quantity is considerably improved, and 2s. per quarter is the lowest estimate at which such improvement can be calculated; the soil containing a large portion of chalky matter is partially converted into lime, potash too is formed from the combustion of the inert vegetable matter, and other salts are generated, conducive to the increased production of crops of vegetables and grain. The cost of producing this manure is less than that of any other description equally beneficial to the land; it is produced upon the spot where it is required without the expense of carriage, and the whole outlay does not exceed in any case 40s. per acre. The burning into ashes is paid for either by the cubic yard or at so much per heap; for digging and burning 5*d.* to 6*d.* per cubic yard of ashes is paid, and in some cases 7*d.*; for burning in heaps of 4 perches each, of which there are forty to the acre, 8*d.* per heap, and the use of a horse, or donkey, and cart. Upon land containing a greater proportion of silica the cost is increased, as the waste is greater than where pure clay abounds, as each heap will then contain about 1½ to 2 yards, and 60 to 80 yards will be given to each acre: when carted on from large heaps from 40 to 50 yards per acre are usually applied, but this depends upon circumstances; when applied for turnips the ashes are sometimes spread in drills and ploughed in as other manure. It has been suggested and proved that if the finest portions are sifted from the coarser, and drilled in with the turnipseed, the crop will be more benefited than by adding a larger portion in the ordinary way. Some farmers combine the ashes with bone-dust and other artificial manures with decided advantage; and setting all other considerations aside, the process assuredly induces a clean system of culture, and finds much useful employment for the labourers, not the least important consideration at this time.

The live stock kept in this district varies with the opinion of the respective occupiers; and from Essex being but in a limited degree a breeding county, all the varieties of Welch, Scotch, and homebred inferior short-horn cattle are found. In this district especially, the Welch breeds are preferred and used; as cows they are considered better adapted than any other kind. The polled Suffolk cow is also kept, and is well adapted for either dairying or for suckling calves for the London markets. These calves are brought from London and other dairying districts when about 7 days old, and are sold from 15s. to 40s., and sometimes as high as 45s. each; they are usually kept on milk alone for 10 weeks, leaving a profit of about 4s. 6*d.* per week in the summer, and from 5s. to 5s. 6*d.* in the winter months; but of late the trade has been greatly depressed and the profits materially reduced. A cow is considered to pay well if she produce a net profit of 8*l.* yearly; but unless the pastures are good few reach that amount, as the

suckling-calves have lately been bought in at a much higher rate than formerly.

The fattening that is carried on is effected with the help of mangold-wurzel and swedish turnips; but second-rate animals are, for the most part, usually fed, being kept upon straw and a few turnips the first winter, grass in summer, and sold off in the autumn, or fattened in the early part of the ensuing winter.

The sheep are principally Hampshire Downs, with some Sussex Downs, and half-bred Down and Leicesters, but the former answer best and are most extensively kept. Wether lambs are purchased in the autumn and are kept either in the yards or pastures during the winter, and in the ensuing summer either folded upon the fallows or fattened upon the clover; in the former case they are sold in the ensuing autumn or winter, fed upon turnips, oil-cake, or beans. Hampshire Down ewes are kept on small farms for producing early lambs for the London markets, and the ewes themselves are also sold for the shambles in the autumn; the average cost of the ewes per head being about 24s.; the return, including the wool and lamb, from 50s. to 55s. Lambs are purchased at about 18s. each; and if fattened from the clover, produce about 30s. to 32s. each, including the wool; those sold for stock realise about 25s., inclusive of wool; but as by the management alone the profit may differ from 20 to 30 per cent., no estimate but a general one can be given. Breeding sows and swine are kept upon most farms, and are of the Essex variety, known as the half-black breed; but not of that description introduced as the Essex breed by Lord Western and Mr. Fisher Hobbs (these, being of modern introduction, have not become prevalent at present); but a larger description of distinct black and white colour, the space over the shoulders being, for the most part, white, with full hanging ears, excellent mothers and prolific, producing from eight to fourteen at each litter, which grow quickly, and at three months old are sold for the London market and large distilleries; at ten months old they average about 180lbs. each.

The implements used in this district are not peculiar; cast-iron foot-ploughs with wooden beams and handles, in using which the horses are driven abreast with hemp-reins, or by the voice of the driver; in some instances wrought-iron shares are still in use; the ploughs for the most part being lighter and narrower than those used in the other districts of the county. The ploughmen are very expert, and have no difficulty in performing the work to the amount of a full acre per day. In the spring months from  $1\frac{1}{4}$  to  $1\frac{1}{2}$  acres are usually effected upon the fallowed lands; the labour to the horses being at that season of the most trifling nature, and

those best calculated to walk quickly are selected as best adapted to effect the work.

Common harrows made with wood, and iron teeth, are most prevalent, not only here but throughout the county. They are extremely small, so that six of them form a set, being fixed together with iron couplings and attached to long or short whipple-trees, by a chain and swivel; two of these harrows cover a single ridge of four furrows; four cover an eight-furrow stetch, consisting of two ridges bouted into one; and the six covering the three ridges ploughed as one stetch of twelve furrows, each ridge being 3 feet  $3\frac{1}{2}$  inches, and each harrow being only 1 foot 7 inches wide, having two sides running parallel with four or six cross-bars united to the sides with a tenon inserted into a mortice.\*

Rollers peculiar to the district are used, the one a small-bellied roller about 4 feet long, without a frame; the other a similar roller, double the length, with a frame; the first is used for rolling four-furrowed ridges, and the latter eight-furrowed ridges: the common roller peculiar to the other parts of the county is of different dimensions; the double roller with joints, to enable the horses to walk in the furrow, and having one shaft fixed to each roller, is of modern invention, and supersedes both the other descriptions upon stetches of all sizes and of different planes, as the roller, from being attached by joints adapts itself, as it proceeds, to every description of stetch it passes over.

Root-ditching, as it is termed, is prevalent throughout this district; this is performed by cutting a drain about 20 inches in depth, parallel with the banks round the fields, about 10 feet from the hedges; by thus dividing the roots that protrude from the trees, great injury to the crops is prevented; otherwise, in dry seasons especially, they affect the crops to an astonishing degree for several perches from the fences, especially where ash-timber abounds. Here, however, pollard oaks, with now and then a clump of elm and ash thinly scattered, are the extent of our timber. The fences are also weak, with low banks (thence the repute as a hunting district), of which the live portions are principally black-thorn and hazel. Fences more recently planted consist of white-thorn quick, placed upon the face of the bank in single or

---

\* An objection, however, exists as respects harrows made upon this construction, for, from the sides throughout being parallel, and a space being allowed for each harrow to work independently, the tines are apt to leave the edges of the furrows uncut in straight lines; this is obviated by increasing the length of the foot-chains of each harrow gradually from side to side of the whole width, and, instead of being fixed at the middle of the front bar, each is fixed more towards one side than the other, by which the harrows, when drawn forward, move diagonally, and thus more fully effect the object of thoroughly pulverizing the surface

double rows, with a ditch in front from 4 to 5 feet in width; those fences are closely cut about once in eight years; and of part of the materials is formed a hedge after the ditch has been scoured out and the soil placed upon the top of the bank.

Upon some of the thin-stapled lands of this district sainfoin is grown with success, and affords excellent crops for hay for several successive years of from 20 to 35, or even 40 cwt. per acre; the process is, late in April to drill upon the same land on which barley has been sown about 5 or 6 bushels per acre of new seed, which is generally done acrossways of the stetches; the sainfoin comes on in the following year, and after the crop of hay is taken, produces an abundant second crop, which is fed with cattle and sheep. It is necessary to the produce of this crop that the land be thoroughly drained, and that it have a top-dressing in the autumn, of which coal or wood ashes, or soot, are said to be superior to farmyard-manure; it succeeds well upon all land having chalk or chalk clay as the subsoil, and is a great acquisition to farming in districts where lands are too poor for clover and artificial grasses.

This division, comprising fully one-fourth of the county, is important as a wheat and barley growing district. The soil is more certain as to an average annual return, being less affected by either wet or dry seasons than most other districts, and in the latter producing crops good in quality as well as quantity. Many portions are cultivated at as little expense as in any other district in the kingdom; but from the crops being produced only in alternate years, and the quality of wheat being coarse, *less profit* is derived than from more fertile districts.

The amount of wages throughout this district ranges from 2s. to 3s. lower per week than in many other districts in the county. The labourers' cottage-rents are, however, fully 1s. per week lower than elsewhere; and, for the most part, larger gardens are attached to the cottages. Flour of a coarser description is eaten, and some privileges are enjoyed as regards fuel, which makes the difference not so great upon comparison as it appears at first sight—the wages at the present moment being from 8s. to 9s. per week; poor-rates from 3s. 6d. to 4s. per acre (3s. 9d. may be taken as the mean); surveyor's rates, 10d.; church-rate, 2d.; tithe rent-charge from 5s. up to 6s. per acre; rent from 15s. to 22s. per acre (the average certainly below 20s. per acre). Throughout this district, the farm premises are ill arranged: large barns, sheds, and waggon-lodges, being placed inconveniently, and detached from each other—the accumulation of water from their thatched roofs falling into yards having large hollows and excavations made by constant scooping out the clay from time to time as the manure is carted out, so that a person unacquainted with

their inequalities is liable to be engulfed in them, as the surface, being covered with the accumulated barley-straw, exhibits *all smooth* to the eye; and it is only by the rising of the water and sinking of the straw that he is awakened to the situation he is placed in. This, however, has been remedied by the more spirited occupiers, but still prevails to an extent deserving their attention, as, upon a moderate estimate, one-fourth of the most valuable properties of the manure is thus annually lost.

The farm-buildings are commonly timber-built, and thatched. The external walls are either common weather board cut from elm timber, or clay daubing upon lath—the clay being suited to this kind of work and very durable, and when whitened over with lime having a neat appearance; the white gable-ends of the buildings and houses shining in the sun's rays give vigour and relief to the landscape.

#### *Second or Mixed Soil District.*

I shall now proceed to the second or eastern division, comprising all that portion described as consisting of gravel, with beds of loam, chalky clay, and alluvial and diluvial strata, in successive order or abruptly displaced.

I shall commence with the land lying upon the banks of the Chelmer, which, to an extent of about 2 miles northward and southward, may be taken as a tolerable specimen of the other portion lying upon the Stour and Colne, and extending from Colchester to Harwich.

The tender loam or brick earth subsoil, lying nearest the river, is in some instances uncommonly fine, and well adapted for the growth of almost every description of vegetable and grain crops.

The higher portions of Danbury, Baddow, Tiptree, &c., constitute a division remarkable for its abrupt varieties of subsoil, consisting of strong clay, gravel, sand, loam, and beds of pebbles lying alternately in successive strata in the same field.

This portion of the county is remarkable for its fine timber, the hedgerows abounding with elm, oak, ash, and maple; but from the fields being small they cause incredible damage to the crops by their roots extracting the nutriment, and shading them from the sun, compensating only by the beauty afforded to the landscape by the multiplicity of tints and variety of foliage displayed.

The beauty of the country, as viewed from these elevated points, is unsurpassed by any other in the kingdom; and the salubrity of the air contradicts the opinion that Essex is an unhealthy county, portions of it alone having been liable to that accusation, and those portions being now rendered healthy by the drainage that has been effected, as well as by the abundance of fresh spring-water which has been procured from artesian wells.

Rich meadow land abounds upon the banks of the rivers, but the quantity requisite towards the proper cultivation of the arable land is *below* rather than *above* the average; still the defect is well supplied by artificial grasses. Many portions of this division are farmed in a very superior manner: many farms, almost entirely arable, maintain a sheep to every acre the greater portion of the year, with bullocks or cows in proportion of from 5 to 10 to every 100 acres during the winter months. The system of bare fallows is almost exploded in this district, except upon the heavier descriptions of land, unfit for the growth of turnips or green crops. The prevailing system will be best described by stating the rotation and application upon a farm already in cultivation, commencing after the wheat crop has been taken off.

Immediately after or during harvest the stubble is collected unless the wheat has been mown, and the land receives one, two, or more deep ploughings, if time allows, and if the soil be gravelly. Rye is sown upon a very fine tilth, produced by more than one ploughing, and sown upon the surface or drilled fleetly, and lightly harrowed in; or if the soil is loamy, tares are sown, mixed with either rye or winter oats, or both. The rye is partly mown for horses and cattle early in the spring, being cut into chaff with proportions of hay and straw, and a part is fed off with sheep; the land being further improved by carting mangold-wurzel on the field to feed with the rye, with the addition of oil-cake or other artificial food. The land is again quickly ploughed once or twice, and well scarified. A crop of swede or white turnips is then taken, half of which is usually drawn, and the remainder fed off with sheep; and the land is either ploughed, and sown with wheat, or remains, as most usually is the case, until the following spring, when it is either ploughed or scarified, and drilled with oats or barley. The clover is sown with this crop, and is either mown for hay, and the after-crop fed off with sheep, or fed early, and left to stand for seed, or fed altogether through the summer with horses, pigs, and sheep; or, in lieu of the clover, peas or beans are grown, which are hoed well as long as weeds can be extracted without injury to the crop. If clover has been taken, it is ploughed up in October, and the land sown, dibbled, or drilled with wheat, which is carefully weeded, and reaped or mown at the following harvest, when the same mode of cultivation is repeated; or the land receives a partial fallowing in the autumn, and is sown with mangold-wurzel. This is succeeded by barley or oats. If clover was taken in the previous course, beans or peas are now taken, and wheat succeeds; and oats sometimes follow, if the wheat has succeeded clover: thus by alternating the crops, giving frequent ploughings and manuring, a regular succession is kept up of green cattle crops intervening with the grain crops, giving the greatest possible

return from the land, but certainly not without a corresponding outlay in labour.

The usual system, however, is what is termed the four-course shift, which, in eight years, will stand thus—sometimes, however, oats are taken after wheat with good success, and are allowed in the covenants of leases to the extent of one field only—

- |               |                                |
|---------------|--------------------------------|
| 1st. Turnips, | 5th. Mangold-wurzel or Swedes, |
| 2nd. Barley,  | 6th. Oats or Barley,           |
| 3rd. Clover,  | 7th. Peas or Beans,            |
| 4th. Wheat,   | 8th. Wheat.                    |

If oats are taken in succession after wheat it would be done in the fifth year, and the course of cropping would then proceed as described.

The probable result will be, upon well farmed land, as follows:—

1st. Turnips.....	manured	15 to 24 tons per acre.
2nd. Barley.....	„	40 to 48 bushels per acre.
3rd. Clover.....	„	1½ to 1¾ ton per acre.
4th. Wheat.....	„	28 to 32 bushels per acre.
5th. Mangold-wurzel.....	„	20 to 30 tons per acre.
6th. Oats.....	„	48 to 56 bushels per acre.
Barley.....	„	40 to 48 bushels per acre.
7th. Peas or Beans (precarious)	„	28 to 32 bushels per acre.
8th. Wheat.....	„	28 to 30 bushels per acre.

This would be the probable result upon good farms with high cultivation; upon second-class farms, 4 bushels less of wheat, 6 of barley, and 8 of oats would be grown; the average of the district may be taken as the mean between the two quantities.

A covenant of lease and custom prevails not to allow clover to be mown twice in one year. This should be exploded, as the land is not injured by two mowings; and if the hay from one crop is expended, it is more than equivalent in return of manure than if the whole was fed by sheep.

Little can be offered, in a general description of the cultivation of a county or district, beyond that of merely stating the system of cultivation carried out by the best farmers, who, from long experience and practice, in most instances succeed better than a stranger who introduces a new system; for it happens that strangers rarely succeed so well as those who from their youth have been identified with a particular locality. This is especially true as regards this county, as very few farmers from distant counties, who have come under my notice, have succeeded here. And so it is as regards winter fattening; upon the clay and retentive soils it is very true that fine crops of turnips can be very frequently produced, but this is always at the expense of a large



quantity of manure; and the injury done to the land by carting off, or by treading heavily with sheep during the winter months, and more especially by suffering crops of turnips, rape, cabbages, or other food of like nature to remain late upon the land, for the use of early-lambing ewes and other stock, does deteriorate it to such an extent as nearly to exhaust the manure for the next crop, which is exemplified sometimes by a portion of the field remaining in fallow and producing crops 20 per cent. better than that from which the green crops have been taken.

To obviate this should be the especial care of the farmer; and perhaps in no other county in England is the mean so well preserved. From the soil being variable, some fields upon every farm are not adapted to the cultivation of turnips, whilst, on the other hand, mangold-wurzel may be produced with less expense, and is more valuable both in the quantity and quality of the food; and as this root is much cultivated, it will not be out of place to allude to the system pursued in its cultivation before we proceed further. There are three varieties of this valuable root generally in use: the long red, having a long clear root, growing from 12 to 18 inches in length, of a pale red colour, and bright green leaves, with beautiful veins of red; another variety of red, similar in colour but of a globular form, tapering downwards and approaching near to the shape of a turnip, with leaves exactly similar to those of the long variety before described; a third variety is like the last in shape, but of a pale orange colour, with lighter coloured leaves, and orange coloured flesh. There is also a long variety of this colour; but from being less productive than the red varieties, it is not grown extensively.

In comparing the merits of the three varieties, much depends on the quality of the soil upon which it is grown; for upon the heavy clay lands, and in dry seasons, the long kind is by far the most productive variety, but upon lighter soils the globe succeeds best; and in the experiments made by the writer in several seasons, upon weighing the roots the proportion was as follows, and with very little variation as to the number of roots in the different seasons:—

	lbs.	lbs.	lbs.
90 roots of Long red upon the square perch in } rows 2 feet 4 inches apart.....	475	435	536
83 roots Globe red, ditto.....	435	400	375
92 roots Globe orange, ditto.....	375	330	436
Long orange, ditto.....	415	375	

These experiments were made, in successive years, upon good sound wheat land, with tenacious subsoil of strong loam lying upon chalk clay, well drained and manured; seasons moderately moist.

The process of cultivation pursued is, after the crop of wheat or barley is cleared, to plough up the land immediately, and give two or three deep ploughings and harrowings before the winter. The land is then put upon small ridges from 2 feet to 2 feet 6 inches wide; but the size usually adopted is such as to allow the cart-wheels to pass up two furrows without injuring the ridges. The land is suffered to lie in this state until the following spring, unless a suitable opportunity offers to carry on the manure in the winter months during frost, and afterwards plough it in. If this is not accomplished, and the weather permits, one ploughing or more is given in the spring before carting on the manure, unless the land should be in a sufficiently clean and pulverized state from the previous ploughings and harrowings given before the winter. The quantity of manure applied is about 18 loads, of 30 bushels each, of good compost that has been partially reduced, so as to be easily ploughed in. If the manure is not sufficiently decomposed, the roots do not succeed so well during drought, should it ensue in the following summer. After the manure is carefully spread in the bottom of the furrows, the land is ploughed, lightly rolled, and the seed\* either dibbled or drilled as soon after as can be, and again lightly rolled, unless the weather should be very moist, when it is considered best to leave the drills only lightly covered. In dibbling as well as drilling care should be taken not to deposit the seed more than one inch in depth, putting it in either with a small dibble, or by pressing it in with the thumb and fore finger alone, at a distance of one foot apart, and inserting from two to three seeds in each hole, and filling the holes by punching the soil in with the back of a hoe. From 3s. to 4s. per acre is paid for this, and if well performed, a plant may be almost insured.

The drill is, however, preferred as more expeditious and certain, especially in dry seasons; as, from the seeds being contained in a hard capsule, from three to five in number in each, and from being deposited thickly in the row by the drill, a plant is more certainly obtained, and the plant can be left more regularly, in a majority of cases, than when dibbled. Mice as well as wireworm are very destructive to the seed and young plants, and a larger proportion is therefore the more necessary to ensure success. The plants also grow more rapidly when they come thickly; therefore not less than 3 lbs. of seed should be deposited upon each acre, care being first taken to ascertain that the seed has not been previously destroyed by mice, which is sometimes the case, and which an inexperienced eye would not detect.

As the plants appear, the greatest attention should be paid to

---

\* The time of sowing is from the beginning of April to the middle of May.

keep them clear of annual and other weeds ; and as soon as they have reached from 2 to 3 inches in height, they should be singled out, leaving the largest plants at each place at distances of at least 1 foot apart. The ridges should then be well hoed, and the furrows horse-hoed, and at each repeated hoeing the earth should be drawn by the hoe from the roots, until, by the end of the summer, the ridges will have become level. Early in November the roots should be pulled and the leaves twisted off, care being taken not to leave them exposed to frost after pulling, as the portion extracted from the ground would, in the event of a single night's frost occurring, be so much injured as to rot after being collected.

The roots are either stored in outhouses or in buildings having thick external clay or brick walls, and thatched, or put into a row or clump about 8 feet in width, and brought up to a point, placing the crowns outwards (when finished similar to the roof of a house), about 5 feet high, and then covered with straw and earth, leaving the top open for some time to allow the heat arising from fermentation to escape.

I have been the more particular in describing the culture of this root as practised, from its importance as an article of food for cattle and sheep in the later spring months ; for, unlike every other vegetable at that period, it continues to improve in quality during the whole time it is kept, and is most in perfection in the months of April and May ; nor should it, if possible, be used before February, after vegetation has commenced, as, from that period, the root has a more beneficial effect upon the animals to whose use it is applied. The quantity grown is from 20 to 30 tons per acre ; the cost of cultivation may be estimated as follows :—

<i>Labour, &amp;c.</i>	<i>£.</i>	<i>s.</i>	<i>d.</i>
3 deep Ploughings, . . . . .	1	7	0
3 Harrowings, . . . . .	0	3	0
Making ridges, . . . . .	0	6	0
Carting and labour to manure, . . . . .	1	0	0
Manure, . . . . .	2	14	0
Ploughing ridges, . . . . .	0	6	0
Rolling, . . . . .	0	1	0
Drilling, . . . . .	0	3	0
Seed, . . . . .	0	4	0
Singling, 2s. 6d. and 4 hoeings, 15s., . . . . .	0	17	6
Pulling, carting, and stacking, . . . . .	0	15	0
	£7 16 6		

The rent and other charges bringing it very little under 10*l.* per acre.

The process pursued to obtain this root upon the heavy clay lands of best quality is not nearly so expensive. Upon a clean

wheat eddish, the manure, in a green or raw state, is carted on in October; the land is then ploughed once only, and in the spring is scarified, and the seed drilled, the same process as in the other case being afterwards pursued.

The system pursued to obtain swede turnips is carried out exactly the same upon the heavier soils, the ridge-culture being best adapted for that description of root. The ridges, however, are narrower, but the process of manuring, &c., is the same: the seed, from 2 to 3 pints per acre, is drilled from the first week in May to the middle of June; the more gravelly the soil the later the seed is put in. It is especially necessary that the seed should be deposited immediately upon the furrows being turned, and the moisture secured by a light roller. The latest sown turnips are almost invariably the best in quality; and, provided the land is in sufficient tilth and well manured, the first week in June is sufficiently early for sowing. The roots are pulled before Christmas, carted and stored, or are collected in heaps and consumed, wholly or in part, upon the land, either by fattening sheep in the winter, or by ewes and early lambs in the spring. The customary plan is to cart one moiety wherewith to feed stalled or other oxen, and to feed the remainder upon the land from troughs, after having been sliced, in addition to oil-cake, in quantity of from one half to one pound each per day, giving them the oil-cake in the morning with some cut chaff, or reserving a part for the night.

The cost of producing an acre of swede turnips will stand as follows:—

	£.	s.	d.
Four ploughings, . . . . .	1	16	0
Four harrowings, . . . . .	0	3	0
Once scarified, . . . . .	0	4	0
One ploughing for manure on ridges, . . . . .	0	6	0
Manuring as before, . . . . .	2	14	0
Labour on ditto, . . . . .	1	0	0
Ploughing on ridge, . . . . .	0	6	0
Ditto repeated, . . . . .	0	6	0
Hoeing twice, . . . . .	0	10	0
Pulling, . . . . .	0	6	0
Carting and storing, . . . . .	0	16	0
	<hr/>		
	£8	7	0

This appears a large sum; but the fallowing and cleaning apply to the crops through the three succeeding years, from the same field, to the growth of which the turnips also conduce in a material degree.

The system of drawing half, and feeding the remainder with corn or oil-cake, is decidedly the best management on this soil,

as a good crop is taken from the land, and the feeding the remainder is equivalent to a dressing of the best manure.

When, however, feeding is intended, the turnips are drilled upon the wide stetch, such being always the case upon light land; the sheep are not so liable to loss from being cast in the furrows, and the land retains the moisture better upon the latter system than upon the ridge-culture. The crops of turnips suffering severely in dry summers in this district, the utmost care is requisite to guard against drought.

White turnips are grown exclusively upon the light gravelly and sandy, as well as dry loamy land, and are sown from the 12th to the 25th of July. A finely pulverized soil is necessary, and manuring highly, to produce a crop. The hoeing taking place in the harvest month is more expensive, and seldom costs less than from 10s. to 12s. per acre. As many as eight ploughings are sometimes given before this crop is put in, and rarely less than six or seven. The whole crop is mostly consumed by cows and sheep; but from its liability to injury by frost, is precarious, and is generally grown as an auxiliary to other turnip crops; the produce from 500 to 800 bushels per acre.

The common drum head cabbage is grown for sheep, as also the thousand-head cabbage for spring feeding. These are mostly planted in large ridges manured with 20 loads per acre; from 6000 to 7000 plants per acre are transplanted in June, the cabbages weigh from 10 to 30 or even 36 lbs. each; the average weight may be taken at 12 or 15 lbs. each. The last-mentioned varieties are used during severe frost or snow, and are mostly consumed by the flocks and neat stock.

White carrots have been grown in limited quantities hitherto, but from the experiments made, are most abundant in produce, upwards of 30 tons having been produced to the acre; the cultivation however is exceedingly expensive, and the obtaining a plant very uncertain.

The new artificial manures have hitherto been used to a limited extent, nor has their introduction been attended with those results that were anticipated;—the soils of Essex are not so capable of deriving advantage from bone manure as those of Norfolk and Suffolk, and but little advantage has arisen from its application.

In the early part of this report, connected with the growth of root crops, the proportions of arable and grazing land were adverted to. The excess of root cultivation upon any farm is not attended with such profit, as when moderately carried out. Upon farms of 200 to 300 acres of arable, from 50 to 60 acres of fallow are made,—about one-half or 2-3rd parts of this is applied to the growth of root crops: by so doing, a better division of the labour takes place, as by growing tares, &c. The making the fallows

upon that portion is best effected in the latter part of the summer, whilst the fallowing for the early turnips requires the full force of the farm to prepare the soil for their reception ; and also as regards the manure, a portion can be reserved for the grain crops ; and the successful result of a well filled stack-yard is better secured by having some clean fallowed lands for barley, as well as by giving a better opportunity to eradicate couch or twitch grass, and other root-weeds, especially thistles, so prevalent in the soils of this county ; and whatever theorists may affirm to the contrary, it is impossible to farm land so profitably in any other way, as by devoting a portion to thorough-draining and fallowing in each summer : the land is invigorated by the continual exposure to the air, and will produce as much under this rotation as can be produced by any other mode, however expensively it may be carried out. The writer of this article has through many years made, as well as seen, repeated experiments to supersede fallows entirely with green crops, but believes it as impossible to succeed without them upon this soil, as for the animal powers to be kept always in full operation without sufficiency of time allowed for their renovation.

The subsoils of Essex perhaps are more prolific of root-weeds than those of many other counties, chalk excepted. The common thistle, the bind-weed, or, as it is termed, sheep-bine, a species of thistle, called gut-weed, and couch or quitch grass, exist in the subsoil to a degree, that it is absolutely necessary, for their eradication, that an exposure in summer, by repeated ploughings and scarifyings, should take place, and this can only be effectual in the early spring and summer months whilst vegetation is rapidly proceeding ; and although much may be effected in the autumnal months towards their eradication, it cannot be effectually performed after the grain crops are removed : the roots having at that period become hardened, and containing more woody fibre, and the sun daily losing power, the moisture is retained in a greater degree, so as to baffle the efforts of the farmer to eradicate them. The succession of grain crops, in alternate years, is of sufficient frequency to ensure success, and to allow the land to be kept up to its producing point ; and as upon lighter soils excellent crops of turnips can be obtained upon the fallowed land, equal in value to the inferior grain crops, no other system, I am convinced, can be adapted better to the cultivation of these descriptions of soil than that which is at present followed and is secured by conditions in most of our leases.

The expending of the turnips in many instances is imperfectly carried out ; and it is upon the larger occupations only that they are turned to the best account, either by sheep-feeding one portion upon the land with corn or oil-cake, or by consuming the remainder in yards with bullocks or cows.

Stall-feeding, however, is carried out upon the larger farms with great spirit, but unfortunately, of late, with little profit;—the great advance of price that has taken place in lean stock (especially that of a superior character), and the depression upon the meat markets, has so reduced the profits, as to have rendered it impossible for some time past to stall-feed oxen with any advantage to the grazier.

The system pursued is to purchase lean animals at the autumnal fairs in our neighbourhood; the Scotch and Welch varieties, Herefords and Durhams, are generally selected. Welch cattle are usually kept the first winter and spring upon a small quantity of turnips given in fold-yards with straw, are then fed upon grass, and finished with turnips in the early part of the ensuing winter. The Scots, especially the polled galloways, are either stall-fed in houses or in yards; and, with proper management, are fattened in about four months. The turnips are mostly sliced, and about 3 bushels of swede or 4 bushels of white turnips, with the addition of 5 lbs. of oil-cake per day; and during the latter portion of the time the oil-cake is increased to 7 or 8 lbs. to animals weighing from 80 to 100 stones of 8lbs. And the cost of bullocks of this description has varied from 10*l.* to 12*l.* each, which have been sold out at from 15*l.* to 20*l.* each. The usual calculation was for the bullock to double its value, and then it was considered fairly to repay the expense and trouble taken to produce it. The Hereford variety is much appreciated, especially heifers, which are purchased forward in calf, which having fattened, they are then put forward themselves, and are frequently sold within the year.

As Essex is not a breeding county, it may be expected that every variety of stock should be found in it, which is really the case; the smaller farmers generally keep the inferior varieties, consisting for the most part of the Welch or Irish breeds. The Highland varieties are grazed upon the marshes the first year, and are mostly finished off in the second with turnips, or mangold-wurzel and oil-cake. The Galloway Scots, Shorthorns and Herefords are stall-fed the first winter.

Cows of every description are kept, but short horns have only lately been introduced on the best pastures. Suffolk polled cows are greatly approved, and the North and South Wales varieties, upon the farms of inferior or heavy quality of land. The produce of a cow is estimated at about 8*l.* per annum for suckling calves, and 12*l.* for dairying.

Labourers are plentiful throughout this district; and as the harvest commences earlier than in the north-western district, harvestmen proceed from thence and assist in this division for a week

or fortnight, so that it is not unusual for farmers who have capital at command to reap all their wheat crop in the first week of harvest. Although reaping has been the general practice, it has of late given way to mowing with a common scythe cutting towards the standing corn, not only on account of the increased quantity of straw obtained, but also from the land being left clean for the cultivation of the succeeding crop, without the necessity and expense of first cutting and carrying the stubble. Little fagging or bagging, as it is here termed, is performed except in the vicinity of the metropolis, where it is practised with some success.

The ricks are mostly made square or oblong, and are placed upon frames with stones or iron piers and caps; but little skill is displayed in the setting them up, and the neatness of the ricks in other counties puts those of Essex in the background. The price of reaping varies according to circumstances; the average may be taken at 8s. per acre, with one gallon of ale and one of table beer in addition. Harvest work is done either by the month or at so much per acre; allowing each man from ten to twelve acres, the amount given in money varies from 9s. to 11s. per acre, producing 5*l.* as the compensation; the labourers receiving, in addition, eight pints of ale, or six pints of strong beer, and four of table beer per day. In some cases malt is given to the amount of three bushels, and 4*lbs.* of hops to each man, with the use of brewing utensils and casks, and from one to two meals, exclusive of the horkey or harvest-home supper, during the month.

If the weather proves fine, the labour is mostly performed within the month; but sometimes wet weather protracts the harvest, to the great injury of the labourer as well as of his employer.

Oats are generally mown, and if stout are placed in bands, and suffered to lie exposed for a day or two without binding; they are then bound, and mostly put upon stacks to prevent the liability of their being heated; but more generally they are suffered to lie in swarth until ready for carting. A general error in management is prevalent as regards this crop, which is frequently suffered to remain so long as to allow the best portion of the grain to shed, to the extent sometimes of six bushels per acre. Oats should always be cut before they are quite ripe; the straw is improved thereby so as to become nearly as valuable as hay; and the late oats, if left by the thrashers adhering to the straw, usually come into account when properly applied to the feeding of stock or cutting into chaff: the average produce may be taken at 6 quarters per acre. The black tartarian are considered the most prolific, and are more generally grown than any other variety; the straw, however, is



inferior to that of any other kind ; all the varieties of white oats are also grown with success, of which the Dutch brew is considered the most productive.

Barley is invariably mown, and in wet weather is much exposed ; it is, however, considered best not to turn over the swarths, but merely to lift them lightly, and to leave them upon what is termed the outing, made at the commencement of the preceding swarth by the mower putting his scythe in a sloping direction downwards, leaving the stubble higher, which prevents the barley from coming into contact with the earth, so that it is thus not so easily sprouted. The average crop of barley in this district may be taken at 5 quarters per acre ; for although here and there a piece may be found producing in good seasons from 7 to 8 quarters per acre, this is not of frequent occurrence.

Beans are grown on the heaviest descriptions of soil. They are an excellent preparatory crop for wheat ; and Essex is notorious for their excellent culture, as such is the nicety pursued in hoeing them that, where well managed, scarcely a weed can be found after the last hoeing is given. The seed is either drilled or dibbled, the latter effected by the man using two dibbles, and walking backwards with children following to deposit two beans in each hole. Sometimes, but not frequently, they are dibbled by a single dibble, the man dropping the seed as he proceeds.

Dibbling with two dibbles can be done at a lower sum per acre than by any other mode ; from 4s. to 5s. per acre is the usual price, and with a single dibble 4s. are paid ; but they are not so thickly deposited, neither are the rows so near together. The drill is very frequently used, and for small-sized beans as well as peas is an admirable implement, but hardly ever succeeds so well as dibbling well carried out. This crop may be taken at from 3 to 5 quarters per acre ; but upon heavier and more tenacious soils double that quantity is frequently grown.

The cost of cultivation of the bean crop may be taken as follows :—

	£.	s.	d.
Dibbling . . . . .	0	4	6
One ploughing and harrowing . . . . .	0	11	3
Three clean hoeings . . . . .	0	12	0
Reaping . . . . .	0	8	6
Carting . . . . .	0	2	6
Thrashing 4 quarters . . . . .	0	7	0
Marketing and carting out . . . . .	0	6	0
Seed, 3 bushels . . . . .	0	11	0
	<hr/>		
	£3	2	9
	<hr/>		

As a preparation for wheat no other crop is considered so beneficial excepting clover.

Peas, grey, white, and blue, are extensively grown; they are mostly drilled after the barley crop, and thus become, like beans, the intervening crop between the barley and wheat crops. They are usually drilled in rows 9 inches apart, with about 3 bushels of seed to the acre, and are generally hoed twice, at an expense of 6s. per acre. The produce is uncertain, but in good seasons will be from 4 to 6 quarters per acre. The former quantity may be taken as a full average crop. The expenses will stand as follows:—

	£.	s.	d.
One ploughing . . . . .	0	9	0
Three harrowings . . . . .	0	2	3
One rolling . . . . .	0	1	0
Harrowing . . . . .	0	0	6
Hoeing . . . . .	0	4	0
Ditto . . . . .	0	2	0
Cutting and harvesting . . . . .	0	9	0
Thrashing and marketing . . . . .	0	12	0
Seed . . . . .	0	12	0
	<hr/>		
	£2	11	9
	<hr/>		

Garden peas are extensively grown for the London seedsmen, who find the seed, and pay from 40s. to 50s. per quarter for the produce (1844), after again deducting their seed. This is a very precarious mode of cropping, as the peas so grown are frequently a delicate or dwarf variety, and are consequently more hazardous to obtain a full plant than of the grey peas or other long-straw varieties; and also suffer the weeds to rise amidst the crop, thereby injuring the land to an extent that frequently overbalances the difference obtained in price.

The wheat crop may be variously stated; but, taking a succession of years, 30 bushels per acre may be considered an average crop.

The wheat-plant is mostly hoed by hand, at an expense of 4s. per acre, in March and early in April. The cost of harvesting is about 10s. 6d. per acre, which, with the ale, amounts to 1s. 6d. more; thrashing by hand from 2s. 6d. to 3s. 6d. per quarter; and the straw binding of 36 trusses to the load, and 36 lbs. to the truss, for market, 1s. to 1s. 6d. per load.

Clover seed, both Dutch and red, as well as trefoil, are grown in this district with success. The quantity of the former may be taken at from 3 to 5 bushels to the acre as an average crop, and of the latter from 6 to 7 bushels per acre. Wheat generally succeeds it, but not so well as when the clover is mown for hay,

the late period of sowing giving opportunity to the slug, which frequently destroys the plant of wheat altogether.

The poor, highway, and church rates average about 5*s.* per acre; the tithe rent-charge about 6*s.* per acre, and the wages of agricultural labourers from 10*s.* to 12*s.* per week.

Thatching is paid for by the square of 100 feet, upon buildings from 4*s.* 6*d.* to 5*s.* are charged for labour only requiring about 20 trusses to the square.

The labourers pay high rents for cottages; from 3*l.* 10*s.* to 5*l.* per annum are paid, and even more in the vicinity of large towns, without the advantage of gardens, and sometimes with insufficiency of room. Excellent cottages, however, are common throughout this district, and are built chiefly of brick, or lath and plaster, containing three or four rooms of about 10 or 12 feet square.

The quantity of waste land is limited, but is good in quality, might be easily brought into cultivation, and would be of especial benefit if enclosed and cultivated.

Upon the whole the north-eastern part of Essex may challenge competition with the best farmed districts in the kingdom; and although great variation of soil takes place upon every farm, the farmer turns this to advantage by producing crops suited to all his purposes. He has ground adapted to the growth of turnips, mangold-wurzel, cabbages, tares, grasses, lucerne, and every description of grain upon the same farm.

The farm-houses and buildings are for the most part substantial, and ornamented with neat gardens and choice evergreens tastefully planted and maintained, and upon some estates a great outlay has taken place in this respect. Buildings in brick and slated throughout in the most substantial manner, have been erected at an expense beyond the mere capabilities of the estate to repay. The estates of the late Dr. Cline, Lord Petre, Sir Henry Smith, and others, have excellent specimens of buildings in the modern style; whilst numerous instances are to be found of buildings of older date improved so as to render them everything a tenant requires or could even wish for.

The buildings are mostly situated adjoining to excellent roads, and much care has been taken from time to time to make the farms upon large estates complete by an exchange of lands. The proportion of pasture is, however, small; but excellent artificial pasturage is produced for one or two years, and, so far, is more productive than the old grass lands; but after that period it becomes of little value for several years, until at last the natural grasses have arisen and become fully established. The seed usually applied is the Pacey and Italian rye-grass, mixed with white and red clover and trefoil, and in some cases sheep-plantain.

The Italian rye-grass is of modern introduction, but such are its qualifications and superiority over common rye-grass, that it bids fair to supersede it altogether upon the better descriptions of soil. All other varieties of rye-grass remain inactive, from the time of the first feeding or mowing, until the succeeding autumn; but the Italian rye-grass is not only much earlier, more productive, and better liked by the cattle, but it shoots quickly after being fed or mown, and advances so rapidly that two crops of seed can be taken in the same summer, or it can be fed until the middle of May, and a crop of hay or seed be afterwards taken. Inoculation by turf to procure permanent pasture has been practised with the utmost success; and when turf can be obtained is decidedly the least expensive mode (taking the immediate advantages into consideration): the remote benefit is beyond all comparison, as pasture is at once obtained equal to the old pastures in the district. The operation is simple, and the mode of producing it so easily understood, that a little explanation will enable any one readily to effect it. The land selected is usually that which has been previously fallowed and manured, and from which swede turnips or mangold-wurzel have been taken, the time selected being early in November. The land, being first reduced to a level and well-pulverized surface, is ploughed as the work proceeds by what is termed back-striking, so as to enable the work to proceed without carting upon the late-ploughed soil. Turf that has been taken up by a plough from a good pasture of similar quality, cut into small pieces about 1 inch square, is then deposited at equal distances, leaving a space about 3 inches apart from centre to centre. This is either stamped down with the heel or with a rammer; and, when all is disposed, is rolled with a heavy roller, and the work is complete. Some persons sow grass-seeds and clover in the following spring; but it is considered by those most experienced not advisable. The turf of itself will spread better if no intervening grass is present, and will, if properly carried out, at once form a permanent pasture. Some, however, dibble in wheat or oats; and sufficient may be grown to defray the whole expense; but it is questionable if the grass will proceed so well; it is, however, but fair to state that this has been the practice of the writer, and with the fullest success. The pasture from whence the turf is taken will be but little injured if a light covering of earth mixed with lime or dung be spread, and harrowed across so as to fill the interstices from which the turf has been carted, which consist of long stripes about  $2\frac{1}{2}$  inches wide, and from 2 to 3 inches in depth. Mr. Wedlake, of Hornchurch (the late spirited inventor and improver of agricultural implements), invented a complete apparatus, consisting of a plough and machine for cutting the turf into small pieces, so as to cover more space.

These implements are still manufactured by his widow, of whom they may be obtained. The cost of inoculation may be taken at from 40s. to 50s. per acre, which must depend upon the distance of carting the turf, &c.

The rent of land in this district varies from 20s. to 30s. per acre; in the vicinity of London and near towns it is far above that amount. The rich marshes by Plaistow let from 4l. to 5l. per acre, and the arable land from 2l. to 3l.; but, as the object of this essay is rather to generalize than to particularize, the rent may be taken at 25s. average upon such lands as are adapted solely to farming purposes. The tithe is for the most part commuted into rent-charge,\* and varies from 5s. 6d. to 6s. 6d. per acre, and rather falls below than exceeds that sum. The tithe compositions from 5s. to 6s. per acre. Poor rates 3s. 6d.; surveyor's rate 10d.; and church rates 2d.: making 4s. 6d. per acre altogether, inclusive of the county and police rates, which are invariably paid from the poor rate. The new poor law has effected a decrease of poor rate equivalent to about 15 per cent. in some parishes, whilst in other parishes, especially those situated in populous districts, it has increased; but, upon the whole, the working of the bill has been beneficial upon the labourers, in producing more order and regularity, and by generally improving their habits; and from having become more independent of parish assistance they are generally more assiduous and attentive to the interests of their employers.

Field cultivation is but little carried on in this district by women; during the summer months they are engaged in hoeing and weeding; in some particular instances they are employed in drawing turnips in the autumn, and in potato planting in the spring. The usual amount of their wages is from 6d. to 8d. per day, for which they work about as many hours; but when sufficient men can be obtained, their employment is limited, except in the vicinity of London, upon the garden lands.

### *Third, or Heavy Clay District.*

I now proceed to treat of the third division of the county, comprising the Dengey Hundred district, as well as all the heavy clay lands lying towards the south-east, resting upon a subsoil consisting of London clay, exceedingly retentive of moisture, and of expensive cultivation, but, under proper management, producing excellent crops of wheat, beans, and oats.

This land is farmed, for the most part, upon the six-course shift of husbandry, except upon the poorer descriptions; there the four-course, as before described, is adhered to; the only difference in the mode being, that, after the wheat crop has been

---

\* By a recent examination of twenty parishes, the average rent-charge is found to be a little below 6s. per acre.

taken, it is succeeded by beans, which are thoroughly hoed and cleaned, and again sown with wheat. The rotation will be better understood by describing it throughout :—

1st. Fallow.	4th. Wheat.
2nd. Oats.	5th. Beans.
3rd. Clover.	6th. Wheat.

Barley is sometimes grown upon the best and driest lands, and, since the introduction of chalk largely into the soils, with good success.

The first and leading principle in the cultivation of this land is carried on by the application of chalk.\* This, in every instance, upon the first application, effects an astonishing change in the soil, enabling it to produce valuable crops for many years afterwards, without the assistance of any additional manure; but as nearly all the land has been already chalked over, it is now applied as an adjunct to other manures, and to render the land porous, and less tenacious; and from the facility with which it can be obtained by water-carriage, is, either as chalk or lime, in constant application upon all well-cultivated farms.

The expense of cultivating this description of land is very great. Three powerful horses are used for several of the first ploughings upon the fallows, and frequently upon land for corn crops. The horses are large and fine, yet two of them, with much extra food, are still unable to effect more ploughing, upon the average, than three-fourths of an acre per day. The horses require the best description of food to enable them to perform their work; and as much as 3 bushels of oats and beans are allowed weekly, with good cut clover hay; and taking the limited quantity of work performed, with the extra cost of horses and keep, into consideration, the expense of horse labour is increased fully one-third over that of any of the other districts.

The fallows are attended with immense expense, having frequently eight clean ploughings, and in no case less than six, some of which are effected with three horses, and are ploughed to a depth of five or six inches. The estimated value of the ploughings is not less than from 10s. to 12s. each per acre, with scarifying or crab-harrowing with four horses between the ploughings, besides a great deal of cross-ploughing, each time, to the numerous water-

---

\* The chalk is carried at from one to four or five miles' distance from the water. About fifteen cart-loads are considered a full dressing per acre. Each load, containing 40 bushels, costs 6s. at the wharf: and for carting one mile costs 3s. 6d.; two miles, 5s.; three miles, 6s.: and so on, for any greater distance. But the expense precludes its being used at more than five or six miles from the water: at a greater distance lime is substituted, at the rate of two waggon-loads per acre; each load costs 32s. at the kiln.

furrows, which average from 20 to 40 perches per acre, and are dug out with a spade at a cost of 10*d.* to 1*s.* per score rods, whenever the land is sown with wheat; and the stetch-furrows, at a distance of every 7 feet, are also ploughed out deeply after the corn is sown, so as to effect a ready passage to the water from the surface, as it has been found difficult to render land of this description dry by under-draining, on two accounts: one of which is, that the land is so tenacious that it is impervious to the water unless the drains are made with cockle-shells or shingle, with or without drain-tiles or pipes below the shells; the other is, that the soil, in dry summers, shrinks to such a degree as to form wide fissures or cracks from 2 to 3 feet in depth, and thus destroys the drains altogether. The system, as pursued by surface-draining, apparently fully effects its object, as excellent crops are produced, unequalled by any others in the county.

The prevalence of couch or twitch grass in these lands renders it difficult to farm them without clean fallows at least once in six years, as it is impossible to eradicate it by short fallows, since it extends to such a depth in the subsoil as to require very deep ploughing to reach it, which deep ploughings would not be necessary for the crop alone. It is customary of late to drill the land that has lain through the winter exposed to the pulverizing effects of the frost without an additional ploughing, by first scaring the surface, and then drilling in the barley or oats, for which operation a scarifier peculiar to the district is used, that is admirably adapted to the purpose. The lands scarified are considered to resist weather better, as well as drought, should it follow; and the crops are decidedly superior than from ploughing, without entailing that expensive operation upon the occupier.

Clover generally succeeds well if plants can be obtained, but the difficulty in that respect is even greater on this land than upon others in the county, and has of late rendered the returns from the wheat crop considerably less on that account.

The wheat grown in this district is of excellent quality, and with genial seasons very productive; but the uncertainty of a full plant, either from prevalence of black grass, or the destructive effects produced by the slug, in a great measure counterbalances its productiveness. From 1826 to 1832 the slug had been so destructive that a vast proportion of the tenants were ruined, and many of the farms fell into the landlords' hands. From 1832 to 1842 a succession of good seasons followed, but the crop of the latter year was almost destroyed by the wet seed-time and winter, and some farmers barely obtained a return of their seed. I mention this to show the precarious nature of these lands, although they do in some seasons produce from 40 to 50 bushels per acre,

under favourable circumstances. The average growth, however, cannot, in my opinion, be taken higher than 34 bushels per acre. The variety of wheat grown is the white velvet, or rough chaff, which is especially adapted to the soil. Red Syer and the golden drop, as well as all the varieties of white wheat, are grown with success, but the rough chaff forms the principal growth. It is not long, but stiff in straw, and is not easily lodged; and the quality is superior to that of any other description, and invariably produces (with the exception of Talavera wheat) the best price in the market, frequently weighing 66 lbs. per bushel.

The bean crop is a most important one in this district, and perhaps in no other part of the kingdom are such fine crops produced. The management is also excellent. The beans, for the most part, are dibbled by a man with a single short dibble, so as to enable him to make the hole and deposit the beans (two in each hole) as he proceeds, following the plough as each furrow is ploughed; three men thus completing the work of one plough every day. As soon as the beans are well above-ground, they are harrowed, and afterwards well hoed. Two more hoeings, at proper intervals, mostly complete the operation. This is done at a cost of about 12s. per acre. The beans are cut in harvest, and tied with yarn tyers or straw bands, and frequently yield from 7 to 8 and even 10 quarters per acre. The average will perhaps fall rather below  $5\frac{1}{2}$  quarters per acre than exceed that quantity, as the seasons affect this crop almost equally with wheat. Horse-hoeing is partly applied, and in some cases successfully, but it is considered with little reduction of expense.

Oats come next under consideration, which are, in congenial seasons, very productive. From 7 to 10 quarters, and even more, per acre are frequently grown. The average, however, cannot be taken at above 7 quarters, and this upon the fallowed lands. Barley is grown in limited quantity, but abundant crops are sometimes produced upon the fresh chalked lands, being also of excellent quality. The usual proportions of tares and some peas are produced; but as beans supersede the latter they do not come under especial notice. Upon the lighter soils, however, excellent crops are produced.

The crops peculiar to this district are white and brown mustard, coriander, canary, and caraway, of which notice will be taken separately. Mangold-wurzel has of late been introduced, and very fine crops are obtained.

White mustard is sown broad-cast as early in the spring as it can safely be, so as to prevent injury from frost, and is generally sown upon land in clean order, and having abundance of tilth; one hoeing is given, and but little is afterwards required in its



cultivation. The annual weeds and surplus plants are hoed out, and the crop is cut and harvested in the field, the produce being from 30 to 40 bushels per acre.

The brown mustard, once so prevalent in these districts, is mostly prohibited being sown by the covenants of leases; for if once sown it becomes a fixed tenant, and further impoverishes the soil; and whatever the succeeding crop may be, it usurps a dominion—sometimes to such an extent that the bean crop has been sacrificed to its prolific growth. Upon first broken-up land it is still attempted, the first crop frequently nearly realising the fee-simple value of the land upon which it is sown. As it is almost prohibited from cultivation, it will be needless to advert to it further.

Coriander and caraway are grown extensively in this district. The mode of cultivation being particular, it will be remarked upon, especially as the cultivation of coriander, in connexion with caraway and teasel, is rather singular, and merits notice. It was formerly the plan to sow a treble crop, of which teasel formed one, and was harvested in the second year; but since the introduction of a substitute by machinery has taken place in the woollen manufacture, its use has been much dispensed with, and it has consequently not of late been introduced into Essex cultivation. About the beginning of the month of March the seeds of the coriander and caraway are sown in the proportions of from 10 to 12 lbs. of the former to 12 or 14 lbs. of the latter—the land being previously well harrowed, and the seed afterwards well harrowed in; and here some difficulty presents itself in the management. The caraway-seed is very much smaller than that of the coriander, and as the practice is sometimes to sow before well harrowing, it then becomes deposited too deeply; but should the land be, on the other hand, in very full tilth, by sowing *after* well harrowing, the coriander-seed may not be sufficiently covered by the harrowing; and it is therefore suggested that the coriander-seed should be first sown after harrowing, and the caraway drilled after the process of harrowing has been partly carried on. In about eight or ten weeks the plants will be strong enough for hoeing, which it is important to complete as soon as possible. They will require about four hoeings, one of which is given at Michaelmas, and cost, with harvesting, about 50s. per acre. As it is necessary this work should be carried out by workmen who well understand it, they are therefore better paid than men in ordinary cases: besides, it requires especial care, and occupies much time to execute the work properly. Workmen are to be found who undertake the labour and divide the profits with the farmer, allowing him the rent as a deduction; and he, upon the other hand, finding horses to perform what work is necessary. Perhaps no crop is more variable

in price and quantity than this, varying as it does from 7 to 20 cwt. per acre, but from 10 to 12 cwt. is considered a good crop. The coriander is also equally productive and precarious, varying from 6 to 20 cwt. per acre, and prices ranging about in the same proportions. It is therefore not surprising that some individuals have realised their fortunes by the cultivation of crops of this character. In the harvesting, great care is requisite to prevent the seed shedding in the field. To remedy this, cloths are used to receive and convey it to the thrashing-place, which is always in the field. The crop is liable to injury from late frost and caterpillar, and is therefore very precarious.

Canary is also much grown in this district. It is sown in April, and produces about the same quantity per acre as wheat. The thrashing is expensive, but the straw and chaff are much approved of for horses and cattle. The price is exceedingly capricious, varying from 40s. to 80s. per quarter. Canary is usually sown in the place of barley or oats, and is considered to pay, upon an average, from 1*l.* to 2*l.* per acre more than either of those crops.

The islands of Essex, upon the south-eastern coast, being composed of rich and deep alluvial soil, as well as portions of Rochford Hundred, are well adapted to the growth of the last-mentioned crops, as well as of every other kind of grain.

That portion of the county comprising Rochford Hundred is reputed the most fertile; but to it unfortunately, as well as to Dengey Hundred, a prevailing idea is attached of an unhealthy character—a considerable breadth of marsh prevailing throughout the whole district. Ague at one period ravaged it; but such has been the effect of cultivation and drainage, added to an abundant supply of water by what are termed artesian wells, that this portion of the county has of late become almost as healthy as other parts on higher elevations. The supply of water, by means of the wells alluded to, is obtained by merely boring through the tenacious London clay from 100 to 300 feet, until the chalk stratum is tapped. Pipes are introduced as the work proceeds, and the water immediately rises to the surface, and continues to flow—giving a supply not only to the homestalls of farm premises, but, by keeping it up in the marshes during summer, contributing a benefit to the grazier of incalculable amount, and has in a great degree rendered that portion of the county healthy.

The woodlands are extensive, but the produce has materially fallen in value during the last twenty years. The introduction of foreign timber in buildings, and of iron and network for folding sheep, has diminished the demand for poles. The supply of coal by water-carriage has also so much reduced the produce in value that unless an abundance of timber prevails few woods afford a rental exceeding 8s. per acre, whilst the greater part do not yield

half that amount; and as the tithe commutation has now fixed the sum to be paid, it is presumed a large proportion will be grubbed in a short space of time.

One great drawback to cultivation arises from the small enclosures, added to the great number of timber-trees and pollards in the hedgerows. In small enclosures, under 5 acres, the deterioration that ensues to the crop is very great; the shelter afforded to birds and vermin, and the injury caused by the trees excluding the sun and air, and the roots extracting the nutriment and moisture, in many cases depreciating the produce from 10 to 20 per cent.

The roads being well maintained, give facility to improvements not found in many other counties, which the navigation also further enhances. These advantages have been made available by the spirited manner in which cultivation is carried out; and in many divisions it is not excelled, if equalled, by any other part of the kingdom; and, considering that leases are not general, it exhibits a confidence between landlord and tenant highly commendable. The proportion of farms under lease is below a moiety. These are held, for the most part, on terms of fourteen years.

The wages of labourers differ considerably in various districts, being fully one-third higher in those districts near London and towards the sea-coast. Those in the first described portion of the county vary from 8s. to 9s. per week; in the last described, the prevailing amount paid is 10s. to 12s., with wheat averaging 50s. The workmen are expert, particularly the ploughmen, who may fairly challenge any other county in the kingdom. The ploughs used are nearly all swing-ploughs, with cast-iron breasts and shares, and of various shapes, adapted to the nature of the soil, and worked by two horses abreast.

In conclusion, the soil of this county may be considered, for the most part, fertile, and with good cultivation yields excellent crops. The average of the wheat crop may be assumed at 28 bushels per acre, barley at 36, oats at 40, beans at 32, and peas at 28. It is impossible, where so much variety of soil exists, to state with precision, but the above may be taken as a fair criterion.

---

#### APPENDIX.

THE system of farming in this county, as well as in others, is varied according to the opinion of the cultivators; and without contending for the superiority of any system, I will state the course of cultivation pursued by Mr. King Viall upon several farms lying upon the borders of this and the neighbouring county of Suffolk. The land consists of three varieties of soil, being for the most part heavy land, as it is called in that district—a term, by the bye, that conveys no distinct idea of the

quality of a soil, being rather adapted to distinguish land which consists mostly of clay from that which consists of gravel or sand. This portion of the farm consists of a chalky clay subsoil, having a considerable quantity of marl intermixed, with a tolerably deep staple of vegetable mould (combined with the clay) lying upon the surface, and is of that description of soil described in the first part of this essay. A second portion lying between the above-described land and the river is clay mixed with alluvial deposit, and loam and gravel prevailing more or less as a subsoil, of which the surface in some degree partakes, having a deeper staple than the first described portion of the farm, it is adapted to the growth of Swede turnips and mangold-wurzel. The remainder of the farm, in the proportion of about 10 acres to each hundred of arable, consists of meadow-ground liable to be flooded during winter, and some small enclosures of pasture adjoining the premises, which are situated nearly central to the farm, a hard road running through and dividing the strong clay-land from the turnip-land and belt of meadow-ground.

The system pursued is an expensive one, and requires great activity and experience to carry it out effectually, as in addition to the management of the land, a competent knowledge of the purchase and sale of sheep and cattle is involved, which is rarely combined with superior knowledge of cultivation in one individual. The land is all adapted to the growth of wheat, beans, barley, and oats, which are the crops produced in fair proportions in each year, every part of the farm being in crop at the same time.

To commence with the turnip-soil (or the last-described portion of the farm), the land is ploughed up as early as possible in the autumn, and receives one, two, or more ploughings, as opportunity offers. In the early part of the winter such portions as require draining are thoroughly drained with pipes of two inches' bore, having the opening heart-shaped—the widest part of which is placed downwards—upon the top of which stone is placed to about 3 inches in depth, consisting principally of small flints and pebbles, picked from the surface of the land; as soon as the land is sufficiently dry it receives two deep cross-ploughings early in the spring, is rolled and harrowed until a fine tilth is produced, and is then formed into ridges, or small stetches, 37 inches each in width, which is thus effected:—A straight furrow is first ploughed, and a double-breasted plough is then used, having a marking instrument attached, which consists of a small straight tough pole fixed at right angles from the beam of the plough by means of a hook, and placed as far back as possible, so that it does not derange the operation of the plough whilst working; at the end of this stick an iron is fixed exactly the width of two of the intended ridges, which is connected diagonally by a chain with the whipple-tree of the horse; this, as the plough proceeds, marks out the next furrow, occupying the space of two ridges. The work thus proceeds followed by a similar plough, or by the ploughman returning, who by passing his plough down the middle of this space divides the stetch of 6 feet 2 inches into two smaller ones of 37 inches each, the marker still defining the distance at which the plough should be held; the ridges being formed, are ploughed off with four furrows to each, and then every fifth ridge is

drawn out to enable the manure to be carted on without injuring the form of the ridge. After the manure is carted on, at the rate of 16 loads of 40 bushels each, the ridges are then ploughed by four furrows, leaving a small baulk in the centre so as to divide the ridge into two spaces for the manure, which from being partially decomposed is easily spread in this double furrow; the land is then ploughed at four furrows to each ridge, and the manure being covered in, is rolled and harrowed, and is again rolled with a light roller. The turnips are then drilled—two rows upon each ridge 11 inches apart, at the rate of 4 pints to the acre, thus standing at alternate spaces of 11 inches and 26 inches between the rows. As soon as the turnips appear, they are singled out by boys and women at 15 inches apart, and are left standing diagonally with each other; they are then carefully and deeply hoed with a heavy hoe, and the furrows are kept clean with the horse-hoe, but the turnips are invariably set out by hand and never by the hoe, the deep hoeing that is given being considered a main point in the system over and above that pursued with the common light turnip-hoe: and the singling by hand is assisted by a small measured stick 15 inches in length, enabling the children employed to set the turnips out regularly and diagonally, so that when finished they stand thus . . . . .

In the months of November and December the turnips are all pulled, avoiding the use of hooks or cutting instruments for trimming them, merely wringing off the tops and dislodging the greater portion of the earth attached to the fibres without cutting them. The turnips are then carted to the respective fields where they will be required for winter use, and one moiety of them is left in the field for using there; those left are put into heaps of about 40 bushels each, are thatched over with straw, and the earth shovelled up and placed round the heaps to the top, which ends in a point. Those taken from the field are carted to the headlands of other fields where they will be required, which are principally those upon which wheat was grown in the preceding year after clover. The old hurdles used for folding are then selected for this purpose; one is placed first at the end across the space to be occupied by the turnips, and two more are put at right angles, forming a space made by the double row of hurdles, in which the turnips are placed, taking care to cart them when dry, and adding more hurdles lengthwise until sufficient space is obtained, and the turnips are disposed of in rows about 7 feet wide and 4 feet in height. The turnips are then protected by the earth being dug up and placed on both sides, leaving air-holes at about 4 or 5 feet distance, level with the surface of the land, which may be formed as the work proceeds by introducing small faggots tied loosely, or by any other mode, leaving the sides of the whole open so as freely to admit air, and extending across from side to side, which is of especial importance towards the preservation of the turnips, as they might otherwise get into active fermentation, which when it takes place frequently destroys the greater part of them. The top of the heap is then covered with barley-straw and thatched, and thus the turnips are preserved from injury by frost and game during the most severe weather, and will remain in excellent condition until May following, very little impaired by keeping. The application of them is by feeding them

upon the eddishes, and upon the land upon which they are grown by sheep in fold. The turnips are all sliced, and the sheep are regularly fed in troughs, having a new fold every day, and with from  $\frac{1}{2}$  lb. to 1 lb. each of oil-cake per day. The sheep, for the most part, consist of lambs of the last year, and cost from 16*s.* to 20*s.* each—these in the following spring are shorn and sent to market, and produce from 30*s.* to 32*s.* each; the fleeces from the half-bred Leicesters weighing each about 6 $\frac{1}{2}$  lbs., and selling from 12*d.* to 16*d.* per lb.

Mangold-wurzel is grown upon the clay-land; the method of cultivating, elsewhere adverted to, (with one exception, that of growing upon 3-foot ridges) is carried out upon this farm, and the roots are used in conjunction with the turnips in the manner above stated, being all sliced and fed in troughs, and the quantity increased as the season advances, and the turnips become diminished. It is by this management that the land is maintained in a condition to produce crops without clear summer fallowing, and the hoeing becomes thus an important item in the farm management and expenditure, which, from being well carried out upon this farm, I shall advert to particularly. Gangs of boys from ten to fifteen years of age are constantly employed, at wages from 4*d.* to 8*d.* each per day; with every ten or more boys a man is placed, who is made responsible for their properly executing the work, and also for their application. Narrow hoes are used in preference to wide ones. The wheat, beans, and peas first receive attention, and are all thoroughly hoed and weeded at a cost of about 3*s.* to 4*s.* per acre; the boys also dibble in the mangold-seed, and single the plants of both that and the turnips ready for the hoe, weed all the Lent corn, each being furnished with a glove, and then assist in making the hay, shaking it out with their hands without using forks; the smallest are then released for the month of harvest to follow gleaning, and the largest are all kept to various work, such as hoeing and cleaning the turnips, and assisting in the harvest-work as required, but always accompanied by the man. As the season advances, the pulling and carting of the turnips again occupies them, and it is only during the depth of winter that the smallest are not employed. Frequently two or three gangs of from ten to fifteen in each gang are at work; the light hoeing is thus executed at a less cost than could be effected by men, and the boys are at the same time taught early to work and to become industrious. The system pursued as regards the corn-crops is as follows:—The land from which the turnips were taken, after having been folded with sheep, is immediately ploughed, provided the weather is dry enough, and remains until the following spring, when it is scarified and drilled with barley. The eddishes to which the turnips have been carted are also folded over with sheep, and are ploughed early and drilled with oats. The land sown with barley is also sown with clover-seed by a machine of peculiar construction, but admirably adapted. In the following year the land that had been in oats is ploughed two or three times in the autumn, and formed into 3-foot ridges, as before described for turnips, manured, and drilled with beans, three rows upon each ridge; these are well hoed during the summer. The clover succeeding the barley is reserved for hay, or fed until the middle of May, and both white and red varieties

are then carefully weeded, rolled, and left for seed. The land in beans is in the next year drilled with wheat or barley, and that in clover is drilled with wheat. In the fourth year that portion of the wheat succeeding the clover is folded upon again with turnips as before, and in the succeeding year is sown again with oats; and that portion succeeding the beans is fallowed, and sown with mangold wurzel and Swede turnips. Thus a continual system of labour is kept up, occupying at the rate of six men to each 100 acres, with boys in addition at the rate of two men more: excellent crops are thus produced, the wheat averaging upwards of 4 quarters, the beans upwards of 5 quarters, the barley 6 quarters, and the oats 7 to 8 quarters per acre. The produce of the clover in seed also forms an important item in the returns, and gives a vast deal of employment in the winter-months; it is about 4 bushels of red and 6 bushels of white clover per acre. The neat stock consists of cows, which are used for dairy purposes, are fed upon grass in summer and oil-cake in winter, which is given in the cow-stalls three times in the day; those not in milk eat the blades of turnips occasionally, but the turnips are principally expended with the sheep.

The horses are of the light Suffolk breed, and fed in the summer upon grass, clover, and tares, and in the winter upon cut chaff or hay, and oats at the rate of 2 bushels to each horse throughout the whole year, with 2 trusses or 1 cwt. of hay each in the winter.

A considerable quantity of artificial manure is also used. Guano is most approved. Ground bones are also used, as well as rape-cake, and the kiln-dust from the malt-kilns, which is drilled between the barley.

A system prevails upon this farm, as well as upon other portions of the county, of applying the white chalk clay as a fertilizer to the surface: this is dug from pits, and upon fresh ploughed land has a very beneficial effect, acting as the chalk does upon the strong clay-lands, and tending towards the production of excellent crops, especially of wheat and barley.

---

## II.—On the Jersey, misnamed Alderney, Cow. By Colonel LE COUTEUR, of Belle Vue, in the Island of Jersey.

THE breed of cattle, familiarly known throughout Great Britain as the Alderney, and correctly termed in the article Cattle, of the 'Library of Useful Knowledge,' "the crumpled horned," was originally Norman, it is conceived, as cows very similar to them in form and colour are to be seen in various parts of Normandy, and Britany also; but the difference in their milking and creaming qualities is really astonishing, the Jersey cow producing nearly double the quantity of butter.

The race is miscalled "Alderney," as far as Jersey is in question; for about seventy years since Mr. Dumaresq of St. Peter's, afterwards the chief magistrate, sent some of the best Jersey cows to his father-in-law, the then proprietor of Alderney; so that the Jersey was already at that period an improved, and superior to the Alderney, race. It has since been vastly amended in form, and generally so in various qualities, though the best of

those recorded at that period gave as much milk and butter as the best may do now.

Ten years have elapsed since the attempt was first made by fixed rules to improve the form and quality of the Jersey cow. A few gentlemen, presided over by the then Lieutenant Governor, Major-General Thornton, selected two beautiful cows, with the best qualities, as models. One of these was held to be perfect in her barrel and fore-quarters; the other equally so in her hind-quarters. From these two the following points were laid down to be the rule for governing the judges in all the cattle-shows of the Jersey Agricultural Society.

The accuracy of this arrangement is proved by the fact that no deviation from it has been made, the experience of ten years having only added to the scale the points for general appearance and condition.

*Scale of Points for Bulls.*

Art.	Points.
I.—Purity of breed on male and female sides, reputed for having produced rich and yellow butter . . . . .	4
II.—Head fine and tapering, cheek small, muzzle fine and encircled with white, nostril high and open, horns polished, crumpled, not too thick at the base, and tapering, tipped with black; ears small, of an orange colour within, eye full and lively . . . . .	8
III.—Neck fine and lightly placed on the shoulders; chest broad, barrel hooped and deep, well ribbed home to the hips . . . . .	3
IV.—Back straight from the withers to the setting of the tail, at right angles to the tail. Tail fine, hanging two inches below the hock . . . . .	3
V.—Hide thin and moveable, mellow, well covered with soft and fine hair of a good colour . . . . .	3
VI.—Fore arm large and powerful, legs short and straight, swelling and full above the knee, and fine below it . . . . .	2
VII.—Hind quarters from the huckle to the point of the rump, long and well filled up; the legs not to cross behind in walking . . . . .	2
VIII.—Growth . . . . .	1
IX.—General appearance . . . . .	2
Perfection . . . . .	28

No prize shall be awarded to a Bull having less than 20 points.

*Scale of Points for Cows and Heifers.*

I.—Breed, on male and female sides, reputed for producing rich and yellow butter . . . . .	4
II.—Head small, fine, and tapering; eye full and lively.— Carried forward . . . . .	4



Art.	Points.
Brought forward . . . . .	4
Muzzle fine and encircled with white; horns polished and a little crumpled, tipped with black; ears small, of an orange colour within . . . . .	8
III.—Back straight from the withers to the setting of the tail; chest deep and nearly of a line with the belly . . . . .	4
IV.—Hide thin, moveable but not too loose, well covered with fine and soft hair, of good colour . . . . .	2
V.—Barrel hooped and deep, well ribbed home, having but little space between the ribs and hips; tail fine, hanging 2 inches below the hock . . . . .	4
VI.—Fore legs straight and fine, thighs full and long, close together when viewed from behind; hind legs short, and bones rather fine; hoof small; hind legs not to cross in walking . . . . .	2
VII.—Udder full, well up behind; teats large and squarely placed, being wide apart; milk veins large and swelling . . . . .	4
VIII.—Growth . . . . .	1
IX.—General appearance . . . . .	2
Perfection for Cows . . . . .	30

Two points shall be deducted from the number required for perfection on heifers, as their udder and milk veins cannot be fully developed. A heifer will therefore be considered perfect at 28 points.

No prize shall be awarded to cows, or heifers, having less than 21 points.

The evil was, and still exists, that most Jersey farmers, like many others, never thought of crossing with a view to improvement, conscious of possessing a breed excellent for the production of rich milk and cream—milk so rich in some cows that it seems like what is sometimes called cream in cities—and cream so much richer that, from a verdant pasture in spring, it appears like clouted cream. But the Jersey farmer sought no further. He was content to possess an ugly ill-formed animal with flat sides, wide between the ribs and hips, cat-hammed, narrow and high hips, with a hollow back.

She had always possessed the head of a fawn, a soft eye, her elegant crumpled horn, small ears, yellow within, a clean neck and throat, fine bones, a fine tail; above all, a well-formed capacious udder, with large swelling milk veins.

Content with these qualities, the only question in the selection of a bull, among the most judicious farmers was, "Is the breed a good one?" meaning, solely, had its progenitors been renowned for their milking and creaming qualities? But the mere attention to this was one of primary importance in a circumscribed spot like Jersey; it may have been quite sufficient to establish a hereditary superiority in the most needful quality.

It may also have established it with a rapidity that could not have been obtained in a wide-extended country like France. Hence, perhaps, the present superiority of the Jersey over the French breed.

Some idea may be given of the difference in the form of the ancient and the improved breed by the following sketches:—

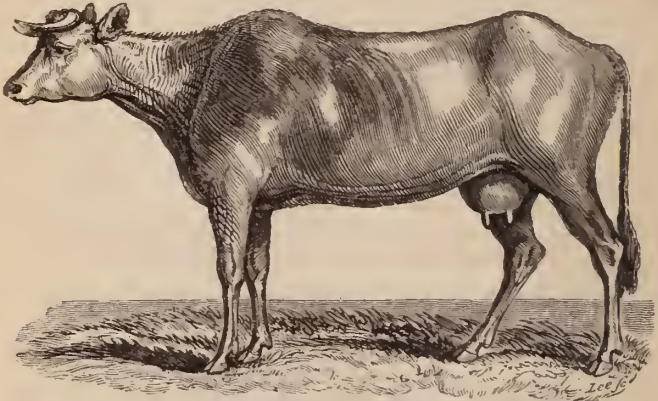

The OLD JERSEY COW, from 1800 to 1830, still to be seen in some pastures. The following points would be taken from her:—cheek large, 1—ewe neck, 1—hollow back, 1—cat ham, 1—flat side, 1—not ribbed home, 1—hind legs crooked, 1—general appearance, 1. In all, 8; these deducted from 26, the number less the pedigree, leaves 18, which was about the average number the best cows had at the formation of the Society.

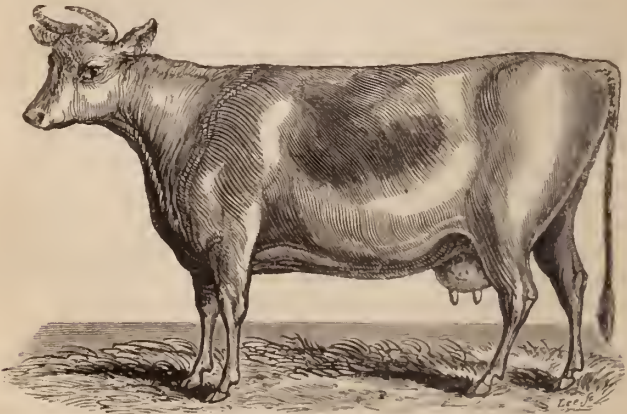

1843, Portrait of "BEAUTY," a Prize Cow, 4 years old, bred by Colonel LE COUTEUR, at Belle Vue. She has already produced 11 lbs. Jersey, or 11 lbs. 13 oz. imp., of rich yellow butter, weekly, in May, from 19 qrts. of milk daily. She was awarded 27 points, as a 2-year-old heifer.

The Jersey cow is a singularly docile and gentle animal; the male, on the contrary, is apt to become fierce after two years of age. In those bred on the heights of St. Ouen, St. Brelade, and St. Mary, there is a hardiness and sound constitution that enables them to meet even a Scotch winter without injury; those bred in the low grounds and rich pastures are of larger carcase, but are more delicate in constitution.

Of the ancient race it was stated, perhaps with truth, that it had no tendency to fatten; indeed some cows of the old breed were so ungainly, high-boned, and ragged in form, Megs Merrilies of cows, that no attempt to fatten them might succeed—the great quantities of milk and cream which they produced probably absorbing all their fattening properties.

Yet careful attention to crossing has greatly remedied this defect. By having studied the habits of a good cow with a little more tendency to fatten than others, and crossing her with a fleshy well-conditioned bull of a race that was also known to produce quality and quantity of butter—the next generation has proved of a rounder form, with a tendency to make fat, without having lost the butyraceous nature.

Some of these improved animals have fattened so rapidly while being stall-fed, from the month of December to March, as to suffer in parturition, when both cow and calf have been lost; to prevent which it is indispensable to lower the condition of the cow, or to bleed, in good time. Such animals will fatten rapidly. Their beef is excellent; the only defect being in the colour of the fat, which is sometimes too yellow. It is now a fair question, whether the improved breed may not fatten as rapidly as any breed known?

Quayle, who wrote the ‘Agricultural Survey of Jersey,’ states—“that the Ayrshire was a cross between the short-horned breed and the Alderney.”

There is a considerable affinity between these two breeds. The writer has noticed Ayrshire cows that seemed to be of Jersey origin, but none of them were said to have produced so large a quantity of cream or butter; nor was the butter in Scotland of nearly so deep a tinge of yellow as the most rich in Jersey. One Jersey cow that produces very yellow cream will give a good colour to butter produced from two cows affording a pale-coloured cream.

It is not doubted that crosses from the Jersey breed have taken place. Field-Marshal Conway, the governor of this “sequestered isle,” as Horace Walpole termed it, and Lieutenant-General Andrew Gordon, who succeeded him, nearly half a century back, both sent some of the best cattle to England and Scotland. If

pains were taken, the race and its consequents might be distinctly traced, which might lead to important results in breeding.

In the 'Farmers' Series,' at the article "The Angus Breed," a portrait of a beautiful heifer is seen; she is said to have been "out of a very small cow, with a remote dash of Guernsey blood in her." Her dead weight was estimated at 130 or 140 stones. She sold for 50*l.*, after having obtained several medals, and had been publicly exhibited.

The grand desideratum is to discover a breed that will be useful to the grazier, the dairyman, and the small farmer. In so small a spot as Jersey, it is difficult to cross the breed essentially—a great step towards it is gained by crossing cattle bred in the low rich pastures with those of the exposed hills on the western or northern coast: these being smaller, finer boned, of a more hardy constitution, and feeding on a short rich bite, impart strength of constitution and hardihood to the larger and more delicate animals of the sheltered low grounds.

It is believed that cattle are generally more healthy and free from epidemics here than in most countries. This may be attributable in some measure to the saline particles which, being so frequently in suspension over the island, are afterwards deposited on the herbage, and tend to its salubrity. After heavy gales, it is frequently found that the grass all across the island has a strong saline flavour. So partial are cattle to this flavour, that they will greedily devour grass which has been watered with sea-water which they previously rejected. Two pipes per acre, spread from an ordinary watering-cart, or from a pipe which may be made to pour into a long deal-box perforated with holes, will be found of great utility where sea-water or salt can be obtained at small cost.

The Jersey farmer treats his cow with gentleness and care; it might be more correct to say that his wife does so. On good farms she is usually housed at night after the end of October to the end of February, if heavy rain, hail, or snow prevail. It is deemed to be healthful to give a cow a short run daily through the winter, excepting in stormy weather. At this season, which is usually several degrees warmer than in the mildest part of Devonshire, she is fed with a certain portion of straw, from 10 lbs. to 20 lbs. of hay, with about 10 lbs. to 20 lbs. of parsnips, white carrots, turnips, or mangold-wurzel.

The small portion of grass which she may pick up in the winter, with the above quantity of food, enable her to produce a rich and well-coloured sample of butter till within six weeks of parturition.

At this period, which is usually regulated to take place about the month of March or April, just when the cow, being in full

milk, may soon be placed on the fresh spring pasture in April or May, she is an object of extreme care. On calving she is given a warm potation of cider, with a little powdered ginger. Quayle hints that pet cows are further indulged with a toast in their cauld.

The calf is taken from the cow at once, and fed by hand. It may be well to advise that, on the first occasion of calving, the calf should be allowed to draw the cow fully; for no milking by hand will so completely empty the udder, nor cause the milk-veins to swell to their full development, as will the suction of the calf.

Some of the early meadows produce rich grass in March; but the general flush of grass, which comes on generally late in April, is the period when the Jersey farmer looks forward with anxiety. The cow is then tethered to the ground by means of a halter 5 or 6 feet long: this is appended by a ring and swivel to a chain which encircles her horns, closed by a ring and bar; the other end of the halter is fastened to a chain 6 or 8 feet long, which is connected by a swivel and ring to a stout iron stake a foot long; this is driven into the ground by means of a wooden mallet. The cow having this circular range of 12 feet or more, is compelled to eat it clean. She is usually moved thrice a day, and milked morning and evening, on many farms at midday also. Under this system, the writer has owned four cows that produced eight-and-forty pounds Jersey, or above 51 lbs. imperial, weight of rich yellow butter per week in the month of May and part of June.

In very hot weather, in July or August, it is advisable to shelter the cow from the heat and flies; otherwise these tease cows to such a degree, by forcing them to run about incessantly, that they have no time for repose or for chewing the cud; they, in consequence, afford much less milk or cream.

It was anciently thought that cream from the Jersey cow was too rich for making cheese. Mr. Le Feuvre of La Hogue, who has a fine breed of cows, tried the experiment two years since, and succeeded to admiration. It was made from the pure milk, cream and all, as it comes from the cow. It was found that the quantity of milk that would have produced a pound of butter afforded  $1\frac{1}{2}$  lb. of cheese.

From the quantity of milk which produced a cheese of 20 lbs weight, the *drainings* of the curds and whey, on being churned, yielded 4 lbs. of butter. This butter was of an inferior quality when eaten with bread, but was superior to any other for the making of pastry; it was peculiarly hard, and of excellent texture for such use in hot weather. The writer has tasted cheeses from Mr. Le Feuvre's farm quite equal in quality to the richest double-Glo'ster.

On one or two farms besides General Fouzel's, butter is made from clouted cream in the Devonshire mode; but as this is not peculiar to Jersey, it is not noticed further than that 10 lbs. of butter are usually made in five minutes by this process. The usual way of procuring the cream is by placing the milk in pans about 6 inches deep—the glazed shallow earthenware having taken place of the unglazed deep vessels.

It is admitted that the richest milk and cream are produced by cows whose ears have a yellow or orange colour within. Some of the best cows give 26 quarts of milk in twenty-four hours, and 14 lbs. of butter from such milk in one week. Such are rare. Good cows afford 20 quarts of milk daily, and 10 lbs. of butter weekly, in the spring and summer months. Butter is made every second or third day.

Lactometers indicate the degrees of richness, or cream, which the milk of any cow affords, with great nicety. This varies with different food. The mode is to fill the lactometer up to zero with the first milk that is drawn from the cow in the morning; then, when the udder is nearly emptied, to fill a second lactometer with the residue of the milk, throwing a little out of the lactometer, to refill it to zero with the very last drops which can be drawn from the cow: these will be nearly all cream. The lactometer filled with the first milking may only indicate 4 degrees of cream, while that filled with the last milking may indicate 40 degrees of cream. Then, by dividing the sum total, 44, by 2, we have 22 degrees of cream, which a very good cow will produce; others so little as 10 or 15.

Jersey butter, made when the cows are partially fed on parsnips, or white carrots and grass, in September and October, when salted and potted will keep till the following spring, preserving as well as Irish butter, with a much less rank flavour.

The present price of the best Jersey cows, including points and quality, is from 20*l.* to 30*l.*; and up to 20*l.* is given for the best heifers. Yearling bulls, of the best breed and points, from 10*l.* to 15*l.*

---

III.—*Further Account of the Tussac Grass.* In a Despatch from the Governor of the Falkland Islands. Communicated by Lord STANLEY.

MY LORD,—A settler, named Jergen Christian Detleff, is desirous of forwarding to England, to be offered for sale, a parcel containing 6 lbs. of tussac seed: as he is of the labouring class, and unacquainted with business, he requested permission to forward it through me. I now do so, and venture to address it to

your Lordship, considering it a national object to introduce this grass into England. The settler Detleff expects to receive not less than 2*l.* 10*s.* per lb.: probably, for a large order, he would be content with a less price per lb.

Conceiving that all remarks relative to the tussac grass will be in some degree interesting to your Lordship, I take the liberty of noticing that I have proved, to my own satisfaction, nothing can answer better than the tussac sown and planted out in rows, the tufts of grass being about 6 feet from centre to centre. I am resolved to pursue this practice by having a large field laid out at Port William, in order to cut bundles through the winter—to fodder horses and cattle in a stable, in the same manner as is done with Guinea grass in the West Indies.

I know that at present it may be cut twice in the year; but, under proper cultivation, it may be gone over much oftener—it greatly improves by cutting, and grows fast. Horses injure it by grazing, and pigs destroy it. My present experiment tends to show that it will grow on almost any soil: and that it is not necessary for it to be exposed to the spray of the sea, although a width of from 300 to 400 yards along the shore is the place of its natural growth.

In some places the extent of the patches appears to be very capricious, the reason of which I cannot discover, as it occurs where the soil and other circumstances appear to be uniform. This is particularly illustrated on an island of some elevation in Port Salvador—the appearance of the tussac patch is somewhat thus cut off in a straight line from the beach directly upwards.



Although the tussac grass may be cut, and amply remunerate the planting in the first year, it seems to take three years (from the seed) to arrive at perfection; but the tufts bear “planting out” extremely well. As to how many years the same roots may last, I can offer no information: decayed portions of the root appear to accumulate, but in a properly attended piece of ground these would be annually removed.

Under our present imperfect system, allowing the cattle to roam and graze at will—pulling out, wasting and trampling as much as they eat—the rough, irregular patches of tussac on Long Island, amounting together to about 150 acres, keep in good fat condition, for six months,\* 250 cattle and 70 horses. Under proper

\* The cattle are kept on Long Island only during the winter months.

management, in my opinion, the same quantity would be found to maintain three times that number throughout the year.

The grass rises high above the snow, is fresh and green all the winter, and from its height completely shelters the horses and cattle lying among it.

Perhaps the best experiment which could be made in England would be to plant tussac on one of the small islands of the Orkneys, such as Hunda, if it met with the approbation of the owner: and I conceive it would be greatly to the advantage of the landed proprietors of the Orkney and Shetland Islands to send from among them an intelligent person to the Falkland Islands, to study the habits of the grass and to collect seed; he should arrive here early in October.

I am sanguine enough to hope that the introduction of tussac into those islands would replace the loss of revenue to proprietors from the depressed value of the kelp: and I hope your Lordship will be inclined to consider this a subject of sufficient interest to the residents in that part of Great Britain and the west coasts of Scotland and Ireland, to cause my remarks to be forwarded for their consideration.

I have, &c.

(Signed)

R. C. MOODY, Gov.

*Government House, Port Louis,  
Falkland Islands, Jan. 17, 1844.*

---

IV.—*An Essay on the Comparative Advantages in the Employment of Horses and Oxen in Farm Work.* By JAMES COWIE, of the Mains of Haulkerton, Laurencekirk, N.B.

#### PRIZE ESSAY.

THIS is a subject which has excited some controversy among agriculturists. Lord Kames wrote elaborately on it, and was at great pains in showing the superior advantages of employing oxen. His observations and calculations are not suited in many respects to the advanced state of husbandry in our day, however valuable they may have been three-quarters of a century ago.

The writer of the following essay is situated in a district of Scotland where oxen are not much used in farm work; but he has for several years past been in the practice of employing them himself; and in the hope that his observations may not be unacceptable to his southern brethren, he has presumed to send them across the Border.

Previously to the discovery of shoeing in the ninth century, horses' feet having no protection against the stones and hard ground,



and their hoofs not being so durable as those of oxen, the latter almost superseded them in field labour. Even up to the middle of last century, when there were few made roads, and when, consequently, all thoroughfares were nearly impassable for wheel carriages, agricultural produce was carried on the backs of the animals, oxen as well as horses.

It may not be altogether out of place or uninteresting here to allude to the plough-team of former days. The manner of yoking oxen in early times seems to have been to fasten the draught gear to the horns. This barbarous practice extended even to a modern date. Lord Kames says—"People differ in the manner of yoking oxen; in some places they are yoked to the tip of the horn, and in some by the root: these modes are visibly inconvenient. When an ox draws by the shoulder like a horse, his head is free, and his motion natural;—when yoked by the horns, he lowers his head to the line of the draught, his posture is constrained, and his step short; his neck indeed is strong, but his shoulder is a better fulcrum for the draught." This is very cool reasoning certainly. It was well for the poor brutes that the policy and interest of the master chanced to be accordant with humanity. Until about the end of last century, the ordinary collars were not used; a sort of stuffed bow was fastened round the neck, and the single tree lay on the *shoulder*, to which were fastened the chains for drawing by. The array of numbers and apparent strength employed in a plough-team would astonish our modern agriculturists. From the earliest times, I presume, up to about the year 1760, as many as from 12 to 20 oxen, and 6 or 8 horses would have been engaged in drawing one plough; this can be partly accounted for otherwise than by the rude and awkward manner of yoking. Before 1770 very little breadth indeed of artificial grasses was sown. The ground was cropped for a succession of years, until the natural grasses, what we now term weeds, got thickly and firmly rooted, the growth of which afforded food during the day in summer for the animals, and at mid-day the ploughmen pulled thistles from among the corn for night provender. In winter the horses were allowed about a feed of oats daily, with oat-straw; the oxen got the latter only. While thus poorly fed, the animals had not strength in the draught, hence the numbers requisite. The farm which I occupy has been tenanted by my ancestors for many generations. At the time of the Revolution my great grandfather, and his son for many years after that, employed 12 working horses, and 28 working oxen, one half of each set being yoked to one plough: I now work the same land to better purpose, I presume, with 6 horses and 2 oxen.

In further discussing this subject, I shall endeavour to treat it in the order pointed out in the conditions:—

1. *The Age and Breed of the Horses and Oxen, and the time at which they are first put to Work.*

Horses in this country are put to work at three years old; they are often from the commencement worked steadily, although it is considered prejudicial to their future development. I am not aware of the breed of the farm-horse in the middle and northern districts of Scotland being recognised by any particular name. The most perfect figure of a draught-horse is that of the Clydesdale breed; he is distinguished by a short compact body and strong broad bone, these properties being characteristic of strength and durability.

Oxen are put to work somewhat older than horses, and they are not at the outset so able for steady work; they cannot be depended on before they are four years old. Our work oxen are bred principally in the shires of Angus and Aberdeen. The peculiarities in their figure are, a small head, deep chest, round body, and short legs. The largest sizes, although frequently selected for work, are, I conceive, not the most proper. They have naturally small bones in comparison with the size of the body; hence the strength of the limbs and the weight of the carcass do not always correspond in reckoning them as "beasts of burthen." The weight of my oxen averages about 800lbs. without the offal, when fed. When much heavier, I find they want activity and endurance, and their feet, from the additional weight, are more apt to give way.

2. *The Condition of Horses and Oxen—the Work performed by each—and its relative Value—Nature of the Soil where worked.*

In all well and economically managed farming establishments, due regard is had to the keeping the horses in good condition. Efficient work can never be performed by ill-fed, ill-groomed animals. The ordinary allowance of food to each horse daily is 16lbs. of oats, and as much oat-straw as he chooses to eat. My oxen get as many turnips as they can eat. They are fed four times a-day, at 5 A. M., 11 A. M., 6 P. M., and half-past 8 P. M., and at each time they eat betwixt them 125lbs., being in all 500lbs. daily. I often slice the turnips for them, especially at mid-day, when they have little time to eat. They never drink any water even in the hottest days of summer. Both horses and oxen graze in summer; I have not ascertained which of them require the most grass.

In regard to the work performed relatively by horses and oxen, I should say that, except in frost, when the land cannot be ploughed, the amount and value of the work performed by each are equal. Many people who work oxen keep 4, and work each pair only one half of the day. This is a most expensive system, and were a good

selection of the oxen to be made, is quite unnecessary. I never keep more than 2 at one time, and they work 10 hours a-day as steadily all the year over, except in frost, as the horses, and keep in perfectly good condition. We often see oxen going very slow and sluggardly at work; when well trained, and of a proper breed and size, they will step out as well and as fast as horses: mine do so. At a late ploughing-match in the district, where upwards of 70 ploughs started, my ox-team was second off the field. The average period when frost prevents ploughing may be stated at six weeks. During this time, except in the thrashing-mill, oxen are unemployed. The horses are then engaged in carting dung, earth, &c. By calculating the work of the pair of horses, without the man's wages, as worth 6s. a-day, and allowing 1*l.* 16s. as the value of the thrashing-mill work performed by the oxen during frost, we have the sum of 9*l.* standing against the latter. It will not do to listen to statements partly speculative and hypothetical, about the capabilities of oxen for drawing wheel-carriages; it is enough for our purpose at present to know that they are not so employed; they are, in the time of frost at all events, unsuited for such a purpose.

The soil best fitted for oxen to tread on is that which is dry and most free from stones. My farm is composed of both clay and black soil, some of the former of which is rather wet, but there are very few stones anywhere. My oxen, although unshod, and working as I have said steadily, never get the least lame, or suffer in the slightest in their feet. On another farm, however, which I occupy, where the soil is more of a clayey nature, and somewhat wet and stony, the hoofs of the oxen wore, and became tender, and rendered them unfit for steady work. Attempts have been made to shoe them in such circumstances, but the experiment seldom proved satisfactory. The conclusion to which I have come is, that oxen cannot by any management or precaution be profitably employed on wet or stony soil.

### 3. *The Cost of Maintenance and Farriery of each Pair of Horses and Oxen, including the separate Charge of Management.*

A horse getting 16lbs. of oats daily will eat in seven months (the period he requires grain) about 10½ quarters, which in value amounts to nine guineas. A horse wears 5 or 6 sets of shoes annually, which cost 18s.; other 5s. will be allowance enough for medicine.

In regard to the cost of maintaining working oxen on green food, such as turnips, I have to remark, that the price of that article varies according to the locality where it is grown. I shall reckon the price or value of the ton of turnips at 10s., being the average in an inland district. I have repeatedly ascertained, both now and formerly, the exact quantity of turnips which oxen eat, and find that

two daily consume about 500lbs. being at the rate of a ton in four and a half days, or 47 tons in seven months (the time they require turnips), which in value amounts to 23*l.* 10*s.* I make no calculation on the cost of straw. I believe the quantity eaten by a horse and ox to be about equal. The charge of management of horses and oxen is the same. One man has the charge of a pair, and all must be groomed and otherwise attended to alike.

*4. The Cost or presumed Value of each Pair of Horses and Oxen with their Gear, when put to work, and their Value at the end of the Comparison.*

A pair of farm-horses, four years old, suitable for all kinds of work, can be bought for 5*l.* Their gear or harness, including the cost of keeping it in repair, amounts to 25*s.* yearly. Should no accident occur, a horse will last twelve years, at the end of which time he is worth about 6*l.* Including the difference between the original purchase and ultimate selling price, together with interest, the sum of 3*l.* 10*s.* is thus lost annually on each horse. There should be added to this at least 30*s.* to cover accidents and deaths.

A pair of oxen, four years old, costs 26*l.* The last pair which I bought cost 24*l.* They have worked regularly for four years, and I am now feeding them for slaughter. I expect to get about 30*l.* for them. They work one day a week at the thrashing-mill, which does not seem to retard their feeding. I would therefore calculate that no actual loss will be sustained on oxen from the time of their being bought and sold. The cost of gear, including keeping in repair, costs 10*s.* annually.

The account of the different items stands thus:—

*Expenditure, &c. on a working horse yearly.*

	£	s.	d.
To 10½ quarters of oats at 18 <i>s.</i>	9	9	0
To deterioration in value, interest on outlay, losses by accidents and death	5	0	0
To shoeing and medical attendance	1	3	0
To furnishing and repairing gear	1	5	0
	<hr/>		
	£16	17	0
	<hr/>		

*Expenditure, &c. on a working ox yearly.*

	£	s.	d.
To 23½ tons of turnips at 10 <i>s.</i> per ton	11	15	0
To furnishing and repairing gear	0	10	0
To loss on his work during frost	4	10	0
To interest on purchase price	0	15	0
	<hr/>		
	£17	10	0
	<hr/>		

In the above table, I have calculated the oats given to the horses at the market price; but the cleanings and inferior grain, which cannot be otherwise disposed of, constitute a considerable portion of their food, and thus the cost on this item can be reduced; otherwise the figures above so nearly correspond, that it rests with the partiality of parties whether they shall employ horses or oxen, or partly both. For my own part, after duly considering the matter, and after the experience of a number of years, I should give the preference to employing horses exclusively. They are ready at all times for all kinds of work; in wet or frosty weather they can be employed in carting, and in leading the crop in harvest they are invaluable and indispensable, while at all these times the oxen are "eating the bread of idleness."

---

Having formerly employed both horses and oxen rather largely in farm labour when residing in Germany, my experience would lead me to use the former solely on road work, and the latter in the field, but coupled with the observation that it must be *clay land*; for, on light soils, I am convinced that horses will do the work more satisfactorily than oxen, and quite as cheaply, unless the farm contains a large portion of rough pasture.

J. FRENCH BURKE.

---

V.—*The Farming of Cheshire.* By WILLIAM PALIN.

PRIZE REPORT.

IN offering a Report on the agriculture of the county of Chester, it may be necessary to observe that cheese being generally considered the staple commodity of the county, and the plough being regarded only as an accompaniment to the pail, the attention of the farmer is principally directed to that article, on the proceeds of which the payment of his rent chiefly depends; the course of cropping, and the general management, will therefore be found to differ materially from those of other districts, where the dairy, if of any interest at all, is merely a matter of secondary importance. Having been practically engaged on a large dairy farm in the interior of the county for nearly thirty years, I have had opportunities of witnessing the different modes pursued, and the progress made during that period; I therefore presume to offer the present statement of its agriculture. In addition to the knowledge derived from my own experience and observation, I have endeavoured to elicit information upon every point proposed in your important inquiry from the most intelligent and the

most authentic sources; and with this view I have visited almost every part of the county.

The farms, with few exceptions, being appropriated to the dairy, the great objects which the best farmers are desirous of attaining, are the selection of a suitable stock for that purpose, and an ample provision of nutritious food best adapted for the cattle during the winter, as well as a good sweet herbage during the summer months. And here I would remark that a great improvement has taken place within the last twenty years in the provision for milch cows by the more general introduction of turnips, and the application of bone manure to the pasture land; to both of which modes of culture I shall have occasion to refer more fully hereafter.

The agriculture of Cheshire is not of so high a character generally as that of some other counties in England; and perhaps it exhibits as great a variety of methods, and as bad specimens of farming, as can possibly be conceived: yet I think it will be admitted that many of its farms approximate very closely to an excellent state of cultivation. During the ten or fifteen years preceding the spring of 1842, a considerable improvement in the management of the land became perceptible; and this result may chiefly be attributed to the diffusion of knowledge by means of agricultural societies—to the stimulus given by competition for their various premiums—and to the assistance rendered by some of the landlords in granting to their tenants a certain quantity of draining-tiles, and in occasionally supplying them with bone manure. Since that period the depreciation in the price of agricultural produce (with an undiminished pressure of the demands upon the farmer) has given a check to that spirit of improvement which was spreading through the county, and which was becoming more apparent every year.

From the great admixture of the prevailing soils of this county, which have been shown by Dr. Holland to consist of sand loams, tenacious clay, and clay loams, it would be tedious and uninteresting to enter into every particular respecting them; and there are many farms which do not exclusively belong to any special class—for instance, in a field in my own occupation, light sand land, strong clay land, and peat, are so intermixed, that the general management cannot vary in any material degree. In order, therefore, to give a clearer view of the various methods of cultivation, I shall classify the farms under four distinct heads, and treat of each respectively, viz. :—

1. Sand-Land Dairy Farms.
2. Clay-Land Dairy Farms.
3. Sand-Land Arable Farms.
4. Clay-Land Arable Farms.

*Sand-Land Dairy Farm.*

The ordinary course of cropping on a farm of this description is as follows:—The first crop of corn usually taken is oats on the grass ley of one strong furrow; the ploughing commences early in February, and the sowing at the beginning of March, or as soon as the ground is dry enough to receive the seed, which is sown by hand at the rate of 5 customary bushels of 38 quarts, or 6 imperial bushels, per acre; the land is then well harrowed, first with rather a heavy pair of harrows, and followed by lighter ones, until the seed is completely covered. It is not unfrequently rolled, if dry enough, immediately after sowing—a process which compresses the furrow, thereby giving the seed firm hold of the ground, preventing rooks and other birds from tracing the rows of corn with their accustomed ease when the ground is left quite light by the harrowing; and it gives an even surface to the land, by which the operations of mowing and raking are much facilitated. If the rolling be deferred until the blade of corn has made its appearance, it has a tendency to check the growth of the crop in a manner which is sometimes injurious. The varieties of oats generally sown are:—

The Poland, or leather back (very saleable to stable-keepers, grooms, &c., from their large and plump appearance).

The Potato (yield much meal, and are preferred by millers).

The Friezland Cuts (stand well on good land).

The Yellow (productive on poor land).

The Hopetown (suitable for strong soils).

And the Tartarian, which are not very common.

As soon as the crop is cleared off the ground, pigs, geese, &c., are turned into the field to pick up the oats which are shed. The land is then prepared for wheat by ploughing it across the butts as thinly as possible; it is next harrowed with heavy harrows, which bring the stubble, grass-roots, &c., to the surface. In the course of a week or nine days, if the weather be favourable, it is harrowed again; and if intended to be sown by hand, is seldom ploughed until the second or third week in October, when it is formed into butts of from 5 to 9 feet wide, according to circumstances; and sufficiently deep to cover the stubble, grass-roots, &c., brought to the top by the previous harrowing, commencing in the rein of the former butts, and making the former ridges into reins.\* If the wheat is to be drilled,† a little difference is re-

\* *Reins*—a provincial term for the lower furrow or division between the butts.

† The practice of drilling corn is very limited in Cheshire at present; but there is reason to believe that it is becoming more general every year, as, where it has been tried, it appears to have given satisfaction. Amongst the advantages of drilling may be specified the equal distribution of the seed—a saving in the quantity—the depositing of it at the same depth—and the facility which is afforded for hoeing, if required.

quired in the management: the first ploughing across the butts is immediately succeeded by a longitudinal ploughing of the same depth into large flats, in order to give the ground a level surface, and to enable the ploughman to form the butts of equal size and uniform roundness, which is an operation of great importance if the land is not particularly dry; the butts are made double the width of the drill, thus admitting of their being sown at one bout or round, and the soil is then usually water-furrowed by a double mouldboard-plough passing along the reins.

The practice of growing two corn crops in succession on the same land may probably be censured, as not being in accordance with the rules of good husbandry; but my own experience convinces me that as good crops of wheat may be grown after oats upon the ley or green sod as any other crops, provided the land be properly managed; and on dairy farms, where the tillage is limited to one-fourth of the acreage, the alternate green crop system would not answer so well. For instance, on a farm of 200 acres, 25 would be in green crop,\* which would be more than could be consumed to advantage, and only 25 in corn, which would not furnish an adequate supply of straw for five or six horses, forty or more milking cows, besides young stock and pigs, and also thatch for the stacks, as well as (in many cases) for part of the farm-buildings.†

The general method with regard to wheat stubbles is to give one ploughing before Christmas, merely reversing the butts. An improvement has taken place on some farms in this respect within the last few years; the land is ploughed very thin, harrowed, and then ploughed again to the depth of 6 or 7 inches, thus covering all the stubble, and rendering it much more easy to be worked in the spring. The succeeding crop is generally

\* Peas and beans, it may be observed, run too much to straw on this description of land.

† In addition to the old kinds of wheat formerly grown in the county, many new varieties have lately been introduced; amongst those generally cultivated are the following:—

*Old Red.*—A fine straw, with a long thin ear; stands well, and the grain is much liked by millers.

*Red Britannia.*—Strong straw, thick long ear, large grain; not so fine in quality as the former.

*Golden Drop.*—Yellow grain, strong white straw.

*Pearl.*—Very white, compact ear, and great producer.

*Blood-Red.*—Stiff straw, and not apt to lodge; an excellent sort for spring.

*Yellow Dantzic.*—Fine straw, small grain; very productive on good clay-soils.

*Devonshire Red.*—Compact ear, liable to lodge in wet seasons; very productive when it stands well.

*Chidham.*—Very white, and something like pearl.

*Hoptown.*—Large ear, and strong; not apt to lodge.



Swedish turnips, and some potatoes in drills, manured with farm-yard dung or crushed bones, deposited with the seed by a machine exclusively for that purpose, at the rate of from 12 to 20 cwt. per acre. The turnips are usually drawn in the months of November and December; the tops are given daily to milking stock, and the bulbs are stored for the horses, cows, young cattle, and pigs.

The turnip and potato crop is sometimes succeeded by wheat, though more generally by barley,\* and the land is sown with clover and grass seeds in the spring. There is some risk in obtaining a good clover root with wheat, on account of the prevalence of the slug, or small snail, for the destruction of which I have found a slight sprinkling of lime, sown late in the evening, to answer well. There is also an uncertainty in having the ground in proper condition for receiving the seed, which should be sown immediately previous to rolling the wheat; besides, a greater degree of moisture is required to cause the seed to vegetate and take root, than when the land has been recently stirred. If the land is to be pastured the following year, white Dutch clover is sown at the rate of 10 lbs. or 12 lbs. to the acre, with 2 lbs. of trefoil, 1 peck of perennial rye-grass, and a few meadow-grass seeds from the hayloft. The latter practice is not now so prevalent as formerly, in consequence of an opinion that a number of seeds from different kinds of weeds, as docks, thistles, couch-grass, &c., are conveyed amongst the meadow-grass seeds to land which has been cleared, at considerable expense, by the previous green crop; and, indeed, it is almost impossible to keep meadows free from such weeds, as large quantities of seeds are annually brought by the floods from neglected land, and deposited in the meadows.

If the land is to be mown the first year, red clover, or a mixture of red and white, with rye-grass, is sown: the latter is preferred, if to remain in grass afterwards, as the red clover generally disappears the second year after sowing, and leaves a bare pasture if sown alone. The land remains in grass four or five years, when it is again broken up, and undergoes the same process. If it has been mown, it is generally manured afterwards on the green sod.†

Of other courses pursued on sand-land dairy-farms, where the tillage is not so limited, the following may be cited:—

\* *Norfolk, or Roundland*.—Long, thin ear; much liked by maltsters when fine in quality.

*Chevalier*.—Much liked; short ear, and fine straw.

*Sprat*.—Very stiff in the straw; short, compact ear; small grain; stands well where no other sort will.

† Lime, at the rate of 4 tons per acre, is a good dressing, which I have found to answer well.

On one farm in the Hundred of Eddisbury, of 200 acres, slate-marl is applied to the grass-land when it is broken up for potatoes or turnips, which are followed by wheat; then potatoes or turnips; oats, or barley, and seeds—10 lbs. red clover, 2 lbs. trefoil, perennial rye-grass, top-dressed and mown, pastured for three or four years.

On a farm of 160 acres, in the Hundred of Bucklow, the course is—potatoes or turnips on ley, manured, in drills, from the farm yard; wheat; potatoes or turnips; wheat clovered down—6 lbs. red, 3 lbs. white, and hay-seeds, mown twice, and pastured five or six years. The clover root is manured with bones, previously to mowing, at the rate of 10 cwt. or 12 cwt. per acre.

On two adjoining farms of 300 acres, in the Hundred of Eddisbury, the course is—wheat on ley; turnips and potatoes; barley; clover, pastured for four years. If the land be sufficiently clean after the wheat, a crop of barley is taken before the turnips. On these two farms, previously to the year 1820, the practice was to grow four or five grain crops in succession, without ever thinking of a green crop: the land was in consequence filled with charlock, and the corn was exceedingly light. The farms have become much improved by the introduction of turnips.

On a farm in Delamere, consisting of light sand-land, another course is adopted, as follows:—1. Oats; 2. Potatoes and turnips; 3. Wheat; 4. Oats and clover, afterwards pastured for four or five years.

#### *Clay-Land Dairy Farm.*

The course of cropping adopted on a clay-land dairy-farm varies considerably from that of a sand farm. The grass-land is frequently broken up for a summer fallow; it receives one ploughing before Christmas; early in the spring it is cross-ploughed; in the course of the summer it receives one or two more ploughings, and an occasional harrowing, knife or spike rolling; towards the middle or latter end of August, it is formed into butts, and, if the weather is favourable, is sown with wheat about the middle of September. It is not unfrequently sown under-furrow, as it is termed, the seed being sown on the surface, and turned under by a shallow furrow with the plough. This practice is not so common as formerly, it being thought by many better to harrow in the seed. After the seed has been deposited, ploughed under, or harrowed in, the field is carefully water-furrowed and guttered. A large portion of the flat clay-land has been formed, ages ago, into butts or loons, varying in width from 15 to 50 feet or more. Where this is the case, the form is scarcely ever altered, unless by a few furrows being ridged up in the rein, to the width of 5 or 6 feet. Sometimes small butts are made at right angles with the larger ones. This appears to be an excellent plan for keeping the land dry during the winter. The reins, which empty themselves into the main reins, are drawn with a double mouldboard plough, so as to admit of a free escape for the water. The wheat-crop is succeeded by oats, the land being either winter-fallowed or sown on one furrow early in March. The latter mode is preferred by some, not only on

account of the saving of labour, but because the land is thought to turn up drier, and is sooner in order to receive the seed than that which has been winter-fallowed. This latter opinion may probably have arisen from the careless manner in which the winter-fallowing of clay-land is too often performed, the ploughman thinking it only necessary to turn over the furrow to the depth of 3 or 4 inches, thereby leaving a hollow in the centre of each butt for the reception of water, instead of ploughing deep enough to give a roundness to the butts, and a depth to the reins to draw off the water. The land is usually laid down with the oat-crop, and kept in pasture seven or eight years. On the very poor clay-lands, when the clover has disappeared, which is invariably towards the latter end of the second year after sowing, the pasture becomes and continues so poor, for three or four years, as to be scarcely worth one quarter of its rent, saying nothing about rates and taxes.

The evil arising from this poverty of the land may be remedied by sowing a greater variety of grass-seeds with the clover, and the application of bone or other manure, the former being decidedly preferable.

A deviation from the foregoing course is frequently practised on the better kind of clay-soils—the first crop being oats, then summer-fallow for wheat, which is followed by oats and clover. Occasionally the wheat-crop is succeeded by beans or peas, and the land is again sown with wheat. When such is the case, manuring with a compost of soap-waste, or lime and ditchings, is generally considered indispensable. The wheat-land is either sown with clover in the spring, or another crop of oats is taken, and seeds are sown, as in the former instance. On the poor clay-lands, turnips or potatoes are seldom attempted, except an acre or two of the former in a small field near the farm-house; and of the latter, barely sufficient for the use of the family.

Another course pursued on poor land, in the Hundred of Broxton, is as under:—

Fallow, wheat, oats, fallow, wheat, oats, seeds. Lime on fallow is used at the rate of 4 tons to the acre. On this estate tiles are offered to the tenants on condition that they pay one-half the value. Formerly, no charge was made, and the tiles were freely used; but now the farmers resort to sod-draining. I need scarcely add that the land just noticed is left in a very exhausted state.

On another farm in the Hundred of Broxton, the course adopted is—  
1. Wheat on grass ley; 2. Oats; 3. Fallow; 4. Wheat; 5. Clover, manured, pastured, and broken up in four or five years.

#### *Sand-Land Arable Farm.*

There are very few farms of this description in the county. On one, in the hundred of Eddisbury, consisting of 160 acres, the following course is adopted:—

The grass-sod is ploughed very thin at the latter end of the year; early in the spring it is cross-ploughed and harrowed, then well worked with a scarifier, and formed into ridges 27 inches apart. Winter potatoes are next planted without manure, which crop is followed by wheat, generally

drilled at the rate of 2 customary bushels of 38 quarts to the acre, the rows being about 7 inches apart; the wheat crop is succeeded by Swedish turnips in drills, the land being manured with a compost of dung and soil, the latter being taken from the headland. The turnips are followed by either wheat or barley, when the land is laid down with red or white clover, or a mixture of both and grass seeds; if the clover be mown, the land is again manured previous to breaking it up, which is generally done every fourth year; in the meantime, it is grazed with either sheep or horned cattle. This farm is managed in a very superior style of cultivation, which does great credit to the occupier.

Another course, practised on a farm of 700 acres, in the hundred of Nantwich, a part of which only is appropriated to the dairy, and which consists chiefly of a light weak soil on a subsoil of fox-beach or white-sand, is as under—

1st, turnips, generally Swedes, manured with 15 cwt. of boiled bones per acre, or, within the last two years, Guano, at the rate of 3 cwt. to the acre, part or the whole of the crop being eaten off by sheep; 2nd, barley or oats, laid down with clover; 3rd, clover; 4th, wheat; 5th, turnips, manured as before and eaten off; 6th, barley or oats; 7th, clover; 8th wheat; 9th potatoes; 10th, wheat.

One of my correspondents, in the Hundred of Nantwich, says—

“ My system of tillage is as follows:—1st, turnips; 2nd, barley or oats, the choice depending upon the nature of the land, as I find oats to answer best on peat, or on land which has been drained; barley requires sound land to produce a good article; 3rd, seeds; 4th, wheat; and after two courses I generally take a crop of potatoes, which is followed by wheat, and then return again to turnips, and the four course. If the land is very light I eat-on the whole, but generally draw off the larger turnips, say about one-half the crop. I grow from 80 to 100 acres annually, and for the last fourteen years have manured them entirely with bones, except a part, during the last two years, with Guano, which had a wonderful effect; I tried it last year in every field I sowed, and with the same result; I think the crop was in some cases one-third more, but generally about one-fourth. I have generally used about 14 or 15 cwt. of bones to the acre, and of Guano about 3 cwt. It is almost impossible to describe the nature of the soil, as it varies so much; but, generally speaking, it is very light on a subsoil of fox-bench or white sand. I have only been a bean-grower three years; I have sown them after potatoes and turnips, and they have always done well. I sowed some on rather strong soil, some on light sand, and others on peat; the latter during the past year were considerably the best.”

#### *Clay-Land Arable Farm.*

On two adjoining farms of about 900 acres, in the Hundred of Wirral, not very distant from Chester, by far the greater portion having been drained along each rein (the small butts being at right angles with the large ones) the following course of cropping is adopted, the same system being pursued on each farm. The grass land is ploughed in December or January into strong furrows, and in March beans are drilled in rows 27 inches apart; a small mark is made with a common plough along every third furrow; thus—

---



---



---



---



---



---

when the beans are deposited by means of a small drill, which is fixed immediately behind the heel of the plough. The beans being thus sown, manure is spread along the rows; a furrow is then thrown over them, and as soon as the land is sufficiently dry, the whole field is rolled with a light roller to level the furrows, and then harrowed with a pair of common harrows. The bean crop is afterwards kept clean by the plough and small scarifier. The course on strong clay is

1st, clover root, pastured, or if mown, manured; 2nd, pasture; 3rd, beans; 4th, wheat; 5th, fallow or turnips, or part potatoes; 6th, wheat, laid down with clover and other seeds.

In the Hundred of Wirral, on a farm of 150 acres, the following course has been successfully adopted:—

1st, clover; 2nd, wheat; 3rd, beans or potatoes; 4th, wheat; 5th, turnips; 6th, wheat or oats, with seeds.

Another course, on a poor stiff clay land farm, in the Hundred of Wirral, is as under:—

1st, clover; 2nd, wheat; 3rd, green crop; 4th, oats and seeds.

On the above farms thorough-draining and subsoiling are invariably performed previous to cultivating green crops.

In the Hundred of Broxton another course, on the drained land, is in the following order:

1st, oats on ley; 2nd, beans in drills, manured, instead of fallow, as formerly; 3rd, wheat; 4th, oats, laid down with clover and other seeds.

Another course, adopted on stiff weak undrained clay, runs thus—

1st, oats on ley, one furrow; 2nd, fallow manured with a compost of lime, &c.; 3rd, wheat; 4th, oats and seeds, pastured five or six years.

Another course, on the better kind of clay land—

1st, oats; 2nd, wheat; 3rd, fallow, manured with lime or compost; 4th, wheat; 5th, oats; 6th, clover, pastured and manured before breaking up again.

Another mode of agriculture, differing from any of the foregoing, is almost peculiar to a district of the county which borders on the Duke of Bridgewater's canal, between Runcorn and Altrincham, the principal object of the farmer being to raise early crops for the Manchester markets, as he has the double advantage of canal carriage for his produce, and of bringing back manure to his farm at a reasonable cost, no tonnage dues being levied, and

only a small charge for wharfage. The course of cropping which is practised (commencing in the neighbourhood of Warrington) is as follows:—

The land is manured and planted with early potatoes in the month of March, and the gathering of the crop commences towards the middle of June. As the ground becomes clear of the first growth, Swedish turnips or a second setting of potatoes are planted; on the removal of this crop wheat is sown, and in the spring clover, which is mown the following year, and is then pastured for three or four years. Sometimes early cabbages are planted in November after the potatoes, and sold off in the spring; in which case the land is planted again with potatoes, and undergoes the same course, having received a good manuring for the cabbages; the land is generally trenched for the potato crop. Proceeding towards Altrincham, some difference in the management is observable; much of the land being suitable for the growth of carrots, a part of almost every farm is appropriated to the culture of that vegetable; four or five acres are let to gardeners at 2s. per rood of eight yards square. The system pursued is to skim the grass ley, then trench the land into four-yard butts, burying the sod in the trench; sow broad-cast, and clean with small hoes. The crop averages about 15 tons per acre: the land is potatoed the following year, and sown with wheat in the autumn; then a crop of oats, and laid down with seeds; sometimes pastured for one year, but generally mown twice, and broken up again.

Another practice is to have oats on leys marled on the oat-stubble; then potatoes and turnips, followed by wheat laid down with red clover, 12 lbs. to the acre; mown and broken up for wheat; then turnips, manured from the farm-yard, or with horse-dung from Manchester, at 6s. 6d. per ton, and followed by barley, sown with a mixture of red and white clover, 10 lbs. of the former and 3 lbs. of the latter, besides seeds from the hay-loft; mown the following year, and broken up again for wheat. This course is pursued for several years, until it is thought that the field requires rest.

Another course adopted in this district is as follows:—

Potatoes on ley, with two ploughings; first, thinly skimmed, then a strong furrow, then wheat, laid down in the spring with clover; mown and broken up again for potatoes, which are followed, as before, by wheat; sometimes oats are taken after wheat, and the land is laid down with seeds, to remain a short time in pasture; but few cattle are kept, and perhaps the necessity for them is not very great, on account of the facilities afforded by the canal for laying down manure on the farm. There are no dairies here, the milk being sold to the dealers for the supply of Manchester and the surrounding neighbourhood.

In order to explain and illustrate more fully the various systems of cropping practised in Cheshire, I subjoin some extracts from letters with which I have been favoured by correspondents, in reply to my applications for information. From the Hundred of Macclesfield:—

“The course of cropping generally followed here is very bad; the fallow is usually planted with potatoes, and then wheat on all descriptions of soil, some of which is very inferior for the latter, and not at all adapted for its cultivation. After wheat, oats with clover, which the farmers cut once and then leave the land in a poor and dirty state, to lie two or three years in grass. In some cases lime is applied in a mortared state the second year, but the land yielding no pasture capable of producing milk or butter

to any extent, then follows the complaint that it will not pasture; it is then ploughed again, is subjected to the same treatment as before, and some will even take three white crops before they will let the field lie; the land is consequently so impoverished that it becomes almost useless for several years. But there are many exceptions to the above bad system, and of late years improvements have progressed so much that we now see, in different situations, good crops of turnips produced with bones and Guano."

From the Hundred of Broxton:—

"The farmers, if left to themselves, have little or no system of cropping; they have an inveterate inclination to keep tilling the same land, until reduced to a stand-still, and then to sow with the last crop of oats a little red clover and some seeds out of the hay-loft; but the usual course is, on breaking up—oats, fallow, wheat, oats and seeds, clover mown, pasture; but most of the farmers would, if uncontrolled, go on with at least another crop of wheat and oats before the seeds. The fallows are occasionally broken as to pieces of fields, with potatoes and *now* turnips. On this estate they seldom till a third of the farm; no more than two successive grain crops without an intervening fallow and purchased manure, lime, &c.; no more than three grain crops in one course of tillage; only one crop of wheat in a tillage. Tenants are bound to lay all their farm-yard manure on grass-land, or green crops to be consumed on the premises; not to sell hay, straw, or food-roots grown with home-made manures. I believe these restrictions are what most landlords about here are aiming at, and most tenants coming into. In Wirral many farmers take only two grain crops in a tillage—oats, fallow, wheat, and seeds upon the wheat. At the Neston Farming Club, last spring, I asked the question about laying down with the wheat crop, and was answered by their best men that it was an approved practice, particularly on *drained* land, where it was not necessary to make small round wheat-butts."

Another correspondent, from the Hundred of Broxton, says—  
"With the exception of one or two fields, I may call the whole of my farm clay land." The course of cropping I propose to adopt is—

"1st, wheat; 2nd, beans, drilled and manured; 3rd, wheat; 4th, turnips, or other green crop, drilled and manured; 5th, oats; 6th, clover. Whether I shall be able to overcome the difficulties generally complained of, in attempting to grow turnips on such stiff land, remains to be proved. I trust that thorough-draining and subsoil-ploughing will effect such an alteration in the nature of the soil, as, in ordinary seasons, to remove those difficulties. There are two or three fields, some of the stiffest land on the farm, which present a very sorry appearance; these I have been recommended to drain and cover with bone dust, and keep in pasture; but shall wait until I see the effect of the course which I am adopting on the other stiff land."

A third correspondent, from the Hundred of Broxton, writes—

"The soil here is principally of a clayey nature, and there are various notions of farming. In many instances it is exhausted, owing to the repeated cropping of the same land. Landlords have an objection to the old ley being broken up, which is a supposed protection to the owners of the soil, the farms being let in most instances from year to year. If leases were granted upon fair conditions I am convinced that an immediate improvement would take place; and if the old ley be so essential to the making of cheese, it might be gradually changed. Tenants are bound not to have more than one-fourth of the land up at once. I make a practice

of growing my wheat upon grass or clover ley, green crop next, and lay down the following spring. This course I cannot regularly pursue, because it gives me too much green crop for my straw, and I am compelled to lay down part with oats for the second crop; but I invariably take a green crop on the land so served the next tillage."

A fourth correspondent, from the Hundred of Broxton, says—

"When a piece of grass-land is ploughed, it is almost invariably sown with oats; and if the condition is such as to warrant a fair expectation of a green crop, with a small quantity of manure, it is sown with turnips and potatoes, then cropped with wheat, afterwards with oats and clover. If the piece be very poor, a summer fallow follows the first oat crop, and it is kept in tillage with oats, beans, or peas in succession for several years. There are very few turnips grown, and seldom more potatoes than are requisite for the use of the family and the farm-labourers."

From the Hundred of Bucklow—

"For the ordinary course of cropping in the parish of Great Budworth and its borders, the land is skimmed about the month of November, as a preparation for potatoes, both early and late; if for early ones, then after that crop the same ground is either planted with Swedish or sown with common turnips, or a second setting of potatoes of the early kind for seed. In October or November, the crops having been got up, the land is either butted for the next year or sown with wheat; the latter is the most general practice. The next crop is potatoes again, of course with manure, which, if the land be poor, is applied in the first crop, and *vice versâ*. The potatoes having been gathered, the land is sown with wheat in October or November, and followed with oats, clover, and grass seeds, of which, in some instances, Italian rye-grass forms a part, and from its rapid growth and frequency of cropping, is growing into repute. Where the purse is a long one, bone-waste is often set upon the clover-root, either before or immediately after the first mowing, at the rate of one ton to the acre; some will only apply 15 ewt. of bones, and these the boiled ones. Clover is occasionally mown twice, but this practice, in the opinion of all good agriculturists, is too exhausting. The same land is not tilled again for six or seven years, according to the nature of the soil, as being more or less suitable to the kind of crops required, and which the other parts of the farm would ill produce."

From the Hundred of Nantwich—

"There is no particular system in practice here; but one method is pretty general, that of ploughing up a field, and never finding a proper time to lay it down again until the land is exhausted and left in a very dirty state. Such was the condition in which I found my farm, and, in fact, the whole township was little, if any better; the fences were also shamefully neglected. I hope, however, that farmers are now roused from their lethargy, and that shortly a better system will be adopted. The only green crop has been potatoes, for which there has been a good market in the Potteries; but now turnips are grown, though in most instances in small quantities; yet I think they will soon be cultivated to a considerable extent. A few leases have been granted from 14 to 17 years. It is desirable that some of the clauses, especially those relating to tillage, should be altered, as one-fourth of the land is not sufficient for the growth of corn and green crops where the pastures have been manured with bone-dust; for it will not produce the requisite supply of fodder to feed the increased number of cattle, which the pastures, when improved by bones, will keep during the summer."



Another correspondent, from the Hundred of Nantwich, writes—

“The tenantry on this estate are all under yearly agreements, at a valuation of cheese at 60s. per cwt. and corn at 9s. per bushel. They are allowed two-sevenths of their acreage for their yearly tillage, and are not permitted to take more than two straw crops in succession; but there is such a disparity in the farms, that no general rule could be laid down that would be beneficial to either the landlord or the tenant. Upon the light-soil farms, under the best management, the four-course system is practised; others prefer taking a crop of oats upon their clover-leys, and wheat afterwards; and where two white crops are taken in two successive years, I give the preference to this mode, instead of taking the oats after the wheat crop. Upon those farms which will not answer for turnips, fallow, oats, and clover is the usual course, two years down; oats upon the clover-ley, fallow next, wheat, and oats with seeds.”

From the Hundred of Eddisbury:—

“The state of cropping in this neighbourhood is as follows with most of the farmers:—1st, oats; 2nd, potatoes; 3rd, wheat; 4th, oats, laid down with clover; the general management is not good, the crops being left in a dirty state. Another course, pursued with old pasture broken up, is, 1st, oats; 2nd, green crop (potatoes, turnips, mangold wurtzel, &c.); 3rd, wheat after potatoes and mangold wurtzel, barley after turnips, laid down with red clover and Italian rye-grass; 4th, mowed; 5th, oats; 6th, green crop, as before; 7th, wheat and barley, laid down with a mixture of clover and grass seeds for permanent pasture. By this rotation of cropping, the land gets twice manured in seven years; and if the crops have been well cleaned, the soil will be in fine order for clover, &c.”

Another correspondent, from the Hundred of Eddisbury, says,—

“The course of crops on tillage land in this county is as various perhaps as can be conceived, and a neglect of a regular succession may probably be attributed to every successful farmer only using the plough as an accompaniment to the pail; for cheese being produced here in great abundance, and the agriculturist well knowing that he can obtain a considerable sum annually from his dairy occupations, at a trifling expense (as compared with the growth of corn), usually devotes all his skill for the attainment of that object; he consequently grows but little corn, and frequently neglects his tillage land. This is more generally the case on strong clay soils, though not at all unusual on lighter soils, which are adapted to a better system of husbandry. Although Cheshire has not ranked high among agriculturists, for any great ingenuity displayed by its practical farmers, still there are districts in this county which are not inferior to any in the kingdom for the economical and profitable system of management adopted. In these parts, the four and five course system (including clover) is the general practice.”

From the Hundred of Wirral:—

“This may be said to be a dairy district, where the farmer's chief attention is paid to his grass land. The small quantity of land which he is allowed by his tenure to plough or break up varying in extent from 1-3rd, 1-4th, and 1-5th of his whole farm, that portion which is under tillage is very soon reduced to poverty by wheat, oats, and clover in succession, with but little assistance of either manure or cleaning applied to it; and in many instances, the farmer comes to a stand-still for want of produce of straw; he is then compelled to request his landlord to allow him to break up a piece of his grass land, ‘to give him something,’ as he says, and the tenant

has no hesitation, in return, to consent that a piece of his old tilled land shall rest. Rest indeed it must, as probably it has not done so (in many instances) for forty years. There are very few tillage farms in the district; but where the occupiers have had the advantage of access to manure, and the capital wherewith to purchase it, and thoroughly drain the land, an advantageous course of cropping has been thus pursued, viz., 1st, clover, pastured, or if mown, manured; 2nd, pasture; 3rd, beans or vetches, drilled, and partially manured; 4th, wheat; 5th, fallow and turnips manured; 6th, wheat, clovered down. This rotation applies to heavy wet land, where neither barley nor oats can be advantageously grown."

### *Breeds of Cattle in Cheshire.*

There is no distinct breed of cattle peculiar to this county; the dairy stock consists principally of a great variety of crosses with the breeds of other districts, viz., the Yorkshire or Holderness short horns, the Lancashire and Staffordshire long horns, the Devonshire, the Ayrshire, Welsh, Irish, and the improved short horns. Doubts, I believe, exist in the minds of some intelligent farmers, whether any improvement has been effected in the milking properties of dairy cows, by the introduction of the improved short horns among them; that the latter breed is much disposed to fatten, is admitted; but this class of cattle does not stand very high in public estimation as milkers; it may therefore be reasonably supposed that there are good grounds for thinking that it is very possible to introduce too much of the improved short horned blood into the dairy stocks, and that great caution should be taken in crossing; however that may be, I am of opinion that an improvement may be effected by the introduction of the blood to a certain extent, care being always taken to select the male animals intended to be reared from the best milkers.

I cannot here refrain from noticing the beautiful and well-selected stock of improved short horns, belonging to Messrs. Forrest of Stretton, near Warrington. Those gentlemen, at much pains and expense, have succeeded in introducing into Cheshire some of the best blood in the kingdom; and they frequently obtain premiums for their stock at the exhibitions of the Royal Agricultural Society. There are, however, in many parts of the county, well selected dairy stocks; and for a great number of years, a slow but gradual improvement has been perceptible in the appearance of cattle bred within it, and they now assume a more decided character of breed, the Holderness or short horns predominating. Though some of the latter breed are alluded to in a treatise by Mr. Wedge, which was published in 1796, they were not then much in favour, as it was thought they were too delicate for wet clay land; but on the introduction of a few *pure-bred* ones from Yorkshire, about thirty-five years ago, or immediately preceding the publication of Dr. Holland's book, they were highly approved by sand land farmers, and soon after were sought for with avidity.

About that time, some of the principal farmers, assisted by some leading cattle dealers, succeeded in establishing fairs at many of the small towns and villages in the interior of the county; and they were so arranged as to give purchasers the opportunity of attending at convenient distances from their farms, and sellers the facility of driving their unsold stock from fair to fair, without any material loss of time, or of the keep of their animals; and many of the dealers had persons engaged in visiting the Yorkshire fairs to make fresh purchases, while they were selling in Cheshire; thus a regular supply of good young milking cows was kept up through the early part of the cheese-making season. Some of the largest and most valuable animals were bought by dealers in milk for the supply of Manchester and Liverpool; but these cattle, from their great size, were not so suitable for the tender clay land, or the very confined farm buildings in the chief part of this county.

The dealers also frequently brought young bulls of from one to two years old for sale in the markets, and it was not unusual for them to receive orders from those farmers who were most anxious to improve their stocks; which orders they were always ready to execute, as they could in such cases make their own charges without incurring any risk. A farmer in the hundred of Eddisbury, who kept about forty cows, and took a pride in having a good dairy stock, thinking the best way of obtaining it was to purchase, instead of rearing from his own, gave a respectable dealer an order for twelve cows—this order was speedily executed for 336*l.*, or 28*l.* per head—probably the whole dairy of cheese would realize little, if any, more than 500*l.*

From the cattle thus introduced at the Cheshire fairs and markets, many of the present stocks were raised. Perhaps the improvement in cattle has been more rapid within the last seven years than formerly, in consequence of an increased emulation having been excited among farmers by the establishment of agricultural societies within the county.

In addition to the cattle bred within Cheshire, many of which are also fed or fattened within it when no longer fit for the dairy, a considerable number of Scotch, Welsh, and a few Irish and Hereford bullocks and heifers are annually bought for the purpose of being fed, principally by gentlemen residing on and farming part of their estates—such cattle, when fat and not required for the use of the family, are sold to butchers for the supply of the surrounding neighbourhood, or sent to the Manchester and Liverpool markets.

### *Sheep.*

Although a considerable number of sheep is fed within the county (estimated at about 65,000), very few comparatively are

bred within it, except such as are sold when lambs to the butchers, and some which are reared from a few choice flocks in gentlemen's parks; of these, the South Down and Leicester are the prevailing breeds. Those fed by farmers consist chiefly of Cheviots (which probably form the greatest portion), Leicesters, Haslingdens, Scotch, and Irish, and occasionally the Anglesea, Carnarvon, Shropshire black face, cluns, and the Derbys, or grit stones, commonly called Woodlands. The usual practice with many farmers is to purchase a few ewes about the month of September, which are kept in the stubbles until ploughed; they are then turned into the cow-pastures, where they remain until the lambing season commences, when they are put into a field of clover or old grass preserved for that purpose; the lambs and ewes, when ready for the butcher, are sold; wethers are seldom kept by the dairy farmers throughout the winter, but are frequently purchased in June or July, and sold off at the latter end of autumn.

A great part of the land in Cheshire is at present much too wet for sheep; but if effectually drained, they would be found a profitable stock, and would improve the soil.

The calculation as to the number of sheep in this county was first made in 1800, and afterwards in 1837, in a work from which I make the following extract:—

“The river Dee, on the north-east border of Flintshire, divides the principality of Wales from England; and the river being crossed, Cheshire first presents itself. This is by no means a sheep district; the flocks bred in the county are comparatively few, and they are of all kinds, from the Welsh mountain sheep to the Leicester; those which are grazed for home consumption are much of the same character. The Leicesters and the Cotswolds, and the Cheviots however prevail, and with every variety of cross; but as they are mostly brought into the county for this purpose, they afford only skin-wool, and are not to be taken into account, when the character of the sheep and the fleece is inquired into. The sheep that are fed on the heaths and commons of Cheshire are short-woolled; but the fleece is gradually increasing in length and weight as elsewhere. The only variety worth particular record is that found in the forest of Delamere, on the high grounds in the eastern parts of the county; they have black, or brown, or grey, or spotted faces and legs, and usually small horns. They are not unlike a diminutive Norfolk. They weigh about 8 or 10 lbs. per quarter; the meat is as good as that of other small breeds, and the wool is short and particularly fine, and weighing about  $1\frac{1}{2}$  lb. per fleece. They are a variety of the true native breed of England. The wool used to be much sought after by the Yorkshire manufacturers of fine cloths, and still bears a superior price, although it is also excluded with the rest from the finer cloths. The Delamere sheep is out of place in such a county as Cheshire. It is capable of a very material improvement, and especially considering the purposes for which wool of this kind is now used. In 1808, Cheshire was supposed to contain 65,000, all short-woolled, the length of the fleece various, and producing 926 packs. The wool is still short, the average weight of the fleece  $4\frac{1}{2}$  lbs., and the number of packs 1218.\*

\* How far this estimate may be correct I cannot pretend to determine.

This increased quantity arises either from the greater number of sheep, which an increasing population requires; or from the increasing weight of the fleece, attributable to the altered mode of management, or to the combined influence of both causes."

Previously to the enclosure (about the year 1815) of Delamere Forest, containing 8000 acres, which were equally divided between the Crown and the adjoining freeholders, it was supposed that 20,000 sheep were kept upon it; it was in fact the great nursery for the county. At the enclosure, the greater part of the sheep were dispersed throughout the country, and most of the commons being also enclosed, very few of that breed are now to be met with.\*

In Delamere Park, the seat of G. Wilbraham, Esq., I have observed a beautiful flock of South Down ewes; this gentleman has lately introduced some rams from the celebrated flock of Mr. Jonas Webb. The number of sheep kept in this park is about 600.

In Lyme Park, the seat of T. Legh, Esq., 1000 sheep are kept, including store ewes and those fed for the butcher.

On some of the driest soils, small flocks of sheep are fed after the Norfolk system of hurdling on turnips, whereby the land is much improved; amongst the most important, are those on farms at Delamere and Haslington; on the former, which is a hilly district, guano has been used at the rate of about 3 cwt. per acre, and the result has been highly successful.

### *Pigs.*

The breeding and feeding of pigs are carried on to a considerable extent in this county; but from the great variety of crosses, it would be difficult to determine to which class the prevailing breeds belong; it must however be acknowledged that during the last few years they have been much improved; for, instead of the large-eared, coarse-boned pig, which was valued so highly on account of the enormous size to which it attained when fat, is now to be seen a fine-boned animal, with smaller ears, great length of body, width of shoulders, and roundness of carcase, with aptitude

---

By the first calculation in 1808, the wool averages more than  $3\frac{1}{4}$  lbs. per fleece, and by the second  $4\frac{1}{2}$  lbs., which appear rather high estimates, when the average of the forest sheep at only  $1\frac{1}{2}$  lb. is taken into account; but supposing this calculation to be correct, and the weight of wool the true criterion as to the number of sheep shorn in the county, I should presume that many more than the numbers stated are kept; as many flocks are brought from distant counties, after they are shorn, and having been fed here, are again sold off when fat.

\* The Crown land is planted with a variety of forest trees, as oaks, larch, Scotch firs, &c., the greatest part of which are in a very thriving state: the other portion has been marled, and is in a high state of cultivation.

to fatten at an early age. These pigs probably do not make such heavy weights as the former kind, but they possess the advantage of becoming fat in much less time; their bone is lighter, and the flesh not so coarse; they are therefore more approved of by the consumer. The county is to a certain degree indebted to the coarser breed, formerly in favour, for the great length of frame which many of the present pigs exhibit; as undoubtedly those best adapted to the purpose of the farmers were raised by crosses from that breed with the Berkshire, Leicestershire, &c. The more delicate sorts, as the Chinese and Neapolitan, although much approved in gentlemen's families, with a slight cross of some of the more hardy breeds, are not suitable, unless *repeatedly crossed*, as a general stock for this county; being too tender for the ordinary treatment, and too light when put into the scale: it is a common phrase here, "when we have done weighing, we have done receiving." The practice with regard to feeding pigs on the generality of dairy farms is, to put up early in the spring some strong stores of twelve-months old, to feed on the offal of the dairy; the number being regulated by the probable supply of food—about one to five cows, allowing for breeding sows and young stores. If the farmer is anxious to bring them early to market, a few potatoes, and a small supply of barley or other meal, are given; but in general they have little else than whey for the first three months, when they are allowed potatoes or meal, or both, for five or six weeks, and are then sold to the butcher for the Manchester, Birmingham, or other markets; the weights ranging from 10 to 14 scores. As soon as the pigs feeding on whey are cleared off, which is usually in August and September, more are put up; by this time the whey is much reduced in quantity, the pigs must therefore be fewer in number, or the allowance of corn, &c., greater; some, or perhaps the whole, of these are kept for the use of the family. The sows farrow twice a-year, bringing their first litter in February, and their second in August; the first are usually kept as stores for the farmer's own use, the latter are sold off when young.

#### *Rearing young Cattle.*

More attention has been paid to rearing young cattle of late years than at the time of Dr. Holland's publication, and there is still room for much improvement in this respect. The treatment of calves, previously to being turned out to grass, is nearly the same as formerly, except that some farmers substitute crushed oil-cake, or linseed-meal, for oatmeal, wheat, or bran-flour, at the rate of 1 lb. per day for each calf; and, occasionally, a few slices of mangel-wurzel or swedes are given, after the calves are weaned from the cows to the time at which they are turned out to grass. At

the period before referred to, very few turnips or other succulent roots were grown, and the yearling calves had seldom anything given to them except a little hay; occasionally a small field of old grass was reserved for them, and the second winter they were fed entirely on straw: this method of treating young cattle is too much practised even at the present day, but many farmers have recently adopted an improved mode of feeding—when very young, before going out to grass, the calves are taught to eat sliced turnips, mangold-wurzel, or carrots mixed with crushed oats; they are taken up at night about the latter end of October or early in November, and have hay, and as soon as their pasture becomes short, sliced turnips or mangold-wurzel, and a few crushed oats are given; they are generally turned out to some early grass in April. Some few farmers, who make a point of rearing their first-dropped calves in February and March, allow their heifers to come into profit when little more than two years old, about the middle of May; but when this is the case they are kept very well the second winter, having hay, turnips, and a little corn, and they are put into a good pasture early in the spring: generally speaking, heifers do not come into profit before they are three years old. The number of calves reared on a dairy farm is in the proportion of 5 to every 20 cows, taking care to select those from the best milkers. But it is too much the practice with many farmers to feed all their *first* calves *indiscriminately* for the butcher, with the view of selling them while veal is fetching a good price, and to take their chance as to what may hereafter come for rearing. This management frequently ends in disappointment, and late rearings seldom or ever grow up such fine cattle as early ones—*i. e.* when after a certain period they are all treated alike, as is the case in Cheshire.

The food for the calves\* is prepared in the following manner: about half a pound of meal for each calf is put into a tub, scalding water or whey is poured upon it, and well stirred, skimmed-milk and fleetings are then added; about four quarts are given to each calf twice a-day, until Midsummer, when they are gradually weaned.

It may perhaps not be out of place to state here that the prevailing epidemic among cattle has proved a great drawback upon the resources of the dairy farmers. In some instances as many as twenty and thirty, and even sixty cows have died on one farm from this destructive disease. Where this has been the case, the places of the dead cattle have been cautiously supplied by fresh stock, from fear of further losses; farmers preferring to increase the

\* A recipe for disordered bowels in young calves:—2 drms. rhubarb, 2 oz. castor oil,  $\frac{1}{2}$  drm. ginger, mixed with a little warm milk or gruel. The dose may be repeated in a day or two, if required.

number of their sheep. I have reason to believe that the epidemic is now abating in virulence; and, in order that losses from this cause may not fall with so heavy a pressure upon those individuals among whose cattle the mortality may rage, insurance clubs for mutual protection have been established among the farmers.

I subjoin a few of the opinions of my correspondents relative to cattle, &c.

From the Hundred of Nantwich:—

“The dairy cows here are a mixture of various breeds, a cross between the Durham and short-horn being more general than any other. The breed of the old long-horn Cheshire cow is become almost extinct. But few sheep are kept in this neighbourhood, and those of a coarse breed, the common black-faced Cheshire; they are very prolific, bringing two, three, and sometimes four at a birth; but they will never fatten.”

From the Hundred of Wirral:—

“No particular breed of cattle can be said to exist in this district: milk being the main object of the farmer, he does not consider any thorough-breed particularly advantageous for that purpose; and I believe it has been stated with truth, that a cross between the old long-horn, short horn, and Welsh cows is considered a good sort for the dairy. In some very particular spots of really excellent land, the pure short-horn and the large Yorkshire cow have been introduced with success; but some farmers object to them, as too delicate to stand out in this wet climate. *Sheep*.—Scarcely any sheep are kept where the dairy is the main object; in some instances the farmers buy a few Anglesea or Scotch widders to eat up their stubble land in autumn; but the custom seems to be attended with doubtful success in most cases, and few make it a general rule to have sheep. The Delamere Forest and Clunn Forest sheep are sometimes to be met with in small numbers, but they are not regularly bred in the district. *Pigs*.—Whatever may be said of the native breed of pigs, a very great improvement has been effected of late years in this class of animals. They seem to be of the old Berkshire breed, with, in many instances, a cross of the Chinese; which, when judiciously managed, will give compactness and aptitude to fatten. I should say they are inferior to none in any county of England.”

From the Hundred of Broxton:—

“The description of cattle fed in the Park here is for the most part Scotch oxen; but some handsome short-horns, from Mr. M'Gregor's prize bull, have lately been reared, and they seem to do very well. The feeding is made a two-years business, and cannot therefore, I think, be quoted as an example. *Sheep* do not answer in the Park, they go lame from foot-rot, through the wet.”

From the Hundred of Eddisbury:—

“The cattle here are not very good generally; a few are now crossing with the short-horn breed, which is found to improve their stocks. In *pigs*, I prefer the Neapolitan, crossed with the large breed (the short-eared kind); I then get a large pig with small bones, and one that will feed at any age. This I consider the best sort.”

From the Hundred of Bucklow:—

“The greater number of cattle kept here consists of fully half-bred short-horns, which are believed to be the best for profit. I am of opinion that



the half-bred short-horn, from a cross by the best Welsh breed and Holderness, is preferable to the cross of the Lancashire long-horn and Holderness: and, generally considered, it is much better adapted to the land. But the most profitable cows I have seen were a mixture of the Guernsey and pure Durham breeds. Great improvements have been effected in the breeds of *pigs* since the publication of Dr. Holland's book; those now considered the most profitable, and the most in use, are a cross of the Berkshire and Shropshire—the ears a little pendent over the eyes, the bodies lengthy, not stunted, or too compact in make. But, of course, there are still amongst us many mixtures of breeds.”

From the Hundred of Macclesfield:—

“Very few *sheep* are kept here, it being considered that in summer they injure the cow-pastures: some are kept for winter pastures by the farmers to serve the Derbyshire flock-masters.”

### *The State of Drainage in Cheshire.*

Having made a very extensive personal survey of the county, and taken into consideration the nature of the soils which predominate, I have arrived at the conclusion that, although on many estates a considerable extent of draining has been effected within the last few years, and some excellent specimens of this desirable operation are now in progress, the drainage is lamentably defective, there being very few farms which do not require it; and it is obvious that where the landowner does not give liberal assistance, it is (with some rare exceptions) totally neglected. These remarks do not apply so much to those lands which abound with natural springs (and in which cases one drain, rightly placed, will sometimes effectually answer for several acres), as to the clay and meadow lands, on the latter of which so high a value is set. Much of the clay-land is of so tenacious a quality that the only possibility of materially improving its value is by thorough-draining. Where land of this description has not been formed into large high butts, it appears to me, and it is also the opinion of many practical men with whom I have conversed, that the butts should be formed to the width of about 6 yards, with an elevation of 1 in 12—3 inches to a yard—from the rein to the centre, and drained down each rein: this exactness in making the butts may not be so essential in arable land, but in pastures, where there are large stocks of cattle, the soil in very wet weather (unless there be a little descent for the water) would soon become poached, and much damage would be done to the grass. On some of the best clay-land, if it have a tolerable slope, I do not consider thorough-draining necessary; particularly if it be kept much in pasture, and the butts be well formed. An implement is used in some parts of the county for the purpose of draining this kind of land; and if taken along the reins once every winter, when the land is in a moist state, it effectually answers the object of its construction. It consists of a sharp-edged wheel, fixed in a

frame with a sliding box over it (as shown in drawing No. 1, p. 110); and, instead of throwing out a furrow, as was formerly the custom, it makes the drain by pressure sufficiently deep to admit of a free course for the surface-water: this implement requires four horses to work it; and it will water-furrow from 15 to 20 acres per day. On much of the pasture-land the butts are too small and flat, some not more than 5 or 6 feet wide, the reins only serving as reservoirs for supplying the rushes with water, instead of acting as drains to the land. Large portions of the natural meadow-land, consisting of many thousand acres, are deprived of half their value by an obstruction to their drainage, occasioned by corn-mills backing up the water to a considerable extent in streams where there is very little fall; and by the consequent liability, from the same cause, of having the hay swept away by floods, or so injured as to render it unfit food for cattle. This evil therefore calls for serious consideration in any inquiry connected with the agricultural pursuits of a dairy district, where the clay-land farmer is almost entirely dependent upon the produce of his meadows as a winter supply of food for his milking stock. The summer and autumnal floods, before the after-grass is eaten off, occur at least once in three years, and are frequently attended with almost ruinous consequences to the farmer; for, in addition to the entire loss of his hay occasionally, his cattle become diseased, and not unfrequently die from eating flooded hay. On the river Gowey there are no less than twelve mills on a distance of about 15 miles; it is therefore obvious that the individual efforts of the landowners, and the united exertions of the occupiers, will avail but little in attempting to effect a complete state of drainage, unless the proprietors of the farms collectively join in removing these impediments, and converting the present water-mills into steam-mills.

Effectual draining being the greatest of all improvements, and also an expensive operation, it is of importance that the work should be well executed, in order to make it as permanent as possible; in addition to the drains being cut in the right direction, and of proper depths, care should be taken to have the bottom of the drains, where they are not on a solid bed of clay, marl, or gravel, sufficiently firm to support the tiles, by a layer of soles of the same material, slates, or split alder, and close enough to prevent moles and vermin from getting into them; the tiles also should be of a good material. In cutting drains for the purpose of carrying off the surface-water only, the bottom is generally found with a sufficient appearance of firmness to support the tiles, particularly if the drains are formed in dry weather; but it should be borne in mind that by draining the water is drawn to those parts where water had never reached before, and, by constant

moisture, a clayey substance will become too soft to support the narrow edge of a tile for any length of time, where there is a pressure of from two to three feet of soil upon it. I have lately seen drains taken up as being perfectly useless; in some instances owing to the tiles sinking—in others, to the tiles decaying (which will be the case when not made of good material, and properly burnt), and in others, to the moles and other vermin filling them with soil.

There are many manufacturers of tiles in the county: there are three on one estate in the Hundred of Broxton—the Tweedale and several other works along the Ellesmere and Chester Canal—and, in addition to many others which might be named, there is a manufactory on Ridley Hall farm, in the Hundred of Eddisbury, where the best I have seen were made. In the year 1829 I had to send twenty miles for 1000 tiles for which I had occasion: they were charged 45s. per 1000, and were so badly burnt that one-third of them were broken in the carriage. Tiles of the same size, and a good quality, are now selling at from 25s. to 30s. per 1000.

In one instance, which has come under my notice, half the value of the tiles is charged by the landlord to the tenant: this charge certainly gives the tenant a pecuniary interest in them; but whether such a regulation will materially contribute to the object in view, viz., a more extended and perfect state of drainage, is very doubtful. On one estate in the Hundred of Broxton, the agent (whose zeal for improvement is highly commendable) under the direction of the noble proprietor, employs a number of drainers regularly throughout the winter months, to perform the work for such of the tenants as may require it, charging them with about two-thirds of the expense. This plan ensures a better system of draining than if done by persons who have not had the advantage of practice, and who, therefore, do not possess much skill in this most useful art. On this property there is a very ingenious, and, I may add, humane contrivance, the invention of the gentleman alluded to: it consists of a portable house, on low wheels, which is removed, as occasion requires, from farm to farm, and from field to field, for the purpose of affording shelter to the drainers during rainy weather, comfort during meal-times, and a safe deposit for the tools, when the men are not at work. I have been informed that, by this contrivance, the men are enabled to proceed with their work during showery weather, with very little loss of time; when otherwise they would frequently, on the first fall of rain, proceed to a beer-shop, and lose the remainder of the day.

The following extracts from letters, with which I have been favoured, will afford additional information upon this important branch of agricultural operations:—

## From the Hundred of Bucklow :—

“Draining since 1808 has increased one hundredfold; and, instead of using (as was the custom then, and till within the last few years) kils, sods, stones, and red sandstone, the materials now worked up are blue or red tiles, under which, unless the bottom of the drain be hard and likely to stand good, soles of alder-wood or thin blue slates (which are most approved of) are placed, one at each end of the tile. The drains are cut from 8 to 10 yards apart, a little further or nearer, as the gouty nature of the land may require.”

## From the Hundred of Eddisbury :—

“A good deal of draining has been done within the last few years; but there is yet much more to be done. The work is much better executed than formerly, and is chiefly laid with draining tiles upon slate.”

## From the Hundred of Wirral :—

“Rapid strides towards improvement in this branch of husbandry have been made within the last six or eight years; but, from the tenure being yearly, the credit or discredit (as the case may be) should rest entirely with the landlord. Where estates are unincumbered, and the owner of the estate has a wish to promote his own interest, as well as that of his tenant, much good has been done by tile draining; but very much yet remains to be done, both upon arable and pasture lands. About one-thirtieth part of the district has been drained within the last twenty years: this seems a small proportion, but I believe it will be found nearly correct.”

## From the Hundred of Nantwich :—

“A great improvement is yet to be made in this neighbourhood by proper drainage. The tenantry are allowed a limited quantity of tiles yearly, which they are expected to put down at their own expense; but this they gladly do, having discovered the benefits arising from this process.”

A correspondent in the Hundred of Broxton supplies the following particulars :—

“Lord Westminster’s estates in this neighbourhood (except much of the townships of Aldford, and the two Churtons, and the meadows) consist very generally of a *clay-soil*, varying in depth, quality, and tenacity, resting upon a few inches of an unwholesome rammel, under which is a stiff marl sub-soil. The discharge of superabundant *surface-water* is here the object of draining. No springs or uprising waters are to be contended with, nor is the soundness and regularity of the ground often interrupted by boggy places or sand-pits. The bulk of the land has long lain in butts, or looms, of a width from six to nine yards, perhaps averaging about seven: these butts cannot be much altered in form or direction without injury to the farmer. Most of the land is saturated with rain-water all winter, so much so that in undrained fields a hole dug will usually fill within a few inches of the surface, and so remain: and in a hot summer the ground will bake to the hardness of an unburned brick. This is the character of the worst parts (*i.e.* Belgrave and Pulford), but the description applies in a great degree to most of the estates. Under these circumstances the system of draining is simple, and almost uniform. A drain is laid down each rean, or furrow, between the butts or looms, falling into a main, which crosses the lower ends of the furrow-drains at right angles, running parallel with the fence from which it is separated by the headland.

“One million tiles a year are now made and used on this property: that number will lay 190 miles of drain, and drain 500 acres.”

*Implements in Use.*

In this county, where the arable land is limited in extent, the variety of implements applied to agricultural operations is perhaps not so great as in many other districts; within the last ten years, however, some of a superior description have been introduced, among which those particularly deserving of notice are the iron ploughs, the subsoil-plough, the Uley-cultivator, Finlayson's harrow, the twin-harrow, various iron harrows, turnip scarifiers, corn-drills, hay-making machines, a furrow-presser, and an improved instrument for water-furrowing clay-land pastures. The iron ploughs, which were scarcely known in Cheshire ten years ago, are now in general use in the best farmed districts. They principally consist of those manufactured by Wilkie, West, Harks of Mere, and Wood of Knutsford: the two former Scotch, the latter two Cheshire. Wooden ploughs of an improved construction are also employed on the southern and western sides of the county, each district having its favourite. Ploughing with two horses abreast is now almost invariably the practice, where the iron plough is used; except in very wet soils, and then three horses in length are employed.

Among the scarifiers or cultivators now in use, in addition to the old clumsy ones, which are almost entirely discarded, are the Uley, Finlayson's, and one of a very useful kind, which is made of wrought iron, is most effective in its operations, and from its simple construction not liable to get out of order: it requires four horses to work it on light land, and five on the heavy soils. It may be put to any depth required, and is regulated by chains attached to a frame (as per Drawing No. 2). This implement was originally brought from the county of Stafford, but it has been much improved by a common blacksmith in the Hundred of Eddisbury in Cheshire.

The Uley cultivator has only been introduced very recently: one gentleman in the Hundred of Broxton speaks highly of it, and generally uses only two horses in working it.

Finlayson's harrow, from some cause or another, is not in such good repute as when first introduced.

It is too frequently the case, that when inventors have at much pains brought an implement to something like perfection, and have exhibited good specimens at an agricultural meeting, they become careless about the manufacture of them; and with a view of offering a cheap article to the public, and at the same time securing a certain profit to themselves, they have a number made by piece-work, which is often indifferently executed, and bad iron or other material is used; but being neatly painted before sent out, the defects are not discovered until put to its destined opera-

tions in the field, perhaps fifty miles from the place of manufacture. It would be well if some means were devised for testing implements before they are sent out, as such a practice would not only be a check upon the men employed in their construction, but the result would be more creditable to the manufacturer, and certainly much more satisfactory to the purchaser.

Turnip scarifiers are much improved: those most in use are made by Harks of Mere, and Wood of Knutsford, nearly all of which are of wrought iron, and are worked by one horse to each, except in extreme cases.

Extracts from letters relating to implements:—

From the Hundred of Eddisbury:—

“ Implements have been much improved within the last few years, and several new ones have been introduced, viz., Scotch iron ploughs, grubbers, scarifiers, and harrows made on a better plan, by giving more room between the pins: with such implements as these the land may be much more efficiently worked than with the old wooden ones; but yet some of the farmers persevere in the use of the latter.”

From the Hundred of Macclesfield:—

“ I have of late years tried the subsoil plough, and with good effect.”

From the Hundred of Bucklow:—

“ Iron ploughs are coming very generally into use, from their superior work. Ploughing abreast is getting into favour, because a driver is saved, the horses travel better together, are nearer to their work, and perform it more effectually. Horses only are used in drawing, no oxen.”

From the Hundred of Wirral:—

“ Implements vary in almost every parish of this district. The plough varies in size, shape, and make, just as the located wheelwright fancies it pleases his customers by new shapes or sizes of implements. Little can be said in praise of any I have seen, and little will be said till the ploughman can do his day's work without a *driver*.”

A second correspondent from the Hundred of Eddisbury says—

“ Upon the clay-lands it formerly excited no surprise to see four horses drawing a plough, and even now three are commonly used; but these practices are giving way to the use of the plough drawn by two horses abreast; and, with a few necessary exceptions, I have no doubt that in a few more years Cheshire will be entirely cultivated with the ‘two-horse plough,’ which prejudice among the older farmers has hitherto, in many cases, prevented. Probably to the limited state of drainage on the clay-lands of this county, may be attributed in part the neglect of the ‘two-horse plough;’ for where the soil is so much saturated, it becomes so very adhesive, that it is as laborious for three or more horses to draw a plough on such land, as for two horses on the same soil when well drained.”

There are a few corn-drills in the county, but at present their number is very limited: the Suffolk drill, with eight coulter, and worked by two horses, is most in favour.

Several lay-making machines have of late been brought into the Hundred of Eddisbury. They are worked with a single

horse, which is changed occasionally if the weather be hot: they are much approved of, especially in thinly populated districts, where hay-makers are scarce. The furrow-presser, although a very useful implement when the furrows are not well closed, is not in common use, and is perhaps not so much required since the introduction of iron ploughs.

The implement for water-furrowing clay-land pasture is worked by four horses, and is found useful where under-draining is not required; it makes an opening along the rein by pressure, sufficiently deep to carry off the surface-water; and on land where the butts are six yards wide the work performed will be little less than twenty acres per day. Fixed thrashing machines (some of them worked by steam) are pretty general among the principal farmers; and the portable ones are in very extensive use: the latter are let out on hire at 15s. per day. Knife and spike rollers are also in common use, and continue in deservedly high favour.

#### *Horses and other Cattle employed in Husbandry.*

Many of the best farmers adopted several years ago the system of ploughing with two horses abreast, except on very wet soils; and as the clay-land becomes drained the practice will no doubt be extended; and nothing will tend more to promote such a result than the annual ploughing matches in different parts of the county, where competitors are not allowed to plough in any other manner.

There are some farmers, in every district, whose prejudices are so strong in favour of old customs, that the most decisive evidences of improvement will never induce them to step out of the path they have previously followed; and such will no doubt continue to plough with three horses, and even four, in length, to the end of their days. Oxen are not used in Cheshire as beasts of draught: they were tried by some gentlemen a few years ago, but the practice has been abandoned.

There are seldom fewer than five horses used in the subsoil-plough, and four or five in the different kinds of cultivators: two in the light harrows for ordinary purposes, and three in the larger; but when land is very rough, and requires what is termed the "ox-harrow," four or even five stout horses are employed. In many of the fixed thrashing-machines four horses are used, but in the portable ones, which are always in great request after harvest, five or six are required: these machines, when the corn yields well, will thrash 150 or 200 measures of wheat per day.

The horses in Cheshire are not so heavy as formerly, but are considered more generally useful for farming purposes.

A correspondent from the Hundred of Macclesfield says—

“That the number of horses kept by the farmers in that district is in the proportion of three to eighty acres of land.”

In the Hundred of Eddisbury:—

“It has been estimated that there is one horse kept for use in husbandry to every thirty acres.”

A gentleman in the Hundred of Broxton has recently fitted up an apparatus for steaming food for horses. He says—

“The steam range cost 14*l.* 7*s.* 5½*d.*; to this must be added the charges for bricks and mortar, fixing the boiler, and the bricklayers' time, which will make the total expense about 15*l.* 10*s.* I had great difficulty at first in getting the men to use the steamed food. I steam both the cut hay and straw and potatoes; 16 lbs. of cut hay and straw, 8 lbs. of steamed potatoes, 7 lbs. of crushed oats, and a few white Belgian carrots, making about 30 lbs. of food, are divided into three servings, which are the allowance for each horse for 24 hours. My horses never looked better.”

#### *Tenures of Farms.*

With very few exceptions the farms in Cheshire are let from year to year, terminable, as to the land, on February 2, and as to the house, buildings, garden, and an outlet for the cattle (which is generally contiguous to, or most convenient for, the buildings), on May 1. Where leases are granted they are seldom for longer terms than 7, 11, or 14 years; some at a fixed rent, others regulated by the price of grain, at what is called a corn-rent, and others by that of wheat and cheese. However desirable it may be to secure to the landowner a fair annual rent for his estate, and its surrender to him in as good condition at the expiration of the occupancy as at its commencement, it is equally desirable that a tenant, who possesses skill, industry, principle, and capital, should have secured to him, as far as the nature of the case will admit, a fair return for the labour and money employed; and, to ensure these results to both parties, probably a lease of 14 or 21 years, on equitable terms, and with proper restrictions, the amount of rental to fluctuate according to the prices of agricultural produce, would be most likely to answer the purpose. But here a question arises, would the average price of grain, or of cheese, or of both, extending over a given period, be a sufficient guide to regulate the rent of a *dairy* farm? It is the opinion of some intelligent men that, as the article of cheese varies so much in quality, and consequently in price, and as there are no means of obtaining a fair return of the averages, it could not be satisfactorily taken into the account; but as there are no similar difficulties with regard to grain, wheat may be safely taken as a guide even on a dairy farm, if the estimates be not calculated from too long a period, as it seldom happens that *any* description of farm produce continues high for any length of time, while other produce is low, and *vice versa*; although it is very possible that, from some particular



influence of season, or other causes, cheese may be high in price when wheat is low; or the latter may be high when the former is low; but this disparity will in all probability continue but for a short time, as I find, by reference to the prices for the last 12 or 14 years, they have nearly kept pace with each other.

The usual time for giving up possession of arable lands (February 2) is frequently attended with great inconvenience to the in-coming tenant, and is of little or no advantage to the out-going one. It has therefore occurred to myself, and my opinion is confirmed by the judgment of many practical men, that the 1st of November would be the proper period for giving up clover roots (where the retiring tenant is allowed the cost of the seed) and all tillage-land, except that sown, or intended to be sown, with wheat; and some consider that March 25th would be a more convenient time for quitting houses and buildings than May; but, having given the matter a careful examination, I feel convinced that the advantage to be gained by taking possession of the house, buildings, &c., at that early period, would be more than counterbalanced by the inconvenience to which the farmer would occasionally be put, by removing his stock to a farm where but little fodder had been provided, and without any prospect of being enabled to turn his cows to grass till after a lapse of five or six weeks, and having left at the same time on the farm he has given up an ample supply of provision, which, according to agreement, must be consumed on the premises; one-half or two-thirds of its value only being allowed by his successor.

Upon this part of the subject I quote the following statements and opinions, with which I have been favoured by my correspondents:—

From the Hundred of Eddisbury:—

“The tenures on which farms are held in this neighbourhood are those of yearly occupation, but I am of opinion that leases would be better for the farmer, whether at a fixed sum, or regulated by a corn-rent: the latter I should prefer, as the fairest arrangement between landlord and tenant.”

From the Hundred of Macclesfield:—

“We have very few leases or agreements for terms of years in this district; but many of the farmers have lived long upon their farms, having succeeded their fathers in the same occupancy. I think, however, it would be better if we had leases.”

From the Hundred of Wirral:—

“Yearly tenancies are most prevalent here. There are some instances of leases for 7, 14, and even 21 years, and, where these have been granted, the tenants certainly appear more industrious and improving, and landlords more generous and liberal. The good feeling, which is said to exist between landowners and yearly tenants, has been strengthened by the granting of leases.”

From the Hundred of Nantwich:—

“The present time of entering upon a farm is very inconvenient, and attended with much loss to the in-coming tenant. Possession of the land should be had on November 1, and of the homestead, &c., on March 25, a fair allowance being made for fodder left unconsumed on the premises, and for any improvements which the retiring tenant has made, and of which he has not reaped the benefit, some return should be given by the landlord.”

Another correspondent from the Hundred of Nantwich says—

“The property for which I have the honour to be concerned is principally held under agreements from year to year, although there are several instances where leases have recently been granted for fourteen, seventeen, and even twenty-one years. The conditions of our agreements, which, I believe, generally speaking, are similar to most others in this division of the county, run as follows, viz. :—

“Tenancy commences at Christmas as to the mowing lands; on the 2nd of February as to all the other lands, except the boosey pasture; and on the 1st of May as to the homestead and boosey pasture: timber, mines, and game reserved. Tenants to keep premises in repair, except in cases of fire or tempest: landlords finding timber in the rough, bricks, lime, and slates, and first putting the premises into repair. The fodder to be consumed upon the premises, or the money to arise from the sale thereof to be expended in bones or other manure to be applied upon the farm. The permanent mowing and pasture lands, *which have been boned by the landlord*, are reserved from tillage. One-fourth is allowed for tillage, including fallows; and the tenant is not allowed to take more than two white straw crops in succession, without either a green crop or summer fallow, and to lay down with a certain quantity of artificial and other grasses; together with a variety of minor stipulations, which of course vary according to circumstances. A difference of opinion exists as to the desirableness or otherwise of granting leases, and a good deal may be said both for and against the practice of doing so. I by no means think that it is politic for any gentleman to make a practice of granting leases indiscriminately to all his tenants, because it must be admitted that it is not safe or prudent, on many accounts, to part with the control over his property, and to commit the charge of it so completely to the care and mercy of *every* man for a term of years; but at the same time, when a gentleman has a tenant possessed of capital, enterprise, skill, and principle (for I think the latter qualification quite as necessary as any of the former), and that tenant comes forward with a spirited proposition to improve the property, I think there can be but one opinion that it is for the interest of both landlord and tenant to have a lease; but whether a lease be granted or not, I am perfectly convinced that nothing tends so much to promote the success of agriculture, and the general good of the neighbourhood, as the best possible understanding between landlord and tenant, and a perfect confidence in each other. There are, I think, few connexions of a more important and interesting character than that of landlord and tenant. The landlord commits his fee-simple and inheritance into the hands of his tenant, which, to a certain extent, is at his mercy, and may be either materially improved or injured (in spite of any written document) by his treatment of it. On the other hand, the tenant is indebted to his landlord, to a certain extent, for many of the comforts he enjoys; and so dependent are they upon each other, and so reciprocal are their obligations, that if I were asked whether a tenant was most indebted to a good landlord, or a landlord to a good tenant, I should be puzzled to give an answer. At all events, this

connexion is of so delicate a character, and the harmony of it so essential to the prosperity and happiness of both, that it ought on no slight grounds to be disturbed."

*Rate of Wages.*

The rate of wages varies in different districts. On the north, north-eastern, and north-western sides of the county, especially in the vicinity of manufacturing or large towns, wages are nearly 20 per cent. higher than in many parts of the interior, or in the south, south-western, and south-eastern districts. In the former, there is a greater demand for labour, while cottage-rents and provisions are higher than in the latter: a better rate of wages is therefore required. The average amount, in the former case, will be about 12s. per week; and in the latter about 10s., including harvest-work. A reduction has lately been made in some instances, during the winter quarters, from 9s. to 8s., but this is not general. Many of the labourers in the latter mentioned districts have peculiar advantages. The rent they pay for a comfortable cottage and garden is about 50s. per annum—seldom more than 3*l*. They have also an acre or two of land at a moderate rent, and are thereby enabled to keep a cow; and they have very frequently the privilege of cultivating potatoes on the farm where they are employed—the farmer manuring the soil, and doing all the necessary team-work, including the cartage of the potatoes to the cottages of the labourers, who on their part find the sets, hand-hoe and dig up the crops, and leave one-half of the produce in lieu of rent, &c.

There has been little, if any, reduction in the wages of servants hired for the year.

The wages of head-waggoners	range from 10 to 12 guineas per ann.
"    under-waggoners	"    8 " 9
"    boys . . . .	"    3 " 4
"    dairy-maids :	"    12 " 20 (according to circumstances).
"    under female servants	"    6 " 8

A correspondent in the Hundred of Eddisbury says—

"Wages for labour vary according to the localities. In the immediate vicinity of large towns, and not unusually in the neighbourhood of smaller ones, wages are higher than in the more rural districts; and this disparity is very obvious in the summer months, even at times of commercial depression. I have observed that for 15 miles round Malpas (say 5 on the Chester side), the rate of wages is lower by at least 6*d*. per day than within the same distance of Northwich, and other towns on the north side of the county. These remarks refer to married labourers; but the same observations will apply to farmers' servants, male and female. Of the latter, in many parts of the county, there is a great scarcity, partly through the facility of obtaining situations in towns, and partly owing to additional numbers being required in consequence of improvements on the farms; for where a reasonably liberal encouragement has been given to tenants

by extensive landowners, immense sums have been expended in bonemanuring and draining, principally on permanent pastures, whereby, in many instances, the dairy stock has been doubled in numbers, and consequently more female servants are needed. For the three years preceding June, 1842, as much as 1000*l.* per annum was expended in these improvements by tenants here."

Having now treated of the different heads of inquiry specifically noted in the Society's proposal for this Essay, I may here observe that, with reference to the question as to what improvements and alterations have been introduced since 1808 (the date of Dr. Holland's publication), those which appear to call for more particular notice have either been mentioned in the foregoing remarks, or will be described under the separate divisions of the subject upon which I think it desirable to supply some information in the following pages:—

#### *Cheese.*

Cheshire being a cheese district, some account of the process of making this staple article of agricultural produce may reasonably be expected; but the method generally adopted being the same as that pursued at the time of Dr. Holland's publication, and of which he gives so full an account, any statement of mine would only be a repetition of his narrative. I shall therefore merely mention a few improvements which have been introduced in the machinery and offices of the dairy. The first process of breaking down the curd in the cheese-tub is now generally performed by a breaker or curd-cutter (see drawing No. 3, p. 111), the dairy-maid alone walking round the tub, and pressing the breaker slowly through the curd at first, and more rapidly as she proceeds with her work, until it is reduced to small particles, when it sinks to the bottom of the tub. This practice supersedes the old mode of three women kneeling around the tub, and breaking the curd with their fingers. The next improvement is the curd-mill (as per drawing No. 3), which is for the purpose of breaking the curd after being drained from the whey in the cheese-vat, before finally putting it under the press, instead of the old tedious plan of again breaking it with the hands. The greatest improvement, however, yet effected, is by the introduction of a lever-press (as per drawing No. 3), which is self-acting, and may be used during the process of making. This invention renders unnecessary the previous custom of kneeling upon and pressing the cheese with a board, or two or three persons thrusting it with their hands, or pressing it for a time, before placing it under the heavy stone press. The great advantage of this machine consists in its being regulated by a small weight on the beam, by which the pressure upon the cheese can be increased or diminished at pleasure. It is also portable; and as warmth is very essential during the time of

pressing, especially in cold weather, it can be conveniently removed to any warm situation. Artificial heat is now introduced into many cheese-rooms, either by means of hot-air stoves or steam conveyed in cast-iron pipes through the rooms, for the purpose of forwarding the ripening of the cheese. By these means, large dairies, which formerly were scarcely ever marketable before April or May, are now sold as early as October or November.

#### *Manures.*

In addition to the old-fashioned manure from the farm-yard, marl, lime, and bones—all alluded to by Dr. Holland, though the latter at that time were in very limited use—the most important kinds which have of late years been tried in this county, are guano and nitrate of soda.

The manure from the farm-yard, if well prepared by occasional turnings, and if, when carted out into the fields, previously to its being applied to the land, it be properly thrown into heaps, and covered with soil to keep in the ammonia—is considered the best for general purposes; but for pasture-land alone, especially the poorer kind, there is nothing to equal in efficacy “bone manure,” either as regards the permanency of its effects or the production of a sweet luxurious herbage, of which all cattle are fond. Many thousand acres of the poor clay-soils have been covered with this manure during the last eight or ten years, and the results have been truly astonishing. There are two descriptions of bones which are used—the boiled and unboiled. The former sort undergoes a process of boiling for three or four days, by which the grease and nearly all the glutinous matter are extracted. This kind of manure is preferred by many, being much quicker in its operations when applied either to pasture-land or turnips; and nothing has yet been advanced to prove that the durability of its effects is not as lasting as those of the unboiled bones. The average quantity applied is about a ton and a half per acre. The unboiled bones, by means of improved machinery, are reduced to a much smaller size than they formerly were, and from this cause are undoubtedly more speedy in their effects. The manure thus prepared is also in high favour; but as bones in this state contain a portion of animal matter, valuable for manufacturing purposes, though not very essential as a manure, they are invariably sold at about 50 per cent. more than those which are boiled; and it has not been demonstrated that they possess any properties which are more permanent or more fertilizing than the cheaper kind. When bones are applied to pasture-land they are generally paid for by the landowner, the tenant being restricted from breaking up the lands which are thus improved, and charged from 7 to 8 per cent. upon the outlay.

It may perhaps not be amiss to remark here, that on many farms much of the essence of the manure (farm-yard dung) is allowed to escape, owing to the want of proper tanks for receiving it. Of late years, premiums have been offered by several agricultural societies for the construction of such tanks; and many of the more spirited farmers are beginning to turn their attention to this branch of husbandry.

#### *Marl.*

Marling, which was thought indispensable till within the few last years, especially upon the light soils, is now rarely practised. Till very lately the shouts of the marlers were to be heard on fine summer evenings in almost every direction, but now their whoops are seldom raised. It may be said that the reason there is so little marling now is because the greater part of the land has been already subjected to that operation. This remark, to a certain extent, may be true; but from what I have heard and seen, I believe the fact to be that farmers do not like to incur the expense of the process, as light land, particularly for corn, would no doubt *now* be materially improved by it. Marl, like other substances, loses its effect in time, probably not so much from exhaustion of its nutritive powers as from its heaviness—sinking as it does, in the course of a few years, below the reach of a common plough. In dividing a strong sandy loam field, which had been marled fifty or sixty years ago, I found, when cutting a ditch for the purpose of making a fence, a regular stratum or bed of marl entirely across the field, at the depth of 13 inches; and there was no appearance of marl in the soil above. How far this marl may again be made available, by the use of the subsoil plough, I cannot pretend to determine; but I purpose giving the experiment a trial, of which I consider it worthy, and from which I anticipate beneficial results.

#### *Lime.*

Lime is used to a considerable extent in many parts of the county, particularly in the Hundreds of Broxton, Wirral, parts of Eddisbury, Nantwich, &c. It is generally applied to fallows for the wheat-crop, at the rate of 4 tons per acre, either in its natural state or in compost; sometimes to grass-land, previously to breaking up for oats; and occasionally to land intended for turnips. I have seen a mixture of lime and salt applied to turnip-land, but the result was not satisfactory. Last year (1843) I saved my clover from destruction by the slug or small snail, on land bearing a wheat-crop, by a slight dressing of powdered lime, scattered through a clover-seed machine late in the evening, when the insects were busy at work. Lime would be found exceedingly useful, if frequently applied in this manner.

*Guano.*

Many experiments have been tried in Cheshire with this wonderful manure; but from my own observations, and the information which I have obtained from others who have used it, I am induced to believe that it is very uncertain in its effects, especially in dry seasons.

One of the tenants of Mr. Wilbraham, of Delamere House, has applied it to a weak sandy soil for common turnips with good effect. A gentleman in the Hundred of Wirral has tried it on pasture with extraordinary results; the herbage was most luxuriant and palatable to the cattle, and he affirms that the cheese made from them while grazing on the land to which the guano had been applied, was much superior to that made from the cows when feeding on the ordinary pastures, and realized 5s. or 6s. per cwt. more when sold. I tried guano myself in 1842 for my turnip crops, on a cool (or damp) peaty soil, at the rate of 2 cwt. per acre, with an equal quantity of ashes from coal and wood; the field having been previously drained and limed at the rate of 4 tons per acre; and although the weather throughout the summer was exceedingly dry, I had a luxuriant crop of white globe turnips, the tops being more than 3 feet high; but on the crop being taken up, the bulbs proved light; this might in some measure be owing to the rapidity with which they grew in the tops after the first hoeing, and not receiving their second hoeing in time; on a butt where the guano was not applied, the turnips were very inferior. On another field of six acres, one half a sandy loam on a porous subsoil, the other on a marly subsoil (the latter having been drained to the depth of 2 feet by parallel drains 8 yards apart) and the whole sub-soiled to the depth of 14 inches, I sowed Swedish turnips in drills 27 inches apart; manured with farm-yard dung at the rate of 15 tons per acre—part in a rotten state, having been drawn to the field early in the spring, and turned twice in the heap, the other in a high state of fermentation.

I commenced sowing (the seed-drill following the plough as closely as possible) the last week in May, and finished about the 1st of June, depositing at the same time, although not immediately in contact with the seed, 1 cwt. of guano, and an equal quantity of ashes (2 cwt. in the whole per acre); in a few drills gypsum was deposited by the same machine, instead of, and in the same ratio as the guano; and in two drills, exactly similar, the same mixture of guano was applied without any other manure, at the rate of 6 cwt., 3 of guano and 3 of ashes. The seed sown on the last-mentioned drills was four or five days later in making its appearance than on any of the former; my object in sowing with guano was principally to force the young plants out of the way of the fly, at the same time saving a portion of my farm-yard manure; in the first place it certainly had the desired effect, for I never saw turnips grow more rapidly; and those sown first on the part where the rotten manure was applied were a good crop; but all the other part was a light crop, and especially the two drills where guano was applied alone; they were certainly not more than two-thirds of the weight of the latter, which did not average more than 22 tons per acre. The season was remarkably dry, and the whole crop much mildewed; nearly one-third of the turnips were hollow and full of juice like cocoa nuts.

Nitrate of soda was tried in the parish where I reside, in 1840, on grass-land, and with apparently good effect, the grass soon becoming of a dark green colour, and increasing rapidly in quan-

tity; but I have not heard of its application since that period. One extensive farmer in the Hundred of Nantwich applied it in the same year to a wheat-crop; and he stated at an agricultural meeting, that it had been a loss of 50*l.* to him, in consequence of forcing his crop too much into straw.

Upon the subject of artificial manures an intelligent correspondent from the Hundred of Eddisbury thus writes:—

“In the winter of 1836, I laid upon a field of eleven acres 1 ton of boiled bones, crushed small, to the statute acre; the field had not been ploughed for a great many years, and produced a coarse bad grass, which I could only get eaten down during the winter or spring. In 1837 I mowed the field, and had a very good crop with much red and white clover. But in 1838, I had a most extraordinary crop, and perhaps the most extraordinary thing was, that it was an entire mass of wild red clover, I never saw a field of common clover a fuller crop. I continued to mow it for three years longer and had fair crops, but not very heavy ones. I may add, that the field was not then drained, which has been done since.

“Guano I have used for turnips at the rate of 2 cwt., and half a ton of bones to the acre, and I should have had a capital crop of Swedes had not the first sowing been killed, soon after they came up, by the drills having been too much crushed down by the drill in putting in the bones, &c. But I soiled the drills up again, and sowed again, and the last sown did not grow to a great size in consequence of the late sowing, June 20th: the growth was so rapid, that in six weeks the leaves met across the intervals of the drills, and what turnips remained of the first sowing were 12 and 14 lbs., and the whole a very fair average crop; this was on stiff clay land, in 1842. I intend following the same plan; as last year the wetness of the season prevented my getting my land in order. If Swedes are not sown upon my land in May they never get to a good size. The very great advantage of using on my land manures so easy of removal, enables me to take advantage of weather, which the long time required for carting manure from the yard often precludes one from doing. I last year put 2 cwt. of guano per acre on my oats, and had a very fine crop, on one field 9½ acres 260 threaves, and one field of 7 acres, and a poor field, and one part thin in soil on a steep slope 148 threaves. In 1840 I put nitrate of soda on a field of wheat, at the rate of 200 cwt. to the acre; on 300 square yards I put none, and the difference the whole time it was green was clearly seen at a great distance. I had this cut and thrashed separate, and 300 yards adjoining on the same butts separate; that with nitrate produced 35 sheaves, and 125 lbs. of wheat: without, 20 sheaves, 86 lbs. of wheat;

The first at the rate of 27 bushels of 75 lbs. to an acre;

The second „ 18 bushels and 26 lbs. to an acre.

The whole crop was very indifferent and thin (before applying the nitrate) and a poor field, and I consider the crop was throughout as good as the 300 yards I cut against that on which I had used no nitrate. I have also used it on grass lands without any experiments of comparison, but the crop was good; without any precise data to go upon, I think it leaves the land poorer a second year, nor does it improve the after-grass. After all, for our clay land, bone at the present price of 4*l.* 10*s.* per ton is the cheapest and best manure, and will pay well at that price: I hope I have met your wishes, and shall at all times be very glad to communicate any of my experience of farming on as stiff a clay as any in Cheshire; in the year 1840 I grew as fine a crop of Swedes as is often seen in a field, in ploughing of which it was so thin of good soil, that we brought up such as farmers are



seldom willing to turn up; the field was well drained down the furrows, and the drills drawn diagonally across the butts—and the crop yielded 10 cwt. of 6 score to the rood of 8 yards—which was tried in several parts of the field, and they form by no means the heaviest part of the crop; I had 8 acres: I only name this to show what may be done on Cheshire clays, the real nature of which is little known by writers on agriculture in general, and particularly by those who recommend very deep draining, and laying the clay in over the tiles—as when I had only laid rammel on, I have in every case been obliged to remove it to render the drains effective, and even upon ploughed ground, the water will remain at the bottom of a slope some time before it sinks in, much to the injury of the crop.”

Another correspondent in the Hundred of Eddisbury thus speaks of the efficacy of salt as a manure:—

“A neighbour of mine had a quantity of soil which came out of a ditch, and was full of *docks* which are completely destroyed by the application of salt; he put 40 cwt. to the soil, and mixed together six months previously to being spread upon the grass; this preparation he put last January upon three statute acres of land, which were covered with a very useless kind of grass, that cattle would not eat; but a good herbage is now produced, and the land thus dressed looks by far the best part of the field. Ten cwt. of salt is sufficient for an acre of grass land. Salt sown on turnip land and land for wheat previously to sowing, is an excellent manure; lime on light soil 1 cwt. per rood for potatoes, &c., is also very useful, and will bring white clover where none grew before. I have used salt and lime in like manner, upon a piece of ground which I suppose had not been cultivated for a century (if ever), and it is now as good as any part of the field.”

From a correspondent in the Hundred of Northwich:—

“If a few handfuls of *salt* be strewn over the horse manure, immediately on its being taken out of the stable, the ammonia contained in the urine, dung, &c., which is the most powerful part of the manure, having a great affinity for salt, is retained by its application on the surface, and it would otherwise be evaporated. Rock salt is coming into more general use for cattle and sheep; if placed in the field or straw-yard, in large lumps, it has a tendency to keep them healthy. There is a description of salt called Salt scale, which contains about a twentieth proportion of lime, and I think would be more powerful on that account, in retaining the ammonia, if strewn on the top of fresh manure.”

From the Hundred of Wirral:—

“No improvements have been made in this district since 1808, except tile draining, to the extent before mentioned. Bone dusting, marling, and manuring, were quite as well understood in 1808 as they seem to be *here* in 1844; and their increased application, and even draining, have only been practised in instances, where tenants and landlords have both been well satisfied that mutual advantages would arise from such improvements.”

A land agent on the eastern side of the county thus writes:—

“This estate is capable of very great improvement, and would well repay an extensive judicious outlay, particularly for draining; there being scarcely a field on the estate which does not more or less require draining. Bone manure, on strong clay land, has a wonderful effect; this is well known to most Cheshire farmers, but the cost is too great for a tenant at will; it is the practice for the landlord to pay for the bones, and the tenant to cart and spread them, the landlord being paid by the tenant from 7½ to

8 per cent. on his outlay. Bone manure, when paid for by the landlord, is always applied to pasture land, which is not allowed to be broken up, and its effects are very durable, I may say permanent. The land will support an extra number of stock, and the increased quantity of manure thus made upon the farm, compensates for any diminution which time may make in the effects of the 'bone dusting.' A considerable income might be realized from an estate like this, by the difference between common interest, and that which a tenant would gladly pay for such improvement."

From a correspondent in the Hundred of Nantwich:—

"It is, I believe, the opinion of some very experienced agriculturists (unacquainted of course with the clay soils of this county), that bone manure can only be applied with advantage for arable purposes, and that to put it upon permanent pasture land is a misapplication of this most valuable manure, but the most casual observer who has witnessed the wonderful effect produced by it upon the pastures of this county, must be amused at the absurdity, and feel surprised that such an opinion could ever have been entertained. Although unquestionably bones may, and are to a great extent very advantageously used for green crops, and other arable purposes on light soils, yet I contend there is no comparison in the return either to the landowner or occupier between bones applied for arable purposes and those applied to the permanent pasture lands. I have known many instances where the annual value of our poorest clay lands has been increased by an outlay of from 7*l.* to 8*l.* a statute acre, to the extent of at least 300 per cent., or in other words, that the land has been much cheaper after this outlay at 30*s.* per acre than it was in its original or native state at 10*s.*, thereby leaving a return of more than 15 per cent. upon the amount expended, besides the satisfaction of seeing a miserable covering of pink grass, rushes, hen-gorse, and a variety of other noxious weeds (which are generally the offspring of poverty), exchanged for the most luxuriant herbage of wild clover, trefoil, and other succulent and nutritious grasses. The permanency of this manure depends in some measure upon the nature and situation of the land; but I believe it is admitted on all hands that it will under any circumstances continue long enough to render ample compensation for the outlay, and although in some instances a considerable portion of the clover and trefoil may disappear after the first eight or ten years, yet an excellent herbage of permanent grasses remains very superior to what the land originally produced; and in my opinion clay land once well boned will never again produce a bad herbage if kept in pasture. I know some instances where lands which have been boned upwards of fifteen years, still retain a very considerable portion of both clover and trefoil, and I have very little doubt but this will be found to be the case in many instances when sufficient time has elapsed to test it. There are different opinions as to whether the boiled or unboiled bones are the most profitable, some contending that the raw or unboiled bones are the most permanent; others, that the boiled ones have the advantage, inasmuch as they come sooner into operation, and are lower in price. My opinion is, that provided the bones could be obtained as they come from the butcher, or from the carcass without the principal bones being taken out (as they generally are) for boiling purposes, they would be preferable to the unboiled ones, inasmuch as they would, by containing more animal matter spread over more land, be longer in decomposing, and consequently more permanent in their effect; but as it is notorious that the best bones are now taken out for boiling purposes, we only get the refuse, and it is very questionable whether the boiled bones, even after the gelatine is extracted (which by the bye some contend forms no part of

their essential quality as manure, and is quite as well dispensed with), are not as good for the purpose of manure as the unboiled ones; at all events, taking into account that 2 tons of the boiled bones can be had for the same sum as  $1\frac{1}{2}$  ton of unboiled ones, I should prefer the former.

“The price of good raw bones now is about 5*l.* per ton, and boiled ones about 3*l.* 10*s.* to 3*l.* 15*s.*: the quantity when land is poor, I generally recommend, is of the boiled bones from 30 cwt. to 2 tons to the statute acre according to circumstances; but where the land is very thin of soil and much exhausted with the plough, I always recommend 2 tons, and nothing less is in my opinion an effectual dressing; but where the land is tolerably good, and the principal object is to sweeten the herbage, I think from 15 cwt. to a ton to the acre is sufficient, and I know an instance where even 8 cwt. to the acre produced surprising effects in improving the herbage. Although I am a great advocate for draining, and am ready to admit that, generally speaking, it is the foundation of most other improvements; yet I think *it may be carried too far* where bones are used upon permanent pastures or mowing, for I have invariably found them to answer best where the land is cool, and even moisture appears to be favourable to their operation, and I believe it is universally allowed that boned lands suffer much by a dry summer; I would therefore only lay the land sufficiently dry to carry stock, and to take away rushes and other aquatics where they exist to the detriment of the proper herbage. Before bones came into use in this county, the farmers made a point of selecting a hardy and inferior description of stock for their clay lands, farmers finding that large well-bred cows did not at all answer upon them; but now they find that the best of stock find ample support, not only to supply the cheese-tub freely, but also to do justice to their lineage by retaining, if not improving, their size and symmetry, so that the farmer has not only the advantage of making considerably more cheese, but also of making more money by his turn of stock. I think bones might be very extensively used, and with great advantage, upon clover roots. The usual practice when a piece of clay land has been tilled to a stand-still, and will answer no longer to the whip, is to clover it down, when nature makes, as it were, a last expiring effort by yielding a crop of clover, or clover and rye-grass, or whatever artificial grasses happen to be sown, which crop is then generally mown off, and this gives the finishing stroke to the miserable existence of the poor field; it then becomes a dead letter for many years to come, an encumbrance to the tenant, an eyesore to the landlord, a subject of remark to the railway traveller, and thereby a disgrace to the county: but if a tolerable covering of bones, say from 20 to 25 cwt. to the acre, according to circumstances, were applied upon the clover, it would not only produce a good crop of artificial grasses, but it would also assist nature in clothing herself speedily with a fine herbage of those natural grasses peculiar to the soil, which only require the friendly aid of some good fertilizer to bring them into existence; and if this plan were pursued, instead of the land lying, as it generally does, for many years, after the artificial grasses have disappeared, in a totally unproductive state, it would form a good turf of natural grasses immediately to succeed the artificial ones, and present a cheerful countenance as well as a profitable return to the farmer, without any check or cessation whatever after the arduous labours of the severe tillage. I think bones might also be most beneficially applied upon permanent mowing ground (of course I am speaking all the while of clay soils), in which case the farm-yard manure might be taken for the tillage lands; and if those were effectually and thoroughly drained, summer fallows might be dispensed with, and some good winter and spring feed provided for the stock in the way of green crops, a luxury with which I fear most of our dairy stocks are as seldom indulged in as the good people

of China are with eating our far-famed Cheshire cheese, both of which enjoyments I hope will become universal ere long. I would in the first instance put upon the lands I intend for my permanent mowing about 30 cwt. to the acre, if old mowing land, or 2 tons if pasture land; and after mowing it for four or five years, if I found the grass begin to get shorter, I would repeat the dose by adding another ton to the acre, and so on every four or five years, by which means the hay crop would no doubt become not only very abundant, but of very superior quality, and the value of the green crops alone would, I contend, more than provide for this outlay; in addition to which the farmer would get a double crop of corn and straw from the tillage land, and always have it in a condition to produce him a good crop of any thing he chose to ask it. I know of an instance where bones were put upon the wheat root of a very hard tilled field of poor clay land after the rate of only 15 cwt. to the acre, and the result was that it considerably improved the crop of wheat, as well as the clover which followed it, and tended materially to produce a better sort of natural grasses afterwards, than would have otherwise appeared; the field has never had any kind of manure since, and has been in pasture now eight years, and produces twice the quantity of herbage, and that of a very superior quality to any of the adjoining fields, which have rested much longer, and consequently ought to be in better turf. I have paid nearly 10,000*l.* for this manure, and therefore must naturally feel no little interest in the subject, and I have much satisfaction in saying that the result has in every instance been most satisfactory both to my employers, myself, and the tenants.

*“I have known many a poor honest, but halfbroken-hearted man, raised from poverty to comparative independence, and many a sinking family saved from inevitable ruin by the help of this wonderful manure. Unquestionably, bones act in a very peculiar manner upon our Cheshire clay soils, when applied to the grass lands, which no doubt arises from the circumstance of our soil containing either less of that matter which counteracts their effects, or possessing in an extraordinary degree those qualities which are favourable, if not essential to their operation. When the landlord purchases the bones, I think he ought to receive  $7\frac{1}{2}$  per cent. upon his outlay, which I consider would amply remunerate him for both principal and interest, and answer the purpose of the tenant exceedingly well; but of course in this case it is only fair that a proper agreement should be (and, I presume, generally is) entered into, reserving the boned land both from the scythe and plough; but when bone manure is applied for permanent mowing, clover or arable purposes, it should of course be at the tenant's expense, and I much question if it is not for his interest, where he possesses sufficient capital and can get a lease, to do it himself in preference to paying the interest even in the former case.”*

#### *Cottage Allotments for Spade Husbandry.*

The following communication is from the gentleman whose opinions on bone-manure are last quoted:—“I know of nothing better calculated to benefit our peasantry than allotting to each labourer a certain portion of land for spade husbandry, at a reasonable price. Some laudable examples have been set by excellent individuals in different parts of the kingdom, which are now beginning, I hope, to be pretty generally followed; but it has often been a matter of surprise to me, that a plan, so well calculated to ameliorate the condition of our poor fellow-creatures—so

very satisfactory in its results, and those results being attainable without any pecuniary sacrifice, and I believe entirely free from any objection whatever—should not at once have received the most cordial and universal support of every well-wisher of the community. I have made upwards of a hundred of these allotments, varying from a quarter of a statute acre to an acre; but I generally confined them to quarter and half acres, according to the capability of the cottager and the size of his family, charging them the same rent as a farmer would be able to pay, and it is quite surprising to see the quantity of produce that is raised from this small quantity of land; and in order to show what may be done by spade husbandry I will mention some facts which have come under my own observation. About three years ago I selected two pieces of land, together about 30 statute acres, from a farm of Lord Crewe's, which land had been very hard tilled, and lying more than a mile from the homestead, had not for many years received any support in the way of manure, besides which it was naturally a weak light soil, with a bad subsoil; and so little did the tenant prize it, that he said I was quite welcome to take it from the farm if I would release him from the rates and taxes paid in respect of it, and make any deduction from his rent I might think proper: this I did to his satisfaction, and set it out in proper allotments, averaging about half an acre each. I allowed the poor men draining shells, which they put down themselves under my directions, and charged them as much rent as was just sufficient to cover the rent formerly paid by the farmer, together with all levies, tithe, rent-charge, &c., and although the land has only undergone this superior method of cultivation for three years, and was in the lowest condition to commence with, and consequently will improve for years to come; yet notwithstanding these disadvantages the crops grown upon these 30 acres of poor land last summer, were as follows:—1497 measures of potatoes, 298 measures of wheat, 22 measures of barley, 10 measures of vetches, and 70 measures of oats; which crops, after paying the rent, poor rates, tithe, and all other charges, amount to nearly 250*l.*, even calculating them at the present low prices of agricultural produce. It is, therefore, impossible that this amount of produce could be distributed amongst these poor men without adding greatly to the comfort of themselves and their families; besides which all these necessaries of life were procured by the application of those leisure hours which would, most likely, have been spent in the beer-house, and might have produced the bitter pains of domestic strife and wretchedness, instead of making the cottage a peaceful and happy home, and the allotment a healthy training-school for the children. I am extensively concerned in the management of cottage property, and necessarily come in contact with some hun-

dreds of cottage tenants (and, I hope, pay some attention to their habits, wants, and feelings), and I am decidedly of opinion that no able-bodied labourer ought to have less than half an acre of land, which will enable him to raise potatoes sufficient for his own consumption and to fatten a couple of pigs, besides growing a little bread-corn; and I think it would be for the general good of the agricultural community if every cottager with a family was enabled to keep his cow."

#### *Irrigated Meadows.*

In addition to the natural water meadows on the principal streams, which have already been noticed, there is a considerable extent (many hundred acres) of meadow land along the numerous small rivulets which intersect the county; and considerable ingenuity is frequently displayed in subjecting these lands to occasional irrigation. The water is dammed up in situations where it cannot injure the surrounding land, and conveyed along the sides of the banks to the parts intended to be flooded. In many instances great improvement is effected by this process, but in others it is decidedly injurious. Where land is already full of water from the want of proper drainage, it cannot, I conceive, be benefited by having more water brought upon it; for although, immediately after irrigation, the herbage may have a green and luxuriant appearance, it becomes coarser every year, with an increasing mixture of rushes and other aquatics. If the same ingenuity were exercised in draining and laying the ground perfectly dry for a fortnight, after being irrigated for a week or nine days, and this process were to be repeated three or four times during the winter, the land would unquestionably be much improved; and we should not hear so many complaints of artificial watering, or irrigation, being injurious. We should also bear in mind that this description of land is frequently in situations where manuring would be very expensive, and therefore never likely to have much applied: it is evidently, then, of great advantage to be enabled to enrich such soil by irrigation.

#### *Pasture Land.*

There is, perhaps, no county in England where the pasture lands (particularly the poorer soils) have been so much improved during the last ten or twelve years as in Cheshire; and this principally by the application of what is termed "bone-dust." This extraordinary manure has a peculiar effect upon the poor clay land pastures, for on the application of boiled bones a sudden change takes place in the appearance of the fields, and instead of the carnation-leaved, or "pink grass," which so

much abounds on this kind of land, a luxuriant herbage presents itself, consisting of red and white clover, trefoil, and other grasses, of which the cattle are so fond that they eat up almost everything before them; even thistles and rushes are very much weakened, and eventually reduced, by being constantly eaten off by the stock after the pastures have been "bone-dusted."

### *Fences.*

The fences in many parts of the county are sadly neglected, some farmers scarcely ever thinking it necessary to cut a hedge, unless when thorns are wanted to repair the gaps, and then the work is performed in a careless manner. Many fences are allowed to run so wild that they cover two or three yards on each side of the ditch, and are so high as in a great measure to exclude the air from the fields; and if perchance a few quicksets are put into the old copse, they are never more thought of, and soon become choked with couch-grass or weeds, and are eventually destroyed. On some of the best-managed farms great attention is paid to the fences; on a field being put into tillage the hedge is neatly cut to the height of about two feet, the ditch is cleansed, and as much of the contents as is required is thrown in among the quicks, and the remainder is put on the opposite side to be carted away as compost; the field remains in tillage four or five years, and by this time there is a good fence, affording shelter for cattle. If the fence be old and ragged at the bottom, all the strong stems are sawn off near the roots; and when there are any young slender shoots, they are reserved for the purpose of plashing or laying, and are fastened down with short hook pegs, the cop having been previously "breasted up," as it is termed, with the contents of the ditch; if there should not be young wood enough to form a sufficient fence to the field, a small beard of thorns is put along the top of the cop. Where there is a great deficiency of quick thorns in a fence, and those left are old or decaying, it would be much better to remove them altogether, level down the old cop, form a new one not too high, and replant with quicksets of four or five years' growth, cutting off the tops, and taking care to put some rotten manure in the trench before planting. Sufficient attention is seldom paid to the protection of young fences, and as good hedges form an important part of an estate, it would be well if landowners would find good strong quicks, and posts and rails to protect them, the tenant planting, manuring, and keeping them clean.

Some farmers not only never think of cutting their fences till thorns are wanted, but they never cleanse their ditches until they become so full that the water from them begins to flow over the adjoining land. There is also great and very general neglect as

regards weeds in the hedgerows along by-roads and around ponds. There are few farmers who do not think it necessary to cut the weeds in their grass-fields once a year, but the hedgerows are frequently neglected, even on well-cultivated farms, this being considered one of those unimportant works which can be postponed till "a more convenient season," but unfortunately this *time* seldom arrives, until the farmer is upbraided by the seeds of these weeds crossing his path in every direction, and alighting on his well-cleaned fallows, &c. Observing a fine crop of seed dispersed through the country by a gentle breeze in the month of September last, a plan occurred to me, which, if generally adopted, would soon materially lessen the growth of weeds arising from such neglect. It is simply this—supposing that all townships could be induced to join in the undertaking, a small fund might be raised by a levy of one halfpenny or one penny per acre, according to circumstances, on each farm in the township; the former sum I believe would, in most cases, be found sufficient. A treasurer should be appointed, whose business it should be to collect the money, and employ a person approved of by a majority of the inhabitants, to go diligently through the township and carefully destroy all weeds in the situations before alluded to; he should be provided with a long pole having a small hook attached, which could be closed at pleasure, like a clasp-knife, to prevent accidents while leaping (as he would sometimes have occasion to do) over fences: his labours should commence at stated periods, say on June 1, and again towards the middle of July, as many weeds might spring up through the brambles after the first cutting. As soon as the work has been completed to the satisfaction of the treasurer, payment should be made, and the surplus, if any, carried to the next year's account. As the work would not be very laborious, in many instances paupers might be employed.

#### *Farm Buildings.*

Although many of the old inconvenient buildings are still remaining in various parts of the county, they have been generally much improved within the last twenty years; with very few exceptions, whenever old buildings have been taken down and rebuilt, they have been made much more spacious than formerly; and instead of the narrow stalls which were scarcely wide enough for small Welsh cows, with room behind barely sufficient for a person to pass, they are now made large enough for the improved breed of cattle, with many conveniences which before were never thought of; and slates or tiles (even where the old buildings remain) are frequently substituted for thatch. There is an error, by no means unfrequent, and which therefore deserves notice, in the construction of calf-pens, and in placing



them in very cold situations. Young calves are exceedingly susceptible of cold, and unless kept warm and dry will not thrive as they ought. A south aspect is decidedly the best, but such an arrangement is not always convenient, as it might interfere with the general plan of the buildings; but whenever they are placed in situations much exposed to the cold winds, care should be taken to have the doors closely jointed, and the openings required for ventilation should be sufficiently high to prevent the winds from blowing upon the calves; and if the building be a shoring, the roof should be plastered underneath, as in frosty weather the cold strikes through the slates; and the floors should invariably be raised a little above the level of the ground, with openings left between the flag-stones or boards through which the wet from them may escape. I have found strong oaken planks to answer better than flags for floors, and so contrived as to be enabled to put them in loosely, as they are then readily removable for the purpose of cleaning out the bottom of the pen: wood is also much warmer for the calves to lie upon than flags in frosty weather. I am thus particular, because I have experienced the difference between cold pens and warm ones. Mine are shorings, on the north side of the buildings, with the exception of one to the south. During cold frosty weather the calves in the former pens often suffer from disordered bowels, and other complaints follow; neither do they thrive well in that situation; but if removed to the latter, a change for the better is very soon perceptible. In three of my calf-pens I have had frames of oak bars made in three divisions each, with an inch between each bar, to place upon the flags, and have found much benefit from the contrivance, as the calves now lie in a much drier and warmer state than before.

Offices connected with the dairy are also much improved in many parts of the county. The dairy-kitchen, as it is called, is spacious and convenient; and anything calculated to create a draught is studiously excluded, it being of great importance to keep cheese warm during the process of making.\* The milk-house is placed on the coolest side of the building, and has good ventilation; the drying-house is at one end of the dairy, and the cheese-presses are placed close to the wall at the back of the boiler and whey-furnace, which stand in the dairy, as the warmth from them is so desirable to promote the running of the whey from the cheese while under the press. The furnace and boiler are arched over, and are so contrived that the steam arising from

---

\* By the present regulations only one dairy window is allowed free of duty; lattices are therefore frequently introduced, and thus cold draughts are admitted of an injurious tendency.

them passes through a flue parallel with the chimney, and escapes without finding its way into the dairy.

#### *Potatoes.*

Although large quantities of potatoes, both of the early and the winter kinds, are grown in the county, I believe it will be found that they have not been on the increase for some years. Many farmers now grow Swedish turnips for their cattle; and some gentlemen have an objection to many potatoes being planted on their estates. In the northern and western districts, and some parts of the interior, where there is water-carriage within a reasonable distance, extensive crops are grown for the supply of the Manchester and Liverpool markets; and some from the southern side are sent to Wolverhampton. Among the early sorts, those most deserving of notice are the foxes-seedlings, and ash-leaved kidneys; there is also a new kind, called Radicals, which are about a fortnight later than the rest, but are much liked on account of their productiveness; and, by taking a little pains with the sets previously to planting, they are frequently brought into the market as soon as the others. The plan is as follows:—

“At the latter end of January, or in February, the sets are placed close together, with the sprout upwards, on shelves in a building with a southern aspect, or on boards, each resting one above the other, on three bricks placed on edge: sacks are suspended in front to keep them warm. About a fortnight before planting, which is early in March, the sacks are removed, with the view of hardening them; they are then cut into two or three sets, taking care to leave only one sprout, and are placed in the ground, which has been well manured. When this method is adopted, they can be brought into the market very early; and the ground is again planted with the same kind of potatoes for seed the following year, or Swedish turnips. Among the best varieties of winter potatoes are the red apple, Scotch ink-eyes, new ink-eyes (much liked in the Manchester market), short wertzle or short tops, Irish cups, bread-fruit, and blue farmers; the latter an inferior kind, but good croppers, cultivated principally for cattle, and have of late years been used by bread-bakers on account of their whiteness.”

#### *Swedish Turnips.*

One of the greatest improvements which have taken place in Cheshire since 1808 is the more extended cultivation of the Swedish turnip; and it has only been within the last ten or fifteen years that its value has been adequately appreciated. In the year 1814 there were not 5 acres of Swedish turnips grown in the parish where I reside; now there are from 60 to 80; and in many parts of the county the increase has been in a much greater ratio; on two farms,\* in the holding of one person, in the Hundred of

\* From 900 to 1000 acres.

A correspondent from the Hundred of Eddisbury says, “When I commenced growing turnips, ten years ago, there was scarcely one farmer in ten who cultivated *swedes* for his stock; but now nearly *all* my neighbours grow them to a greater or less extent.”

Nantwich, where turnips were not grown at all twenty years ago, from 80 to 100 acres are now raised annually, and these principally with bone manure: these are dairy and grazing farms combined, and a great part of the turnip crop is consumed by sheep, on the Norfolk system, or by stall-fed cattle. Many of the new implements for cleaning the land having been introduced, the crops generally are kept much cleaner, and the management of them is on the whole better understood than formerly. Swedes are given to the dairy cows while eating straw, and to the team-horses, and are found to be very wholesome: they are sometimes steamed for the latter, and mixed with chaff or cut hay or straw; this appears to be an excellent plan when hay has been damaged by the weather, &c. Swedes are given raw to the sows and store-pigs, with good effect; on many farms they live upon them entirely throughout the winter, and keep in good condition. Too much cannot be said in praise of this invaluable root; but some farmers have yet to learn that, to have swedes in perfection, and to grow them so that the land may derive that benefit which renders their culture doubly desirable, the ground must be well worked, well manured, good seed sown, and the crop kept perfectly clean by scarifying and hand-hoeing. The turnips on the dairy farms are generally taken up during the months of November and December, and piled into narrow heaps near the home-stead, and thatched over to keep out the wet.

#### *Lucerne.*

The land in Cheshire is not at all suited (generally speaking) to the culture of this plant—it requires a deep dry soil: it grows well on some of the driest parts of the enclosures from the river Dee, called “Sealand,” particularly on the raised cops, where it is most productive, affording three good cuttings in the year. There is a small field of it in the Hundred of Eddisbury, where it is sown in rows 10 inches apart; the lucerne occupying 4 inches, with 6 inches between for the purpose of cleaning. It was sown in May, 1843, was cut twice, and is now most promising.

---

In concluding my Report I may remark, that any attempt to have given an accurate description of every course or “no course” system of management, pursued throughout this part of England, would have been an almost endless task, and could not possibly lead to any beneficial results. There is in Cheshire, as in every other county, a mixture of good and bad farming; and while the agriculturists of this district make no pretensions to the palm of peculiar merit, they cannot admit the imputation of being the “very worst farmers” in the kingdom; and they justly think the epithets unenergetic and unskilful are not generally

applicable. In almost every district there are more or less difficult soils to contend with; and the systems which are pursued in the Lothians, Norfolk, and other counties of England, would not be at all suitable to the generality of land in Cheshire. Enough, I trust, has been advanced to show that, in many respects, the agriculture of the county has been improved; and I doubt not that a majority of the farmers are desirous of proceeding with improvements as far as in their power: but something more than even energy and skill on the part of the tenants is essential to good farming; and there never was a period when they stood more in need of assistance and encouragement than the present.

The breeds of cattle and pigs are more improved in the interior and northern parts of the county than on the western, southern, and eastern borders; and this difference may be chiefly attributable to the circumstance of the former being more within the influence of various agricultural societies. For any improvement which may be observable in sheep, this county can claim little or no merit, as it is almost entirely dependent upon other districts for a supply of that useful class of animals. So lightly do the leading agriculturists of Cheshire appreciate them that in their societies they have erased from their lists of premiums prizes for sheep; it being evidently considered a stock undeserving of such distinction.

The description which has been given as to a defective state of drainage—that highly important branch of husbandry—should command the attention and arouse the energy of all who are interested in the productiveness of the soil; for there can be but little doubt, that by far the greatest portion of land in this county is capable of being made to double and even treble the present amount of its produce, by a proper system of draining, and a judicious application of manures. I have seen much draining in operation, and observed land which was subjected to that process 12, 14, and even 20 years ago, and the result of my conviction is, that no general system of drainage can be laid down, as equally applicable to all soils. The tenacious clays of Cheshire do not require such deep draining as is generally recommended, from 18 to 22 inches being sufficient for most of them; and some of the sound clay land (*i. e.* land with a little slope, and on a regular substratum of solid marl) would not need under-draining at all, if the butts were properly formed, 6 or 7 yards wide, with an elevation of 1 inch in 12 towards the centre: should it at any time be necessary to water-furrow, as before described, the rein presser (see drawing No. 1) would be sufficient for the purpose. It has, within the last few years, become the practice of many landowners to allow their tenants indiscriminately, without charge, a certain quantity of draining tiles annually; the tenants per-

forming all the work. In a very few instances 5 per cent. is charged upon the cost of the tiles, but this charge, I should imagine, is only made to ensure a proper care and use of them; and in *one* case which has come to my knowledge, half the value of the tiles is charged to the tenant—an arrangement which certainly cannot facilitate improvements at a very rapid rate. There can be no question that a better state of information, and a more extended spirit of enterprise, have been promoted of late years throughout the county; and if those who possess the means will cheerfully and liberally advance this movement, there will, no doubt, be an almost universal readiness, on the part of the farmers, to avail themselves of all those helps and facilities which modern science and investigation have brought to the aid of agriculture.

---

*Appendix.*

As a kind of "Appendix" to my Report, it may not be altogether destitute of interest if I narrate the course which I took in my tour of agricultural inspection, the principal journeys of which occupied me during the greater part of the month of December; having previously crossed the county in various directions in the summer and autumnal months.

I commenced at the south-west side of the Hundred of Eddisbury, crossed Delamere Forest to Delamere House, the seat of G. Wilbraham, Esq., and observed some land near the mansion much improved by draining with tiles, laid upon split alder. On one of his farms in the neighbourhood, consisting of light sand-land, the Norfolk system of eating off the turnips with sheep is adopted: the land is sown with barley and seeds afterwards. Mr. Wilbraham thinks many of the old leases and agreements very absurd, and not at all applicable to the most approved mode of farming in the present day. He speaks highly of bones as a manure, and also of guano; but is of opinion that the effects of the latter are very uncertain in dry seasons: he considers it very suitable to the culture of mangold-wurtzel, having an excellent crop this year raised by this manure.

The fences here are in admirable condition, from having been carefully attended to when young. There are two brooks on this estate, one a clear white water, the other brown, both of which abound with trout; and on each there are irrigated meadows. In the former stream the trout are large; in the latter, small, and never grow beyond a certain size,—the meadows watered by the former are green, luxuriant, and productive; those by the latter comparatively barren. It is supposed that the pernicious effects of the brown stream are occasioned by passing through peat, or some mineral substance, but the cause has never been satisfactorily demonstrated.\*

From Delamere proceeded to Weaverham and Acton Bridge, where I entered the Hundred of Bucklow, and thence through Whitley. Observed

---

\* On the property of the Earl of Carnarvon, near Exmoor, there are four streams: the Haddiow, containing excellent trout, and making superior water-meadows; the Exe, inferior in the quality of the fish and less beneficial to grass; the Barle, worse again in each respect; and lastly, the Daesbrook, containing no fish at all, and itself, as I am informed, poisonous to grass-land. The variation of their colour confirms Mr. Palin's opinion that these differences are owing to the presence of peat.—PH. PUSEY.

some grass-land very badly managed. The land naturally poor and wet, the butts small and flat, the reins sufficiently deep to form reservoirs for supplying the rushes with water, but not deep enough to act as drains to the land. Arrived at Stockton Lodge in the afternoon, and visited the town of Warrington in the evening. The next morning passed through Stretton to Great Budworth, saw a great deal of bad farming, and some little good. Draining on the increase in that neighbourhood, especially on the estate of Rowland Warburton, Esq., who allows his tenants the tiles—a great quantity of hedge-row timber, which is much neglected, on an estate between the two last-named places, belonging to a non-resident gentleman. On returning to Stockton from Budworth, along the lower road, between Belmont and Marbury, passed a number of small freeholds: an indication here of some improvement by draining; but in many instances great neglect of the timber, and much loss of land in old pits, hedge-rows, &c.

The next day went to Lachford and Grappenhall, and along the Duke of Bridgewater's Canal. The course of cropping pursued in this district has been previously described. From Grappenhall to Stretton, and thence through Preston by Whitley. Noticed a great deal of poor land, which might be much improved by draining and bone-manure: passed through Frodsham, and thence to Chester.

Started again from the south side of the Hundred of Eddisbury, crossed into the Hundred of Broxton at Stapleford Bridge, near which, on an estate belonging to the Marquis of Westminster, there are some good specimens of draining; the butts, consisting of a strong clay-soil, are high, and vary in width from 4 to 10 yards: the drains are cut along every rein to the depth of 20 inches, and are laid with tiles. (The other particulars are fully described under the head of "Drainage.") From thence to Saighton, Bureton, and Aldford. At Bureton noticed on a large farm belonging to Sir W. Stanley, and in the occupation of Mr. Thos. Weaver, a field of 40 acres, about one half of which was in progress of draining. This field was one of the stiffest clays I had seen, the butts, varying in width from 5 to 14 yards, were drained with tiles down every rein, to the depth of about 20 inches. The tiles are made upon the estate, at the expense of the landlord, and allowed to the tenant, who pays for the cutting of the drains, filling up, &c. Previously to cutting the drains, a thin furrow is removed from the top by a plough, and afterwards placed upon the tiles. The good soil in this field is remarkably thin. From Aldford I proceeded to Farndon, where I crossed the Dee into Denbighshire. The farming on that side is exceedingly bad for three or four miles, and the farm buildings are much out of repair. Re-crossed the river at Bangor Bridge, and proceeded to Worthenbury, where, on the following day, I saw some good specimens of farming in the neighbourhood: the wheat stubbles were decidedly the best I had seen. They drain here by throwing out two furrows with a plough, right and left, then the remainder of the soil is thrown out with a spade to the depth of about 15 inches, when an instrument 2 inches wide is used to cut a narrow drain about 5 inches deep, leaving a shouldering or ledge, on which are put sods or stubble, and the drain filled up; but previously a long narrow scoop is used for clearing out the soil which may have fallen in. The course of cropping here has been described. From Worthenbury went to Cuddington, in the parish of Malpas: here they have a practice, novel in this county, that of burning marl as a manure for their turnip crops. The plan is to build a wall of sods of the size required, then lay in a quantity of wood, then a layer of marl, then a layer of coal and marl alternately, the fire constantly burning till the work is finished. The heap may be raised as high as men can conveniently throw the marl. The turnips were a good crop grown with this

manure alone, but the more general practice is to put about half the usual quantity of farm-yard manure on the burnt marl in the drill. "Shoulder" draining is practised in this district at the distance of 8 yards. Noticed a great quantity of neglected small timber in the hedgerows. Proceeded the next morning to Ridley Hall; saw a very good specimen of draining on Coxon-green farm, the drains from 8 to 9 yards apart, average depth 30 inches, cut obliquely across the fall; the sub-stratum a mixture of sand and clay; cost of the work  $4\frac{1}{2}d.$  per rood, the landlord finding tiles and soles. On Mr. Cawley's farm, at Ridley, noticed part of a field laid out for irrigation (about 8 acres); the work done in a superior style, and the whole wore a good appearance. There is a large thrashing-machine worked by steam, and there is also an excellent tile and brick yard on this farm. A good deal of draining has been done here; one large open drain at the lower end of the farm, about one mile in length, cost the tenant upwards of 100*l.* Returned by way of Cholmondeley, where I observed much fine oak timber, which is well managed, not being too much crowded together; the land too is better cultivated here than any I had previously seen.

From Cholmondeley proceeded to Wrenbury, and thence to Nantwich, without seeing any thing worthy of notice, except bad farming and timber crowded in the hedgerows: arrived at Henhull Cottage, where I stayed for the night. The next day went to Mr. Bott's farm at Shrewbridge: the buildings are quite new and complete. There is in the grounds a stone trough, 20 yards in diameter, which supplies two fields with water for the cattle: it is formed of blocks of stone, neatly worked and cemented together, the bottom being cased with bricks on edge; the stone-work is raised about two feet above the level of the ground, and the water is only a few inches below the top of the trough. The water is supplied by a small spring: there is a pipe in the centre for the purpose of conveying the surplus water into a drain underneath the trough. The whole is surrounded by flags, for the cattle to walk along, about two yards in width. The fences here are very good, and the farm in a high state of cultivation. A fine dairy stock of short-horns is kept. I also observed a good hay-cutter, made by Parry of Chester, and worked by one horse. Afterwards went to see some irrigated land, belonging to Mrs. Tomkinson of Dorfold: it is laid out in a masterly style by Daniel Smith of Sandbach, and is so contrived that all the sewers about the farm-yard may be cleansed by turning some water into them out of a large pond, and the whole is thrown over the meadow. Proceeded to Doddington, *via* Combermere, passed a large tract of land, which wants draining. Near Combermere perceived symptoms of better farming; here and there a large turnip field of small turnips, but clean and regular: at the farm-yard, where there is a range of good buildings, was a number of cattle feeding. This kind of stock is peculiar to the place, and consists of oxen and heifers, bred from the Brahmin bull, and short-horned and Ayrshire cows, which, I was informed, feed well, and are most excellent beef: a nice dairy stock of Ayrshire cows is also kept upon the farm. The pigs here are very numerous, and consist of a great variety of breeds, which are fed principally for home use. The dairy is neatly fitted up: there is a churn worked by steam, which I was told answers well. From Combermere proceeded to Audlem, Doddington, and Barthomley. On Monday morning left Barthomley for Haslington; proceeded thence to Sandbach, afterwards to Rode, the seat of Rundle Wilbraham, Esq., a delightful residence, the grounds of which are laid out with admirable taste. Passed on from Rode to Congleton, where I spent the night. The next day walked to West Heath Cottage. West Heath is a tract of land which has not been enclosed many years; the farm-houses and cottages have all a neat appearance, and the land, which consists chiefly of a black soil on a grey sand and fox-beuch, has been drained, and

seems to be tolerably well managed. Returned to Congleton, and thence went to Macclesfield, calling in my way at Eaton Hall, the seat of Crawford Antrobus, Esq., beautifully situated about two miles from Congleton. About four miles from Macclesfield came to an estate, the land miserably poor and badly managed, with a superabundance of timber, sadly neglected. Passed on to Macclesfield, whence, after obtaining some information, I proceeded along a hilly road and wild country through Bollington, to Lyme Park, the seat of T. Legh, Esq., where I arrived too late in the evening to see its beauties. On this line of road the farming is most uninteresting; remained for the night at Disley. On the next morning took a stroll through Lyme Park; the house is a noble mansion; the park has a wildness about it which is seldom seen in this part of England; high uncultivated hills, covered with fern and rushes: there is a number of wild cattle on these hills, the breed of which has been there for centuries; they are perfectly white. There are buildings for these cattle to run in during the winter, where they are fed on hay, and have rushes to lie upon and make manure. The park, in the greater part of it, is wet and rushy, and very much in want of draining: a little draining has been done, which answers exceedingly well; about 1000 sheep are kept in the park. Returned to Disley, and thence proceeded to Stockport. At Hazel Row there is a good tile-yard, where the price for the largest size of draining-tiles is 32s. per 1000. The railway viaduct of 26 arches, on brick pillars, is an object of great interest in this neighbourhood. From Stockport drove to Altrincham; where I remained for the night. There is a tolerably good specimen of draining in this neighbourhood: on the same road a common has lately been enclosed by consent of the freeholders, Mr. Tatton of Withinshaw being the principal one: it appears a barren soil, consisting principally of grey sand, fox-bench, and peat, and requires draining and marling; the men receive a shilling a rood for trenching it, and the first crop is generally potatoes. The following morning inspected several farms, the course of cropping on which has been described in the general remarks on that head. From Altrincham proceeded to Dunham Massey, the seat of the Earl of Stamford and Warrington: the land in tillage here is a deep black loam, and appears to be well managed on the alternate green-crop system. About eighty head of cattle, consisting of Scotch bullocks and short-horned cows, are fed in the park, and what are not sold off before Christmas are put upon turnips. On leaving Dunham I observed some good meadowing: proceeded thence to Mere, where there is an excellent implement manufacturer named Harkes, who is doing an extensive business, and has frequently obtained premiums at the different agricultural meetings. Went thence to High Leigh, and saw a farm belonging to Egerton Leigh, Esq., in the holding of Mr. John Owen; it consists of 160 acres, and is decidedly the best managed farm I have seen. There are two bone-mills in this vicinity; one little more than a mile off, worked by steam on a large scale. A quantity of American bones is crushed here, besides those brought from the surrounding neighbourhood; the large bones when crushed are sold at a higher price than the small ones; the former are now selling at 6*l.* 10*s.* per ton, the latter at 5*l.* 10*s.*; they are ground more finely than formerly, and are consequently considered better for the land, and are here preferred to boiled bones; the other works are at Hoo Green, and are on a smaller scale; the proprietors, Messrs. Ockleston, have also an establishment at Massey Brook, Lymm, near Warrington. From High Leigh, drove to Knutsford, and slept there. A great extent of draining has been done, and is yet progressing on the estates in this neighbourhood, the landlords finding tiles. Mr. E. Leigh, Mr. Cornwall Legh, Mr. Brooke, Mr. Egerton, and Lord De Tabley, are the principal landowners. Went to Tatton, the seat of Wilbraham Egerton, Esq.; on my



way there, a short distance from Knutsford, observed a great number of small plots of ground, which I learned are let by Mr. Egerton to the surrounding cottagers and mechanics; 20 roods to each person, at 1s. per rood, thereby producing a good rental to the owner, and being a great accommodation to the occupiers. The farming here presents no features requiring particular comment. Mr. Egerton gives prizes for the best ploughing, which are annually contested for by his tenants; but these being very numerous, the competition has the effect of improving this important operation in agriculture in the vicinity adjoining his estates. Visited Messrs. Woods' implements manufactory at Knutsford, where are made some of the most approved ploughs, scarifiers, turnip scufflers, lever churns, &c. Leaving Knutsford, passed Toft, the seat of H. Leycester, Esq.: this estate is finely wooded; large numbers of oaks have recently been felled, and many more are marked to come down next season. The appearance of the country will not only be thus improved, but the proceeds will enable the proprietor to improve his lands by draining and bone-manuring, without any material additional outlay of capital. Tiles are allowed to the tenants, and not unfrequently bone-manure. Leaving Toft, came to a village called Little Peover, thence to Middlewich, passing some very good meadow land on a small stream, and some property once belonging to Lord De Tabley, but now to "Dr. Taylor," who allows his tenants as many draining-tiles as they will use, and will advance an equal sum of money to that which they are willing to pay for bone-manure, or will advance the whole sum himself, at the rate of  $7\frac{1}{2}$  per cent., at the option of the tenants. Passed Kinderton Hall, the property of Lord Vernon, a fine farm of about 400 acres, managed by the tenant Mr. Stones, on the Norfolk system, or nearly so; he feeds a considerable number of cattle and sheep, and grows large quantities of turnips; there are only three milking cows kept, to supply the family with milk and butter. Passing through Middlewich, arrived at Sutton Hall, a farm belonging to Mr. Court, of the Manor, and well managed by the occupier Mr. G. Woolrich. Returned through Middlewich to Winsford, where are some extensive bone-works belonging to Messrs. Rawcliffe. A peculiar process of boiling is carried on here with excellent effect; and the manure which a year and a half ago was sold at 5*l.* 10*s.*, is now to be had at 3*l.* 12*s.* 6*d.* per ton. The dust, which is caused by the sawing of the bones, does not pass into the boiler, and is sold alone at 8*l.* per ton: it is a very valuable manure. Leaving Winsford, crossed Delamere Forest, and reached Stapleford, a township in the Hundred of Eddisbury.

Commenced a tour through the Hundred of Wirral, at Chester, and proceeded in a westerly direction. About the middle of the Hundred observed a large tract of land in a most wretched state of cultivation from want of draining; the land is very thin of soil, a great portion of clay being turned up in ploughing very shallow furrows; the butts are small and flat, in many fields not more than three feet wide, and in some not more than two feet six inches; every rein full of water, and the gutters not more than three or four inches deep. As I proceeded I found some better specimens of farming, and some very good on two farms, one of 500 and another of 150 acres. On the former I witnessed an exceedingly interesting and novel sight—"Alexander's draining-plough," which has been minutely described in agricultural publications; it was drawn by sixteen horses, yoked eight abreast, then six, then two. By the first operation, soil to the depth of sixteen inches was thrown out; by the second, soil to the depth of eight inches more was cast up, leaving the drain twenty-four inches deep and five inches wide; the loose soil is then scooped out by an instrument for the purpose, when the tiles are laid upon slates cut for this work; sods are placed upon them, and the drains filled up. It is calculated that the

plough will drain, on an average, eight acres per day; and it is estimated by the gentleman using it, that work which would be done by this clever invention for 6*l.*, would cost by spade-husbandry 7*l.* 4*s.*

The weather throughout my various journeys was remarkably propitious.

*Stapleford Hall, Chester.*

*Drawings referred to in the foregoing Essay.*

No. 1.

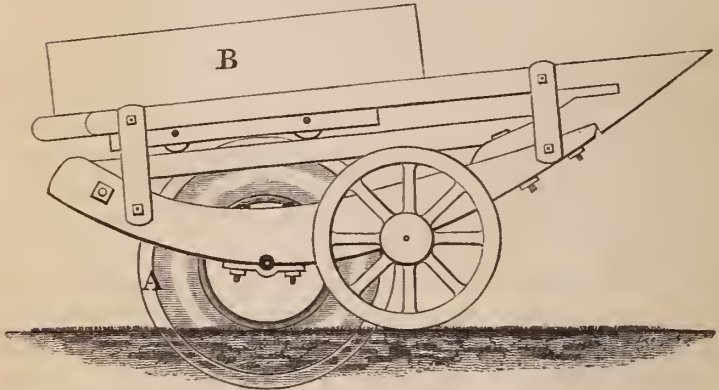

ELEVATION.

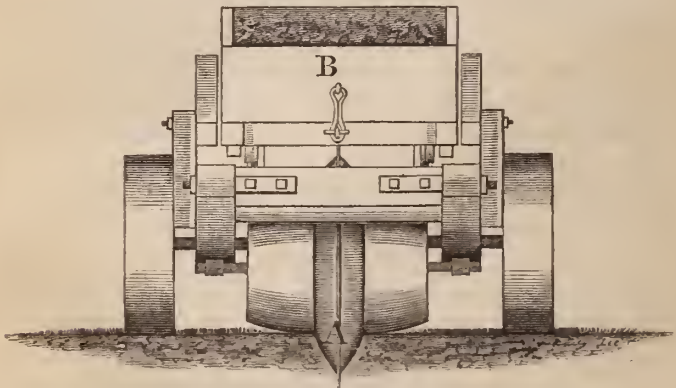

FRONT ELEVATION.

Scale  $\frac{1}{4}$  an inch to the foot.

(Note.) When the roller A is not required to press the furrow, the box B, which has small wheels sliding upon plates of iron, should be moved to the other end of the machine, which raises the roller out of the ground, and leaves it running upon a small pair of road-wheels attached for that purpose.

When greater pressure is required, the box B should be filled with heavy material.

Cost £16.

No. 3.

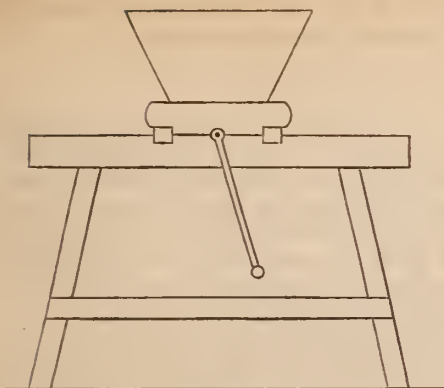

CURD-MILL.

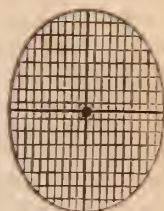

CURD BREAKER.

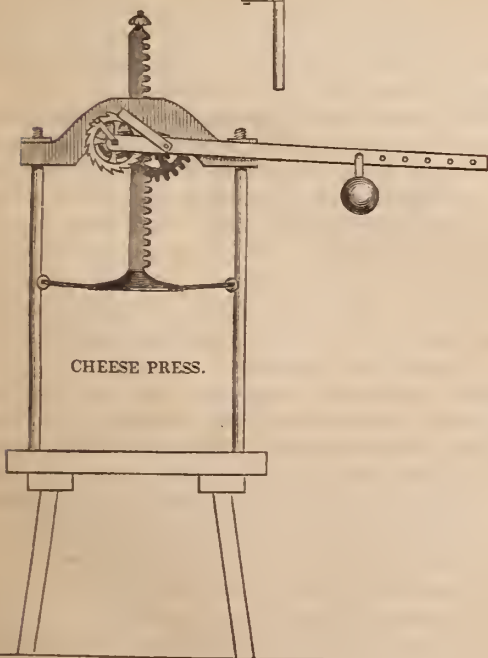
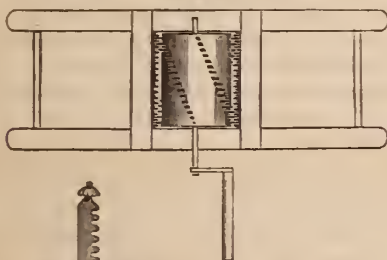

CHEESE PRESS.

VI.—*Method of growing Beans and Cabbages on the same Ground.*

By THE EARL OF LOVELACE.

*To Ph. Pusey, Esq.*

MY DEAR SIR,—I have great pleasure in replying to your inquiries as to the manner of growing the double crop of beans and cabbages, the latter of which only you saw upon the ground last week. The beans are dibbled in February in double lines 4 inches apart, and with an interval of 3 feet to the next row. This enables the double mould-board or the subsoil plough to pass freely along without injury to the beans as often as the state of the soil may require it, until the time of planting the cabbages. The latter are of the thousand-headed sort, and should have been raised the previous autumn—then pricked out in March (in a corner of the garden), and finally planted in their places between the rows in the field in May or June, taking advantage of showery weather for the purpose. The distance from plant to plant is about 2 feet; they should be from 5 to 8 inches out of the ground. They do not grow much until after the beans have been removed, which is generally done early in August—when the latter are gone, the space they occupied is ploughed, and the cabbages grow with such rapidity as effectually to prevent any weeds from making head that season. No one, ignorant of the practice, sporting over the field in the beginning of September, would imagine that the then luxuriant crop was the second of the season.

The cabbages yield a great bulk of green food towards Christmas, and if their leaves are then pulled, a second sprouting takes place at the end of March or the beginning of April; but as food is of much more consequence to a breeding flock at the latter period, they have been left (without plucking from them in December) till the turnips are over. They are then eaten on the ground by couples, and the land is ready with a single ploughing for any sort of spring corn. The quantity of keep derived from them by this arrangement is equal to what the same extent of turnips would give, but inferior to swedes.

I was led to try the experiment for the first time in 1838, from having accidentally read an account of the husbandry of M. de Fellenbergh, at Hofwyl, in Switzerland, in which a similar custom is mentioned. The success has been complete, and it has never been omitted for a single year since its introduction at Ockham; and I see that, so far from the bean crop being diminished (in consequence of the greater distance at which the rows are planted to admit the cabbages between them), it has, on the contrary, been increased from about 35 bushels the average yield for 5 years before the mixture, to 41 bushels the average yield for

5 years since the cabbages were introduced. These figures are in the tabular statement you did me the honour to print p. 23 of vol. iv.

Believe me ever yours truly,

LOVELACE.

*Ockham Park, March 5, 1844.*

---

VII.—*On the Improvement of Cold and Heavy Soils by the Application of Burnt Clay.* By CHARLES RANDELL.

*To Edward Holland, Esq.*

MY DEAR SIR,—I cannot answer the inquiries contained in your letter, and that of Sir Robert Throckmorton accompanying it, as to my experience of burnt clay, in any way that will be satisfactory to you without going somewhat into detail, and at the same time recalling to your mind the state of cultivation of my farm when I entered upon it, at Michaelmas, 1839. You will believe that it is not from any disposition to speak harshly of the tenants who preceded me upon this farm (formerly in two), but because the extent to which it has been benefited by burning would not be appreciated, if it were not understood that the farm at the time I mention was in an exceedingly bad state. Without further preface, then, I will proceed to describe what has been done in this way upon a few of the fields; regretting that I cannot in all cases speak with accuracy as to the results, not having expected that I should be called upon for them. In one or two cases, however, I can do so.

In speaking of what the several fields were worth, I give the price at which they were valued when the estate was purchased for your father, about twenty years since. The valuation upon which my rent was fixed—at least as far as regards the clay-land to which these remarks apply—is very nearly the same.

I will begin with the field upon which my first attempt was made, not only for that reason, but because it is the worst piece of land; indeed, I hardly need say it is as bad as possible, for the rent is but 5s. per acre. It is called the “Coal-pit Ground:” 11½ acres of the worst description of clay, on the side of a steep hill, wholly inaccessible to the dung-cart, to which it has always been a stranger. It had been allowed to run down a few years before I entered upon it; and the former tenant being bound by the covenants of his lease to have a certain portion the last year in fallow (for which I, as the incoming tenant, had to pay 40s. per acre), had broken up this field for that purpose. After he had ploughed it once, I offered in the middle of the summer to take to it on the same terms as if a fallow had been made, in order that I might at once begin burning it. This was agreed

to, and I immediately began with the scuffle and drag to work the clods of couch and wiry turf to the surface, which, with the quantity of soil necessary to procure a good dressing of ashes, were shovelled and forked together, and burned in heaps of about a cart-load each, with wood cut from the wild neglected hedges surrounding the field; at the cost, including spreading, of 2*l.* per acre. I scarcely know how to put a value upon the wood used, as it would barely have been worth drawing home; the cost of cutting and tying up would be about 5*s.* per acre. The weather, while the work was in progress, proved unfavourable; and this, as it was the first, so it was the least effectively done of any I have attempted; nevertheless, the result has been highly satisfactory. The field, after the ashes were ploughed in *lightly*, was planted with vetches, which were eaten off, the succeeding summer (1840), by sheep: and then planted with wheat, which produced rather more than 30 bushels per acre; it was sown with seeds upon that crop, and continues down, carrying a much greater stock than it has ever before done. Should I find it deteriorate, as such land as this always does, I shall plough it again for vetches, having no doubt that it is now capable of bearing a crop sufficient, when consumed upon the land by sheep, to enable it again to grow as good a crop of wheat as the last, to be then laid down again.

My next piece was upon part of a field, called the "Barn Ground," in the spring of 1840, and as I have done several others, under similar circumstances, and with precisely the same results, the description need not be repeated. This is a field of 15 acres, 6 of which are a strong clay of tolerable quality, worth 30*s.* per acre; the remainder fair turnip-land: the clay part of the field was exceedingly foul, so that I had two objects to attain—first, to get rid of the couch by burning it in the clods; next with the ashes so obtained, to render the whole field alike capable of bearing a crop of swedes. In this I succeeded. The whole, after draining so much as needed, was lined and manured alike, and the crop was quite as good upon the clay as any part of the field. All the swedes were consumed upon the land by sheep: the succeeding barley-crop was much better upon the part that had rarely, if ever, been planted with barley before; the seeds were equally good, but the wheat-crop this year (1843), from the excessive growth of straw, went down early, and became mildewed, and, though more bulky than the rest of the field, will not be so productive. The field is now ploughed for swedes again; and the clay part is as healthy, and as likely to grow a crop, as that which has always been considered turnip-land.

I come next to two fields, upon which the fertilizing power of ashes is still more satisfactorily shown than in the last mentioned, inasmuch as they were not assisted by any other kind of manure;

and, in these two cases, I am enabled to speak with accuracy of the results. The first, called the "Rough Hill" (5 acres), adjoining the Coal-pit Ground, before mentioned, not being considered quite as bad, is valued at 7*s.* 6*d.* per acre. I entered upon it (1839), a foul bean-stubble: the following May it was skim-ploughed to the depth of about 1½ inch, and all that the plough raised burned with faggots, at the cost, including spreading, of 42*s.* per acre. It was then ploughed and scuffled; and the weather being favourable, was rendered perfectly clean; then planted in October with vetches, which, the following summer, were eaten off by sheep folded upon them; succeeded by wheat (1842), which produced 226 bushels, of 62 lbs.; or one bushel more than 45 bushels per acre. It was sold at 7*s.* per bushel; and this crop therefore produced more than the fee-simple of the land in its former state. This field is also laid down, and is looking very well. A small field of 3 acres, adjoining, was similarly treated at the same time, with nearly equal results; the difference in the wheat-crop, which was not quite so heavy, being attributable to the vetches having been eaten off by horses tethered on them, instead of by sheep.

The second instance of the power of ashes, unaided, in rendering exhausted land capable of producing a crop, is, I think, even more conclusive than the first, as it may be said that the great crop of wheat produced in the former case was attributable to the manure left by the sheep in consuming the vetches; and this is correct in a degree, but I know not how that crop of vetches could have been obtained to create that manure without the ashes. In this case, however, the land received no such assistance. It is a field called the "Brake Ground"—10 acres of exceedingly stiff clay, valued at 25*s.* per acre—and was, Michaelmas, 1839, an awfully foul piece of two years old—I was going to say seeds—however, it had been down two years; and, for want of something more fit, I was induced to plough and plant it with wheat, and a miserable speculation it proved. The seed-time of that year, as most of us in this part of the country very well remember, was exceedingly wet. This, combined with the bad state of the land, left me no resource but to dibble it; this was done as well as it could be, and after being twice hoed the following spring, the crop was as nearly as possible 16 bushels per acre. Here then was a stubble in the best possible state for burning, and the weather being dry after harvest, it was skim-ploughed, and attempted to be dragged, but that was impracticable—it was so tied together that it could only be parted with forks, which increased the expense of burning this piece to 50*s.* per acre; but it was well repaid: the quantity of ashes burnt could not have been less, upon by far the greater part of the field, than from 150 to 200 yards per acre. It was then planted, after being ploughed,

with vetches ; but such a crop of crowfoot, charlock, and rubbish of all descriptions came up the following spring, that I had all mown off together, and carried to the fold-yard. I then proceeded to fallow it, but, as if this field was to be unfortunate, the latter part of the summer proved wet, and it was very imperfectly done, and after draining was left till April, 1842. The whole of that month proved dry ; the field was forked at an expense of 25s. per acre, and by that means rendered clean at last. No rain fell till the night of the 11th of May, and on the 12th and 13th it was drilled with barley, the produce of which, fit for and sold to the maltster, was 56 bushels per acre. The next crop was beans, mixed with a few grey peas, and certainly the greatest crop of straw I had ever seen ; what the produce may be I cannot yet say, but I shall be enabled to inform you, as it is stacked by itself ; but I should suppose nearly or quite as many bushels as there were of barley. It is now wheat, without manure ; after that crop, my intention is to take vetches, wheat, clover, wheat—still without manure—in order to see how severe a test the ashes can bear. The produce of each corn-crop I shall, if you wish it, be pleased to give you.

The field to which the inquiries of Sir Robert Throckmorton referred is called the “Green Hill”—13 acres of stiff but tolerably productive wheat-land—and will come under what I have said relative to part of the Barn Ground : it was equally foul, was burned equally well, was drained, limed, and manured ; and produced an excellent crop of swedes—no turnips of any kind having ever been planted upon it before. This was done in 1841. It has grown barley and seeds since, as good as I could wish, and is now planted with wheat. I have also a piece planted with wheat, after vetches, for which the field—11 acres of very bad clay-land—was burned, and on which no manure has ever been laid : this, like the Brake Ground, must support itself for some years.

All these pieces of land to which I have now alluded had the ashes burned and spread upon the field, at the expense, as I have said, of from 40s. to 50s. per acre ; the greater part done with wood cut from the hedges, the value of which I can scarcely state. When that was all exhausted (a good deal having also been used to put upon the tiles in draining) I had recourse to coal, and can state the expense. Three tons of raked slack, which costs here from 9s. to 10s. per ton (at the pits 3s.), will burn in the summer in heaps of about a cart-load each—more than 100 yards to the acre. I have had in some cases much more than this done ; and as the labour of burning with coal is rather less than with wood, the whole can be well done at a cost of 3*l.* 10s. per acre.

But there is another mode of procuring ashes, which, though somewhat more expensive, has its advantages ; these are that it



can be done at a time of year when the other mode would be impracticable from wet, and also that in doing it the banks, borders, and high headlands, frequently seen in old enclosures, are removed; it is by burning these in large fires of 50 to 200 yards with coal, and carting and wheeling the ashes upon the land. I have done a good deal in this way, and the cost, not including horse labour, which of course varies with the distance to which the ashes have to be drawn, is as follows:—

	£.	s.	d.
100 yards per acre, labour to burning, at 6 <i>d.</i>	.	2	10 0
2 tons of coal, at 9 <i>s.</i>	.	0	18 0
Wheeling and spreading a distance of 50 yards from the heaps, and filling and spreading the remainder, 100 yards, at 1½ <i>d.</i>	.	0	12 6
		<hr/>	
		£4	0 6
		<hr/>	

I give you the following as an instance of the effect of this latter mode.

A field of clay-land, called “Bitton”—20 acres, worth 28*s.* per acre—was wheat in 1842. During the following autumn and winter I had the banks and headlands all round the ground burned, which produced 2400 yards of ashes, 400 of which were drawn to another field. Part of the piece, about 5 acres, was planted with vetches, which were mown while green for fodder for the sheep, to eat while consuming the turnips upon the other 15; upon these 5 acres a dressing of ashes—100 yards to the acre—were spread when the vetches were removed, and after being cleaned by the requisite ploughings and scuffling, it is now planted with wheat. The crop upon this portion of the field must therefore depend entirely upon the ashes: it has derived no benefit from the vetches. Upon the 15 acres, which were dressed in like manner during the winter, where no attempt was ever before made to grow turnips in consequence of the tenacious quality of the land, and without the aid of manure of any description, except the ashes, I have had a very excellent crop; and the most extraordinary part of the matter is that, though the greater part has been eaten off in the months of October and November last, which were very wet, by nearly 400 sheep constantly kept upon them, the nature of the soil has been, for a time, so changed by the ashes that I have been enabled to plough close behind the sheep, and drill the wheat as fast as ploughed.

I need not multiply these instances further. I have dressed, in one or other of the modes I have described, upwards of 140 acres, besides using a large quantity of ashes as bottoms for dung-heaps, and where it has been done a sufficient length of time to give any result, the effect has been unvarying.

With regard to the latter mode, I should observe that success will depend entirely upon how the ashes are burned. If dug, and thrown with the spade upon the fires in large pieces, a double quantity of coal will be consumed, and the ashes of no more value than so much brick-ends. The proper mode is to move the soil with a pickaxe, breaking it all the time as much as possible; it is then put lightly upon the fires with a shovel. I would, however, advise no one to commence operations in this way without first seeing how it is done by men who have had some experience; no description would be sufficiently intelligible to enable any one, a stranger to it, to practise it with success.

That the mechanical effect of ashes in rendering heavy land friable has a great deal to do with increasing its powers of production, there can be no doubt; but it is unfortunately as certain that their effect in this way is not so great in subsequent years as in the first two or three, though it will always be considerable. This is accounted for by the natural tendency of ashes, like lime, to sink into the soil. They, therefore, in a few years become incorporated with a larger proportion of earth than at first, and their effect in rendering it more easily workable gradually diminishes; but that their virtues are not to be attributed to their mechanical effect alone, as I have heard it contended, I have proved by wheeling ashes upon the surface of part of a crop of vetches, when the part so dressed showed, in the succeeding spring, a superiority which was distinguishable as far as the field could be seen, and when the crop was cut (green) while the whole was heavy, that part to which the ashes were applied was completely rotten in the bottom.

For those who, like myself, have to undertake the task of getting a considerable tract of foul and poor clay-land into a tolerable state of cultivation, there are, to my knowledge, no means by which it can be accomplished in so short a time, and with so great a certainty, as by burning: let it be accompanied in all cases by draining; let the first crop be a green one, consumed upon the land; and the land will be at once established, and may ever after, at the least possible expense, be maintained in a productive state, provided it be kept clean and cropped in a fair and reasonable manner.

It will at all times give me pleasure to answer any inquiries you or any of your friends may make connected with this subject; or to show you or them, during the summer months, the effect upon the growing crops of the treatment I have endeavoured to describe.

Ever, my dear Sir, very truly yours,  
C. RANDELL.

*Chadbury, Dec. 19th, 1843.*

---

---

VIII.—1. *On the Influence of Water on the Temperature of Soils.*  
 2. *On the Quantity of Rain-Water and its Discharge by Drains.*

By JOSIAH PARKES, Consulting Engineer to the Society.

*To Ph. Pusey, Esq., M.P.*

DEAR SIR,—I have at length endeavoured to comply with your wish to receive an account of the few experiments I made, some years since, on the temperature of a particular soil; of the motives which induced me to enter on them; and of the practical utility to which an extended series of such experiments may be expected to lead.

The importance of an inquiry into the physical properties of different soils, and particularly into the causes affecting their state of heat and moisture, has been glanced at by various philosophers and agriculturists; but I am not aware that a systematic pursuit of it has yet engaged the attention of any British experimentalist. Mr. Handley, in his letter to Earl Spencer, which preceded the formation of the Society, has cited certain phenomena with which, it must be admitted, we are very insufficiently acquainted; and he has pointed out, as still remaining among the mysteries of nature, the action of several of her most energetic agents. He observes:—“The experimentalist might be usefully engaged in determining the temperature of the earth at its surface, and to the depths accessible to the cultivator; the influences exerted by heat, light, and air; how far they penetrate into the soil, and at what point seeds cease to germinate. The effects of different culture in promoting the absorption and retention of caloric; the extent and operation of capillary attraction; points which, hitherto much disregarded, evidently act an important part in hastening and perfecting the maturity of plants; and the study of which appears to be at least as interesting to mankind as those scientific labours which have been exercised with so much zeal to deduce the intensity of a central fire from experiments showing the increasing temperature of the body of the globe, the deeper we bore into it.”\*

I have no pretension either to the ability or the knowledge to fill up these *vacua* in the science of agriculture; it may appear, even from the following imperfect observations, that the gaps are still wider than those above recited; yet I would express my conviction that there exist no obstacles which should discourage the possessor of land and leisure from entering on this unexplored

---

\* Letter to Earl Spencer on the Formation of a National Agricultural Institution. 1838.

field of investigation; but, on the contrary, there is reason to anticipate that his labours would be made in a land of promise, and that they would be abundantly repaid.

Previously to detailing my own and other very limited experiments on the temperature of soils, it may be well to consider some of the operations of the husbandman, their intent, and the manner in which the heat and moisture of a soil may be affected by them. The two principal agricultural processes, upon which, perhaps, the fertility of land depends as much as on the artificial aids now so scientifically and beneficially applied to it, are drainage and pulverization.\* These mechanical operations are practically known to be indispensable to the full development of the natural powers of soils, as well as to the profitable employment of the numerous and costly stimulants latterly introduced into agriculture; and it is my present object to show that the temperature of soil is materially influenced by the perfection of these processes; and that each particular soil is benefited by them, according to the degree in which it may require to be artificially drained or worked. You have forcibly remarked that "all who are acquainted with improved husbandry are now agreed that, on wet land, thorough-draining is to a farm what a foundation is to a house."† Water, indeed, forms an essential element in soil, but there may be as much difference, in respect of fertility, between a *wet* soil and a *moist* one—though they be identical in other respects—as between a swamp and a garden. By drainage and pulverization the proper degree of humidity is to be attained in most soils; for, though it is wisely ordained that we cannot control the precipitation of rain, we do possess the power of regulating, within certain limits, the quantity of moisture to be retained by the earth, and of adjusting it, as it were, to the quality of the soil, and to the requirements of vegetation.

#### *Physical Action of Water.*

The consideration of the well-known effect of drainage on soils surcharged with water, naturally leads to an examination of the causes of the change produced in them by so simple an operation. A soil perfectly dry, or one perfectly wet, *i. e.* constantly drenched with water, would be nearly alike sterile; and we may conceive that some certain proportions may exist between the amounts of

---

\* The term *drainage* is here used in an extensive sense, not confining it to the construction of artificial conduits for water, nor to its application on those soils only which are reputed as *wet*. The mere acts of digging, ploughing, and working soils reputed as *dry*, do, in reality, effect drainage by opening channels for the descent of water from the superficial to the lower strata.

† Journal, vol. iii. p. 170.

heat and moisture adapted, so far as their agency is concerned, for bringing a given soil, in a given latitude or situation, to its maximum state of fertility. The researches of different philosophers have elucidated the laws which pertain to water, in its several states, as a fluid, a solid, and a vapour or steam. There is, probably, no natural substance which has been investigated with greater success, and there is perhaps no other substance which performs more numerous or more important parts in its action on soil, and in the economy of vegetable life, than water. In its chemical relations to the solid, saline, and gaseous constituents of soil there may still be something to discover; but its physical properties as regards heat, its operation as a solvent, and its mechanical laws, are sufficiently ascertained to enable us to understand, and explain satisfactorily, the various benefits that are afforded to wet soils by drainage.

If a soil be saturated with water, the nobler classes of plants cannot flourish; they vegetate more or less imperfectly, until the quantity of water be so diminished as to suit their habits. The reduction of the excess of water to the due proportion can only be effected, naturally, by its gradual evaporation, *i. e.* by its conversion into vapour; and its transition from the fluid to the æriform state is accompanied by the absorption of so large a quantity of heat from the soil in contact with it, that it may be convenient to consider its action in this respect first, and to endeavour to appreciate its amount.

When water is set over a fire in an open vessel, its temperature, as indicated by the thermometer, cannot be made by any force of fire to exceed  $212^{\circ}$ , under the mean atmospheric pressure of about 30 inches of mercury. The temperature of the water then becomes stationary, and the heat of the fire is afterwards expended in converting the water into steam or vapour. The temperature of the steam continues to be precisely that of the water, and it has been found that it requires about six times as much heat to boil off any given volume of water as would raise the temperature of that volume from  $50^{\circ}$  to  $212^{\circ}$ . Hence it is concluded that the difference, or  $162 \times 6 = 972$  degrees of heat, have passed through the water, and entered into the composition of every atom of steam. Steam, therefore, has a much greater capacity for heat than water. These continual accessions of heat are absorbed by the steam in the act of its formation, and become what is termed *latent*, *i. e.* insensible to the thermometer, which, plunged in the steam, marks only the same temperature as that of the water from which it was generated, *viz.*,  $212^{\circ}$ . This latter is termed the *sensible* or *thermometric* heat of the steam. That the whole of the heat thus expended in changing water from its fluid into its gaseous state, has entered into the steam, is proved, conversely, by condensing a

given weight of steam in water, when it is found that a pound of steam will raise about 6 lbs. of water from 50° to the boiling-point.

Water is vaporizable at all temperatures when exposed to the atmosphere. Its expulsion from the earth does even, under certain circumstances, continue when the atmosphere is replete with moisture, or at what is termed the dew-point. And it is most important to observe that at however low a temperature the water in the soil, or that of the atmosphere incumbent on it may be, at which vapour is formed and expelled, the same amount of heat is carried off by a *given weight* of vapour, as if it had been generated in the open vessel over the fire above referred to, or in the close boiler of a high-pressure steam-engine. A practical confirmation of the truth of this law has been obtained by evaporating water under widely different pressures, when it appeared that the same weight of fuel (or measure of heat) was consumed in converting equal bulks of water into steam at all those different pressures. It is ascertained that it requires as much heat as 2 or 3 oz. of coal will produce, to convert 1 lb. of water into vapour: it is, therefore, evident what an enormous quantity of heat must be taken from the soil in cases where water is allowed to remain stagnant upon it till it evaporates.

As heat is generally considered to be an imponderable body, we are without the means of ascertaining directly, by weight or measure, the quantity of heat absorbed from soil by the evaporation of water. The following illustration of it will, however, be familiar enough to the mind of the engineer, and will also, I think, enable intelligent farmers to form an idea of its immense amount.

If we suppose the rain falling on the surface of an acre of land in a year to be 30 inches in perpendicular depth, it would amount to 108,900 cubic feet = 3038 tons; which, spread over a twelve-month, gives an average of 298 cubic feet =  $8\frac{1}{3}$  tons, or 18,647 lbs. per diem. This weight of water would require, for its diurnal evaporation—supposing it were all carried off by that means—the combustion of about 24 cwt. of coals, as ordinarily used under a steam-boiler, or 1 CWT. PER HOUR PER ACRE throughout the year! We thus obtain some idea of the abstraction of heat from land under the circumstances of perfect aqueous repletion and stagnation, and there are too many soils approaching to them. We may also imagine the depression of the terrestrial temperature consequent on the abstraction of so much heat from the mass of the soil—a depression which must ever be in proportion to the excess of water present in a soil, over and above the due complement required for the supply of vegetation. Soils in that state must necessarily be very cold in the spring months, and much

colder at the time of the commencement of vegetation, and throughout the summer, than well drained or naturally drier lands. If we knew the capacity for heat of any given soil, and the weight of water mixed with it in excess, over the proper complement necessary for vegetation, it would be easy to determine, very nearly, the depression of temperature caused by its evaporation. We know that the heat of a pound of water in its gaseous state, that is, as steam, would raise the temperature of about 1000 lbs. of water one degree; so that if the specific heats of the solid and fluid bodies were alike, the evaporation of a pound of water would keep down the temperature of 1000 lbs. of earth one degree; of 500 lbs., two degrees; and so on.

Secondly; excess of humidity obstructs the absorption of heat by the solid matter of the soil. Water in a quiescent state is one of the worst conductors of heat with which we are acquainted. If it be warmed on the surface—and it derives, when mixed with soil, nearly all its heat from the sun's rays—water transmits little or no heat downwards.

If a mass of water be heated from below, the whole quickly attains an uniform temperature by reason of the motion excited amongst its particles. The lowest stratum, when heated, becomes of less specific gravity than that resting upon it, and the heavier superincumbent portions descend and push that which has been warmed upwards. In this manner rapid circulation is induced. If, on the contrary, it be heated from above, *i. e.* on the surface, the film of warmed water floats on the top, by virtue of its superior levity, and no heat is conveyed below; there is no circulation from above downwards. Much of the heat of the sun's rays is, therefore, prevented by excess of water from entering into, and being transmitted through, the mass of the soil.

Thirdly; water is a powerful radiator of heat, *i. e.* it cools quickly. All bodies, whether fluid or solid, possess peculiar powers of emitting or radiating heat, and water was esteemed by the late Professor Leslie—in which opinion he has been joined by other philosophers—to stand at the head of radiating substances.

The phenomena of the production of cold by radiation and evaporation are elegantly exemplified by the well-known experiment of exposing water, warm enough to give off visible vapour, in one saucer, and an equal bulk of water drawn from a well in another saucer. The former, on a sharp frosty morning, will be found to exhibit ice the soonest.\* The cooling powers of evaporation and radiation combined, and of radiation chiefly, or solely, are represented in this experiment by the order of congelation in

---

\* Boiling water thrown on the ground will freeze sooner than cold water.

the two vessels in time; but the difference in the quantity of heat emitted from each of them is immense, as appears from what is stated above with reference to the constituent heat of vapour.

Fourthly; as the temperature of water diminishes during the night, or in the day time, according to the varying conditions of the atmosphere, by radiating its heat to the heavens, its specific gravity increases; and the superficial stratum, which is first cooled, immediately descends by reason of its augmented density. This film of cooled and heavier water is as quickly replaced by relatively warmer and lighter portions which become cooled in turn, and successively sink. Water, therefore, though a non-conductor of heat downwards, when warmed on the surface, becomes a ready vehicle of cold in that direction when cooled on its surface; and this cooling process may even continue, under fitting circumstances, until the whole of a given mass is reduced to the low temperature of  $42^{\circ}$ , at which point water attains its maximum density. The further descent of cold through this process would then cease; but the refrigeration occasioned by it must affect all soils, to a greater or less degree, which hold water in excess, *i. e.* when in a state of stagnancy near to the surface. Those soils only can be exempt from this chilling influence which are not naturally retentive of water, or which are artificially and deeply drained.

Thus, excess of water conduces to the production of *cold* in soil, by means of several independent, vigorous, and ever active properties.

On the other hand, when a soil is naturally so porous, or is brought into such condition by art, that rain-water can sink down into the earth, it becomes a carrier, an alert purveyor, instead of a robber of heat; and tends to raise, permanently, the temperature of the mass of useful soil; and this more particularly and beneficially during the vegetative season. Rain-water, at that time, conveys downwards the more elevated superficial heat of the soil, and imparts it to the subsoil in its course to the drains; it leaves the soil in a fit state to receive fresh doses of rain, dew, and air, and in a better condition to absorb and retain heat, at the same time that it promotes, in other ways, its fertility and productiveness; but a consideration of the chemical effects attributable to the continual circulation and renewal of water and air is foreign to the present discussion.

In order to render the change of water perfect, and its action uniform throughout a field, all drains should be deeper than the active or worked soil, and covered. If drains are open, much of the rain precipitated on the surface necessarily passes into them, before it has permeated the whole mass; consequently, it carries off with it heat, which would have been usefully employed in warming the



lower strata; and it may, at the same time, remove fertilizing matter. If drains are not deeper than the worked bed, water remains below in a stagnant state, which must chill the roots of plants, and diminish the temperature of the superincumbent mass.

Gardeners and florists are well aware of the injurious influence of water when supplied constantly to the pan instead of to the surface of the soil in the flower-pot; and *bottom* water, as it is frequently and very appropriately called, produces the same ill effects when stagnating too near the surface of the great agricultural bed.

Superficial drainage is comparatively of little value, and is, perhaps, exemplified in its worst practical form by land tortured on the ridge and furrow system. When land is permanently cultivated in high ridges, the crowns can obtain but partial benefit from the action of rain. The gradation from the comparative dryness and warmth of the summit, to the suffocating wetness and coldness of the furrows, is commonly evidenced by the state of the crops grown on land so disposed.\*

#### *Physical Properties of Earthy Matter.*

The influence of drainage and pulverization on the temperature of soils is, necessarily, dependent on the habits and constitution of the solid as well as of the fluid matter composing or mixed with the soil. The variety of substances which enter into its composition; their peculiar structure; the state of their division or size of their particles; their colour; their respective powers of absorbing, conducting, and radiating heat; their bibulousness; all these properties conspire to the determination of the temperature of a given soil: and these properties are irrespective of latitude or locality. Chemists have informed us of the specific heat, of the absorbing and radiating energy of various earths, and of many soluble and insoluble bodies, when submitted separately to investigation; but we possess little or no knowledge of these relations, when such various substances are blended together, as we find them to exist in the agricultural bed. It is there we should seek for information; it is on the mass of the soil itself

---

\* It would be curious—but, possibly, more curious than useful—to learn the origin of this remarkable artificial configuration given to land, which is, I fancy, peculiar to England and to particular counties. One would think that this system must have been invented previous to the discovery that water would find its way into cut drains; or, the inventor may have considered rain as his greatest enemy, and that he ought to prevent its entrance into the soil and get rid of it as soon as possible. I once put the question, as to the utility of this process, to a few farmers in Cheshire with whom I was in company. Their notion was that an undulating, being greater than a plane surface, more stuff would grow on it. It stood to reason that such must be the case! This was debated at great length, I contending it was a fallacy. On a division I was left in a minority of one.

practical men should experiment, to ascertain the facts in question. Nevertheless, the labours of the laboratory are not to be rejected; it is by their agency, chiefly, that we have acquired our complete knowledge of the phenomena of water; and investigations conducted in the closet may materially aid the experimentalist in the field. I have extracted the following opinions and researches from the works of two distinguished British philosophers, as they relate to the affinity to moisture and heat of many bodies found in soil, and illustrate this division of the subject.

Professor Leslie, who added largely to our knowledge of the phenomena of heat and moisture, thus introduces the mention of his experiments on the hygrometric powers of some of the earths, which, for the sake of brevity and perspicuity, are collected in the following table:—

“Absorbent substances, besides assimilating to their essence a portion of the liquid which touches them, are likewise disposed to attract, though with various energy, the humidity of the atmosphere. The more solid, as well as the softer, materials exert this power, and which is exactly analogous to that of the concentrated acids and the deliquescent salts. In their several affinities to moisture the earthy bodies discover the most essential differences of constitution. To examine these properties, let the substance be dried thoroughly, and almost roasted before a strong fire, and introduced immediately into a phial with a close stopper; the powder having undergone that sort of preparation is, at any time afterwards, thrown partially into a very large wide-shaped bottle, and shut up till it has attracted its share of humidity from the confined air; and a delicate hygrometer being now let into the bottle, indicates the measure of the effect produced by absorption.”

	Degrees of Moisture Absorbed from Air at about 60°.
Clay, very highly torrefied . . . . .	8
Silica, ditto . . . . .	19
Whinstone ditto . . . . .	23
Carbonate of strontites . . . . .	23
Carbonate of barytes . . . . .	32
Clay, strongly roasted . . . . .	35
Silica, soaked in water, and dried after high torrefaction	35
Silica, in its natural state . . . . .	40
Carbonate of lime . . . . .	70
Shelly sea-sand . . . . .	70
Carbonate of magnesia . . . . .	75
Sea-sand, from a sheep-walk . . . . .	78
Whinstone, in its natural state . . . . .	80
Alumina . . . . .	84
Pipeclay . . . . .	85
Sea-sand, cultivated . . . . .	85
Whinstone, in a crumbling state . . . . .	86
Ditto, reduced to mould . . . . .	92
Garden mould . . . . .	95

Leslie remarks that "the absorbent power of the earths depends as much on their mechanical condition as on the species of matter of which they are composed. Whatever tends to harden them diminishes the measure of their effect; and hence, apparently, the reason why the action of fire impairs their desiccating quality."\*

Useful as is this contribution to the philosophy of soils, it must be deemed very remarkable that the ingenious author altogether omitted to investigate the relation of the same substances to the absorption of heat as well as moisture. The importance of ascertaining these double relations did not, however, escape the sagacity of Davy, who preceded Leslie in this research, and whose remarks are so pertinent, and possess such intrinsic worth, that I trust the citation of them will not be thought tedious:—

"Many soils are popularly distinguished as *cold*; and the distinction, though at first view it may appear to be founded on prejudice, is really just.

"Some soils are much more heated by the rays of the sun, all other circumstances being equal, than others; and soils brought to the same degree of heat cool in different times, *i. e.* some cool much faster than others.

"This property has been little attended to in a philosophical point of view, yet it is of the highest importance in agriculture. In general, soils that consist principally of a stiff white clay are heated with difficulty; and, being usually very moist, they retain their heat only for a short time. *Chalks* are similar in one respect—that they are difficult to heat; but, being drier, they retain their heat longer, less being consumed in causing the evaporation of their moisture.

"A black soil, containing much soft vegetable matter, is most heated by the sun and air; and the coloured soils, and the soils containing much carbonaceous matter, or ferruginous matter, exposed under equal circumstances to the sun, acquire a much higher temperature than pale-coloured soils.

"When soils are perfectly dry, those that most rapidly become heated by the solar rays likewise cool most rapidly, their power of losing heat by radiation being the greatest; but I have ascertained by experiment, that the darkest-coloured dry soil (that which contains abundance of animal or vegetable matter—substances which most facilitate the diminution of temperature), when heated to the same degree, provided it be within the common limits of the effect of solar heat, will cool more slowly than a wet pale soil, entirely composed of earthy matter.

"I found that a rich black mould, which contained one-fourth of the vegetable matter, had its temperature increased in an hour from  $65^{\circ}$  to  $88^{\circ}$  by exposure to sunshine, whilst a chalk soil was heated only to  $69^{\circ}$  under the same circumstances. But the mould removed into the shade, where the temperature was  $62^{\circ}$ , lost, in half an hour,  $15^{\circ}$ ; whereas the chalk, under the same circumstances, had lost only  $4^{\circ}$ .

---

\* Leslie, on Heat and Moisture, p. 96, 1818.

“A brown fertile soil and a cold barren clay were each artificially heated to  $88^{\circ}$ , having been previously dried. They were then exposed in a temperature of  $57^{\circ}$ . In half an hour the dark soil was found to have lost  $9^{\circ}$  of heat; the clay had lost only  $6^{\circ}$ . An equal portion of the clay containing moisture, after being heated to  $88^{\circ}$ , was exposed in a temperature of  $55^{\circ}$ . In less than a quarter of an hour it was found to have gained the temperature of the room.\* The soils, in all these experiments, were placed in small tin-plate trays, two inches square, and half an inch in depth; and the temperature ascertained by a delicate thermometer.

“Nothing can be more evident than that the genial heat of the soil, particularly in spring, must be of the highest importance to the rising plant; and when the leaves are fully developed, the ground is shaded, and any injurious influence, which in the summer might be expected from too great a heat, entirely prevented: so that the temperature of the surface, when bare, and exposed to the rays of the sun, affords at least one indication of the degrees of its fertility; and the thermometer may be sometimes a useful instrument to the purchaser or improver of lands, &c.”—*Agricultural Chemistry*.

The chapter containing these experiments and opinions of Sir Humphry Davy will supply many other useful hints for the guidance of the experimentalist in his inquiry into the causes of the varying temperature of soils. I will select only one other short extract from the well known lectures of this eminent man, as it records information touching the affinity of some particular soils to moisture, the fertility and rent-value of which he quotes as being pretty nearly in the ratio of their hygrometric powers.† The soils were first dried at a temperature of  $212^{\circ}$ , and then exposed to air saturated with moisture at  $62^{\circ}$ :—

---

\* A remarkable confirmation of what has been before stated of the chilling effect of evaporation.—J. P.

† Schübler has criticised this opinion of Davy's (*Journal*, vol. i. p. 197). He observes, “The assumption of Davy that this capacity of absorption possessed by a soil was to be received as a *conclusive* proof of its fertility, is liable, therefore, to many exceptions; and, if applied without modification, might easily mislead.” Excepting in one instance, Schübler's experiments appear to confirm, very closely, Davy's observation,—“I have compared the absorbent powers of many soils with respect to atmospheric moisture, and I have always found it greatest in the most fertile soils: so that it affords *one* method of judging of the productiveness of land.” I have not noticed that Davy has anywhere spoken of it as a *conclusive* method. Davy, Leslie, and Schübler all agree on the fact of garden mould being the most absorbent of all soils. Davy specially excepted the case of a pure clay; and Schübler also instances that earth, as an exception to the general law deduced by both philosophers, that the fertility of soils is pretty much in the ratio of their powers of absorbing and retaining moisture. Schübler has made a step in advance of Davy, by his elaborate experiments tending to establish the fact that moisture in earth is a preparation for its absorption of oxygen, and consequently that the attraction of soils for moisture is a property of first-rate importance to agriculture.

	Gain of moisture in an hour. Grains.
“ 1000 grains of a celebrated soil from Ormistown, in East Lothian . . . . .	18
1000 grains of a very fertile soil from the banks of the river Parrett, in Somersetshire . . . . .	16
1000 grains of a soil from Mersea, in Essex . . . . .	13
1000 grains of a fine sand from Essex . . . . .	11
1000 grains of a coarse sand . . . . .	8
1000 grains of a soil from Bagshot Heath . . . . .	3”

In reflecting on the results of these isolated experiments, and on the conclusions drawn from the consideration of some single property of soils (whether they be just or otherwise), the philosophic mind cannot fail to perceive how infinitely more valuable such experiments would be to the agriculturist were they combined with direct indications of the actual constitution of the same soils in their natural state, and under culture, as regards their attraction for heat and moisture. May it not be reasonably expected that a well-conducted series of experiments on these phenomena would illustrate some of the causes which conduce to render certain soils in a higher latitude more productive than others in a more southern one? Might they not serve to detect fallacies in reasoning or practice—to show, possibly, that effects have been attributed to wrong causes—and to unfold to our perception a clearer and more correct knowledge of the workings of nature?

From the foregoing review of the physical properties of soils, in relation to heat and moisture, and of the action of water in warming or cooling them, it will be seen that a very remarkable difference obtains between the properties of the fluid and solid bodies. It appears that water absorbs heat rapidly, but can only convey it downwards by itself descending into the earth; that the heat which it receives from the solar rays is again projected into the atmosphere by radiation, and in combination with vapour, when it remains stagnant on or near to the surface; whereas, solid substances impart the heat which they absorb to all surrounding matter, in all directions (though with different degrees of rapidity), as well as to the atmosphere. There is yet another important effect arising from the radiating force of solids to notice. As the sun verges towards the horizon, the superficial layer of the earth becomes colder than the atmosphere, causing the precipitation of dew, which the affinity of earthy matters to moisture enables them to absorb, and thereby to recruit in part, by night, the loss of moisture which has taken place during the day. Water also radiates heat powerfully, but it does not attract moisture to itself, except under very peculiar and rare circum-

stances: hence, again, the advantage of drainage. These important processes, viz., the absorption of moisture, and the radiation of heat, will be carried on with more or less energy in proportion to the inherent qualities of a soil, to its state of mechanical preparation, and to the proper adjustment of its supply of water.

#### *Cause and Physical Action of Dew.*

The quantity of moisture attracted from the atmosphere, in the form of dew, is unknown; but the cause, and many of the laws of its formation, deposition, and physical action, have been disclosed to us by the talents and labours of Dr. Wells, whose experiments and Essay on this subject stand almost unrivalled in the records of science, as examples of skilful investigation and profound induction.\* Previously to the conclusive experiments of this admirable philosopher, the formation of dew was held to be the *cause* of the cold observed with it, and he originally entertained the same opinion.

“But,” he observes, “I began to see reason, not long after my regular course of experiments commenced, to doubt its truth, as I found that bodies would sometimes become colder than the air, without being dewed; and that, when dew was formed, if different times were compared, its quantity, and the degree of cold which appeared with it, were very far from being always in the same proportion to each other. The frequent recurrence of such observations at length converted the doubt of the justness of my ancient opinion into a conviction of its error, and at the same time occasioned me to conclude that dew is the production of a preceding cold in the substances on which it appears.”

Further—

“that the cold which produces dew is itself produced by the radiation of heat from those bodies upon which dew is deposited.”

Thus it was discovered that an *effect* had heretofore been mistaken for a *cause*; and the explanation of the various phenomena connected with the subject, afforded by this theory, has since remained unchallenged, and is admitted to be incontrovertible.

Besides the determination of the immediate cause of dew, Dr.

\* The original ‘Essay on Dew,’ which appeared in 1814, is very scarce, but is republished in the ‘Works of Dr. Wells’ (1818), containing a memoir of his life, written by himself.

A distinguished living philosopher thus writes of this theory, after making a concise but searching analysis of it:—“We have purposely selected this theory of dew, first developed by the late Dr. Wells, as one of the most beautiful specimens of inductive experimental inquiry lying within a moderate compass. It is not possible, in so brief a space, to do it justice; but we earnestly recommend his work (a short and entertaining one) for perusal to the student of natural philosophy, as a model with which he will do well to become familiar.”—*Discourse on the Study of Natural Philosophy*, by Sir J. F. Herschel, 1832, p. 163.

Wells ascertained, among other phenomena affecting the temperature of soils, that the attraction of substances for water is not exactly proportional to their radiating energy; and that—

“the formation of dew not only does not produce cold, but, like every precipitation of water from the atmosphere, produces heat.”

As the earth becomes colder than the atmosphere on dewy nights, by reason of its radiating energy, and as the moisture suspended in the latter possesses the atmospheric temperature, dew, with respect to the surface of the earth, is warm. Were it not that this antagonist warning process counteracts, on cloudless and serene nights, the rapid escape of heat from the earth by radiation, it is probable that the temperature of the soil would be depressed, during the sun's absence, by a greater amount than it is elevated during its presence; and that the extremes of heat and cold, or the vicissitudes of temperature, during 24 hours, might be so great as to destroy vegetable life in the summer season. The least experienced observer may easily satisfy himself of the superior cold of the earth's surface on clear nights, relatively to that of the atmosphere. Hoar-frost, which is frozen dew, frequently forms on grass when the thermometer in the air indicates a temperature some degrees higher than the freezing point; a phenomenon showing that the earth, or the leaves of plants, were colder than the atmosphere, and below the freezing point, when the deposition took place. In Bengal, ice is (or was) procured artificially, on a large scale, and for profit, by exposing water to the sky in porous earthen pans placed in shallow pits. The difference of temperature between the air and the water, at the time of its congelation, has often been observed, on clear serene nights, to amount to  $14^{\circ}$ , and even  $16^{\circ}$ . The air near the ground must then have had a temperature of about  $46^{\circ}$  or  $48^{\circ}$ .

The genius of Davy would appear to have almost divined the mystery of dew-making, even before the complete revelation of its true and only cause by Dr. Wells, as may be gathered from the following profound remark:—

“The power of soils to absorb water from air is much connected with fertility. When this power is great, the plant is supplied with moisture in dry seasons; and the effect of evaporation in the day is counteracted by the absorption of aqueous vapour from the atmosphere, by the *interior* parts of the soil during the day, and by both the *exterior* and *interior* during the night.”—*Agricultural Chemistry.*

If a soil be sufficiently permeable to air, and not saturated with water, it is in a state to receive accessions of moisture from the atmosphere, which is a constant and inexhaustible vehicle of humidity; and if the temperature of a sufficiently porous subsoil be at, or below the dew-point, as will frequently be the case during some portion of the day, in the summer season, the process of de-

positing dew will take place in "the interior parts of the soil during the day," at the same time that the exterior, or surface of the ground, may be projecting both heat and moisture into the atmosphere. This process is evidently dependent on the relative temperatures and degrees of aqueous repletion of the air and sub-soil at a given time; and independent of the hygrometric power of the latter, which is, however, a potent auxiliary to the acquisition and retention of atmospheric moisture by soil, particularly in its interior parts. Thus, it is apparent that the acquisition of moisture by soils in the form of dew, is not limited to the period of the night only, nor to the surface of the earth; and it has been shown that the precipitation of dew cannot take place without the communication of heat to the recipient substance: hence, the importance of sufficient pulverization to permit access and change of air to the interior parts of soil. One of the most beneficial effects of drainage may be also safely presumed to arise from its facilitating the access, and change, of air to the very bottom of the bed; as, in proportion to the escape of water, so will be the entrance of the air, which will, *pari passu*, occupy the place vacated by the water.

Every observant farmer must have remarked that the amount of dew precipitated during the same night varies greatly on different soils in fallow, and still more on the leaves of different plants. Well pulverised soils attract much more dew than those which are close and compact, as the radiation of heat is effected from many more points in highly comminuted than plane surfaces. Sands appear to be powerful attractors, and in some countries to depend altogether on the nightly deposition of moisture for the support of vegetation. An extreme example of the derivation of the aqueous element from dew alone, and of its highly fertilising qualities, is afforded by the fact that, on the sandy plains of Chili, rain is scarcely ever known to fall; yet that soil, which under other circumstances would be sterile, is maintained in a productive state by the active forces of radiation and absorption. The temperature of the soil is moderated during the period of the sun's action by the large amount of heat carried off combined with vapour; whilst the exhausted humidity is replaced by dew, deposited during the resplendent nights of that tropical region. Instances are also on record of the flourishing growth of trees in Africa on sandy districts, never refreshed by rain nor springs, nor by artificial supplies of water: whilst soils of another nature, in the same latitude, and not far distant, require irrigation to enable them to sustain vegetable life.

It is to the copious dews of our own country that we have in great measure to attribute the productiveness of the meadows border-



ing streams and rivers. The atmosphere, in the neighbourhood of currents of water, becomes more highly charged with aqueous vapour than that of the uplands; and as the air transports and disperses this moisture over the adjoining fields, it is condensed and precipitated during the night by the process discovered and illustrated by Dr. Wells.\* The finely-divided and filamentous structure of the grasses renders them, in addition to their demand for aqueous nutriment, peculiarly suitable for culture in these localities. It is worthy of notice that the leaves of different plants appear to act in somewhat different ways as to their mode of receiving and disposing of dew. A blade of grass is sometimes spangled over with dew-drops, but it usually becomes wetted throughout its whole surface by the running together of the drops, and thus conducts the water to the earth in minute streamlets; whereas, the leaves of the clover, cabbage, nasturtium, and many other plants, will be found to collect it in distinct globules, which may be rolled about on the leaf without appearing to moisten it. These drops, in fact, do not touch the leaf, but rest and roll upon a pillow of air interposed between them and the substance of the leaf. I have not unfrequently procured a tea-cup full of dew, early in the morning, from the leaves of a single cabbage-plant; and, on very translucent nights, I have seen, whilst watching this elegant and interesting process, the tender clover-leaf bend beneath the weight of its crystal load, discharge it on the ground, and immediately begin to accumulate another globule. In the course of three or four hours I have observed as many collections and discharges of dew by the same leaf. The gradual diminution of the size of these drops of water, by evaporation, as the sun exerts its influence, has often struck me to be the means provided by nature for preparing plants to sustain his increasingly-ardent rays without injury; and it is generally after nights of copious deposition of dew that the mornings are the brightest, and the sun's heat the most powerful. Cup-formed and horizontal leaves and flowers seem to retain all, or nearly all, their collected dew for their special use, as if it were more beneficial to them when so applied than to their roots.

---

\* The French expression, that a river *bedews* (arrose) a country, is more correct than the English one, that it *waters* it. The watering of land is, properly, an artificial, the bedewing of it, a natural, process. The distance from its banks to which a river can saturate soil with water is rarely great; though it is in this acceptation that I have known many persons and authors to understand and use the phrase *watering*. A river, deep within its banks, will bedew a country as well as one bank-full; but the former acts as a drain to the land, and therefore does not directly moisten the surface of the soil. The term *watering*, in agriculture, should be limited to what we understand by *irrigation*.

Popular belief is often founded on correct observation, and sound practice is not unfrequently in advance of science. It also not uncommonly happens that the evidence of practical truths is received with scepticism, because we are unable, immediately, to "interpret nature," and frame a satisfactory theory or explanation of the origin of particular phenomena. Hence the discovery of causes is of the highest importance to the arts, and a correct theory of any action so rapidly accelerates, extends, and perfects sound practice, that we cannot too highly prize its possession. This admitted truth, together with the rarity of Dr. Wells's 'Essay,' will, I trust, form a sufficient excuse for introducing the mention of phenomena explained by his theory of dew, which, though not directly affecting the soil itself, are of no slight consequence to the cultivators of the soil:—

"The bare mention of this article," Dr. Wells observes, "will be apt to excite ridicule, it being an attempt to show in what way the exposure of animal substances to the moon's light promotes their putrefaction.

"I have no certain knowledge that such an opinion prevails anywhere at present, except in the West Indies; but I conclude, from various circumstances, that it exists also in Africa, and that it was carried thence by negro slaves to America. It was entertained, however, by persons of considerable rank and intelligence among the ancients; for Pliny affirms it to be true, and Plutarch, after making it a subject of discussion in one of his Symposia, admits it to be well founded.

"As moonbeams communicate no sensible heat to the bodies on which they fall, it seems impossible that they can, directly, promote putrefaction. But still a reason for ascribing such a power to them may be derived from their being received by animal substances at the very time that a real but generally unnoticed cause of putrefaction in warm climates (and it is in these alone the opinion I am treating of has ever prevailed) is taking place, which ceases to act as soon as the moon's light is excluded.

"The nights on which a steady moonshine occurs must necessarily be clear, and nights which are clear are almost always calm. A moonshiny night, therefore, is one on which dew forms plentifully; hence the expressions 'roseida' and 'rorifera luna,' employed by Virgil and Statius; and hence also an opinion, held, as appears from Plutarch, even by philosophers among the ancients, that the moon communicates moisture to the bodies which are exposed to its light.

"Animal substances are among those which acquire dew in the greatest quantity. To do this, indeed, they must previously become colder than the atmosphere; but, having acquired the moisture of dew, in addition to their own, they will, on the following day, be in that condition which is known by experience to favour putrefaction most powerfully in hot climates.

"The immediate cause assigned here for the putrefaction of animal substances which have been exposed to the moon's rays in a hot country,

is the same as that given by Pliny and Plutarch ; but they attributed the origin of this immediate cause, the additional moisture, to the peculiar humefying quality which they supposed that luminary to possess. This false theory has probably contributed to discredit, with the moderns, the circumstance which it was employed to explain.”—*Essay on Dew.*

The belief that moonshiny or clear and dewy nights advance the process of putrefaction is not altogether confined to the ancients or to tropical climates, as was supposed by Dr. Wells. I had personally noticed the phenomenon of an increased putrefactive vigour in dungheaps, after nights of a copious precipitation of dew, succeeded by hot days, some years before I was acquainted with Dr. Wells’s ‘*Essay* ;’ and I frequently conversed on this subject with an intelligent and observant farmer near Warwick, who corroborated my idea that such was the fact. Several farmers have recently confirmed this early opinion ; and it is very common in France, among the numerous peasant-farmers near Paris. During a residence of several years in that country, my house being surrounded by small, unenclosed, and variously-cropped plots of ground, with a heap of night-soil or dung usually contiguous to each, the sense of smell somewhat too frequently informed me of extreme activity in the putrefactive process. On inquiring of the peasants how it happened that, on certain mornings, the odour was so pungent, they commonly replied, “*It is owing to the dew of last night, Sir ;*” but I do not recollect that any one of them imputed the effect to the moonbeams.

A knowledge of all that is requisite for the perfect preparation and management of dung is yet a desideratum in agriculture. Means of accelerating and retarding, at will, the putrefactive process, are much needed. The study of this art is certainly worthy of closer attention, and more exact experiment, than it has yet received. A movable roof-shelter might be a useful adjunct to the sunken pit, or raised mass, in order to obtain command over the meteorological agents—air, heat, and water ; each of which performs a part in the process ; and more frequently to the injury than to the benefit of that species of manure which, home-made, and the most natural, if not the most beneficial, to the farmer.

“*I had often,*” says Dr. Wells, “*in the pride of half-knowledge, smiled at the means frequently employed by gardeners to protect tender plants from cold, as it appeared to me impossible that a thin mat, or any such flimsy substance, could prevent them from attaining the temperature of the atmosphere, by which alone I thought them liable to be injured. But, when I had learned that bodies on the surface of the earth become, during a still and serene night, colder than the atmosphere, by radiating their heat to the heavens, I perceived immediately a just reason for the practice, which I had before deemed useless.*”

He then ascertained by experiment that

“A difference in temperature of some magnitude was always observed, on still and serene nights, between bodies sheltered from the sky, by substances touching them, and similar bodies which were sheltered by a substance a little above them.” “Possibly,” he continues, “experience has long ago taught gardeners the superior advantage of defending tender vegetables from the cold of clear and calm nights, by means of substances not directly touching them, though I do not recollect ever having seen any contrivance for keeping mats, or such like bodies, at a distance from the plants which they were meant to protect.”

It is a common practice in France to cover transplanted vegetables by linen sheets placed over sticks about two feet high. All the spare linen of my own house has been occasionally borrowed for this purpose; and I have laid my friends equally under contribution, until tender plants were sufficiently rooted, and strong enough to bear complete exposure to the heat of the sun and the cold of the night.

May it not possibly be of advantage to the agriculturist to protect his potatoes, turnips, or other stored roots, from frost, by means of impermeable portable cloths stretched at a convenient height, instead of with earth, straw, &c. placed upon them? When substances touch each other, heat is conducted from the mass, and finally radiated away into space; cold results, and the roots are frost-bitten. The experiment may be worth a trial.

Mr. Graburn has communicated to me a remarkable phenomenon connected with hoar-frost, which is, perhaps, generally known to farmers, but, if not, the mention of it will convey a useful warning. He has remarked that the passage of a flock of sheep across a clover field covered with hoar-frost, particularly young spring clover, is certainly followed by the destruction of every leaf over which the animals have passed. He further aptly observes, “You might trace the footsteps of a thief across a clover field covered with hoar-frost, at noon the day following, by the withering of the grass in his track.” Knowing, as we do, that hoar-frost is a great protection to the leaf against further accession of cold, we might be disposed to attribute the death of the leaf, indirectly, to the shaking off of the frozen dew; but it is possible that the proximate cause is purely mechanical, and the withering the direct effect of injury from the tread, when the leaves are so crisp as to be in a state to be bruised by a sufficient weight pressing on them. The cause would be manifested by ascertaining whether the leaf, under the circumstances, would perish if the hoar were carefully brushed off it, and not trampled.

*Experiments on the Temperature of Soils.*

*Schübler's Experiments.*—This subject appears to have attracted the attention of several German philosophers, who have investi-

gated it with their habitual minuteness of research. The excellent translation of Professor Schübler's learned work, in vol. i. of our Journal, renders it necessary to do little more than refer those persons to it who would pursue the same track of investigation. The inferences drawn by him, from experiments in the laboratory, confirm generally those of Davy and Leslie. They are, however, chiefly of an elementary nature, and though more comprehensive and precise, perhaps even more accurate, than those of the British chemists, this valuable treatise seems to present nearly the same blanks, as respects useful practical experiments on the bed of the soil, as the labours of our own countrymen. We shall all agree in the truth of the Professor's concluding paragraph; viz., that—

“Those very soils may be fertile for one country which become no longer so for another, under a change of external circumstances.”

It is the difference in these external—*i. e.* in the meteorological conditions of the surface of our globe which evidently renders identical systems of cropping, husbandry, and management, inapplicable to all climes. It is this difference, also, which must clearly point out to the agriculturist that if he would draw any useful deductions from experiments on the temperature of soil, they must be made on his own soil, or on like soils similarly circumstanced. In Britain we have, generally speaking, to combat excess of moisture, accompanied by a low and inconstant solar heat. It is one of my objects to show that, *by establishing a free passage for water through the soil, the greater heat of the surface may be carried downwards, and the mean annual temperature of the mass of the soil thereby permanently raised.* This position, as well as the effect of removing excess of water, is well illustrated by Schübler in the section wherein he treats of the “*Influence of Moisture on the Warming of Soils.*” He states “*the depression of temperature arising from the evaporation of their water amounts to 11¼° or 13½° Fahr.;*” though the method by which he obtained this thermometric quantity is not mentioned, which is to be regretted. In the tenth section, however, wherein he treats of the “*Capacity of soils to develope heat within themselves on being moistened,*” the following passage occurs:—

“The falling rain, in warm seasons, is many degrees colder than the lower stratum of the atmosphere, and the upper surface of the earth which it moistens; so that the earth in hot weather becomes rather cooled than otherwise”

This remark might seem to militate against the doctrine herein advanced, that the mass of the soil is warmed by rain when suffered to permeate it; but such opinion will, I think, vanish on

further consideration, and by reference to Schübler's own experiments on the temperature of soils at Tübingen and Geneva.

At Tübingen his experiments were directed to the ascertainment of the mean highest temperature of the earth by a thermometer placed on its surface,—

“the bulb being covered only  $\frac{1}{2}$ th of an inch high with earth: these observations were recorded in perfectly fine weather, between noon and one o'clock, whenever the weather happened to be perfectly fine at that part of the day.”

It appeared that during the six hottest months, from April to September inclusive, the mean temperature of the surface was  $131^{\circ}.4$ . Now it is evident that, if rain fell upon the earth when it was so highly heated, the surface must be cooled by it; but it is equally evident that the substrata would be warmed; for the temperature of the atmosphere in the shade, which was also recorded at the same hour, was  $70^{\circ}.4$ ; and that of rain, had it then fallen, would have been much the same. Thus, the rain, on reaching the earth, would acquire a temperature of about  $100^{\circ}$ , and communicate heat, as it descended, to the underlying portions of soil possessing a lower temperature.

His experiments at Geneva, in 1796, give the mean heat of the soil on its surface—at 3 inches—and at 4 feet below it. The observations were taken every day, in all weathers, and therefore, as described by the Professor, “in variable weather.” The mean temperature, denoted during the corresponding six months of the year before-mentioned, was—

	Degrees.
On the surface, . . . . .	86.7
At 3 inches below, . . . . .	69.8
At 4 feet below, . . . . .	60
Temp. of air in the shade. . . . .	59.7

On these results the author observes:—

“The elevation of temperature by the rays of the sun was, therefore, considerably less” (than at Tübingen), “according to the average results of these observations, because the temperature of the upper surface of the earth on cloudy and rainy days often accords exactly with that of the air; but, on the other hand, they give us more accurately the mean temperature of the ground at some depth.”

These experiments denote that, if the mean temperature of the rain, during the six months, accorded with that of the air, it would receive, on reaching the earth, an augmentation of thirteen and a half degrees of heat, and sink downwards at a temperature of  $3^{\circ}.4$  higher than that of the soil at 3 inches deep, and of  $13^{\circ}.2$  higher than that of the soil at 4 feet below the surface; thus supplying at the same time heat and moisture to the underlying soil. His table also shows that, on the mean of the whole

year, the increase of temperature imparted to the soil by the rain would have been  $2^{\circ}.4$  at 3 inches, and  $6^{\circ}.1$  at 4 feet deep. Schübler's remark, therefore, "that the earth in hot weather becomes rather cooled than otherwise" by rain, is only applicable to the effect produced on its superficies, which is there beneficial.

The section of this author's Treatise on the "Influence of Moisture on the Warming of Soils" must be deemed incomplete, by reason of the absence of all reference to the warming effect of dew: which—whether it be considered as directly communicating heat to the surface of soil necessarily colder than itself at the time of its precipitation, or as diminishing to a great extent the radiation of heat from the earth to the heavens—is an agent which performs an energetic part in maintaining a sufficiency both of heat and moisture in the mass of the soil.

*Leslie's Experiments.*—In the Supplement to the 'Encyclopædia Britannica,' Art. Climate, written by Professor Leslie, will be found a table of experiments on the temperature of the earth, for each month of the years 1816 and 1817, at four different depths, viz. 1, 2, 4, and 8 feet below the surface. They were made at the instance of Mr. Ferguson of Raith. It is stated that the instruments were sunk "in a soft gravelly soil, which turns, at 4 feet below the surface, into quicksand, or a bed of sand and water." As it does not appear that these experiments were conducted with any other intent than to assist Leslie in some deductions relative to isothermal lines, and to the correspondence which might subsist between the mean annual atmospheric temperature of a given parallel of latitude, with that of springs and of the earth at certain depths, I have thought it unnecessary to extract the Table. Such deductions are, at best, very vague, nor are they calculated, in the slightest degree, to illustrate the physical properties of the various soils which form the crust of our globe, and which come within the province of the farmer; neither can they serve to assist his judgment in the management of them. The mere determination of the heat of the earth "at depths accessible to the cultivator" is useless, unless the observations be so conducted and recorded as to lead to the discovery of the circumstances which influence its temperature. I had the advantage of passing several days, about 20 years since, in company with Leslie, at the house of the late Lord Rosslyn in Fifeshire, and he took me to Mr. Ferguson's of Raith, to show me the thermometers in the ground. They were then, if I recollect right, two in number, and sunk in grass-land, the one descending 12 inches, the other 36 inches below the surface. Leslie's mind was, at this time, so pre-occupied with his newly invented instruments, the photometer, differential thermometer, hygrometer, &c.—with which his hands and his pockets were filled—that I was unable to engage his attention, seriously,

as to the practical use which I submitted to him might be made of observations on the temperature of soils. It was at this period I resolved to commence some experiments on the subject, but a fitting opportunity did not occur till 1837.

*My own Experiments.*—The site of the few experiments which I have now to describe as made by myself, was a peat-bog called Red Moss,\* near Bolton-le-Moors, in Lancashire, in its nature identical with Chat Moss, and approaching, in many parts of it, to that consistence which would cause it, in Scotland, to be designated a flow-moss, from its semifluid character. The depth of the bog, at the spot where the thermometers were inserted, was nearly 30 feet; and its temperature from 12 inches beneath the surface, downwards to the bottom, was uniformly 46°. I never found any variation to occur in the results afforded by thermometers placed at various depths during nearly three years' observations; excepting in the winter of 1836, when the thermometer nearest the surface fell to 44° for a few days.

To this uniformity of temperature throughout the mass of the natural bog, I shall, subsequently, have to call your attention very particularly, as it seems to stamp with certainty the fact, that the more elevated temperatures, marked by the thermometers in the cultivated bog soil, were solely due to the change effected in its mechanical condition, and to the removal of stagnant water. There were no springs, so far as I could ascertain, in this bog, nor could I ever perceive that water rose from the bottom of any drain cut in it. The substratum, on which the bog had accumulated and reposed, consisted of a retentive white marl, abundantly mixed with limestone gravel. The temperature of the water drawn from the bottom of a coal-pit contiguous to the bog, and 300 feet deep, was 54°; and that from a bore, or Artesian well, near my house, and 160 feet deep, was invariably 52°.

The exposure of the bed in which the thermometers were sunk was perfect. There existed no bush higher than a tuft of heather within a radius of half a mile: not a ray, therefore, of the sun's light and heat, could be intercepted (except by clouds) between his rising and setting.

The preparation of the bed was as follows:—The surface had been ploughed in 1836 by the steam-plough, to a depth of 9 inches, and was well pulverized. A plot of about 216 square yards area, clear of the drains, was divided into twelve beds intended for experimental culture. Each bed was 6 yards in length by 3 yards in breadth; and each was insulated from its neighbour, and from the surrounding bog, by an open drain,

---

\* It was on this moss that the writer undertook the construction and conduct of Mr. Heathcoat's patent machinery for cultivating bogs by steam-power.



24 inches broad at top, 12 inches at bottom, and 36 inches deep. Previously to opening these drains the plot had been surrounded by a catchwater drain, 38 inches deep, communicating with a main drain 40 inches deep. The pulverized surface was then drawn to a heap, the enclosed plot dug 3 feet deep, the intermediate drains opened out, and the superficial soil replaced. In this state it remained through the winter of 1836 and 1837. Had the thermometers been ready, they would have been sunk in the bed as soon as prepared, but I could not obtain them from the maker and plant them, till June 1st, 1837.

The thermometers were five in number, each being enclosed, throughout its length inserted in the ground, in an iron tube open at the bottom, with holes perforated round the bulb. They were firmly connected together by iron clamps, and the whole formed a stiff portable frame. The glass stems rose 10 inches above the ground. These were sustained against the wind or accident by a skeleton framing of metal carrying the scales divided into degrees and tenths. A hole being dug in the centre of one of the plots, the frame was let into it and set in the line of the meridian, so that the stems above ground might cast the least possible shadow on it at noon. The soil was carefully replaced about the thermometers so as to preserve, as nearly as might be, the order of its texture and consistence throughout the mass of the bed. At the same time a naked thermometer was inserted to the depth of 7 inches in the natural bog adjoining. I did not commence any regular register of the indications until June 7th, being desirous that the thermometers should first become well settled in the soil, and arrive at what may be called a true working state.

It is necessary to state that, on the bed in question, there was no kind of seed sown, nor a plant of any kind growing; my purpose having been to ascertain, in the first instance, the influence of the sun's rays, of rain, dew, and other atmospheric agents, upon the naked natural soil; and, subsequently, with other sets of thermometers, to acquire some knowledge of the effect which might be produced on the temperature of such soil by the admixture of manure and foreign substances. Whether this be the proper mode of proceeding, abler judges will decide; but, it would appear to be difficult to detect the true physical characteristics of a soil, by apparatus applied in the middle of a corn-field; and I thought it desirable to attempt to discover the properties of the natural soil first, and then of mixed soil, before proceeding to investigate similar phenomena on similar soils under crop. An industrious experimenter might carry on all these separate investigations at the same time; since, after his sets of thermometers are placed, he has only to observe and record:—

1837.	Depth of the Thermometer bulbs below the Surface.					Time of Observation.	Direction of the Wind.	Temperature of the Air 4 feet from the Ground in the Shade.	Remarks.		
June.	Inches. 31	Inches. 25	Inches. 19	Inches. 13	Inches. 7						
	Temp.	Temp.	Temp.	Temp.	Temp.	Hour.		°			
7	46° ..	47° ..	48°·4 ..	50° 50·5	52° 55	9 A.M. 2 P.M.	S.W. by S. W.	° ..			
8	.. ..	.. ..	.. ..	50 ..	51 52·5	9 A.M. 2 P.M.	S.E. ..	.. ..	Cold day.		
9	46·1 ..	47·2 ..	.. 48·5	49 49·5	49 52·8	9 A.M. 2 P.M.	E. W.S.W.	.. ..	Cold and hazy. Clear and warm.		
10	46·2 ..	.. ..	48·6 ..	50 50·5	53 54	9 A.M. 2 P.M.	S. ..	.. 70	Rain during the previous night; splendid sun all day.		
11	46·3 .. .. .. .. .. .. .. ..	47·4 .. .. .. .. 47·5 .. .. ..	.. .. .. .. .. 48·7 .. .. ..	51 52 .. 52·5 .. 52·3 51·5 .. 51·3 51·2	55 56 57 57·5 58 59·1 59 57·5 57 56 55·5 55 55	9 A.M. 10 ,, 11 ,, Noon. 1 P.M. 2 ,, 3 ,, 4 ,, 5 ,, 6 ,, 7 ,, 8 ,, 9 ,,	.. .. .. .. .. .. .. .. .. .. .. ..	65 68 .. .. .. .. .. .. .. .. .. ..	Throughout the day no visible cloud. Much hotter than the 10th; but, unfortunately, the air thermometer was broken after 10 A.M. The surface of standing water was 60° at that hour, and the surface of the bed 75°.		
	12	46·5	47·4	..	51	55	9 A.M.	W.S.W.	..	Warm showers.	
	13	46·8	48	48·8	52	59	2 P.M.	W.S.W.	..	Hot; a shower at 11 A.M.	
	14	47·2	48·4	50·4	53	60·4	Noon.	S.	..	Hot and dry.	
	15	47·25	48·6	50·8	53	57·6	9 A.M.	S.W.	..	Very hot; cloudless.	
	16	47·6 47·8 .. .. 47·9	49 49·6 .. .. 49·9	51·4 52 .. 51·8 51·9 52 52·5	54·2 55 .. 54 55 57 55·5	60 63 64 62·5 65 66 63	9 A.M. 1 P.M. 2 ,, 3 ,, 3¼ ,, 3½ ,, 4 ,,	S.W. .. .. W. .. .. S.	69 72 74 78 76 72 68	Sultry; cloudless. Light high clouds. Dark cloud to windward. Heavy thunderstorm, with lightning for ½ an hour. Temp. of rain 78°. Bright sun; visible vapour from pools and ditches.	
		17	48 48·2	50 50·1	52·8 ..	55·6 55·8	58 60·4	9 A.M. 3 P.M.	S. ..	67 74	Brilliant morning. Cloudless and hot.
		18	48·25	50·2	..	55	56	10 A.M.	E. by S.	64	Hazy.

I have now to invite your attention to a few deductions from the tabulated results which we may be authorised to draw, notwithstanding the restriction of the observations to the short space of twelve days.

Firstly. The constant temperature of the *natural bog*, from 12 inches to 30 feet deep, was  $46^{\circ}$ ; and the thermometer planted in the same substance at 7 inches deep, constantly indicated  $47^{\circ}$  during the term of the experiments.

Now, the thermometer at 31 inches deep in the *worked bed* exhibited a maximum heat of  $48\frac{1}{4}^{\circ}$ , having gradually gained  $2\frac{1}{4}^{\circ}$ ; and it was, apparently, still rising. The thermometer at 7 inches below the surface reached  $66^{\circ}$ , after a thunderstorm, showing a maximum increase of  $19^{\circ}$ , and, on a mean of the thirty-five observations, of  $10^{\circ}$  over its fellow, at the same depth, in the natural bog.

We have here satisfactory evidence that the accession of heat was solely derived from meteorological agency, *i. e.* from action on the surface and not from the substratum, as the latter possessed, invariably, a lower temperature, which must have tended to diminish, rather than to increase, the heat finally acquired by the worked bed. And, we may safely deduce from these facts, that the origin of the increased temperature is attributable to the change induced on the mechanical condition of the soil by drainage and pulverization, as no other changes were effected in it than those of comminution of its texture and the withdrawal of free water.

Secondly. The inference may be permitted, even from these few experiments, that, in the month of June, rain-water carries down heat, and raises the temperature of the subsoil; whilst the loss of heat by the strata nearer the surface is quickly restored by the sun's rays. By an inspection of the Table no doubt will be left on the mind as to the truth of these inferences. It appears that, at 7 inches deep, the temperature of the soil was subject to considerable diurnal increase and decrease, as well as from day to day, according to the state of the weather; that these variations became of less amount at lower depths; and that, at 31 inches, increase alone, for the time, was felt. Heat is conducted downwards so slowly by all bodies, and by moist substances particularly, that rain-water would appear, when allowed to permeate the bed, to be the most active agent in the propagation of heat to the subsoil. Accordingly, we find the lower thermometers to indicate accession of heat more quickly after rain than in dry weather; and had a rain of longer continuance fallen, instead of short showers, it is probable that the lower thermometers would have been affected much more rapidly, and have

indicated higher temperatures, as no water was observed to have passed through the soil into the drain.

On the 11th of June I was able to devote an entire day to the observation of the thermometers. The results are interesting, by showing the steadiness of the increments and decrements of heat during a cloudless day, and by denoting the period of maximum temperature attained by the thermometer at 7 inches, which was about 2 P.M.

On the 16th, I had foreseen the probability of a thunderstorm, and hastened to my thermometers to observe its effect. It is well worthy of remark, that after the temperature of the soil at 7 inches deep had attained its maximum, under the previous circumstances of the day, it was subsequently raised  $3\frac{1}{2}^{\circ}$  by the descent of the rain. It is also notable, that in half an hour after the cessation of the storm, the sun again shining brightly, and evaporation being visibly great from the surface, the earth at the same depth had lost  $3^{\circ}$  of its highest temperature; showing the rapidity with which heat is carried off by water in its transformation into vapour. It would have been highly interesting to have known, by other thermometers, the temperature of the surface when this storm fell, as the transition was almost instantaneous from bright sunshine to heavy rain; but I was unprovided with a sufficiency of these instruments.

An effect of importance—which might be predicated of all soils properly prepared to receive heat and water, and permit their descent—is traceable to the preparation of the bed: viz.,—that the transmission of accessions of heat downwards continues during the afternoon of the day, and throughout the night, whilst the superstrata (but chiefly from 7 inches upwards) are losing some amount of their heat by conduction upwards, and radiation into space. The reverse may be expected to occur during the cold seasons of the year, when the heat accumulated and stored up in the subsoil will be drawn as from a reservoir, and supply part of the loss then taking place more freely near the surface.

As I have criticized the labours and experiments of others in this branch of science, it is right I should point out the deficiencies of my own, which are also numerous. The experiments related can, indeed, only be regarded as a slight contribution to our stock of knowledge on the subject—the investigation of which deserves to be commenced *de novo*; to be carried on simultaneously, if possible, by different observers, and with appliances of all the instrumental means which the existing state of science can furnish. The enumeration of the phenomena which demand attention—of the methods we possess, or still need, for ascertaining their force, or measuring their amount—will, perhaps, be

the simplest and more useful form in which the criticism can be conveyed.

We require to know,—

1. The temperature of soils at depths accessible and profitable to the agriculturist.

The thermometer is all sufficient for indicating temperatures. It would be advisable that the heat of the surface, and that of the soil at every 2 inches in depth, descending to 12 inches, and thence to 36 inches, by spaces of 6 inches, should be noted. Self-registering thermometers would give the maxima and minima temperatures, but these instruments conduce to laziness in the observer; they give no information of the periods of the 24 hours when the maxima and minima occur, nor register the continually varying increments and decrements of heat at different depths, as they are affected by sunshine, or cloud, by rain, wind, and other atmospheric changes, which should be diligently and faithfully recorded.

2. The temperature of the air, in the shade, near the earth.

3. The pressure of the air: for which the barometer suffices.

4. The temperature of the rain.

5. The quantity of rain; ascertained by the rain-gauge.

6. The quantity of water passed by drainage from a measured extent of land, in order to compare it with the ascertained fall of rain on its surface.

There are many situations in which this object could be accomplished at a trifling expense, and the knowledge of such facts would open a new chapter of the book of nature to our view. All that has been written as to the quantity of water dismissed from the earth is too speculative and baseless to merit more than a passing notice; and no inquiry into these phenomena has, I believe, been instituted with the end of making them subservient to the practice or science of agriculture.

7. The dew point; to be determined at frequent periods of the day and night.

The best known hygrometer is Professor Daniell's, but, though simple and true, it has the disadvantage of requiring a manual experiment for every determination.

8. The quantity of dew deposited.

Of the amount of this item in the stock of Nature's fertilizing laboratory we are wholly ignorant; and though aware, as we must be, of the difficulty of ascertaining the fact required, there is no reason to despair of overcoming it if the attention of the many gifted men now attached to the science of meteorology could be brought to bear on the construction of a sufficient instrument.

9. The hygrometric condition of soil.

By this term is meant the amount of moisture which a soil may

at any time contain. This quantity will depend, in a well-drained soil, on its bibulousness or hygrometric energy. If an instrument could be contrived to indicate, by simple insertion and inspection, the humid condition of the earth between the extremes of perfect dryness and of aqueous saturation, as the thermometer discloses heat of temperature, we should indeed become possessed of two ready and sufficient means of quickly ascertaining the principal phenomena on which the temperature of soils depends; we should be provided with tests, which would go far towards explaining certain causes and degrees of fertility, and possibly find ourselves armed with an expeditious method of deciding on the aids which a given soil might require for increasing its fructifying properties and power. The mention of a desideratum is occasionally half way towards its fulfilment; and we may hope that the resources of science will avail for the supply of an instrument which would be so precious to the enlightened agriculturist.

---

Thus far had I written last year, as you are aware, and deemed my task terminated. Having had, however, the good fortune to obtain a record of observations illustrating, very forcibly, the necessity of draining retentive soils—by bringing within the scope of arithmetical computation the quantity of rain-water which is annually evaporated from the mass of the soil, “at depths accessible to the cultivator,” and the quantity which either permeates porous or must stagnate in retentive soils—I have appended the following section to the foregoing discussion, as contributing to establish certain statistics of drainage, or, to use your own remark, “as striking a debtor and creditor account between the earth and the sky.”

*On the Quantity of Rain compared with the Quantity of Water evaporated from or filtered through Soil; with some Remarks on Drainage.*

WE are indebted to Mr. John Dickinson of Abbot's Hill, near King's Langley, Herts (the eminent paper-manufacturer), for a register, extending over the period of the last eight years, of the quantity of rain which has fallen in his locality, and of the quantity which may be presumed to have passed through the soil. The first datum is determined by the common rain-gauge; the second is derived from a gauge invented many years since, for this special purpose, by the illustrious Dr. Dalton. And hereby we obtain, very unexpectedly, as regards both the facts and the extensive range of observations, experimental illustrations of the desiderata numbered 5 and 6 (page 18). The construction of the rain-gauge needs no remark, and the Dalton gauge is equally

simple. It consists of an open-top cylinder or rain-receiver sunk vertically in the earth level with its surface, having a false bottom perforated with holes, like a cullender, which supports three feet depth of soil within the cylinder, through which, and through the cullender, the excess of the rain—or the portion not evaporated—filtrates to the close bottom of the vessel; and this communicates, by means of a small pipe, with a vertical tube, whose diameter bears some definite proportion to that of the receiver, and is sunk so much lower in the earth as to have its top nearly on a level with the bottom of the receiver. Thus, all the water which permeates the soil contained within the rain-receiver flows into the tube, and is measured by a float carrying a divided stem, and indicating, in parts of  $\frac{1}{100}$ th of an inch, the quantity of rain which has entered it. The measuring tube has a cock at the bottom for evacuating its contents from time to time, and bringing the scale to zero.

Mr. Dickinson's rain-receiver has a diameter of 12 inches, and is 36 inches deep to the false bottom; it was originally filled with the soil of the country, a sandy gravelly loam, and has constantly had grass growing on it. The contents of the receiver, therefore, represent fairly the natural state of such soil; whilst the gauge indicates the quantity of water which a drain, at a depth of 3 feet, would have to convey away. The proportion which this quantity bears to the rain is obtained by comparison with the rain-gauge; and their difference gives the quantity evaporated, assisted by the action of the succulent grasses. We may, however, for the present purpose, consider the whole of this last quantity under the term evaporation.

It will be interesting and useful to agriculturists to learn Mr. Dickinson's object, as a manufacturer, in ascertaining and registering phenomena of this nature. Having several mills on the river Colne or its tributaries, it was a matter of importance to him to be able to calculate the power of water on which he might depend for use at different periods of the year; and having noticed that a considerable period elapsed after rain, owing to the extent and stratification of the country, before the springs were affected by it, he fixed a rain and Dalton gauge to assist his judgment in forming an estimate of the amount and duration of their flow according to the varying seasons, and the proportionable water-power on which he might count. These registers, combined with observation, have since enabled him to regulate his manufacturing operations, and to foresee what dependence he could place on the mill-streams, and to what extent he should require the aid of steam-power for fulfilling his contracts and engagements. This is a very remarkable and honourable instance of the application of meteorological "science to practice."

Nor is this all—for the knowledge acquired by means of these instruments, and the exposition of the results of rain and filtration proved by them, together with a just acquaintance with the area and nature of the soils of the district supplying the streams (about 120 square miles), enabled Mr. Dickinson, two years since, to demonstrate the impracticability of a scheme for furnishing the Metropolis with water proposed to be drawn from the valley of the Colne, which must have inflicted irreparable injury on the mill-owners, at the same time that it would have proved, in all probability, an abortive speculation to the adventurers. Such are the various and often unexpected fruits of exact knowledge. It was Mr. Dickinson's communication of his experiments to the Institution of Civil Engineers last year which introduced me to his acquaintance, and has enabled me to apply his acquired facts to the subject of agricultural drainage.

The annexed Table, No. I., contains the monthly and annual indications of the two gauges for the years 1836 to 1843 inclusive; those of the rain-gauge being, Mr. Dickinson informs me, generally corroborated by another gauge kept by the Grand Junction Canal Company about 8 miles distant. Table II. gives the mean result of the eight years' observations for each month, and the whole period, in terms of the depth of rain which fell on the surface—of the amount which filtered through the Dalton gauge—and of that which was evaporated or again restored to the atmosphere in the shape of vapour—with two columns showing the proportion per cent. of filtration and evaporation. Table III. presents to view the total amount of rain which fell during each year, with the per centage of filtration and evaporation. And Table IV. illustrates the quantity of rain and the proportion of water disposed of by filtration and evaporation, during the six hotter and six colder months of each year respectively. To these last Tables I have added columns exhibiting the weight of rain in tons per acre, as that expression may convey to the farmer a clearer idea of its amount than the more usual mode of stating it in inches of depth. By means of this tabular analysis we shall find the phenomena, as they may be applicable to agriculture, clearly brought before us.

The first important fact disclosed is, that, of the whole annual rain, about  $42\frac{1}{2}$  per cent., or  $11\frac{3}{10}$  inches out of  $26\frac{6}{10}$  inches, have filtered through the soil; and that the annual evaporative force is only equal to the removal of about  $57\frac{1}{2}$  per cent. of the total rain which falls on any given extent of earth 3 feet in depth (Table II.).

By a closer scrutiny we learn (Table IV.) that only about  $25\frac{1}{2}$



per cent. of the rain which falls from October to March inclusive, passes back to the atmosphere by evaporation in the same period ; whereas from April to September inclusive, about 93 per cent. is evaporated. It appears, then, that there is even a balance on the side of rain over evaporation during the six hottest months ; and we discover only two years, 1840 and 1841, in which no filtration occurred within that period. Table II. shows that in August the soil is in its driest state ; but, even in that month, some filtration took place in 3 out of the 8 seasons recorded. It will be understood, that though a near balance is shown to subsist between rain and evaporation during the six hottest months, on an average of years, the hygrometric condition of a soil, *i. e.* its state of wetness or dryness at any particular time, is not indicated by the Dalton gauge. A soil may be in a state of drought, or of humid saturation at different times during these months, and according to the season. It is, however, manifest, from these registers, that if all the water derived from rain during the six colder months were allowed to accumulate in a soil, such land must be perpetually *wet* ; and coupling this fact with the performance of drains, which I am now enabled to exhibit, it appears that six months are expended in maintaining, by the sole unaided force of evaporation, an undrained retentive soil in a tolerably uniform moist condition, whilst deep covered drains relieve the same soils of excess of humidity in a very few hours after every fall of rain, even in the wettest season. Table IV. shows that the mean excess of rain-water to be disposed of during the six coldest months by some other process than evaporation, amounts to no less a weight than about 1050 tons per acre.

Evaporation is the only *natural* agent for diminishing the quantity of water absorbed by retentive soils, but it is not at our command. When such soils are perfectly saturated, the superfluity must either stagnate on the surface or flow away from it ; and proof is here offered that the force of evaporation is scarcely equivalent to the duty required of it during one half of the year ; also that it greatly falls short of the requisite power during the six colder months. The invention of subterranean drains supplies an effective artificial method of compensating the deficiency of the evaporative force in our climate, and it is capable of placing the retentive soil in the same favourable condition, as respects meteorological agency and the fruition of every agricultural process, as soils naturally endowed with sufficient porosity. But, it must constantly be borne in mind, that, in order to assimilate this artificial process to that of nature, drains should be deeply laid, as the floor of the drains forms the limit of their action, and determines the depth below the surface at which water must still remain in a state of nearly constant excess and stagnancy.

TABLE II.

Rain.	Filtration.		Evaporation.		Filtration.		Evaporation.	
	In.	Per Cent.	In.	Per Cent.	In.	Per Cent.	In.	Per Cent.
1·847	1·307	70·7	0·540	29·3	1·307	70·7	0·540	29·3
1·971	1·547	78·4	0·421	21·6	1·547	78·4	0·421	21·6
1·617	1·077	66·6	0·540	33·4	1·077	66·6	0·540	33·4
1·456	0·306	21·0	1·150	79·0	0·306	21·0	1·150	79·0
1·856	0·108	5·8	1·748	94·2	0·108	5·8	1·748	94·2
2·213	0·039	1·7	2·174	98·3	0·039	1·7	2·174	98·3
2·287	0·042	1·8	2·245	98·2	0·042	1·8	2·245	98·2
2·427	0·036	1·4	2·391	98·6	0·036	1·4	2·391	98·6
2·639	0·369	13·9	2·270	86·1	0·369	13·9	2·270	86·1
2·823	1·400	49·5	1·423	50·5	1·400	49·5	1·423	50·5
3·837	3·258	84·9	0·579	15·1	3·258	84·9	0·579	15·1
1·641	1·805	100·0	0·000	0·0	1·805	100·0	0·000	0·0
26·614	11·294	42·4	15·320	57·6	11·294	42·4	15·320	57·6

Mean of each Month, and of eight Years.

TABLE I.

Months.	1836.		1837.		1838.		1839.		1840.		1841.		1842.		1843.	
	Rain.	Gauges.	Rain.	Gauges.	Rain.	Gauges.	Rain.	Gauges.	Rain.	Gauges.	Rain.	Gauges.	Rain.	Gauges.	Rain.	Gauges.
January	2·40	2·32	2·40	2·10	0·31	0·04	1·40	1·04	3·95	3·05	1·50	..	1·36	0·60	1·46	1·25
February	2·01	2·04	2·85	2·92	2·65	0·86	1·45	1·51	1·32	1·00	1·02	..	2·02	2·10	2·42	1·95
March	3·65	2·51	0·75	0·01	1·55	2·73	1·92	1·22	0·34	..	1·65	0·53	2·20	1·62	0·88	..
April	2·57	1·71	1·32	..	1·35	..	1·65	0·71	0·34	..	1·85	..	0·47	..	2·10	..
May	0·70	0·03	0·91	..	0·84	..	1·22	0·10	2·62	..	1·68	..	1·85	..	5·00	0·74
June	1·80	0·01	1·86	..	2·85	..	3·31	0·05	1·33	..	3·00	..	2·00	..	1·56	0·25
July	2·29	0·10	1·30	..	2·35	0·09	4·36	0·15	1·18	..	2·80	..	1·93	..	2·09	..
August	2·24	0·15	3·00	0·05	0·95	..	3·65	0·09	1·90	..	3·62	..	1·40	..	2·66	..
September	2·60	0·07	1·38	0·05	2·47	0·03	3·22	1·50	2·31	..	4·00	..	4·50	1·30	0·63	..
October	4·55	3·82	1·55	0·02	2·68	0·07	1·68	0·09	1·50	..	4·40	5·99	1·41	0·30	4·82	0·91
November	3·95	3·14	2·05	0·18	3·55	2·91	4·40	4·70	4·25	2·57	4·28	4·87	5·77	5·00	2·45	2·70
December	2·21	1·72	1·70	1·62	1·58	1·84	3·02	3·75	0·40	1·57	2·30	2·80	1·52	0·84	0·40	0·30
Total	31·00	17·65	21·10	6·95	23·13	8·57	31·28	14·91	21·44	8·19	32·10	14·19	26·43	11·76	26·47	8·10

TABLE III.

Total of each Year.				
Years.	Rain.	Filtration.	Evapora- tion.	Rain, per Acre.
	In.	Per Cent.	Per Cent.	Tons.
1836	31·0	56·9	43·1	3139
1837	21·10	32·9	67·1	2137
1838	23·13	37·9	63·0	2342
1839	31·28	47·6	52·4	3168
1840	21·44	38·2	61·8	2171
1841	32·10	44·2	55·8	3251
1842	26·43	41·4	55·6	2676
1843	26·47	36·0	64·0	2680
Mean	26·61	42·4	57·6	2695

TABLE IV.

April to September inclusive.							
Years.	Rain.	Filtration.	Evapora- tion.	Filtration.	Evapora- tion.	Rain, per Acre, Filtrated.	Rain, per Acre, Evaporated.
	In.	In.	In.	Per Cent.	Per Cent.	Tons.	Tons.
1836	12·20	2·10	10·10	17·3	82·7	212	1023
1837	9·80	0·10	9·70	1·0	99·0	10	982
1838	10·81	0·12	10·69	1·2	98·8	12	1082
1839	17·41	2·60	14·81	15·0	85·0	263	1500
1840	9·68	0·00	9·68	0·0	100·0	..	980
1841	15·26	0·00	15·26	0·0	100·0	..	1545
1842	12·15	1·30	10·85	10·7	89·3	131	1099
1843	14·04	0·99	13·05	7·1	92·9	100	1322
Mean	12·67	0·90	11·77	7·1	92·9	91	1192
October to March inclusive.							
1836	18·80	15·55	3·25	82·7	17·3	1574	330
1837	11·30	6·85	4·45	60·6	39·4	693	452
1838	12·32	8·45	3·85	68·8	31·2	855	393
1839	13·87	12·31	1·56	88·2	11·8	1216	159
1840	11·76	8·19	3·57	69·6	30·4	829	362
1841	16·84	14·19	2·65	84·2	15·8	1137	269
1842	14·28	10·46	3·82	73·2	26·8	1059	387
1843	12·43	7·11	5·32	57·2	42·8	720	538
Mean	13·95	10·39	3·56	74·5	25·5	1052	360

NOTE.—The quantities of rain in the columns headed Filtration represent the required performance of drains in retentive soils. One-tenth of an inch of rain in depth amounts to 10·128 tons per acre.

A study of the results registered in these Tables puts us in possession of many other facts of import to the agriculturist, as enforcing the warning—which experience cannot but have taught him—to adopt every appliance at his command for placing his soil in such condition as to derive the greatest benefit and the least evil from elemental influences; for, so variable are the seasons, that no average can properly display the changing amounts of meteorological quantities and forces. It seems, from Table I., that the discharge of water by drains occurs, on the average, during seven months of the year. In 1840 and 1841, however, rain was in excess over evaporation only during four months; though in the first year  $21\frac{4}{10}$  inches of rain fell, whilst in the second the earth received  $32\frac{1}{10}$  inches, or 50 per cent. more rain in the latter than in the former year; yet the soil was equally dry in both years on the mean of the six hottest months, for the evaporative force was able to relieve the soil of all the rain that fell, though the quantities were so widely different, being  $15\frac{2}{10}$  inches in 1841, and only  $9\frac{6}{10}$  inches in 1840. But, turning to the six colder months of the same years, we find the case reversed, for the proportionate evaporation in 1840 was double that in 1841. It appears, too, that in 1836, when the quantity of rain was only about one inch less than the maximum in 1841, the force of evaporation was 13 per cent. less, and water filtered through the gauge in various proportions, during every month of that year, and the same in 1839. Thus, in preparing soil to receive the utmost benefit and the least evil from rain, however slight or excessive, it should be put into a state to refuse holding water in excess, but be capable of absorbing humidity freely and retaining it deeply; whilst the drains should admit water with facility, and convey it away with dispatch.

The quantities of rain and filtration denoted by Mr. Dickinson's gauges are daily registered, and this record has enabled me to ascertain a remarkable coincidence between the action of the Dalton gauge and that of Mr. Hammond's inch-pipe drains, as reported to the Royal Agricultural Society, in the last Journal, p. 375. It appears, according to the rain-gauge, that  $\frac{4}{10}$ ths of an inch of rain fell on the 7th and 8th November last; and by the Dalton gauge, that on the 9th  $\frac{4}{10}$ ths, or nearly the whole of this quantity, had passed through it. It was on the 9th that I inspected the drainage of Mr. Hammond's farm, recording the fact that, after a rain of about 12 hours' duration on the 7th, I found the drains on the 9th, in a nine acre piece, 3 feet deep, just dribbling, and those in a hop-ground adjoining, 4 feet deep, exhausted; Mr. Hammond having observed, previously to my arrival, that the greatest stream at the outfall of each drain amounted to about the half-bore of the inch pipes. The times

occupied in the discharge of the water by the gauge and the drains may, therefore, be considered to be identical, and as comprising about 48 hours from the commencement of the rain. In drawing this parallel between the action of the gauge and these drains, I am presuming that the fall of rain at Penshurst was equal to that at King's Langley; and I think this may be assumed to be near enough to the truth, as I have learnt that a nearly similar downfall ( $\frac{5}{10}$ ths of an inch) was recorded at Birmingham northwards, and a rain of similar duration occurred at Brighton southwards.

This experimental corroboration of the sufficiency of such small drains will have its weight with practical men; but I am further able to demonstrate, by simple arithmetical computation, how very small is the quantity of water required to enter the crevice formed by the imperfect junction of two pipes. The rain-gauge informs us, that  $\frac{4.9}{10}$ ths of an inch in depth of rain fell upon each square foot of surface, in the observed time of 12 hours. This quantity is equivalent to  $69\frac{1}{10}$  cubic inches, or  $2\frac{1}{2}$  pounds, which, divided by 12 hours, gives little more than  $\frac{2}{10}$ ths of a pound per square foot of surface per hour for the weight of the rain.

The drains were 24 feet asunder, and each pipe a foot in length, so that each lineal foot had to receive the water falling on 24 square feet of surface, equal to 60 pounds, or 6 gallons; and as the time which this quantity occupied in descending through the soil and disappearing was about 48 hours, it results that  $1\frac{1}{4}$  lb., or one pint per hour, entered the drain through the crevice existing between each pair of pipes. Every one knows, without having recourse to strict experiment, how very small a hole will let a pint of water pass through it in an hour, being only one-third of an ounce per minute, or about twice the contents of a lady's thimble.

The weight of rain, per acre, which fell during the 12 hours amounted to 108,900 lbs., or  $48\frac{9}{10}$  tons, which on the whole piece of nine acres, is equal to  $437\frac{4}{10}$  tons; and each drain discharged 19 tons, equal to about  $\frac{4}{10}$ ths of a ton per hour, on the mean of 48 hours; but when the flow was at the greatest, I find that each drain must have discharged at the rate of five times this quantity per hour, which affords proof of the faculty of the pipes to receive and carry off a fall of rain equal to  $2\frac{1}{2}$  inches in 12 hours, instead of half an inch, a fall which is quite unknown in this climate. Half an inch of rain in 12 hours is a very heavy rain. I learn from Mr. Dickinson, that his rain-gauge has never indicated so great a fall as  $1\frac{1}{2}$  inch in 24 hours; and from Dr. Ick, the curator of the Birmingham Philosophical Institution, that only on five occasions has the rain there exceeded 1 inch in 24 hours, during the same period of 8 years; the greatest quantity having been  $1\frac{9}{10}$  inch on Dec. 4, 1841. We may, therefore, consider the fact

of the sufficiency of inch-bore pipes for agricultural drainage to be fully demonstrated both by experience and experiment.

I will now mention an experiment which every farmer is competent to make, and which cannot fail to throw light on the action and effect of his drains, and on the relative condition of different pieces of land as to porosity, or filtrating activity—I allude to the simple ascertainment, by measure, of the quantity of water discharged from different drains, after rain, in the same time. In reply to numerous inquiries on this subject, I have only succeeded in obtaining sufficiently exact information from Mr. Hammond, whose intelligence had led him to make the experiment without any suggestion from me. He states—"I found after the late rains (Feb. 17, 1844), that a drain, 4 feet deep, ran 8 pints of water in the same time that another 3 feet deep ran five pints, although placed at equal distances." The circumstances under which this experiment was made, as well as its indications, deserve particular notice. The site was the hop-ground before referred to, which had been under-drained 35 years since to a depth varying from 24 to 30 inches, and though the drains were laid somewhat irregularly and imperfectly, they had been maintained in good action. Mr. Hammond, however, suspecting injury to be still done to the plants and the soil by *bottom* water, which he knew to stagnate below the old drains, again under-drained the piece in 1842 with inch pipes, in part to 3 feet, and in part to 4 feet in depth, the effect proving very beneficial. The old drains were left undisturbed, but thenceforth ceased running, the whole of the water passing below them to the new drains, as was to be expected. The distance between the new drains is 26 feet, their length 150 yards, the fall identical, the soil clay. The experiment was made on two drains adjoining each other, *i.e.*, on the last of the series of the 3 feet, and the first of the series of the 4 feet drains. The sum of the flow from these two drains, at the time of the trial, was 975 lbs. per hour, or at the rate of  $19\frac{1}{2}$  tons per acre in 24 hours—the proportionate discharge, therefore, was 12 tons by the 4 feet, and  $7\frac{1}{2}$  tons by the 3 feet drain. No springs affected the results. Hence, we have two phenomena very satisfactorily disclosed; 1st, that the deepest drain received the most water; 2nd, that it discharged the greatest quantity of water in a given time—the superficial area of supply being the same to both drains. It would appear, then, either that the deeper drain had the power of drawing water from a horizontal distance greater by the ratio of 8 to 5 than the shallower drain; or that the perpendicular descent of the water was more rapid into the 4 feet drain; or that its increased discharge was owing to both these causes combined. The phenomenon of a deep drain drawing water out of soil from a greater distance than

a shallower one, is consistent with the laws of hydraulics, and is corroborated by numberless observations on the action of wells, &c.; but the cause of the deeper drain receiving more water *in a given time* is not so obvious. An opposite result, as to time, would rather be expected from the fact of water falling on the surface having to permeate a greater mass of earth, both perpendicularly and horizontally, in order to reach the deep drain. A natural agricultural bed of porous soil resembles an artificial filter, and it is unquestionable that the greater the depth of matter composing such filter, the slower is the passage of water through it. In stiff loams and clays, however, but more particularly as regards the latter earth, the resemblance ceases, as these soils can permit free ingress and egress to rain-water, only after the establishment of that thorough net-work of cracks or fissures, which is occasioned in them by the shrinkage of the mass from the joint action of drains and superficial evaporation. These fissures seem to stand in the stead of porosity in such soils, and serve to conduct water to drains rapidly after it has trickled through the worked bed; it is possible, too, that in deeply drained clays of certain texture the fissures may be wider, or more numerous, in consequence of the contraction of a greater bulk of earth than when such soil is drained to a less depth. However this may be, it is asserted by several respectable and intelligent farmers in Kent, who have laid drains very deeply in clays and stiff soils, that the flow from the deepest drains invariably commences and ceases sooner than from shallower drains, after rain. On this interesting and unexplored subject I hope to be able to furnish you with multiplied observations after next winter, and trust also to receive the co-operation of members of the Society in making them in different soils, and with due regard to all those phenomena which may influence the results, or be detected by them.

The consideration of the depth of drains has been too generally limited to the mere exigencies of culture and implements, combined with the natural desire to restrict expense when the materials used were dear, and the cost of earth-work great. These adventitious circumstances have certainly tended to obscure from view the true principles on which drainage should be founded, and on which the utmost benefits to be derived from it depend. The question of distance between drains is important on the score of expense, and it will be wise to err on the right side, and keep within safe limits; but insufficiency of depth can only be remedied by a new outlay. So far as experience can illuminate the subject, we know that many agriculturists have, a second time, drained their fields to a greater depth; it may, however, be doubted whether any one has taken up deep drains, and placed them nearer the surface, or nearer together. The system of deep

drainage now pursued in Kent has doubtless been encouraged by the cheapness, lightness, and approved action of the pipe-tiles, combined with the more moderate cost of the earth-work incident to their small dimensions, and to the facility of laying them. The aggregate cheapness of the work has set the mind of the farmer free to contemplate more exclusively and attentively the perfection of the end in view; and it is well worthy of remark, that experiment and experience have rapidly induced the adoption of a system of parallel drains considerably deeper, and less frequent, than those commonly advocated by professed drainers, or in general use. I gave several instances of this practice in Kent in the report of last year, already alluded to, and it is rapidly extending. Mr. Hammond stated to you (*Journal*, vol. iv. p. 47), that he drained "stiff clays, 2 feet deep, and 24 feet between the drains, at 3*l.* 4*s.* 3*d.* per acre," and "porous soils, 3 feet deep 33½ feet asunder, at 2*l.* 5*s.* 2*d.* per acre." I now find him continuing his drainage at 4 feet deep, wherever he can obtain the outfall, from a conviction, founded on the experience of a cautious progressive practice as to depth and distance, that depth consists with economy of outlay as well as with superior effect. He has found 4 feet drains to be efficient, at 50 feet asunder, in soils of varied texture—not uniform clays—and executes them at a cost of about 2*l.* 5*s.* per acre, being 18*s.* 4*d.* for 871 pipes, and 1*l.* 6*s.* 6*d.* for 53 rods of digging. Communications have been recently made to me by several respectable Kentish farmers, of the satisfactory performance of drains deeply laid in the Weald clays, at distances ranging from 30 to 40 feet, but I have not had the opportunity of personally inspecting these drainages.

The following little table shows the actual and respective cost of the above three cases of under-draining, calculated on the effects really produced, *i. e.* on the masses of earth effectively relieved of their surplus water at an equal expense. I conceive this to be the true expression of the work done, as a mere statement of the cost of drainage per acre of surface conveys but an imperfect, indeed a very erroneous, idea of the substantive and useful expenditure on any particular system. This will be apparent on reference to the two last columns of the table, which give the cost in cubic yards and square yards of soil drained for one penny, at the above mentioned prices, depths, and distances:—

Depth of the Drains in Feet.	Distance between the Drains in Feet.	Mass of Soil drained per Acre, in Cubic Yards.	Mass of Soil drained for 1 <i>d.</i> , in Cubic Yards.	Surface of Soil drained for 1 <i>d.</i> , in Square Yards.
2	24	3226½	4·1	6·27
3	33½	4540	8·93	8·93
4	50	6453	12·00	8·96



I may here observe, that Mr. Hammond, when draining tenacious clays, chooses the month of February for the work, when he lays his pipes (just covering them with clay to prevent crumbs from getting in), and leaves the trenches open through March, if it be drying weather, by which means he finds the cracking of the soil much accelerated, and the complete action of the drains advanced a full season. The process of cracking may, doubtless, be hastened both by a choice of the period of the year in which drains are made, and by such a management of the surface as to expose it to the full force of atmospheric evaporation.

Recurring to the foregoing Tables, it must be noticed that the mean annual fall of rain, as therein registered, is below the average of Britain, whilst the force of evaporation is probably higher than the average; and the monthly as well as annual amounts of filtration and evaporation may be expected, in different latitudes, localities, and soils, to vary greatly from these records. Similar observations obtained on different soils, and in various parts of the country, when combined with the indications of thermometers sunk in the earth, would put us in possession of that condition of soil which may not be improperly termed its *climate*, of which no certain knowledge can be deduced from purely meteorological phenomena, but upon which the atmospheric climate of a district is known greatly to depend.

Meteorologists have recorded, for many years, the amount of terrestrial evaporation, as denoted by a gauge invented by Mr. Luke Howard, and have considered it as "indicative of the quantity of moisture taken up by the atmosphere from the earth;" but this instrument only denotes the evaporation from a dish of water placed on the earth's surface, and, therefore, supplies no fact of direct use to the agriculturist, for cultivated soils are not under these circumstances, and the power of the sun's rays in heating soil is but indifferently represented by their effect in transforming water into vapour. The difference between the indications of the Howard and Dalton gauges is most remarkable. Professor Daniell states (*British Almanac*) the mean annual rain in London to be 22·199 inches, and the mean evaporation 23·981 inches, or 1·782 inches more than the rain; and the results recorded at the Birmingham Philosophical Institution for 1843 are—rain 26·716 inches, evaporation 31·982 inches, or 5·266 inches more than the rain. But we learn from the Dalton gauge that, in Hertfordshire, out of 26·614 inches of rain only 15·32 inches were restored to the atmosphere—the remainder passed through the earth into the rivers, and this is the real fact on comparing the amount of rain with the amount evaporated from soil 3 feet deep.

We must never forget that accurate and multiplied quantitative facts form the only substantial basis of science; and observations

of the rain and Dalton gauges would be usefully varied, by placing the latter at different depths, as at 1, 2, 3, and 4 feet or more below the surface, and filled with a diversity of soils, whence information may be expected to arise of great practical value to the agriculturist.

JOSIAH PARKES.

7, *Great College-street, Westminster, 1844.*

---

IX.—*On Preparation for the Wheat Crop in Cornwall.* By  
J. H. TREMAYNE.

THE agriculture, perhaps the soil, of Cornwall is peculiar. We have little pasture land, properly so called. The upland is not suited to permanent pasture; our valleys generally (particularly in the west) not much wider than the streams that run through them; but the soil is of such a nature, that after a course of husbandry the land acquires a firm hard sward, sooner than any I ever saw in other parts of England. We may call it, therefore, almost all convertible land—and it is treated accordingly. The course of husbandry has been—I speak not now of the old system which once prevailed, when corn crops were taken till the land was exhausted, and then left for years to recover, but of the later system, which is even now enjoined by our leases—the course of husbandry has been to take not more than two corn crops in succession, seeds being sown with the last. It is then pastured for three or four years (the grass once cut for hay in the first year), and then broken up again for wheat. Of late, however, a better spirit has arisen—green crops have been introduced—the system of alternate corn crops and green crops adopted; on farms where twenty years ago one saw only a small piece of turnips adjoining the homestead, one now sees large fields of Swedish and other turnips drilled, following the wheat crop, and turning out the barley stubbles for the subsequent pasture in a state of cleanliness utterly unknown before. The new system, however, calls for a change in the application of manure. Under the old, nearly the whole manure (chiefly lime, from about 80 to 120 Winchester bushels per acre) was applied for the wheat crop—mixed, perhaps, with the small quantity of very badly made dung which the farm afforded—or (if the farmer chose to apply this dung to a favourite piece of grass land) mixed only with earth from ridges ploughed in the fields. Under the new or alternate system, if the lime is applied to the wheat, and dung or bones or other purchased manure applied to the turnips, there is not enough taken out for the lime—and if the lime is discontinued, it is generally supposed the crop of wheat will be deficient. I have long thought on this—and, moreover, thought that our general

preparation for wheat was very imperfect: that system is, to plough the three or four years' sward in June or July (turning half upon half, as the provincial expression is), break it down, harrow and roll it in September, and then plough clean for wheat in October or November, immediately before sowing. It occurred to the person who manages this farm, that a great improvement might be made by ploughing in February, instead of June or July, and sowing rape in the spring. That has accordingly been done on this farm for two or three years. We were at first afraid to dispense with our lime, and applied the usual quantity before sowing the rape in May. We had abundant produce—kept our sheep on it through the summer with great advantage—and though the wheat of this summer (1842), owing to the wet winter of 1841-2, was thin on the ground, I have no doubt we have on ordinary land more than four quarters per statute acre. There can be no doubt that what was taken out of the lime manure by the rape was fully returned to the land by the sheep being hurdled upon it through the summer. The loss was the pasture from February to June on a four years' old ley. The gain was the keeping our feeding wethers, and other sheep following them, from June to September or October.

In consequence of a partial experiment made last year (and which, though under unfavourable circumstances, was successful), the experiment this year has been pushed further; and the following has been the course pursued this summer (1842):—

A four years' old ley was skimmed  $2\frac{1}{2}$  inches deep about the 10th of February, not stirred till the 28th of April; the surface was then so well rotten, that after the usual labour in working it down, nothing remained from which ashes could be procured. The ashes made from the fuel used in this house have been entirely neglected—wood and coal ashes mixed—and when they have accumulated to some extent, carried to the garden, where they have been screened, the large cinders used for the fires there; some of the ashes, perhaps, applied to garden purposes, and the refuse thrown by. About *six* cart-loads of these small refuse cinders or ashes were collected. Having been exposed to all weathers, they would not run through the drill; one load of lime (30 Winchester bushels) was applied and mixed well with them, which had the desired effect of drying and separating them. They were drilled with the rape-seed over about 7 acres on the 5th of May; seven weeks after the rape was stocked with sheep; we continued increasing them, but the rape still gained upon us—seventy-five sheep were upon it for several weeks,—the greater part of which were fattened, and all maintained during the summer; fifty young wethers are now upon it (September, 1842), with some other sheep; and it will keep them till it is ploughed for wheat some weeks hence. The land is perfectly clean; and

we think it so well manured that *no lime* is to be applied for the wheat crop. As to the effect of the coal-ashes on this crop of rape, it may be observed that on a few spots the cinders, occasionally choking the drill, prevented a perfectly regular distribution of them; these spots are plainly to be seen, showing a contrast, as between a healthy and unhealthy plant. It may be supposed, too, that there was a large proportion of wood-ashes—this is impossible. The original proportion of wood-ashes was trifling to the greatest degree as compared with the coal.

A feeling is beginning to prevail in this county unfavourable to lime as a manure. I am far from participating in that feeling—but if by rape and sheep we can save a part of the lime bill, it is an advantage not to be lightly regarded. Those who think badly of hurdling long-woolled sheep on turnips will observe that their objection, viz. that such a practice punishes the sheep, cannot apply to this system, which is only in operation between June and October.

*October, 1843.*

The above was written about September, 1842. A year has since elapsed; and the wheat which was then to be sown has been reaped and saved. It is the best crop on the farm, though on very ordinary land. It was drilled in the usual manner, 16 gallons to the acre. A quarter of an acre of the field was fully manured with lime a little before the wheat was sown. It is but fair to add, that this lime was not well mixed, and that the quantity was greater than usual. At harvest this appeared rather thicker on the ground than the rest of the field, but to have suffered more from the rain; its hue was not so good, and it had every appearance of being a lighter sheaf. A square yard of this was cut and separated from the rest, as was also a square yard of the part not manured with lime immediately adjoining. The produce of these 2 yards has been now thrashed, and is as follows:—

1st. Wheat not manured with lime, 31 half-pints, weight  $13\frac{1}{2}$  lbs.

2nd. Wheat manured with lime, 28 half-pints, weight 11 lbs.

No. 1. At the rate of 38 bushels 3 pecks per acre.

No. 2. At the rate of 35 bushels per acre.

The wheat from the part not manured is the brightest sample.

All single experiments made like this on a small scale are exceedingly fallacious, but I fully believe the difference on the whole piece to have been equal to that shown in the experiment. It is very possible that in a hot and dry summer the result might have been different—but, at all events, we have a very good crop of wheat, had the advantage of feeding many sheep through the summer, and saved the lime bill.

*Heligan, October, 1843.*

---

X.—*Farming of Wiltshire.* By EDWARD LITTLE, of Lower Sheldon Farm, Chippenham.

PRIZE REPORT.

IN writing on the agriculture of Wiltshire it will always be found necessary to divide the county into two districts,—viz., North and South, or rather North-west and South-east. The soil\* and the systems of husbandry, &c., are as different—as is often the case in two separate counties—North Wiltshire being principally in enclosed pasture-farms, famous both for their dairies and excellent quality of cheese, and for grazing of cattle; whereas South Wilts consists chiefly of unenclosed arable and down land, in large farms, and is celebrated for its extensive flocks and the good quality of its corn. The former may also be characterized as the *oolite district*, the latter as the *chalk district*. I propose to commence with the consideration of the latter, it being the most extensive, having the largest farms, and a far greater breadth of corn-land.

*South Wilts, or Chalk District.*

*South Wilts* comprises the whole of that part of the county called the Wiltshire Downs, commencing where they enter the north-eastern part of the county from Berkshire, between Marston and Bishopstone, and terminating at Maiden Bradley, whence they pass into Dorsetshire; containing nearly 500,000 acres. The soil of this district, though various, is more uniform than that of the other; the hills are chalk, with its usual accompaniment of flint; and in general the land on the sides of the hills is a chalky loam, while the flatter parts are a flinty loam. In some of the valleys there are veins of black earth without any mixture of flints. The sides of the hills are in general the weakest and thinnest, and the level tops are frequently the deepest and strongest land. There are some singular sand veins running through a large portion of this district, which deserve notice. One narrow and fertile vein enters the county at Mere, on the borders of Dorsetshire, and takes a north and north-eastern direction round the outside edge of the downs, keeping nearly close to their foot, by way of Maiden Bradley, Warminster, Westbury, and Lavington, towards Devizes, where it meets and unites with

\* There is no county perhaps that presents to the geologist a more extensive range through the succession of strata in this island. From the lias at Box, which is the lowest in the series, he may pass over the marlstone of Smith, inferior oolite, fullers' earth, great oolite, Bradford clay, forest marble, with Stonesfield slate, cornbrash, Oxford clay, calcareous grit, coral-rag, Kimmeridge clay, lower green sand, gault, upper green sand, chalk marl, lower and upper chalk, without going one step out of the county.

a much wider and more fertile vein coming down the Pewsey Vale from Burbage.\* Another vein also enters the county from Dorsetshire, and passes through Donhead, Ansty, Shallowcliffe, Fovant, &c., under the foot of the down. This vein is also met at or near Fovant by another branch, or rather a ridge of sand-hills, coming from West Knoyle. The fertility of the sand here depends upon its being more or less mixed with chalk and chalk-marl. There are a few instances of strong clays and clayey loams in this district. Nearly the whole of the soil of South Wilts now under cultivation consists of flinty and chalky loams, with various mixtures of chalk-marl, green sand, and gault or clay, and may be treated of under the following heads:—1st, chalky and flinty loams; 2nd, the down or beak land; 3rd, the heavy white lands; and, 4th, the sand land. The size of the farms varies from 100 to 2000 acres; there are but few so large as 2000, the general size may be said to be from 400 to 1000. There is usually a portion of down to each farm.

*System of Cropping.*—The intelligent and enterprising men who occupy this district have, since the extinction of the common field-husbandry, worked a great change in the system of farming. They have been always ready to adopt any improvement. The system of cropping pursued in South Wiltshire varies considerably, the soil not being uniform; but it appears that the heavy white lands and the sandy loams, which are the best wheat-lands, are cropped in a three-field course; and on the best and richest of these soils wheat is sown every alternate year. On the chalk and flinty loams, where barley can be grown to advantage, the four-field course is adopted; and on the light down, or “beak-land,” as it is termed, of which there is usually a portion attached to the farm, it is farmed on a five or a six field course, as the quality of this land varies, there being two kinds of it—the strong red or “wood sour land,” and the light or black land.

#### *Rotation of Crops on Flinty and Chalky Loams.*

This kind of soil comprises the largest portion of South Wilts, and is well adapted for the growth of barley and turnips. It is usually cropped in the four-field, or Norfolk course:—

- 1st. Wheat.
- 2nd. Vetches and turnips.
- 3rd. Barley.
- 4th. Clover.

Much of the land has been found to be “clover sick” by a

---

\* This vein is certainly a part of the green-sand formation of geologists, which is remarkable for its fertility wherever it appears at the foot of chalk-hills, though not when it spreads into a wider range of country.—PR. PUSEY.

strict adherence to this course for many years; and the following rotation has in consequence been adopted by many:—

- 1st. Wheat.
- 2nd. Barley, half sown with clover.
- 3rd. Half clover, mown for hay ;  
Half vetches and swedes.

(Winter turnips and rye are sown after the vetches are fed.)

- 4th. Half clover, fed, or sometimes broken up and sown  
to green food, such as summer vetches, &c. ;  
Half rye, early turnips, rape, &c.

After the rye is fed the land is sown with turnips.

In this course, clover is sown only once in eight years; the barley may be sown much earlier, and the produce is consequently of a better quality; nor is the quantity found to be deficient. It also gives an opportunity of preserving a portion of swedes for sheep later in the spring, at the time when they are so much wanted; and the land is also in a higher state of condition for the wheat crop. Where there are no water-meadows on the farm, to make up for the deficiency of hay from this course of crops, there is an extra quantity of sainfoin sown.

*Light Flinty Soils.*—There is a lighter description of this soil generally termed “beak-land,” or down-land, and more of this kind has been brought into cultivation within these few years inasmuch as vast breadths of the downs are broken up every year, and not, as was formerly the case, crops of corn taken till, according to a quaint expression, “an old corn would not produce a new one,” and then laid down “to rest;” but there is now a more regular system of culture by the use of artificial manures (bones are chiefly used, as best adapted to this soil): these lands are found to produce good crops of corn and turnips. The system of cropping is *generally* five-field:—

- 1st. Wheat.
- 2nd. Swedes or turnips.
- 3rd. Oats or barley.
- 4th and 5th. Grass two years, or broken up the second  
year for rape and vetches.

Which practice is found to be a good preparation for wheat, as the land is better manured and rendered firmer by the sheep feeding off the green crop; for on this kind of soil firmness is essentially necessary to a good crop of wheat. Barns and yards are continually springing up on the hills, consequently manure is made where it is most wanted. A large portion of these soils is found to carry good crops of sainfoin, of which some is commonly found on each farm. The usual plan is to sow a piece every year, and let it stand five or six years: about a tenth, or something more,

may be said to be the average number of acres kept to sainfoin, but it varies according to circumstances—such as the nature of the soil, the quantity of down attached to the farm, &c. ; but sainfoin is considered indispensable on a stock-farm.

*Heavy White Land.*—The general course of cropping the heavy white lands of this district is the three-field, this kind of soil being best adapted for the growth of wheat ; it is, in fact, the only corn crop taken by some farmers, excepting enough of oats and beans, &c., sufficient for the use of the farm. Those who do so, sow thus:—

- 1st year. Wheat ; one-third sown with clover.
- 2nd year. One-third clover (mown for hay) ;  
One-third beans, oats, peas, or vetches ;  
One-third swedes. (Rye, or winter barley, or vetches, are usually sown on a portion of the swede field.)
- 3rd year. One-third clover, fed, summer tilled or sown to green crop ;  
One-third early turnips or rape ;  
One-third rape, or summer vetches : or some prefer a clean fallow after the swedes.

Clover is in this course sown only once in nine years ; and the green crops are changed every rotation. It gives an immense quantity of green food ; the whole, or nearly so, is fed on the land with sheep, which keeps it in very high condition. This system is only pursued by the best farmers : the more general one is,—

- 1st year. Wheat.
- 2nd year. Half oats, sown with clover ;  
Half swedes, vetches, or beans, &c.
- 3rd year. Half clover (mown for hay) ;  
Half turnips, rape, &c.

But some adopt the following :—

- 1st year. Wheat ; half sown to clover.
- 2nd year. Half clover (mown for hay) ;  
Half swedes, vetches, oats, &c.
- 3rd year. Half clover, fed, or summer tilled ;  
Half rape, turnips, summer vetches, &c.

Horse-corn being so little wanted since the completion of the railways, more attention is given to the growth of green crops, and less to that of oats and beans, which formerly made one field in the course ; and the sheep stock is thereby considerably increased.

*Sand-Lands.*—The sand lands form but a small part of this district, and that little varies considerably in quality, there being



some very poor, thin, and gravelly, and some rich sandy loams; consequently, there are various methods of cropping pursued. They are all well adapted for turnip husbandry, but not equally so for barley. The poorer kinds are generally sown in a four-field course, similar to the flinty soils. On the sandy loams wheat is usually sown every third year. Barley is sometimes grown; though not well adapted for malting purposes, it is often selected for seed, as a good change for the other parts of the county. There is considerable variety in respect to the choice and succession of green crops, consequently it is difficult to describe what rotation is generally pursued when it is so varied. Some of the deepest and richest of these soils are sown with wheat every alternate year; the green crop between being varied as much as possible. The object of those who occupy the sand-land is to keep it manured as highly as possible, and shaded with a crop of either corn or green food. The same remark applies to this kind of soil, with regard to beans, &c., which is made on the white lands. Much of the sandy land has been sown so often with turnips and swedes as to have become tired of them; and a good deal is now sown with rape and mangold-wurzel, but the latter not to any great extent. It will be seen by the system of cropping pursued on the different soils that great attention is given to the production of green crops, the whole of which are mostly fed on the land by sheep; for throughout the whole of this division of the county sheep-farming is pursued; and, to use Mr. Davis's expression, is "*the sheet-anchor of South Wiltshire husbandry.*"

*Management of Crops.*—Wheat is not sown so early as formerly, even on the hills and the light lands; Michaelmas is considered early, but November is the principal seed-time. On the sands, December is considered the best time. There is a good deal of spring wheat sown after turnips and swedes, instead of barley; particularly where the land is not kind for barley. Drilling is now almost universal, except on some heavy land, where some farmers still continue to sow broadcast. Two bushels to the acre are the quantity usually drilled, and the drills are from 7 to 9 inches apart: half a bushel more is sown when the broadcast method is preferred. Wheat is reaped at prices varying from 7s. to 12s. per acre.

Barley is sown much earlier than formerly; March and April are now the principal seed-time; and drilling is universal. One sack to an acre, with drills 7 inches apart, is the usual plan. It is mown at 2s. per acre. Oats are not grown in large quantities, except on the down lands, where they are sown instead of barley, and drilled and mown in the same manner.

Beans are not grown so much in this district as formerly, even on the soils best adapted to them, there not being the usual

demand for horse-corn. Dibbling at one foot square is the plan of sowing: the price of cutting is much the same as with wheat, but varies according to the crop. Peas are not extensively cultivated for sale, but chiefly used on the farm: being an uncertain crop, little attention is paid to the cultivation. Drilling, at 18 or 20 inches apart, is the method of sowing: cutting, at from 3s. to 5s. per acre. Swedes and turnips are grown in all the different soils of the county, and are nearly all consumed on the land by sheep; a few only are carried off, as stall-feeding is not adopted. Where artificial manures are used, drilling is the invariable practice; but where yard-manure is applied, particularly on the heavy lands, broadcast has its advocates. There are very few farmers who drill on ridges: drilling on the flat, from 15 to 24 inches apart, according to the soil, or the opinion of the grower, is the general practice. Horse-hoeing is by no means general; neither is cutting turnips in the field for sheep, except occasionally for young sheep and lambs, or for grazing sheep. Storing of swedes is become very general, and the method considered to be the best is throwing 7 or 8 bushels in a heap, and covering them with sufficient earth to keep them dry and exclude frost. Mangold-wurzel is only partially cultivated, and on the deepest soils. Rape is a favourite green food in autumn with the South Wiltshire farmers, and is very extensively cultivated: it is sown by itself, and with turnips and vetches. Rye is mostly sown as green food for early spring feeding. On some of the light hill or "beak land," which is considered too weak to carry wheat, it is occasionally sown for seed. Great breadths of vetches are sown in the autumn and spring, for feed; and they are considered a good preparation for wheat on the heavy lands. Very few are kept for seed, except in seasons when there is an abundance of food for sheep. Potatoes are not at all a favourite crop in South Wilts, particularly on the large farms. Many farmers let out a small portion of land to the labourers, which generally forms the extent of this crop, except on the sand-land, where they are rather more cultivated. The artificial grasses sown on the light lands of this division are a mixture of hop or trefoil, with rye-grass and white clover. Red clover is sown on the heavy lands, and such other soils as are calculated for its growth. Cow-grass and marl-grass are found to be good substitutes when the land is tired of red clover. A great proportion of the flinty and chalky soils are found to bear good crops of sainfoin, which is now generally taken advantage of; indeed, sainfoin is indispensable to the stock farmer, being the most nutritive grass that is cultivated. Italian rye-grass has lately been introduced, and found to be a valuable grass for early spring feed on farms where there are no water-meadows.

*Pasture.*—As before stated the quantity of pasture-land in this

division of the county is small compared with the arable. It is mostly fed with sheep or the working cattle of the farm, except on the western borders of the county, adjoining Dorsetshire, where there is a tract of pasture-land which is chiefly applied to dairy purposes.

*The Water Meadows* of this division of the county form a most important part of its husbandry. Of these there are about 20,000 acres, and amongst them are to be found some of the best meadows in England; every brook and rivulet is applied to irrigation when practicable. Their management has undergone but little alteration since Mr. Davis made his report (who wrote so practically and ably on the subject), that it is unnecessary to give more than a general account of the system now pursued. The watering, or, as it is provincially termed, "drowning," continues to be done in the same manner as formerly, each meadow having its stated time for the water to be thrown over it, which rule has been in force very probably ever since the meadows were first formed, and seems likely to continue: from the construction of the meadows, generally, such must be the case, as the drain that takes the water from one meadow forms a "carrier" to irrigate the next below; consequently, by altering that system one person would divert the stream to the injury of his neighbour below, which has been done, and caused many very vexatious and expensive lawsuits. They are generally fed by sheep, which is the principal stock of this division of the county. The grass is usually ready to take the couples about the third week in March, or as soon as the lambs can travel the distance (which is sometimes considerable), as they invariably return to the arable land at night. After being fed the meadows are laid up, and in about six weeks produce an excellent crop of hay: they are sometimes mown a second time, but not often. It is usual to feed them in the fall with dairy cows (if any are kept) or the working oxen, and horses of the farm. There is great danger of rotting sheep in the autumn, consequently they are not allowed to feed there at that season of the year. The *real* value of water-meadows is not so great now as in Mr. Davis's time. It was thought impossible at that time for the sheep-farmer to breed lambs on such farms as were not fortunate enough to possess them, but since the introduction and extensive growth of swedes, turnips, and other artificial food, many farmers that have little or no grass-land, have produced lambs equal, if not superior to those occupying the best water-meadows. In the neighbourhood of Salisbury, and in the Wiley Bourne, some farms have increased their dairy-stock, and they set apart a portion of the water-meadows for that purpose, but the system is by no means general.

*Manures.*

*Sheepfold.*—Of the different manures used by the South Wiltshire farmers, the sheepfold stands first. It is not confined to any one crop, for the sheep are regularly folded all the year through, whether feeding in the water-meadows, on the artificial crops, or on the down only. In the winter and spring for barley and turnips, and in the summer and autumn for wheat; 2000 sheep are generally folded upon an acre. A general plan in this district is what is termed “muckle and folding,” for turnips. A quantity of muck or litter is thrown over the land, and folded upon, in the early part of the winter; and ploughed in, where it lies till spring. This has been proved to be a good preparation for swedes or turnips: the same plan is often adopted with good results for wheat.

*Farm-yard.*—Farm-yard manure is not much economised, or very richly made in South Wilts, so few cattle being kept either as store-stock or for grazing. The principal part on some farms is made by the horses and oxen worked on the farm. There are some who keep cattle in the winter to tread in the straw, and on which they are fed: some times a few swedes, if very abundant, are added. Some pay more attention to this than others, and regularly provide roots for their cattle in the winter, in order to improve the quality of the manure. It is usually ploughed in fresh from the yards.

*Liquid Manure,* for two reasons, is entirely neglected at present, viz., the small number of cattle kept, and the homesteads being generally old and ill constructed for saving it.

*Bones, &c.*—The introduction of bones as manure has proved of incalculable benefit to this district. As in all other places, where the soil is adapted to them, they are extensively used over a considerable part of it, particularly where no other manure can be well applied, except the sheepfold. By the use of bones much of the light hill-land is brought into a good state of cultivation. They are used for turnips only: 16 bushels to the acre is thought quite sufficient. They are sometimes mixed with ashes, at the rate of 10 to 15 bushels of bones, and 20 to 30 of ashes.

Guano has not yet been extensively used; but from the trials made, and their results, it is likely to be more generally employed. Nitrate of soda has been found a good top-dressing; but it appears to have had its day, not being so much used as it was a few years since. Lime is not very extensively used in South Wilts, but there is an opinion in favour of its application on some soils. Coal ashes are extensively used on the sand-land, as a top-dressing for young clover: they are sometimes applied to sainfoin.

Woollen rags are often used as manure on the sand-land for swedes or mangold-wurzel. Soot is also found to be a good top-dressing for wheat, and is much used.

*Chalk* has long since been known as a permanent, and, consequently, a valuable manure, and it is to be found on every farm; but as most of the land that requires it has been chalked, there is little used now, except when some of the down-land is broken up, which is always benefited by its use.

*Paring and Burning*, or, as it is called in North Wilts, "stifle-burning," is a system lately introduced into the south of the county, where it finds many advocates. It is not confined to burning the turf of old lea or sainfoin, but is done on wheat or other stubble, as a preparation for turnips, and has been found to produce excellent crops. The method of doing it will be described in the report for North Wilts, where it has been practised with success for many years, on the stone-brash soils. On the hill farms great attention is paid to the collecting of ashes from burnt stubble, couch-grass, and other weeds. The parings from road-sides, old banks, and lynchets, ant-hills, &c., are burnt likewise; and the ashes mixed with bones, or other artificial manures, and sometimes applied separately, after the fold, or a light dressing of yard manure.

*Breed of Cattle.*—There is no particular breed of cattle kept in this division of the county, and very few of any kind are bred, there being but a small quantity of pasture exclusive of the water-meadows; and the sheep being the principal stock, very little attention is given to horned cattle. The dairies that are kept here are generally let to dairymen, and the cows are selected chiefly for their milking qualities, consequently there are all kinds of breeds, but the short-horn cross prevails. There are some farms, on the western borders of this county, where the pasture exceeds in quantity the arable land; here more attention is paid to the dairy, and some good herds of cows may be seen, principally of the short-horn breed, and some few good stocks of Herefords. The cows are generally bought at the fairs and markets in North Wiltshire.

*Pigs.*—The Berkshire spotted pig may be said to be the breed of pigs kept, of which large quantities are bred: they are not usually fattened, except for the use of the house, but are kept to run over the stubble and eat the offal corn; and are sold as stores, either to the labourer, or go into the dairy counties to be fattened.

*Sheep.*—The principal live-stock of this division of the county consists of sheep, for which the nature of the soil, and of the farms, is peculiarly adapted. Sheep are kept as store-stock, and chiefly for breeding, very few being fatted. Wether flocks are

kept only where there is no convenience for breeding. *South Downs* are nearly universally the breed now, and although the sheep-fold is a paramount object on a South Wilts farm, the quality of the animal is not neglected. As much attention has of late years been paid to the improvement of the breed of sheep in Wiltshire as in any county of England. Many of the flock-masters of Wilts have, by judicious selection of stock from Sussex, brought their flocks to a high state of perfection, and their stock being dispersed through the county, has greatly improved the breed of sheep. There are a few who prefer the Hampshire, or coarser kinds of sheep: and where the forcing of lambs from their birth, to be sold fat in the autumn, or for grazing as tegs, is adopted, it appears to answer well, as the extraordinary production of that breed brought to the fairs within the last few years will prove; but the generality of farms are stocked with *South Downs*. Where breeding flocks are kept, the usual plan is to keep the wether lambs during the summer as well as circumstances will admit, and sell them in the autumn for stock. The draft-ewes are generally taken from the flock soon after shearing, and are kept better than the flock; and likewise sold in the autumn either for fattening, or to produce another lamb for fattening, which last is the most usual plan. When there is no convenience for a breeding flock wether sheep only are kept, the system generally adopted being to buy lambs, keep them either one or two years, and then sell them for fattening. There are some who fat their wethers, but the number is very limited.

*Horses, or other Cattle* employed in the different operations of Husbandry.—*Oxen* are used only in ploughing, for which there are usually one or two teams kept on a farm, where they can be used with advantage; but some situations are not adapted to the working of oxen, the flints and the steepness of the hills, the small quantity of pasture-land on some farms, &c., being reasons why they are not used. The breeds preferred are the Hereford and Devon. They are often worked in pairs, and driven with reins, on the light soils. Three or four are usually worked in each plough on the heavier lands.

*Horses*.—The rage for fine fat heavy cart-horses, that existed some years since in this county, is at an end, and a lighter active kind of horse is now used. For ploughing the heavy land three horses are used; they are not worked at length, but invariably driven one before, and two abreast behind: for the hill-land, and the lighter soils, a pair are driven abreast with reins. There are some few who still fancy that ploughing cannot be done well without three horses on some of the light soils. Corn and hay are carried on waggons, to which two or three horses are attached, according to the distance, state of roads, &c. Manure

is carried in both waggons and carts, and three or four horses are used according to circumstances as above. One horse is attached to each harrow: two or three harrows are kept together by a rider, or overlay, and the horses draw abreast. The number to scarifiers, drags, &c., varies from three to six, according to the weight of the implement and nature of the work.

### *Implements.*

*Ploughs.*—The ploughs chiefly used in this district are the old Berkshire, or Tasker's two-wheel plough, Tasker's one-wheel, or D. P. plough, and the common one-wheel, which has been greatly improved by Reeves of Bratton, and which in some parts of the county is much used. A double furrow-plough is used on some farms in stirring or cross-ploughing fallows for turnips or barley. There are many others, but they are not in general use.

*Drills.*—The Suffolk drill is the principal drill used for corn and turnips: there are others used, but mostly of old construction. There are several men from Suffolk living in different parts of the county, who keep from five to ten drills each, and let them on hire at so much per acre. The usual price is 1s. 3d. per acre for corn, and 2s. for turnips, with manure. Many farmers keep drills themselves, but many even of the larger farmers prefer hiring. *Broadcast Machines* for corn and seeds are likewise used.

*Scarifiers* are but little used on the heavy lands, the preference being given to ploughing; but on light soils Finlayson's harrow, Carson's scarifier, and the common nine-share, are much used. The common drags and harrows are in general use, but lately iron harrows with curved tines have been introduced, and are found more efficient in working the heavy land. Crosskill's clod-crusher has been lately introduced on a few farms, and appears to be a useful (though an expensive) implement. *Land-Pressers* are in general use, as well as rollers, both of iron and wood.

*Horse-hoes* are not in general use; where they have been introduced, the preference is given to a set of hoes fixed in a beam, and attached to the wheels and frame of the Suffolk drill, by which the whole breadth of the drill is hoed at once. The hoes are arranged according to the number and width of the drills. *Waggons only* are used for carrying hay and corn, but carts and waggons are used for carrying manure. The carts are made deep in the bed and strong, and are well constructed for carrying the heavy loads which are often placed on them. Gardener's turnip-cutter has decidedly the preference for beasts and sheep; but Moody's crusher is sometimes used when Swedes are given mixed with chaff. Chaff-cutters of various kinds are now in use: Ransom's one-knife, Passmore's, and a variety of others, too numerous to mention, worked both by horse and manual labour. Most of the farmers have a thrashing-machine worked by horse-

power; there are some few hand thrashing-machines introduced, and many portable machines let on hire, in the same manner as the drills.

*Winnowing-machines*, with the fan and Amesbury-heaver, are used for dressing corn. There have been lately many new implements introduced in the different branches of farming, but those enumerated are the principal kinds in general use.

*Drainage*.—The condition of this division of the county as to moisture may be said to be good, as the natural formation of the country is well calculated to carry off the surface-water; and the substrata being generally porous, drainage is seldom required except on the heavy lands, which do not form a very large portion, and the principal part of that has been under-drained.

#### *North Wilts, or the Oolite District.*

North Wiltshire differs very much in appearance from the southern division of the county. Instead of the open down country of the latter, the whole consists of enclosures, some of which are very small; and in many places the hedgerows are so thickly stocked with trees as to give the appearance of an extensive plantation when viewed from a distance.

There is great variety of soil in this part of the county, as might naturally be expected from the various strata of which it consists. On the borders of Gloucestershire, a narrow belt of oolite, with its subordinate formations of forest marble and cornbrash (all three being generally known to farmers by the name of stonebrash), extends from the neighbourhood of Bradford to the extremity of the county near Cirencester. The land here is for the most part arable, upon which sheep-farming is practised after the same manner as in South Wilts. The soil is generally thin; some poor clays are also met with here; but there are notwithstanding some rich gravelly loams upon the alluvial soil, composing the banks of the Avon and Thames rivers. Within this belt there is a much broader tract of deep clayey land known by the name of Oxford clay. It commences beyond Chippenham, and proceeds north-eastward throughout the county, passing by Malmesbury on one side and Wootten Bassett on the other. A great part of the soil upon this stratum is of the very worst quality.\* Between the Oxford clay and the chalk hills of the southern division there are two other strata of some extent, viz., coral, rag, and Kimmeridge clay. The soil upon the first of these resembles that of the oolite, forest marble, and cornbrash, and is known by the same name; the last resembles the Oxford clay, but is of a better quality. There is a small quantity of sandy soil near Calne, but it is by no means so fertile

\* This obdurate clay wears the same appearance, and bears deservedly the same character, wherever I have seen it in Berkshire, Buckinghamshire, and Lincolnshire.—Pitt. PUSEY.



as that of the southern division. It produces, however, excellent vegetables, to the growth of which it is chiefly applied. The city of Bath is mainly supplied with carrots, turnips, and green peas from this source. *The size of the farms* in this division differ from those of the south, being mostly small, say from fifty to five hundred acres; the largest are in the arable part of the division. The principal part of the arable land of North Wilts then consists of stonebrash soil. There are, indeed, several portions here and there of a different kind, but they are generally small, belonging to dairy farms, and cultivated at the option and convenience of the occupiers. Upon these there are so many modes of cropping, and the soils are so various, that it is impossible to reduce it to a system. But a more regular method of cropping is pursued upon the *stonebrash* soils varying according to its depth. The four-field system is generally pursued on the deepest, and a five-field upon the thinnest. The rotation of the four-field is generally the common or Norfolk course.

- 1st. Wheat.
- 2nd. Vetches and turnips.
- 3rd. Barley or oats.
- 4th. Clover.

The five-field is the same, with the difference only of the clover remaining two years, or broken up the second year and followed by turnips or spring vetches. It cannot be said that rotation is always observed, for some farmers have introduced the practice of growing two green crops in succession, as well as two corn crops; and some do not scruple to take two corn crops and one green crop. This soil is not so generous as that of South Wilts, and is not kept in such high condition, there being neither water meadows nor downs to assist it, *nor is the cleanly state of the arable farms in North Wilts proverbial*; but there is a spirit abroad amongst us for improvement, which is daily increasing,

In respect to *Manures*. Sheepfolding is practised after the same manner as in South Wilts. Bones have been found to answer well upon the stonebrash, but they are not in general use, nor is much attention paid to any other artificial manures. *Soot* is used with advantage as a top-dressing for wheat. *Stifle-burning* is by far the most general preparation for turnips, and is done after the following manner:—The land is raftered, and pared with the breast-plough; or raftered again in a cross direction, to get sufficient earth for burning. It is then worked with the drags or harrows, and when dry the couch or turf is raked into heaps, and a small bundle of straw placed in the middle of each heap and set on fire. The hole is then closed, and as soon as the heap burns freely, the earth is shovelled upon the fire in large quantities;

sometimes as much as eight or ten bushels are burned in heaps, at as many yards asunder. The ashes, when cold, are spread evenly over the land and ploughed in. The farmers of this district (that is the *stonebrash* soil) place great dependence on ashes for their turnip crops; banks are grubbed, and the turf and roots burnt; road-sides pared, couch grass, and other weeds are collected and burnt: and the ashes are drilled for turnips, some few adding bones or other artificial manures, but the many are content with the ashes only, but the turnips often prove only an apology for a crop. *Yard manure* is generally better made than in South Wilts, a larger number of cattle being kept, and is mostly used for the wheat crop in a decomposed state. On the thin soils the plan of spreading it on the land after it is ploughed is much in fashion at present, and is done in the following manner:—Upon the top of the ridge seven furrows are ploughed, being about the width of the cart; the manure is then placed in heaps upon the furrows, and when the whole field is ploughed, it is spread abroad and worked in. Wheat is generally drilled upon the large farms, but upon small ones, where there is not much sown, it is often hoed in. Spring sowing is yearly becoming more general. In taking the crop reaping is universal, at prices varying from 6s. to 10s. the acre, according to crop. *Barley and Oats* are often ploughed in, but the drill system is adopted by many. Mowing is always adopted, price 1s. 6d. to 2s. per acre. Beans and Peas are but little cultivated, the same remark applying as in South Wilts.

*Turnips* are generally sown broad-cast where stifle-burning is practised, or when farm-yard manure is used; but drilling is preferred when bones or other artificial manure is applied. When the ashes are not sufficient to be spread over the land, they are usually collected and drilled in; some persons sow their turnips upon ridges, but the number is very limited: they are chiefly hoed by hand. On some farms a portion is carried off the land for consumption by cattle in the yards; and on the light soils they are mostly fed on the land by sheep. *Rape, Rye, Vetches*, and other green crops, are cultivated as in South Wilts; and upon the large farms are consumed on the land by sheep. On smaller farms vetches are frequently sown for seed. *Sainfoin* is sown upon the *stonebrash* soil with much advantage, and a great quantity is sown wherever there is no sheep-sleight, or but little pasture land on the farm. *Artificial Grasses* of the same kinds are sown as in South Wilts.

*Potatoes* are extensively planted on the dairy farms where any arable land is attached, and are often the only root-crop taken. Upon the lighter soils, however, they are not much cultivated, except by the labourers, to whom a good deal of land is annually let in some parishes. They are much used in feeding pigs.

*Pastures.*—The usual method of managing the pasture land is to feed and mow alternately. There is not always sufficient attention paid to it, especially where there is much arable land in the same occupation, the grass land being neglected for the improvement of that producing corn. Composts of road dirt and ditch scrapings, with a little yard dung, are the principal dressing allowed, and even that but seldom. It is often well managed when the farm consists entirely of pasture land, and in no part of the county is pasture land managed so well as in the neighbourhood of Devizes, where there is little or no arable land occupied with it.

*Breed of Cattle.*—The proportion of inferior and wet pasture land is great in comparison with the dry, healthy, and good; notwithstanding which it is generally applied to dairy purposes, and not unfrequently does it happen that the cheese made upon it is of a better quality than that of the best land. The breed of cattle now preferred for the dairy is the short-horned, especially upon the best land; but very few are bred there, the whole being applied to the dairy and grazing. These dairies are supplied with heifers, of which large droves are brought from the northern counties to the fairs and markets of Wilts, and although there are not amongst them a great number of short-horns of the purest breed, many excellent packs of cows may be seen here very nearly approaching to the pure breed. There are a few individuals who breed sufficient for their own dairies, who have lately selected some excellent short-horned bulls in the north of England. Upon the inferior grass land it is usual to breed to an extent sufficient for keeping up the dairy stock, and different crosses, such as the Gloucestershire, Hereford, and short-horn are kept, according to the opinion of the farmer in regard to his own interest; there is, consequently, no similarity of breed to be found; in fact, upon many farms it would be difficult to find two animals of the same breed; but even there the short-horn breed predominates. There are very few herds of the old long-horned cows now remaining in this county, but they were nearly universal in 1811. The dairy farmers generally fat all their calves that fall early enough to be fattened before grass time. After that period the remainder are bought by dealers and sent into other counties for grazing. The whole of the milk is then used in making cheese, for the excellent quality of which North Wilts has long stood pre-eminent. Those who are particular in the selection of their stock always sell their cow-calves for weaning at good prices. The number of young stock now reared is greatly reduced by the enclosure of the common land in this division of the county; for once enclosed, the land is either broken up or applied to the dairy. A few are reared for sale on some farms, where the quantity of arable land is considerable, and the pasture not sufficient for a dairy to be

kept with advantage. In this case the short-horned breed is preferred on account of their coming to maturity at an early age.

*Grazing of Cattle.*—A great part of the rich meadow land upon the banks of the Avon and Thames, and in other fertile districts of this division of the county, is applied to the grazing of cattle and sheep. Of cattle, heifers are principally the stock chosen for this purpose, and are supplied from the neighbouring dairies. When oxen are chosen, which are comparatively but few, Herefords and Devons are the breeds preferred. Of sheep, both South Down and Long Wools are fattened. (When there is a portion of arable land attached to the farm, and roots are grown, winter grazing is often adopted, the dairy farmers grazing some of their cows that are out of season.)

*Pigs.*—The breed of pigs is the same as in South Wilts, viz., the Spotted or Berkshire, of which great numbers are bred, and fattened at the dairies, at all seasons of the year. Their chief food in the summer is whey, and in the winter potatoes, corn being added always to both.

*Sheep.*—The sheep stock of this division of the county is different from that of South Wilts, the cross between the Cotswold and South Downs being mostly preferred. There are, however, some flocks of pure South Downs and Cotswolds. Nearly the same system of management in respect of keeping and sale is adopted in both divisions. On the Gloucestershire side of the county some farmers pursue the plan of their neighbours, viz., that of keeping smaller breeding flocks, and fattening the whole of their sheep.

*Horses.*—A pair driven abreast with reins is the usual number employed in ploughing the lighter soils; three or even four are sometimes attached to a plough upon some of the heavy land. Oxen are very little used in this division. Harrowing, dragging, scarifying, harvesting, and carting of manure are done the same as in South Wilts.

*Implements.*—The plough generally used upon the stonebrash soil is the one-wheel plough made by Reeves of Bratton. It is nothing more than the common plough with a longer turn-furrow and beam, by means of which the furrows are more evenly turned, the draught steadied, and the plough not so liable to be shaken out of its work by the stones. Various kinds are in use upon other soils, but principally one-wheel ploughs of old (and some few of new) construction. The Suffolk drill is chiefly used, and is generally hired as in South Wilts. Drags and harrows or the same. A scarifier made by Phelps of Lacock is well adapted to light soils, and much used on the stonebrash. The Uley cultivator has been lately introduced upon some of the heavier soils. Land-pressers are in general use upon the stonebrash. Horse-

hoes are very little used either for corn or turnips. Waggon and carts are similar to those of South Wilts, and used for the same purposes; nor are the turnip-cutters, thrashing-machines, chaff-cutters, or winnowing machines at all different.

*Drainage.*—Much of the land here is in a very imperfect state of drainage; and although a good deal has been done, and is still in progress, it will be long ere it is complete, unless it proceeds more rapidly than at present. A great part of what was done some years ago is quite inefficient; the drains not having been made sufficiently deep, and the distance between them too great. Stone-draining has been generally practised on the land when materials were near at hand, and turf-draining upon much of the pasture-land. Tile-drains are comparatively but little used, the old method being still pursued, but the work is done much more effectually than in former times. Thorough-draining and subsoil-ploughing is scarcely yet introduced, although much of the clay-land would be wonderfully improved by it: to carry off the surface-water trenching only is all that is done to a good deal of the pasture.

*The Tenure on which the Farms are generally held.*—In Wiltshire the farms are held on a variety of tenure. Leases are granted by some of the large landed proprietors for seven, fourteen, or twenty-one years at a fixed rent; others let their farms on leases of four, eight, or twelve years on a corn-rent, the average price of corn being taken from the scale that regulates the rent-charge published yearly under the Tithe Commutation Act. The number of farms let in this manner are not very considerable. By far the greatest proportion of farms are held by yearly tenants. Michaelmas is the usual time of entry in South Wilts, and Lady-day in North Wilts.

*Wages of Labourers.*—The wages of the labourers of this county vary with the price of wheat. At present\* the general price is 7s. per week in the southern division, and 8s. in the northern; but there are some advantages in addition to the 7s. and 8s. per week. The farmer provides from 10 to 20 perches of land ploughed and manured for potatoes for his constant men, and a cottage and generally a good garden at a very moderate rent, say from 30s. to 50s. per annum. Shepherds and carters receive 2s. per week extra, or an equivalent in rent, wood, coal, &c. In the summer work is mostly done by the piece, and men earn high wages. In South Wilts it is usual to give 2s. per day for six weeks in the harvest-time to day labourers. Beer is given throughout the year in North Wilts, two quarts per day in the summer (unlimited in harvest and hay-making time), and one

\* This was written in the winter, 1843-4. The wages in South Wilts have generally been raised to 8s. per week since that time.

quart per day in the winter. It is not usually given in South Wilts except at harvest-time. Women's wages are from 7*d.* to 10*d.* per day.

*Poor Rates.*—From the best information I have been able to collect from the different Unions in the county the average amount of poor-rate is 3*s.* 2*d.* in the pound upon the rateable value, which includes county and police rates.

*Improvements and Alterations since 1811.*—When the report of Mr. Davis was published, it appears that a very considerable portion of the land was in common field husbandry, both in the southern and northern divisions of the county, and many large tracts of grass-lands in the northern division were in open commons. Most of these commons are now inclosed; some are converted into arable land, and some still remain in pasture, and the common field husbandry, or “tenantry,” as it is called, is abolished, with the exception of five or six parishes. Since that took place, improvements have been continually making in the agriculture of this county. At that time nearly one course of cropping was pursued on all descriptions of soils, whether they were calculated to grow such crops or not. Root-crops were but partially cultivated, the great dependence for sheep-food being on the produce of the downs, artificial grasses, and water-meadows. Corn-crops, clover, and fallow formed the usual rotation: now a regular succession of green food is provided in addition to those most useful appendages to the sheep-farm; consequently the number of sheep is greatly increased, by some it is calculated that it is nearly doubled, and although there is still the “pride of keeping fine sheep,” as Mr. Davis expresses it, that object is not obtained by reducing the number, but by producing an increase of food. The land is in a much higher state of cultivation than at that time, and produces much better crops of corn, both in quantity and quality. Various rotations are now adopted on the different soils, mostly tending to a large growth of green crops, as it is found to be the most profitable method of manuring the land. A naked fallow is now only known by name except on the very stiffest soils. The introduction of bones and other artificial manures has wrought a great change in the agriculture of this county (as well as in all others), more particularly on the lightest soils, which were formerly considered too poor to be cultivated. Their use has greatly contributed to bring the agriculture of this county (especially of the southern division) into that superior state which has excited the surprise even of some of those patterns of good farming, the farmers of the Lothians, who have visited this part of the kingdom, and the commendation of all who are capable of judging on the matter; for the farmers of South Wilts, taken as a body, are excellent farmers, but those of North Wilts

(though the writer is of that class), it must be confessed, are far from being so; but there are many exceptions in both cases. The ploughs in general use are somewhat similar to those described by Mr. Davis; but there is this difference, they are not the great heavy cumbrous implements of that day, very great attention having been paid lately to their improvement by the different makers, with regard to the draught and turn-furrow, &c.: and not only are the ploughs improved, but the ploughing also; the land is ploughed much deeper, and the work performed generally in a much superior manner. The prizes given by the different agricultural societies at their annual ploughing-matches have increased among the ploughmen throughout the county a spirit of honest rivalry, which has done great good. While writing on the improvement of ploughs and ploughing, it will be well to point out another most important alteration connected with it, that is, driving a pair of horses abreast with reins, which is now used very generally on all the light lands, whereby the number of horses is considerably diminished. The general application of the drill-system for corn and green crops, which was scarcely introduced in 1811, is an important improvement, both in saving of seed and the opportunity it gives for clearing the crops; and although the use of the horse-hoe has not followed the introduction of the drill, as in many other counties, hoeing is not neglected, but is chiefly done by hand. With the exception of waggons, carts, ploughs, drags, and harrows, the implements now in general use were almost unknown in this county in the year 1811, as they are not mentioned by Mr. Davis—in fact many of them have been introduced recently.

*Drainage.*—Although the drainage of some parts of the northern division of the county is far from being in a good state, there are some districts that have been greatly improved in this respect, particularly the arable land, much of which is inclined to be very wet and full of springs. A good deal of the poor pastures remains much in the same state as in 1811.

Of all the alterations that have been made in the agriculture of this county there is none that strikes one more forcibly than the change made in the cattle; although the same systems are followed, sheep-farming in South Wilts and dairy-farming in North Wilts, a complete change has taken place in the breed of cattle and sheep since the year 1811. The long-horned cows, which at that period were the universal breed of the county, have now become nearly extinct, and the short-horns for some few years past have been preferred in the best pasture districts, and this breed appears to be gaining favour with most dairymen even on the poorer lands. The Wiltshire horned sheep, which were then the breed of the county, have entirely given way to the South Downs

in South Wilts and some parts of the northern division, and to the Cotswolds and the cross of these two breeds in the other parts. The breed of pigs is also totally different, and the change has no doubt been beneficial, the pigs now kept being generally of a superior description. In no branch of the agriculture of this county is improvement more apparent than in the management of sheep. As before stated, regular successions of green food are now grown, and often three or four kinds are provided during the summer, such as clover, sainfoin, vetches, rape, early turnips, &c., in addition to the grass upon the downs and sheep-walks, in order that they may often have a change of food; good supplies of turnips and swedes are given in addition to hay, which was formerly the only winter-food. Hay is now nearly everywhere cut into chaff, and sent to the fields in bags, or covered waggons made for that purpose—a circumstance which would have rather astonished a farmer of 1811. Swedes are likewise preserved, or rye, or winter-barley, or some other green food, is provided for them while feeding in the water-meadows, which was thought quite unnecessary some years since. The ewe lambs were formerly sent into the grass districts to be wintered; now provision is made for them on the farm, except when the turnip or hay crop fails, and then a little corn or cake is often given, in order to keep them at home. There is also great improvement in the management of cattle, particularly where young stock are reared; they are much better fed and lodged in the winter. The latter remark applies to cattle generally, as they are not kept in the fields nearly so much as formerly, sheds being provided for them.

---

XI.—*Observations on the Natural History and Economy of the Insects called Wireworms, affecting the Turnips, Corn-crops, &c.; also of their parents the Elaters or Beetles, called Skip-jacks, Click-beetles, &c.* By JOHN CURTIS, F.L.S., Corresponding Member of the Imperial and Royal Geographi Society of Florence, &c.

#### PAPER VI.

It is an incontrovertible axiom—"That the profit we derive from the works of creation will be in proportion to the accuracy of our knowledge of them and their properties."—*Kirby and Spence's Int. to Ent.*

As Wireworms not only injure the turnip but various other crops, I shall terminate my account of the insects affecting that plant by detailing the history of the animals thus designated, making them the transition to the corn-crops, which are subject to the attacks of other insects, whose economy will be found equally interesting and important to the agriculturist.



Of all the insect enemies with which the farmer has to contend, there are none which are more fatal in their effects, and more difficult to overcome, than the Wireworms. It has already been stated that the larvæ of many insects are not unfrequently attached to one species of plants, or at least to one particular tribe or "natural order;" thus the ravages of the Turnip-fly\* are confined to the Cruciferæ, † of the Black-caterpillar ‡ to the turnip, of the Hessian-fly to corn, &c.; but in the Wireworm we have an example of a larva which may almost be termed omnivorous, as far as regards the productions of the field and garden, for it will feed upon corn, turnips, mangold-wurzel, potatoes, grass, and cabbages, as well as upon the roots and stems of the choicest flowers; its operations therefore being so extensive, the mischief done by these formidable little animals must be incalculable.

It is true that every grub and worm § found at the roots of their crops by the farmer and gardener has been hitherto stigmatised with the appellation of "the Wireworm," which has no doubt contributed to add to the amount of mischief complained of; nevertheless, the true Wireworms have enough to answer for on their own account, and the great ignorance that has existed regarding them renders a narrative of their natural history very desirable. An instance, which occurs in the 'Gardeners' Magazine,' || will be sufficient to substantiate the assertion; figures 93, b and c, are there given as the larva and pupa of *Elater segetis* ¶ (viz. the true Wireworm), but they are undoubtedly the offspring or produce of some insect not belonging to the same order, but probably to the *Diptera* or two-winged flies. Such errors are sadly mischievous in a work expressly intended to convey information to all classes, and no subsequent correction can entirely eradicate a blunder and its effects when once circulated by the press.

It will probably surprise the general reader to learn that there are nearly seventy species of beetles in this country which are the parents of Wireworms; many of them however live in decaying trees or under the bark, and the number that affects our crops of corn, vegetables, and flowers is very limited; of these we shall treat as far as we have been able to obtain data for their histories, but their economy appears to be so similar, that it will be most convenient to consider them in the first instance as the Wireworms.

\* Royal Agric. Jour., vol. ii. p. 193.

† So called from the four leaves or petals of the flowers forming a cross.

‡ Royal Agric. Jour., vol. ii. p. 364.

§ Millepedes, Centipedes, and the larvæ or maggots of Gnats and Tipulæ have been thus confounded.

|| Vol. vi. p. 500.

¶ This name is synonymous with *E. lineatus*, as will be shown a few pages farther on.

Of the species of beetles producing these larvæ (for such the Wireworms are), there are not more than eleven I believe that will require our attention; they belong to the ORDER COLEOPTERA, they form the FAMILY ELATERIDÆ and the GENUS ELATER of Linnæus, which has since been divided into several others by modern naturalists. These beetles have been called Elaters from a peculiar power they have of leaping up like a tumbler when placed on their backs, and for this reason they have received the English appellations of Spring-beetles and Skip-jacks, and from the noise which the apparatus makes when they leap they are also called Snap or Click beetles, and likewise Blacksmiths. The species we will enumerate and describe hereafter, and detail at present their economy: after pairing, the female beetle lays her eggs; the eggs produce little larvæ called Wireworms, which grow and change to pupæ or chrysalides, and from these again emerge the beetles.

Whether the eggs (pl. I. fig. 1), which are nearly globose or slightly oval, yellowish white, and very minute,\* are laid in the earth close to the root of a plant, or between the enveloping leaves or sheaths near the base of the stalk, I am unable to determine; it is a very desirable part of their economy to be ascertained, but hitherto I have endeavoured in vain to detect a female depositing her eggs or to find any, except by dissection, when I have observed them close to the base of the oviduct; the little worms produced from these eggs must be almost invisible to the naked eye; they grow very slowly, and eventually attain the length of three-quarters of an inch, rarely eleven lines.† These are the true Wireworms (fig. 2), so named from their cylindrical form, smooth surface, and extreme toughness. In this state they live five years, as proved by Bierkander,‡ casting off their skins thrice, probably, like other larvæ, as they increase in stature. I have examined many of these exuvia, which are brown; and the animals perform this extraordinary moult like other caterpillars, by splitting the horny skin along the thorax, and drawing themselves out at the aperture, leaving (like a snake) a perfect exuvia of every part, including eyes, horns, feet, and it is believed also of the internal organs.§ Immediately after this operation, the Wireworms are very tender and of a whitish colour; but as soon as they recover from this great effort of nature, they move about with the greatest facility, gliding along and soon burrowing into the earth when

---

\* Those of *E. pectinicornis* are oval, whitish, and shining. De Geer's Hist. des Ins., vol. iv. p. 143.

† There are twelve lines in an inch.

‡ Commun. to Board of Agri., vol. iv. p. 413; and Trans. Acad. Scien. in Sweden, vol. for 1779, p. 285.

§ Vide Mr. R. J. Ashton's paper in Trans. Ent. Soc., vol. iii. p. 157.

dug up and laid on the surface, their smooth horny coats being well adapted to their subterranean habits.

The Wireworm very much resembles the Mealworm;\* it is of a pale ochreous colour, becoming darker when dead, with a few hairs scattered over its polished shining skin; it is semicylindrical, the back being convex, the belly more flat; its head is flattened or wedge-shaped, and there are twelve abdominal segments; the mouth is rather small, and comprises an *upper-lip* (fig. 3) with a horny base, the margin leathery and bilobed; it is small and concealed beneath the *clypeus* (fig. 4), which is rigid, with a ciliated lobe on each side, and three minute teeth in the middle; beneath is a large semiovate space (fig. 5) formed by the union of the base of the maxillæ (*b*) with the *mentum* or chin (*c*), which is long and narrow; the *under-lip* (*d*) is small and somewhat obtrigonal, the base truncated, the margin undulating and furnished with two small biarticulate *palpi* or feelers (*e*), sometimes with an indistinct third joint: on either side is the *maxilla*, having a minute and densely pubescent lobe on the inner angle, with a larger biarticulate one behind it † (*f*), and a four-jointed *palpus* or feeler on the outside, the terminal joint the smallest (*g*); above these are the *mandibles* or jaws (fig. 6), which meet over the mouth, one being placed on each side; they are strong, horny, and of a pitchy colour, being more or less pointed, with a tooth below the apex, and frequently a smaller one at the middle, ‡ and below this is a ciliated space. There are also two little *antennæ* or horns (fig. 7), placed in front of the head near the anterior angles; they are triarticulate and similar to the palpi in form, the basal joint being the largest, the terminal one short and slender (*h*); sometimes there is a tubercle projecting from one of the angles of the second joint (*i*), but whether these are accidental differences or characteristic of different species is not at all clear. On each side of the head and behind the antennæ is a minute dot like a little eye. The first abdominal segment is much longer than the two following (fig. 2 § *j*), the eight succeeding have a minute spiracle on each side (fig. 2); the terminal one is the longest and conical (fig. 9), with a brown or blackish oval aperture or spiracle (?) larger than the others on each side towards the base (*k*); beneath this segment is also a false leg or prehensile foot (*l*) which assists in walking, and is probably the vent for the evacuation of the digested food; the three first or thoracic segments are fur-

\* Curt. Brit. Ent., fol. and pl. 331.

† These are the analogues or parts which correspond with the two hairy lobes in the beetles, vide fig. 24.

‡ These jaws are sometimes so worn at an advanced age, that the apex is rounded and the smaller teeth have entirely disappeared.

§ Royal Agric. Journ., vol. ii. p. 376, pl. B, f. 3.

nished with six short legs, a pair being attached to each near the hinder margin; they are nearly alike and four-jointed (*m*), the joints being rough with short brown spines, the apex furnished with a strong claw, slightly curved and nut-brown (*n*).

When the Wireworm has arrived at maturity, it descends a considerable depth into the earth, forms an oval cell there (fig. 10) entirely composed of the surrounding particles of soil, and not even lined with silk as in the Turnip Saw-fly; it then casts its skin again, and becomes a pupa or chrysalis, generally, it seems, at the end of July or beginning of August; it is long and narrow in form, like the perfect insect, but it is of a yellowish-white (fig. 11); there are two minute spines projecting from the anterior angles of the thorax; all the oral organs are visible, the horns and legs are folded or incumbent upon the breast, and the wing-cases as well as the wings are small and the least developed of any part (fig. 11\*); the scutel and abdominal segments are distinct, the apex being furnished with two moveable spines and two lobes terminated by nipples in the middle beneath. Of course at this period the animal is at rest, being deprived of the power of locomotion, and is consequently no longer injurious. Several were found in this state on the 26th of July, 1841, and Bierkander says that in the month of July his Wireworms became pupæ, from which the Elaters emerged in their perfect state about the 10th of August; it has also been elsewhere recorded that they remain in the pupa state two or three weeks, but many no doubt pass the winter buried and protected from casualties and the rigour of that inclement season; when, however, the appointed time comes, they burst from their shrouds and the earthy tombs they inhabit, and rising through the soil arrive at the surface changed to perfect beetles, but of a whitish colour, soft, and extremely tender; exposed to the air and light, their bodies harden and their colour gradually changes, so that in a few hours they have attained the horny coat which covers them and assumed the tints which the Author of nature has assigned to the species.

The parts of the animal which were lately indistinctly seen as through a veil are now distinctly visible, and all the members are liberated to give action to its body and animation to all its senses. They walk and run like dogs, with their heads and trunks declining, their noses close to the ground; when they leap, their legs are applied closely to their bodies, and by the same means they fall down when the plants are approached upon which they are resting. These Elaters (figs. 12 and 25) have small heads and eyes, the latter minute, hemispherical, and reticulated, a portion being frequently concealed beneath the margin of the thorax; the two horns or *antennæ* are generally slender and eleven-jointed (fig. 13), and received when at rest into two grooves beneath the

*thorax* (fig. 19, *o*), which is more or less oval-quadrangle, the hinder angles produced and forming spines; the wing-cases or *elytra* are long and narrow, covering a pair of ample *wings*, which are closed longitudinally like a fan, with the tips folded over when in repose. They have also six *legs* for walking; the anterior pair is a little the shortest, and the hinder the longest (fig. 14); the thighs are stout; the tibiae or shanks simple; the tarsi or feet are as long and all five-jointed, the basal joint the longest, except in the anterior pair, and the last is furnished with two curved acute claws. In this state its habits are quite altered; instead of the ravenous and destructive Wireworm it is now become an active beetle (figs. 12, 25, and 26), running up the grass and readily flying to flowers, to which it resorts for food; the sexes also pair, and the business of the male being accomplished he probably dies, but the female is longer lived; the organs of generation are frequently at this period exerted, when they may be easily examined with a magnifying glass; those of the *male* (fig. 15) are received into the apical segments of the abdomen in repose (*p*); they are ochreous and shining, formed of two valves rounded at the apex with two minute hairs, the central lobe being lanceolate (*q*). The *female* has a longish horny ovipositor, which is easily protruded from the extremity (fig. 16); it is flat and linear, the apex conical, thickened, and forming two lobes, each of which is produced and hairy; at the tips are two minute obovate appendages, with two hairs at the apex (*r*). In *Elater obscurus* the flattened tube is terminated by two horny lobes (fig. 17, *s*), pear-shaped when united, with two hairs outside, and having no appendages; they are capable of distension to allow the eggs to pass. In the same species the generative organs are not so long as usual in the male (fig. 18); the lateral valves are pointed and notched outside, and the central lobe is strap-shaped, the apex conical, with a minute notch on each side (*t*), and this appeared to me to be folded back upon the base in a quiescent state.

We have already alluded to the remarkable power these beetles have of recovering their natural position when they fall upon their backs; their legs not being long enough for that purpose, they are furnished with an apparatus which I will now describe. Fig. 19 is the underside of the thorax, fig. *u* showing the cavities in which the first pair of legs is inserted; between them arises a spine with two small teeth at the base (*v*), and sometimes one above, towards the apex. Fig. 20 is the underside of the post-pectus or breast, with two oval cavities into which the second pair of legs is fitted (*w*); and behind are the trochanters or hips, to which the third pair of legs is attached (*x*): at the anterior margin is a long cavity (*y*), into which the spine (*v*) is pressed, and the animal, when on its back, by depressing the head and tail, raises this spine

with such force, that the point is jerked out of the cavity that holds it; bringing the centre of the back suddenly upon the plane, a spring is created which raises the beetle many inches from the ground, and turning over in the air it alights on its feet; the height of the leap depending greatly upon the hardness and smoothness of the surface of the plane, and some species can bound much higher than others.

The mouth of the perfect beetle varies considerably from that of the larva or Wireworm; the upper-lip or *labrum* is rather large (fig. 21), and nearly concealed beneath the projecting forehead; it is transverse-oval, the anterior margin is pubescent, with a membranous edge, and it is ciliated with long hairs. The two *mandibles* or jaws (fig. 22) close over the rest of the mouth, which is sometimes scarcely discoverable in repose; they are strong and horny, clawed at the apex, with a strong tooth on the inside; towards the base is a leathery oval lobe, the margin of which is densely hairy. The chin or *mentum* is transverse and narrowed in front (fig. 23), from whence arises the *labium* or under-lip (*z*), which is leathery, somewhat quadrate, the anterior margin trigonate; to the centre of this is attached a pair of small *palpi* (*a*) of three joints, the two basal ones are small and pear-shaped, the third is larger and hatchet-shaped. On either side of the chin is attached a *maxilla* (fig. 24), which is terminated by two broadish lobes that are densely pubescent at their extremities; and on the outer edge arises a *palpus* or feeler (*b*), larger than the labial and four-jointed; the basal joint is small, second and third much larger and stouter, especially at the apex, the fourth joint the largest and more or less hatchet-shaped; they are slightly hairy.

Amongst these Elaters, which are the parents of the Wireworms, just as the Turnip Saw-fly is of the Black Caterpillar,\* there are four species which are most common in corn-fields: their metamorphoses have been traced from the worm to the perfect beetle, and these we will first describe. Owing to a difference in their structure, they are not included in the same genera by modern naturalists; one group being called *AGRIOTES* by Eschscholtz, the other *ATHIÖUS* by the same author;† but they are all Elaters of Linnæus. In *Agriotes* there are three species, unless one be a variety only, which affect the crops; one is called

1. *E. sputator* by Linnæus, and is the smallest of them: it is shining, piceous, and clothed with very short ochreous pubescence: head and thorax black, thickly and distinctly punctured; the latter orbicular, convex, the hinder angles forming short stout teeth, sometimes rufous; down the centre is a channel: scutel subovate: elytra or wing-cases not broader than the thorax, but

\* Vide Royal Agr. Journ. vol. ii. pl. B, figs. 2, 6, and 7.

† Curtis's Guide, Gen. 309, Nos. 30, 31, and 32.

more than twice as long, elliptical, convex, slightly rugose, with nine punctured striæ on each: antennæ and legs rufous; the former not longer than the thorax, slender, the joints obconic, basal the stoutest, second a little longer than the third, which is the smallest: feet with five distinct joints: length from 3 to  $3\frac{1}{4}$  lines, and breadth from 1 to  $1\frac{1}{8}$ . *Obs.*: some specimens are entirely tawny, excepting the black eyes and tips of the mandibles; whilst others have the head and thorax only black, the hinder margin of the latter and the spines being tawny as well as the elytra. From this great difference of colour, this Elater was named *E. variabilis* by Herbst; and Paykull, thinking it was the same as the next described species, gave it the name of *E. obscurus*. *E. sputator* is very abundant everywhere from the beginning of May to the end of June in hedges, on grass under oaks, in corn-fields, &c.; it occurs also in profusion amongst rejectamenta left by floods.

2. *E. obscurus*, *Linn.* (fig. 25), named also *E. variabilis* by *Fabricius* and *E. obtusus* by *De Geer*. It is rather more robust than the former, and the sides of the thorax are more convex: it is piceous, densely clothed with short depressed ochreous hairs: the head and thorax are thickly and distinctly punctured; the latter is as broad as it is long, orbicular, very convex; the posterior angles are produced into strong spines, and there is a channel down the back: scutel oval: elytra not broader than the thorax, and nearly three times as long, elliptical and convex, the extremity when united conical, the apex of each rather acute, reddish brown and punctured, each having nine punctured striæ somewhat in pairs: antennæ a little clavate, quite as long as the thorax; basal joint stout, second and third of equal length, shorter and smaller than the following, the terminal one ovate-conic (fig. 13), reddish brown as well as the legs: the feet or tarsi distinctly five-jointed: length  $4\frac{1}{4}$  lines to  $4\frac{1}{2}$ , breadth  $1\frac{1}{2}$  to  $1\frac{3}{8}$ . *Obs.*: the pubescence is so thick on perfect specimens as to give them a dull brown tint all over, whilst others which are old and rubbed appear blackish. From April to Midsummer this beetle is abundant in fields, pasture lands, woods, and gardens. It was this species which Mr. Paul, of Starston in Norfolk, bred from the Wireworms.\*

3. *E. lineatus*, *Linn.* (fig. 26); *E. striatus*, *Panzer*; *segetis*, *Bierh.*, *Gyll.* This insect is supposed to be a variety only of the foregoing *E. obscurus*, with the elytra or wing-cases striped, the spaces between the striæ being alternately dark and light, forming four brown and five testaceous lines. It is an exceedingly common species in various situations, and is the most frequently bred from the larvæ by those who have taken the pains to rear them: in April I have found great numbers under stones by the sea-shore;

\* Kirby and Spence's *Introd. to Ent.*, 6th edit., vol. i. p. 147.

in May they were congregated upon a yellow ranunculus or buttercup in an ozier-holt in Norfolk. They abound also on grass, in hedges, corn-fields, &c. I have received specimens as late as July, with the pupæ and exuviæ, from Surrey. Bouché says that the larvæ live sometimes in great multitudes in dung and vegetable earth;\* and it is very extraordinary, but two specimens in my collection were found the 25th of May in the stem of a dock, and apparently feeding upon it.

In the other genus *ATHÖUS*,† which is principally distinguished from *Agriotes* by the structure of the feet, there is only one species supposed to affect the crops, which has received, however, a variety of names in allusion to the rufous or rust-colour of the belly and tail, being called

4. *E. ruficaudis* by *Gyll.* (fig. 12); *E. sputator* by *Olivier*; *E. hæmorrhoidalis* by *Fabricius*; and *E. analis* by *Herbst*. It is long, narrow, piceous, and shining, clothed with ochreous and longish hairs: the antennæ are dusky, and similar in their relative proportions to *E. obscurus*, but they are a little longer and compressed; the basal joint is stout, second and third slender, the remainder obtrigonal, the apical one is narrower, the tip conical: the head and thorax are black, thickly and minutely punctured; the former is semi-orbicular: the clypeus truncated and reflexed; the latter is much longer than broad, a little narrowed towards the anterior angles, the posterior spines are short and trigonal, and the margin beneath projects considerably in a semicircle to receive the head: scutel black: clytra reddish brown, twice as long as the head and thorax, being rather broader than the latter, but linear, the apex ovate, and the tip of each rounded; they are minutely punctured, with nine striæ on each: the abdomen is ferruginous: legs short, ferruginous: feet appearing four-jointed until magnified; very pubescent beneath, the basal joint the longest, second and third decreasing in length, slender at the base, and somewhat trumpet-shaped, the apex being furnished with a membranous margin; the fourth is minute; the fifth long, slender, and terminated by two simple claws (fig. 27, d): length 6 lines, breadth  $1\frac{1}{2}$  line. Abundant from April to the end of June in corn-fields, on nettles, on commons, in pastures, &c. The beginning of June, 1842, I observed this beetle flying about hedges and banks in Dorsetshire, and I had previously found it in May by brushing the oak-leaves and underwood in the extensive woods in the neighbourhood of Wilton, near Salisbury.

There is probably scarcely any land where the Wireworms

\* *Naturgeschichte der Insekten*, p. 187; but from Bouché's figure of the tail, I suspect it is not the larva of *E. lineatus*, but of another species of *Elater*.

† *Curtis's Guide*, Gen. 309, No. 50.



might not be found, and but few crops that they will not attack : but some situations are more favourable to their increase than others, and there are particular vegetables to which they undoubtedly give a preference. This may, however, in some measure arise from the larvæ of the different species not having exactly the same tastes, and we have already shown that Wireworms, the offspring of three, if not four, distinct species of Elaters, attack the crops; yet some of them are so similar, except in size, that at present no tangible characters have been discovered to distinguish one from another; moreover all root-worms are called Wireworms by the farmer; but in this matter we hope to set him right, by giving descriptions and figures of the *false* Wireworms before we close the subject. At present they are accused of attacking wheat, rye, barley, oats, grass, turnips, rape, cabbages, potatoes, mangold-wurzel, carrots, onions, lettuces, hops, irises, carnations, pinks, dahlias, lobelias, and a variety of garden flowers; but in many instances the insects sent to me as the offenders were not the offspring of the Elaters, and consequently were not true Wireworms, but the larvæ of Crane-flies and other dipterous or two-winged flies, also the Juli or Millepedes, Centipedes, &c.

If it be correct, and there seems to be no reason to doubt the statement,\* that a Wireworm is feeding five years in the earth, it is evident from the variety of sizes one discovers of them at the same period and about the same turnip-root, for instance, that there must be a great difference in their ages, and possibly two kinds; and as they will not voluntarily leave the field in which they were hatched until they have arrived at their perfect state and become Elaters, it is impossible by any change of crops to remedy the evil, unless indeed one could discover some vegetable which they absolutely disliked; or by ploughing, harrowing, and keeping the soil perfectly free from weeds or plants of every kind, especially the grasses, they might be starved out. Whether they can fast for a long period is very doubtful I think, although Bierkander favours such an opinion, for it is principally in their perfect state that insects can live without food for an extraordinary space of time. Some importance, however, must be attached to the generally-received opinion that it is in all probability whilst the surface of the field is undisturbed that the eggs are deposited, consequently the crops that follow fallows, or pasture-land when broken up, are most likely to fall a sacrifice, and that for several succeeding years; and it is the same with a clover layer; whereas during turnips, potatoes, and similar crops, no eggs or very few are laid

---

\* Bierkander kept them living on roots of corn five years, and those which I have had feeding for ten or twelve months scarcely increased in size during the time.

in the field; but many of those which had been deposited from one to four years previously in the grass or layer are consecutively hatching, and the larvæ are gradually increasing in size and appetite, and consequently become daily more mischievous. If a corn-crop follow turnips, in a field infested by the Wireworms, it is astonishing if it escape being swept off entirely, for Bierkander says, "In the spring and autumn they have good appetites, and I have often observed that a single worm has bitten from eight, twelve, to twenty stalks in one place; and if one destroys so much, what may not thousands do?" For the same reason, it is almost useless to re-sow when a crop has been destroyed by the Wireworms, unless the soil be first freed from them by repeated ploughings, when rooks, starlings, poultry, game, and frosts may diminish their numbers; and the farmer must remember that the Wireworms *cannot* increase in number unless fresh eggs be laid by the Elaters, and of this there can be no danger from the end of September to the end of March.

We will now take a review of the crops, &c. which suffer from their attacks, as well as of the soils most affected by them; but it may, I think, be received as an axiom, that wherever grass will grow, the Wireworms may be found, for the roots of the various species afford sufficient nourishment for their support, and consequently pastures and meadow-lands are, I expect, never free from them; and thus it follows that newly broken-up lands so constantly swarm with this pest. I believe they are most to be dreaded in dry seasons, yet that they cannot be kept alive without moisture I am convinced by experience; and this is the reason that the worms are often found under stones in gravelly situations, exposed downs, dry heaths, &c.

*Oats* being sown upon land recently broken up are generally the crop which suffers the most severely. Dickson\* says: "When this sort of grain is cultivated on such leys as are newly broken-up, there may frequently be danger, especially where the land has been long in the state of grass, both from the destructive attacks of insects, and the soil becoming too light, open, and porous, from the decay of the grassy materials for the support of the plant." Such are their ravages, that sometimes it compels the discouraged farmer to lay down valuable land as pasture to a very great disadvantage; and in 1842, in many parts of England, the oat-crops suffered so severely from the ravages of the Wireworms, that it became necessary to plough them up and sow a second time.

When the season is dry and cold in the early spring months, the *Barley*-crops are frequently greatly injured by the attacks of the Wireworms, which is indicated by the young plants changing from

---

\* Practical Agriculture, vol. i. p. 582.

a healthy green to a sickly yellow; this was the case a few years since in Surrey during the month of May, when they were eating the young barley-plants just below the surface of the ground. I may also here mention that early in May, 1842, the Wireworms were injuring both barley and oats at Durnford, near Salisbury; the specimens forwarded to me by Mr. Hinxman varied greatly in size, as well as others which I not unfrequently found under stones on the downs in that neighbourhood, together with specimens of the "Small Brown," *Elatér obscurus* (fig. 25).

The *Wheat* is also greatly injured by their attacks, which are said to be continued during the entire winter; but this, I think, is doubtful; for during severe frosts they descend into the soil, like the larva of the cockchafer, retiring deeper and deeper as the cold increases. Early in the year, depending greatly upon the temperature, they make ample amends for their fast, if such be the case, by diminishing if not destroying this important crop. Mr. Hindman informed me that he found in the spring of 1840 Wireworms of three sizes in a field of wheat, in the county Down, near Belfast, which was eventually consumed by them, and was obliged to be ploughed up. Some young wheat-plants (fig. 28) were transmitted to me in April, 1841, by a friend in Surrey, and the following account accompanied them: "The dying off of the lower leaves indicates that the Wireworm is at work, and when he has gnawed through, the plant falls. The Wireworm not having eaten through in some instances, we re-planted the wheat-root, and have ascertained by a second digging up that it was shooting again below, and it is now growing after a second planting." In these plants the Wireworm had buried its head in the stem, nearly an inch below the surface, and about half an inch above the roots; in other instances they were detected in the same position, but very near to the base of the stalk (fig. 29), and quite an inch beneath the surface of the earth, which is shown by the dotted, horizontal line at fig. 28. On examination I found the tender stalk eaten through or nearly so, for I drew it out of the sheath without employing any force, and this part was decayed and of a clay-colour for the space of half an inch. In the same neighbourhood the Wireworms were found of various sizes in a wheat stubble, where under-draining was going on in October of the same year.

Having made every effort to obtain the eggs of the Elaters, in order to the ascertaining where they were deposited, I procured as many as I could of the beetles alive. Towards the end of May I put a considerable number of *E. lineatus* (fig. 26) into a garden-pot, in which some young wheat was thriving, and tied some gauze over to prevent their escape; this precaution did not, however, appear to be necessary, for they remained a very short time upon the surface of the mould before they buried themselves.

From the beetles thus seeking the roots of the wheat I was led to believe that they there deposited their eggs; consequently, on the 14th of June, I emptied the garden-pot, and found two Elaters dead at the roots of the wheat, but I could not detect either eggs or recently-hatched Wireworms. On the 17th of May, two specimens of *E. ruficaudis* (fig. 12) were found upon the wheat-leaves, also *E. sputator* (pl. J, fig. 34), and *E. marginatus* (fig. 36); on the 31st, one of *E. murinus* (fig. 32), four of *E. fulvipes* (fig. 33),\* one of *E. lineatus* (fig. 26), and one of *E. sputator*, as well as others in the hedge surrounding the field; and it is probable that if any one had searched the clover-fields, the oats, or the barley and clover fields, the Elaters would have been found in great numbers; for, as we have stated, wheat after clover-lays is more devoured by the Wireworms than after anything else, and they had worked both the barley and oats when young in that locality. June 2nd, received about twenty specimens of *E. lineatus*, found in the evening in a wheat-field in the same neighbourhood; but on June 16th the Elaters were no longer abundant there: they had paired; after which the males, I expect, died; and the females, I imagine, had entered the earth to lay their eggs: and I hope that some one more fortunate than myself will soon prove whether such is their economy.

At the same time I placed in another garden-pot, having wheat and a potato growing in it, some of the larvæ or Wireworms. On examining the plants on the 14th of June I found the base of the stalks perforated, the worms had descended 2 or 3 inches deep, where they had formed cells (fig. 10), as if they were inclined to change to pupæ, and the earth was full of their burrows. Having kept the pot in a saucer of water, they thrived well, but others not kept moist invariably died; if they had not been unseasonably disturbed I have no doubt they would have undergone their regular metamorphoses, for on the 26th of July some kept by a friend in a pot had cast their dark skins, and were become white pupæ like fig. 11. Having had opportunities of examining a very large number of Wireworms, I am able to state that some are nearly destitute of hairs, especially the smaller ones, which appear to me to be the most numerous. My opinion is that the smaller ones are very often the larvæ of *E. lineatus* and *E. obscurus*, and the larger ones of *E. ruficaudis*, and some may belong to the smaller species of Elaters which will be hereafter figured and described.

Potatoes suffer greatly in some counties from the Wireworm, whilst in others, where that animal equally abounds amongst the turnips, the potato-crops escape. This is a very remarkable fact, and resembles the curious anomalies in the black caterpillar,

\* These four insects will be figured in the next plate, which will appear in the succeeding Number.

which in some districts would not touch the Swedish turnips, and in others would feed upon nothing else;\* consequently we see it asserted by one writer, that the Wireworms will not eat the potato,† whilst others as confidently affirm that in many localities the annual produce has been reduced to less than one-third.‡ Owing to these counter-statements, when I was at Glanville's Wootton, near Sherborne, in Dorsetshire, in October, 1840, whilst the potato-digging was proceeding, I made strict inquiries concerning the Wireworms; and in a piece of common land, which had been broken up previous to forming a plantation, I found great quantities about the potatoes, and they infested all the potato-fields which had been lately common land, and newly-enclosed and broken up, notwithstanding the whole had been pared and the turf previously burnt.§ Some of the worms had eaten into the hearts of the potatoes; and at Shaftesbury I learned that the potato-crops had suffered considerably from this little animal. Mr. Hope also says: ||—"On observing several potato-plants just above the ground in a drooping sickly state (without an *Aphis* on them), I was induced to dig them up. In many instances I found the Wireworm at work, and adhering to the slices which had been planted; others apparently had been partially eaten, were abandoned, and in a forward state of corruption. Where the plants did *not come up*, which was the frequent occurrence in 1838, I am inclined to think the *slices* were entirely eaten, as not a vestige of them could be found." Mr. Hope attributes the disease, which is denominated the *Curl*, to the Wireworms; but that I think is very doubtful. He adds, that they first attack the potato when the slices are first committed to the earth; and secondly, when the haulm is considerably grown. Mr. T. A. Knight's plan of planting *whole potatoes* instead of slices would at once remedy the evil.

We learn also from Mr. Hope's remarks that the *Hops* in Kent, Worcestershire, and Herefordshire, have been repeatedly injured by the Wireworm.

*Cabbages* are frequently destroyed by the Wireworm. A gardener in Wiltshire says that in 1829 it was with the greatest difficulty he could bring any of the *Brassica* tribes to perfection; ¶

\* Royal Agric. Jour., vol. ii. pp. 376 and 377.

† Trans. Yorksh. Agric. Soc., p. 65.

‡ Remarks on Wireworms which seriously damaged the Potato-crops, &c., in Trans. Ent. Soc., vol. iii. p. 154.

§ The numbers of Wireworms which infested the land after this operation in all probability came from surrounding spots and boundary lines, which were still covered with turf, and had not been subjected to this process.

|| Remarks on Wireworms which seriously damaged the Potato-crops, &c., in Trans. Ent. Soc., vol. iii. p. 154.

¶ Gardeners' Magazine, vol. v. p. 610.

and this may be readily imagined, for I have found great numbers of the Wireworms in the clubbed roots of cabbages, especially in the autumn.

It is, however, the *Turnip* amongst the green crops which suffers the most severely I apprehend from the Wireworms; and it is very remarkable that this invaluable vegetable should have the greatest number of formidable insect enemies to encounter, as we have already shown in the five published Memoirs. I believe there is no period of the year, if the winter be not very frosty, when they may not be found at their roots. It is, however, to the young plants that they do the most serious injury. On visiting the turnip-fields at Rougham, in Suffolk, with Mr. E. Bennet, we found the plants looking sickly and the outer leaves yellow; on drawing them up a Wireworm was invariably detected round the root of each, which had been gnawed by it (fig. 30); Mr. Bennet also observed them engaged in the same way the beginning of August, 1840. The worms varied in size from a line and a half (being the smallest I ever saw) to four lines, and latterly to three-quarters of an inch, and in some instances two or three were attacking the same root. On the 9th of November in that year I found a Wireworm, as large as the one represented at fig. 2, at the root of a turnip in a garden, and others of the same size have frequently occurred since. In September of the same year the Wireworms were very abundant in Surrey, from six to eleven being found at a single turnip-root; the fact is, that as the plants are destroyed and deserted by them, they march off to the nearest, and thus meeting at one spot they daily become more formidable to the remaining crop. They ate off the root from half to an inch below the base of the leaves, and it was often gnawed higher up (fig. 30, e). With these Wireworms was a snail (*Helix*) then alive, but being left together in a box, the former attacked and ate up a portion of the latter, and six of them were found within the shell at one time: from this it seems that they are sometimes carnivorous. In the western counties the Wireworms appear to have been still more formidable, for Mr. Hope\* says:—"In the counties of Salop, Worcester, and Hereford, the failure of the crops of 1838 was very considerable, the real cause of it being little suspected or understood: I feel no hesitation in ascribing it almost entirely to the wonderful increase of Wireworms. In some instances I have, during the years 1836 and 1838, taken twenty and even thirty Wireworms feeding upon a single turnip-root."

Mr. Le Keux has not neglected to attend to the economy of the Wireworm, in his investigations of the insects affecting the turnips;† and from his observation it appears that the *foliage* as well

\* Trans. Ent. Soc., vol. iii. p. 155.

† Ibid., vol. ii. p. 32.

as the root is equally acceptable to them. He says, "the Wireworm begins on the edge of the leaf and eats it away like a caterpillar, and often cuts the leaf off at the top of the stalk, and it may sometimes be found on the ground half devoured. One Wireworm will consume about as much as five or six flies (*Altica nemorum*) could do in the same time." The following remarks by the same accurate observer throw so much new light upon the economy of this destructive animal, that I need not make any apology for laying them before the reader.\*—"The Wireworm," he states, "seldom feeds above-ground in the daytime, unless it be cloudy and dark; at such times I have observed them devouring the young turnip-plants before the rough leaf has been formed; but their most destructive operations are carried on beneath the surface of the earth, where they attack the root; in the very early state of the plant, after eating this through, the upper part of the plant is gradually drawn down into the earth and devoured, so that the plants disappear without any perceptible cause, and without any trace of them being left. In the more advanced state of the plant their devastation appears to be confined to eating through the root; and having thus killed one plant, they proceed to another. If a turnip-plant appears drooping (as if from the want of water), whilst those in its neighbourhood are fresh and erect, a Wireworm (sometimes half-a-dozen) will be sure to be found at the root, if the earth around it be carefully removed."

If noxious insects be dreaded by the farmer, the gardener has no less cause to apprehend their mischievous assaults; and from the great variety of these animals to which his culinary vegetables, as well as the fruits of the orchard, fall a sacrifice, they become in truth domestic plagues, which are brought to his own door. Amongst them are the Wireworms, especially those produced by the beetles called *Elatер obscurus* (fig. 25), and *E. sputator*—this last is abundant everywhere; and in the spring and summer the gardener often has the misfortune to see his newly-planted lettuces suddenly commence withering and dying: on pulling or digging up such plants a Wireworm is found at the roots, considerably like a mealworm, but more flattened, of a pale yellow, from 6 to 7 lines long, and about the size of a pigeon's quill.

We learn from Kollar † that the larva of *E. sputator*, Fab. ‡ undergoes its transformations in the ground, and remains only

\* Trans. Ent. Soc., vol. ii. p. 30.

† Naturg. der schaed. Insect., p. 149.

‡ It is impossible to say if he intend the Linnæan species; I think not, and am rather disposed to consider it the *E. ruficaudis*, but it is very doubtful.

fourteen days in the pupa state, when the beetle is produced. This dangerous enemy has been known to destroy one-fourth part of the crop by gradually eating the roots up to the crown of the plant where the leaves arise. Not only ought the earth to be immediately removed from the roots of the affected plants, the worms taken away, and the earth returned to its place, but, if necessary, the lettuces had better be dug up, and the worms which are concealed in the roots or in the surrounding mould can be destroyed: thus the rest of the crop may be saved; otherwise the worms will travel from dying to living plants until all the lettuces have fallen a prey to this annoying enemy. The beetle is particularly attached to the flowers of the *Umbellatæ*, and to nettles; it is therefore most important for the gardener not to neglect destroying the fools'-parsley, hemlock, and all similar wild-flowers, which harbour them and constantly spring up on the banks and hedges round his grounds.

As it is in the field so it is in the garden, "the Wireworm is particularly destructive for a few years in gardens recently converted from pasture ground. In the Botanic Garden at Hull thus circumstanced a great proportion of the annuals sown in 1813 were destroyed by it."\* At Bordean House, Hants, Captain Chawner's flower-borders have been frequently infested by the Wireworms, which ate into the base of the stems of the pansies and carnations, ascending them sometimes 2 inches above the ground. They revel also on the roots of the dahlias and lobelias. On the 5th of May I received two Wireworms of different sizes from a flower-garden in Surrey, and precisely the same as those from Hampshire; towards the end of the month four examples of the *E. ruficaudis* (fig. 12), and one of *E. fulvipes* (fig. 33, pl. J) were found on the side of the house there, most likely bred from the borders. About the same time three very small Wireworms were found in the flower-garden, and the beginning of August I received a pupa, I believe, of *E. ruficaudis*, with the exuvia of others and their earthen cases, from the same locality. Mr. Smith, in the 'Florist's Magazine' says—"The Wireworms invariably attack the pink and the carnation at the bottom of the stem near the root, and make holes through it in every direction, while the only indication of their presence is the entire destruction of the plant. The larva is in general found in the loam, therefore great care should be taken, in sweetening that soil, not to allow one to escape when it is turned over; and their colour being a light brown, makes the finding of them more difficult."

Wishing to render the history of the Wireworms as complete as my materials will allow, and being greatly attached to the garden, which may be considered a farm in miniature, I have made this

---

\* Kirby and Spence's Introd. to Ent., 6th edit., vol. i. p. 147.



slight digression, and will now return to our legitimate object. Having obtained some facts from practical men highly esteemed in the county of Suffolk for their agricultural knowledge, I shall now give the results of their experience.

Mr. Porter of Covehithe, where the lands are for the most part light, says that the Wireworms do most mischief in March, April, May, and June; that wheat suffers the most among the corn-crops, and white turnips amongst the green crops, but that rye is sometimes swept off by acres; and with regard to barley, he has observed that when it is drilled-in 3 inches deep, the plant droops and turns yellow, as if attacked by the Wireworm, whereas at  $1\frac{1}{2}$  inch deep it makes a vigorous plant. I may observe with respect to this difference of result from the depth of sowing, that it is possible the Wireworm may not be able to exist near the surface in a light sandy soil, and consequently the barley escapes when drilled-in at the lesser depth. Turnips and beet-root he finds most affected at the end of June and the beginning of August, yet 12 acres of the latter, which produced a fine plant, were completely taken off by the Wireworm the last week in May; swedes were afterwards sown the second week in June, and to his surprise produced a fine crop. The success of the swedes must be attributed, I think, to the greater part of the Wireworms having arrived at maturity when they had destroyed the beet, in which case they would change to pupæ, and afterwards to beetles, in both which states they are harmless. Turnips do best at Covehithe if sown about the 21st June on the light lands, and a week earlier on heavy lands. On the lower part of fields bordering on marshes, where the land is springy and friable, barley, turnips, and beet have generally fallen a sacrifice, and such land is most subject to their attacks. When white-clover or suckling and ryegrass layers have been left for seed, it is scarcely possible to get a wheat-crop on account of the Wireworm; the only chance is to break up the land and work it well about for a couple of months in the autumn. Potatoes never suffer on Mr. Porter's farm from the Wireworm.

Mr. Robinson, of Henstead, informs me that in his neighbourhood the gravelly and sandy soils are most infested, and the strong loam and clay most free from the Wireworms. That they inhabit every aspect was proved by their ravages over all parts of a field which was lowest in the centre. A dry season is most conducive to their increase, yet if the following year be wet it does not kill the Wireworms, but it probably destroys the Elaters, and prevents the deposition of the eggs. Early in March, 1841, when his wheat was well out of the ground, and about  $1\frac{1}{2}$  inch high, it began to die off, and on pulling some up he found the Wireworm had caten into the stalk and consumed the inside.

This was upon dry gravelly hills which had been a clover layer, and the valleys and better parts of the field did not suffer, but barley on strong land in the same parish drilled in the spring did not produce above one-third of a crop owing to the attacks of the Wireworms. Some low wet common land was broken up, *pared and burnt* (which with the draining cost 10*l.* per acre); it first produced a good crop of turnips, and afterwards a prodigious crop of oats; but another portion under a different owner was *pared but not burnt*, and the crop was lost.

Mr. Bates says that the following is the order in which the crops probably are affected in degree in his part of Suffolk, viz. wheat, turnips, barley, oats, and beet, and that they are generally least injured on good soils. If wheat be sown in dry weather it has proved favourable to the inroads of the Wireworm. Oat stubble ploughed several weeks previously, and sown with wheat the third week in November, suffered from their attacks. Barley and oats were injured in May, in a cold wet season. Turnips have been swept off after being up a fortnight, but generally they fall a sacrifice when three or four weeks old, having at that time four or six leaves; yet he finds the eating through of the tap-root after the second hoeing does little mischief to the turnip-plant. That all lands exposed to the sun by being fed off short, as clover layers, are greatly infested with the Wireworms, but that no potato-crop is destroyed by them.

From these statements it is evident that in some parts of Suffolk the potato-crops escape the attacks of the Wireworm, although that animal is abundant in the soil. It seems to be the same in Yorkshire, for Mr. Milburn\* was so convinced of the potato being exempted from the ravages of the Wireworms, that he even recommended it as a good crop to plant in order to starve them out and clear the land of that pest: he says, "Nobody ever heard of a potato-crop being injured by them;" and, alluding to Sir Joseph Banks's mode of ridding gardens of Wireworms by sticking slices of potato in the ground, he adds, "It is really surprising how a person so truly above all visionary theory should be led to recommend such useless plans."† We must, however, be very careful in drawing positive conclusions, for there is unquestionable evidence of the potato-crops suffering severely from the depredations of the Wireworm in Dorsetshire, Wiltshire, and the western counties. The valuable memoranda I have just given from the experience of practical men will, it is to be hoped, induce others cultivating land of a different nature to attend to this subject, and communicate their observations to the Society or to myself, for it is for want of correct and an extensive variety of data that we are at a

\* Of Thorpfield, near Thirsk.

† Journ. Yorksh. Agric. Soc., p. 65.

loss to account for many anomalies in the economy of insects ; indeed it is impossible to draw correct conclusions from isolated facts.

Difficult as the Wireworm is to deal with, so much attention has been paid to the subject by the suffering farmer and gardener, that numerous methods of arresting its ravages have been tried, some of them with great success ; and let not any one be discouraged because he cannot clear his land entirely, or at one blow sweep away a nuisance, for extermination amongst these minor works of the creation is not permitted, it is against the laws of the Creator ; for although such intervals of absence may occur as to lead us to think that a noxious animal is annihilated, it will in due time return, and again require all our efforts and vigilance to contend against it. We are sometimes deceived by appearances, and it is true that by persecuting the higher order of animals they may be driven from a favourite spot or locality, and take shelter so far from the haunts of man as to relieve him from their inroads, and dispose him to imagine that the species is lost ; and in some instances we know that a country has been freed from races of animals, as the wolf and eagle, but they are not exterminated ; and the latter, under favourable circumstances, would return : I think it therefore probable that by perseverance insects may be driven from a locality, for persecution is not agreeable to any animated being ; and this knowledge ought to encourage the cultivator not to relax in his efforts to free his land from destructive insects, but to be certain that those efforts are well directed.

Great benefits may be derived by selection of crops, by modes of cultivation, by manures and dressings, but, above all, by manual labour. Animals also whose economy tends to diminish destructive insects ought to be encouraged, and no doubt we are benefited, to an extent which it is impossible to conceive, by the parasitic insects whose instincts lead them to prey upon the eggs and caterpillars of our enemies : they are, as we have shown in former memoirs, multiplied to an almost incredible extent, and labour incessantly in their vocation. These are discoveries which have been gradually developed by the industry, perseverance, and research of the naturalist, for the improvement, amusement, and benefit of his fellow-creatures ; and I concur entirely with Mr. Hope that "Agriculture may derive valuable assistance from the science of Entomology ; and I feel fully convinced that we can scarcely do a greater act of kindness, or be of more service to the farmer, than by pointing out the nature and habits of those insects which destroy his crops." \*

We will now return to the opinions of practical men regarding the best modes of culture for keeping in check the Wireworm ;

---

\* Trans. Ent. Soc., vol. iii. p. 156.

a great deal, however, must depend upon the soil and situation, which will often explain the reason of an experiment succeeding in one place and failing in another. Mr. Salisbury gives some good advice concerning the Wireworm.\* “It is an insect,” he says, “much complained of by farmers whenever they turn up land that has been cultivated with clover or grass, and it in general does great injury to the corn-crop which succeeds. It should be noticed that clover, or other plants of such description, give protection to this insect; it is bred in the roots of these plants, and the land is so well stocked with it that it attacks the corn and other succeeding crops very much to their injury. Land of this description is therefore unfit for corn immediately on breaking up. Turnips or potatoes are not so liable to injury from this insect; but the best preventive is probably a summer fallow, and burning the rubbish on the land before cropping, by which means the eggs which are laid in the stalks are destroyed,† and the live worms die for want of nourishment; soot and lime will also kill this destructive worm. Before breaking up old lays it should always be a point with the farmer to examine the then existing crop, and observe if any of these insects are in the roots and stalks, and if so, to apply the above as a preventive previous to sowing a crop of grain in the land. Nothing but the preventing such a pest as this insect will justify the fallowing of land according to our improved system of agriculture; in this case, however, it is indispensable. May not this insect, which is now (1816) more prevalent among our crops of grain than ever, owe its prevalence to the system of fallowing and burning the refuse of such crops being nearly exploded?” Fallows must, however, be kept very clean, for if couch and other grasses be allowed to exist in the land, the Wireworms will find the roots very acceptable, and sufficient to maintain them until the corn-crop appears; nothing can therefore be worse than to leave strips or spaces of grass or stubble in a ploughed field.

All waste and wood lands are harbours for the Wireworms, and therefore when they are brought into cultivation the change is so congenial to their habits that they seem to increase at a prodigious rate, and consequently the second crop is frequently carried off by them. If land be planted or sown two years in succession with the same crop, it is sure to be well stocked with them, at least so it is with the potato. When old pastures are broken up for a crop of corn, I have heard that a breast-plough should be used to take off not more than 2 inches of the turf in the first instance, which will secure the crop from the attacks of the Wireworm. whereas even the addition of only 2 inches more in the depth

---

\* Hints to Proprietors of Orchards, p. 109.

† No authority is given for this statement.

has so encouraged that pest that it has been known to destroy an entire field of wheat. This difference probably arises from the effects on the roots of the grass; if the top of the turf only be pared off, the roots will die, whereas by going 4 inches deep they lie and vegetate, so that when it is afterwards all ploughed-in the worms find the requisite pabulum, until the corn is forward enough to afford the Wireworms a more agreeable substitute. Dickson says that the destructive attacks of insects on lays newly broken up "may in some measure be obviated by eating such lands very closely with sheep previous to their being broken up, as by such a method the ova of such insects may be much destroyed and their propagation prevented; and the treading the crop by sheep as well as the roller may likewise be beneficial; horses have also been turned in for the same purpose by some cultivators."\* It is supposed by many that folding oxen and sheep upon infested fields will check the Wireworm by stopping their burrowing; but it seems more likely to arise from the beetles not being able to get out of the earth from their pupæ cases, and those which do effect their escape, finding no appropriate place for the deposition of their eggs, depart for a more suitable locality; this operation might therefore be most advantageously adopted early in the spring before the beetles hatch.

Mr. Bates assured me that he preserved his turnips by harrowing and hard-rolling the land in March and April, and that it was of no use later in the season. In another place, alluding to barley, Mr. Dickson also says † that if the plants suddenly change from a healthy green to a yellow cast "the use of the roller should be had recourse to, in order that the superficial parts of the soil, which are probably become too loose and porous, may be effectually pressed, and thereby rendered too close and compact to admit the worm to prey upon the tender roots of the young plants. That this effect may be produced in the most effectual manner, the roller should be of such a size, or so loaded as to afford a pressure equal to the draught of three or four horses, which should be yoked double, in order to increase the effect by their treading. It has been suggested that if by this method the injury can be counteracted until such time as rain falls, there need not be any apprehension for the crop, as the plants will soon push forward in such a manner as to become too strong to be in danger from this insect." ‡ Top-dressings of lime before using the roller would be useful. All this is very reasonable, for by excessive pressure the Wireworms are compelled, at least for a time, to descend into the earth; and it must be beneficial in its subsequent effects, for numbers of eggs may thus be destroyed, and if

\* Practical Agriculture, vol. i. p. 582.

† Ibid., vol. i. p. 576.

‡ Dickson's Synopsis of Husbandry, p. 91.

rain fall it will so cement the earth together that the beetles when hatched will die in their tombs.

There are some *Crops* which appear to be extremely useful in keeping the Wireworms under, and amongst them is *Woad*. I learn from Dr. Roy, that, on breaking up damp meadow and pasture land in Lincolnshire, if it be sown with woad instead of corn, the Wireworm will be got rid of; and about Boston it is found to be a very profitable crop. It may be repeated for two years, after which splendid crops of oats and potatoes may be obtained from the land. It may not be irrelevant to remark here that it is a prevailing opinion respecting the Bedford Level, that *over-draining* has caused great mischief to the wheat crops by increasing the Wireworms.

*White mustard-seed* sown on land will secure the succeeding crop of wheat or other corn against this insect; and Mr. Tallent's\* account of his success being satisfactory, I shall transcribe it:—

“White mustard-seed will protect the grain from the Wireworm, and this fact I have demonstrated perfectly to my own conviction. I first tried the experiment on half an acre, in the centre of a 50-acre field of fallow, which was much subject to the Wireworm. The mustard-seed being carried, the whole field was fallowed for wheat, and the half-acre that had been previously cropped with mustard-seed was wholly exempt from the Wireworm: the remainder of the field was much injured. Not only was the half-acre thus preserved, but in the spring it was decidedly the most advanced part of the crop; and the prosperous appearance which it presented caused me to repeat the experiment, by sowing 3 acres more of mustard-seed in the worst part of a field of 45 acres, also much infested with the Wireworm. The remainder of the field was sown with early frame peas, which, with the mustard-seed, were cleared in the same week. The land was then ploughed for wheat; and I had the pleasure of noticing these 3 acres to be quite free from the worm, and much superior in other respects to the other part of the field, which suffered greatly. Thus encouraged by these results, I sowed the next year a whole field of 42 acres, which had never repaid me for nineteen years, in consequence of nearly every crop being destroyed by the Wireworm; and I am warranted in stating that not a single Wireworm could be found the following year, and the crop of wheat throughout which was reaped last harvest was superior to any I had grown for twenty-one years. I am therefore under a strong persuasion that the Wireworm may be successfully repelled and eradicated by carefully destroying all weeds and roots, and drilling white mustard-seed, and keeping the ground clean by hoeing.” †

Mr. Loudon is of opinion “that the Wireworm cannot eat the roots of the mustard, most probably from their acridity, and there

---

\* Of Little Houghton.

† Read before a meeting of the Northamptonshire Farming Society, and inserted in the ‘Country Times,’ Sept. 1831.

being no other roots in the soil for them to live on; and no weeds or other plants than mustard being permitted to grow during the season, the insects necessarily die of famine.”\*

*Mowing oats*, and of course other corn, is considered the best method of getting rid of the Wireworm by Kollar, and other continental writers; but they assign no reason, and it is difficult to explain the cause. It may be, that when corn is reaped, the stubble being left long, rooks and many other birds will not resort to such fields, and consequently the Wireworms revel without molestation. This is worth the consideration of the farmer; and whatever may be the cause, if the statement be true, it ought not to be neglected. Long stubble certainly harbours many injurious insects, and amongst them, it is believed, the turnip-beetle, which resorts to the long hollow straws for shelter during the winter.†

I will now give the experiments made by Bierkander; and although their application to the crops may not be so beneficial as one could desire, yet they may be useful in directing the cultivator in the pursuit of this subject. “I have,” says this learned Swede, “made many experiments to discover by what means the Wireworms may be destroyed. Many were put at one time into tea-cups filled with the following vegetables, viz. :—

	Days.	Hours.
“Garlic . . . . amongst which they lived	9	0
The leaves of the spruce fir . . ditto . . . .	0	14
The leaves of the fir . . . . ditto . . . .	0	10
<i>Ledum palustre</i> (an Irish plant) ditto . . . .	0	9
<i>Myrica gale</i> , sweet gale, or Dutch } ditto . . . .	0	2
myrtle . . . . . }		
In water they lived . . . . .	4	0

“In consequence of this it ought to be tried how useful it might be, in winter and summer, to mix in the heaps of manure fir-leaves, *Ledum palustre*, and *Myrica gale*, of which vegetables the dung would smell, which might probably be disagreeable to the vermin; and if they did not die in consequence of it, they might perhaps quit the fields.”‡

It thus appears evident that any endeavour to destroy the Wireworms by drowning them is almost impracticable; for they not only exhibited signs of life in water for four days, but I think it probable that if a field were laid under water for a much longer period, it would not destroy them. This, however, might be easily tried in some situations; and to ascertain the truth is worth the trouble.

\* Gardeners' Magazine, vol. vii. p. 675.

† Royal Agric. Journ., vol. ii. p. 204.

‡ Trans. Acad. Scien. in Sweden, vol. for 1779, p. 286, and Commun. to Board of Agric., vol. iv. p. 414.

Lord Albemarle recommends that when fields intended for wheat are attacked by the Wireworms, rape-cake should be used as a manure, to be powdered, and sown across the field. If it do not destroy the insects, it at least saves the crop from their attacks.

Many other applications have been recommended, and amongst them spirits of tar and chloride of lime. One correspondent in the 'Gardeners' Chronicle'\* says, "Spirits of tar is the most effectual remedy with which we are acquainted for destroying the Wireworm. We should therefore recommend any one to saturate some sand with that compound, and mix it with the soil in the beds of ranunculus and anemone when they are turned up in autumn." J. W. C., † having lost his crops from Wireworms, also says, "Thinking that spirits of tar might do good, when I sowed dwarf French beans again, before covering-in the rows, I watered them with a strong solution of it; and the result was that they came up very strong and healthy, and the produce was enormous, whilst the first crop gradually dwindled away, and died a premature death." "The refuse lime of gas-works is stated to be efficacious in banishing these pests from the garden. Previously to the crop being planted, a thin covering of the lime should be spread over the ground, and it must be well mixed up with the soil in digging." ‡ F. H. B. "had been using some chloride-of-lime water, and poured it over some grass, when it immediately killed the worms. From this success he was induced to try it on some very sickly carnations infested with Wireworms, and had the satisfaction to find them recover rapidly. The proportion used was about a table-spoonful to a pint of water, but that of course must depend on the quality of the soil." § It seems necessary to employ it with caution, in the flower-garden at least; for in the same journal it is asserted, "We have great doubts whether chloride of lime, although considerably diluted, would not be injurious to picotees, and commit as much havoc amongst them as the Wireworm. We recommend you to spread some of the refuse lime from the gas-works over the surface of the bed, the effluvia of which will probably drive them away." ||

In the Journal of this Society Mr. Burgess ¶ says, "This year I applied the *nitrate of soda* to my wheat, when, from the wet season and the Wireworm, the plant was nearly destroyed, and I found it particularly beneficial, the Wireworm either being killed by the application or forsaking the roots; and consequently I think I have above an average crop of wheat." The ammonia

\* Vol. iii. p. 233.

† Ibid. p. 737.

‡ Gardeners' Chronicle, vol. ii. p. 777.

§ Ibid., vol. iii. p. 318.

|| Ibid., vol. ii. p. 777.

¶ Elmhurst, Bucks. Vide Royal Agric. Journ., vol. ii. p. 132.



which invigorated the plants at the same time destroyed the insects; and it is added that the turnips grew so fast that they soon got out of the way of the fly (*Altica nemorum*).

It is also positively affirmed that if *lime and soot* be applied to the soil before sowing any grain, it will kill the Wireworms. *Salt* likewise, on light sandy soils, is highly efficacious in destroying them; and of its effects upon these animals it is in the power of every one to convince himself, and also of the strength required for their destruction, by dissolving a tea-spoonful or more of salt in a tea-cupful of water, with some Wireworms in another, half full of pure water, when, by adding the salt water by degrees, the exact effect produced upon the life of the animals will be ascertained; and the same of course may be done with spirits of tar, &c. In alcohol the Wireworms expire in five minutes, but spirits of turpentine destroys the vital principle almost instantaneously. It is, however, difficult to kill them by a change of temperature, and yet in an artificial state it is extremely difficult to rear them.

As the Wireworms will live upon potatoes—as I can testify by having fed them on nothing else for many weeks together—there cannot be a better bait to catch them in the flower borders than slices of that tuber, as recommended by Sir Joseph Banks, which has been fairly tried by a friend in Hants, who tells me it is the only method by which he can save his carnations and other flowers. I have now before me communications from several contributors to the ‘Gardeners’ Chronicle,’ all concurring in recommending slices of potato, &c., as the best mode of freeing the garden at least from this troublesome visitor. One of these I will transcribe: “I send you an account of destroying the Wireworm, which I have adopted for some years, my ground being full of them, so that I could neither grow sweet-williams, picotees, bulbs, lettuces, nor indeed any succulent plant, without their boring, running up, and eating the hearts out. Near these plants I now place half a potato, with the eyes cut out to prevent its growing, and run a pointed stick through the middle of it, and peg it into the ground, covering it over with about an inch of mould; and in a day or two I have pulled out by the tail from 15 to 20 of them from one piece of potatoe.”\* Slices of turnip, brocoli, cabbage, beet-root, parsnip, carrot, apples, and young lettuce-plants, will answer the purpose where potatoes are scarce or not to be obtained; and it is very probable, if such vegetables were scattered over infested corn-fields, that considerable numbers of the Wireworm would be decoyed to them, and might be collected and destroyed; for it is even recommended by some persons to lay the slices of potato on the surface, although there

\* Adan, in Gard. Chron., vol. iii. p. 301.

are others who consider that they may be buried 2 or 3 inches deep; but these variations in the mode of application arise, in all probability, from differences in the soil.

Excellent as many of the foregoing remedies may be, I must confess I think highly of *hand-picking*; its effects are certain, it is comparatively not expensive, especially when it is borne in mind that it gives employment to the children of the labourer; and where the Wireworms swarm it must be successful, as will soon be demonstrated. What must have been their amount in a field shown to Mr. Spence, "in which," he says, "they had destroyed one-fourth of the crop; and the gentleman who showed them to me calculated that his loss by them would be 100*l.* One year he sowed a field thrice with turnips, which were twice wholly, and the third time in great part, cut off by this insect."\* Bierkander, after all his experiments, appears to have depended most upon hand-picking; for, he says, "in a field where rye was intended to be sown, I last autumn (1778) employed a child to follow the plough and pick up the worms; by this means 351 were collected in a piece of land 600 feet long and 56 broad. The quantity which was taken in other fields was not counted. There were caught in the furrows, according to their length, 4, 6, 10, to 14 worms. It would be serviceable if children always followed the plough and gathered these yellow worms into a bottle; they would by that means be considerably diminished, and perhaps in time entirely exterminated."† The following fact shows the advantages of this system, and requires no comment. "A striking instance," says Mr. Spence, "of the use of hand-picking (in most cases by far the most effective mode of getting rid of insects) appeared in the '*West Briton*,' a provincial paper, in November, 1838, stating that Mr. G. Pearce, of Pennare Goran, had saved an acre and a half of turnips, sown to replace wheat destroyed by the Wireworm and attacked by hosts of these larvæ, by setting boys to collect them; who, at the rate of 1½*d.* per 100, gathered 18,000; as many as 50 having been taken from one turnip. Thus, at the expense of only 1*l.* 2*s.* 6*d.*, an acre and a half of turnips, worth from 5*l.* to 7*l.*, or more, was saved; while, as the boys could each collect 600 per day, 30 days' employment was given to them at 9*d.* per day, which they would not otherwise have had."‡

As *birds* and *animals* are the farmer's best friends, I shall always advocate their cause, and to establish their claims I shall quote various good authorities who have borne testimony to their utility, in addition to those which have been already given.

\* Kirby and Spence's Int. to Ent., 6th edit., vol. i. p. 154.

† Commun. to Board of Agric., vol. iv. p. 414.

‡ Kirby and Spence's Int. to Ent., vol. i. p. 154.

Amongst the birds that which stands first and foremost in the ranks is the Rook; wary as he is on most occasions, he follows the plough fearlessly, to feed upon the Wireworms and other insects; and here his services are most invaluable, for if you dig up the Wireworms and lay them upon the earth, they will often burrow down and disappear in a few seconds; many, therefore, of the feathered race have little chance of catching them in the ploughed field, but the form of the bill, combined with the strength and assiduity of the rook, is well adapted for detecting them in their hiding-places. To pick them from the growing crops is likewise the occupation of the rook when we see him gravely surveying a turnip or corn crop, and with astonishing sagacity selecting those plants only which have a few yellow leaves outside, the sure indication of the presence of the Wireworm and other insects. A gentleman in Norfolk, who well understands this subject, says, "the rooks convey the first tidings of the presence of this formidable enemy by hovering over a field in flocks, and actually pulling up the turnips by the roots to search for them, and I cannot but believe that their sagacity directs them to the infested plants, which are distinguished by their drooping leaves and dark unhealthy aspect."\* An equally observant friend, in Surrey, says, "the rooks are accused of doing injury by pulling up the wheat, but I, as well as others here, believe that they pull up the attacked plants to get the Wireworms, and do not touch the healthy plants." The bailiff to the same party informed me, during a period when the Wireworms were abundant, that the rooks had been busily occupied amongst the barley in May, and where it looked sickly had drawn the earth away from the roots to find the Wireworms, and where they had been "working the earth" he could not find any of the worms.

But there is still stronger and incontrovertible evidence in their favour, for in the stomachs of rooks which have been shot when following the plough in barley-sowing, a few grains of corn only were found, but abundance of Wireworms and other insects. Mr. J. Denson, sen., says, "I have repeatedly examined the crops of rooks: in six young that had been shot the crops were nearly filled with *Wireworms*; in the crops of others I have found the larvæ of the cockchafer, and other grubs that I am not entomologist enough to know the names of. In one or two instances, in frosty weather, I have examined the crop of one or more rooks that had been shot: it contained dung, earth, and a small portion of grain. I will just notice that the land adjoining Mr. Wiles's rookery is yearly sown with pulse or grain, and in no instance have I known or heard that the land has in consequence failed of

\* T. S. N., in Preface to an 'Abstract from Marshall's Rural Economy of Norfolk,' p. x.

a crop."\* The following remarks also, by Mr. T. G. Clithero, are exceedingly interesting. "In the neighbourhood of my native place, in the county of York, is a rookery, belonging to W. Vavasour, Esq., of Weston, in Wharfedale, in which it is estimated that there are 10,000 rooks; that 1 lb. of food a-week is a very moderate allowance for each bird, and that nine-tenths of their food consist of worms, insects, and their larvæ; for although they do considerable damage to the fields for a few weeks in seed-time and a few weeks in harvest, particularly in backward seasons, yet a very large proportion of their food, even at these seasons, consists of insects and worms, which (if we except a few acorns and walnuts in autumn) compose at all other times the whole of their subsistence. Here then, if my data be correct, there is the enormous quantity of 468,000 lbs., or 209 tons, of worms, insects, and their larvæ, destroyed by the rooks of a single rookery in one year. To every one who knows how very destructive to vegetation are the larvæ of the tribes of insects, as well as worms, fed upon by rooks, some slight idea may be formed of the devastation which rooks are the means of preventing." † Wagtails and robins are also very fond of the Wireworm, and probably sparrows; blackbirds and thrushes are constantly hunting the grass for them and other larvæ and pupæ.

Pheasants and partridges are likewise exceedingly beneficial in this respect, and in some measure compensate the farmer for the loss of the rook, crow, &c.: when we find the game in the turnip-fields they are usefully employed in picking out the Wireworms, and the crops of the pheasant are frequently found full of them. I was not aware that the plover or lapwing, called also "pewit," lived very much upon Wireworms, until a friend in Norfolk informed me of the fact. In the marshy districts of our eastern counties this bird was formerly exceedingly abundant, as well as the ruff and ree, but the gun and the nest-hunter have so thinned their numbers that the lapwing is becoming scarce, and the latter have almost abandoned our shores, and, as might be expected, the Wireworms seem to be increasing rapidly in such localities. On opening the lapwings that have been shot, their crops were found full of Wireworms, and as it is supposed that one bird would eat a hundred in a day, the flocks of forty, fifty, and upwards that were constantly to be seen some years since would clear off a very large number in a season. Their assistance, however, is departed and gone for ever, for the high price which the eggs fetch in the market cause the peasantry to look so carefully after the nests that the only chance the lapwing has of escaping destruction is to seek the wildest districts of Scotland and Ireland, where their eggs not being so essential a luxury as they are con-

\* Gard. Mag., vol. ix. p. 718.

† Mag. Nat. Hist., vol. vi. p. 142.

sidered in England, they may escape the persecution they have so long endured. Whether the destruction of late years of whole fields of corn at Oxborough, near Stoke in Norfolk, is attributable to the absence of these birds I cannot say, but it is certain that formerly the plover abounded in that neighbourhood and now scarcely a pair can be seen.

Before leaving the birds, it may be worth reminding the farmer, that in Norfolk much benefit is derived from turning ducks into fields at the time of ploughing, when they pick up the Wireworms, the larvæ of the cockchafer, &c., and whatever slugs there may be; and with regard to the Wireworm we think that turkeys and barn-door fowls would prove equally, if not more, serviceable.

There is not the least doubt that in many districts great mischief has arisen from the eternal warfare carried on against the Mole, as if it had been created expressly and entirely to do mischief, but hear Mr. Le Keux's praises of this persecuted little animal in Devonshire:—"I think it probable that the mole may prove the best protection against the ravages of this insect; because I observed that seven years ago moles were very numerous all over the farm, and at that time the Wireworm was never found to be injurious to any of the crops, but a war of extermination has ever since been most sedulously carried on against the mole, and with such success that it has become a rare thing to meet with upon the farm. The Wireworm on the contrary is now (1830) so abundant as to cause very serious and perceptible injury by laying bare large patches in the different crops."\*

Frogs, toads, and lizards feed upon insects, but whether they reduce the broods of the Wireworm I am not able to determine. It has, however, enemies in the insect tribes which probably aid very materially in keeping this destructive animal in check.

In the early part of August a friend sent me a pupa, with the exuvia, earthen cases, and some Wireworms; in one of these which seemed to be full-grown I found two or three white maggots, and another had changed into a nympa or chrysalis, from which I could see that it was an hymenopterous insect, which of all the orders contains the greatest number of species that are employed by the Creator to attack noxious and other insects. Concealed therefore as the Wireworms are in the earth, and armed with a coat of mail which will withstand most external assaults, this little ichneumon fly † discovers their retreats, and puncturing the sutures of the skin in all probability which are

\* Trans. Ent. Soc., vol. ii. p. 31.

† It is probably a *Microgaster*, of which genus we have already shown several that are parasitic on caterpillars: vide Royal Agric. Journ. vol. iii. plate E, fig. 10.

more membranous, deposits her eggs in the body of the worm, to feed upon the muscles and thus destroy this enemy to the cultivator. This discovery I supposed to be perfectly novel as regarded the Wireworm, but on turning to Bierkander I find the following statement:—"Nature has, however, furnished allies against this army of vermin, as an Ichneumon, by means of its aculeus, or egg tube, if I may so call it, insinuates its eggs into many of them, so that in thirty worms which I have taken, I have found six that have been thus quartered upon. From one of these worms, with the loss of life of the host, six, ten, thirteen, to twenty guests have come out. Which Ichneumon this is I have not yet discovered, as the pupæ put into jars have all died."\* Mine also unfortunately all died, although I paid the greatest attention to them; and hoping to gain some further information upon the subject, I shall defer giving figures of this parasite until my next Memoir is published.

The same author† also says:—"The 14th of June a Wireworm drew from its mouth a thread 8 inches in length." This must have been a *Filaria*, of which I find in the 'Gardeners' Chronicle'‡ the following notice:—"W. W. The thread-like substance 5 inches long, which you extracted from the body of a Wireworm, is an intestinal worm, belonging to the genus *Filaria*. Similar worms have been observed in various insects, but still your fact is a very interesting one, showing that the filariæ are found in the larvæ of insects."§ (S)

I believe I may here close the history of the true Wireworms. I trust that the descriptions and figures will enable the inquiring cultivator to study their economy satisfactorily, and likewise that the mass of information relating to the destruction of them may enable both the farmer and the gardener to encounter more successfully this great enemy to their crops and industry.

I shall be ready to return to this subject in the spring, when it will be necessary to give the history of the animals which are so often confounded with the true Wireworms, and in the meanwhile I shall be extremely obliged by any information which the members of the Society or others engaged in agriculture may be able to communicate.

#### Summary of the foregoing Report.

*Wireworms* feed upon corn, turnips, mangold-wurzel, potatoes, grass, cabbages, and garden-flowers.

\* Commun. to Board of Agric., vol. iv. p. 414.

† Ibid, p. 415.

‡ Vol. iii. p. 433.

§ I have seen several of these worms issuing from the tails of beetles, principally Carabidæ, when thrown into alcohol to be preserved: they were brown and as thick as very stout cotton.

Every *Root-worm* has been designated the *Wireworm* by agriculturists.

*Great errors* circulated in print by persons ignorant of the science of Entomology.

*Seventy species of Beetles* inhabiting England, which are the parents of *Wireworms*.

These *Elaters-beetles* are called *Spring-beetles*, *Skip-jacks*, and *Snap or Click beetles*, from the power they have of leaping up when placed on their backs, and the noise they make on such occasions.

*Eggs* minute, and whether laid in the earth, or in the base of the young wheat-stalks, not determined.

*Wireworms* almost *invisible* when first hatched: but some, when full-grown, nearly *an inch long*.

They live *five years* in the larva or feeding state.

They *cast their skins* several times, after which they are white, and very tender for a short time.

They resemble the *mealworm*, but are smaller, not so cylindrical, and very different when minutely examined.

They have *small mouths*, with strong jaws, six pectoral feet, and an anal foot.

When full-grown the *Wireworm* forms a *cell in the earth*, in which it moults and becomes a pupa or chrysalis, generally in July or August.

This *pupa* is stationary, quiescent, and harmless.

It *changes* again to an *Elater* or beetle in *two or three weeks*; at first it is white and tender, but in a short time it gains its proper colour and hardness.

The *beetles* run with their heads down, and drop when approached: they also *fly well*, and are *perfectly harmless*, feeding only on flowers.

The females sometimes have the *ovipositor* or egg-tube exerted.

The *mouth of the Elater* differs considerably from that of the *Wireworm*, but consists of the same organs more perfected.

*Four species* of *Elaters* most common in *corn-fields*, which have been reared from the *Wireworms*.

*Elater sputator* the smallest of these, and variable in colour: found in the spring.

*Elater obscurus* rather larger, and appears also in the spring.

*Elater lineatus* supposed by some to be a variety of the foregoing species. It is now by far the most abundant, and is found in spring and summer.

*Elater ruficaudis*, the largest of the four, and abundant in the spring on nettles.

*Scarcely any land free* from the *Wireworm*, and but few crops which they will not attack.

*Larvæ of crane-flies*, the millipedes and centipedes, all called Wireworms by farmers.

*Wireworms* are of various sizes and ages at the same time in a field.

It is doubtful if they can *fast long*.

*Eggs* probably deposited in pastures, clover-layers, and fallows, whilst the surface is undisturbed.

*Not deposited* in turnip and potato fields probably.

*One Wireworm* will bite twenty different stalks.

*Very hazardous to re-sow* where they have destroyed a crop, unless the soil be ploughed repeatedly.

*Wireworms cannot propagate* or increase their numbers, and the *Elaters* do not lay eggs during the six winter months.

*Wherever grass will grow* the Wireworms may be found.

They are most to be dreaded in *dry seasons*, yet they cannot exist without some moisture.

*Oats* suffer most severely on fresh broken-up land: often ploughed up and re-sown.

Valuable land laid down in *pasture* to avoid their depredations.

*Barley-crops* generally injured in dry and cold springs.

The *Elaters* and Wireworms found *under stones* on downs, whilst the crops were attacked by the latter.

*Wheat* greatly injured by the Wireworms during the whole of winter, it is said.

They descend deep into the earth when *frosts* are severe.

*Wheat* obliged to be *ploughed up* near Belfast from their attacks.

*Affected plants* are known by the dying off of the outer leaves.

The Wireworms eat into the stem above the roots, and sometimes separate the stalk.

*Elaters* placed on the earth *buried themselves*, and were found dead at the roots of the wheat.

*Elater lineatus* abundant beginning of June, but by the middle of the month they had disappeared.

Wireworms form burrows in the earth at 2 or 3 inches deep.

The smallest Wireworms often the offspring of *Elater obscurus* and *E. lineatus*, and the largest of *E. ruficaudis*, it is supposed.

*Potatoes* are destroyed in the west of England, and escape the attacks of the Wireworms in the eastern counties.

Wireworms found in the hearts of potatoes in Dorsetshire.

They destroy the "sets" when first planted; to palliate this evil, plant whole potatoes.

It is doubtful whether the *curl* be produced by the Wireworm.

*Hop-plants* attacked by them.

*Cabbages* destroyed by them to a great extent.

*Turnips* suffer most amongst green crops.



In mild winters the Wireworms are found at their roots.

They do most mischief to the *young turnip-plants*.

*Multitudes* of various sizes in August gnawing the young turnip-roots, and biting the extremities off.

Some got into the shell of a *snail*, and ate up the animal.

They will feed upon the *turnip-leaves*; drawing the remainder of the plant afterwards into the earth.

Gardens suffer exceedingly; *lettuces* often fall a sacrifice to the Wireworm.

*Elater sputator* is only fourteen days in the pupa state.

The earth should be scraped away from *infested lettuces*, the worms may then be removed, and the earth returned to the roots.

*Hemlock, fool's-parsley, &c.* to be eradicated, as the Elaters resort to the flowers.

*Gardens* formed out of a pasture-ground greatly infested by Wireworms, and the annuals all destroyed; they eat into the stems of carnations, &c.

In adding *loam* and other soils to garden-borders, great care should be taken to free them from Wireworms.

On *light lands* they do most mischief from the beginning of March to June. Wheat and white turnips suffered most; rye does not escape.

*Barley* drilled-in at 3 inches becomes sickly, but does well at one inch and a half.

Wireworms, probably, *cannot live* so near the *surface* in a sandy soil.

*Lower parts* of fields bordering on marshes most infested.

*Rye-grass* most dangerous with clovers for encouraging the Wireworm.

*Gravelly and sandy soils* most infested; *strong loam and clay* most free from them.

They inhabit every *aspect*.

A *wet season* may not destroy the Wireworms, but it does not suit the Elaters, which cannot then deposit their eggs.

*Paring and burning* common land, broken up, preserves the turnip-crops.

*Wheat* sown in *dry weather* most likely to suffer.

*Turnips* when *three or four weeks old* attacked the most in some places; but eating through the *tap-root* does not kill the plant.

*Crops after clover-lays* exposed to the sun, if fed off short, suffer greatly.

By constantly *disturbing insects*, it is probable they may be driven from a locality.

Difference of *soil or season* may cause the failure of a *remedy* which has succeeded elsewhere.

*A summer-fallow* and *burning* the rubbish recommended after clover and grasses; it kills the eggs and starves the Wireworms.

*Soot and lime* will kill them.

*Fallows* must be kept very clean from *couch* and other grasses and weeds.

Nothing more dangerous than to leave *strips and patches of grass* or lays in ploughed fields.

*Waste and wood lands* harbour Wireworms.

*Two crops in succession* stock the land with them, especially potatoes.

*Two inches* of the turf taken off pasture-land by a *breast-plough* an excellent process to secure the succeeding crop: shallow ploughing is supposed to kill the roots.

*Feeding land close* with sheep will prevent the eggs being laid.

*Folding oxen and sheep* in the spring may also keep the beetles from coming out of the earth.

*Harrowing and hard-rolling* in March and April strongly recommended.

*Top-dressings* of lime useful before rolling.

*Wood* will expel the Wireworms.

*White mustard-seed*, equally efficacious; it is supposed they cannot eat the acrid roots.

*Mowing corn* considered good for getting rid of the Wireworms in Germany.

Amongst the leaves of *sweet gale* the Wireworms died in two hours; it is serviceable, therefore, if mixed with manure.

They *lived four days in water*, and drowning them by flooding very difficult.

*Rape-cake* powdered and sown on a field will preserve the wheat-crop.

*Spirits of tar* and sand mixed with the soil will protect a crop.

*Refuse lime of gas-works* will banish the Wireworm.

*Chloride of lime-water* kills them.

*Nitrate of soda* will destroy them.

*Salt* on light sandy soils highly efficacious.

*Alcohol* will deprive them of life in five minutes, and *turpentine* instantly.

The best *bait* in a flower-garden is *sliced potato* stuck down.

*Pieces of turnip, cabbage, beet-root, parsnip, carrot, and apple*, will also attract them.

*Hand-picking* a most certain remedy.

*Rooks* invaluable in catching Wireworms, consuming immense quantities.

*Wagtails, robins, blackbirds, thrushes, and many smallbirds*, will feed upon them.





*Pheasants and partridges* very useful in clearing turnips of them.

*Lapwings* attack them in low grounds.

*Ducks, turkeys, and fowls* will pick them up in ploughed fields.

*Moles* feed almost entirely on insects, and are incessantly labouring to find the Wireworms and other subterranean larvæ.

*Frogs, toads, and lizards* feed on insects.

Wireworms are infested by the parasitic larvæ of an *ichneumon*.

A species of *worm* also lives in their bodies.

---

EXPLANATION OF THE PLATE.

Fig. 1. Eggs of *Elater obscurus*.

a\* The same magnified.

Fig. 2. The true Wireworm or larva of *Elater lineatus* or *E. ruficaudis*.

Fig. 2.\* The under side greatly magnified.

j\* The first thoracic segment.

l\* The proleg or false foot.

m\* The three pairs of pectoral legs.

n\* One of the legs greatly magnified to show the spines and claw.

Fig. 3.\* The *Labrum* or upper-lip of the Wireworm.

Fig. 4.\* The *Clypeus* or nose of do.

Fig. 5.\* A large space under the head, formed by the union of the bases of the maxillæ and labium.

b\* Base of *Maxillæ*.

c\* The *Mentum*, or chin.

d\* The *Labium*, or under-lip.

e\* The *Labial palpi*, or feelers.

j\* The large *maxillary lobe*, the smaller one below it.

g\* The *maxillary palpus*, or feeler.

Fig. 6.\* One of the *Mandibles*, or jaws.

Fig. 7.\* One of the minute *Antennæ*, or horns.

h\* A horn greatly magnified.

i\* Another horn, with an extra lobe.

Fig. 8.\* Upper side of the head, showing the position of the jaws, mouth, and two minute dots like eyes.

Fig. 9.\* Terminal segments of abdomen.

k\* One of the large spiracles.

l\* The proleg or false foot, and vent?

Fig. 10. The earthen case formed by the Wireworm to contain and protect the chrysalis.

Fig. 11. The upper side of the *pupa* or chrysalis removed from the case.

Fig. 11.\* Under side of the same.

Fig. 12. *Elater (Athöus) ruficaudis*.

Fig. 12.\* The same magnified.

Fig. 13.\* The *antenna* or horn of *Elater obscurus*.

- Fig. 14.\* Hind-leg of *Elater obscurus*.
- Fig. 15.\* Male organs of generation of *Elater pectinicornis*.  
*p*\* Apical segment of abdomen.  
*q*\* Central instrument.
- Fig. 16.\* Female organs of generation or ovipositor in the same species.  
*r*\* The external lobes enclosing the oviduct.
- Fig. 17.\* Apical abdominal segment and female organs of generation of *Elater obscurus*.  
*s*\* The two horny lobes uniting and enclosing the oviduct.
- Fig. 18.\* Male organs of generation in the same species.  
*t*\* The central instrument.
- Fig. 19.\* The under side of *thorax* of *Elater obscurus*.  
*o*\* One of the grooves for receiving the antennæ in repose.  
*u*\* Cavities receiving the first pair of legs.  
*v*\* Spine employed in leaping.
- Fig. 20.\* *Postpectus*, with one of the hinder legs attached.  
*w*\* Cavities receiving the second pair of legs.  
*x*\* Coxæ or hips, to which the third pair of legs is attached.  
*y*\* The cavity into which the spine *v* fits.
- Fig. 21.\* *Labrum*, or upper-lip of the beetle called *Elater obscurus*.
- Fig. 22.\* *Mandibles*, or jaws of do.
- Fig. 23.\* *Mentum*, or chin of do.  
*z*\* *Labium*, or under-lip.  
*a*\* *Palpi*, or feelers.
- Fig. 24.\* *Maxillæ*, with their hairy lobes.  
*b*\* *Palpi*, or feelers.
- Fig. 25. *Elater (Agriotes) obscurus*, in outline.
- Fig. 25.\* The same magnified and shaded.
- Fig. 26.\* *Elater lineatus*, represented flying.  
*c* The natural dimensions.
- Fig. 27.\* Hind-leg of *Elater ruficaudis*.  
*d*\* The *Tarsus*, or foot, showing the fourth minute joint.
- Fig. 28. A young wheat-plant; the dotted line denoting the surface of the soil.
- Fig. 29. A small Wireworm feeding in the base of the stem in the earth.
- Fig. 30. A young turnip-plant, with its roots bitten off by the Wireworms.  
*e* A portion near the base gnawed by them.

*Obs.*—All the figures are drawn from nature; and the foregoing numbers and letters with a \* attached indicate that the objects referred to are represented much larger than life.

London, Nov., 1843.

## PART II.

MY last Memoir concluded with the history of the true Wireworms; but I am inclined to believe that some of the following insects, belonging to the same family, may contribute in their larva state to the injury of the field and garden; and, as they are constantly found in corn-fields in the beetle state, figures and descriptions of them cannot be unacceptable to the farmer; these I shall therefore now lay before him, hoping that they may lead to a more perfect knowledge of their economy. I shall afterwards proceed to give an account of the other animals which appear to assist, with the larvæ of the Elaters, in the destruction of the crops, by attacking the roots of the turnips, &c.; all of which have been incorrectly denominated Wireworms by the cultivator.

## ORDER COLEOPTERA, FAMILY ELATERIDÆ.

No. 5 is an Elater which I frequently observe in corn-fields; I find it also under stones, I have taken it off birch-trees in woods, &c. Its appearance lasts from the end of April until August, but nothing is known of its economy or of the Wireworm which it produces. It is called

Elater (*Lepidotus*) *holosericeus*, *Fab.*,\* the satin-coated Click-beetle. It is elliptical or boat-shaped, deep brown, thickly and minutely punctured, and clouded with silky ochreous pubescence: antennæ scarcely so long as the head and thorax, slightly pubescent, eleven-jointed; basal joint the stoutest, somewhat chopper-shaped, and chesnut coloured; 2nd, minute; 3rd, long and slender, clavate; 4th and six following produced internally, obtrigonal, apical joint elongate-ovate, apex narrowed (fig. *a*); head small; palpi and eyes black; thorax convex, semi-ovate, concave before, broadest at the base, which is bisinuated, the angles produced, each forming a strong trigonal lobe, not very acute; pectoral lobe rather small and tapering; scutel large and orbicular; elytra more than twice as long as the thorax, and scarcely broader at the middle, the ochreous pubescence often forming two ocelli on the disc; nine punctured striæ on each elytron, most distinct at the base; costa emarginate towards the base; wings ample; legs short, slender, and pale ferruginous; length 5, breadth 2 lines (fig. 31).

6. This Elater is found in corn-fields and in sandy places at the same periods as the foregoing species; but whether its larva, or Wireworm, is injurious to the crops, I am unable to state; it is named

Elater (*Agrypnus*) *murinus*, *Linn.*, the mouse-coloured Click-beetle. It is rather broad and boat-shaped, entirely clothed with

\* Vide Curtis's Brit. Ent., fol. and pl. 694 for dissections, &c. of the Elateridæ; and the Guide, Genus 309, for an arrangement of the species.

very short ash-coloured depressed hairs, marbled with brown, more or less ochreous, and is thickly and minutely punctured. Antennæ shorter than the thorax, rather stout, and eleven-jointed, bright ferruginous, basal joint stout, oblong, and piceous; 2nd, small, semiovate; 3rd, smaller, pear shaped; 4th and six following compressed, produced internally, obtrigonal, apical joint longer, ovate, the apex suddenly narrowed (fig. *b*); head semi-orbicular, depressed; eyes scarcely visible; thorax twice as broad, orbicular, convex on the back, with two tubercles on the disc; beneath are two deep fissures to receive the antennæ, and the pectoral spine is long and attenuated, the apex subulate; scutel ovate-conic; elytra a little broader than the thorax, and more than twice as long, hinder portion attenuated, the apex rounded, sloped suddenly towards the thorax at the base; there are nine indistinctly punctured striæ on each, and the costal margin is deeply emarginate to receive the hinder thighs; wings ample; legs short and shining pitchy; the tips of the thighs and the tarsi fulvous—the latter are five-jointed and tapering, basal joint the stoutest and the longest in the hinder pair; claws moderate and acute; tibiæ rough, with series of minute bristles; length 6, breadth  $2\frac{1}{2}$  lines, sometimes much larger.

7. This species of Click-beetle is sometimes abundant in corn-fields, also in hedges and grassy places, in May and two succeeding months; but as the Wireworm lives in decaying trees, it is not likely to do any mischief to the crops. It is named

*Elater* (*Melanotus*) *fulvipes*, *Herbst*, the tawny-legged Click-beetle; it is also called by *Marshall* *E. castanipes*—a more appropriate name, as its legs are of a chesnut colour. It is very long, narrow, and shining black, thickly punctured, and clothed with very short fine ochreous pubescence; antennæ as long as the thorax, compressed, pubescent, fulvous, and eleven-jointed; basal joint stout and subpyriform; 2nd, minute, nearly globose; 3rd, small obovate; 4th and six following, produced internally, obtrigonal, but slightly decreasing in diameter to the apical joint, which is spindle-shaped (fig. *c*); mouth pale ferruginous, the labrum and tips of mandibles piceous; head rather broad, semi-orbicular; the eyes hemispherical; clypeus forming a sharp projecting shelf over the mouth; thorax convex, somewhat semiovate, almost straight before, the base nearly straight also, the angles forming rather narrow lobes, appearing pointed above, but truncated laterally; there is a dorsal impression broadest at the base, and a short longitudinal channel on each side, close to the lobes; the pectoral spine is rather long and narrow; scutel tongue-shaped; elytra thrice as long as the thorax, but not broader, linear, the apex subovate, they are more finely punctured than the thorax, and there are nine punctured striæ on each; costal margin gently



hollowed towards the base; wings ample; legs moderately long, chestnut coloured; tarsi tapering, basal joint the stoutest, and a little elongated; 4th, small; claws minute; length from 6 to 9 lines, breadth from  $1\frac{3}{4}$  to 2 and  $\frac{2}{3}$  (fig. 33).

8. Is nearly allied to the *Elater obscurus*, pl. I., fig. 25, but it is smaller. The Wireworm of this species is said to abound in grass fields, where it feeds with those of *E. obscurus* and *E. lineatus*; the perfect insects are occasionally found in multitudes in marshy districts in the rejectamenta left by floods in Norfolk, Cambridgeshire, &c., and in the spring and summer months they are abundant everywhere. This has been called, I know not why,

*Elater* (*Agriotes*) *spntator*, *Linn.*, the spitting Click-beetle. It is reddish brown, clothed with short depressed ochreous pubescence; antennæ scarcely so long as the thorax, compressed, pubescent, basal joint stout; 2nd rather longer than the 3rd, which is oval, the remainder short and obovate, terminal joint elongated; apex conical; head and thorax black, shining, and thickly punctured; the anterior margin of the latter, and the hinder lobes, reddish brown; the head is somewhat orbicular; the clypeus narrowed; thorax longer than broad, narrow, oblong, very convex, with a dorsal impression behind, the posterior angles forming truncated lobes; scutellum oval, truncated at the base; elytra not broader than the thorax, and twice as long, nearly linear, the apex ovate; they are somewhat scabrous, with nine striæ on each, not neatly punctured, and deepest at the base, costal margin very concave towards the base; wings ample; under side castaneous-brown, the angles of the thorax and the pectoral spine, which is rather long and slender, ferruginous; legs moderate, slender; feet tapering, basal joint a little elongated; claws slender; length 3 lines, breadth 1 line (fig. 34). The colour of this insect varies considerably, some specimens being entirely bright ochreous, whilst others have the head and thorax partially variegated with black.

9. Is a Click-beetle very abundant in corn-fields, hedges, and meadows, in May and June. I have copied the tail of the Wireworm from Bouché (fig. 41), who asserts that it lives two years in rotten horse-dung in a high state of decomposition, when it is almost become earthy, and with it the Wireworms are of course conveyed into the fields and gardens. The beetle is called

*Elater* (*Athöus*) *niger*, *Linn.*, the black Click-beetle. It is boat-shaped, shining black, finely punctured, and clothed with yellowish pubescence, which is not depressed; antennæ longer than the thorax, compressed, tapering and hairy, basal joint stout; 2nd, minute, ovate; 3rd, obtrigonal; the following similar but larger, produced on the inside, but decreasing towards the apical

joint which is fusiform (fig. *d*); head suborbicular, the clypeus, forming a projection over the trophi; thorax twice as broad, oval, very convex, the posterior angles not acute, a little divaricating; pectoral lobe not long and tapering; scutel ovate-trigonal; elytra broader than the thorax, elliptical, the apex ovate or subconical, with nine punctured striæ on each, most distinct at the base; wings ample; legs not long; thighs stoutish, three basal joints of tarsi cushioned beneath; 2nd and 3rd dilated; 4th minute; 5th, slender; claws small; length  $5\frac{1}{2}$  to 6 lines, breadth  $1\frac{3}{4}$  to 2 lines (fig. 35).

10. Abundant in June, July, and August, upon oaks and alders in woods, and not unfrequent in corn-fields, but nothing is known of its economy; it has received the name of

Elater (*Dolopius*) *marginatus*, *Linn.*, the margined Click-beetle, and is the *E. suturalis* of Marsham. It is narrow and elliptical, shining, testaceous, and clothed with short ochreous pubescence; antennæ longer than the head and thorax, slender, compressed, fulvous, and pubescent; basal joint the stoutest, clavate; 2nd and 3rd the slenderest, elongated—the latter a little the shortest; 4th and following stouter and clavate; terminal joint subfusiform (fig. *e*): head and thorax thickly and strongly punctured; the former obtuse, convex, and pitchy; the latter longer than broad, very convex, piceous, anterior and posterior margins bright ochreous, including the angles, which are very acute and slightly divaricating; scutel subovate; elytra linear, thrice as long as the thorax, sometimes rather broader, attenuated or ovate behind, ochreous or reddish brown, with a space down the suture, and sometimes the costal margin brown; they are somewhat scabrose, with nine distinctly punctured striæ on each, the outer margin slightly concave towards the base; wings ample; underside more or less fuscous or castaneous; the pectoral spine long and narrow, but thick; apex of abdomen testaceous; legs moderately long, slender, and pale ferruginous; tarsi, with the terminal joint the slenderest, basal joint elongated; claws minute; length  $3\frac{1}{4}$  lines, breadth  $\frac{3}{4}$  (fig. 36). An exceedingly variable species in outline and colour, some specimens being broader than others, and the antennæ are apparently stouter in the males; some examples are entirely bright ochreous or chesnut, and others are uniformly of a pitchy colour.

11. This species also frequents corn-fields, meadows, hedges, &c., but whether its larva is injurious to the crops has not been ascertained; it is so like the former one (*E. marginatus*) in miniature, that it will be unnecessary to figure it. It is about the size of *E. limbatus* of Linnæus, but the thorax is narrower and less convex, and there is generally a distinct sort of shallow groove down the crown of the head. It is distinguished by the name of

*Elater* (*Adrastus*) *acuminatus*, *Step.*, the pointed Click-beetle. It is elliptical, narrow, shining testaceous, and clothed with short ochreous pubescence; head and thorax black, punctured; the former with an impression down the centre, the latter longer than broad, the anterior margin and posterior angles, which are acuminated, are testaceous; antennæ longer than the head and thorax, compressed, castaneous; basal joint elongated, stout; 2nd and 3rd obovate, the latter a little the shortest; 4th and following somewhat obovate, truncate, terminal joint fusiform; scutel dark, oval; elytra nearly thrice as long as the thorax, punctured, testaceous, the suture often dusky, especially near the apex, with nine punctured striæ on each; underside piceous; pectoral spine long and slender; legs ochraceous; length 2 lines, breadth about half a line.

12. Also frequents corn-fields, hedges, grassy and woody places, from April to August, but its economy is unknown. It is the *Elater* (*Athöus*) *longicollis* of *Fabricius*, the long-necked Click-beetle. The *male* is long and narrow, ochreous, and clothed with very short pubescence of the same colour; head and thorax thickly and coarsely punctured, dull black; the anterior margin of the latter, the sides and base, including the angles as well as the clypeus, more or less ferruginous in many examples; this portion of the head is very concave, the margin thickened and slightly reflexed; the antennæ are more than half the length of the body, slender, and compressed; the basal joint is clavate, and not stouter than the following, which are elongate-clavate, and truncated, excepting the 2nd, which is minute, and the terminal joint, which is subfusiform (fig. *f*); the head is subquadrate; the eyes very prominent; thorax long and narrow, not much broader than the head before, gradually and slightly increasing in diameter to the base; the angles short and truncated laterally; the sides are nearly straight, but slightly convex near the middle; down the back is a faint channel, with a slight fovea on each side near the base; pectoral spine long and slender; scutel small, black, and punctured; elytra more than twice as long as the thorax, and a little broader, linear, the apex ovate, the costal margin fuscous and very gently concave near the base, they are slightly glossy, a little rugose, with nine distinctly punctured striæ on each; wings ample; underside more or less piceous, excepting the body, which is ochreous and very glossy, sometimes pitchy down the centre or having two fuscous spots on each segment; legs longish, slender, and deep ochreous; tarsi tapering, basal joint elongated, 4th minute; length  $4\frac{1}{4}$  lines, breadth rather more than 1 line (fig. 38). The *female* differs so considerably from the male in form that the name of *longicollis* is not appropriate; it is much broader and larger, the antennæ are not so long, the 3rd and fol-

lowing joints being obtriginate: this sex varies also greatly in colour, some specimens being entirely brown, others of an ochreous-chesnut, &c.

As the Wireworms seem to be easily distinguished from each other by the apical segment of the abdomen, I have copied from Bouché\* those which he has described, hoping it may tend to their being accurately identified with their respective click-beetles by some one who may be fortunate enough to rear them hereafter. Figure 41 he calls the Wireworm of *Elater niger* (vide fig. 35); 42 is *Elater lineatus*, 43 *Elater fulvipes* (vide fig. 33), and 44 *Elater fulvipennis*. I must, however, observe, that I have some doubt of his figure of *E. niger* belonging to that species; but the Wireworm of *E. lineatus* he has certainly mistaken, as will be seen by referring to our pl. I., fig. 9, † which represents the same portion of the Wireworm as fig. 42, pl. J. Bouché's figure of *E. fulvipes* approaches that which I believe to be the Wireworm of that insect; and as his drawings are not accurate I fear, it is most probable they are identical. His *Elater fulvipennis* is most probably correctly named, as it lives in decayed timber, in which it changes to a beetle with yellowish or reddish elytra: his figure represents the underside with the anal foot contracted. I have found, at different times, the Wireworms of two allied species, namely, *E. sanguineus*, Linn., and *E. rufipennis*, Hoff., whose habits are similar and their figure very like Bouché's.

At fig. 39 I have drawn a Wireworm, which I believe to be the larva of *Elater fulvipes* (fig. 33): it is very shining, nearly as large as the figure, of a ferruginous colour, with a few long hairs distributed over the body, and a channel down the back; the head is flattened, with four channels in front (fig. *g*), and the tail is conical, concave above, with four channels at the base, rugose and transversely striated towards the tip, which is acuminate, forming a tooth, with two obscure tubercles on each side (fig. *h*); the jaws are black, the 6 pectoral legs small, and the anal foot distinct.

This Wireworm cannot, I imagine, be injurious to the cultivator, as it feeds in decaying trees, from which I have cut it out, together with the perfect insect. Bouché says it lives two years in soft willow wood, and becomes a pupa there in winter.

Figure 40 I think may prove to be the Wireworm of *E. murinus* (fig. 32) or of *Elater niger* (fig. 35). It does not, however, agree with

\* Naturgeschichte der Insecten, pl. 8, figs. 31, 32, 33, and 34.

† Whether this be the Wireworm of *Elater ruficaudis* or of *E. lineatus* I cannot positively decide, for they seem to be so exceedingly similar that it is impossible to detect the slightest difference between any of the specimens I have found at the roots of the turnips and corn crops, or amongst the multitude of examples which have been transmitted to me for my inspection, yet I think the largest specimen must belong to *E. ruficaudis*.

Bouché's figure of *E. niger* (fig. 41), but whether he be correct I cannot determine. I have thought it necessary to give a drawing of it, having received specimens with other Wireworms from Surrey in August; and I have met with the same species under stones, occasionally, on grassy downs. It is very shining, ochreous, and clothed with longer hairs than usual, with a faint channel down the back; the head, first thoracic segment and tail are ferruginous; it is not so cylindrical as the common Wireworm; the head is broad and flattened; the jaws are longish, arched, acute and black (fig. *i*); the first thoracic segment is narrowed behind; the apical segment is somewhat semiovate, with a large oval excavation, forming a hollow above; it is rugose, with two longitudinal channels; the sides are denticulated, and at the apex are two large teeth, generally notched, and separated by a triangular fissure; the underside is tuberculated, and the anal foot is large and broad, with a short horny spine on each side (fig. *k*); the six pectoral feet are small, but serrated beneath with spines, and terminated by simple claws.

In the course of publication of these papers we have seen that many insects prey upon one another, and that probably no species injurious to agriculture is free from the attacks of parasitic and predaceous insects, which, by subsisting upon the mischievous multitudes, subdue their numbers and render a most essential service to man. I have already alluded to those which live upon the Wireworms in the former part of this memoir; but as I have now obtained additional materials, and am enabled to add figures of the insects which destroy them, as well as others which infest the click-beetles, I shall describe these valuable little friends of the cultivator.

Thousands of insects, called *Carabidæ*, varying greatly in size, from half a line to an inch in length, may be found under stones and clods in fields, meadows and gardens, where they secrete themselves by day, and sally forth at night to feed upon other insects, worms, larvæ, &c., which come to the surface at that period either to feed or to migrate; they are consequently eminently serviceable in reducing the ranks of noxious animals. During a drought they retire into cracks in the earth, and to the most humid spots, and evidently enjoy the refreshing rains which succeed. I have seen the large *Carabus glabratus*\* in mountainous districts running about immediately after a thunder-storm, each having a tolerably large earth-worm in its mouth; others, as the splendid *Calosoma sycophanta*,† live entirely upon caterpillars in trees; and there is one which is eminently serviceable by feeding upon the Wireworms—a fact for which I am indebted to a

\* Donovan's Brit. Ins., v. 15, pl. 506.

† Curtis's Brit. Ent., fol. and pl. 330.

most zealous naturalist, Mr. Marshall Fisher of Ely. The insect alluded to belongs to the ORDER COLEOPTERA, the FAMILY CARABIDÆ, and the GENUS CARABUS of Linnæus, but it has been designated by a new generic name by Megerlé, and is now called

13. *Steropus madidus*, *Fab.* (fig. 45,) from its inhabiting wet and damp localities. It is shining black; the legs are often red; head oval, forming a neck behind: the eyes are not large, but prominent and hemispherical; the mouth is complete, and furnished with two pair of longish jointed palpi of a chesnut colour, and two large curved and acute jaws;\* antennæ not longer than the thorax, tapering, the apex sometimes of an orange colour; thorax broader than the head, somewhat obovate, concave before, truncated at the base, the angles rounded, with a large fovea on each, marked with two short longitudinal channels, and a sharp indented dorsal furrow; the entire surface is delicately striated with transverse wavy lines, which are only visible under a magnifier; the scutel is short and broad; the elytra are convex and soldered together, and consequently both sexes are destitute of wings: their form is oval, narrowed at the base, each having nine deep striæ, the first furcate next the scutel, the eighth impressed with strong punctures, the costal edge a little emarginated on each side towards the tip: legs strong; thighs stout; anterior tibiæ the thickest, with a notch on the inside producing a spine, and another at the apex: the others are spiny with bristles, and terminated by a pair of moveable spurs; the tarsi are five-jointed, and furnished with two sharp claws: in the male the first pair of feet are dilated and cushioned beneath, the three basal joints being broad and heart-shaped, the fourth similar but minute; length 7 lines, breadth  $2\frac{1}{2}$ .

*S. madidus* is a very active insect: it prowls about at night, and is admirably adapted to its predaceous mode of life. The free motion of its neck and thorax gives it an advantage over most insects of its own size, and its strong legs are furnished with spurs and spines which enable it to stand firmly, and resist the efforts of any individual endeavouring to escape from its grasp. The sensitive horns are in constant motion: with its long palpi it embraces its victim, whilst it tears it in pieces with its sharp and powerful jaws. When touched, these beetles eject a terribly fetid and dirty fluid from the mouth, which is probably a defence against the more powerful and kindred species. To show the usefulness of this insect I cannot do better than give Mr. Fisher's own statement of the facts which came under his observation. He says—“My brother Henry seeing a field which had been sown with oats much injured, pulled up several plants and found numerous Wireworms at the roots of each: he put them into a box with

\* Curtis's Brit. Ent., pl. 171 for dissections, &c.

several black beetles of the family *Carabidæ*, which he detected in the same field, and on opening it a short time after, he saw one of the beetles with a Wireworm in its mouth. Profiting by this accidental discovery, I placed two of the beetles under a glass with a Wireworm; the beetles appeared to whet their mandibles, ready for the attack, and in an instant each had seized the Wireworm, the writhings of which threw the beetles upon their backs; they quickly recovered their legs, and the worm was soon divided, each taking his share, and entirely sucking out the milky contents, leaving only small fragments of the horny skin. I then introduced several more worms under the glass, and they as speedily disappeared. I repeated the experiment several times with the same results; I therefore think I may fairly conclude that this beetle is a natural enemy of the Wireworm."

Figure 46 represents a dead shrivelled Wireworm, of *Elater lineatus*, I believe, which was infested with parasitic larvæ, one of which had become a pupa (fig. *p*), so greatly advanced that in a few days the perfect fly would have been hatched. By some accident this pupa was forced through the skin, and it is evident that it was some species of Ichneumon; for the head (fig. 47, *l*) is distinct enough, and shows the two eyes; the antennæ (fig. *m*) are enclosed, as the whole animal is, in a transparent shroud. Fig. *n* exhibits the thorax, and fig. *o* the legs and jointed feet. I had hoped to breed this insect, but it died, and it must therefore be left for future inquirers to determine the species of this useful little being, which was not unknown to Berkander, and is very probably far from uncommon. The specimen was sent to me the 1st August, 1841, having been just discovered with other Wireworms in Surrey.

The click-beetles themselves are not free from the assaults of minor enemies, which may not actually destroy them, but I imagine they must exhaust and weaken the individuals they attack so as to render them incapable of fulfilling their functions with energy. Of these animals two very different species have come under my observation, which I will now describe; but it will not be irrelevant to observe that the class Insecta, as it stood in the last century, included crabs, lobsters, spiders, centipedes, &c. Latreille, however, and modern philosophers have very properly divided them into three classes; \* the 1st is called CRUSTACEA, the 2nd ARACHNIDES, the 3rd INSECTA. With the 1st we shall have nothing to do in these reports; the 3rd is distinguished by its pair of genuine antennæ, six thoracic legs, &c., comprising all the insects whose histories we have recorded; and the 2nd will include most of the few remaining animals, which will complete this communication.

\* Dr. Leach formed the insects of Linnæus into five classes, namely Crustacea, Arachnoida, Acari, Myriapoda, and Insecta.

The CLASS ARACHNIDES embraces the millipedes, spiders, lice, mites, ticks, &c. Amongst the last are included the little parasites before us, the first of which belongs to the ORDER ACERA, FAMILY RICINÆ or Ticks, GENUS UROPODA of Latreille. The Baron De Geer describes a tick nearly allied to ours under the name of *Acarus vegetans*;\* but as that species is attached by the apex of the body and this by the back, I am induced to think it a distinct species, which I shall call

14. *Uropoda umbilica*. It is oval, rusty-brown and shining; the upper side horny, shield-shaped, convex and punctured, with longish scattered hairs. From the back, but a little on one side, arises a peduncle (fig. 49, *s*), which is white, transparent, as long as the animal, sometimes gradually increasing to the extremity, which is attached to the elytra of the *Elater* (fig. 48, *r*). It has eight short-jointed legs more or less clothed with hairs, which in repose are pressed close to the underside: the first pair seem to be somewhat palpi-form and a little the longest, especially in the terminal joint, which is densely hairy at the apex; the second pair are the shortest, similar to the preceding, but tapering and less hairy; the others are terminated by a slender transparent clavate joint, destitute of hairs (fig. 48, *q*; the natural size).

This curious tick infests the *Elater obscurus* (fig. 48), attaching itself in considerable numbers to the wing-cases by a singular contrivance in the shape of a thread, which is fixed by one end to the tick and by the other to the click-beetle. This is probably a provision to prevent the tormented animal from rubbing off his parasites: they are able, according to the remarks of De Geer, to remove when they please, by crawling in a certain direction until the cord is sufficiently strained to cause the end to be detached from the beetle. It has been supposed that these animals obtain their nutriment through this tube; and whether they possess a rostrum for sucking I have not been able to ascertain, from the extreme minuteness and obscurity of the head.

The other parasite belongs to the same ORDER ACERA, † but to the FAMILY MICROPHTHIRA, and the GENUS LEPTUS, Latreille. It infests the click-beetle named *Elater ruficaudis*, which has been already described and figured. ‡ It is a very different little animal to the *Uropoda umbilica*, thrusting its beak into the punctures of the thorax and elytra of the beetle, and thus absorbs the juices (fig. 50, *t*). The dreadful pest called the harvest-bug, § which insinuates itself into one's legs, causing an insupportable

\* Mémoires pour servir à l'Histoire des Insectes, v. vii., p. 123, pl. 7, fig. 15 and 16.

† Latreille, in his later works, makes this a family only of his Arachnides.

‡ Vide pl. I., fig. 12.

§ *Leptus autumnalis*, figured in Shaw's Zool. Misc., vol. ii. pl. 42.



irritation, and which is also red, but invisible, or nearly so, to the naked eye, is closely allied, I believe, to our tick, which appears to be described by De Geer under the name of *Acarus Phalangii*, from its infesting the harvest-spider (*Phalangium Opilio*). It now bears the appellation of

15. *Leptus Phalangii*. It is of a brilliant scarlet colour, and soft. The head is pear-shaped, terminating in an attenuated slightly-curved rostrum, and on each side is an appendage forming a pair of horns or short legs: these seem to be triarticulate, the basal joint the stoutest, third small. The abdomen is large, and like an oval bag, attached by a narrow base, forming a neck. The back and belly are sparingly clothed with black stoutish hairs. To the pectus are attached six long slender legs, remote at their base, especially the hinder pair, which are the longest, and those before them are shorter than the second pair: they are composed of many joints, and clothed with black hairs, which appear thick, from their being pubescent I suspect: fig. 51; the natural size being shown at *t*, fig. 50.

Having now discussed every subject, I believe, relating to the "true Wireworms," I shall turn to the history of the other animals which are improperly included by agriculturists under that denomination, and may not inaptly be termed "false Wireworms." Some of them may be almost as injurious to the crops as those just described; but as portions of their economy still remain doubtful, this is a point which I fear cannot be determined satisfactorily.

A general belief prevails amongst farmers that the larger gnats, or *Tipulæ*, called crane-flies, daddy long-legs, &c., are the parents of the Wireworms. This we have already shown to be quite a mistake, yet it is very far from improbable that the maggots of the *Tipula Oleracea*, &c., may do mischief to farm as well as to garden crops; but as it is most destructive to grass-lands, I shall pass by its history until I arrive at that portion of my work. There is, however, a larva of a gnat which I shall here describe and figure, as it is an undoubted enemy to the corn-crops; and being one of the false Wireworms it will come under this head. I regret exceedingly that it did not reach my hands in a living state, in order that I might have reared it, to ascertain the parent insect. I was, however, shown such multitudes of a gnat, called, I believe, *Tipula maculosa*, in walking over a turnip-field in Suffolk, which the owner imagined were the produce of the genuine Wireworms, that I think it very probable this maggot was the early state of that or an allied species.\* The larvæ alluded to were found in great numbers in May, 1841, attacking the roots of Lord Prudhoe's wheat, and were transmitted to Mr. Yarrell, who gave

\* Vide Curtis's Guide Gen., 1160, No. 30 and following.

them eventually to me. They were of a yellow ochreous colour, composed of the usual number of segments (fig. 52), tapering to the head, and truncated at the tail, and were about two lines long (*v*). The head was furnished with two small black horny fangs (*u*); and the tail was cut off abruptly, the lower circumference being deeply indented, and forming several irregular lobes, and in the centre were two brown tubercles. It was destitute of feet, as such maggots usually are.

The remaining animals which infest the roots of corn and other crops, and called also Wireworms by the farmers, belonged to the Class Arachnides and the Order Myriapoda. Latreille subsequently altered the value of these terms, changing them to the CLASS MYRIAPODA, the ORDER CHILOGNATHA, and the FAMILY ANGUIFORMIA. Linnæus gave them the generic name of JULUS; and from the typical species resembling snakes in miniature, especially the slow-worm, I have applied to them the English appellation of Snake-millipedes. After describing them I will relate their history and economy. One has been named

16. *Julus pulchellus* by *Leach* (the beautiful Snake-millipede). This species is from one-sixth to half an inch long, or upwards. It is slender, cylindrical, and shining (*x*); it has about 170 legs; the horns are clavate, pubescent, and seven-jointed, the apical joint being minute (*y*); the eyes are black, and coarsely granulated; it is pale ochreous, with a double row of bright crimson spots down each side, excepting the four first and five last segments; the whole of them are faintly striated longitudinally with a rather deep incision separating the rings (fig. 53).

After death this species becomes of a fine sanguineous purple, which will stain the paper upon which the specimens are gummed. It is, I think, the most widely spread, if not the most abundant, of the Snake-millipedes. It inhabits both fields and gardens, and has been observed feeding upon a small *Helix*.

17. *Julus Londinensis* of *Leach*, the London Snake-millipede, (fig. 54), is usually about an inch long, cylindrical, shining, and rather stout. It is of a dark lead-colour. The segments are longitudinally striated, the margins subferruginous; there are two black dots on each, excepting the five thoracic and four apical ones, forming a line of pores down each side, from which an acid liquor flows, of a disagreeable odour, which is said to be employed to defend itself from enemies. The legs are dirty white, and amount to about 160, in pairs on each side, so that each segment seems to be provided with four legs. The head is brownish, and pubescent, with black granulated eyes. The antennæ are brown, clavate, and a little hairy. The basal joint is sub-globose; second elongated, and slightly exceeding the following in length; the third, fourth, and fifth are stouter, ovate-truncate, the last

forming a club in union with the sixth, which is small. Thoracic segment twice as long as the others. Apex of abdomen rounded, with a vertical slit; the penultimate ring with the centre a little angulated, and lapping over the apex, but not mucronated ( $z$ ).

This is a large species, and similar to the following; but there are gigantic Snake-millipedes in South America, as thick as one's little finger, and upwards of half a foot in length. *Julus Londinensis* was so named from its having been first discovered in the neighbourhood of the metropolis; and it infests the roots of wheat in Surrey, from whence I have received specimens at the end of April, which had not arrived at their full growth.

18. *Julus terrestris*, *Linnaeus*, the earth Snake-millipede. Shining, cylindrical, and piceous; rather strongly striated longitudinally; the edges of the segments brownish, a line of indistinct black pores on each side; the legs ochreous; eyes black, and granulated; antennæ longer than the first thoracic segment, which is larger than the others, seven-jointed, basal joint globose, four following elongated, clavate, truncate, the last being the stoutest, and forming with the sixth and seventh a little oval club, the apical joint being minute ( $b$ ); penultimate segment of abdomen mucronated ( $a$ ), the lobe subtrigonal, the tip rounded.

This species greatly resembles the foregoing, but the spined tail and longer antennæ readily distinguish it. I remember one being discovered inside a rotten pear.

19. *Julus punctatus*, *Leach*, the dotted Snake-millipede, is often an inch long, but rather slender, cylindrical, and of a testaceous brown or ochreous colour; the margins of the segments are finely and very closely striated; the crown of the head and thoracic segment are freckled, the penultimate one is mucronated, the lobe oval; face, antennæ and legs, pale ochreous; eyes grey, granulated with black. When alive this species is of a somewhat pellucid pale flesh-colour, every segment with a black dot forming a line down each side.

I generally find this *Julus* amongst the moss on old stumps, and under stones in woods; but I think I have received it with the other species from gardens.

20. *Julus latistriatus*, *Curtis*, the broad-lined Snake-millipede, is 5 or 6 lines long, of a dull ochreous lilac with a purple tint, cylindrical, very shining, sparingly striated, the lines not approximating; down each side is a row of dots, and the penultimate segment is not mucronated, but slightly angulated and rounded, as in *Julus Londinensis*; the antennæ are stout and rather short, pilose and capitate, second joint the longest, the apex very pubescent.

This *Julus* I took at first for the young of *J. Londinensis*, but the striæ are twice as far apart as in any other species I have exa-

mined, and when dead it greatly resembles *J. pulchellus* in colour. I have never seen it alive; but thousands were infesting a garden at Namptwich, and a small box full was forwarded to me.

21. *Julus pilosus*, *Newport's MSS.*, the hairy Snake-millipede, is nearly an inch long, rather slender, cylindrical, lead-coloured, slightly pilose, the margins of the segments being striated and somewhat ciliated, the penultimate segment is mucronated; the lobe is pointed, and projects beyond the terminal joint, which is brown and hairy; there is a line of black dots down each side; the thoracic segment, head and antennæ are brown: these last are rather long, slender, very pubescent, and slightly clavate; the fifth joint is nearly as long as the second.

This very distinct species stands in the British Museum with the above appropriate name, being distinguished from all the others by the hairs scattered over its entire length. I have found it more than once infesting the roots of cabbages in gardens in March.

There is one more species which belongs to the GENUS *POLYDESMUS* of Latreille. It is essentially distinguished from the *Julii* by the apparent absence of the eyes, as well as by its flattened back, the segments being a little dilated or margined on the sides, and the hinder angles of each are acute; the tail is mucronated, and it has only between sixty and seventy legs: the antennæ are seven-jointed, the basal joint being subglobose; second, ovate; the third is by far the longest; the two following are elongate, clavate, and truncated; the sixth is stouter and ovate, forming a little club; the seventh is small (d); the species is named

22. *Polydesmus complanatus*, *Linnaeus*, the flattened millipede (fig. 55). It is of a pale lilac colour above; the back is granulated; the belly is whitish; the legs are more or less ochreous. It is generally from  $\frac{1}{4}$  of an inch to  $3\frac{1}{2}$  lines long (c), but when arrived at maturity some specimens are as large as fig. 55.

This is reported to be by far the most destructive species. In April considerable numbers of the smaller ones were detected eating the roots of wheat, and in the spring and autumn they were injuring the roots of onions and pansies. They propagate rapidly where the earth is undisturbed; and specimens measuring three-quarters of an inch have been found under garden pots at the roots of anemones. In a systematic arrangement *Polydesmus* forms a natural transition from the snake-millipedes to the centipedes, called *Scolopendræ*, the habits of all being similar; but as the numbers of the latter family are comparatively insignificant, and they are said to live like the earth worms upon the soil alone—which, however, I very much doubt—it appears to be unnecessary to enter farther into their economy.

The Snake-millipedes seem to be both carnivorous and herbivorous, for they have been detected feeding upon small snails, as well as upon the pupa of a fly; and they are believed to live also upon larvæ, acari, earth-worms, &c.; and there is such abundant evidence of their destroying the roots of many vegetables, being found clustered together in multitudes at the roots of corn, potatoes, turnips, cabbages, &c., that there can be little doubt of their doing great mischief to many crops of the gardener, and apparently to the farmer also. In order to confirm this generally-received opinion, which appeared formerly to rest upon doubtful evidence, I shall enumerate the different proofs which have come to my own knowledge.\* A garden at Ledbury, Herefordshire, was infested by *Julus pulchellus*, which congregated in masses at the roots of the Brassica tribe. On pulling up some rotten cabbage stalks in the beginning of March, I found the *Julus pilosus* amongst the roots; they were then of a large size, and had, as well as I could ascertain, 156 feet, being thirty-nine pairs on each side. At the end of the same month *Julus Londinensis* was detected at the roots of wheat; they were at that time an inch long, and *Julus pulchellus* was observed with them: these I buried at the roots of some potatoes and wheat, which I dug up in August, when the former were completely decayed, but the latter were not in the least injured; and I could not detect any of the snake-millipedes. I received some roots of the scarlet-bean from Ulswater, in Westmoreland, which were eaten through and through by the *Julus pulchellus* and *Polydesmus complanatus*, which were still sticking in the holes formed by them in the cotyledons; and the party who transmitted them stated that thousands of those species infested his garden, destroying the peas and kidney-beans also. Near Namptwich, in Cheshire, the *Julus latestriatus* was in countless myriads in January last, destroying the potted plants in the green-houses, by eating the rind just at or under the surface of the soil; and cauliflowers and cabbage-plants shared the same fate in the garden: nearly at that period of the year the *Julus Londinensis* was doing great injury to the early potato crops near Chester. My friend Mr. W. W. Saunders, who is too able a naturalist to be deceived, has ascertained that the *Juli* are very destructive in his garden at Wandsworth, where they devoured the young shoots of the heartsease just below the surface. I have more than once observed the snake-millipedes and *Polydesmi* in September infesting the roots of onions, which had been attacked by the maggots of a fly;† and the *Polydesmus* injures the carrot crops

\* Latreille says "These insects (the millipedes) live upon substances both vegetable and animal, but dead and decomposed."—Vide Cuvier's Règne Animal, edition 1829, vol. iv. p. 333.

† Called *Anthomyia Ceparum*, Hoffmannsegg; vide Gardeners' Chronicle, vol. i. p. 396.

by eating various labyrinths in the roots. The *Juli* are also found in pears, apples, &c., but I believe not in sound fruit. A few similar proofs the reader will have observed appended to the descriptions of the various species. These animals are also found in considerable numbers under the loose bark of decaying trees, in company with woodlice, earwigs, &c., also amongst the moss which clothes the base and holes in the trunks and stumps of trees, and likewise under stones in humid situations.

The action of the Snake-millipedes is very remarkable; the horns are constantly moving when they walk, which is very leisurely, yet they appear to glide along in a very peculiar manner, owing to the immense number of legs they possess, amounting sometimes to 240: these legs are very small, jointed, and terminate in a single claw, and are so thickly set in pairs, that when the animal is in motion they resemble a fringe of hairs, one pair moving after another in quick succession, yet with the most exact and beautiful regularity, causing an undulatory effect. They are able to jerk themselves about like a scotched snake, and when disturbed they coil themselves up spirally, the head forming the centre, and all the legs are then contracted and concealed, and in this position they appear to repose.

These animals being longlived have ample means of doing mischief, if such be their nature, for they do not arrive at their full growth until the expiration of two years, when the organs of generation are developed, and during that period they change their skins, or rather horny coats, five times: in this respect they resemble the true wireworms, but there is a great difference in their economy; for these, as we have shown, become beetles, and pass through four distinct stages or metamorphoses, namely the egg, larva, pupa, and beetle, whereas the Snake-millipedes, &c. are animals which seem to be always in a caterpillar state, undergoing a constant succession of growth, and increasing in bulk from their birth to their death, so that they are active and feeding during the whole period of their lives, and do not, like the true wireworms and other larvæ of insects, ever change to anything else. The females lay their eggs from Christmas until the middle of spring, each depositing a great number in the earth: those of some species are round, whilst others are stated to be oval and of a dirty or yellowish white colour. A few of these animals, however, may be said to undergo certain degrees of perfection as they increase in stature, for they are very dissimilar in their infancy to their parents, having very few legs when they are first hatched,\* at which period the young of *Julus sabulosus* have only three pairs, and seven or eight abdominal segments alone, but in four days they acquire four pair more with additional rings. The number of segments thus increasing with the age of the animals, renders a

\* De Geer's Mémoires, vol. vii. p. 583, pl. 36, f. 20, 21, and 22.

knowledge of the species difficult to acquire, and this is not diminished by the frequent moultings; it is therefore possible that some of the smaller species may be only the younger state of the larger ones, yet I cannot think but that all I have described are quite distinct.

The way in which these animals live amongst the roots of plants, renders it extremely difficult to destroy them, without sacrificing the infected crop; and their horny coats, which resist the point of a pin, being impervious to water, nothing, I should conceive, could be of much service but very great heat and hand-picking; unless, indeed, any dressing could be discovered which is disagreeable to them: whether lime would answer the purpose I have no means of ascertaining, but I am inclined to think it might, for I believe that they cannot endure heat, and I am certain they are not able to exist without humidity, for if confined in a box deprived of moist earth or damp moss they die in a few hours. The following remedies have been suggested by various writers.

Watering the land repeatedly with lime-water is believed to destroy the Millipedes, and soot spread over the surface will drive them away. Sprinkling nitrate of soda round the plants, and afterwards watering them, would, it is presumed, prove the best remedy, or watering the land with a solution of the nitrate would be equally beneficial, and more applicable to extensive crops; but this operation must be performed in a dull damp day, or in the morning or evening when the sun does not shine upon the field, otherwise it might scorch the leaves. Traps should also be resorted to, especially in gardens, where if loosely made baskets, such as strawberry pottles, were filled with damp moss, especially during dry weather, and sunk in the earth, the *Juli* would, in all probability, resort to them, and the baskets might easily be drawn out by the handles every morning, in order to examine their contents and kill the animals. In hand-picking, all large stones and clods should be turned over, as the Millipedes secrete themselves in such humid situations, and where these animals are abundant, large numbers, I expect, might be caught by strewing old cabbage-leaves over a field, in the same way as when slugs are troublesome, and employing children to turn them over and collect the Millipedes, &c. beneath.

#### *Summary of the foregoing Report.*

*Descriptions* of eight *Click-beetles* which inhabit corn-fields namely,

*Elater holosericeus*, the larva or Wireworm of which is unknown.

*Elater murinus*: it has not been ascertained whether the Wireworm of this beetle is injurious to the crops.

*Elater fulvipes*, its Wireworm lives in decaying trees.

*Elater sputator*, the Wireworm of this species is very abundant and injurious in meadows and pastures.

*Elater niger*, the Wireworm is said to live in rotten horse-dung.

*Elater marginatus*, the Wireworm of this beetle has not been discovered.

*Elater acuminatus*, the economy of this Wireworm is not known.

*Elater longicollis*, the Wireworm of this species has never been detected that I am aware of.

*Descriptions* and habits of the *Wireworms* of some of the above and other species of Click-beetles.

Some of Bouché's figures of the Wireworms appear to be inaccurately named, that of

*Elater niger* may be correct, but the larva of his

*Elater lineatus* is certainly the Wireworm of some other species.

His *Elater fulvipes* may be intended for that Wireworm, and that of his

*Elater fulvipennis*, inhabiting decayed timber, is probably correctly named.

*Elater fulvipes*, its larva described, but it is not injurious to the crops; it lives two years in decaying willow-trees.

*Elater murinus*, or *E. niger*, description of the supposed Wireworm of one of those species.

Probably none of the insects injurious to agriculture are free from *parasites* of the class Insecta.

The *Carabidæ*, eminently serviceable in the destruction of larvæ, worms, &c.; *Carabus glabratus* feeds upon the earthworm.

*Calosoma sycophanta* upon caterpillars.

*Carabus (Steropus) madidus* destroys and feeds upon the true Wireworms.

One of the true Wireworms of the "Striped Click-beetle," probably *Elater lineatus*, is inoculated with maggots, which produce *Ichneumons*.

The Click-beetles are infested with *vermin*, which belong to the *Class Arachnides*.

*Uropoda umbilica* is a Tick which attaches itself in considerable numbers to the Click-beetle, called *Elater obscurus*.

*Leptus Phalangii* is a Tick which infests the *Elater ruficaudis*, the red-tailed Click-beetle.

History of the *False Wireworms*.

The larva or maggot of the *Tipula oleracea*, one of the Crane-flies, is improperly called a Wireworm; it is very injurious to pasture-lands.

The maggot of another Crane-fly, probably *Tipula maculosa*, was abundant in a wheat-field, feeding upon the roots.

*Descriptions* of the *Snake* and other *Millipedes* which infest the roots of plants, and are improperly denominated Wireworms.



*Julus pulchellus* inhabits both fields and gardens, and is widely spread over England.

*Julus Londinensis* infests the roots of wheat in April.

*Julus terrestris* is found in rotten fruit, &c.

*Julus punctatus* inhabits moss on trees, and resides under stones.

*Julus latestriatus* : thousands infested a garden and greenhouse, destroying cabbages and potted plants.

*Julus pilosus* lives in cabbage-roots in March.

*Polydesmus complanatus* is said to be the most destructive species, eating the roots of wheat and destroying onions and garden-flowers.

*Snake-millipedes* feed upon animal as well as vegetable substances, such as snails and earth worms; and in addition to the plants already alluded to, potatoes, turnips, the entire tribe of cabbages, beans, peas, carrots, &c., suffer from their attacks.

When the *Snake-millipedes* walk they glide along, and curl themselves up spirally when at rest.

They live two years before they can procreate their species, and change their skins five times.

The females lay a great number of minute *eggs* in the earth, from Christmas to the middle of spring.

The *young* when first hatched have only *six legs*, which increase with age until they have from 150 to 240.

Application of artificial *heat* and *hand-picking* the most certain remedies.

They cannot live without *moisture*.

The application of *lime* probably would be serviceable where they abound, especially *lime-water*.

*Soot* spread over the land will drive them away.

Sowing *nitrate of soda*, or watering the crops with a solution, might destroy them.

*Dull damp days* the best for this operation, and never attempt it when the sun shines upon the crop.

*Baskets* filled with *damp moss*, and sunk in the earth, might be employed in gardens as traps to decoy them, especially during droughts.

They will be found *under clods* and *stones* in fields, pastures, &c.

*Old cabbage-leaves*, if strewed over fields, would *attract* them, where they are numerous and hand-picking is resorted to.

---

EXPLANATION OF PLATE J.

Fig. 31. *Elater holosericeus*.

\* The same magnified.

a\* The antenna or horn.

- Fig. 32. *Elater murinus*.  
 \* The same magnified.  
 b\* The antenna.
- Fig. 33. *Elater fulvipes*.  
 \* The same magnified.  
 c\* The antenna.
- Fig. 34. *Elater sputator*.  
 \* The same magnified.
- Fig. 35. *Elater niger*.  
 \* The same magnified.  
 d\* The antenna.
- Fig. 36. *Elater marginatus*.  
 \* The same magnified.  
 e\* The antenna.
- Fig. 38. *Elater longicollis* ♂.  
 \* The same magnified.  
 f\* The antenna.
- Fig. 39. Wireworm of *Elater fulvipes*?  
 g\* The head.  
 h\* The tail.
- Fig. 40. Wireworm of *Elater murinus*?  
 i\* The head.  
 k\* The tail.
- Fig. 41.\* Apical joint of the Wireworm of *Elater niger*?
- Fig. 42.\* do. do. called *Elater lineatus* by Bouché.
- Fig. 43.\* do. do. *Elater fulvipes*?
- Fig. 44.\* do. do. *Elater fulvipennis*.
- Fig. 45.\* *Steropus madidus* ♂.
- Fig. 46. Emaciated Wireworm of *Elater lineatus*?  
 p\* The pupa protruded.
- Fig. 47.\* The same pupa magnified.  
 l\* The head and eyes.  
 m\* The antennæ.  
 n\* The thorax.  
 o\* The feet.
- Fig. 48.\* *Elater lineatus*. The line shows the natural length.  
 r The tick with which it is infested.  
 q The natural size of the tick.
- Fig. 49.\* *Uropoda umbilicus*, removed from the Click-beetle.  
 s The cord by which the animal is attached.
- Fig. 50. *Elater ruficaudis*.  
 t The parasitic ticks, called *Leptus Phalangii*?
- Fig. 51.\* The same tick removed, and greatly magnified.
- Fig. 52.\* Larva of some *Tipula*?  
 v The natural size.  
 u\* The head in profile.  
 w\* Front view of the tail.
- Fig. 53.\* *Julus pulchellus*.  
 x The natural size and walking.

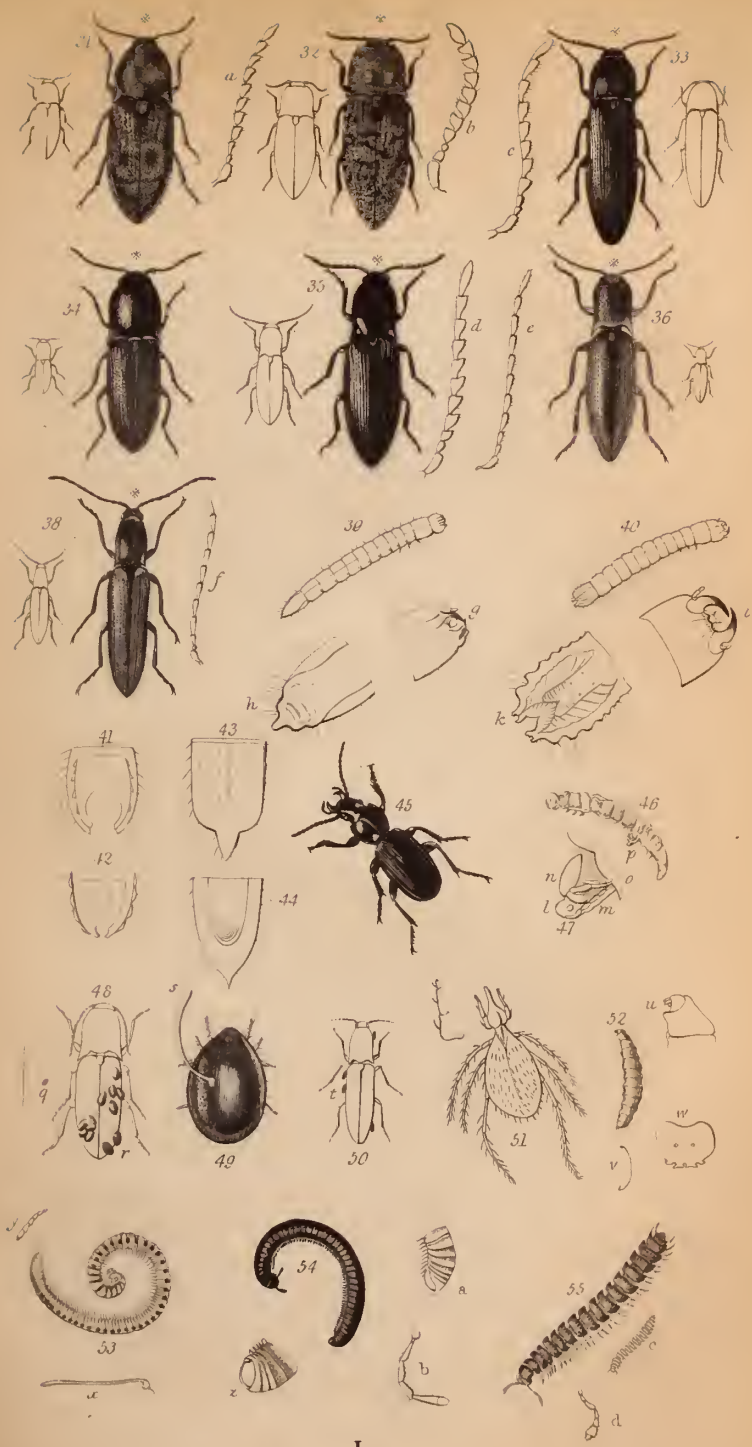



Fig. 54. *Julus Londinensis*.

z\* The unarmed tail.

a\* The armed tail of *Julus terrestris*.

b\* The antenna of the same species.

Fig. 55. *Polydesmus complanatus* when full grown.

c The younger state.

d\* The antenna magnified.

*Obs.*—All the figures are drawn from nature, and those numbers and letters with a \* attached indicate that the objects referred to are represented much larger than life.

London, March, 1844.

[The copyright of this Paper is reserved to the Writer.]

## XII.—On the Building of Cottages for Farm-Labourers.

By JOHN GREY.

IF the right construction of our barns, and stables, and cattle-sheds, is matter of no small importance, that of the dwellings of our labouring population must claim to be so in a still higher degree, seeing that it affects not only the health and comfort, but in a great measure also the moral character and well-being of that numerous and generally respectable class, on whose industry we are dependent for the success of all our exertions, and whose good or bad conduct and principles cannot fail to exercise a powerful influence on our own comfort, and on the moral atmosphere of society at large. I am too sensible of the truth and importance of this sentiment, and have had too much experience of the beneficial effects of reciprocal kindness and conciliation between masters and servants not to know that, setting inclination and duty aside altogether, it is the line of good policy to bestow care and consideration on all that relates to the comfort and happiness of the peasantry around us. It is to be regretted that, in building the cottages of farm-servants, the choice of a site is more frequently determined by the opportunity of occupying a piece of ground which would otherwise be of little account, or by the saving effected by making them form a side of a set of offices from which they would in all respects be better at a little distance, or some piece of ill-judged economy equally insignificant, instead of having regard to a dry and healthful spot, with an open and cheerful aspect. In advert- ing to this subject, I recognise with pleasure the importance attached to it in the institution of the Royal Agricultural Society of England, in whose charter it is stated to be one among many others of the objects contemplated in the formation of the Society,

“to promote the comfort and welfare of labourers, and to encourage the improved management of their cottages and gardens.” The first step towards this desirable end is to supply them with such cottages as afford the means of being kept in a state of comfort and cleanliness, to each of which a small garden should be attached, as well as other out-of-door conveniences. This first step is exclusively the landlord’s business, and it is to their manner of fulfilling the duties incumbent upon them in this respect that this paper entirely refers. It is unreasonable to look for health, comfort, and cleanliness, when a whole family is crowded into a low, damp, and dingy hut. Let them first be supplied with the means and opportunity, and then let them be blamed if they do not avail themselves of them for the purposes of their own improvement in these respects.

It is agreed on all hands, that to confine all the members of a family in a small dwelling, with only one apartment, without the means of dividing the young from the old, and the males from the females, must be at once destructive of comfort and most ininical to delicacy of mind and right moral feeling; and that, when fever and sickness attack the house, it is tantamount to condemning the whole family to undergo the painful course of its visitation. It has been often alleged that a second room is almost useless to poor people as a sleeping apartment, because they cannot afford to keep a fire in it, and being constantly without one, it becomes too cold and damp to be habitable. If it were absolutely necessary to have the second room on the ground-floor, this argument might seem to carry some weight with it; but even that is in great measure overturned by the simple fact, that all that is needful to preserve such an apartment from being damp, and to secure a moderately warm temperature, is to have the fire-place in the adjoining one so contrived as to be in the division wall between them, and at the back of that fire-place to build into the wall a cast-iron box to contain heated air, with a pipe through it to convey the air into the second room, the end of the pipe being secured by a small grating. This may also be easily applied to a room upstairs, by a trifling addition to the length of the pipe; but, in general, a room in an airy situation, being above another in which a fire is constantly kept, does not require such means of creating a dry and healthy atmosphere.\* The advantage of a second room upstairs over one on the ground-floor is obvious, from its superior dryness, and the greater seclusion which it affords to the female members of the family. Sufficient access to it is afforded by a good step-ladder placed against the end wall on one side, and closed in from view by thin deals on the other, which

---

\* I consider fire-places in every dwelling and sleeping-room essential on account of ventilation.—BRAYBROOKE.

comes much cheaper, and takes up less room than a passage with a brick partition (see plan No. 6). It forms no part of my plan at present to treat of the construction of those ornamental cottages in the shape of lodges or appurtenances to the family residence, upon which generally taste and expense are abundantly bestowed, but on the homelier dwellings of the farm-labourer, in the erection of which the great and most important object is to obtain the largest amount of comfort and accommodation at the smallest cost that is consistent with strength and durability in the building. Where many such dwellings are required, it will be prudent to build them of different sizes, for the accommodation of families more or less numerous; as the house which would be barely sufficient where there is a large family of children differing in age and sex would be in great measure wasted upon a widow or a married couple without children and with little furniture. This plan has been adopted by Earl Grey in building cottages on the estate of Howick, as are represented in plan No. 5. A considerable addition to the expense of these cottages above what was absolutely necessary has been made for the sake of appearance. I do not, therefore, refer to them so much with a view to their cheapness, as each of the smaller of them cost 6*l.* 10*s.* in materials and building, exclusive of cartage, as to show their neat appearance, and the plan upon which they are constructed. A garden is appropriated to each cottage, as is common throughout this county.

Plan No. 6 shows the plan of cottages which have been lately erected on the northern estates of the Greenwich Hospital under my care, and which affords the largest amount of accommodation at the smallest expense of any plan which I have been able to devise. If it is objected to as being on too large a scale, the same arrangement may still be adopted although the size may be abridged. But when it is remembered that the farm-servants or hinds of this country have each a cow, a garden, and a fatting-pig, requiring some room in the house for milk and utensils, and also that a very small saving of outlay at first may create perpetual inconvenience to the inhabitants, I think it will not be deemed extravagant. These houses are strongly built of freestone from a quarry on the estate. The walls are of common work, 2 feet thick; the coigns, window and door frames, dressed and jointed. The timber of the roofs, doors, and windows is of the best Memel wood; the inside doors and shelves are of American deal; and the upper flooring is of deals, planed and tongued by the patent mill. The ground-floors are of Aberdeen flags. The roofs are of the best Welch slate, and all the wood-work has had three coats of paint, the omission of which in new buildings is a great oversight. Each house is provided with a fire-range, consisting of



END ELEVATION.

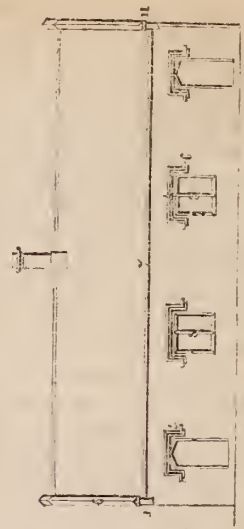

ELEVATION B.

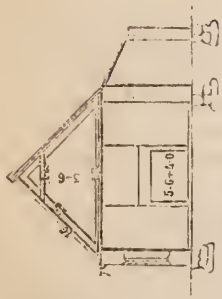

SECTION.

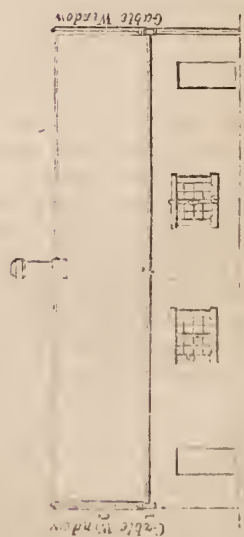

ELEVATION A.

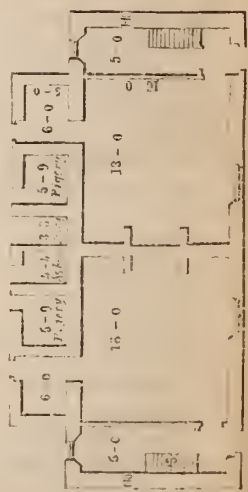

GROUND PLAN A and B.

SCALE OF FEET.





No. 5.

SMALL COTTAGES AT HOWICK.

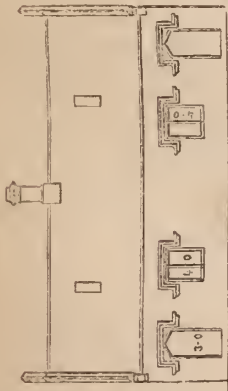

ELEVATION C.

COTTAGES AT HOWICK.

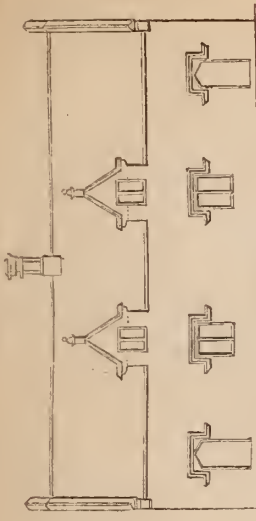

ELEVATION D.



SCALE OF FEET.

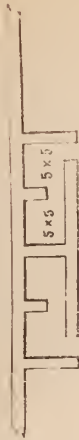

Piggery.

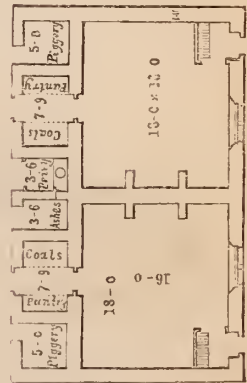

GROUND PLAN C.

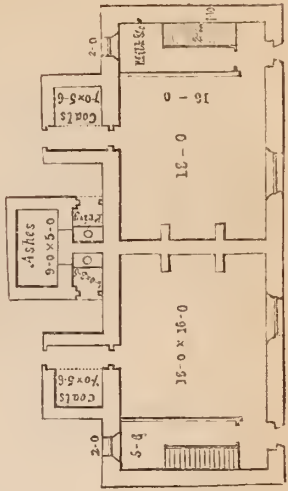

GROUND PLAN D.

No. 6.

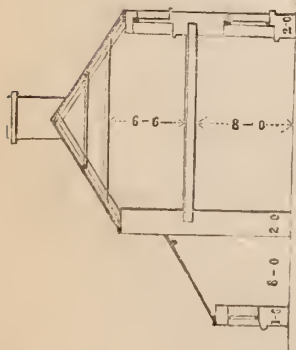

SECTION.

ELEVATION.

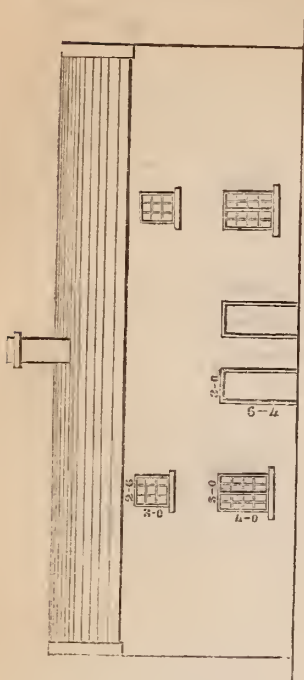

SCALE OF FEET.

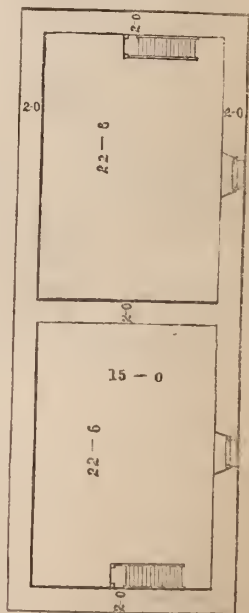

GROUND PLAN.

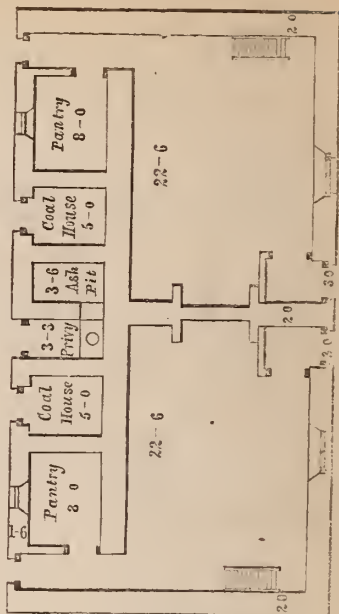

GROUND PLAN.

a grate with an oven on one side, and a pot on the other. They have also eave gutters of cast-iron, with pipes to carry the rain-water into barrels, one of which serves three houses. This is a desirable appendage to all buildings, but especially so to cottages; for while it gives a supply of soft water for washing clothes at the very door, it saves the wood-work of the doors and windows from the injury sustained by the rain from the roof being driven against them in high winds, and the walls from taking in wet at the foundations from the constant dropping against them from the eaves. The cost of each (exclusive of bringing the materials to the spot, which was done by the tenants) was 6*l.* 15*s.* 4*d.* As these houses stand in rows of six together, and two end or outside gables serve the six, they cost less than if only two or three were built together. And if some of smaller size are desired for the use of single persons or couples without children, each end house can easily be made into two, one below and the other above, by adding an outside stair and door, and doing away with the inside communication.

A house of one story, affording the same accommodation as those described, would cost, on account of the extra quantity of roof and wall, 86*l.* 13*s.* (see note), making a saving of 24*l.* 17*s.* 8*d.*, and giving at the same time the superior dryness and retirement of a sleeping room or rooms, for the upstairs apartment is large enough to allow of being divided if desired.

The cottagers' cow-houses and piggeries are conveniently placed in a yard at a little distance behind the dwelling-houses; the former hold six cows each, and the latter are single.

I am aware that in some publications on the subject an objection has been stated to building cottages in rows, and it has been recommended that they should stand singly, or at most only in pairs, in order that they may be sufficiently accessible to sun and air. I confess I do not enter into this view of the subject, although I entirely agree in deprecating the mode which has in some places been adopted of building cottages in squares with all the doors on the inside, thus having a show of cleanliness outwardly, but making the interior a receptacle of everything that is filthy and unwholesome; besides which, houses so situated are necessarily of a gloomy appearance, and want all the cheerfulness and variety which an open prospect affords. In the case of large farms or collieries, where a great number of cottages are required, the expense of building them singly or in pairs, occasioned by the extra quantity of outside walling, and of the approaches with their fences to each, the extent of ground over which they must be squandered, and the inconvenient distance at which some of them would be placed, are sufficient to condemn the plan, unless founded on proved and absolute necessity; a necessity which will hardly be

made out in the case of twenty or thirty cottages, with a southerly aspect and airy apartments, having ample sashes that open for the admission of air, and intervals between each group of six: when we consider that long streets of houses, less favourably situated in towns, are not found to be unwholesome, unless rendered so by something objectionable in their vicinity. In many situations, too, shelter from the wind is more desirable than exposure to it, and this is obtained in some degree by connecting a few houses together, whereas, by placing them separately, the intervals between are apt to create eddies or gusts of wind, which are in many respects inconvenient, and in exposed situations are destructive to the produce of a garden, if it be placed in the way of them.

NOTE.—Cost of each Cottage shown in plan No. 6, exclusive of  
*Cartage.*

	£.	s.	d.
Joiners' work and timber . . . . .	22	9	0
Masons' work and materials (quarried on the estate) . . . . .	19	2	0
Slating . . . . .	9	2	0
Plastering . . . . .	2	13	0
Glazing . . . . .	0	19	4
Painting doors, windows, &c. (three coats) . . . . .	3	10	0
Metal spouts and pipes, painting, and fixing . . . . .	3	4	0
Grate, pot, and oven . . . . .	0	16	0
	<hr/>		
	£61	15	4
	<hr/>		

The cost of each cottage, affording equal accommodation as the above, and at the same prices for work and materials, but all on the ground-floor, would be, without eave gutters, 80*l.* 5*s.*, and with them on both sides, like the others, 86*l.* 13*s.*, making a difference of 24*l.* 17*s.* 8*d.* in favour of cottages of two stories.

JOHN GREY.

*Dilston, 12th January, 1843.*

XIII.—*An Essay on Fat and Muscle.* By W. F. KARKEEK,  
Veterinary Surgeon, Truro.

PRIZE ESSAY.

1. THE object of this essay is to endeavour to explain “the causes which appear to determine the production of fat and muscle respectively, according to the present state of our knowledge of animal physiology.” Formerly, the study of the uses and functions of the different organs, and of their mutual connexion in the animal body, was the chief object of physiological researches; but although these yielded the most valuable results in relation to the recognition of dissimilar forms and conditions to be found in healthy and diseased structures, yet they afforded no conclusions calculated to give us a more extensive insight into “the essence of the vital processes.” The recent alliance of chemistry with physiology has furnished most valuable data both in this respect and as regards the nutritiveness of particular vegetables in the feeding of our domesticated animals. The most important discoveries in this branch of science are those of Professor Liebig, he being admitted, by the unanimous voice of European chemists, to be the first living authority on Organic Chemistry. Professor Playfair was the first English chemist who attempted to apply those discoveries to the practical purposes of the farmer—holding up the torch of science, as it were, to the agriculturists, and teaching them the advantages to be derived from the union of practice with science.\* It will be seen, in the course of this essay, that we have adopted many of the physiological views of Professor Liebig; and if we have succeeded in adding but one useful fact to the mass of knowledge already acquired, which may be advantageously put into practice in the ordinary operations of a farm, our object will be sufficiently realised.

2. Your attention will first be directed to some of the phenomena connected with *nutrition* and *growth*. When we consider that the food of vegetables and animals is either altogether different from their substance, or passes before being assimilated into a new form, we must admit that the nutrition and growth of both depend on chemical agencies, although these operate under peculiar conditions, and are influenced by the unknown force which is called the *vis vitæ*, or *vitality*, so as to produce results that cannot be imitated by the chemist. The food of vegetables is derived from the crude and simple materials which they absorb from the *air*, the *earth*, and the *waters*. These, after being con-

---

\* Playfair's Lectures before the Members of the Royal Agricultural Society, December, 1842.

verted by the powers of vegetable assimilation into the substance of the plant, acquire the characteristic properties of organised products. Hence, plants can grow at the expense of the elements around, where no living substance ever previously existed; whilst animals, on the contrary, can only exist upon matters previously organised either by plants or other animals. In their well-marked forms, no two things can be conceived to offer a stronger contrast than these two great divisions of organised beings, yet the naturalist cannot determine, in the animated chain, where the one ends or the other begins; nor can the chemist detect, by his analyses, any greater differences in their constituent parts.

Thus, on the analyses of hay, oats, beans, beef, and potatoes, they are found to be composed of the same *ultimate elements*, differing only in their relative proportions:—

	Hay. Boussingault.	Oats. Boussingault.	Beans. Playfair.	Dried Beef. Playfair.	Potatoes. Boussingault.
Carbon....	33·47	41·57	38·24	51·82	12·30
Hydrogen..	4·20	5·25	5·84	7·57	1·74
Oxygen ...	32·51	30·10	33·10	21·37	12·04
Nitrogen...	1·26	1·80	5·00	15·01	0·32
Ashes.....	7·56	3·28	3·71	4·23	1·40
Water ....	16·00	18·00	14·11	*	72·20

\* Out of 100 lbs. of beef muscle there is about 77 per cent. of water, by weight, and 23 lbs. of dry matter.

These elements are not very numerous, the principal of them being carbon, oxygen, hydrogen, azote or nitrogen, sulphur, phosphorus, together with a few of the alkaline, earthy, and metallic bases. A brief knowledge of a few of these elements will be found indispensable to be able properly to understand the subject of this essay.

3. *Carbon* forms from 40 to 50 per cent., by weight, of all plants in a dried state, which are cultivated for the food of animals. This substance is better known under the name of charcoal.

*Oxygen* is only found in a gaseous form, and exists in the atmosphere to the amount of 21 per cent. of its bulk: hence it is necessary to respiration, and no animal can live in an atmosphere which does not contain a certain portion of uncombined oxygen. In respiration it disappears, as will be explained by and bye. It exists also in water—every 9 lbs. of this liquid containing 8 lbs. of oxygen; and it forms about one-half, by weight, of the bodies of all living animals and plants. Indeed, it may be said that it forms one-half of the weight of every solid substance we see around us—of the solid rocks which compose the crust of the

globe, of the soils which we cultivate, and of all that live and breathe thereon.

*Hydrogen* is the next elementary body. It also exists in the state of gas, and is the lightest of all known substances. In combination with oxygen, it forms water, being about one-ninth of its weight; and it also forms a small per centage of the food of animals, which, combining with oxygen in the living organism, assists to produce animal heat (8).

*Nitrogen*, sometimes called *azote*, is also known only in the form of gas. It exists in the atmosphere to the amount of 79 per cent. of its bulk: hence it is an essential constituent of the air we breathe—serving, as chemists believe, only to dilute the oxygen; but it is more probable that it serves some necessary purpose in the economy of animals, the exact nature of which has not been discovered. All parts of the body of an animal, which have a decided shape, contain nitrogen: hence it may be supposed to perform certain most important functions, in reference both to the growth of plants as well as animals; for the most convincing experiments and observations have proved that the animal body is incapable of producing an elementary body such as nitrogen out of substances which do not contain it; and it obviously follows that all kinds of food fit for the production either of blood, cellular tissue, membranes, skin, or muscular fibre, must contain a certain amount of nitrogen.

4. The union of those elements, according to certain laws, in various ways, forms what are called the *proximate elements* of nutrition.

These have been divided, for the sake of distinction, into two groups—the *azotised* and *non-azotised*—the former being properly designated the *elements of nutrition*, and the latter the *elements of fat and respiration*. The following analyses of several of these bodies will enable the reader to comprehend the nature of this distinction:—

100 parts of—	Elements of Nutrition.				Elements of Respiration.			
	Vegetable Fibrine from Wheat. Boussingault.	Vegetable Albumen Mulder.	Vegetable Casein. Jones.	Ox Blood. Playfair.	Mutton Fat. Chevreul.	Potato Starch. Berzelius.	Gum. Berzelius.	Sugar of Milk. Liebig.
Carbon..	54.2	59.99	54.138	51.35	78.996	44.250	42.682	40.01
Hydrogen	7.5	6.87	7.156	7.50	11.700	6.674	6.374	6.73
Nitrogen.	13.9	15.66	15.672	15.76	..	..	..	..
Oxygen .	24.1	22.48	23.034	22.39	9.304	49.076	50.944	53.27

Thus, in the azotised group we have *four* of the ultimate elements, whilst in the non-azotised we have only *three*, the presence or absence of the nitrogen constituting the difference. This distinction is a very important one, and must be kept steadily in view. The former is only susceptible of being applied to the nutrition and renovation of the tissues (2), whilst the non-azotised substances are destined either to undergo important changes within the body, or to be thrown off from it again, without even forming a part of its organised structure. In reference to this, the distinction between the organisation of a substance, and the simple deposition of it in the midst of an organised tissue, must not be lost sight of; for the fatty matters which are derived from plants, and become deposited in different parts of the animal body, cannot be regarded as ever becoming organised. Till very recently, it was believed that vegetable albumen, fibrine, and caseine, differed from animal albumen, fibrine, and caseine; but the researches of Mulder have shown that this opinion was erroneous, and Liebig has proved that caseine exists in vegetables, with all the characters of that found in milk. Mulder has also shown that vegetable albumen, fibrine, and caseine, are all nothing more than the modification of one compound, to which he has given the name of *proteine*, as being the original matter from which all those varieties are derived. *Vegetable fibrine* is a gelatinous substance of a green tinge, produced from the newly-expressed juices of peas, beans, carrots, turnips, beet-root, &c. *Vegetable albumen* is found in many vegetables and seeds, such as cauliflowers, asparagus, swede turnips, nuts, almonds, &c. When the clarified juices of those substances are made to boil, a coagulum is formed very similar to the serum of blood, or the white of an egg,—this is vegetable albumen, which may be considered as the true starting-point of all the animal tissues, as is evident from the phenomena of incubation, where all the tissues are derived from the white and yolk of the egg (which also contains albumen), with the aid only of the air, of the oily matter of the yolk, and of a certain proportion of iron found in the yolk. It is clear from this that albumen may pass into fibrine, caseine, membranes, horn, hair, feathers, &c. *Vegetable caseine* is found chiefly in the seeds of peas, beans, and of other similar leguminous plants; and is identical with the caseine of milk, which is cheese. It differs from the two former modifications of *proteine* in that it does not coagulate spontaneously like fibrine, nor by heat like albumen, but by the action of acids only.

5. The following table, compiled from one of Professor Johnston's (being the analyses of Boussingault, Sprengel, and Dumas), will give the reader a tolerably just idea of the proportions of



those *proximate principles* as they are found to exist in many of the cultivated crops of the farmer :—

100 Parts of	Water.	Husk, or Woody Fibre.	Starch, Gum, and Sugar.	Gluten, Albumen, and Caseine.	Fatty Matter.	Saline Matter.
Field Beans . . . . .	16·0	10·0	40·0	28·0	2·0	3·0
Peas . . . . .	13·0	8·0	50·0	24 0	2·8	2·8
Barley . . . . .	15·0	15·0	60·0	12·0	2·5	2·0
Oats . . . . .	16·0	20·0	50·0	11·5	5·6	3·5
Meadow Hay . . . . .	14 0	30·0	40·0	7·1	2 to 5	5 to 10
Clover Hay . . . . .	14·0	25·0	40·0	9·3	3·0	9·0
Potatoes . . . . .	75·0	5·0	12·0	2·25	0·3	0·8 to 1
Carrots . . . . .	85·0	3·0	10·0	2·0	0·4	1·0
Turnips . . . . .	85·0	3·0	10·0	1·2	..	0·8 to 1
Wheat Straw . . . . .	12 to 15	50·0	30·0	1 3	0·5	5·0
Oat Straw . . . . .	12·0	45·0	35·0	1·3	0·8	6·0

Notwithstanding the imperfections of this department of science, great importance has been attached to these proximate analyses. We believe that the proportions laid down in this table are, with the exception of the fatty matters, tolerably correct, and that they will prove serviceable by enabling us to trace the sources from which are derived particular organic compounds essential to nutrition, and to the continuance of life or of certain elements which become assimilated in organic structure. Thus the proportion of starch, gum, and sugar contained in any separate article of food will enable us to form a rough approximation as to the percentage of *fat or tallow* which it is capable of yielding, and the number representing the *gluten, albumen, and caseine* in the same article of food will give us a very correct indication of its muscle, or flesh-forming principle.

6. But before we can comprehend the manner in which these changes are effected in the living organism, we must first make ourselves acquainted with some of the laws, vital and chemical, which regulate the metamorphoses of those materials, and the interchange of atoms occurring between the blood and the structures in the process of nutrition. Accordingly, we will first direct your attention to the process by which the aliment is received into the bodies of animals, and prepared to form a part of their fabric. When the food has entered the stomach, the gastric juice is poured out, and the whole is converted into a pulpy mass termed *chyme*. The process by which this step in the assimilation of the food is produced, constitutes what is commonly called *digestion*. The next step occurs in the intestinal canal, where the chyme is united with the biliary and pancreatic secretions, when it becomes converted into *chyle*. Brande found no essential difference in the chyle of gramivorous and carnivorous

animals. Dr. Marcet imagines that the former is less abundant in albumen than the latter, and Liebig informs us that all the compounds of proteine, absorbed during the passage of the chyme through the intestines, take the form of albumen. The chyle is absorbed from the inner surface of the intestines by a set of vessels termed *lacteals*, which commence by very minute orifices in incalculable numbers, and unite successively into larger and larger vessels till they form trunks of considerable size, which empty their contents into a *receptacle* for that purpose, forming the entrance of the *thoracic duct*. In this receptacle, other absorbent vessels termed *lymphatics* also terminate, and empty their contents. The fluid they convey is of nearly the same character as that brought by the lacteals. Almost every part of the body is in continual decay, so that we may justly say that death and decay are constantly going on in every living body, and are essential to the activity of its functions—a quantity of organised matter being continually removed, and replaced by that which is newly formed. Of this, a portion is doubtless unfit to be retained within the body, and is cast out by the various processes of *excretion*; but it appears that another portion of it may again be made use of, and is, in fact, taken up by the lymphatics, and brought to the central receptacle to be mixed with the newly absorbed chyle: so that an animal may be said in a certain sense to live upon its own flesh. The *chyle and lymph* thus mixed together flow into the thoracic duct, by which they are conducted into a large vein—the *jugular*—and together are sent by a direct and short course to the lungs.

7. The changes which result from the passing of the blood through the lungs form a very important part of the process of nutrition. The blood, the newly formed as well as that which has been returned by the circulation, after repairing and renovating the tissues, here comes in contact with the atmospheric air, which is principally composed of two gases, oxygen and nitrogen, in the proportion of 21 parts of the former and 79 of the latter, besides the watery vapour with which the atmosphere is always charged more or less; and a change immediately takes place, from the dark purple hue which the blood has when it is brought to the lungs, to a bright vermilion colour. When the air has produced this effect, it is found that a certain proportion of oxygen which it had contained has disappeared, and that the place of the oxygen is almost wholly supplied by an addition of carbonic acid gas, together with a quantity of watery vapour. With regard to the nitrogen of the atmosphere, Liebig says it is applied to no use in the animal economy except diluting the oxygen; whilst other chemists, Mulder for instance, affirm that nitrogen is both absorbed and exhaled by the blood in respiration. The question next arises, what becomes of the oxygen which dis-

appears in respiration, and what is the origin of the carbonic acid gas? The blood consists of the same elements as the food which the animal consumes, containing, as we have seen (4), a very large proportion of carbon and hydrogen; and as carbonic acid gas consists of oxygen and carbon, it is evidently the result of the combination of the oxygen with the carbon of the food. According to Boussingault, "a horse consumes in this manner in twenty-four hours  $97\frac{1}{8}$  oz. of carbon, and a milch cow  $69\frac{9}{16}$  oz.; and the former requires to convert the carbon into carbonic acid 13 lbs.  $3\frac{1}{2}$  oz. of oxygen, and the milch cow 11 lbs.  $10\frac{3}{4}$  oz. in the same time."

8. In whatever way carbon may combine with oxygen, the act of combination cannot take place without the disengagement of heat. There exists in the living body no other known source of heat but the chemical action between the elements of the food and the oxygen of atmosphere, and it signifies nothing what intermediate changes (6) the food undergoes in becoming assimilated to organised tissues, or in its passage through the liver in the formation of bile; the last change is uniformly the combustion of the carbon and hydrogen, and the production of carbonic acid, watery vapour, and animal heat. No part of the oxygen taken into the system is given out again in any other form than that of a compound of carbon and hydrogen; and as these substances are supplied in the food, it is clear that the amount of nourishment required for any animal will be proportionate to the quantity of oxygen taken into the system.

9. There are two causes which chiefly contribute to increase the consumption of oxygen gas; these are TEMPERATURE and EXERCISE. We will proceed to consider the effect of these in the living organism by a few examples from the farmer's every-day practice. In the winter, the air is more condensed than in the summer, consequently the same volume of air in the winter contains a larger per centage of oxygen than in the warm weather, when it is more rarified. It is for this reason that a larger supply of food is consumed by persons living in cold countries than by those who are inhabitants of hot climates. We thus perceive an explanation of the apparently anomalous habits of different nations. The maccaroni of the Italian and the train-oil of the Greenlander are not adventitious freaks of taste, but necessary articles fitted to administer to their comforts in the different climates in which they have been born.

*Example No. 1.*—A flock of Leicester sheep on tolerably good keep will increase in weight throughout the year about 52 lbs. of mutton for each sheep, but this accumulation takes place chiefly during the spring and summer months, for during the cold weather it requires all the farmer's supplies of food to keep them at the

same weight. Should the cold prove very intense, and supplies of carbon and hydrogen in the form of food be not at hand, the store of fat which the animals have been accumulating in the mild seasons will be soon made use of to keep up the animal temperature.

*Example No. 2.*—“ One hundred sheep were folded by tens in pens, each of which was 22 feet in length by 10 feet in breadth, and possessed a covered shed attached to it: they were kept there from the 10th of October to the 10th of March. Each sheep consumed on an average 20 lbs. of swedes daily. Another hundred were folded in similar pens, but without sheds, during the same time, and their daily consumption of swedes amounted to 25 lbs. each. The sequel was, that those sheep which enjoyed the protection of the covered sheds had increased 3 lb. each more than those left unprotected, although the latter had consumed one-fifth more food.”\*

*Example No. 3.*—In the mountainous districts of Scotland, the necessity of artificial shelter for sheep has long been acknowledged—for, when the stormy season sets in, there is a necessity of feeding the sheep with hay, both morning and evening, the quantity of the fodder necessary being generally proportionate to the degree of cold.

10. Rest also, as well as the necessary protection from cold, is an equivalent for food. The consumption of oxygen in a given time may be expressed by the number of respirations; it is therefore obvious that in the same animal the quantity of nourishment required must vary with the force and number of respirations, and as the number of respirations is fewer in a state of *rest* than during labour or exercise, the quantity of food necessary in both instances must be in the same ratio. This can also be exemplified by the farmer's daily practice, since he is very well aware that the quieter an animal is kept when feeding, the quicker it fattens.

*Example No. 1.*—It is uniformly found that a stall-fed cow in the summer will yield considerably more butter and milk than one fed in the field with a greater supply of food. The reason is obvious; absence of oxygen prevents the inspiring of so large an amount of oxygen as would take place in the open air.

*Example No. 2.*—In the rearing of calves for veal in Holland, it is usual to confine them in suckling houses or pens, so narrow that the animal cannot turn round. The calf is fed through an opening in the doorway, just large enough to allow the head of the calf to be thrust out: as soon as he is fed, the opening is closed, and the animal is kept in total darkness. In this manner,

---

\* See Journal Royal Agric. Soc., vol. iv. p. 222. Professor Playfair's Lectures.

it is found that calves get fat in a considerably shorter period than if allowed to move freely about in an open stall.

*Example No. 3.*—Again, in the suckling of house-lambs of the early Dorsetshire breed for the London markets, the dams are fed with hay, oil-cake, and cabbage in an enclosure adjoining the apartments where the lambs are confined. The lambs are excluded from the light, except at the intervals when the shepherd suckles them upon the ewes. Some feeders confine their lambs in narrow separate stalls to prevent them from playing with one another, but others deem the exclusion of light and the absence of motion and noise sufficient for this purpose. By these means, they speedily fatten, and their flesh becomes exceedingly white and delicate.

11. This brings us to that very important part of our Essay, the PRODUCTION OF FAT. We have seen from the examples just adduced, that, under certain circumstances, *viz.* the absence of exercise and cold, and the presence of a proper supply of food, herbivorous animals speedily become fat. By reference to the table containing the relative proportions of nutritious matter in the ordinary cultivated crops of the farmer (5), it will be seen that the proportion of beef-suet which exists in wheat or barley, straw and turnips, is exceedingly small; indeed the turnip does not contain any; and yet animals under such a diet will speedily fatten. The fat then is the product of a peculiar digestive process on the unazotised constituents of the food, and is formed in consequence of a want of due proportion between the food taken into the stomach and the oxygen absorbed by the skin and lungs. The chief source of fat is starch and sugar, and its composition is such, that if deprived of oxygen, fat remains. “Thus, if from starch C 12, H 10, O 10, we take 9 at oxygen, there remains C 12, H 10, O, which is one of the empirical formulæ for fat.” It is obvious from this that Liebig’s theory is the right one, and that fat can only be formed by a process of deoxidation. He regards fat as an abnormal condition, since wild animals, such as the hare, the roe, and the deer, never produce any—the exercise which they continually undergo preventing its formation; besides, they never eat except when hunger requires it, while the sheep and the ox eat almost without intermission, and when young, they convert into fat and organised tissue all the nutritious parts of their food beyond the quantity required for supplying the respiratory process and the waste of the system; so that they soon become plump and fleshy.

12. Want of exercise then and diminished cooling are equivalent to a deficient supply of oxygen, for when these circumstances occur, the animal absorbs much less oxygen than is required to convert into carbonic acid the carbon of the substances destined

for that purpose. We have a beautiful example of this in "the conditioning of the hunter," which consists in giving such exercise and food as will, without reducing the strength of the animal, prevent the formation of superfluous flesh and fat. *Air, exercise,* and a proper supply of nitrogenised food, such as oats, peas, beans, &c., contain the grand secret in the art of training. But these articles also contain a large proportion of starch and fatty matters, and yet, when in proper condition, the hunter never becomes fat; and the reason is, that these substances, by the constant exercise which is given, are consumed in the lungs, whilst under different circumstances, the same horse with little exercise and little oats, being fed chiefly with straw, hay, and turnips—articles that do not contain a quarter part of the fattening principle of food contained in the hunter's diet—would be found plump and fat. Here we have the normal and abnormal conditions compared together, as they regard the capability of horses to undergo fatigue, since the well-conditioned hunter is capable of undergoing great exertion with very little fatigue—whilst the frothy lather with which the non-conditioned horse is covered after very little exertion, evinces undeniable inferiority.

13. From what has been stated then, we may safely conclude that fat is chiefly produced from the starchy matters contained in the food of animals, all the excess of which, that is not consumed in producing animal heat, is taken back into the circulation and deposited, in the form of fat, in cells appropriated for that purpose. It would appear also that the blood-vessels have the power of taking back the fatty matter again into the circulation, when it is required; so that one of the objects which this deposition fulfils is to store up, when nourishment is abundant, a supply which may be taken back into the system, and made use of in time of need.

14. These accumulations are found in different parts of the bodies of animals of the same kind, some breeds of cattle being disposed to carry fat externally, and others internally, whilst in others it is mixed in the muscle, forming what is commonly called a proper mixture of fat and lean. In the races of cattle disposed to carry fat externally, the African ox, with a large fatty hump on his shoulder, and the mild zebu of India, with an immense lump of fat on his neck and rump, are striking examples. Among sheep we have many instances of accumulations of external fat. Throughout Arabia and Syria, the countries over which the patriarchal shepherds roamed, the breeds, which are two, are characterised by immense accumulations of fat on their rumps and tails. In one breed, we have an accumulation on the tail, averaging from 14 lbs. to 18 lbs., whilst the dead weight of one of these sheep will not amount to more than 50 lbs. or 60 lbs. The Cape sheep are also of the broad fat-tailed kind. These

animals have little or no internal fat, it being chiefly collected on their rumps and tails. Climate must have some influence in producing these characteristics, since the very women are distinguished at the Cape for their prodigious fatty rumps. In our own country, examples of external fat are particularly seen in the once-famed Dishley breed of cattle, which have an accumulation of fat spreading itself over the rump. There appears a tendency of the fatty tissue to remain separate from the muscle, in the improved long-horned breed, the fat mingling less with the lean than in any other of our native breeds. The Hereford breed have also a similar tendency, but not nearly in so great a degree. In the Jersey breed of cattle, we have an example of accumulations of loose fat in the inside. This peculiarity is common to all good milching breeds, more or less, for they all turn out well when well fed, in the "fifth quarter." Some French and Spanish cattle imported into Cornwall in the summer of 1842, when killed, showed an immense accumulation of internal fat; they were also particularly lean and coarse-looking animals. In the improved Devons, the fat and muscle are generally well mixed, whilst in the common coarse breed of the Devon kind, we have plenty of inside tallow. The short horns carry more inside fat in proportion to their size than the improved Devons; they are also better milkers. From these examples we may safely infer that the better the milking qualities of the breed are, the more likely is that breed inclined to carry inside fat.

15. As we proceed with our subject, it will be found that some of those characteristics are in great measure dependent on internal organisation, and accordingly experience has proved that animals possessing small lungs, small livers, and small spleens, indeed "small offal" of every description, have a greater disposition to fatten and to lay that fat on the proper places, which we consider to be a fair proportion of fat and lean, than coarse-bred ill-proportioned animals, which will be found to possess larger offal than well bred animals in proportion to their size and growth. We can clearly understand the reason of this, since we now know that the less quantity of oxygen an animal consumes, the fatter it becomes; for small lungs cannot decarbonize as much blood as large lungs, nor can a small liver secrete as much bile as a large liver, bile being formed in the herbivora from the non-nitrogenised materials of their food; hence a larger quantity of carbon is used in the production of fat. Many physiologists conceive that the secretion of bile is by no means the sole function performed by the liver, and look upon it as a supplementary organ of the lungs, assisting that organ in the depuration of the blood, and like it eliminating from the blood its superfluous hydrogen and carbon. The same will apply also to the spleen, its functions being, we

believe, also subsidiary to the lungs as a purifier of the blood. It is a very common occurrence to find stall-fed animals with diseased livers, and yet this does not interfere with the power of accumulating fat; on the contrary, if our theory be correct, it must materially assist in accelerating this process. We have witnessed the same in the livers of horses in many instances—the animals will continue to do fair ordinary work in either coaching or posting, and always look healthy, when, should they be attacked with some prevailing epidemic or a severe catarrhal affection, the veterinary practitioner, if he be a young one, will be surprised to find that the remedies which in similar cases had proved successful, should fail here; and he does not get at the truth until a *post-mortem* examination reveals to him that there are extensive lesions of the structure of the liver, it having the same appearance as if it had been boiled.

16. Professor Playfair was the first who directed the public attention to the fact just related, that an animal having small offal was more disposed to fatten, and to come quicker to maturity, than an animal with large lungs, livers, &c. We believe we are correct in stating that this discovery was never brought before the public until he delivered his two lectures before the Royal Agricultural Society on December 27, 1842; and it was in consequence of some inquiries which we made to ascertain the truth of the Professor's statement, that we also became acquainted with another singular and important fact—that *in proportion as an animal fattened, so in proportion did the organs which are chiefly connected with nutrition become diminished in size.* This fact we shall find to be intimately connected with the *breeding, rearing, and feeding of animals.* We draw our conclusions from examining a great number of stall-fed animals, chiefly of the Devon breed, averaging from 5 cwt. to 9 cwt. of meat. We have seen them slaughtered at all stages of feeding—from the comparatively lean to the fatted ox—and the result of our observations has been, that in proportion as the fattening process went on, the lungs, stomachs, intestines, liver, &c., were reducing in size. It has already been stated (6) that a constant change of particles is going on in the tissues of the living body; and it has been computed by physiologists that the human body, including the skeleton, is taken down and rebuilt about every seven years; so that we may safely say that it is being taken down and rebuilt at the same time; and that the processes of destruction and renovation, absorption and nutrition, are always being carried on concomitantly. Now, within certain limits it is observed that the greater the waste, the greater is the supply—as by constant exercise the muscles are increased instead of decreased, so that the effect of nutrition is not only to replace what was destroyed, but



to supply a certain quantity more. And again, by the same law, an organ that was originally intended to perform a certain function, if that function be not fulfilled, will diminish in size and power. In the muscular arm of a blacksmith, and the delicate arm of a person not accustomed to labour, we have an excellent example. Now, whatever is true of the external parts is likewise true of the internal parts of the body. If we take for an example the heart of a calf, which must increase in size as it increases in growth—it increases, not only in its whole bulk, but also in the size of the cavities. If an addition were made only to the exterior of the heart, its whole bulk would be increased, but the size of the cavities would be proportionately small. We must therefore assume that substance is removed from the interior of the heart, at the same time, though perhaps not exactly in the same quantity, that substance is added to the exterior. In like manner, when the heart of a man diminishes in size, as it does in consumption, materials must be abstracted from the exterior, and added in rather a less proportion to the interior. It is upon this principle that in proportion as animals fatten, particularly stall-fed ones, their internal organs become smaller—the lungs adapt their size to the volume of oxygen consumed, and the liver becomes smaller as the secretion of bile is diminished; the kidneys, stomach and intestines are also considerably smaller in extremely fat animals than in lean ones of the same age and breed. In the intestines this is particularly observable—the circumference of the tripe is considerably reduced, but it is thicker and richer. This change appears to take place more rapidly during the latter stages of fattening; and it is rather a remarkable coincidence that the fatter an animal becomes at this period, the less food it consumes. When the animal arrives at this last stage of fattening, the arterial action is much slower than before—a sluggish action appears to prevail throughout the whole vascular system, and the arterial exhalants appear to be engaged chiefly in manufacturing fat. If the animal be bled at this time, which is usually the case on the evening previous to its being slaughtered, very little blood can be drawn before it faints.

17. The breeder may learn a very important lesson from these remarks; for if it be true (*and time and observation will prove them to be so*) that in proportion as an animal increases in fat will the organs of nutrition become diminished in size, it follows that, by pursuing the system of breeding from fatted animals, or from those having a great tendency to fatten, *function* must react on *organization*, and at last those qualities become, not only increased, but fixed in the race. By *function* reacting on *organization*, is meant—when an organ, as the lungs, for instance, becomes diminished in consequence of not performing its natural

function, and the disposition to accumulate fat is thereby produced—the diminished structure is very likely to be reproduced in the progeny of an animal so affected: hence *the reaction*; and if the same system be pursued, particularly in breeding from the nearest affinities, this effect will be more speedily produced. It is in this manner that the greatest improvements have been made in our native breeds from time to time—in the short-horns and improved long-horns—in the improved Herefords and Devons. The history of those different breeds sufficiently proves this. The dam of Hubback, the sire of the short-horned race, became so fat that she soon ceased to breed; and her son, having the same tendency, was useful as a bull but for a very short period. This was also the case with Bolingbroke, and several of Mr. Colling's best bulls. The two cows of Mr. Tomkins, *Mottle* and *Pigeon*, the originators of the improved Herefords, were selected in consequence of their extraordinary tendency to become fat; and the whole secret of Bakewell, as to the method which he pursued to establish the long-horned cattle and the new Leicester sheep, lay here.

18. There is a delicacy of form and a refinement of tone which characterize animals bred in this manner, and they acquire early maturity; their bone and muscle are more quickly developed, and are soon ripe, because they sooner become old. In a wild state, and without reference to the wants of man, we should consider these qualities as a progress towards deterioration; and so they are, since the animals suffer by the exchange—but man gains an improvement. It will be shown, however, before we conclude, that by carrying this system of breeding too far, in many instances man also has become a very considerable loser (21, 22). The very opposite system to this has been established in the *breeding of the racehorse*; and, accordingly, there have been produced opposite results. The object being here to develop a structure capable of great speed with the powers of endurance: to attain these qualities, animals were selected with large lungs; and the system pursued in training them has tended to develop a still more powerful structure of those organs. The object in training the racehorse is to increase what is commonly called the *wind*; and the regular gallops, which are given for this purpose, increase the power of the lungs; and the breathing becomes accordingly freer and deeper, and the capability of exertion is increased. We have an example here also of the effect of function reacting on organisation—for the constant breeding of animals in this manner (other objects of course being attended to) would to a certainty develop those desirable qualities in a greater degree than was possessed by the founders of the race. It is no argument to the contrary that the present race of

horses on the turf are not capable of running such long distances and carrying such heavy weights as the *olden racers* were—since the system adopted in rearing, training and racing, has been very considerably altered within the last half century. Our blood stock were formerly shorter in the leg, and more compact and muscular animals, seldom running until four years old, and frequently not until *five years*. But now they run at *two years old*, carrying light weights, and running short distances, where bottom and stoutness are not so necessary; and it is this difference in the style of racing which has altered their former character.

19. There are certain *external signs or tokens* which are used as indications of early maturity, and of the determination of the animal frame to produce fat or muscle in an eminent degree. We will proceed to consider some of them. The first token which a grazier will make use of, for the purpose of ascertaining the feeding properties of an ox, is technically called *the touch*—a criterion second to none, inasmuch as a thick, hard, unyielding hide indicates a bad feeder, and an unprofitable animal. A thin papery-feeling hide, covered with thin hair, indicates the very reverse of the former, as such an animal will speedily fatten, but will not carry much muscle; at the same time it indicates a delicate constitution. This quality is produced in animals by great refinement in breeding, and especially by breeding from animals near of blood: in doing so, we should remember that we are deviating from the natural characters, in a point connected with hardness of constitution. The perfect touch in a feeding animal will be found with a thick loose skin, floating as it were on a layer of soft fat, yielding to the least pressure, and springing back to the touch of the finger, like a piece of thick chamois-leather. This token indicates hardness of constitution and capability of carrying plenty of muscle, as well as a sufficiency of fat. The physiological history of these tokens is as follows:—The cutis, or true skin, is that portion of the external integuments from which leather is manufactured; and is much more dense and elastic in some breeds than in others. Its external surface lies in contact with a layer of cellular tissue which intervenes between it and the muscle. This cellular tissue contains a larger or smaller amount of fat cells; and the mellow feel which is found in some animals arises from the resiliency or springing back of the cellular tissue in which the fat is deposited on being touched. Where there is much “mellowness” in a lean animal, it arises from the free circulation of the blood-vessels through the meshwork; and where there is a hard feel, it arises from the cellular membrane participating in the hardness of the hide, and therefore being less capable of dilation by the interstitial deposit.

*Smallness of bone* is another indication of early maturity, since it must be evident that a breed of animals that will attain their full size of bone at an early age will be a much more profitable breed to the grazier than one of slower growth.

The *size of the head* of an ox affords another indication of a capacity to carry fat in an eminent degree. When the head of a bull approaches to the narrow elongated form of the female, he will be extremely docile, but will have lost much of his masculine character; his stock will be certain to fatten readily, but will not carry much muscle.

The *ears* should be thin—coarse ears being a certain sign of a coarse breed.

The *horns* should be fine—a coarse and thick horn being an indication of an ill-bred animal. Wherever there is a tendency in a breed to thick and coarse hides, the horns are generally found coarse and thick also. The horns, hoofs, hair, and cuticle, seem to be intimately connected: they resemble each other in their chemical composition, differing only in their degree of hardness and condensation. Thus, according to Scherer:—

	External Skin of the Sole of the Foot.	Hairs of the Beard.	Buffalo Horn.	Nails.	Wool.
Carbon . .	51·036	51·529	51·162	51·089	50·653
Hydrogen .	6·801	6·687	6·597	6·824	7·029
Nitrogen . .	17·225	17·936	17·284	16·901	17·710
Oxygen and Sulphur . }	24·938	23·848	24·957	25·186	24·608

These products are remotely connected with the vital actions of the systems with which they are associated; and however they may differ in form, uses, and external appearance, they are all produced by the same kind of vascular structure; and though variously arranged to suit the particular circumstances in each case, yet the mode of their development and growth is essentially the same.

A *thin neck* is another indication of a delicate breed, either in bulls or rams; a thick neck, on the contrary, indicating large muscles and a good constitution. *Proportion* is another sign or token by which to judge of the disposition of an animal to carry a fair proportion of muscle. There should always be a proportionate union of *length, depth, and thickness*; no matter what the

weight or size of the animal may be, these three properties are indispensable, if the breeder's object is to obtain the greatest weight of meat on the most valuable points.

20. The immense difference in the size of the different breeds of cattle or horses is beyond our control, although man has produced wonders even in this respect. Generally speaking they assume a certain character, dependent on the food which they obtain—for where food is abundant, they are found of a large size; and, where deficient, they are found of a diminutive breed. But this truth holds good only as it regards the different races, and not the individuals—for were we to breed the Shetland pony on the best Lincoln pastures, it would take many hundred successive generations before his race would approximate to the size of the breeds that are natural to this district.

21. But although the size of different breeds of animals is seemingly fixed, or dependent only on climate and soil, still much has been done by care and attention in breeding and rearing. Our attention here will chiefly be directed to the *rearing department*, where there is a great deal of mismanagement, even amongst our very best breeders. With some, it is a common practice in the rearing of a bull-calf, to place the young animal, shortly after he is weaned, in a narrow stall, and to feed him with raw milk and oatmeal gruel, and afterwards with some of the artificial and natural grasses, hay and turnips, &c.—the breeder feeling perfectly satisfied that his system is a right one, so long as the animal is looking plump and fat. The effect of this, as we have already shown (16), would be without doubt to lessen the size of the lungs and other organs concerned in nutrition, and produce a breed that will carry immense masses of fat, come quickly to maturity, and also when they breed produce the same qualities in their offspring. But however desirable those qualities may be, depend on it there are others of an opposite character which are also to be attended to—these are, weight of muscle, strength of constitution, and the capability of propagating their race—to produce all which quite a different system must be adopted. There is a certain amount of exercise which muscles require to encourage their proper development and growth, that never can possibly be obtained by a young animal confined in this manner. The degree of activity in the nutrition of muscles depends in a great measure upon the use that is made of them; and thus we find that any set of muscles in continual employment undergoes a great increase in size and vigour, whilst those that are disused lose their firmness and diminish in bulk (16.). Cattle require not such exercise as would tend to harden the muscular fibre, but just so much as would keep the animal in a healthy state, and prevent those enormous accumu-

lations of fat which so frequently disfigure and so materially injure our very best breeds of cattle. This was particularly observed in many of the short-horned milch cows that won the Society's prizes at Derby, that were better adapted, in consequence of their immense fatness, to compete for prizes offered for fatted stock; and many of which will be prevented from breeding for the future.

22. During the first two years, as long as the weather will permit, the young bull should be allowed to range in the meadows; and when the autumn advances, and it becomes necessary to house him, we would recommend that the house or shed should be attached to a straw-yard, into which he may be occasionally turned during the mild dry days in the winter. We are aware of the trouble to be apprehended from grazing animals of this description during the second summer, but we know the plan is commonly practised in localities where the enclosures are conveniently small, without any difficulty or danger.

23. We stated at the commencement of this essay that the living organism is incapable of producing an elementary body out of substances which do not contain it; a statement in common parlance meaning, "that a horse which gets kicks instead of oats is not likely to maintain a working condition." In the rearing of young animals of all descriptions, it must be evident that substances rich in nitrogen are particularly required for the growth of the various parts of the body, since there is no part of an organ that contains less than 17 per cent. (3.). For the growth of bone, muscle, blood, membranes, skin, horn, hair, and cellular tissue, a certain amount of this substance is absolutely necessary. We have shown that they do not obtain much, if any, of this substance from the air: it must therefore necessarily be supplied in the food. In the rearing of horses, where the object is to produce a great development of muscle, this is particularly required: hence it is the practice of intelligent breeders to supply the young stock with a proper allowance of oats, peas, beans, and shelter, during the winter; and it is from the want of those requisites that so many thousands of horses are yearly rendered worthless. The young animal is placed on our globe tolerably perfect from the hands of the Creator, but its degeneracy is frequently owing to the treatment pursued in the rearing. Only compare a yearling colt that has been well housed and well fed during the winter, with one that has been turned out, and fed chiefly with hay, straw, and turnips—the food usually allowed by farmers to this kind of stock in the winter; and although equally fine and clean in their respective points when separated in the autumn, yet they bear no kind of comparison, either in size or beauty, in the spring. Again

pursue the same plan the following winter, and you fix the shape for life—the one a handsome, strong, muscular animal; the other a coarse and plain one. It is by proper feeding, and a proper degree of shelter given to the young stock, during the first three winters, that some horses are got to such perfection as we sometimes see, having clean limbs, large powerful muscles, and good action; for, had those colts been kept hard, and exposed to the weather, they would never have attracted any attention.

24. In the rearing of store cattle, the same care is not required as we have recommended for breeding ones—the object of the feeder in this instance being to obtain as much profit as he can from the food which the animals consume: hence, their value must be determined by the profit which they yield to the breeder and feeder conjointly, from birth to maturity; but, even in this case, it may be worth the farmer's notice to be acquainted with the fact, that nearly the whole of the fleshy part of an animal, *which will afford any profit to him*, is assimilated chiefly during the period of its growth. When it has arrived at its full growth, the addition made to its bulk is chiefly an accumulation of fat, which surrounds and is intermingled with the substance of the muscle. Thus, the object of the farmer whose purpose is profit, will be to force his stock on, during the period of their growth, by such kind of food as will produce the largest quantity of muscle at the least expense.

25. The farmer must now see the necessity of giving his growing stock peas, beans, and barley-meal, in conjunction with good hay, grass, and turnips, varied, of course, according to the seasons, and other circumstances. Experience has proved that health and appetite are best promoted by a change of diet, rather than by limiting the quantity and quality. There should be no cessation in the rearing and feeding of cattle, for those that are stuffed and starved by turns are sure to prove unprofitable to the feeder; and there is no more certain rule in the rearing of young stock than this—that those that suffer a deprivation either in quantity or quality of food, never become perfectly developed, either in bulk or proportions.

26. It forms a curious and interesting subject for the feeder to ascertain the respective quantities of the fleshing and fattening properties contained in an acre of the different crops commonly used in the rearing and feeding of stock. The following *acreable table of nutrition* has been constructed chiefly from Professor Johnston's calculations—the proportions of gluten, &c., from Boussingault's analyses, which indicate the *fleshing properties*; and the proportions of starch, gum, and sugar, the *fattening properties*:—

One Acre of	Produce per Acre.	Weight of Grain per Bushel.	Weight of Gluten, Albumen, and Caseine.	Weight of Starch, Gum, Sugar, and Fat.	Weight of Water per Acre.
		lbs.	lls.	lbs.	lbs.
Field Beans . . . . .	25 bush.	64	450	672	256
Peas . . . . .	25 „	66	380	845	208
Oats . . . . .	50 „	42	290	1,168	336
Hay . . . . .	3 tons.	..	480	2,790	752
Potatoes . . . . .	12 „	..	600	3,330	20,250
Carrots . . . . .	25 „	..	1,120	5,800	47,600
Turnips . . . . .	30 „	..	800	6,700	56,950
Wheat Straw . . . . .	3,000 lbs.	..	40	940	450
Oat Straw . . . . .	2,700 „	..	36	970	324
Barley Straw . . . . .	2,100 „	..	28	646	252

The farmer need not learn from this or any other table the importance of a turnip-crop, it being acknowledged by all that it is indeed the sheet-anchor of light-soil cultivation; for although the per centage of nutritious matters is trifling in the turnips, when compared with that of peas, beans, oats, or barley, yet the immense weight of these roots which can be grown—sometimes as much as 40 or 50 tons per acre—gives such a very large quantity of nutritious matters, that swede turnips\* may well be called the raw material for the manufacture of beef. The farmer will also see the peculiar adaptation of the carrot crop to the rearing and fattening of stock—the nutritious matters which they contain being greater than turnips, and being admirably fitted for the heavier description of soils, where turnips cannot be successfully cultivated. He will also see, from the immense weight of water contained in those roots, that it is desirable to give some dry provender to his sheep, such as oat or barley meal, oat-straw, hay, or pea-haulm, which would prevent the frequent scouring of those animals, the consequence of so much watery food; and by occasioning the food to remain longer in their stomachs, a greater quantity of nourishment would probably be obtained than when eaten alone.

27. The *hay-crop* varies very considerably in its per centage of nutritious matters—more so, we believe, than any other; the consequence of difference of soil, and methods adopted in saving. In the blades and stems of the young grasses there is much sugar, which, as they grow up, is gradually changed, first into starch, and then into woody fibre; and the more completely the latter change is effected, the riper the plant becomes, and conse-

\* I have not been able to obtain a correct analysis of the Swede turnip.



quently the less soluble are the substances it contains. Both theory and experience, then, indicate to the farmer the necessity of cutting his hay before it has attained its full stage of ripeness. It is also very probable that, when exposed to dry in the sun and air after being cut, to a certain extent this change from starch to woody fibre takes place. Hence the more quickly the drying is effected, the less extensively will changes of this kind take place; and this shows the necessity of the hay being frequently turned during "saving," and being rapidly dried.

28. Great quantities of bean-meal are used in some districts in the feeding of bacon-hogs, but it is found to make the flesh too firm for delicate porkers, and in the last stage of their fattening, barley-meal is substituted. The best kind of food for feeding pigs is a mixture of barley-meal, peas, and potatoes. Potatoes are frequently used by themselves for this purpose; but neither the fat or muscle of pigs fed in this manner can be compared to corn and peas-fed pork—the fat having a tallowy appearance, and both fat and muscle shrinking, for want of firmness, when boiled. Potatoes will do very well for store pigs, but should never be depended upon for the "feeding." Some feeders reject the grey pea, from an idea that it partakes in a degree of the nature of the bean in rendering the meat tough and hard. The same effect is produced, although in a more considerable degree, in the feeding of pigs on the acorn, which tends to render the meat firm and hard. This is owing to the astringent or tannin principle contained in the bean and acorn; vegetable astringents of all kinds are found to contract the muscular and vascular tissues, to diminish secretion, lessen irritability, and in many instances to impart strength or increased tone to an organ or part. It is the tannin principle contained in beans which renders them so valuable a food for hard-working horses. The nutritious elements of beans and peas are nearly the same, yet the former add more materially to the vigour of horses than the latter. Our Saxon ancestors used to feed their swine on acorns, and set great value on them for this purpose; and round the forests of England, it is still customary to drive the pigs in at the proper season, that they may feed on the acorns and the various kernels which fall from the trees. In Westphalia, the pig is turned into the oak-forest as soon as he is weaned, where he feeds, like the wild boar, upon acorns and roots of various vegetables; the consequence of which is, the worms and slush of every description which he devours counteract the astringent or tannin principle of the acorn, and they thrive amazingly. When the farmers around the New Forest feed their swine with acorns in the sty, they invariably give other food mixed with them, such as wash, brewers' grains, potatoes, turnips, beet, and the refuse of the

gardens, as they find that swine fed on acorns only, seldom thrive.

29. Our essay is now brought to a close; and, from what has been stated, it must be evident that constant and progressive change appears to be one of the leading characteristics of life; the whole seems like one vast laboratory, where mechanism is subservient to chemistry—where chemistry is the agent of the higher powers of vitality. In considering the digestive functions of animals, we have seen the manner in which vegetable food is assimilated into blood and tissues; we see that the materials have to pass through a great number of intermediate stages before they can attain their final state. We can perceive all these, but still we have as yet a very imperfect knowledge of the nature of the vital agents concerned in producing those chemical changes which the food must necessarily undergo during its assimilation. The living principle, whether of a vegetable or animal, is so adapted that it can elaborate its body out of the materials which are around it; but neither can create out of nothing that matter of which its organisation, during its appointed time, is composed. These materials, but few in number, are first elaborated from the air, the earth, and the waters, into the substance of plants, for the food of herbivorous and graminivorous animals, which, in their turn, are eaten by carnivorous animals; and when, after a time, the spirit has left its tenement, the organised body is resolved into its original inorganic substances—carbonic acid, water, and ammonia—these elements being either returned to the atmosphere, whence they were derived, or imbedded in the parent soil, again to constitute races of vegetables, and to contribute to the nourishment of organised beings. Even those portions of organic matter which, in the course of decomposition, escape in form of gases, and are widely diffused through the atmosphere, are not wholly lost to living creatures; for, in the course of time, they also re-enter into the vegetable kingdom, resuming the solid form, and re-appearing in organic products, destined again to pass through the same never-ending cycle of vicissitudes and transmutations. This is the most important page in the whole book of material nature, for thus is grass changed into mutton and beef, which afterwards are changed into the flesh of man.

---

XIV.—*Experiments with Salt and other Manures upon Oats, Barley, and Wheat.* By JOHN HANNAM.

[From an 'Essay on Manures,' to which a prize of 50*l.* was awarded by the Royal Highland and Agricultural Society.]

*Experiments on Oats.*

I.—Experiment on the actual and comparative effects upon the Oat crop of Nitrate of Potash, Nitrate of Soda and Salt (mixed), Salt (only), and Rape-dust.

*Details.*—Soil—thin limestone, worth 20*s.* per acre rental—exposed to the north. Prior crops—*barley*, (after turnips, eaten on,) *seeds*, (pasture,) *wheat*, (rape-dusted).

*Management.*—Hopetoun oats, drilled April 4, 1842, and the following tillages applied:—

1.	2.	3.	4.	5.
Nit. Soda and Salt.	Nit. of Potash.	Nothing.	Common Salt.	Rape-Dust.

No. 1.—Area  $\frac{1}{4}$  acre, nit. soda  $1\frac{1}{2}$  st., salt 3 st. applied as a top-dressing, May 2.

2.— Ditto nit. of potash 2 st. do. do.

3.— Ditto nothing.

4.— Ditto salt 6 stone, applied as a top-dressing, May 2.

5.— Ditto rape-dust 3 bushels, drilled with the seed, April 4.

*Observations.*—Rain coming a few days after the top-dressings were applied, the effects upon Nos. 1 and 2 were soon visible in the dark-green hues assumed by the young plant. No. 5 (rape-dust) at this time was much a-head of all the other patches, owing to the manure having been applied when the grain was drilled. During June Nos. 1 and 2 came up with No. 5, No. 3 (nothing), and No. 4 (salt), being much in the background.

July 1.—A change had now taken place in the respective positions, as regarded appearance, of the plots, No. 4 having made a push that quite astonished me. At this time they stood thus—

- |      |  |  |
|------|--|--|
| 1. { | No. 1, nit. soda and salt—long and rich in foliage.                        |  |
|      | 2, nit. potash, do. do. partially lodged.                                  |  |
|      | 4, salt—good standing crop.  |  |
|      | 5, rape-dust—good.   |  |
| 2.   | 5, rape-dust—good.   |  |
| 3.   | 3, nothing—full of plant, but shorter in the straw than the other patches. |  |

In this order they stood up to August 24, when they were reaped; and, after being well fielded, were thrashed immediately, with the following results:—

No. 1,	gave 175 sheaves, yield. 588 lbs. of straw, 431 lbs. of gr. weighing 40 lbs. per bush.
2,	172 do. 582 do. 416 do. 40 do.
3,	150 do. 512 do. 378 do. 40½ do.
4,	180 do. 601 do. 451 do. 41 do.
5,	162 do. 561 do. 410 do. 40 do.

From the above we therefore obtain the following

FINAL RESULTS PER IMPERIAL ACRE.

No.	Tillage.	Quantity of Tillage.	Gross Produce.		Cost of Manure.	Increase of		Weight per Bush.
			Grain.	Straw.		Grain.	Straw.	
			Bushels.	st. lbs.	£. s. d.	Bushels.	st. lbs.	lbs.
1	Nit. Soda and salt	6 stone 12 stone	43·1	168 0	1 2 1½	5·76	21 10	40
2	Nit. Potash	1 cwt.	41·6	166 4	1 16 0	4·26	20 0	40
3	Nothing	..	37·3	146 4	..	..	..	40½
4	Salt	24 stone	44·0	171 4	0 9 0	6·66	25 6	41
5	Rape-Dust	1½ qrs.	41·0	160 4	1 13 9	3·76	14 0	40

*Observation.*—Be it observed that the straw here weighed is the good marketable straw, and does not include the short and broken, which goes away in what is technically termed “falls” or pulls.

*Conclusions.*—In this experiment we observe—

1. That, for the oat crop, upon soil which has been for a length of time under a system of rape-dust tillage, a dressing of saline manures may be used with greater effect than another application of rape-dust.

2. That in such cases, common salt has a tendency to increase both the quality and the quantity of grain, and to increase the quantity of grain in a greater ratio than the quantity of the straw.

5. That nit. of soda, mixed with salt, increases the quantity of straw and grain in a greater degree than nit. of potash, and in a less degree than salt only.

6. That nit. of potash increases the straw in a greater ratio than the grain, and diminishes the weight per bushel.

7. That rape-dust increases both straw and grain, and diminishes the weight per bushel of the grain.

8. That the nitrates act more quickly than salt.

9. That the nitrates render the straw bulky, soft, and coarse; while salt makes it white and brittle.

*Experiments on Barley.*

J.—Experiment on the actual and comparative effects on the Barley crop, of Nitrate of Potash, Nitrate of Soda and Salt (mixed), Salt (only), and Rape-dust.

*Details.*—Soil—good turnip soil, upon the limestone range,

worth 26s. per acre rental. Situation—level, and free from all extraneous influences. Prior Crops—*seeds* (pastured); *wheat* (rape-dust); *turnips* (farm manure, and partially consumed on the land by sheep).

*Management.*—Drilled, April 6, 1842, and applications made as follows :—

1.	2.	3.	4.	5.
Nit. Soda and Salt.	Nitrate of Potash.	Nothing	Salt	Rape-dust.

- No. 1. Area  $\frac{1}{2}$  acre {Nit. soda,  $1\frac{1}{2}$  st. } applied as a top-dressing, May 2, 1842.  
 Salt, 3 st.  
 2. do. Nit. potash, 2 st. do. do.  
 3. do. Nothing.  
 4. do. Salt, 6 st. do. do.  
 5. do. Rape-dust, 3 bush. drilled with the grain.

*Observations.*—This experiment being precisely similar to the preceding one upon oats, and made at the same time, the effects in both cases were very similar. At the time of top-dressing, rape-dust (No. 5) had the lead, which it maintained somewhat longer than in the oats, as the effect of the saline dressings upon the foliage of the plant was not so visible as in the other case. The bulk, however, was increased, though the colour was not so much affected in Nos. 1 and 2, so that on July 1, I placed Nos. 1, 2, and 5 equal, No. 4 next, and No. 3 last—all, however, being good. During the month of July, No. 4 made an extraordinary push, so that at the end of the month they stood thus :—

1. { No. 4, Salt—very good ; forward.
- 1, Nit. soda and salt—very good ; rather coarser in the straw.
2. 2, Nit. potash— do. stronger in the straw than any other.
3. 5, Rape-dust—good ; forward.
4. 3, Nothing—fair crop ; forward.

At reaping time the above peculiarities were more fully developed. Thus, Nos. 1, 4, and 3 were riper than No. 2. Nos. 2 and 1 were coarser in the straw than the other, especially No. 2, which was much lodged. No. 4 was particularly white and brittle in the straw, and was fit for cutting before any other portion. No. 5 was also yellow in the straw ; while No. 1 was darker than 4, and lighter in colour than 2. By these features the plots were distinguishable by the casual observer.

After reaping, August 29, 1842, the produce of the several plots was well weathered, and then thrashed, with the following results :—

No. 1.	gave 234 sheaves, yield.	830 lbs. straw & 670 lbs. of grain, weigh.	56 lb. p. bush.
2. do.	233 do.	860 do.	668 do.
3. do.	178 do.	680 do.	524 do.
4. do.	236 do.	792 do.	696 do.
5. do.	205 do.	814 do.	612 do.

From these results per rood we obtain the following

FINAL RESULTS PER IMPERIAL ACRE.

No.	Name of Tillage.	Quantity.	Gross Produce.		Cost of Manure.	Increase of		Weight of Grain per Bush.
			Grain.	Straw.		Grain.	Straw.	
			Bushels.	st. lbs.	£ s. d.	Bushels.	st. lbs.	
1	{ Nit. soda . . . Salt . . . }	{ 6 stone 12 stone }	47·84	237 2	1 2 1½	10·42	42 12	56
2	Nit. Potash	8 stone	48·58	245 10	1 16 0	11·16	51 6	55
3	Nothing	..	37·42	194 4	..	..	..	56
4	Salt	24 stone	48·84	226 4	0 9 0	11·42	32 0	57
5	Rape-dust	1½ qrs.	44·08	232 8	1 13 9	6·66	38 4	55½

*Conclusions.*—In this experiment we observe—

1. That, upon a soil which has had rape-dust as a manure for a length of time, a dressing of saline manures may be advantageously used upon the barley crop.

2. That, as upon oats, so upon barley, common salt has a tendency to increase the quantity of grain in a greater ratio than the straw, to improve the *quality* of the grain, and to render the straw white and brittle, and to promote its ripening.

3. That the nitrates have a tendency to increase the quantity of straw in a greater ratio than the grain, to render the straw soft and bulky, and to retard slightly the ripening.

4. That the nitrates have not such a decided effect upon the colour of the young plant of barley as upon oats or wheat.

5. That the action of salt upon the crop is not visible so soon as that of the nitrates.

6. That rape-dust has a tendency in this case to diminish the weight of the grain per bushel.

7. That nitrate of potash also diminishes the weight per bushel of the grain.

K.—Experiment on the actual and comparative effects upon the Barley crop, of Rape-dust, Guano, Rape-dust and Salt, Nitrate of Soda, and Nitrate and Sulphate of Soda.

*Details.*—Good limestone soil, worth 24s. per acre per annum; exposed to the north; low fences; no trees. Prior crops—*barley* (upon turnips eaten on the land); *seeds* (pastured); *wheat* (rape dust); *turnips* (bones, crop pulled off).

*Management.*—Ribbed and sown April 10, 1843, with barley and clover seeds. Manures applied as follows:—

1.	2.	3.	4.	5.	6.	7.
Nothing.	Rape-dust.	Guano	Rape-dust and Salt.	Nit. of Soda.	Nit. of Soda and Sul. Soda.	Salt.

No. 1.— $\frac{1}{4}$ acre.	Nothing.					
2. do.	Rape-dust, 3 bush.,	sown in the furrows with the seed.				
3. do.	Guano, 4 st.		do.		do.	
4. do.	{ Rape-dust, 3 bush. and Salt, 3 st.,		do.		do.	
5. do.	Nitrate of soda, 3 st.			applied as a top-dressing,	May 3.	
6. do.	{ Nitrate of soda, 2 st. Sulphate of soda, 2 st.			do.	do.	
7. do.	Salt, 8 st.			do.	do.	

The remaining portion of the field (about 5 acres) was manured with 2 cwts. of guano per acre, in alternate lands or stitches, with 12 bushels of rape-dust per acre.

*Observations.*—The effects of the guano and rape-dust were distinctly marked from the first appearance of the plant—the portions left for a top-dressing being in one month a full week behind the Nos. 2 and 3. If anything, No. 3 had the lead of the two.

At the beginning of June, the top-dressings had not begun to show any effects, Nos. 1, 5, 6, and 7, being much in the background. Indeed the difference between them and Nos. 2, 3, and 4, could be seen half a mile off. At this time No. 3 was very decidedly superior to No. 1. This was the case, too, throughout the field, the lands dressed with guano being very distinguishable by their superior luxuriance from those manured with rape-dust.

A week of fine weather, about the middle of June, coming after a month of almost constant rain, made a wonderful improvement in the top-dressed portion; so much so, that some of them (Nos. 5 and 6) came up with No. 2, which had not progressed so well as No. 3. No. 4, however, at this time pressed No. 3 very closely in the race; so that, at the end of July, the whole field, with the exception of No. 1, (unmanured,) was a splendid crop. The experimental plots at this time stood as follows:—

- (No. 3) Guano—Splendid crop, thick and luxuriant.
- (No. 4) Rape-dust and salt—Do., not quite so luxuriant; more forward.
- (No. 5) Nit. of soda—Nearly equal to the preceding; rather more backward.
- { (No. 6) Do. and sulph. soda—Not quite so good as No. 3; backward.
- { (No. 2) Rape-dust—Equal to No. 3; not quite so backward.
- (No. 7) Salt—Not so luxuriant in the straw; very forward.
- (No. 1) Nothing—Very poor crop; much worse than any of the above.

The remainder of the field was a very excellent crop. The lands guanoed were, however, decidedly superior in every case to the rape-dust. On one marly hill, where there is scarcely an inch of soil, (the whole being formed of shelly limestone and chalky marl mixed,) and from which the turnips (grown with bones *only*) had been carted away, it was surprising to see the effect of the guano. The place where every handful had fallen was particularly marked, and the whole crop (where scarcely ever a crop, under more favourable circumstances, grew well before) was good. At this time an extensive dealer in rape-dust and bones went over the field with me, and gave, without hesitation, his opinion that the guano beat the rape-dust throughout the field by a quarter per acre. This gentleman, Mr. Robert Snowdon, was the very person who had supplied the rape-dust used in the experiment; his testimony, therefore, was decidedly free from prejudice *in favour* of guano.

As a curiosity, I send a sample of the soil from the marly hill alluded to, where, by the aid of guano, a crop of barley, of full 4 quarters per acre, was produced after turnips pulled off the land. (*Vide* "Extra Sample of Soil," marked "K.")

At reaping time, certain peculiarities were observable. No. 1, thin and short in the straw, was ripe first. No. 7, (salt,) though backward at the time the top-dressings were applied, was ripe sooner than any other, except No. 1. The straw was white and brittle. No. 4 partook of these peculiarities in a less degree. Nos. 5 and 6 (nitrated) were ripe last, having been at the time of top-dressing a full week behind Nos. 2 and 3. The straw of these portions was very yellow and coarse, appearing as though it had been forced to a quick vegetation. The straw of the patches 2 and 3 (rape-dust and guano) was yellow and soft. All the plots, with the exception of No. 1, which was too light to break down, were lodged so much, that they were very difficult to mow. Nos. 7 and 4 were less lodged than the others.

The whole of the field was mown, August 30, and the produce of the various patches kept separate, when, after being well weathered, the following were the results obtained from each plot:—

1.	gave	206	sheaves,	yield.	587	lbs. of	straw,	&	421	lbs. of	grain,	weigh.	54 $\frac{3}{4}$	lbs. p.	bush.
2.	do.	212	do.	do.	644	do.	496	do.	do.	do.	54 $\frac{3}{4}$	do.			
3.	do.	255	do.	do.	785	do.	625	do.	do.	do.	54	do.			
4.	do.	206	do.	do.	738	do.	622	do.	do.	do.	55	do.			
5.	do.	219	do.	do.	730	do.	603	do.	do.	do.	53 $\frac{3}{4}$	do.			
6.	do.	201	do.	do.	695	do.	579	do.	do.	do.	54 $\frac{1}{4}$	do.			
7.	do.	187	do.	do.	607	do.	554	do.	do.	do.	55 $\frac{3}{4}$	do.			



## FINAL RESULTS PER IMPERIAL ACRE.

No.	Manure.	Quantity.	Gross Produce.		Cost of the Manure.	Increase of	
			Grain.	Straw.		Grain.	Straw.
			Bushels.	st. lbs.	£ s. d.	Bushels.	st. lbs.
1	Nothing . . .	..	30.75	167 10	..	..	..
2	Rape-dust . .	12 bushels	36.23	184 0	1 7 9	5.48	16 4
3	Guano . . .	2 cwts.	46.29	224 4	1 6 0	15.54	56 8
4	{ Rape-dust and Salt . . .	{ 12 bushels 12 stone }	45.23	210 12	1 12 3	14.48	43 2
5	Nitrate of Soda	1½ cwt.	44.87	208 8	1 11 6	14 12	40 12
6	{ Nit. of Soda . Sul. of Soda .	{ 1 cwt. 1 cwt. }	42.30	198 8	1 10 6	11.55	30 12
7	Salt . . .	4 cwt.	39.74	173 6	0 12 0	8.99	5 10

Observe here that the weight of straw upon No. 1 is greater than it would have been had there been no clover seeds sown, as the light crop of barley *encouraged* the growth of the clover, while the heavier bulk of straw upon the other plots *retarded* its growth. Hence the straw of No. 1 weighed well, and the *gain* of straw on the other patches appears less than it really was. Again, the same circumstance affected the number of sheaves on No. 1; the quantity of clover making it necessary to bind *small sheaves*.

*Conclusions.*—In this case we see—

1. That guano is superior to rape-dust.
2. That saline applications may be used with success upon soil *requiring manure*.
3. That nitrate of soda increases the crop of straw and grain, and that sul. soda mixed with nitrate does not improve the crop so much as nitrate alone; hence we infer that nitrate of soda has a *positive effect*, and sulphate a *negative one*, upon the barley crop.
4. That salt increases the *grain* more than the *straw*.
5. That salt, *as a top-dressing auxiliary to rape-dust*, is extremely valuable; improving the produce in quantity and quality. (*Vide gain per acre, and weight per bushel, of No. 4.*)
6. That salt alone, or mixed with another substance, has the same visible effects—acting at the latter period of the plant's growth, and blanching the straw and stubble.
7. That guano and nitrate of soda diminish the weight per bushel of the grain produced.

L.—Experiment on the comparative effects on the Barley crop, of Rape-dust, Rape-dust and Salt, and Guano.

*Details.*—Soil—moderate limestone, worth 24s. per acre per

annum. Prior crops—*wheat* (rape-dust), *oats* (rape-dust), *turnips* (bones—eaten on the land).

*Management.*—Sown with clover seeds, and drilled with barley, May 6, 1843. Manures applied as follows:—

1.	2.	3.
Rape-dust.	Rape-dust and Salt.	Guano.

- No. 1.  $\frac{1}{2}$  acre. Rape-dust, 6 bush.; drilled along with the seed.  
 2. do. Rape-dust, 6 bush., and salt, 6 stones, mixed and drilled with the seed.  
 3. do. Guano, 1 cwt.; mixed with earth, and do. do.

*Observations.*—The whole came up well, no difference being visible in any of the three for some time, when No. 3 took the lead. All the plots throve well, and, though sown late, at harvest promised a very fair crop. The clover seeds came equally well in all the patches. On reaping, September 7, No. 3 still had the advantage in weight of straw; No. 1 being also a shade better than No. 2 in quantity of straw. No. 2, however, showed somewhat similar effects from the application of salt that we observed in the other experiments on barley;—the straw was whitened, sooner ripe, and promised a better yield. The seeds were equally good throughout. The following were the results from each portion:—

1. 370 sheaves, yield. 1142 lbs. of straw, and 902 lbs. of grain, weigh. 56lbs. per bush.  
 2. 314 do. 1124 do. 918 do. do. 56 $\frac{1}{2}$  do.  
 3. 376 do. 1192 do. 949 do. do. 56 do.

From the above we obtain the following

FINAL RESULTS PER IMPERIAL ACRE.

No.	Name of Manure.	Quantity.	Gross Produce.		Cost of Manure.	Weight per Bushel.
			Grain.	Straw.		
1.	Rape-dust . . .	12 bushels	Bushels. 32·21	st. lbs. 163 1	£ s. d. 1 7 9	56
2.	Rape-dust and salt	} 12 bushels & 12 st.	} 33·55	} 160 4	} 1 12 3	} 56 $\frac{1}{2}$
3.	Guano . . . . .					

*Conclusions.*—In this experiment we note—

1. That guano and rape-dust, in comparative effect, are nearly equal; from want, however, of a patch *without manure*, we are unable to see what was the positive effect of each; hence we cannot say whether the equal yield from each plot arises from

the equal working of the manures or from the total failure of both.

2. That salt applied by drill, along with rape-dust, produces somewhat similar, though not so decided effects, as when applied as a top-dressing auxiliary to rape-dust. Thus we have, in No. 2, the highest yield of grain and the lowest of straw, although the heaviest weight per bushel of grain.

### Experiments on Wheat.

M.—Experiment on the actual and comparative effects upon the Wheat crop, of Nitrate of Soda, Nitrate of Potash, Sulphate of Soda, Soot, and Salt.

*Details.*—Soil—moderate limestone, worth 24s. per acre. Prior crops—turnips (manured); barley (rape-dusted); seeds (pastured with sheep).

*Management.*—Sown with red wheat November 7, 1841, and top-dressed as follows:—

Soot.	Common Salt.
5.	6.
Nothing.	Sulphate of Soda.
3.	4.
Nitrate of Soda.	Nitrate of Potash.
1.	2.

No. 1.	$\frac{1}{4}$ acre.	Nitrate of soda, $2\frac{1}{2}$ stones, applied as a top-dressing, May 2, 1842.			
2.	do.	Nitrate of potash, 2 stones,	do.	do.	do.
3.	do.	Nothing.			
4.	do.	Sulphate of soda, $2\frac{1}{2}$ stones,	do.	do.	do.
5.	do.	Soot, 8 bushels	do.	do.	do.
6.	do.	Salt, 6 stones	do.	do.	do.

*Observations.*—Showers coming after the applications were made, Nos. 1 and 2 began to show the effects of the nitrates in a few days; in a fortnight, however, they assumed a rich dark green hue, very different from any other portion of the field.

In the course of a month after the top-dressings were applied, No. 5 (soot) also assumed a darker colour than the rest, but was not so flourishing as Nos. 1 and 2.

When reaped (August 18, 1842), Nos. 1 and 2 were much the best crop to the eye—the rest being nearly equal. The straw and stubble upon No. 5 were quite blanched.

When thrashed, the following was the produce of each plot:—

No. 1.	152 sheaves,	yield.	734 lbs. straw and	562 lbs. grain,	weighing	64 lbs. per bushel.
2.	146 do.	707 do.	540 do.	64 do.		
3.	118 do.	628 do.	472 do.	64 do.		
4.	124 do.	635 do.	459 do.	64 do.		
5.	122 do.	645 do.	508 do.	64 do.		
6.	132 do.	604 do.	495 do.	61½ do.		

From the foregoing data we obtain the following

FINAL RESULTS PER IMPERIAL ACRE.

No.	Manure.	Quantity.	Gross Produce.		Cost of Manure.	* Increase or † Decrease.		Weight per Bus h.
			Grain.	Straw.		Grain.	Straw.	
			Bushels	st. lbs.	£ s. d.	Bushels.	st. lbs.	Lbs.
1	Nit. of soda .	1¼ cwt.	35·125	209 10	1 9 4½	*5·62	*30 4	64
2	Nit. of potash	1 cwt.	33·75	202 0	1 17 0	*4·25	*22 8	64
3	Nothing . . .	..	29·5	179 6	..	..	..	64
4	Sulph. of soda	1¼ cwt.	28·68	181 6	0 11 10½	†·82	* 2 0	64
5	Soot . . .	32 bush.	31·75	184 4	0 16 0	*2·25	* 4 12	64
6	Salt . . .	3 cwt.	30·9	172 8	0 9 0	*1·4	† 6 12	64½

*Conclusions.*—It will be here observed that—

1. Nitrate of soda, nitrate of potash, and soot, have a tendency to increase the produce of wheat, both straw and grain.

2. That common salt has a slight tendency to increase the produce of grain, and to decrease the *weight* of straw (mark, the *weight of straw*, as it will be observed—*vide* number of sheaves per rood—that it does not diminish the bulk), and that common salt increases the weight per bushel of the grain; thence it may, from these properties, be advantageously used as an auxiliary to other manures.

3. That sulphate of soda has *no* visible effects upon the wheat crop. The slight variation in yield of straw and grain may be fairly attributed to accidental circumstances, such as variation of soil, &c., as no two patches can be *perfectly* equal in every respect.

## MISCELLANEOUS COMMUNICATIONS AND NOTICES.

I.—*Experiment on Manures.* By SIR WILLIAM HEATHCOTE,  
Bart., M.P.

SIR WILLIAM,

BELOW I send you an account of the experiment made on the wheat crop at your Home Farm in the course of last year, with different kinds of manure; with my remarks during the growth of the crop, and my opinion on the final result of the trial.

Your directions, given to me in writing, were as follow:—To manure Numbered thus—

	A.	R.	P.	
1.—	2	0	0	with 40 loads (tons) of farm-yard dung.
2.—	2	0	0	with 20 ditto, and 3 cwt. of Guano.
3.—	2	0	0	with 20 ditto, and 50 bushels of Daniel's B manure.
4.—	1	0	0	with 4 cwt. Guano.
5.—	1	0	0	with 3 cwt. ditto.
6.—	2	0	0	with 100 bushels of Daniel's B manure.
8.—	1	0	0	with 2 cwt. Guano, 2 ditto in the spring.

In addition, were tried—

- |     |   |   |   |   |
|-----|---|---|---|---|
| 7.— | 1 | 0 | 0 | without any manure; and                             |
| 9.— | 1 | 0 | 0 | with 3 cwt. 37 lbs. of artificial Guano (Potter's). |

The field chosen for the experiment contains 37 acres nearly, and does not vary much as to quality. It has a gentle inclination to the south, and was in all respects in such a state of cultivation as to give an equal chance to each parcel: it was a clover ley, and had been mown twice during the summer, yielding at the least 3 tons of hay to the acre, and, when ploughed, above half a ton more per acre was buried.

The allotments having been carefully measured off, and plugs driven firmly in to mark their bounds, the dung-carting, ploughing, and pressing being completed, the artificial manures evenly sown, and the whole sufficiently harrowed, 3 bushels of wheat per acre were drilled on the 27th of October and the following day.

The sowing of the manures on the press, and before the harrow, was to secure the wheat from injury by coming too closely in contact with them.

*Observations during the progress of the Crop.*—The wheat came away evenly, except in a very few spots where Daniel's manure had touched the seed, and these looked sickly during the winter and spring; and, indeed, where Daniel's manure was the only dressing, the crop never looked better than No. 7, which had no manure, if so well. The

early part of the summer, being very wet, produced a very luxuriant growth of straw, especially on the dunged and Guano lots, Nos. 1, 2, and 4; and the want of sun caused weakness and consequent lodging of the crop. Just before reaping the following note was made:—

- No. 1, lodged flat.
- No. 2, not quite so much.
- No. 3, not much.
- No. 4, same as No. 2 nearly.
- No. 5, not much.
- No. 6, standing.
- No. 7, ditto.
- No. 8, ditto.
- No. 9, ditto.

The reaping began on the 20th August, and was not completed till the 31st, owing to the wet and unsettled state of the weather; each parcel was kept scrupulously apart, and set up upon its own land; and here the difference of bulk in straw was very evident, but where it was most lodged, soft and spongy.

On the 2nd of September the lots were housed separately in good order, except one, which was put in a small rick in the field (also in good order).

The thrashing having been completed, below is the produce:

No.	Quantity.			Best.		Second.		Tail.		Total.		Weight of Straw.			
	A.	R.	P.	Bush.	lbs.	Bush.	lbs.	Bush.	lbs.	Bush.	lbs.	Tons.	cwt.	qrs.	lbs.
1	2	0	0	62	63	3	53 $\frac{1}{2}$	3	51	68	4219	3	5	1	14
2	2	0	0	68	62 $\frac{3}{4}$	3	56	6	47	77	4717	3	6	2	16
3	2	0	0	65	62 $\frac{3}{4}$	5	60	4	48	74	4579	2	19	3	20
4	1	0	0	28	62 $\frac{3}{4}$	2 $\frac{1}{2}$	60	2 $\frac{1}{2}$	48	33	2015	1	13	3	8
5	1	0	0	32	63 $\frac{3}{4}$	2 $\frac{1}{4}$	54	2	40	36 $\frac{1}{4}$	2241	1	8	1	7
6	2	0	0	56 $\frac{1}{2}$	63 $\frac{3}{4}$	3 $\frac{1}{2}$	57	3	42	63	3917	2	7	3	20
7	1	0	0	29	63 $\frac{3}{4}$	1	57	1 $\frac{1}{4}$	44	31 $\frac{1}{4}$	1960	1	3	1	3
8	1	0	0	30	62 $\frac{1}{2}$	2 $\frac{3}{4}$	58	2	47	34 $\frac{3}{4}$	2093	1	6	0	0
9	1	0	0	27	62	2	52	1 $\frac{3}{4}$	41	30 $\frac{3}{4}$	1849	1	1	1	6

It appears from the above that guano and dung combined yielded the greatest bulk of both wheat and straw; that Daniel's B manure and dung came next as to wheat, but much under in straw.

That guano alone yielded a larger crop of wheat than dung alone, but less straw; that the omission of all manure produced a better crop than Daniel's manure, though not quite so much straw.

That guano sown in Autumn and spring is not so good as all sown in the Autumn;

And that artificial guano is, like Daniel's manure, worse than nothing on such a soil, and in such a season.

Although dung has in this instance been secondary, I am inclined to believe that this is entirely owing to the season, the wet May and June having caused the wheat to be too luxuriant.

I consider the dung in No. 3 to have produced the crop, and that

Daniel's manure is of no use for wheat on your farm; for proof of this compare Nos. 6 and 7.

I think Potter's guano is not adapted for a wheat crop, and that it is more fit as a dressing for turnips, one of its great constituents being bone-dust, which may be, and no doubt is, an excellent dressing for wheat when in a more decomposed state; but I think certainly not in so fresh a state as now made.

To conclude—I feel more disposed than ever to hold by the opinion given to you when you first spoke to me of using Daniel's manure, which was, that bone-dust is by far the best agent to improve a worn-out farm, and to enable it ultimately to maintain itself by producing great crops of turnips, heavy crops of straw, and consequently yards full of manure, made from the combination of these in the fattening of cattle.

I remain, Sir William,

Your obedient Servant,

WM. FOWLIE.

*Red House, near Hursley, Dec. 5th, 1843.*

---

## II.—*On the Bathing of Lambs as a Cure for the Scour.*

By RICHARD FISHER.

HAVING lost a great many lambs from the scour, I think it right to inform you what I know, from experience, to be the most beneficial remedy in that complaint. When the lambs are affected as above mentioned, I have them dipped for twelve mornings successively: a running stream is preferable to a pond. The lambs should be kept on old turf. My lambs have been affected from July to October.

I think the origin of the complaint alluded to in lambs arises, in a great degree, from the land being overstocked; but I have known it occur where the land has been lightly stocked. My lambs have sometimes been affected with the scour when with the ewes, but more frequently when weaned; and they usually appear in good health before the attack. I always put lambs upon first and second seeds. They are most liable to the complaint from the middle of June till October. The land the lambs are upon may be considered dry, as it consists of marl and gravel. I am not aware that they are affected by any changes of the atmosphere. When a *post mortem* examination has been made, I have never seen the liver affected, but a great deal of water in the intestines. Some of my lambs have lived a month after they have been attacked, and others have died in a few hours; and I have known them recover without any means being tried, but have invariably found that *medicine* has done harm. Sainfoin is the most beneficial food when suffering from the complaint. I have my lambs dipped at eight o'clock in the morning, and there are no pains taken to dry them afterwards. I have adopted this plan for three years, and find it tends more to their recovery than any other means I have tried.

RICHARD FISHER.

*Alcester Lodge, Nov. 25th, 1843.*

---

III.—*Experiment on the Use of Charcoal as a Manure.*

By the EARL OF ESSEX.

*To Ph. Pusey, Esq.*

SIR,—From the consideration that both salt and charcoal are not only direct food to plants, but also powerful absorbents and retainers of moisture, I made, during the late severe drought, the following experiment :

No. 1, I put in turnip-seed alone (Skirvings).

No. 2, the seed, mixed with 5 times its weight of salt, and 9 times its bulk of common charcoal refuse-dust.

No. 3, seed of the same kind, mixed with 12 bulks of charcoal-dust only.

All three put in the same day in drills, on the same ground, which had had no manure for three years. The ground at the time (3rd June) was as dry as dust: in five days Nos. 2 and 3 came up well, No. 3 soon, however, rapidly taking the lead. At the end of a fortnight all were slightly watered, but the soil was so dry that No. 1 did not vegetate; Nos. 2 and 3, however, grew rapidly. At the end of five weeks we had heavy rains, and in a few days No. 1 at last appeared, and then No. 3 almost grew visibly.

The three plants I exhibited to the Council this day (17th July) bore the following proportions to each other:—

No. 1, just coming into rough leaf.

No. 2, eleven inches long from end of root to the head; and

No. 3, twenty inches, and as big as my little finger at the crown of the root, and very vigorous. I may add, that the first week in May I sowed six acres of carrots with charcoal, the ground at the time being quite dusty, and no rain falling for many weeks. Carrots, under the most favourable circumstances of rain, &c., seldom come up in less than four or five weeks. Mine, in spite of the drought, were well up in three weeks, and held their own during the drought. The efficacy of the charcoal would not be so apparent in moist weather, but under no circumstances can do injury.

By "12 bulks," I mean, that putting, say, 2 quarts of seed to the acre, I should *well mix* with it 24 quarts of charcoal-dust; 8 less than a bushel.

Below I send a scale of the plants.

Your obedient servant,

ESSEX.

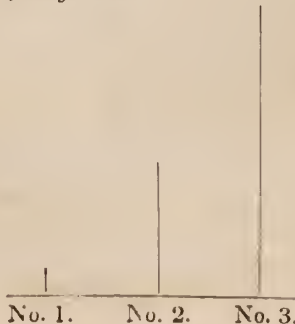
*Cassiobury, Watford, July 17th.*



IV.—*On White Carrots.* By Sir CHARLES BURRELL.

HAVING now received my bailiff's explanations I may yet be in time to make the desired statement respecting my culture and use of white cattle carrots. In the spring of 1843, 5 acres were sown, of which  $4\frac{1}{2}$  acres with white and  $\frac{1}{2}$  an acre with red Altringham carrots, to test their worth against the white—some seedsmen having asserted that they would answer equally well, perhaps from having great difficulty in supplying the demand for the white carrot seed, which was very scarce in the spring of 1843: the sowing of the Altringham was unsuccessful, as also  $\frac{1}{2}$  an acre of land sown with the white, consequently I had only 4 acres, producing 1200 bushels per acre, or in the whole 4800 bushels; with these twenty-four fattening beasts were fed, adding equal quantities of swede turnips (both sliced by a machine), together with hay and oil-cake up to the month of April, 1844. For my cart-horses, twenty in number, about 10 lbs. of white carrots were used with a little corn and hay, from November, 1843, to the following April; and the carrots were further applied in feeding twenty-four cows and two bulls to the same period, with *very great economy of hay*.

The land for carrots was dressed with sea-weed trenched into the ground in the autumn previous to frosty weather. The carrots were sown in April, and my bailiff's observation leads to the conclusion that carrots *do not* draw the ground *more* than swede turnips. In preparing for a crop of swedes, however, we necessarily dress the land well; whereas for carrots we seldom dress the ground, sowing them generally after wheat, or after *oats and seeds*. In fact this season I have a very promising crop of flax after carrots without any dressing.

The land which last year bore carrots is now in fallow for wheat. In preparation for carrots deep trenching is much preferable to ploughing, however deep, the crops being better; and this season the preference for drilling carrots over, sowing broadcast, is very evident.

Having stated that the introduction of white carrot culture economised hay, I proceed to offer proofs as follow:

In 1842—238 acres of seeds and grass produced 200 loads of hay; and when hay-making commenced in 1843 I had about 50 loads of old hay only in reserve.

In 1843—260 acres of seeds and grass produced 505 loads of hay, besides 21 acres of clover, producing 19 loads; and I had about 400 loads of hay in reserve when hay-making commenced in 1844.

Showing a beneficial reserve of hay, chiefly to be attributed to the united effects of a very good crop of hay in 1843, and the reduction of its consumption by the use of white cattle carrots, grown to considerable perfection on clay land in the weald of Sussex, a soil which, without thorough good and frequent under-drainage, combined with a high state of cultivation, offers no hope of growing a crop of good swede turnips.

*July 4th, 1844.*

N.B. Carrot-seed is very easily saved by transplanting some of the carrots of smaller size into portions of gardens, where not liable to injury by rabbits or hares.

V.—*Statement of the Situation of the Labourers in the Village of Sarby, on the Lincolnshire Wolds.*

By Mr. JOHN HORSLEY.

IN the first place, the cottages are good, being brick and tile, and contain each four rooms, viz., two low rooms and two chambers, besides a back kitchen, pantry, &c. &c. For the cottage alone the rent charge is 30s., to each of which is attached about an acre (some more, some less) of garden ground, for which they pay 28s. per acre, the average rent of their meadow and pasture land. Those keeping *one* cow have about 4 acres of meadow and pasture, and those keeping *two* cows about 7 or 8 acres, exclusive of the garden above described. The labourer's wages are 13s. 6d.\* per week; this has been the stated wages during the winter. The garden ground is cultivated with potatoes, which enables them to feed two or three good pigs, which on an average weigh about 25 stone (14 lbs. to the stone): one pig they generally contrive to sell for the Michaelmas rent, the other for their own consumption. During the spring they have generally a good fat calf, which will fetch from 3*l.* to 3*l.* 10s.

Having given you the principle upon which our cottages are rented, I will give you (as under) a few of the names, with the particulars, as they stand in the rent-roll:—

	Quantity.			Annual Value.		
	A.	R.	P.	£.	s.	d.
George Atkinson, two cows . . .	8	1	8	13	19	6
Jonathan Ashton, one do. . . . .	4	1	34	7	15	0
John Brocklesby, one do. . . . .	3	2	26	6	7	0
William Blair, one do. . . . .	3	3	30	7	1	0
John Clayton, one do. . . . .	4	0	1	7	2	0
William Jackson, one do. . . . .	4	0	27	7	0	0
Isaac Marshall, one do. . . . .	4	3	5	8	4	0
John Oglesby, two do. . . . .	8	1	19	13	5	0
John Pocklington, two do. . . . .	7	0	1	11	9	2
Thomas Stephenson, two do. . . . .	7	1	39	14	10	0
George Turner, one do. . . . .	3	3	31	7	0	0
John Twidle, one do. . . . .	4	3	7	8	4	0
Joseph Thistleton, two do. . . . .	8	0	25	13	0	0
John Walker, one do. . . . .	4	3	23	8	7	0

What I have stated above is a fair specimen. We have in this parish about forty cottagers, and I am happy to see them all comfortably fixed. The farmers generally draw the hay and coals for the cottagers in their employ. I have great pleasure in giving the particulars of our cottagers, and I should be glad to hear of other landlords following the example.

Sarby, near Barton-on-Humber,  
2nd April, 1842.

JOHN HORSLEY.

\* The wages would be now about 12s.

VI.—*Chesterman's newly-invented Portable Steaming Apparatus, for steaming Potatoes or any other Vegetable-Roots for Cattle.*

THIS is a very convenient apparatus, and an extremely cheap one. It will be found especially beneficial to farmers, butchers, and other feeders of pigs and cattle; and is calculated to supersede in many cases the fixed furnace, as it can be removed at pleasure from one part of the homestead, or of the farm, to another: and, from the simplicity of its construction, there is not the least danger of its getting out of order. Another important consideration is the great saving effected in consumption of fuel, as 8 or 10 sacks of potatoes can be steamed with 1 cwt. of coals. The apparatus is so constructed that all the pernicious quality contained in the potato is entirely extracted, and runs off in the process of steaming, and the potato comes out, of the most beautiful flavour, and perfectly dry and mealy. The boiler may at any time be used separate from the steamer where a large quantity of hot water is required for any purpose, and may be removed to any place at pleasure, with the greatest safety.

The apparatus, at prices varying from 4*l.* to 6*l.* (according to size), with full directions for use, may be obtained by applying to the inventor and manufacturer, W. Chesterman, engineer, &c., Faringdon, Berks.

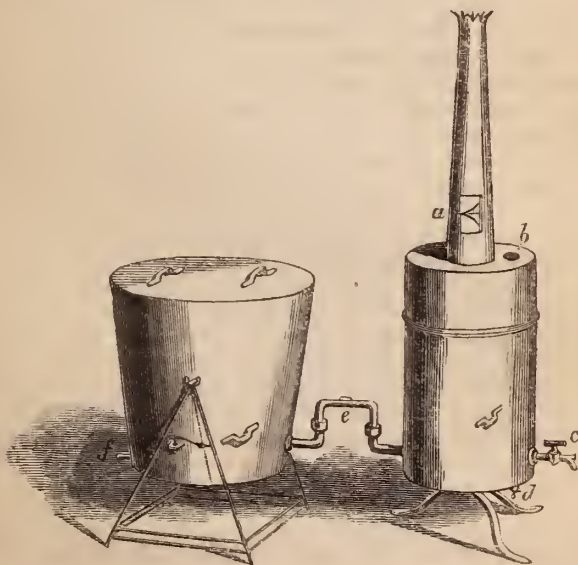

Reference (a) Opening for supply of Fuel. (b) Opening for supply of Water. (c) Tap for drawing off Water. (d) Opening of Fire Grate. (e) Elbow Pipe, connecting the Boiler and Steamer. (f) Pipe for carrying off the pernicious extract from Potatoes.

VII.—*Extract of a Letter from Governor Grey, dated Adelaide, South Australia, December 18, 1843.*

THE Colony continues to prosper, and the only event which has created any sensation is the complete success which has attended the operations of a newly-invented reaping-machine, invented in the colony. This machine reaps, thrashes, and winnows all at the same time, and this at the rate of nearly an acre an hour, the machine requiring to be attended by two men, and to be pushed by two horses. The corn is at once taken from the machine (which is stopped for the purpose when it is filled), and put into bags for exportation. The total sum charged for this operation is 10s. per acre; the sowing of corn, time, and labour, and consequently of expense, is very great. The inventor of the machine anticipates that, next year, the whole of these operations will cost much less than 10s. per acre. I have seen this machine at work, and was quite satisfied as to its success.

You will say, but we shall soon make such a machine in England, when the principle is known. It is, however, based upon a peculiarity in this climate, and could, I think, only succeed in a similar very dry climate.

I must now give you a description of this invention. It is something like a cart, pushed forward by two horses instead of being drawn. In front of the machine is a very large steel comb, which is pushed forward and seizes the straw of the wheat as an ordinary comb seizes hair. As the machine is moved forward, the straws are by the motion drawn through the comb, until the head, or the part containing the grain, is caught in the comb, and dragged up towards the mouth of the machine.

From the peculiar dryness of this climate, the wheat (what is termed) sheds very easily, that is, the corn or grain falls very readily out of the husk; indeed so much so, that wheat cannot be reaped here in the usual manner without considerable loss from the shedding. As soon, therefore, as the head of the wheat is caught in the comb, the grain is, as it were, combed out, and falls down the comb to the mouth of the machine. That part of the head of the wheat which does not get through the comb (which is too fine to admit it until the grain has fallen out) is ultimately dragged up to the mouth of the machine, where it is knocked off by an apparatus like that of the ordinary thrashing-machine, and the wheat is then thrashed in the same manner as in other thrashing-machines; whilst the rapid advance of the machine creates a strong draft, by the aid of which the corn is winnowed. The straw is left standing. So much of it as is required for manure, &c. is mown, and the remainder is burnt.

---

VIII.—*On the Italian Rye grass (Folium Trefolium).* From  
JOSHUA RODWELL.

MY LORD PRESIDENT AND GENTLEMEN,—My object in again venturing to address you upon the subject of the Italian rye-grass, is for the purpose of stating to you the result of my further experience and observa-

tions upon the culture of this valuable introduction to British agriculture, taking it for granted that your Journal will be open to the fair discussion and correction of any communications that may have been made upon this (or upon any other) subject. In reference, therefore, to my statement made to your Society in March, 1841, and inserted in your Journal (vol. ii. p. 214), I have the satisfaction of remarking that the experience of every subsequent year has fully borne out, not only the usefulness and productive qualities of this plant beyond any other rye-grass with which I have been able to compare it, but that its properties as a preparation for wheat (or any other successive crop) are not liable to the objections that have been so unjustly made to it. It is, however, for the purpose of stating for the information of your Society and the public, that although a name and certain characteristics are taken as the test of this grass, no other kind being considered genuine but that which in its growth is pale-coloured, upright in its stem, and being the produce of seed with a long awn (or tail); but I am furnished with proofs indisputable that these characteristics are not descriptive of the best kind of *Italian rye-grass*, but that the most productive and most nutritive plant is that which has a more fibrous root, producing a dark-coloured spreading stem, the produce of seed which has a short awn (or tail); and I beg therefore to state that this conviction is the result of very close attention to the growth and application of this grass for the three last years, against my previous predilections upon the subject, fostered as they have been by the public taste, the long-awned seed having hitherto been considered the only genuine stock, and consequently the only marketable commodity in every seed-market in England. But that your Society may feel the force of my observations, I beg to relate to them the details of my proceedings. Having observed in the growth of my crop which I reported on in your Journal in the year 1841, some plants that were, as I supposed, not genuine, that is, not of the pale colour, nor producing seed with long awns, I determined upon a fresh importation of seed direct from Italy, from which I have since tested the properties of the two varieties, both of which I have since cultivated with great care and attention; and I am now fully convinced, from every comparison I have made, not only of the different kinds of plants in different fields, but of both kinds in the same fields, and in every case have satisfactory proof that the best grass, viz. that which is the most productive and the most nutritive for all cattle, is the plant which spreads upon the ground, is dark-coloured, and being the produce of seed with short awn (or tail); and my conclusion has been more fully confirmed during the past week by testing the varieties, both in weight and bulk, finding that the dark-coloured plants from the seed of the short-awned grass exceed both in weight and bulk the pale-coloured plants by more than 30 per cent.

It will be also worthy the observation of those who intend to cultivate this grass, that if intended as a biennial or a perennial grass, in that case the dark-coloured is much preferable to the pale-coloured grass, the former branching and becoming thicker, and the latter spindling up and thus becoming thinner in plant every succeeding year.

I have only to add my readiness to supply specimens of these plants to your rooms, if it is desired that I should do so, or, should any gentle-

man wish to inspect my growth this year, which is upwards of 100 acres, it would give me great pleasure to see them in Suffolk.

I have the honour to be, my Lord and Gentlemen,  
Your obedient and faithful servant,

JOSHUA RODWELL.

Alderton, April 27th, 1844.

Buckanay Farm, April 29th, 1844.

SIR,—Agreeably to your directions I have tried the specimens of Italian grass by weight, which I have done with the greatest care and without prejudice; I selected ten plants or entire roots of each sort in each of two different fields, which I find by weighing to come as follows:—

	lbs.	oz.
Pale grass pulled and dirt beaten out of roots, the ten weighed . . . . .	0	14
Brown, with same treatment . . . . .	1	4
<hr/>		
Pale grass with roots cut off just above ground . . . . .	0	10
Brown ditto . . . . .	0	14
<hr/>		

*In another Field.*

	lbs.	oz.
Pale grass treated as above (ten roots) . . . . .	1	8
Brown ditto . . . . .	2	0
<hr/>		
Pale without root . . . . .	1	1
Brown ditto . . . . .	1	7
<hr/>		

The pale grass is produced by the seed with a long tail; the seed of the brown grass has but a very short tail, and is much the heaviest seed.

I did for some time advocate the pale grass, but I am brought by experience to become an advocate for the brown, which everything tells me is quite superior. First, I believe that 1 peck of the brown grass sown on 1 acre, will produce a bottom equal to 3 pecks of the pale grass. Secondly, in point of quality the cattle will soon decide that, for feed what kind of cattle you choose with it, they will very carefully select the brown from the pale, whether green or in hay; if in hay the pale is so very coarse that they will select the brown from it, and if fed on the layer green, the pale is always the last that is eaten. Thirdly, and what I think is of great importance, I am persuaded the brown is the best preparation for wheat, on account of its not growing in such large rough hollow bunches. The pale by growing all in bunches never forms on the face of the land what we call a tough flag, while the brown, on the contrary, by spreading on the surface, forms a face equal, if not superior, to any grass I have ever seen; and I quite believe, in fact I am quite sure, that, sow what quantity you will of the pale grass, you cannot get a good bottom without some of the brown with it. If you, Sir, or any one else, look at our layers this spring, I am sure there will be sufficient evi-

dence to confirm what I have said on the two points, of the cattle eating them where we have fed, and likewise of the beautiful bottom which the brown grass forms both where we have fed and where we have not fed.

I am, Sir, your humble servant,

THOMAS SCOTCHMER, Farming Bailiff.

To. J. Rodwell, Esq.,  
Alderton Hall.

### IX.—*Mode of procuring Water for Irrigation in Affghanistan.*

ALL the high mountain peaks in the valley of Kojuk and Pisheen are covered with snow in March and April. The valley slopes from north to south, and also from east to west. It is studded with villages, which are hid amongst gardens and orchards, and is a lovely plain, being refreshed with sweet waters, and clothed with luxuriant vegetation. It is intersected by numerous small canals and water-cuts, which are supplied by means of khareez. These khareez, upon which so much depends in Affghanistan, consist of a number of shafts or wells sunk in the upper part of the plain where there is water, until they meet with springs. They are connected at the bottom by subterraneous galleries, and the whole united in one canal, which is carried under ground down the valley at nearly the same level, or at least with only sufficient slope, so as to cause the water to flow; while the slope of the country being much greater, the canal, of course, gradually emerges to the surface. Wells are sunk along the line at the distance of every 15 or 20 yards, through which the soil is brought up from the canal, and air admitted to the workmen. They are never closed, but remain a line of open wells, marking the course of the canal underground, which are often of great length, being many *miles*. When the canal makes its appearance on the surface of the country, and becomes an open water-course, it is often carried for 20 or 30 miles, fertilizing the country through which it passes. A number of these khareez, which unite together at a place called Sir-i-âb, or Head of the Spring, a few miles south of Kwettah, form the source of the Shadeezy Lora river, a considerable stream, of great importance to the country, being thus in a manner artificially formed.

### X.—*On the Analysis of Guano.* By ANDREW URE, M.D., F.R.S., &c.

THIS extraordinary excrementitious deposit of certain sea-fowls, which occurs in immense quantities upon some parts of the coasts of Peru, Bolivia, and Africa, has lately become an object of great commercial enterprise, and of intense interest to our agricultural world. Four or five years ago it was exhibited and talked of merely as a natural curiosity. No one could then have imagined that in a short period it would be imported from the coasts of the Pacific in such abundance, and at such a moderate price, as to cheer by its fertilizing powers the languid and depressed spirits of the farmers throughout the United Kingdom. Such,

however, is now the result, as attested by the concurring Reports of almost all the Agricultural Societies of Great Britain and Ireland. No less than 28,500 tons of guano have been already imported from Peru and Bolivia, 1500 from Chile, and 7000 from Africa, altogether 37,000 tons, while more is on the way. The store of it, laid up from time immemorial in the above localities, seems to be quite inexhaustible; especially since it is receiving constant accessions from myriads of cormorants, flamingos, cranes, &c.

Having been much occupied with the chemical analyses of guano during the last two years for Messrs. Gibbs, of London, and Messrs. Myers, of Liverpool, who are the co-agents of the Peruvian and Bolivian governments, I have enjoyed favourable opportunities of examining samples of every description, and hope to show that many of the analyses of guano hitherto published have been made upon specimens not in their normal or sound state, like the best imported by the above houses from Chinchá and Bolivia, but in a certain state of *eremacausis*\* and decay.

Huano, in the language of Peru, signifies dung: a word spelt by the Spaniards, guano. The natives have employed it as a manure from the remotest ages, and have by its means given fertility to the otherwise unproductive sandy soils along their coasts. While Peru was governed by its native Incas, the birds were protected from violence by severe laws. The punishment of death was decreed to the persons who dared to land on the guaniferous islands during the breeding period of the birds, and to all persons who destroyed them at any time. Overseers were appointed by the government to take care of the guano districts, and to assign to each claimant his due share of the precious dung. The celebrated Baron Von Humboldt first brought specimens to Europe in 1804, which he sent for examination to Fourcroy, Vauquelin, and Klaproth, the best analytical chemists of the day; and he spoke of it in the following terms:—"The guano is deposited in layers of 50 or 60 feet thick upon the granite of many of the South-sea islands off the coast of Peru. During 300 years the coast birds have deposited guano only a few lines in thickness. This shows how great must have been the number of birds, and how many centuries must have passed over in order to form the present guano beds." The strata have undergone many changes, according to the length of time they have been deposited. Here and there they are covered with siliceous sand, and have thus been protected from the influence of the weather; but in other places, they have lain open to the action of light, air, and water, which have produced important changes upon them. Fresh guano is of a whitish or very pale drab colour, but it becomes progressively browner and browner by the joint influence of the above three atmospherical agents. Only *one* guano examined by Fourcroy and Vauquelin was found to contain a fourth of its weight of uric acid combined with ammonia, whence *that* appears to have been well selected by Baron Von Humboldt. They also found

---

\* The decomposition of animal and vegetable bodies by the joint action of air and water is shown by Liebig to be analogous to their combustion—as denoted by the term *eremacausis*, a Greek work, signifying *slow combustion*.



phosphates of ammonia, of lime, and of potash and ammonia, with some other constituents of little value in agriculture. Klapproth's analysis reported 16 per cent. of urate of ammonia, no less than 12.75 of oxalate of lime, 10 of phosphate of lime, 32 of clay and sand, with 28.75 of water and indeterminate organic matter. From the great proportion of clay and sand, Klapproth's sample of guano was obviously not genuine. I have met with no specimen of Peruvian guano that contained any appreciable quantity of clay, and none that contained above 4 or 5 per cent. of siliceous sand.

To Mr. Bland, of the firm of Messrs. Myers and Co., I am indebted for the following valuable information:—

The Chincha islands, which afford the best Peruvian guano, are three in number, and lie in one line from north to south, about half a mile apart. Each island is from 5 to 6 miles in circumference, and consists of granite covered with guano in some places to a height of 200 feet, in successive horizontal strata, each stratum being from 3 to 10 inches thick, and varying in colour from light to dark-brown. No earthy matter whatever is mixed with this vast mass of excrement. At Mr. Bland's visit to these islands in 1842, he observed a perpendicular surface of upwards of 100 feet of perfectly uniform aspect from top to bottom. In some parts of these islands, however, the deposit does not exceed 3 or 4 feet in thickness. In several places, where the surface of the guano is 100 feet or more above the level of the sea, it is strewed here and there with masses of granite, like those from the Alpine mountains, which are met with on the slopes of the Jura chain. These seem to indicate an ancient formation for the guano, and terraqueous convulsions since that period. No such granite masses are found imbedded within the guano, but only skeletons of birds.

The good preservation of the Chincha guano is to be ascribed to the absence of rain; which rarely, if ever, falls between the latitude of 14° south, where these islands lie, about 10 miles from the main land, and the latitude of Paquica, on the coast of Bolivia, in 21 S. L. By far the soundest cargoes of guano which I have analyzed have come from Chincha and Bolivia. Beyond these limits of latitude, where rain falls in greater or less abundance, the guano is of less value—and what has been imported from Chile has been found by me far advanced in decay—most of the ammonia and azotized animal substances having been decomposed by moisture, and dissipated in the air (by the *eremacausis* of Liebig), leaving phosphate of lime largely to predominate along with effete organic matter. The range of the American coast from which the guano is taken must therefore be well considered; and should not extend much beyond the Chincha islands as the northern limit, and Paquica, in Bolivia, as the southern.

The relative estimation of guano and nitrate of soda among the Peruvians is well shown by the following facts communicated to me by Mr. Bland:—"Near the coast of Peru, about 45 miles from Iquique (the shipping port of guano), there is the chief deposit of nitrate of soda. The farmers, who collect and purify this natural product, carry it to the place of shipment, and always require to be paid in return with an equivalent quantity of guano, with which they manure their land, to the exclusion of the far cheaper nitrate of soda. We cannot be surprised

at this preference, when we learn that in the valley of Chancay, about 40 miles distant from Lima, the soil produces, when farmed with irrigation in the natural way, a return upon maize of only 15 for 1; whereas, with the aid of guano, it produces 300 for 1! Hence the Peruvian proverb:—Huano, though no saint, works many miracles.

In the pamphlet recently published by Messrs. Gibbs and Myers, entitled “Peruvian and Bolivian Guano; its nature, properties, and results,” we have a very interesting view of the best established facts with regard to its operation and effects upon every variety of soil, and in every variety of circumstance, as ascertained by the most intelligent agriculturists of the United Kingdom. The general conclusion that may be fairly deduced from the whole evidence is, that good guano will, under judicious application, increase the crops of grain, turnips, potatoes, and grass by about 33 per cent.; and with its present price of 10*l.* per ton, at a cost considerably under the average cost of all other manures, whether farm-yard dung and composts, or artificial compounds. Guano is, moreover, peculiarly adapted to horticultural and floricultural improvement, by its relative cleanliness and facility of application.

The following observations upon guano, by Dr. Von Martius, of Munich, addressed to the Agricultural Society of Bavaria, deserve attention:—“Among animal manures,” says he, “it clearly claims the first place. It is uncommonly rich in ammoniacal salts, which act very favourably on vegetation. The ease with which these salts are decomposed, and exhale their ammonia into the air, is by him assigned as the reason why plants manured with guano generally present early in the morning accumulations of dew on the points of their leaves. The guano absorbs the atmospheric vapour, as well as carbonic acid; whereby it becomes so valuable a manure in dry barren regions. If we compare guano with other excrementitious manures, we shall find it far preferable to those afforded by man or other mammalia, which do not generally contain more than 20 per cent. of food that can be appropriated by plants. It is therefore five times better than night-soil, and also very superior to the French *poudrette* which (being dried night-soil) loses, through putrefaction and evaporation, the greater proportion of its ammoniacal elements. In birds, the excretions both of the kidneys and intestines are contained in the cloaca; whereby the volatile elements of the former get combined with the more fixed components of the latter.”

The guano is also a richer manure, on account of its being produced by sea-fowl, which live entirely on fish, without admixture of vegetable matter. The exposure also of the guano as soon as deposited to the heat of a tropical sun, in a rainless climate, prevents the components from fermenting, and *mummifies* them, so to speak, immediately into a concrete substance not susceptible of decomposition till it gets moisture; whereas the dung of our dove-cots suffers a considerable loss by exposure to our humid atmosphere. But in their action on vegetation, and in their chemical composition, these two bird excrements are analogous. Davy found in fresh dove-cot manure 23 parts in 100 soluble in water, which yielded abundance of carbonate of ammonia by distillation, and left carbonaceous matter, saline matter, principally common salt, and carbonate of lime as a residuum. Pigeons' dung readily ferments, but after fermentation afforded only 8 per cent. of soluble matter, which gave

proportionably less carbonate of ammonia in distillation than the dung recently voided. Dr. Von Martius proceeds to compare the proportion of soluble salts in guano and pigeons' dung, and thinks that by that comparison alone he can establish the superiority of the former; but he should have considered that the insoluble urate of ammonia, which is so powerful and copious a constituent of good guano, and is present in much smaller proportion in pigeons' dung, is sufficient of itself to turn the balance greatly in favour of the Peruvian manure. His general estimate however, that the manuring power of genuine guano is four times greater than that of pigeons' dung, is probably not wide of the truth. Besides the above-mentioned constituents, guano derives no small portion of its fertilizing virtue from the great store of phosphoric acid which it contains, in various states of saline combination, with lime, magnesia, and ammonia. Of all the principles furnished to plants by the soil, the phosphates are, according to Liebig, the most important. They afford, so to speak, the bones and sinews of vegetable bodies, while ammonia supplies them with their indispensable element, azote. Their carbon, hydrogen, and oxygen are derived from the air and water. Those products of vegetation which are most nutritious to man and herbivorous animals, such as bread-corn, beans, peas, and lentils, contain the largest proportion of phosphates. The ashes of these vegetable substances afford no alkaline carbonates. A soil in which phosphates are not present, is totally incapable of producing the above cereals. Agreeably to these views, Liebig believes that the importation of 1 cwt. of guano is equivalent to the importation of 8 cwt. of wheat; so that 1 cwt. of that manure assumes, with due culture, the form of 8 cwt. of substantial food for man.

Since all these testimonies concur to place this remarkable excrementitious product in such high estimation, it becomes a paramount duty of the chemist to investigate its composition, and to discover certain means of distinguishing what may be termed the sound or normal state of guano, from the decomposed, decayed, and effete condition. The analysis by Fourcroy and Vauquelin of a sample of guano presented to them by Baron Von Humboldt, gave the following composition in 100 parts:—

Urate of ammonia . . . . .	9.0
Oxalate of ammonia . . . . .	10.6
Oxalate of lime . . . . .	7.0
Phosphate of ammonia . . . . .	6.0
Phosphate of ammonia and magnesia . . . . .	2.6
Sulphate of potash . . . . .	5.5
Sulphate of soda . . . . .	3.3
Sal ammoniac . . . . .	4.2
Phosphate of lime . . . . .	14.3
Clay and sand . . . . .	4.7
Water and organic matters . . . . .	32.3

How different are the constituents from those assigned by Klaproth—a no less skilful analyst than the French chemists! and how much this difference shows not only the complexity of the substance, but its very variable nature!

The general results of an analysis by Professor Johnston, published in

his paper on guano, in the 3rd part of the 2nd volume of the Journal of the Royal Agricultural Society of England, are as follows :—

Ammonia . . . . .	7·0
Uric acid . . . . .	0·8
Water and carbonic and oxalic acids, &c., expelled by a red heat . . . . .	51·5
Common salt, with a little sulphate and phosphate of soda . . . . .	11·4
Phosphate of lime, &c. . . . .	29·3
	100·0

The specimen of guano represented by this analysis must have been far advanced in decomposition, as shown by the very scanty portion of uric acid; and must have been originally impure, from the large proportion of common salt, of which I have not found above 3 or 4 per cent. in any of the genuine guanos which I have had occasion to analyze. In another sample, Professor Johnston found 44·4 of phosphate of lime, with a little phosphate of magnesia, and carbonate of lime. These results resemble, to a certain degree, those which I have obtained in analyzing several samples of Chilian and African guanos, especially in the predominance of the earthy phosphates. The proportion of ammonia which can be extracted by the action of hydrate of soda and quicklime, at an elevated temperature, is the surest criterion of the soundness of the guano; for by this process we obtained not only the *ready-formed* ammonia, from its several saline compounds, but also the ammonia producible from its uric acid, and undefined animal matter. These two latter quantities have been hitherto too little regarded by most analysts, though they constitute the most durable fund of azote for the nutrition of plants. Uric acid, and urate of ammonia, which contains 10-11ths of uric acid, being both nearly insoluble in water, and fixed at ordinary temperatures, continue to give out progressively to plants in the soil, the azote, of which they contain fully one-third of their weight. Under the influence of oxygen and a certain temperature, uric acid passes through a very remarkable series of transformations; producing allantoin, urea, and oxalic acid, which eventually becomes carbonic acid. These changes are producible immediately by the action of boiling water and peroxide of lead. From these metamorphoses we can readily understand how so much oxalate of ammonia and of lime is reported in many analyses of guano, though none, I believe, is to be found in the normal state, as it is occasionally imported from the Chinha Islands and Bolivia; nor were any oxalates found in the dung of the gannet, as analyzed by Dr. Wollaston, or of the sea-eagle, according to the following analysis of Coindet:—ammonia, 9·21 per cent.; uric acid, 84·65; phosphate of lime, 6·13 = 100. The Peruvian sea-fowl, by feeding exclusively on fish, would seem to swallow a large proportion of earthy phosphates; since, in the purest guano that has come in my way, I have found these salts to amount to from 12 to 15 per cent.

Dr. Von Martius proposes to use the degree of solubility of the guano in water as a good criterion of its quality; but this is a most fallacious test. Sound guano contains from 20 to 25 per cent. of insoluble urate of ammonia; nearly as much undefined animal matter, along with from

15 to 20 of earthy phosphates; leaving no more than 50 or 55 per cent. of soluble matter, exclusive of moisture; whereas decayed guano yields often 60 or 70 per cent. of its weight to water, in consequence of the uric acid and animal matter being wasted away, and the large portion of moisture in it, the latter amounting very often to from 25 to 35 per cent. The good Peruvian guano does not lose more than from 7 to 9 per cent. by drying, even at a heat of 212° F.; and this loss necessarily includes a little ammonia. Each analysis of guano executed for the information of the farmer should exhibit definitely and accurately to at least 1 per cent. :—

1. The proportion of *actual* ammonia.

2. The proportion of ammonia producible also from the uric acid and azotized animal matter present; and which may be called the *potential* ammonia. This is a most valuable product, which is, however, to be obtained only from well-preserved dry guano.

3. The proportion of uric acid, to which, if 1-11th of the weight be added, the quantity of urate of ammonia is given.

4. The proportion of the phosphates of lime and magnesia.

5. The proportion of fixed alkaline salts, distinguishing the potash from the soda salts; the former being more valuable, and less readily obtainable: the latter can be obtained by the use of common salt. Wheat, peas, rye, and potatoes require for their successful cultivation a soil containing alkaline salts, especially those of potash.

6. The proportion of sandy or other earthy matter, which in genuine guano, carefully collected, never exceeds 2 per cent., and that is silica.

7. The proportion of water, separable by the heat of 212° F.

The farmer should never purchase guano, except its composition in the preceding particulars be warranted by the analysis of a competent chemist. He should cork up in a bottle a half-pound sample of each kind of guano that he buys; and, if his crop should disappoint reasonable expectation, he should cause the samples to be analyzed; and should the result not correspond to the analysis exhibited at the sale, he is fairly entitled to damages for the loss of his labour, rent, crop, &c. The necessity of following this advice will appear on considering the delusive, if not utterly false, analyses under which cargoes of guano have been too often sold. In a recent case, which came under my cognizance in consequence of having been employed professionally to analyze the identical cargo, I found the guano to be nearly rotten and effete; containing altogether only 2½ per cent. of ammonia, ½ per cent. of urate of ammonia, nearly 9 of sea-salt, 24 of water, and 45½ of earthy phosphates. Now, this large cargo, of many hundred tons, fetched a high price at a public sale, under the exhibition of the following analysis:—

Urate of ammonia, ammoniacal salts, and decayed animal matter . . . . .	17·4
Phosphate of lime, phosphate of magnesia, and oxalate of lime . . . . .	48·1
Fixed alkaline salts . . . . .	10·8
Earthy and stony matter . . . . .	1·4
Moisture . . . . .	22·3

---

100·0

The purchasers, I was told by the broker, bought it readily, under a conviction that the guano contained 17·4 of ammonia, though the proportion of ammonia is not stated.

By the following hypothetical analysis much guano has been well sold :—

“Bone earth, 35; lithic acid, &c., 15; carbonate of ammonia, 14; organic matter, 36 = 100.” I am quite certain that no sample of guano can contain 14 per cent. of carbonate of ammonia—a very volatile salt. We shall see presently the state of combination in which the ammonia exists. It may contain at the utmost 5 per cent. of the carbonate; but such guano must have been acted upon powerfully by humidity, and will therefore contain little or no uric acid.

In the very elaborate examination of guano by T. Oellacher, apothecary at Innsbruck, published in a recent number of Buchner's *repertorium* of Pharmacy, it is said, that if a glass rod dipped into muriatic acid be held over guano, strong fumes are developed; and the solution of guano has an alkaline reaction with litmus-paper. These phenomena evidently indicate the presence of carbonate of ammonia, and of course a partially decomposed guano; for sound Chinha and Bolivian guano have an *acid* reaction, proceeding from the predominance of phosphoric acid. Farmers frequently judge of the goodness of guano by the strength of the ammoniacal odour; but in this judgment they may egregiously err, for the soundest guano has no smell of ammonia whatever; and it begins to give out that smell only when it is more or less decomposed and wasted.

Oellacher could find no evidence of urea in his guano; I have obtained fully 5 per cent. of this substance from good Peruvian guano.

I shall now describe my own system of analysis :—

1. In every case I determine, first of all, the specific gravity of the guano; which I take by means of spirits of turpentine, with a peculiar instrument contrived to render the process easy and precise. If it exceeds 1·75 in density, water being 1·0, it must contain sandy impurities, or has an excess of earthy phosphates, and a defect of azotized animal matter.

2. I triturate and digest 200 grains of it with distilled water, filter, dry the insoluble matter, and weigh it.

3. The above solution, diffused in 2000 gr. measures, is examined as to its specific gravity, and then with test-paper, to see whether it be acid or alkaline.

4. One half of this solution is distilled along with slaked lime in a matrass connected with a small quintuple globe condenser, containing distilled water, and immersed in a basin of the same. As the condensing apparatus terminates in a water-trap, no part of the ammonia can be lost; and it is all afterwards estimated by a peculiar meter, whose indications make manifest one hundredth part of a grain.

5. The other half of the solution is mixed with some nitric acid, and divided into three equal portions.

*a*, the first portion, is treated with nitrate of barytes, and the resulting sulphate of barytes is collected, ignited, and weighed.

*b*, the second portion, is treated with nitrate of silver, and the resulting chloride of silver ignited and weighed.

c, the third portion, has a certain measure of a definite solution of ferric nitrate mixed with it, and then ammonia in excess. From the weight of the precipitated subphosphate of iron after ignition, the known amount of oxide used being deducted, the quantity of phosphoric acid in the soluble portion of the guano becomes known.

d, the three above portions are now mixed, freed by a few drops of dilute sulphuric and hydrochloric acids from any barytes and silver left in them, and then tested by nitrate of lime for oxalate of ammonia. The quantity of oxalate of lime obtained determines that point.

6. The last liquor filtered, being freed from any residuary particles of lime by oxalate of ammonia, is evaporated to dryness and ignited, to obtain the fixed alkaline matter. This being weighed, is then dissolved in a little water, neutralized with acid, and treated with soda-chloride of platinum. From the quantity of potash-chloride of platinum which precipitates, after being filtered, dried, and weighed, the amount of potash present is deducted; the rest is soda. These bases may be assigned to the sulphuric, hydrochloric and phosphoric acids, in proportions corresponding to their respective affinities.

7. The proportion of organic matter in the above solution of guano is determined directly by evaporating a certain portion of it to dryness, and igniting. The loss of weight, minus the ammonia and oxalic acid, represents the amount of organic matter.

8. A second portion of a solution of the guano is evaporated to dryness by a gentle steam-heat, weighed, inclosed in a stout well-closed phial along with alcohol of 0.825, and heated to 212°. After cooling, the alcoholic solution is decanted or filtered clear, evaporated to dryness by a gentle heat, and weighed. This is urea, which may be tested by its conversion into carbonate of ammonia, when heated in a test-tube or small retort. In this way I have obtained from Bolivian guano 5 per cent. of urea: a certain proof of its entire soundness.

9. *Analysis of the insoluble matter.*—One-third of it is digested with heat in abundance of borax-water, containing  $\frac{1}{100}$  of the salt, filtered, and the filter dried by a steam-heat. The loss of weight indicates the amount of uric acid, which is verified by supersaturating the filtrate with acetic or hydrochloric acid, thus precipitating the uric acid, throwing it upon a filter, drying, and weighing it. This weight should nearly agree with the above loss of weight, the small difference being due to soluble organic matter, sometimes called geine and ulmic acid. The uric acid is evidenced,—1, by its specific gravity, which I find to be only 1.25, as also that of the urate of ammonia; 2, by its affording fine purple *murexide* when heated in a capsule along with nitric acid, and then exposed to the vapour of ammonia from a feather held over it; 3, by its dissipation when heated, without emitting an empyreumatic odour.

10. Another third of the solid matter is distilled along with half its weight of slaked lime and ten times its weight of water, in the apparatus already described, and the ammonia obtained from it estimated.

11. The remaining third having been ignited, is dissolved with a gentle heat in weak hydrochloric acid, and the remaining silica and alumina washed on a filter, dried, and weighed. To the hydrochloric solution, dilute sulphuric acid is added, and the mixture is heated till all the

hydrochloric acid be expelled, and the greater part of the water. Alcohol of 0.850 is now poured upon the pasty residuum, and the whole, after being well stirred, is thrown upon a filter. The phosphoric acid passes through, as also the magnesia in union with sulphuric acid. The sulphate of lime, which is quite insoluble in spirits of wine, being washed with them, is dried, ignited, and weighed. From the weight of sulphate of lime, the quantity of phosphate of that earth that was present becomes known.

12. Ammonia in excess is now added to the filtrate, which throws down the granular phosphate of ammonia and magnesia. After washing and drying this powder at a heat of 150°, its weight denotes the quantity of that compound in the guano.

13. To the filtered liquor (of 12), if a little ammonia be added, and then muriate of magnesia be slowly dropped in, phosphate of ammonia and magnesia will precipitate, from the amount of which the quantity of phosphoric acid may be estimated.

14. The proportion of oxalate of lime is determined by igniting the washed residuum (of 9), and placing it in an apparatus for estimating the quantity of carbonic acid given off in dissolving carbonate of lime. The apparatus, either Fig. 1 or 2, described in my little treatise on alkalimetry, will serve that purpose well. I have rarely obtained more than  $\frac{1}{2}$  gr. of carbonic acid from the insoluble residuum of 100 gr. of good guano; and that corresponds to less than 1 $\frac{1}{2}$  per cent. of oxalate of lime in the guano. Sometimes no effervescence at all is to be perceived in treating the washed residuum with acid after its ignition.

15. The carbonate of ammonia in guano is readily determined by filtering the solution of it in cold water, and neutralizing the ammonia with a test or alkalimetric acid (See the Treatise on the Alkalimeter above referred to).

16. Besides the above series of operations, the following researches must be made to complete our knowledge of guano. The insoluble residuum (of 10.) which has been deprived by two successive operations of its uric acid and ammonia, may contain azotized organic matter. It is to be therefore well dried, mixed with five times its weight of the usual mixture of hydrate of soda and quicklime, and subjected to gentle ignition in a glass or iron tube closed at one end, and connected at the other with an ammonia-condensing apparatus. The amount of ammonia being estimated by a proper ammonia-meter, represents the quantity of azote, allowing 14 of this element for 17 of ammonia, being the potential ammonia corresponding to the undefined animal matter. In a sample of Peruvian guano, I obtained 5 per cent. of ammonia from this source.

17. The whole quantity of ammonia producible from guano is to be determined by gently igniting 25 grains of it, previously well dried, and then mixed with ten times its weight of the mixture of hydrate of soda and quicklime (2 parts of the latter to 1 of the former). The ammonia disengaged is condensed and measured as above described.

18. The ready-formed ammonia is in all cases determined by distilling a mixture of 100 grains of it with 50 grains of slaked quicklime, condensing the disengaged ammonia, and estimating it exactly by the meter.

19. The relation of the combustible and volatile to the incombustible



and fixed constituents of guano, is determined by igniting 100 grains of it in a poised platinum capsule. The loss of weight denotes the amount of combustible and volatile matter, including the moisture, which is known from a previous experiment.

20. The insoluble matter is digested in hot water, thrown upon a filter, dried, and weighed. The loss of weight is due to the fixed alkaline salts, which after concentrating their solutions, are to be investigated by appropriate tests—1. nitrate of barytes for the sulphates; 2. nitrate of silver for the chlorides and phosphates; and 3. soda—chloride of platinum, for distinguishing the potash from the soda salts.

21. The insoluble matter (of 20.) is digested with heat, in dilute nitric or hydrochloric acid, and the whole thrown upon a filter. The silica which remains on the filter is washed, ignited, and weighed. The lime, magnesia, and phosphoric acid, which pass through in solution, may be determined as already pointed out.

22. I have endeavoured to ascertain if muriate of ammonia be present in guano, by evaporating its watery solution to dryness, and subliming the residuum; but I have never obtained a satisfactory portion of sal ammoniac; and therefore I am inclined to think there is little of it. The quantity of chlorine to be obtained from guano is too inconsiderable to lead to a suspicion of its presence except in combination with sodium and potassium. Phosphate of soda is also a doubtful product—but if present, it may be obtained from the saline matter (of 20.) by acidulating it with nitric acid; precipitating first with nitrate of barytes, next with nitrate of silver, taking care to use no excess of these two re-agents, then supersaturating the residuum with ammonia, and adding acetate of magnesia, when the characteristic double phosphate of this earth should fall, in case phosphate of soda be present.

By the preceding train of researches, all the constituents of this complex product may be exactly disentangled and estimated; but they manifestly require much care, patience, time, and dexterity, as also a delicate balance, particularly in using the appropriate apparatus for generating the potential ammonia, and for measuring the whole of this volatile substance, separated in the several steps of the process. It may be easily imagined how little confidence can be reposed in many of the analyses of guano, framed, I fear, too often with the view of promoting the sale of an indifferent or even a spurious article of commerce.

A.—I shall now give in detail my analytical results upon three different samples of good South American guano; and next the general results upon three samples of African and Chilian guanos:—

1. Guano from Bolivia, imported by the *Mary and Anne*. This sample was taken by myself, as an average of several bags in the lighter, before the cargo was landed. Pale yellow colour, dry, partly pulverulent, partly concreted in small lumps, with a few small fragments of granite, which being obvious, were separated prior to the analysis. Specific gravity of the pulverulent portion, without granite, 1.60; of the concretions, 1.66; mean, 1.63. Water digested on the former portion is neutral to litmus-paper; on the latter, it is faintly acid.

2. 100 parts lose 6.5 by the heat of boiling water, and exhale no ammonia. When digested and triturated with cold water 30.5 parts dissolve and 69.5 are obtained after drying at 212°. Of those 30.5 parts,

6·5 are therefore water, easily separable, and 24·5 parts are solid matter.

3. 100 parts, mixed with 9 times their weight of water, and 50 of lime, being distilled in an alembic connected with the five-globe condenser, &c., afforded exactly 4·2 of ammonia, 20 grains in fine powder, along with 200 of a mixture, consisting of 2 parts of dry lime and 1 of hydrate of soda were gently ignited in a combustion-tube connected with the ammonia-condensing apparatus, and they produced 4·25 grains of ammonia—equivalent to 21·25 from 100 grains of the guano. Thus only 4·2 per cent. of ammonia were ready formed; while 17·05 lurked, so to speak, in their azotized elements. From its aspect and its want of ammoniacal odour, this guano, the first cargo received from Bolivia, was imagined by its importers to be of bad quality; and accordingly my very favourable report of its analysis surprised them not a little, and rather unsettled the little faith they at that time (January, 1843) had in chemistry. But about a fortnight after the date of my report, they received a letter from Peru apprizing them of the excellence of that cargo of Bolivian guano, and of its being prized by the Americans as possessing fertilizing powers in a pre-eminent degree. I consider this guano, therefore, as a type of the substance in its best state.

II. The soluble matter was analyzed, in the manner already detailed, and was found to consist of—

1. Urea . . . . .	5·
2. Sulphate of potash . . . . .	7·90
3. Chloride of sodium . . . . .	5·
4. Biphosphate of ammonia . . . . .	5·50
5. Oxalate of ammonia . . . . .	0·60

---

24·

In these ammoniacal salts there are only 1·65 parts of ammonia; but I obtained 2·55 grains in distilling the soluble matter of 100 grains of the guano. The remaining 0·9 parts, therefore, must have proceeded from the partial decomposition of the urea during the long ebullition necessary to extract every particle of ammonia, in distilling the guano along with quicklime.

III. The *insoluble* matter = 69·5 parts, was found to consist of—

1. Silica . . . . .	2·25
2. Subphosphate of lime . . . . .	9·00
3. Phosphate of magnesia and ammonia . . . . .	1·25
4. Urate of ammonia . . . . .	15·27
5. Undefined azotized organic matter, affording, with the 14 parts of uric acid, by ignition with hydrate of soda, 17·05 parts of ammonia . . . . .	41·73

---

69·50

---

This result as to the large proportion of organic matter in the dried insoluble residuum was verified by igniting a given quantity of it, when it was found to lose, out of 69·5 parts, 57; corresponding to the 15·27 urate of ammonia, 41·73 of undefined matter, and 0·08 of ammonia,

in the double magnesian phosphate. In the urate and double phosphate are 1.35 of ammonia, which, with the 2.55, make 3.9 parts; the other 0.3 parts may be traced to the urea.

As these results differ very considerably in many respects from those of the analyses made by respectable German chemists, I was careful to verify them by manifold variations of the process.

1. The soluble matter, with acid reaction, of 100 parts of the lumps of the Bolivian guano, was examined by per-acetate of iron and ammonia, for phosphoric acid, and afforded 4 parts of it, which is more than had been found in the neutral pulverulent guano. After the phosphoric acid was separated by that method, chloride of calcium gave no cloud with the filtered liquor, proving that no oxalic acid was present in these nodules. The washed insoluble matter, when gently ignited, and treated with dilute nitric acid, afforded no effervescence whatever, and therefore showed that no oxalate of lime had been present, for it would have become a carbonate.

It is necessary to determine from time to time the quantity of ferric oxide in the acetate or nitrate, as it is liable to be deposited from the solution, when this is kept for some time. If this point be not attended to, serious errors would be committed in the estimation of the phosphoric acid.

2. The quantity of uric acid was verified by several repetitions, and found to be 14 per cent.

3. The undefined organic matter, when deprived of the uric acid by prolonged digestion with weak borax water, being subjected to ignition along with hydrate of soda, yielded the quantity of ammonia requisite to constitute the whole sum, that producible from the uric acid alone being taken into account.

4. The little lumps of the guano afforded, by distillation along with quicklime, 5.27 per cent. of ready formed ammonia, probably from the uric acid being partially decomposed by the moisture which had concentered them. It is a curious fact, that the solution of borax, from being of an alkaline, becomes of an acid reaction, after digestion with the Bolivian guano.

5. For distinguishing and separating the soda salts from those of potash, I tried the antimoniate of potash, according to Wackenroder's prescription, but I found reason to prefer very much the crystallised soda—chloride of platinum, for that purpose.

6. From another specimen of the Bolivian guano, I extracted 3.5 per cent. of the ammonia-phosphate of magnesia.

B. A sample of guano from the Chincha Islands, of nearly the same light colour as the preceding, and the same dryness, being an early importation of 250 tons in the present year, was subjected by me to a careful analysis.

1. The solution in water of this guano had an alkaline reaction from carbonate of ammonia, which, being neutralised by test acid, indicated 0.34 per cent. of ammonia, equivalent to about 1 of the smelling sesquicarbonate.

2. Of this guano, 47 per cent. were soluble in water, and 53 per cent. remained, after drying at a heat of 212° F. Of the above 47 parts, 8.5 were moisture in the guano.

3. The solution being acidulated with nitric acid, was treated with acetate of barytes, in a quantity equivalent to the sulphuric acid present, and it afforded 12 parts of sulphate of barytes. With the filtered liquor, 700 water grain measures of ferric acetate were mixed, and then ammonia in excess; 18.5 parts of washed and ignited subphosphate of iron were obtained, from which 8.8 parts present in the acetate being deducted, 9.7 remain as the quantity of phosphoric acid; but 9.7 of acid produce 13.25 of biphosphate of ammonia, which contain only 2.3 of ammonia, combined with 0.95 of water, or its elements. From the alkaline excess in the guano, there can be no doubt, however, that it contained the subphosphate (*found in the urine of Carnivora*), and not the biphosphate of that base. In this case, 9.7 of acid produce 14.32 of dry saline compound, containing 4.62 of ammonia, which, with the 0.34 of ammonia in the carbonate, constitute a sum of 4.96. To the liquor freed from the phosphate of iron, and acidulated with nitric acid, acetate of lime being added, 3.33 parts of oxalate of this base were obtained, which are equivalent to 3.23 oxalate ammonia, containing 0.89 of ammonia.

4. Nitrate of silver now produced from the filtered residual solution 8 parts of chloride, corresponding to nearly 3 of sal ammoniac, which contain nearly 0.95 of ammonia.

5. The 53 parts insoluble in water were digested with the solution of borax at a boiling heat, thrown on a filter, and the uric acid being precipitated from the filtrate by means of a little hydrochloric acid, washed and dried, was found to weigh 13.5 parts. There were left on the filter 36.5 parts, dried at 212° F., so that 3 parts of soluble organic matter had passed through the filter. These 36.5 parts lost by ignition only 9.7 parts in organic matter, became white, and afforded a very faint effervescence with hydrochloric acid, showing that a very little oxalate of lime had been present. 1.25 parts of silica were left after the action of the acid. To the solution of the 26.55 parts, sulphuric acid was added, and the mixture being heated to expel the hydrochloric and excess of sulphuric acids, the residuary matter was digested and washed with dilute alcohol, and thrown on a filter; the solution of magnesia passed through, while the sulphate of lime remained. After ignition, this weighed 27.5 parts, equivalent to 22 of subphosphate of lime. On supersaturating the filtrate with ammonia, 4.5 parts of the magnesian ammonia phosphate were precipitated, containing 0.32 of ammonia. With the 13.5 parts of uric acid, 1.23 of ammonia had been originally combined, forming 14.73 of urate.

6. 25 grains of the dry guano afforded, by ignition in the combustion-tube along with 200 grains of the mixed lime and hydrate of soda, 4.165 of ammonia, which correspond to 16.66 in 100 parts of the dry, or to 15.244 in the natural state; leaving therefore 5 parts for the quantity of potential ammonia, or of ammonia producible from the decomposition of its azotized organic matter. This guano is therefore well adapted to promote permanently the fertility of a soil. It yields besides to alcohol a notable quantity of urica, which I did not think it worth while to determine quantitatively, and from which undoubtedly a portion of the ammonia proceeded, in the distillation with milk of lime.

7. 100 parts afforded by distillation with milk of lime, 10·2 of ammonia.

8. The total constituents of that guano, being tabulated, are—

I. Matter soluble in water . . . . 47·00

consisting of—

1. Sulphate of potash, with a little sulphate of soda . . . . .	6·00	Ammonia.
2. Muriate of ammonia . . . . .	3·00	0·95
3. Phosphate of ammonia . . . . .	14·32	4·62
4. Sesqui-carbonate of ammonia . . . . .	1·00	0·34
5. Sulphate of ammonia . . . . .	2·00	0·50
6. Oxalate of ammonia . . . . .	3·23	0·89
8. Water . . . . .	8·50	
9. Soluble organic matter and urea . . . . .	8·95	

47·00

II. Matter insoluble in water . . . . 53·00

consisting of—

1. Silica . . . . .	1·25	
2. Undefined organic matter . . . . .	9·52	
3. Urate of ammonia . . . . .	14·73	1·23
4. Oxalate of lime . . . . .	1·00?	
5. Subphosphate of lime . . . . .	22·00	
6. Phosphate of magnesia and ammonia . . . . .	4·50	0·32

53·00

9·80

The remaining 1·25 of *actual* ammonia may be fairly traced to the partial decomposition of the urea during the distillation with lime; and the 5 per cent. of potential ammonia proceeded from the transformin decomposition of the uric acid.

C. Foliated guano, from Peru, in caked pieces, the layers very thin, parallel, and interspersed with white streaks. This guano was somewhat dense for a pure specimen, having a specific gravity of 1·7. The insoluble matter afforded by digestion with borax water, no less than 25·2 per cent. of pale yellow uric acid; 9 of other combustible organic matter, and 15 of earthy matter: consisting of silica, 3·5; phosphate of magnesia and ammonia, 6·5; and only 5 of subphosphate of lime or bone earth. It lost 10 per cent. when dried in a heat of 212° F. The remaining 30·8 parts soluble in water had a strong acid reaction, and afforded by ferric acetate and ammonia 6 of phosphoric acid, equivalent to 9·7 of crystallized biphosphate of ammonia, after acetate of barytes had separated the sulphuric acid. No less than 17 parts of chloride of silver were obtained, by precipitating with nitrate of silver the liquor filtered from the phosphate of iron, and acidulated with nitric acid. As the present is an accidental sample, and not an average of any importation, I did not prosecute the research further.

D. *Chincha Guano*, of a somewhat darker colour than the preceding, and alkaline reaction; specific gravity, 1.62. Digested with water and strained, 56.75 parts remained after drying it at 212° F. The solution, evaporated and dried also at 212°, afforded 31.25 of saline matter. This saline mass being mixed with four-fifths of its weight of slaked lime, nine times its weight of water, and distilled, afforded of ammonia 14.28 per cent. Some chemists have prescribed potash instead of lime, for separating the ammonia in distillation; but no person of intelligence who has made the experiment will choose to repeat it, because the potash forms with the organic matter of the guano a viscid compound, that froths up like a mass of soap-bubbles, and coming over with the vapours, obstructs and vitiates the result.

2. When dried altogether by a steam heat, 100 parts lost 12 in moisture; whereas by evaporating and drying the soluble matter by itself, the loss amounted to 16.3, no doubt by the dissipation of some of the ammoniacal salts; for 100 parts of the entire guano afford, by distillation with quicklime, 9 parts of ammonia, and by the transforming decomposition with hydrate of soda and lime 16.25, indicating 7.25 of *potential* ammonia, in addition to the 9 of ready formed. The insoluble matter of 100 parts afforded to borax water a solution containing 16.5 of uric acid, corresponding to 18 of urate of ammonia. There remained on the filter, after drying it at 212° F., only 33.8 parts; so that about 5 parts of soluble organic matter had passed through the filter in the borax water. These 33.8 consisted of subphosphate of lime 17, magnesian phosphate of ammonia 5.5, silica 0.7, and combustible organic matter 10.6.

The ammonia in the soluble portion was in the state chiefly of phosphate; there was merely a faint trace of oxalate of ammonia.

E. *African Guano*.—Among the many samples of African guano which I have had occasion to analyze for the importers, none has contained any appreciable quantity of uric acid, or of consequence of potential ammonia. The best afforded me 10 per cent. of ready-formed ammonia, existing chiefly in the state of a phosphate, though they all contain carbonate of ammonia, and have of consequence an alkaline reaction. The said sample contained 21.5 of moisture, separable by a heat of 212° F. Its specific gravity was so low as 1.57, in consequence of the large proportion of moisture in it. It contained 23 per cent. of subphosphate of lime, 3 of magnesian phosphate of ammonia, 1 of silica, and 1.5 of alkaline sulphate and muriate. The remaining 50 parts consisted of decayed organic matter, with phosphate of ammonia, and a little carbonate, equivalent to half a grain of ammonia, which is the largest quantity in such guanos. Other African guanos have afforded from 24 to 36 of moisture; no uric acid; no potential ammonia; but decayed organic matter; from 5 to 7 of ready formed ammonia in the state of phosphate, with a little carbonate; from 25 to 35 per cent. of subphosphate of lime; 5 or 6 of the magnesian phosphate of ammonia; more or less oxalates from the decomposition of the uric acid, and 3 to 5 per cent. of fixed alkaline salts.

F. The *Chilian Guano* gathered on the coast contains a remarkable proportion of common salt, derived probably from the sea spray.

The following is the General Report of the chemical examination

of several samples of guano, which I made for Messrs. Gibbs of London, and Messrs. Myers of Liverpool, the co-agents of the Peruvian and Bolivian governments :—

“In these various analyses, performed with the greatest care, and with the aid of the most complete apparatus for both inorganic and organic analysis, my attention has been directed not only to the constituents of the guano which act as an immediate manure, but to those which are admitted by practical farmers to impart durable fertility to the grounds. The admirable researches of Professor Liebig have demonstrated that AZOTE, the indispensable element of the nourishment of plants, and especially of wheat and others abounding in gluten (an azotized product), must be presented to them in the state of *ammonia*, yet not altogether ammonia in the pure or saline form, for, as such, it is too readily evaporated or washed away; but in the dormant, or as one may say, in the *potential* condition in contradistinction from the *actual*. Genuine Peruvian and Bolivian guanos, like those which I have minutely analyzed, surpass very far all other species of manure, whether natural or artificial, in the quantity of *potential* ammonia, and, therefore, in the permanency of their action upon the roots of plants, while, in consequence of the ample store of *actual* ammonia which they contain ready formed, they are qualified to give immediate vigour to vegetation. Urate of ammonia constitutes a considerable portion of the azotized organic matter in well-preserved guano; it is nearly insoluble in water, not at all volatile, and is capable of yielding to the soil, by its slow decomposition, nearly one-third of its weight of ammonia. No other manure can rival this animal saline compound. One of the said samples of guano afforded me no less than 17 per cent. of potential ammonia, besides  $4\frac{1}{2}$  per cent. of the actual or ready formed; others from 7 to 8 per cent. of ammonia in each of these states respectively. The guanos which I have examined are the mere excrement of birds, and are quite free from sand, earth, clay, and common salt, reported in the analyses of some guanos, and one of which (sand) to the amount of 30 per cent. I found myself in a sample of guano from Chile.

“The Peruvian guano, moreover, contains from 10 to 25 per cent. of phosphate of lime, the same substance as bone-dust, but elaborated by the birds into a pulpy consistence, which, while it continues insoluble in water, has been thereby rendered more readily absorbable and digestible (so to speak) by the roots of plants. I have therefore no doubt, that by the judicious application of these genuine guanos, mixed with twice or thrice their weight of a marly or calcareous soil, to convert their phosphate of ammonia into phosphate of lime and carbonate of ammonia, as also to dilute all their ammoniacal compounds—such crops will be produced, even on inferior lands, as the farmer can scarcely raise upon more improved soils by ordinary manure. To the West India planter, guano will prove the greatest boon, since it condenses in a portable and inoffensive shape the means of restoring fertility to his exhausted cane-fields, a benefit it has long conferred on the poorest districts of Peru.

“I respectfully observe, that no analysis of guano hitherto made public at all exhibits the value of the cargoes referred to above, while none gives the quantity of ammonia dormant in the azotized animal matter of the bird's dung, which, called into activity with the seeds in the soil, be-

comes the most valuable of its constituents, as a source of perennial fertility. In the detailed account of my analyses of this complex excretion (now preparing for publication), all the above statements will be brought within the scope of general comprehension. I shall also describe my 'ammonia generator,' based on the process invented in the laboratory of Professor Liebig, and also my 'ammonia meter,' which, together, can detect and measure one-hundredth part of a grain weight of absolute ammonia, whether potential or actual, in any sample of guano.

"Meanwhile the following may be offered as the average result of my analyses of genuine guano in reference to its agricultural value:—

1. Azotized animal matter, including urate of ammonia, together capable of affording from 8 to 16 per cent. of ammonia by slow decomposition in the soil . . . . .	50	0
2. Water . . . . .	11	0
3. Phosphate of lime . . . . .	25	0
4. Phosphate of ammonia, oxalate of ammonia, ammonia—phosphate of magnesia, together containing from 5 to 9 parts of ammonia . . . . .	13	0
5. Siliceous sand . . . . .	1	0
	<hr/>	
	100	0

"Very moist guano has in general more actual and less potential ammonia than the dry guano.

"ANDREW URE.

"London, 13, Charlotte Street, Bedford Square,  
"February 14th, 1843."

Oellacher's analysis of a brownish yellow guano is as follows:—

		Ammonia.
1. Urate of ammonia . . . . .	12·20	1·07
2. Oxalate of ammonia . . . . .	17·73	6·50
3. Oxalate of lime . . . . .	1·30	
4. Phosphate of ammonia . . . . .	6·00	1·79
5. Phosphate of ammonia and magnesia . . . . .	11·63	1·68
6. Phosphate of lime . . . . .	20·16	
7. Muriate of ammonia . . . . .	2·25	0·72
8. Chloride of sodium (common salt) . . . . .	0·40	
9. Carbonate of ammonia . . . . .	0·80	0·23
10. Carbonate of lime . . . . .	1·65	
11. Sulphate of potash . . . . .	4·00	
12. Sulphate of soda . . . . .	4·92	
13. Humate of ammonia . . . . .	1·06	0·09
14. Substance resembling wax . . . . .	0·75	
15. Sand . . . . .	1·68	
16. Water (hygroscopic) . . . . .	4·31	
17. Undefined organic matter . . . . .	8·26	
	<hr/>	
	100·00	12·07

I am satisfied from the large proportion of oxalate of ammonia that the sample thus analyzed was by no means a fair or normal specimen of



guano; and it is in fact widely different from all the fresh samples which have passed through my hands. It is described as "Knobby, being mixed with light laminated crystalline portions, in white grains, from the size of a pea to that of a pigeon's egg." Having some lumpy concretions of a similar aspect in my possession, I submitted them to chemical examination.

G. 1000 grains being digested in boiling water and strained, afforded a nearly colourless solution. This was concentrated till crystals of oxalate of ammonia appeared. It was then acidulated with hydrochloric acid, to protect the phosphoric acid from precipitation, and next treated carefully with solution of nitrate of lime equivalent to the oxalic acid present. The oxalate of lime thus obtained being converted into carbonate weighed 80·5 grains, corresponding to 100 of oxalate of ammonia, or 10 per cent. of the guano.

The liquor filtered from the oxalate was precipitated by nitrate of barytes, and afforded 112 grains of sulphate of barytes=38 sulphuric acid; and the last filtrate being mixed with a given measure of ferric acetate, and the mixture supersaturated with ammonia, yielded subphosphate of iron, equivalent to 5 per cent. of phosphoric acid. I digested with heat other 500 grains of the same guano in a weak solution of borax, filtered, acidulated the liquid, but obtained merely a trace of uric acid. It is clear therefore that the oxalate of ammonia had been formed in this guano at the expense of the uric acid, and that its concreted state, and the crystalline nodules disseminated through it, were the result of transformation by moisture in a hot climate, which had agglomerated it to a density of 1·75; whereas clean fresh guano friable and dry like the above, is seldom denser than 1·65. This guano contained only 3·23 of ammonia; 65 of insoluble matter, 53 of earthy phosphates, 5 silica, 3 alkaline salts (fixed), and 7 organic matter.

Oxalate of ammonia, being readily washed away, is a bad substitute for the urate of ammonia, urea, and azotized animal matter, which it has replaced. Oellacher could find no urea in the guano which he analyzed; another proof of its disintegration.

Bartels' analysis of a brown-red guano is as follows:—

1. Muriate of ammonia . . . . .	6·500
2. Oxalate of ammonia . . . . .	13·351
3. Urate of ammonia . . . . .	3·244
4. Phosphate of ammonia . . . . .	6·450
5. Substances resembling wax and resin . . . . .	0·600
6. Sulphate of potash . . . . .	4·277
7. Sulphate of soda . . . . .	1·119
8. Phosphate of soda . . . . .	5·291
9. Phosphate of ammonia and magnesia . . . . .	4·196
10. Common salt . . . . .	0 100
11. Oxalate of lime . . . . .	16·360
12. Alumina . . . . .	0·104
13. Sand insoluble in nitric acid, and iron . . . . .	5·800
14. Loss (water and volatile ammonia and undefined organic matter) . . . . .	22·718

---

100·000

Voelckel, in his analysis of guano, states 7 per cent. of oxalate of lime; a result quite at variance with all my experience, for I have never found so much as 2 per cent. of carbonate of lime in the washed and gently ignited insoluble matter; whereas, according to Bartels and Voelckel, from 10 to 5 per cent. of carbonate should be obtained, as the equivalents of the proportions of the oxalate assigned by them.

All these analyses are defective, moreover, in not showing the total quantity of ammonia which the guano is capable of giving out in the soil; and, since it appears that the freshest guano abounds most in what I have called *potential* ammonia, it must possess, of consequence, the greatest fertilizing virtue.

A sample of decayed dark-brown moist guano, from Chile, being examined, as above described, for oxalate of ammonia, was found to contain none whatever; and it contained less than 1 per cent. of uric acid.

An article offered to the public, by advertisement, as Peruvian guano, was lately sent to me for analysis. I found it to be a spurious composition: it consisted of—

1. Common salt . . . . .	31·5
2. Common siliceous sand . . . . .	28·0
3. Sulphate of iron or copperas . . . . .	5·2
4. Phosphate of lime . . . . .	4·0, with
5. Organic matter from bad guano (to give it smell)	23·3
6. Moisture . . . . .	8·0
	100·0

Genuine guano, when burned upon a red-hot shovel, leaves a white ash of phosphate of lime and magnesia; whereas this factitious substance left a black fused mass of sea-salt, copperas, and sand. The specific gravity of good fresh guano is seldom more than 1·66, water being 1·00; whereas that of the said substance was so high as 2·17; produced by the salt, sand, and copperas.

---

#### ERRATUM.

At page 45—see Art. V. in the points for cows—for 4 points read 3—which correction accounts for 30 points, or perfection in milch cows.

THE  
JOURNAL

OF THE

ROYAL AGRICULTURAL SOCIETY  
OF ENGLAND.

VOLUME THE FIFTH.

1845.

PART II.

---

PRACTICE WITH SCIENCE.

---

LONDON:  
JOHN MURRAY, ALBEMARLE STREET.

MDCCCXLV.

THESE EXPERIMENTS, IT IS TRUE, ARE NOT EASY; STILL THEY ARE IN THE POWER OF EVERY THINKING HUSBANDMAN. HE WHO ACCOMPLISHES BUT ONE, OF HOWEVER LIMITED APPLICATION, AND TAKES CARE TO REPORT IT FAITHFULLY, ADVANCES THE SCIENCE, AND, CONSEQUENTLY, THE PRACTICE OF AGRICULTURE, AND ACQUIRES THEREBY A RIGHT TO THE GRATITUDE OF HIS FELLOWS, AND OF THOSE WHO COME AFTER. TO MAKE MANY SUCH IS BEYOND THE POWER OF MOST INDIVIDUALS, AND CANNOT BE EXPECTED. THE FIRST CARE OF ALL SOCIETIES FORMED FOR THE IMPROVEMENT OF OUR SCIENCE SHOULD BE TO PREPARE THE FORMS OF SUCH EXPERIMENTS, AND TO DISTRIBUTE THE EXECUTION OF THESE AMONG THEIR MEMBERS.

VON THAER, *Principles of Agriculture.*

## CONTENTS OF PART II., VOL. V.

ARTICLE	PAGE
XV.—On the Agriculture of Norfolk. By Barugh Almack . . . . .	307
XVI.—On White Mustard. By George Jesty . . . . .	358
XVII.—On the Growing of White Mustard as a Green Crop for Sheep. By John Gray, Agent of F. & H. Dickinson, M.P. . . . .	360
XVIII.—Report on the Exhibition of Implements at the Southampton Meeting, in 1844. By Josiah Parkes, Consulting Engineer to the Society . . . . .	361
XIX.—On the Allotment System. By Sir Henry E. Bunbury, Bart. . . . .	391
XX.—Trial of several Artificial Manures. By William Miles, Esq., M.P. . . . .	394
XXI.—Some Account of the Process of Warping. By Ralph Creyke . . . . .	398
XXII.—On the occurrence of Phosphorite in Estremadura. By Charles Daubeny, M.D., F.R.S., F.G.S., Professor of Chemistry, &c., Oxford; and Captain Widdrington, R.N., F.R.S., F.G.S., &c. &c. . . . .	406
XXIII.—Instance of the advantage of Subsoil-ploughing in addition to Draining. By George Turner . . . . .	418
XXIV.—A few Remarks on the large Hedges and small Enclosures of Devonshire and the adjoining Counties. By John Grant, Surveyor and Land Agent . . . . .	420
XXV.—On the Indications of Fertility or Barrenness of Soils, whether of Colour, Consistence, or Vegetation. By John Arkell . . . . .	429.
XXVI.—On the Use of Bones as a Manure with Sulphuric Acid . . . . .	443—468
1. Experiments at the Home Farm of Gordon Castle, Morayshire, in 1843, with the effect on the crop in 1844. From the President, His Grace the Duke of Richmond.	
2. On the Use of Bones with Sulphuric Acid. By E. Wagstaff.	
3. On Bones with Sulphuric Acid and other Manures. By R. W. Purchas.	
4. Report by the Committee appointed by the Morayshire Farmer Club to examine the Experiments made by Candidates for the Premiums offered for the Growth of Turnips by new Manures—Season 1843. Communicated by the President, His Grace the Duke of Richmond.	
5. On the Action and Application of Dissolved Bones.—By John Hannam.	
XXVII.—Observations on the Natural History and Economy of various Insects affecting the Corn-Crops, many of them improperly called Wireworms; including Ground-beetles, Chaffers, or May-bugs, also the Caterpillars of a Moth and Saw-fly, and the Larvæ of some minute Flies. By John Curtis, F.L.S., Corresponding Member of the Imperial and Royal Geographi Society of Florence; of the Academy of Natural Sciences of Philadelphia; &c. Paper VII. . . . .	469
XXVIII.—On Peat Charcoal as a Manure for Turnips. By W. Uppleby . . . . .	507

CONTENTS.

ARTICLE	PAGE
XXIX.—On the Breeding and Management of Horses on a Farm. By John Burke, Jun. . . . .	508
XXX.—On the Cultivation of Flax. By G. Nicholls, Esq. . . . .	547
XXXI.—On the cheapest Method of making and burning Drain- ing Tiles. By T. Law Hodges . . . . .	551
XXXII.—On the Indications which are practical Guides in judg- ing of the Fertility or Barrenness of the Soil. By John Bravender, F.G.S., Land-Surveyor, Cirencester. Prize Report . . . . .	559
XXXIII.—Addition to Mr. Hannam's Paper on Sulphuric Acid, &c.	594

MISCELLANEOUS COMMUNICATIONS AND NOTICES:—

XI.—Thin-Sowing of Wheat . . . . .	597
XII.—On Grafting Turf. By B. Baker . . . . .	600
XIII.—On the application of Sulphate of Ammonia to Wheat. By John Barton . . . . .	601
XIV.—On Socket Drain-Pipes. By H. Dixon . . . . .	603
XV.—Experiments on the Use of old Hop-bines as Manure in Hop-Gardens. By Sir John M. Tylden . . . . .	604
XVI.—Trial of Superphosphate and other Manures. By Ed- ward Strouts . . . . .	605
XVII.—On Medical Treatment for Sick Trees. By Sir C. Lemon, Bart., M.P. . . . .	606
XVIII.—A Plan to prevent the Waste of Manure in Rivers which flow through Towns. By W. Popham, Esq., B.A., Oriel College . . . . .	610
XIX.—On the Hainault Scythe. By the Right Hon. Sir G. H. Rose, Bart. . . . .	611
XX.—On the Analysis of Soils. By Andrew Ure, M.D., F.R.S., &c. . . . .	614
XXI.—On Stacking Sainfoin. By the Earl of Essex . . . . .	622
XXII.—Experiment on Manures. By Isaac Everitt . . . . .	623

APPENDIX.

Council and Officers of the Royal Agricultural Society of England	xxxix
Honorary Members . . . . .	xl
Report of the Council (General Meeting, Dec. 14, 1844) . . . . .	xli
Statement of Accounts . . . . .	xlvi
Statement of Receipts and Payments at Southampton . . . . .	xlvii
Award of Prizes at the Southampton Meeting . . . . .	xlviii
Commendations . . . . .	lv
Prizes for the Shrewsbury Meeting, 1845 . . . . .	lviii
Essays and Reports on Various Subjects . . . . .	lxiii
Rules of Competition for Prize Essays . . . . .	lxvi
General Meetings of 1845 . . . . .	lxviii

LIST OF PLATES.

Plate K., Insects affecting the Corn-Crops, to face page . . . . .	506
Plates (2) of Agricultural Weeds, to face page . . . . .	573

XV.—*On the Agriculture of Norfolk.* By BARUGH ALMACK,  
Land Agent.

I ENTERED Norfolk as a stranger, fully aware that it had long been considered the best cultivated county in the kingdom; therefore any impression, from the view presented to me, was not so likely to be favourable for the district. Yet, in many respects, as the abundance and regularity of the crops, the neatness of the drilling, the straightness and regularity of the ploughing, my expectations were more than realised; in short, good drilling and good ploughing are the "rules" of the whole county,—bad drilling, or bad ploughing, so much the exception, as scarcely to be seen in it. Again, in that very difficult part of farming, the securing a good plant of clover where land has been long under the four-course system, the farmers of Norfolk seemed to me infinitely before any others I had seen: so much so, indeed, that although I consequently looked out to detect failures if possible, yet, in riding through nearly every part of the whole county, I only observed about five or six fields where the clover was decidedly "patchy," and, on inquiry, found these had been treated differently from the general plan. Those abundant crops, it must be remembered, were growing, in many places, on an entirely artificial soil. The recent desert of white blowing sand had been converted into the most fruitful land, by the well-directed industry of the people; the materials for the change not being found on the spot, in some cases, but brought from a distance. Indeed, in the permanent improvement of the soil, by claying, marling, &c., the people of Norfolk are probably not excelled by any, and few will bear a comparison with them; therefore I recommend all who have what they consider a barren estate of worthless acres, to take a tour through the county, and see for themselves what may be done in such cases, if I should fail in explaining it to them.

Having said thus much in favour of Norfolk farming, I must in fairness state that I think there are other counties more likely to attract admiration from those who pass through each hastily, without possessing practical knowledge of the subject. For there is not, generally, so great attention paid to effect and neatness of appearance here, as in some districts which I could name, if we except the drilling and the ploughing. Thus, the corn-ricks show that, whilst the farmers of some other districts were thinking how to place and build theirs so as to have the neatest appearance, many of the Norfolk farmers were only thinking how they should put their corn together in the least possible time.

## STATE OF THE DRAINAGE.

Few agricultural readers will expect to see much respecting drainage in a report of Norfolk, as few will suppose there is any necessity for draining in a district generally considered not only sandy, but dry. Whereas, in fact, almost every variety of drainage may be found in Norfolk, and there are few places to be named from whence you can go many miles without finding drains of some sort; indeed, even where the largest quantities of clay have been used, to qualify a blowing sand, the land has, in many instances, undergone extensive drainage. The marshes and fens in the neighbourhood of Lynn and Downham are drained by machinery, so as to throw the water out of the drains in the lowest levels into raised channels capable of conveying it to the outfalls. Wind was the power applied to this purpose until recently, and even now there are in some places so many wind-engines erected for draining, as to remind us of the corn-mills near populous towns. Yet these are at present little more than proofs of the truth of the history of the adjoining levels. So long as no power was known more suitable, it was all very well to make good use of that which they had, when they could; but, it has been observed, *there is generally least wind during the time of the greatest floods*, that is, when draining-mills are most required. Who then can be surprised that steam should be applied to the purposes of draining? And, accordingly, nearly the whole of this district is now effectually drained by the use of steam-engines. One of these, of 60-horse power, has recently been erected in the Feltwell New Fen District, at an expense (for the engine, and house, &c.) of about 4000*l*. This engine, made by Messrs. Headley and Hawthorne of Newcastle, drains 7000 acres of fen and 1000 acres of high land, and is supposed to be capable of draining double the extent if necessary.

The low land east of Norwich, irregular in breadth, but extending from that city to Yarmouth, is partially drained by steam-power also; but this must be more generally applied before the draining can be effectually done. The owners of land in the neighbourhood are becoming aware of this, and probably a few years hence it may be found one of the most productive tracts in the kingdom.

Navigation is not the only interest which has occasionally proved an obstacle to effectual drainage. In one district land was pointed out to me as suffering from water being kept high in the drains around it, that it might in its main course drive the wheel of a corn-mill. Thus the water-power of the miller, although cheap to him, was not so to the community. The loss in produce from the land around was very great, and the direct injury



to the occupiers in that proportion. As it is of the greatest national importance to remove any clog on the cultivation of the soil, surely a power might be given to remove such a check as this, on amply compensating the party whose particular interest may stand in the way.

As the Society require to know "the state of the drainage," and not the details of the manner in which drainage is performed, I do not, in the abundance of other matter, dwell on these; and, so much having been recently written on the subject, it seems unnecessary to do so.

#### FENCES.

The farmers of Norfolk (as a body) do not excel in the management of hedges, but rather the contrary; though some of them think that Mr. Blakie's remarks, in his work on Hedges, will apply with too much truth even at the present time, and that there is much land wasted by having *a wide ditch added to the large fence on a high bank*, where in many cases, especially on arable land, a low and narrow fence, on the level, without a ditch, would answer every useful purpose, and not be so likely to fill the adjoining land with weeds.

Probably few have passed Mr. Cambridge's farm at South Runcton (on the road from Downham Market to Lynn) without admiring the neatness of all the hedges on it, which are cut in this  form. One which I measured was nine inches wide at the top and twenty inches at the bottom.

Neat hedges may be seen at Acle, Thrigby, Quidenham, and other places, but these are the exceptions, not the common fences of the county.

#### CLAYING, MARLING, &c.

The farmers of Norfolk shine most particularly in their improvement of the texture, and therefore of the productive qualities, of the soil itself. This may be owing to their having been placed under such circumstances as to draw their attention forcibly to this important branch of agriculture. There are few soils of so happy a texture as not to admit of improvement by a mixture of some sort, but, where the faults are not very glaring, our attention is not so likely to be devoted to their correction, as when we find our onward progress effectually impeded by an evil which must be faced and removed before we can make any good progress. Thus the occupier of the light blowing sand could not for any long period avoid observing its glaring defects, and even if he had never heard of a remedy, some chance circumstance would point one out, by placing before him an improvement on a small scale, which, to a careful and shrewd observer, would be a suffi-

cient index of the result to be expected from the trial of the same means to a greater extent.

Some soils are so very different from what they ought to be, as to justify a greater quantity per acre of clay, chalk, or marl, as the case may be, than would be proper on other soils: therefore, those unaccustomed to the consideration of the matter ought to have that circumstance strongly impressed on their minds, before they try new experiments on their own soil. Even supposing the only object is to obtain a soil of the most perfect texture and quality, whatever the cost of doing so may be, yet the quantity to be conveyed must not be a certain number of loads per acre, but should be regulated in each case, not only by the nature of the original soil, but also of that which is carried upon it. In some cases a smaller quantity would be sufficient; and, if more were taken, the excess might become a positive injury, in addition to the cost of labour. Having discovered what proportion is most beneficial to apply, those who design to make improvements on the soil for the purpose of profiting by them at once, first endeavour to ascertain whence it can be brought at the least comparative cost; then, whether the maximum quantity would, if brought, pay the largest profit, or whether a smaller quantity might not pay better, bearing in mind the distance it has to be brought. Many considerations affect the proper settlement of this last question, as appears from the experience of the Norfolk farmers; but they generally agree in thinking that it is better to clay more frequently than to run any risk of putting on too large a quantity at once. It generally happens that the required remedy may be found very near where it is wanted, and a bed of clay in one part of a field may be at once the ready means of improvement to all the rest of it, which was before a blowing sand. The tenacious soil taken out of a ditch, as a matter of necessity in improving the drainage, may at the same time be applied as a valuable means of correcting the texture of a sandy soil within a short distance of it, whilst part of the too sandy soil may be brought, in returning, to the low tenacious land, so as to furnish its quota to the general improvement. In some cases, that which is most required lies buried under the very soil itself, and I have no hesitation in saying that the value of many millions sterling is buried under what is now comparatively unproductive soil, in England alone. As an instance, I was shown in Norfolk, what a gentleman called "his hidden jewel," so *near the surface*, that one plunge of his walking-stick convinced me it would be practicable to bring up sufficient by merely ploughing deeply with the common plough, the first time he broke up the land, which he said he intended doing immediately after the tithe-rent charge was apportioned. On the surface was light "fen," to a

common observer apparently of little value, yet immediately below was the valuable slate-coloured clay, ready for its improvement.

In the fens near Downham this clay is from 4 to 6 feet below the surface. Pits, about 6 feet by 3, and 3 feet apart, are dug in rows, generally 2 rows in a chain (of 22 yards), and taking out 2 or 3 spits deep of clay from each pit. In digging one pit, part of the peat is put in that which was last made. The space between the pits is very necessary; one of the men whom I saw at work, appeared, notwithstanding this caution (as well as having a piece of wood to support the sides), to run some risk of being buried by the peat. In another place, within a short distance, the peat stood much better. The cost varied; being under or over 50s. per acre, according to circumstances; but it is *very well repaid* by the crops of red clover, wheat, and beans, which the land will afterwards grow. Where this slate-coloured clay is near the surface, and the land in 12-furrow "stetches," the following method is occasionally adopted by Mr. Hudson of Castle Acre, on his farm at Seech:—Two of the "stetches" are ploughed *outward*, so as to leave a trench between them, to get out the clay for casting on each side. This saves some labour in digging for it. Most farmers have occasionally observed whole fields ploughed outward; the ploughs commencing at the outside and following each other round the field until it is finished. Mr. Hudson's plan of raising a swamp is just reversing that system,



and "taking the land up." By two or three such ploughings, he calculates, the land may be raised as much as by 500 loads per acre carted on to it.

As Mr. Cambridge of South Runcton enjoys the honourable reputation, among his brother farmers in the county, of having made great improvements by claying, &c. (the exact expression of it being, "Probably no other farm in the county owes so much to its occupier; for, when he first took it, a large proportion was nothing but a white blowing sand"), I here insert a correct statement of the quantities of clay which he has spread on some of his fields. I do not give the whole list of what he has applied at his own expense as a tenant farmer, but I hope there is sufficient to show how great a debt of obligation is owing to such men by the country, as well as by individuals whom they more directly benefit.

	A.	R.	P.	Loads of Clay-
1. Brets Field . . . .	13	2	37	1,964
2. East Field . . . .	11	0	16	524
3. 12 Acres . . . .	12	2	21	1,780
4. 11 Acres . . . .	12	2	0	1,770
5. 13 Acres . . . .	13	2	26	320
6. Barn Close . . . .	17	1	6	3,407
7. Park Piece . . . .	24	0	10	2,163
8. Chapel Field . . . .	20	3	34	2,310
9. Town Close . . . .	11	3	16	3,634
10. The Sinks . . . .	6	0	7	2,895
11. Moor Field . . . .	21	3	8	5,545
12. Forston Lot . . . .	10	3	16	3,451
13. Thorp Lot . . . .	24	1	29	4,900
14. Barn Lot . . . .	26	3	33	5,852
15. Chiswick Lot . . . .	23	1	11	5,920
16. Warren Lot . . . .	22	2	22	5,280
17. The Grazings . . . .	12	3	13	2,340
	286	2	25	54,055

Thus 54,055 loads have been applied to 286A. 2R. 25P., or, on an average, 188 loads per acre; but, if we observe the quantities named opposite each field, the real quantity allowed per acre has varied greatly, according to circumstances. Of course this includes repeated elayings to some of the fields. There are now several acres of clay-pits on the farm, rendered in some degree ornamental by being planted, and forming lasting proofs of the persevering spirit of Mr. Cambridge. His farm is selected as a favourable specimen of what has been done for the soil in Norfolk, and to account for its present productive state; but, so far from being a solitary instance of such improvements, the practice has been almost universal throughout the county, the quantity of clay applied varying according to circumstances. Mr. Keppel, of Lexham Hall, has made great improvement in his light sandy land, by claying it at the rate of 50 loads per acre.\* Near Swaffham I observed some men elaying a field from a pit nearly in the centre of it; they were paid at the rate of one halfpenny per barrowfull, or 7*d.* per "load;" their orders being to apply 80 such loads per acre; making the cost of it under 50*s.*, though the work was done without the use of horses; employment being thus found for more labourers, without fear, too, of injury to the land by its being cut in using earts when not sufficiently dry. The propriety of using carts, or barrows only, must depend on the distance of the elay from the land where it is wanted, and the abundance or scarcity of manual labour to be obtained. It is hardly necessary to repeat, that each of these circumstances has its effect on the cost; so that no price can be named which would apply in all situations. Mr. Hudson leaves a small part of each land, or

\* Mr. Hudson states, that the late Mr. Garwood of W. Lexham clayed or marled upwards of 1000 acres twice over, at the rate of 40 loads per acre each time, during the first eight years of his lease.

“stetch,” in the stubble fields, unploughed, just as wide as the cart, that the wheels may pass along each furrow on a firm bottom, the horse walking in the centre of the part not ploughed. By this means the whole of the clay required is laid in heaps near where it is wanted, and with a saving of labour to the horses; and, when there, the remainder of the land can be ploughed and made ready for the clay to be spread over it, so as to receive the beneficial effects of frost.

A remarkable instance of improvement made in land by mixing the top soil with that below it may be seen at Stratton Strawless, the property of Mr. Marsham; the part I allude to being cultivated under his direction. There is still sufficient left in its original state, to show that Gray’s description of it, in his letter to Dr. Wharton—“on one side a barren black heath, on the other a light sandy loam”—was probably very correct, as well as to justify us in supposing that it did not acquire so singular a name without reason. Yet, at Stratton Strawless, in August, 1843, I found the crops on the cultivated part of the land fully as good as any elsewhere; and, in one field, observed turnips (a second crop, after a mixed crop of tares and rye, eaten off by sheep *the same season*) which *then* looked as well as any other turnips in the whole county. The first step towards this great improvement was a mixture of the soils, by trenching it deeply, thus:—A trench is opened 3 or 4 feet wide and 2 spades deep, the bottom of the trench then turned up with a spade or three-pronged fork. The flag (or surface growth, &c.) is then thrown in upon the last named, or bottom of the trench, and the second spade put to the top.

Some may say this is an exchange of soils; and so it is, but no such operations can be performed without some mixture of the two, from the succeeding ploughings and subsoil ploughings, although, in the first instance, the subsoil plough only breaks the lower soil.

The land intended for turnips is subsoiled (the whole of one of these farms having now been done twice), even where the wheat stubble has been sown immediately after harvest, with rye for the ewes and their lambs in the spring; yet time is taken to apply the subsoil plough to the whole, after the rye has been fed on the land and before it is sown for turnips.

#### MANURES.

The farm-yard manure of Norfolk is almost invariably *saturated with the essence of linseed-cakes*, these being given in abundance to the cattle. Whether made in open yards or under cover, *linseed-cake is the great improver of their dung*, although there are called to its aid many other manures, such as bones, soot, &c. Many

persons give their cart-horses green food in the yards or boxes during summer, such as tares, lucern, trefoil, clover. They also carry into their yards all the vegetable matter they can readily collect. When within a moderate distance of the coast, they spread sea-sand in their yards, loose boxes, sheds, stables, &c., to absorb the liquid manure. I would particularize Mr. Browne of Thrigby as doing this, though there are many others along the coast. Refuse-fish also is mixed with sea-sand or mould. Mr. J. H. Holley, of Aylsham Burgh Hall, uses very large quantities of sprats as manure for turnips. He mixes about one ton of them with eight or ten loads of mould, and finds that a ton and a half of these fish per acre will produce a good crop from very ordinary land; never having failed in any season. The mould for this mixture is obtained from the borders of the field where the turnips are grown, and the carting of it does not cost more than the carting of 20 tons of yard-manure. Brewers' grains are also in some instances used as manure; they are supposed to pay best when mixed with farm-yard manure. Some of the best farmers are decidedly in favour of using dung fresh from the yard. Mr. Blomfield of Warham is one of these. Mr. John Baker, who for twenty-five years "farmed from 500 to 1000 acres in Norfolk," states, that "three essential points are to be observed: first, to apply the manure to the soil as soon as convenient after it is made (except in the depth of winter); secondly, to keep it as near the surface as possible; and, thirdly, to mix it well with the soil." This view is supported by the practice of some of the best farmers in Norfolk. Liquid-manure tanks are becoming very common, although many prefer having the best of the liquid absorbed in mould, so as not to apply it in a liquid state; but all agree in the necessity of preventing waste. Mr. Bowman, the steward of Mr. Marsham at Stratton Strawless, gave me a good practical reason why circular tanks are better than square ones. "If a waggon *heavily laden* comes near a square tank, the pressure and crushing in" of the wheels may injure it, which "would not be the case if the liquid-manure tank was circular." Mr. Blakie says, it is advisable "to throw litter, scourings of ditches, and such other refuse into the tanks, in sufficient quantity to absorb the urine and wash of the yards which run into them. Compost so collected is admirable top-dressing for permanent grass-lands, or for young clover layers." When at Stratton Strawless (about Christmas, 1843), I observed women employed in raking up leaves in the woods surrounding the mansion. Mr. Marsham turns these to account by mixing them with liquid manure.

#### HORSES.

Many first-rate animals, of different species, may be found in

Norfolk, having been brought thither from other counties, or bred from those that were so brought; but the best breed they can show, as their own peculiar and original stock, are their cart-horses. Many of these are such as any county might well be proud of; and I observed very few there that would not, in any place, come within the description of good and useful horses. At Mr. Aylmer's of Fincham, I had the pleasure of seeing ten better cart-horses than I ever saw together at any other place: each had every essential of a good farm-horse—substance, compactness, strength, shape, and activity. The real Norfolk cart-horses are generally dark bays or browns, hardy in appearance, possessing good bone and sinew. I certainly do not think them small (as Mr. Kent described them in his time); and, if I were required to suggest any change, I should say *reduce their size*, knowing that small horses, if equally well shaped (and they are generally better shaped), are more free from illness and unsoundness, and, consequently, most certain to be ready when wanted. I have reason to believe their size has been increased since Mr. Kent wrote.

Besides Mr. Aylmer's, I observed remarkably good horses at Mr. Raven's of Somerfield, and at several other places too numerous to mention. The gentlemen I have named breed none themselves; therefore, if we make certain allowances for their judgment in selection, their stock may be taken as a fair representation of the district generally.

Many of the "Suffolk chesnuts" may also be seen in this county. These too are a very active and useful breed, and he who possesses good specimens of either, or crosses of both, cannot be far wrong. Every farmer who keeps a horse for riding should have a really good hackney; which would cost no more keeping than the most worthless one. Peculiar circumstances made me acquainted with the history of a breed of roadsters which Norfolk once possessed, but of which it has now to lament the loss. A good specimen of that celebrated breed took its rider, in a case of necessity, 104 miles in 12 hours, without being injured; but such feats spread their fame—liberal offers from strangers followed—and, as men seldom know the value of a first-rate animal, so long as it is in their own possession, the best of the blood were bought, and taken from the county; and I was repeatedly told that their loss is irreparable. I do not mean that there are no good hackneys in Norfolk, but the people of that county say that they have lost their best, which is perhaps the strongest ground for hoping that their loss is not, as they suppose, irreparable. The fact is, they have not only sold the best specimens, but have crossed the others, in too many cases, with blood-horses; thus producing a nondescript animal in lieu of what might otherwise have been most valuable. Had they contented themselves with crossing the

heaviest of their *cart-mares* with small blood-horses, uniting good bone and sinew with compactness of shape, they might have made a real improvement.

#### CATTLE.

The cattle called "Norfolks," or "Home-Breds," seldom possess any characteristics of thriving stock. They are generally of a dark red colour, without horns; have narrow backs, thin thighs, and are of stunted growth. There may be some decent animals among them, but few will venture to say anything in their favour *as a breed*, except that the cows generally give a good quantity of milk. There are many, especially in the southern parts of the county, which are evidently the produce of crosses between these and the polled Suffolks; but they have no qualities to compete successfully with the Short-Horns, Scots, Devons, Ayrshires, and Herefords: although in a few instances of crosses with these breeds the produce is better than I should have expected. For winter-feeding on turnips, linseed-cake, &c., the Short-Horns seem to have the most general preference at present. The same may be said of Ayrshires for the dairy; and Devons are almost the only kind used for draught, on account of their quicker step and greater activity. A large proportion of the Devons are very beautiful animals. Probably there are as few bad ones of that breed as of any other whatever; and (which is of great importance) they are well adapted to the particular situation, bearing in mind on what they have to be fed, as well as their being so suitable for the London market.\* Good Scots are also in very high estimation for the latter reasons; but farmers say, that it is much better to have a good animal of its kind, than to take at random from any particular breed. Herefords are not so common in this county as

---

\* Mr. Marsham of Stratton Strawless and Mr. Overman of Weasenham keep Ayrshire cows. They occasionally cross with the Durham or short-horned bull for feeding-stock, but keep up their pure breed of Ayrshire for the dairy. Each feeds his male animals when little more than two years old, as paying better at that age than they would if kept later. They are then also more suitable for the London market.

One gentleman says—"For this situation I think our present breed of cattle, the pure North Devon, cannot be improved upon. They are extremely healthy and hardy; they maintain their condition on bare pastures in a dry summer better than almost any other breed. They will come, if required, to early maturity, and, when slaughtered, I believe there is no meat to surpass that of the North Devon in quality. I am now speaking with reference to the dry sandy soils of West Norfolk; in the rich grazing pastures of Leicestershire, Northamptonshire, and Warwickshire I should prefer the Durham or Hereford. In the mountains of Cardiganshire and Radnorshire I found the Ayrshire and Kyloe cattle answer remarkably well, and, although the experiment was not tried, I feel sure no high-bred animal could have borne the cold and hardship."



might be expected ; but, as I saw some of the breed at Castle Acre, it is not improbable that here too they may prove as formidable rivals to the Short-Horns as in other districts.

#### SHEEP.

Notwithstanding the opinions of former reporters in favour of the old Norfolk breed of sheep, they have not stood their ground ; and in some districts of the county it is difficult to find one genuine specimen. They might be, in many respects, suitable stock for the soil of Norfolk when Mr. Kent wrote his report ; but the activity then commended, as requisite to take them over the ground in collecting their food, from the short pastures of that day, is now unnecessary, and becomes a positive evil. Great activity implies, or at least is generally accompanied by, restlessness of disposition, and therefore is one of the greatest obstacles to rapid feeding. The superior flavour ascribed to Norfolk mutton by Mr. Marshall and Mr. Kent is an interesting quality to those who are willing to *pay* the price of such luxuries. It is often asked, why Welsh mutton is not more common in the markets, when all admit that its flavour is superior to that of any in common use. The reason is obvious : the consumers and butchers do not make it the farmer's interest to supply them with it. This also is the reason why old Norfolk sheep have for many years been gradually and steadily superseded in their native pastures, as the herbage has become suitable for breeds which improved in value much more rapidly in proportion to the food consumed. Mr. Denny, of Egmere, is generally admitted to have the best Norfolk sheep of the present time. They are said to have been greatly improved by him ; the legs are shorter, and they are rounder in the frame. An attempt has been made to give the capaciousness of chest, the levelness of form, and the aptitude to fatten, which belong to other breeds, but it has only been partially successful ; and the very fact of an attempt at imitation is the best evidence of the superiority of that which is imitated. Still great credit is due to Mr. Denny for what has been done, although he has not succeeded in entirely changing the nature of the animal. I saw Norfolks in Lord Berners' park at Kerby Cane worthy of a much better character than Mr. Arthur Young gives to the Norfolk sheep of his time, viz., "shape bad, loins narrow, back-bone high, chines thin ;" though even yet "their legs are long and their disposition wild and roving."

Leicesters were tried without success, and the South-Downs were the first to supplant Norfolks, and many splendid flocks of pure South-Downs may be seen. They are said to stand *folding* quite as well, if due care be taken so to arrange that the fold shall be within a moderate distance of their pasture. They will

travel as far as is now necessary, though free from the restless disposition of the Norfolks, yet are well calculated to thrive on short and more heavily stocked pastures; and, where an equal opportunity is given them, they become ready for the butcher at an earlier period than the Norfolks. New-Leicesters are generally admitted to be the best feeders, where the pastures are good, but are not considered so well calculated as the South-Downs for the light sands of Norfolk, or the downs of Sussex.

As the cultivation and soil of Norfolk improved, the county became more suitable for Leicesters than before, and advantage was taken of this change by crossing the South-Down ewe with the new Leicester ram. The produce of such cross is now generally admitted to be the most profitable sheep in the highly cultivated light soils of Norfolk. Only one cross is taken for the purpose of fattening it, the flock of ewes remaining of the South-Down breed.

#### PIGS.

The old breed of Norfolk pigs thus described by Mr. Young, "carcass long, but wants thickness," has been generally improved, so that it is rather difficult to find any possessing these peculiarities of shape to mark their origin. There certainly are some of them left, but barely sufficient to prove that the former reporters of the county faithfully described such as were common in their time.

The pigs most generally seen in Norfolk now are white, with a due thickness of back, a moderate length of leg, and an apparent aptitude to fatten *with good keeping*. They have been greatly improved by crossing with the Suffolk pigs, and to these, I believe, they chiefly owe their present good qualities. But, although they are probably now as well calculated as most breeds for general use, yet, where a little more care than ordinary can be bestowed, other crosses are more desirable. I saw some, in different parts of the county, the produce of crosses with Berkshire, others with "the improved Essex," &c.; but these are the exceptions, not the common breed of the county; which is, as I have above stated, the old Norfolk improved by the Suffolk pigs. I observed some remarkably good pigs, which I understood were the produce of the common sow of the county, crossed by a Neapolitan boar. Captain Glasspoole, of Ormsby, near Great Yarmouth, has, I believe, obtained more premiums for pigs, at the recent agricultural shows of the county, than any other person in it; and he thus describes the breeding of those with which he was so successful:—"My original stock of pigs were Chinese; they were crossed with a Berkshire boar, and that cross with a Neapolitan boar:" his present stock being the result of this last cross. The Captain adds, that "pigs require to be kept warm, dry, and clean, which is not sufficiently attended to by farmers generally." "Washing them occasionally with warm soap-suds is very beneficial, and they will lie down to be scrubbed as soon as they see

the soap and brush." The truth is, warmth, quietness, and comfort are very essential, as means of making food repay its cost in the best manner, to every animal on which food is bestowed for that especial purpose; and therefore our attention ought as constantly to be directed towards securing the former as providing the latter; and I think this general principle can hardly be too often impressed upon feeders of stock. I may observe also, that, although most of the best Norfolk farmers are aware of this fact, it is not so well known, generally, as it ought to be, that the peculiar flavour and quality of bacon is derived more from the food on which it has been fed than from the manner of curing it.

#### YARDS, BOXES, BUILDINGS, &c.

A question of some importance has recently arisen as to the comparative merits of stall, yard, or box feeding; but perhaps more particularly between the two last-mentioned methods. Box-feeding is of recent origin in Norfolk, and advocated on the ground of its uniting the advantages of having the cattle loose (or at liberty to move themselves as far as is beneficial), without allowing them to be checked in their feeding by annoyance from other animals, or by their own restlessness; whilst the manure, by this means, is made under cover, and the liquid from the cattle preserved in it; the boxes being generally sunk in the ground, or, when placed on the level, surrounded by a wall of clay, and in some cases brick and mortar, for the purpose of retaining the liquid manure. This is the new mode of feeding; and the only objection raised to it, which seems of much importance, even at first, is, that of its being more expensive. If it is really a more expensive means of arriving at the same end, it should undoubtedly be at once abandoned; but in these cases, as well as others, the cheapest way is not always the most profitable; on the contrary, it is often found, in the end, the dearest. Those who advocate stall-feeding say, that by their plan you can feed twice the number in the same space; but then the question arises, can you feed them as rapidly, for the same amount of food consumed, and with equal benefit to the manure? If you cannot do both these, the difference should be taken into the account in calculating the expense of feeding. For, supposing the interest of the landlord and that of the tenant to be (as they really are in the long run) as identical as if united in one person, a very small difference in the capability of producing improvements in the animals, from equal quantities of food consumed, would abundantly cover the most extravagantly built sheds for them. It is said, however, that these boxes may be so constructed as to cost very little.

Mr. John Blomfield, of Warham, has long prevented water from entering the sheds surrounding his yards, as a means of avoiding injury to the manure there made. He has kept his horses in the yards all night, during summer, upon cut grass, &c., more than

forty years, as a regular system ; when he has deviated from that, it has been from necessity. The advantages of this are shown by one of my Norfolk friends in the following extract :—

“ It is absolutely necessary to give cart-horses green food during summer, and I am convinced that horses thrive much better in loose yards, with plenty of green food like lucern, than by being turned at random into a pasture, where they are frequently teased and worried by flies in hot weather—and drenched and starved, even in summer, by the cold rains we frequently have at that season.

“ Then, again, (which should be an important consideration to every high-land farmer,) by one mode you produce, during summer, a rich and excellent yard of dung, and by the other your manure is all wasted, or deposited in situations where it is not wanted.”

It is only necessary to add, that this conveys what seems to be the general opinion of the best farmers in the county at the present time.

Mr. Blomfield's horse-cribs for cut-grass or cut-hay are worthy of notice. They are square, like most others, but have two high sides and two low ones : the latter, for the horses to reach over, whilst eating, opposite to each other ; the former, to prevent their wasting what they should eat, by throwing it out.

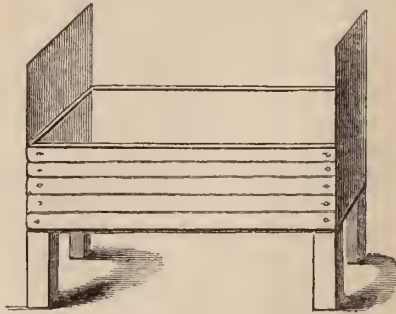

In Mr. Cambridge's yard, at South Runcton, I observed cast-iron posts used to support the front part of the open cattle-sheds. These posts cost 12s. each, and have the advantage of never decaying ; if accidentally broken, they can be made as strong as before, by enclosing the broken parts in a circular brace of iron.

Norfolk is celebrated for its large barns, which would be very desirable if the cost of them were not large also. Who would not, for instance, like to be able to drive ten or twelve loaded waggons under such a shelter in case of necessity ?

#### THE COURSE OF CROPPING ON DIFFERENT SOILS, AND IMPLEMENTS USED.

The four-course shift, viz. turnips, barley, seeds (or layer), and

wheat, is most common in almost every part of the county; but that arises partly from the occupiers being tenants of others, and bound to it by their agreements. On the light, sandy, or chalky soils the *general* opinion seems to be, that no other course would be mutually more beneficial to landlord and tenant. But that is not the case on the strong clay land. In the marshes and fens there is in some instances an entirely different course adopted, which would no doubt be the case more generally if each person cultivated his own land.

In some cases I felt a diffidence in asking men, whom I knew to be possessed of original talent, "their course of cropping;" because that course was not selected by themselves, but copied from some "musty old parchment," and circulated by some man in authority as the *unbending law*, to be applied to all soils, all situations, all climates, and all circumstances! The folly of this must be obvious to all intelligent practical men. I do not mean in this to convey a censure on the management of estates in Norfolk particularly, for the same error is too common in many other counties of England.

What may be good in one instance, would not be so in a different situation, or even in the same situation *often repeated*; as then, the original circumstances may be quite changed.

Thinking it a convenient means of conveying to my readers some idea how the business of Norfolk agriculture is carried on, I purpose selecting one person to represent the rest, and showing, when necessary, the opinions and practice of others bearing upon the particular point.

For this purpose it might seem natural to some to select Holkham as an index of the rest, but that would be objectionable as being cultivated for an owner, and therefore such as might not be supposed proper to be imitated by a tenant farmer. The farmer whom I shall select is Mr. John Hudson, of Castle Acre, one of the principal tenants of the Earl of Leicester. Mr. Hudson names as his model or "tutor" in agriculture the justly celebrated Mr. Blakie, late agent at Holkham; and I could not avoid observing that many others of the best farmers of the district are doing precisely as that gentleman recommends in his publications. The two farms at Castle Acre occupied by Mr. Hudson contain about 1500 acres; the soil being a "sandy loam on clay or chalk." He also has a farm of low land at Seech, near Lynn, about 200 acres. When he first took the land at Castle Acre in 1822, he only kept about 30 head of cattle and 800 sheep; he now grazes "*about 200 beasts and from 2500 to 3000 sheep annually.*" He has *doubled* the produce of barley, and nearly doubled the produce of wheat. To account for this change; he uses yearly about 100 tons of rape-cake and bones for

manure, and about 200 tons of linseed-cake for fattening cattle and sheep; the whole of the land has been clayed or marled, and, where necessary, drained. Here, as on most other large farms in West Norfolk, a bailiff is engaged for each farm to superintend the different operations. Now, let us suppose that these have received Mr. Hudson's instructions, and commence operations, and that the farmers of Norfolk generally are aware of what is going on, and give their opinions occasionally (neighbours and others sometimes will) as to the policy of the modes adopted in the particular situation; also *how* and *when* they ought to be varied under *different circumstances*.

These latter I shall insert as seems convenient and necessary.

*Mr. Hudson's Course at Castle Acre (or the Common Four-course Shift).*

1. Turnips; 2. Barley; 3. Clover; 4. Wheat.

*Preparing Land for Turnips, Mangold, &c.*

FIRST YEAR.

Immediately after harvest, if the weather is too dry to plough clover layers for wheat, it will be particularly well adapted for the work of clearing and preparing part of the land for turnips next season; thus—

By skeleton-ploughing the wheat stubbles about 3 to 4 inches deep, all the soil is cut, but not turned over; therefore, the stubble, &c. will be left on the surface. This is done by Ransome's Suffolk plough, without its "plat," or mould-board.—Searifying across with Blakie's grubber, or some similar instrument, usually drawn by two or by three horses—well harrowing with heavy harrows, two of them being fastened together when at work, and drawn by three horses. They are considered at least twice as effectual at this stage as those which could be drawn by one horse each, and therefore the work progresses more rapidly by the use of them: harrowing afterwards with lighter harrows, two horses drawing a gang of three. In performing this operation it is usual to drive the horses much more rapidly, by which each harrowing becomes more effectual than it otherwise would be:—the stubble, &c. raked into rows, earted into a heap, and afterwards earted into the yards, as opportunity offers, that it may be used for litter in winter: it is never burnt.

These operations only apply to that part of the shift which there is time to get through during such a period of dry weather as prevents any more valuable work being attended to, and are in that case done during September or the first half of October. If no such opportunity offers, these will not be performed, but the whole of the land will be prepared for turnips in the following manner:—

Ploughing 5 inches deep (or as deep as may be without turning up dead soil) with Ransome's wheel-plough, drawn by *two horses or oxen*.

And, as there is no instance of more being used at one time for common ploughing in any part of Norfolk, I shall not think it

necessary to state the number used in any other ploughing herein described.

Mr. Hudson objects to cross-ploughing *each time*, because it cuts the land into diamonds and renders it unlevel; he, therefore, always ploughs it twice in succession in the same direction, that is, if he has turned it out from a furrow, he turns it in the next time. In districts where fallows are ploughed in very wide pieces this objection to cross-ploughing each time does not apply so strongly; but, as Mr. Hudson's are only 20 yards wide, it is in his case well founded.

Ploughing the same depth as before, and in the same direction or otherwise, as may be consistent with the above rule. This may probably be done in February if the first ploughing was performed early; but that ploughed for the first time in December will not be ready before the end of March or beginning of April.—Scarifying with Blakie's grubber or Biddle's scarifier.

He considers some scarifiers\* to be good harrows but bad ploughs, and therefore ploughs oftener than some of his neighbours.

Well harrowing with heavy harrows (two drawn by three horses).—Ditto, occasionally afterwards, to destroy the annual weeds, &c.—Rolled as occasion may require.—Any rubbish which the land contains may now be supposed to have come to the surface, and is picked off by hand for *6d.* per acre; it formerly cost 20s.—A "clean earth," (the third ploughing,) called the "stirring earth."—Harrowed with the three-horse harrows, followed by the light ones as before, and rolled if necessary. This supposed to be about the end of April or beginning of May.—Mr. Hudson prefers ridging to flat work on such soil as that at Castle Acre. He thinks the land more certain of bearing a crop if ploughed about ten days before sowing, in doing which, his aim is to leave the soil light, and as finely pulverized as possible.†

The land is marked for ridging by an implement for the purpose, drawn by one horse, the markers being somewhat similar to the coulter of a drill. It makes five marks at a time, the rows 27 inches apart, and one of the coulter returning on the mark last made by itself, whilst the others go on fresh ground. The land being thus all marked for ridging, that operation may be commenced at any part of the field. Two of Ransome's, or similar double-breasted Northumberland ploughs, will set out 8 acres per day. The land being measured, so as to know exactly how many ridges make an acre, tumbrils with muck immediately follow the ridging-ploughs, each load being made to go the whole length; so that they take any number of rows, according to the length of them, &c. Two men unload; one in the cart with a fork,

the other behind it with a crome



; this last is



\* During the last spring and summer I have used Biddle's *improved* scarifiers to great advantage, and certainly saved a ploughing by using them for barley, as well as for turnips.—J. HUDSON.

† The strong land on Mr. Overman's farm at Weasenham is thus prepared for turnips: in November, ploughed deeply, the ploughs having "*short plats*" (or mould-boards), that the land may be more exposed to frost; in the spring, scarified with Biddle's scarifier, and afterwards ploughed and drilled; being generally sown the last week in May or the first in June.—Mr. Overman has this land in 12-furrow, or 3 yards, "*stetches*" (and there are few good farmers in the county who have wet land in much wider pieces, or "*stetches*," than four yards). He is of opinion that the less such land is ploughed the better, so long as it is kept clean.

the team-man. Six women, or strong youths of fifteen or sixteen years old, spread the manure with light three-pronged forks, the rows being divided into three



2	2	2
Women	Women	Women

equal lengths; they work in pairs, and the ground being equally divided, they know the part they have to do. Other two similar ploughs follow immediately after the spreading of the ma-

nure, and plough it in before the gases escape.—The drilling of the seed immediately follows that, not *rolling first*; but, to prevent the necessity for that, a flat mould-board is attached to the shafts of the drill, and therefore precedes the coulters, taking off the tops of the ridges and moving the clods, if any, into the furrows.—Besides the usual quantity of about ten three-horse tumbrels of muck, from ten to fourteen bushels per acre of bones (or bones and rape-dust in equal quantities, *mixed*) are drilled with the seed.

—Care is taken to put the bones, &c., as near the farm-yard muck as possible.—A small fork,  $\wedge$ , attached behind the drill manure-coulters, slightly covers the bones, &c., before the seed is deposited by the other coulters of the same drill.—The seed is deposited not more than an inch deep, and is covered by a loose chain attached to a cross-bar of wood.—Mr. Hudson has sowed mangold twenty-two years, out of which he drilled twenty, and dibbled two. The latter were the only failures; therefore his mode of sowing it is precisely the same as when sowing Swedes or white turnips, in all the particulars I have described; and the only variation is in the time of sowing and the quantity of seed.\*—His practice at Castle Acre is: to sow mangold the last week of April or the first week in May.—Swedes from the 1st to 20th of June.—Decanter or bell-turnips about the 15th of June (being for early consumption by cattle or sheep); and he would sow white turnips, intended for the lambing season, about the 6th of July.—Quantities of seed per acre: white turnips, 3 lbs.; Swedes, 4 lbs.; mangold, 7 lbs.—Mr. Aylmer was surprised to find 18 inches *flat* heavier as a crop, than 27 inches *ridge*, by  $1\frac{1}{2}$  ton per acre; the latter looking much the best. He describes the soil as loam, and subsoil chalk. Notwithstanding this, Mr. Aylmer is inclined to ridging; so that the evidence of his actual experiment is of the more importance. Many of the best farmers of the thin soil chalk-districts *drill their turnips on level at about 18 or 20 inches apart, exactly in the same manner as those of the Wolds* of Yorkshire and Lincolnshire. Mr. Overman of Buruham is an instance of this, and he is said to be one of the best farmers of the county. Those of other districts, who have a geological map to refer to, will find that Burnham is on the chalk. This only confirms the opinions of others in different districts, who are cultivating similarly thin soil resting on chalk; and whoever happens to occupy such, in whatever part of the kingdom it may be, should bear such evidence as this in mind, in order that he may try the experiment if he has not already done so. I found the same soil at Massingham, where the drilling is on the flat. It is the same also at Quidenham, where I could have thought myself in a Lincolnshire or a Yorkshire turnip-field; Mr. Coulson's management of his 18-inch flat drilled turnips is so similar to the common practice of those counties. Where the soil is deeper, and yet not wet, I found the turnips more generally ridged; but Mr. Hudson of Castle Acre, and Mr. Overman of Weasenham, both say they should not ridge on wet land.—Mr. Tingey of Scoulton says, "I object to ridging turnips on heavy land, because I cannot prevent the clods from rolling to the top of the ridge, therefore the seed gets deposited in the clods, and unless there comes a heavy rain soon after the seed is sown, the turnips come up very patchy, for if the seed is not covered with loose mould it cannot grow." "I also find that, when turnips are sown on ridges, the land becomes flat from hoeing," so that it is often difficult to find a season in which the carts can be taken upon the land without becoming a means of injuring the barley-crop by compressing the soil so as to turn up, after ploughing, "whole

\* Mr. Milnes had as good mangold as any I saw in the county, his manner of growing it being very nearly the same as Mr. Hudson's at Castle Acre; the rows being only one inch wider, and the seed steeped thirty-six hours, and afterwards placed in a moderately warm sun, and dried with sand and a small proportion of lime, that it may work easily in the drill.



and livery." "Again, I can grow more weight of turnips per acre on the flat-work 17 inches apart, than I can on the 27-inch ridges." Mr. Tingey adds, "My system of growing turnips on heavy land is this: I sprcad seven loads per acre of yard manure, plough it on 12-furrow ridges (3 yards), drill six rows on a ridge, with ten bushels per acre of bone-dust, taking three drills up one side and three down on the other, the horses walking in the furrows. By this method I am most certain of plant, and can grow the greatest weight per acre; and the land lies in a much better form for keeping itself dry at Michaelmas, or when you want to get the turnips off, than when it is hoed flat from the ridge system. It ploughs lighter and in a better state for barley, and will work much better, and more like light land in the spring, if you can plough it up soon enough to have the benefit of the frost. By this plan I can get two or three coombs more barley per acre than when my land has been ridged."

On Mr. Hudson's farms a few days after the plants appear the land is horse-hoed by an implement which takes one row and two half-rows at a time; a little buck-wheat is now sown at wide intervals (about 60 yards) for the game, which is covered by the horse-hoe.—The young turnips are hand-hoed with 9-inch hoes for 2s. per acre, at which work the men earn from 2s. 6d. to 3s. per day.—After a few days the turnips are singled, and the weeds picked from around the plants for 1s. 6d. per acre, many persons only giving 1s. per acre.—Horse-hoed a few days after that, and as soon as possible hoed a second time, breaking up the soil and drawing it round each turnip, for 3s. per acre.—Horse-hoed again, with a triangular hoe, three rows at a time, drawing or "crowding" soil to the plants.—Sometimes another horse-hoeing.

I met with several extraordinary instances of difference in opinion on important points, but none more remarkable than this, as to the distance at which turnips should be set from each other in the rows.—Mr. Marsham of Stratton Strawless, Mr. Hudson of Castle Acre, and Mr. Blomfield of Warham, are supposed to be as good authorities on agricultural matters generally as any other persons in the whole county, yet Mr. Marsham hoes his turnips with a 4-inch hoe, Mr. Hudson one of 9 inches, and Mr. Blomfield leaves his 18 inches apart in the rows, or two in a yard. All three sow them on 27-inch ridges; but Mr. Blomfield sows only Swede turnips, Mr. Hudson nearly all Swedes, and Mr. Marsham rather a large proportion of white turnips. This in some degree accounts for their difference in opinion. My own opinions on this subject are already known to the Society.\*

In September Mr. Hudson begins to draw off white turnips for lambs on second crop clover or wheat stubble, in order to gradually accustom them to food of so opposite a nature to what they have had before. This is continued about six weeks, the quantity of turnips being increased, as the sheep become accustomed to, and acquire a liking for, them. In doing this Mr. H. takes six rows and leaves twelve to be fed off on the land.—In October, puts the lambs on turnips, cutting them all with Gardiner's turnip-cutter.—The sheep are kept in by hurdles and nets.—Mr. Hudson prefers hurdles between the different flocks, nets before and behind, also on the sides of the folds. Where there is little game, nets become proportionably more suitable.—Each sheep is allowed half a pound of linseed-cake, and two or three pints of cut clover-hay, per day, in addition to all the turnips he will then eat.—Cut turnips are given to the sheep in troughs.—One-third of the turnips intended for cattle, &c. is drawn topped, tailed, and loaded on carts; the remaining two-thirds "placed" for 4s. per acre *on the whole quantity*; the turnip-tops are thrown on wheat stubbles for store cattle.—Three sheep-feeders (a man and two boys working together) top, tail, and cut the turnips, move the

\* "Prize Essay on the Drill Husbandry of Turnips."—R. A. S. J., Vol. iv. Part 1.

troughs, nets, &c., for about 1s. a score per week; thus, if the sheep are fed on turnips twenty weeks, each sheep will cost about 1s. for attendance.—Mr. H. gives his sheep salt, either common or rock being always by them.

Turnips are all drawn out of the ground by hand before frost sets in; as evidence of which, there were *none* left on the land in the state they had grown, when I rode over Mr. Hudson's farms about Christmas Day, 1843.—Turnips are taken to the yards in light carts drawn by two horses.—If intended for use in November or December, they are put in turnip-houses; and for January and February they are laid on heaps, the tops being cut off, but the roots left on, as they are found to keep better so; that is, they are not so liable to become musty.—Those for March and April are placed in beds on wheat stubbles or other convenient situations which seem suitable for the purpose.—Mr. Overman of Weasenham draws off about half the early-sown white turnips for cattle in the yards, or throws them upon the wheat stubble for them, previously to their being put into sheds or yards to fatten; the remainder he eats off with sheep where they are grown. The Swedes are pulled, topped, tailed, and put into heaps (about eight heaps per acre), which are covered with a small quantity of straw and mould to preserve them from the frost, and to have them ready for use in any weather. This system of pyeing turnips is a very common one in Norfolk, and it is difficult to decide whether the majority of good opinions is in favour of it, or rather of the other method, which is, "placing" the turnips from several rows side by side, so as to leave at least nine-tenths of the land vacant. Mr. Overman has a practice which seems almost peculiar to himself at present, but not unlikely to extend in that district. After part of the Swedish turnips have been carted off, and the remainder put in "pies," the turnip-tops and "offal" are consumed on the land by his flock of ewes.

Mr. Hudson cuts them for cattle, with Gardiner's, Wedlake's, or Man's slicers.—The cattle have each about three bushels of turnips per day, and from 7 lbs. gradually increasing up to 10 lbs. per day of oil-cake, besides hay.—Mr. Hudson does not approve of cut hay for cattle; he thinks they do not ruminate so well with it. He also thinks that long hay is a means of cleaning the mouths of the animals, otherwise clogged by eating oil-cake.—Sheep finish the turnips by the second week in April.—Mangold is pulled, topped, put in carts, and packed on heaps, for 5s. per acre; and it is considered very important to have this done before the frosts.—Mr. Milnes's plan of packing mangold-wurzel is, to throw up the main body of the pile roughly (so as to be laid open), but to pile, or *place straight by hand*, the outside. The heaps are covered with straw first, then with soil, to the thickness of four inches, except the top, which for about a month is left open, for the heat, &c. to evaporate.

Mr. Hudson observes, that mangold is not in season before February; it is better in March, still better in April; and that all cattle eating mangold should be kept warm, and have hay with it.—Cattle should be gradually accustomed to mangold, the allowance of it being increased from day to day, thus: one peck the first day, two pecks the second, three the third, and four the fourth; then increasing more largely, to six pecks the ninth day, &c.—Mangold suits best in warm weather, and as it is more relaxing than turnips, it requires a more liberal supply of hay to correct the bowels of the animals.—They eat less cake with it, and fatten more rapidly upon it.—Mangold is very useful to carry on wheat for hoggets in March. By consuming about five tons of it per acre, and a little linsced-cake, the wheat is greatly improved. It is made more free from poppy and other weeds, the straw stiffer, and the grain heavier and better. This, it must be remembered, applies to dry land.

Mr. Hudson first covers the bottoms of all his yards with sand or mould, to absorb all the liquid manure.—The cattle are fed in yards with open sheds fronting the south, and affording shelter from the cold north winds; these are spouted round to carry off water from the manure.—Mr. Hudson (like many other Norfolk farmers) takes out his manures from horses and cattle alternately, to mix them in the hill—about half a day's work of each before changing.

#### SECOND YEAR, BARLEY.

After the turnips are off, the land is ploughed "fleet," or about 3½ inches deep across the ridges, with a skeleton plough.—In February, scarified, if the weather is favourable.—Harrowed, and, if cloddy, rolled.—Ploughed again, but not across, for reasons before stated.—Harrowed, and rolled with light rollers, &c.

Drilled, with from 3 to  $3\frac{1}{2}$  bushels of barley per acre, according to the state of the land.—Rows 7 inches apart.—Mr. H. sows none but Chevalier barley.—It is harrowed in with light harrows (three for two horses).—Sows clover and other small seeds with a horse-machine, that it may be more equally spread over the land than is possible by hand, especially in windy weather.\*—Mr. Nurse, junior, states that sainfoin has been sown by many first-rate agriculturists for one year only; the wheat is much better after it (scarcely a case known where wheat has failed after it); a friend of his has grown it thus, many years, and intends this year to lay down fifty acres with it, for one year only; he had the same quantity last year, and grew three good loads per acre of hay; the after-grass was a foot and a half high; upon this he turned his lambs, and they became the best in the neighbourhood. Some say, plough in the “eddish” for wheat; he thinks it better to buy other manure, as the value of the crop for sheep-feed is more than equal to that cost.—As in Norfolk generally, Mr. Hudson’s seeds are varied in each course, so as to have red clover only once in eight years, thus: first course—16 lbs. of red clover, 4 lbs. of white, and half a peck of rye-grass, per acre; second course—12 lbs. of trefoil, 8 lbs. of white clover, and a peck of rye-grass, per acre.—This last is intended for feeding on the land.—The clover (in the first course) is for mowing once, and afterwards to be fed by sheep.—Seeds covered by light harrows, and the land rolled, to make it level.—Barley is weeded for 5*d.* per acre.—In preparing for barley, Mr. Brown of Thrigby always keeps from the land in wet weather; sows, a few days after the barley, small seeds with machinery, covering them with very light harrows.—Mr. Blyth (S. F.) says, “The turnip-land is generally ploughed twice towards the end of the season, scarified once or twice, and then once ploughed; drilled about six inches, beginning about the 25th of March, and sowing three bushels per acre.” Mr. Coulson, “When the turnips are fed off early in winter first skeleton ploughs (by taking off the plough-breast), then harrowing in spring, and ploughing clean. Where later fed, ploughing once, and harrowing; drilling at 7 inches, from two and a half to three bushels.”

The barley is mowed by a set of harvest-men, paid for the harvest, not by the week; therefore they receive the same, whether it is of long or short duration.—After two or three days, turned with a hay-fork or fork-shaft.—Last harvest Mr. Hudson sheafed part of his barley *for the first time*; therefore the old method of treating it will here be described. When dry enough for carting, it is gathered six swathes in a double row, thus:—



\* I could not find that the plan of drilling clover-seed in rows had been tried in Norfolk. A gentleman of great experience in Lincolnshire recommends it on the following grounds:—

1st. “That one-fourth of the seed is saved.”

2nd. “That, by all the seed being deposited at an equal depth, the plants retain a much firmer root in the soil during the winter.”

3rd. “That the grass-seeds may be drilled across the rows of barley some time after the corn is up, and not only be better covered by the soil than they would be if no coulters were used, but the barley itself may be improved, at the same time, by this slight breaking of the surface soil.”

In addition to the saving of seed, as before named, this gentleman’s clover was better last spring than he ever had it before, and he believes that, if the following season had been an average one, his seeds would have carried at least one-third more stock than usual. This improvement he attributed solely to the drilling. The drill he uses for this purpose is  $6\frac{1}{2}$  feet wide, having twenty-four coulters, and resembling a corn-drill, except that it is much lighter. It is drawn by one horse.

Knowing the high estimation in which this plan is held by some farmers in Lincolnshire and Yorkshire, I take this opportunity of alluding to it as a general answer to those of my Norfolk friends who made inquiries respecting it.

one row being turned to each side, from the centre to the swathe adjoining, and one from each outside towards it.—One raker follows each gathering-fork, with a rake five feet long.—Two women gather for two pitchers.—There are two rakers after each pitcher; two to load the waggons, one of them being the team-man; there are also two pitchers, or one for each man on the waggon.—The land is afterwards horse-raked.—The waggon commonly used throughout Norfolk is rather too substantial; it is a shafted one, drawn in harvest when loaded by three horses, one before another, and driven without reins.—When unloading there is only one horse standing with the waggon, the others having gone to assist in bringing a fresh load.—The stack-staddles of straw are about  $5\frac{1}{2}$  to 6 yards wide for barley, the length varying according to circumstances.—Mr. Hudson's stack-stage is peculiar, and readily formed, a cart being the foundation for it.—There are usually five men at the stack for two pitchers.—As is usual in Norfolk, nearly all the corn is stacked in the fields, and as near to where it was grown as may be, without injury to the clover, or waste of labour; thus the barley is generally put on the first wheat stubble in the way to the barn.—After harvest the outsides of the ricks are threshed with poles to save the corn (and prevent the staining of part of it), which falls on a rick-cloth or waggon-sheet.

Barley is threshed by machines, the men not liking to use flails. Horse-machines are almost universal in Norfolk, but Mr. Hudson has recently had one erected to go by steam.—A winnowing-machine takes the chaff out of the barley.—It is hummelled by machinery.—Winnowed again with smaller riddles.—Blown, to take out the small corn.—To make the parcel more uniform, the corn is not measured *as dressed*, but *after the whole is clean*.—The bushel is not filled by a scuttle, or "scoup," but with the hands, the measurer having it between his knees at the time. A coomb (four bushels) is put in each sack.—Barley is delivered in a waggon drawn by four horses, which usually takes twenty-five coombs for a load, but occasionally thirty.

#### THIRD YEAR, CLOVER.

Thistles are cut on new layer before they are closed for mowing, at the rate of 2d. per acre.—Clover is mowed for 2s. 6d. to 3s. per acre. Some get it done for 1s. 6d., but, the stubble being of no value, Mr. H. pays more to have it cut close to the ground.—The weakest land is manured for wheat, and, the earlier the manure is put on after the clover is carried, the more beneficial it appears.—Mr. Hudson's breeding-flock being comparatively small in number (200), he does not practise *folding* extensively, but only when the lambs are not with them.

Mr. Aylmer's boy, "Abraham Fisher," aged twelve the previous April, was removing the fold when I saw him in August, 1843, but this he had then done for about two years. Those who at first think the hurdles expensive, may not do so, perhaps, after calculating the difference there is between the wages of men and those of boys like this. I annex a sketch of Mr. Aylmer's sheep-hurdles:—



They are 21 feet long, and cost 30s. each, but I was informed they may be made for considerably less. Sixteen of these (four on each side) constituted Mr. Aylmer's fold for 400 Southdown ewes; and this valuable flock was attended to by the boy "Abraham Fisher," above alluded to.

#### PREPARING FOR WHEAT.

Mr. Hudson's layers are ploughed by Ransome's wheel Olland-ploughs.—Drill-rolled with a 12-roll presser, covering six feet, and drawn by three or four horses, as the land is level or otherwise.—Harrowed with heavy harrows, to raise mould.—Mr. Hudson thinks it very important to select the finest ears for seed.—Mr. Neave had the "Britannia" and "Clovers" last year, both of which surpassed any other in

his possession. He thinks "Spalding" is the most general favourite, but he prefers those named, as being superior in quality.—Mr. Neave's wheat attracted my observation so much, that I inquired to whom it belonged, when I found this was one of the gentlemen on my list; and, but for his good crops, I should have gone considerably out of my way.—This case was an exception; but nearly all the best crops of wheat I saw in the county were of the sort called "Spalding," the straw of which is bright and stiff.—The seed is drilled.—In Norfolk, generally, the drill is so constructed, that the man following it may, to a great extent, guide it. This partly accounts for the straight drilling almost everywhere seen there. In other districts, where all this depends on the horses and their leaders, it cannot be expected that the work should be so generally well done. But I hope this hint will be sufficient to introduce the improvement (now very old in Norfolk) to more general notice. The farmers, I suppose, may send for them, if their neighbouring agricultural-implement makers do not.

The wheat is drilled eight inches from row to row, about three bushels to the acre; the quantity varying according to the season and state of the land, but generally beginning with a smaller quantity, and increasing it as the season advances.—Would dibble part, if he would get the dropping done well.—To prevent smut,\* the wheat is prepared for sowing thus:—To three gallons of boiling water a quarter of a peck of quicklime is added, and, after boiling, when effervescing, three pints of strong salt-brine are added, the whole being then stirred up and mixed together. This is poured over three bushels of wheat, which is then turned four times, sweeping the corn up quite clean after each turning.

The growing wheat is hand-hoed for 1s. 6d. or 2s. per acre.—To mow 300 acres of wheat, Mr. Hudson has thirty-four men as mowers.—Each mower is followed by two women, or strong boys or girls in lieu of them.—One gathers with the hand and the other prepares the band and ties it up: but they take the work alternately.—This company is followed by eight team-men, who set up ten sheaves in a shock, not as suits their convenience, but, commencing with the two sheaves intended for the centre, they place two more, first on one side of them, then on the other, that the shock may be equally balanced, and therefore more likely to stand; as is shown by the numbers over each pair of the sheaves in the ac-

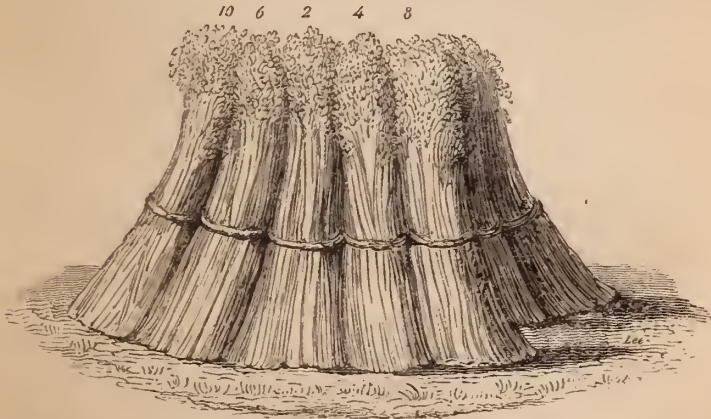

\* Mr. Coulson, of Quidenham, states, he has for several years used blue vitriol, and finds it "a perfect preventive of smut in wheat," which was not the case with salt and lime when he used them.

"The vitriol should be put into a tub and dissolved with boiling water, then adding cold water at the rate of (hot and cold) three pailfuls to one pound of vitriol.

"The wheat should be steeped in the solution, and then turned out on the floor.

"It soon dries, and is ready for use. It drills freely in any weather, which is not the case with salt and water; as we frequently could not get it to drill at all in very damp weather."

companing sketeh.—The ground is raked with a horse-rake.—Horse-drag raked.—Old men tie up rakings as closely to the mowers as possible; as that work is more easily done when the corn has been recently cut.—In earthing wheat (as with barley) there are two pitchers, and two persons to load each waggon.—There are always two waggons at least loading, and two unloading, at the same time, by which means the work progresses more cheerfully, and much more is done than would be by each party working separately.—Mr. Hudson does not use carts for carrying his corn; and there are few persons in his immediate neighbourhood who do.—The wheat is put together in ROUND stacks, because these have a smaller proportion of outside, and wheat is not likely to heat from the weight of grain in the centre.\*—The stacks are made of one uniform size, in order that the two companies may keep pace with each other; the advantage of which has been before stated.—They are placed sufficiently far from each other to prevent any two of them being burnt by one original fire.—The round staddles are made 9 yards in diameter, by sticking a fork in the ground as the centre, and then, with a rope  $4\frac{1}{2}$  yards long, having a ring at one end (to pass over the shaft of that in the centre), and a fork at the other, drawing the exact circle at once, and making them all of one size.—Each of these stacks holds about 28 or 30 loads, about 18 or 20 shocks to a load, and 10 sheaves to a shock.—Twelve waggons (eight going, and four unloading) will make eight such stacks a-day.—All the wheat is stacked in the field, where grown.—Thatched in the same manner as the barley, at 5*d.* per yard, measuring round the eaves.—The sides of these wheat-stacks cut round, immediately after harvest, with scythes having straight handles, for 2*s.* per staek.—Shavings carried to the machine and threshed, from which Mr. H. got about 40 bushels last harvest; a larger quantity than usual, arising from the corn being difficult to mow, &c.—Mr. H. hangs old worn-out sheep-nets round the eaves of his wheat-staeks, to keep the crows off.—Does not plaster round the bottoms of his staeks, as rats are not so numerous with him as in some other parts of the county.†

All wheat is threshed by machines, winnowed twice, then blown, and measured in the same manner as the barley; and delivered by a waggon and four horses, taking 22 to 24 saeks at each load.

From what I had heard, I expected to find that the use of oxen for ploughing had recently been given up by many; but I found very few instances of it, or even of a doubt expressed as to the propriety of keeping some Devons for this purpose, where the party possessed old grass-land suitable for their support. All admit that horses are best for harvest, and therefore say they must keep so many horses as are necessary to cart their corn. These horses will perform great part of the ploughing, and the number of oxen to be kept will be regulated by the extent of land the harvest horses cannot plough.

Nearly all the best farmers of West Norfolk agree in this. As

---

\* There are many who object to round staeks. For instance, Mr. Overman, of Weaseuham, says—"Long ones are better, because there is not so much time lost in beginning and finishing them; you can make them any length you like (in parts), and if you do not choose to get the same lengths into the barns, you can cut them." Mr. Overman's ricks are 7 yards wide, and 20 long.

† At Stratton Strawless I first observed ricks plastered round, for about a yard from the bottom, with mortar, to keep rats out. The cost of doing a round stack, thus, (Mr. Bowman thought) had been about 12*s.*, and the old plaster would be worth (as maure) nearly half the money. I observed several instances of this in the neighbourhood of Blofield; some of the parties having also dug a trench, about a yard deep, round the stacks. In some parts of the county the stacks are on iron stands (or frames), for the same reasons. Mr. Blyth of Burnham has displayed great ingenuity in constructing a cheap one, from loose bars of iron and posts. The number of rats now infesting the county is little short of a plague.

instances, I name Mr. Blomfield of Warham and Mr. Hudson of Castle Acre.

Oxen are used at Holkham and at Quidenham. Mr. Coulson, the steward of the Earl of Albemarle, at the latter place, states their advantages thus:—

“They are kept at less expense than horses; they save the wear and tear and cost of horses, by the oxen themselves growing into greater value, and by having more work done by the man with oxen than by him with horses; and thus they keep the ploughing in a state of forwardness. One man has two pairs of oxen (which is, indeed, the common custom, in order to change them in the middle of the day, and thus keep them in good condition), and ploughs about  $2\frac{1}{4}$  acres of fallows per day, for which he receives 1s. 2d. per acre; he ploughs about 2 acres of seeds, or layers (for wheat), and is paid 1s. 4d. per acre for it.”

Mr. Coulson adds,—

“I am of opinion that horses are best calculated for harvest work; but I am convinced that, on large farms, a certain number of oxen may be kept with great advantage, according to the size of the farm. I use about eight pairs, they work four ploughs, and generally plough 9 acres per day, so that the four ploughs keep the drill with manure at full work during the time of sowing. Four horses work the drill and harrow once before and once after it; other horses being employed in preparing the land for the ‘sowing earth.’”

Although I saw cattle at work in almost every part of the county, they were nearly all Devons; indeed, I only observed two that were not.

There is no doubt as to the superiority of Devons for draught, from their peculiar activity. They do not walk so fast as some horses, but they take the plough quite as quickly as horses do, in some situations; and, from the steady pace, and habit of walking exactly parallel with each other, which I observed in Devons, I believe the ploughman may, generally, do his work better with them than with horses.

Although, as I have before stated, the general opinion seems to be in favour of the 4-course system, for such light soils as are in West Norfolk, yet there are good farmers in that district who think differently. For instance, one says, if the land is clean and highly cultivated, he is of opinion the 5-course would be better, if carried out as follows:—

1st round.—1, turnips; 2, barley; 3, layer; 4, layer; 5, wheat or oats.

2nd ditto.—1, turnips; 2, barley; 3, red clover; 4, wheat; 5, pulse, and part vetches; to be mowed green, for immediate consumption in yards or boxes.

For, thus, only one-fifth of the land would be sown with turnips, and, consequently, more likely to have a heavier crop per acre for

the manure applied. The red clover would only come once in 10 years; a sufficient interval to insure a good crop of it; whereas, it generally fails, if repeated every four years.

With high land, called light, yet not containing sufficient sand or chalk to render it "kind for turnips," Mr. Blomfield, of Warham, states he would adopt the following course:—

1, turnips; 2, barley; 3, grass-seeds; 4,

About Michaelmas he would partly plough the land, that is, plough it in the manner called "risbalking," by which 4 inches are taken out and laid on 12; so that one-fourth only of the land is actually ploughed; but that fourth destroys the herbage on another fourth; and, notwithstanding this, it so improves the remaining half, as to make it, as a means of supporting stock, nearly equal to what the whole would have been. About Midsummer he would cross-plough it, as opportunity might offer; and, near the time of harvest, manure and plough it.

5, wheat; 6, grass; 7, part oats and part peas.

Mr. Neave, of Downham Grove, near Wymondham, (whose land is too strong for turnips, and, on that account, not desirable that he should have them oftener than is really necessary,) would not sow them so frequently, but would prefer the course following:—

1, turnips; 2, barley; 3, layer; 4, layer; 5, wheat; 6, beans; 7, wheat.

Near Lynn I observed, on one farm, this course:—

1, Rape, sown in June and eaten off by sheep.

2, Wheat, drilled with 7 pecks of seed.

3, Beans, ploughing once for them, and drilling or dibbling 2 bushels per acre.

4, Wheat, ploughing the land only once and drilling the seed.

5, Oats, ditto, drilling 4 bushels per acre.

This farm was remarkably clean, although other land near it was as much the contrary: the difference, probably, being caused by the occupier of one commencing operations *only* when the soil *seemed in a favourable state*, the other, when it suited his convenience, whatever the state of the soil might be.

Mr. Hudson at Seech, near Lynn (where the land is his own, and cultivated on his own account, in conjunction with the farms at Castle Aere), the soil being a deep silt, a deposit from the sea, has sowed wheat and beans alternately for the last 16 years, without fallow, and without taking any other crop than the two named. As he undoubtedly obtains a good crop every year, I think myself justified in giving some of the details. It seems necessary, in the first place, to state that, by having large high land farms, he can spare a sufficient number of horses from them to get through any work on the other, while the season is par-



ticularly suitable for it. Immediately after harvest the wheat stubbles, &c. are ploughed about 4 inches deep, that the grass, &c. may be taken off. In November the land is ploughed 5 or 6 inches deep, with swing-ploughs; afterwards harrowed, if dry.

If the weather is suitable, the land is ridged at 27 inches apart, in the manner described when speaking of Castle Acre.

In February, if the weather be dry enough to cart the "muck," from 8 to 10 three-horse Scotch cart-loads per acre of good farm-yard manure (from linseed cake, &c.) is applied, being spread evenly along the rows. The drill follows, its coulters being swung or suspended above the surface of the land, so that the beans may fall on the manure without touching the soil. The Northumberland double-breasted plough immediately follows the drill, and, by splitting the ridges, forms new ones, covering the beans. The seed is applied at the rate of about 10 pecks per acre. Mr. Hudson prefers Fullard's prolific bean, and, next to it, the Heligoland bean, but sows only the former. This method of "ploughing in" the seed was adopted from observing, that beans, when not drilled so as to have the advantages of a great depth in the soil to support them, were often broken by the wind previous to harvest.

This is supposed to be in the latter part of February, or the first week of March. During the following three weeks, the seeds of weeds which lie near the surface of the soil will probably vegetate. A gang of light harrows, therefore, (three, drawn by two horses) is then used; of course in the same direction as drilled; the horses walking in the furrows. This breaks the soil on and near the tops of the ridges, and, by exposing the roots of such annual weeds as may have grown, they will probably be destroyed by the dry weather of March. After this process the beans soon appear through the tops of the ridges in straight rows; and, when they are about 2 inches above the surface, the land is horse-hoed, with an instrument taking only 1 row at a time, but clearing that of all weeds, and leaving the soil pulverized. This horse-hoeing is repeated at least three times; and the oftener the better, when the weather is favourable, as it may thus be made more beneficial to the land than any dead summer fallow; having all its advantages without its drawbacks. Such parts of the ridges as the horse-hoe will not touch, are hoed and weeded by hand. The beans are "shocked" at wide intervals, in order that the land, in the spaces between the rows of shocks, may be broken down by a flag-harrow, called by some a crab-harrow.

The shocks of beans are then moved on to the harrowed land, that the part they before occupied may undergo the same process; and thus all the land is brought into the same state. Immediately after the beans are carted, the Northumberland plough is put

through the ridges, turning out the "muck." In a few days, the same harrow which was used before passes up and down the ridges, and then across them, thus dispersing the manure equally, mixing it with the soil in all parts, and leaving the surface level. The land is then laid in 12-furrow "stetches," across the direction in which it was laid for beans. It is drilled with Spalding's wheat, about 3 bushels per acre; the rows being 8 inches apart. During the time the wheat is growing, the land is hand-hoed, to keep it as clean as possible. Indeed, the whole of this course is so conducted by Mr. Hudson, as to show that he has made up his mind the land shall enjoy all the *advantages* of perpetual fallowing; by which it will, on the other hand, afford him proportionate profits, from perpetual cropping. The crops selected being not only in the list of the most profitable, but, certainly, such as are best suited for following each other, this land, which is adapted for both, may grow them successively, without other variations, for any length of time, if the above principle (of perpetual fallowing) is as constantly acted upon. The last year's crop of beans was a good proof that the land has not been injured, as many of them had 80 pods on one stalk, and one bean had produced 97; the produce per acre being also great. Land is not injured by what some would call over-cropping; because, we see, where properly treated in other respects, it is not injured by constant cropping. It is injured by cropping injudiciously, or taking two crops in succession of a similar nature (as wheat after barley, or *vice versâ*); and there is scarcely any land which ought to grow two white crops in immediate succession, as nearly every good tenant-farmer will allow. Indeed, I have heard many of them say, that the prevention of this is the only really good restriction on a tenant as to his course of cropping. But then comes a more important consideration, viz., as to the *manner* of cropping—that is, whether crops are taken from the land without a return equivalent at least to what is taken away, as a means of keeping up its productive qualities. Also, whether the land is kept in such a state of cultivation as to resemble in its freedom from weeds, &c. a well-kept garden. If these three points, viz., varying the crops, returning what is, at least, equal to that which is taken, and garden cultivation, are combined, I maintain there is no such thing as over-cropping—the idea is merely imaginary. To whatever extent any of these are neglected, to the same extent will the land certainly be injured.

Within the last few years great benefit has been derived from sowing white mustard, not only as a preparation for wheat, but also for turnips. I mention this here, as in some degree confirming what I have just stated as to over-cropping. Mr. Nurse, jun., of Feltwell, near Downham, has this year threshed (of the

harvest of 1843) from 6 to 8 bushels of wheat per acre more, where mustard was sown, than where the land was manured with a quarter of a ton of cake per acre. As, in this instance, the land was not manured for the mustard, the superior produce from it, added to the saving of cost of manure applied in the other case, renders this a strong presumption of its value, as a preparation for wheat. The question for consideration is, how the land is benefited by growing mustard in the manner described by Mr. Nurse. To which I would answer, it is by literally following out the three principles first stated (which were put on paper before I heard the result of his experience). 1st. Varying the crops. 2nd. Ploughing-in all the mustard before it runs to seed; by which, at least, an equivalent is returned to the land for that taken. 3rd. Mr. Nurse strongly recommends that the land should be made as clean as possible; and those who have once witnessed the result of garden cultivation need not be surprised at its beneficial effects in this instance, where it can be united with a mechanical means of improving the texture of the soil (which the green mustard would certainly be), as well as furnishing to the soil itself any chemical aid which the growing mustard may derive from the atmosphere around it, and uniting the chance of all these advantages *with the positive certainty* that you are not injuring the land, because you take nothing from it.

Although, in the one instance named, no manure was applied to the land for the mustard, yet Mr. Nurse recommends manuring, to get as great a quantity of vegetable matter as possible to plough in. I will quote his own words:—

“We have been in the habit of sowing mustard as a preparation for wheat, the last few years, with great success. We have generally sown it on light land (subsoil chalk), cultivated on the 5-course system, by ploughing the two-years-old layer and getting it as clean as possible, manuring it with 7 or 8 loads per acre, and sowing it about the last week in July, or beginning of August, with a peck and a half of seed per acre. On newly broken-up land it is an admirable preparation. We have a field, mixed soil, subsoil chalk, that produced \* \* \* of wheat after a crop of seed without any manure. We have also found it an excellent preparation for turnips on unkind land. It is advisable to get your land as clean as possible before you can sow it; manuring it with 7 or 8 loads per acre, as before stated, and sowing it the early part of April. We consider mustard a great preventive of wire-worms, and generally sow it as a preparation when the land is affected by them. As far as our experience goes, we can strongly recommend sowing mustard as a preparation for wheat.”

This account is probably of more importance than some would at first suppose; for, admitting the difficulty there may occasionally be in cleaning the land after breaking up a layer for a “bastard fallow,” as it is called, yet, if beneficial to wheat, may

it not be so to other crops? There are districts in the kingdom where two white crops are sown in succession; nay, the two least suitable for following each other closely—wheat and barley, which is perhaps the worst possible system of cropping; yet, if we can show those parties a means of getting their favourite crops at the usual season in a less objectionable manner (by having an intermediate green crop to plough into the land), they may be induced to try the plan, and, if afterwards satisfied that they shall profit by it in an increase of crop, possibly they may thus be taught the first useful lesson on the value of changing the nature of crops as often as possible.

If useful as a preparation for turnips, why not sow it immediately after reaping an early crop of wheat or oats, drilling in along with it such manure as, from its price and the nature of the soil, might be proper for the purpose of growing a crop of cheap manure? This, in many parts of the south of England, could often be done early in August (as the horses are not generally wanted for other purposes), before the corn is ready for carting; and from that period to November there would be time for the growth of an abundant crop to plough in as extra manure, in order to act in the most powerful manner on the soil during the following winter. When spring arrived, the land would be found not only richer, but better to clean, than it would have been if left idle for a time, and then ploughed to make clean fallow. By this plan you run no risk of mischief from being caught by unfavourable weather, as in breaking-up layers, for, at the worst, no harm can be done. Besides, land, after a stubble crop, may be cleaned in such weather, as it certainly could not be after a layer newly broken up. But, as there is not the same necessity for cleaning effectually at once, where the following crop is to be turnips, as there is where it is intended for wheat, the chances are rendered greatly in favour of having a more suitable season to prepare for one crop than the other.

So few Oats are grown in Norfolk, that it is in most districts difficult to find a field of them. Every reader of agricultural books may know the crop has had a bad name with some whose opinions became very influential, not only in that county, but in others. I was prepared to find something peculiar in the nature of the soil, to render it unsuitable for the crop; but, although I made most diligent inquiry for evidence of this, I could not hear any, either from those who cultivated their own land, or who were tenants of others. One of the best farmers of West Norfolk, and occupying his own land, says, "I really know no reason, practically speaking, why oats should not be grown, for I find that, if I manure for them at the same rate as I do for other crops, I get more return than I do even from wheat; and I have not yet

found the succeeding crop worse for them. If the manuring or the weeding is evaded, because it is an oat crop, the after poverty is to be attributed to the farmer, and not to the grain. I know a small farmer who has invariably grown oats instead of wheat for many years, because he could make more money by them."

Mr. James Everitt, of North Creake, sows part of his seeds (or what with most others would be their wheat shift) with oats, of which he grows good crops. He selects the lightest of his land for them, as being least suitable for wheat, and thus the crop is more valuable than it otherwise would be from such soil. Mr. Everitt's oat crops have been increased about 16 bushels per acre by dressing the land with nitrate of soda, at the rate of about 1 cwt. per acre, but always with this result, that the oats are lighter by nearly 3 lbs. per bushel. It is necessary to observe, that he always sows Tartarian oats, which, however suitable *for land not in high condition*, might here probably be superseded with advantage, inasmuch as I have seen abundant proofs that, by sowing a species which grows heavier grain, you may counteract the tendency to too much straw, and produce by this means a greater quantity of corn per acre, as well as of better quality.

The same principle applies to corn as to stock, viz., that what is peculiarly adapted to soil *in a certain state* will not be equally so when its state is changed. Nearly all persons will admit the truth of this, when they see it on paper, but many are too apt to forget it in practice.

I do not mean to advocate the sowing of oats where there is a probability of obtaining another more valuable crop, as it would be the extreme of folly to do so. But when we consider how important it is to *vary* the crops as much as possible, in order that each may profit by the longer interval, and how science, theory, and practice agree and confirm each other on this point,—that *land may be in some degree exhausted of its capabilities of growing one species of grain*, yet, provided it is in a clean state, may at once produce a comparatively good crop of *another which is opposite in nature*, and requiring a different nourishment,—so it surely is desirable to remove anything like prejudice against a particular grain, and thus afford to all a greater choice and means of change, according as they deem it advisable, after fairly weighing, not only the general principles, but the peculiar circumstances of their own case.

It is right to observe, that all the light-land farmers, who spoke most favourably of oats, seem to have grown them on farms where the subsoil was generally chalk. I am inclined to think that sand is not so suitable, but I could not procure any evidence to establish this. Indeed, the only reason given why this crop had

acquired a bad name was its having been so generally *accompanied*, in former times, by what was really bad farming.

Near Acle, on loam with clay subsoil of a yellow colour, I observed this singular course:—turnips, potatoes, beans, wheat, clover, wheat. I neither wish to advocate its more general adoption, nor to say that I saw any proofs of its having been disadvantageous; but I think it my duty to state the details in carrying it out, and the particular results I observed from it.

There is nothing very remarkable in the preparation for, or the management of, the turnip crop; but, as on all other highly cultivated farms, care is taken that it shall be a good one, by applying manure, &c. liberally. After consuming the turnips (the larger portion of them on the land by sheep), it is ploughed twice, when convenient, and as the weather is favourable, and then left level, until about the middle of April, when furrows are opened, 3 feet apart, with a double mould-board or Northumberland plough. The potato sets are conveyed in a one-horse cart, from which they are supplied by a man with a large shovel to six women or boys, with strong aprons to hold the pieces, until they have dropped them singly into the furrows, at the distance of 9 inches apart. The droppers are followed by another double plough, to cover in the seed by reversing the furrows, which are then to be rolled down, in order to make them firm. This number of workpeople are enabled, by following the method described, to set 6 *acres in a day*. Whilst the potatoes are growing, the land is horse-hoed and hand-hoed as often as possible, on the supposition, that every stirring of the soil admits fresh air and increases the crop. After the potatoes have been taken up, the land is ploughed. In the spring, single furrows are ploughed, 3 feet apart, in which the beans are scattered, at about the rate of 2½ bushels per acre. It is observed, also, that the crops of beans are much improved by applying some manure in the rows with them. The land is then harrowed, first along the furrows, then across them. It will be understood that the beans are here applied in single rows; but some prefer the gardener's method, of having two rows, so near, as *only* to admit a small hoe, when necessary, but with wide intervals adjoining, to admit the horse-hoe, air, &c. Many deposit the seed by drill. All allow the great importance of horse-hoeing, and hand-hoeing, as much as possible. The wheat is drilled; the rows 9 inches apart, and 3 bushels of seed per acre. While the crop is growing, the land is horse or hand hoed. As there is nothing very peculiar in the treatment of the other crops, the question arises, how does this system answer? The potatoes are generally very good, and the value of a good crop of them is well known. The beans being

so much improved by manure afford ample proof that the good preceding crop of potatoes has taken something out of the soil; but, that the system on the whole is not impoverishing to it is amply shown by the abundance of the wheat crops. If those I saw had any fault, it was that of too much straw. I will give my readers an opportunity of judging for themselves, by a sample of them taken from the middle of a field, where the men were reaping the corn. One "land," or "stetch," 8 yards wide and 195 yards long, had produced 296 sheaves, which measured on an average 2 feet 5 inches where they were tied (close by the band). This is at the rate of 76 shocks per acre, with 12 sheaves in a shock. It is necessary to state, that this system is accompanied by box-feeding cattle with turnips, baked potatoes, bean-meal, and oil-cake in abundance: also, that the liquid manure, which would otherwise be wasted, is preserved in tanks; in short, nearly all the best practices of first-rate farmers are brought to its aid.

#### *Beans.*

There are more beans grown in Norfolk than many persons would suppose; as, in some districts of it, part of the land is sown with beans in lieu of, and to defer, the clover crop; and those I saw of the harvest of 1843 were extremely good crops, with scarcely any exception. Nearly all of them are in rows, either drilled or dibbled (but most commonly drilled), so as to allow the frequent use of the horse-hoe. I have already given some of the details of managing this crop, when forming a part of a peculiar course, therefore I will here only state the plan of growing beans as adopted by Mr. Neave, of Downham Grove, near Wymondham, one of the most intelligent practical farmers of the county. The rows are 14 inches apart; the beans put in singly, 4 inches from each other. The quantity thus used for seed about  $2\frac{1}{2}$  bushels per acre. As soon as the beans have grown, so as to be out of the ground, the land is harrowed, and, on a dry day, rolled. The land is horse-hoed as often as possible, and once hand-hoed. The growing beans are rolled, when about 3 or 4 inches long.

#### *Tares.*

I find some of the most intelligent practical cultivators of land have recently adopted the plan of sowing tares in their new layers, especially where the clover is not well set, or where it is not likely to be a productive crop, alone, from the nature of the soil or other causes. This is done by drilling the seed in, immediately after harvest, at the rate of 1 to 2 bushels per acre; the drill-coulters being very sharp and narrow, so as to run along betwixt the drills of barley-stubble, without doing any material

injury to the clover. Some dibble the land for tares, where the layer is "patchy." The seed is covered by "bush-harrowing;" the land manured before the tares come up, and rolled early in the spring. One person says, "I have grown tares in various ways, and at last decided on sowing them only upon a layer. If I sow them on a stubble, I always lose my turnips after them. I put them on my layer, because I cannot always get clover to rise sufficiently to mow, on my dry land. Tares help the clover, and both together come early and make a large crop." Another says, "You have an abundant crop of green food, much better for stock than tares alone, or tares with a mixture of wheat, oats, or rye, as generally sown; which horses will not eat after a short time; and, even if you put them through a cutting-machine, they will still pick out the tares. I frequently sow from 10 to 15 acres of tares in a weak new layer for folding off with my ewes and lambs. If eaten before the tares flower, the crop is not injurious to the wheat which follows." The former gentleman states, "I never found the wheat suffer afterwards, if the tares were not allowed to ripen the seed, or if sown with (red) clover. Once I sowed them with white clover and trefoil, and I hurt the wheat crop; but it was, as I thought, because nothing rose to cover the ground after the first mowing, so as to make a flag for the wheat." In order that this may be more readily understood by persons of other counties, I think it right to state, that red clover is not grown oftener than once in eight years in Norfolk, and only once in twelve by some. In short, they all follow the plan of varying their grass-seeds each course; and they all agree, that one of the best securities for a good crop of wheat is to plough in a "good flag."

#### *Cabbages.*

I observed several small plots of cabbages in different parts, but select Mr. James Everitt's description of his manner of growing them at North Creake, not only because they were at least as good as any others (if not better), but because I think his statements respecting them calculated to be useful. He says:—

"I never, in any one year, have more than 3 acres, as I use them only in my lamb-yard during the lambing season; nor, on my light land, should I attempt to extend my quantity; being satisfied they are immense exhausters of the soil, and require a larger proportion of manure than any other crop."

Mr. Everitt adds, he has tried two methods—transplanting, and sowing the seed where he intends the crop to grow. I will give their description, as nearly as I can, in his own words:—

"In the former, I sow the seed in April, upon a well-manured seed-bed, at the rate of 1 lb. of seed for an acre. I ridge the land about mid-



summer, with a double-breasted plough, the rows being 27 inches from centre to centre, and then deposit at least 15 loads of farm-yard manure, and a quarter of a ton of rape-cake, per acre; split the ridges, so as to cover the manure, and then run a light roller over them.

“In the first period of damp weather I employ women and girls to transplant them in the ridges 18 inches apart; of course they require horse and hand hoeing.”

By this plan the cabbages are generally larger than by drilling, except when the weather is very warm and dry; but, even then, watering by hand will save them. Mr. Everitt, however, finds this plan expensive; and although the other, of drilling the seed, does generally produce a lighter crop, he is inclined to follow it in future; and the crop I saw was so sown. The seed is thus drilled on 27-inch ridges, about the first week in June, in the same manner as swedes, except having manure applied more liberally for cabbages.

Mr. Everitt grows two sorts—the “thousand-head,” and the “drum-head,” either of which the sheep will eat very well. For the first day or two after ewes have lambed, he finds they prefer cabbages to anything else, and they are great promoters of milk.

---

#### TENURE.

Norfolk, undoubtedly, owes great part of its fame, as an agricultural district, to the clear views of the late Mr. Coke (afterwards Earl of Leicester), as to what are the moving springs of human action. It thus becomes our duty to inquire, what those principles were, as he evinced them in the management of his own estates.

After a very careful investigation, I think I am justified in concluding, that the whole conduct of this prince of landlords towards his tenants was founded on two great principles:—

- 1st. That to induce a man to exert to the utmost such ability as he possesses, you must show him that his doing so will be rewarded by benefits to himself, and not merely to others, who have no just claim to the exclusive advantages of the fruit of his labour; in other words, to prompt men to great and extraordinary industry, you must satisfy them, they shall certainly be rewarded for their exertions, by at least participating in those permanent improvements which they alone have created.
- 2nd. That, in order to gain the advantage of first-rate talent, added to sufficient capital, you must not trust to chance, but hold out some advantages to attract and secure to yourself those select men as tenants.

The first may seem to some a strange doctrine to apply in the management of estates, although the same parties would say, that the English people distinguish themselves by their industry, chiefly because the laws of their country guarantee to them security for the fruits of their labour, so that "he who sows shall certainly reap."

On this principle Mr. Coke (to his honour be it said) granted leases, making up his mind to the disadvantages of them, which could only affect himself, whilst the benefits to others would certainly be great. Yet I am prepared to admit, that leases are not necessary to good cultivation, though I as distinctly say, that security to the tenant in some shape is absolutely necessary, for the general and permanent improvement of the soil. A much-respected friend of mine says, when speaking against "leases," there ought to be a mutual well-placed confidence between "landlord and tenant." So say I; but I might also say, if all men could and would be honest, we should have little occasion for law. Those who know this gentleman's strong feeling in favour of old tenants would have little occasion to fear his taking any unfair advantage of confidence placed in him; but who is to say what changes a year may produce in the ownership of the estate, &c., so as seriously to affect the tenant, in the absence of a written, or recognised and effectual, protection? It is a matter of business, and as such it ought to be treated. None will deny that there are many instances in Norfolk where the tenants of an estate have doubled its value to the owner, by laying out their money, not his; and they surely had as good a right to some security for their capital expended, as the owner would, if he had purchased with his money an adjoining estate of equal value?

Who is there that could advise a gentleman to purchase and pay for 4000 acres of land without taking some title-deeds for security? And if not, who, with common sense and common honesty, can advise ten farmers to lay out their capital on their farms of 400 acres each, so as to double the value of the land, and that without any written or positive guarantee, that the owner may not, at any year's end, appropriate the whole of their improvements to himself, without making them the least return, or allowance, for the money they had laid out under a misplaced confidence in him?

To secure the assistance and advantages of first-rate talent in the improvement of his estates, Mr. Coke gave, not only security, that each should reap a certain portion of the benefits arising from his own exertions and skill, but he provided superior houses, and other accommodation, for his first-class tenants. This, undoubtedly, was well adapted to the object in view. I am not about to advocate a great outlay, in every case, on farm-houses and farm-

buildings, nor any outlay inconsistent with the occupation and business of the tenants; but there should be, on all farms, such buildings, conveniently arranged, as are necessary for the economical carrying on of the farm, and no more than are necessary, so that they may be kept in good order at moderate expense.

There should also be such a dwelling-house as is suitable for the management of the farm, and appropriate, as a residence, for the family of a man who possesses talent, and such an amount of capital, as is invested in that occupation. When, in anything, we are determined to have the best of its kind, we must be prepared to pay the best price for it, more especially in this case, when the value is certainly known to the party who has it to dispose of. This Mr. Coke well knew, and on this knowledge he acted, when providing superior accommodation for his first-class tenants. That his mode was very successful, all allow; but all cannot afford to pay the price which he did, and, as a natural consequence, their estates must be, in such cases, generally cultivated in an inferior manner. Men, no doubt, have a strong feeling in favour of the scenes of their early life. Old ties are in this case very strong, and may, in some degree, incline a person to put up with inconveniences which would otherwise be insupportable; but this is certainly a state of things to be regretted, as, at best, no great improvement can reasonably be expected under it. The value of leases to tenants has, however, in my opinion, been greatly overrated. For what are they to them but a temporary means of delaying, and more distinctly marking the time, when the rent may be increased with apparent justice? And if the case be considered merely as a matter of business, and not of feeling at all, the longer the day of reckoning is deferred, the more severe will it be when it comes. In other words, if the landlord would have demanded an increase of rent at an earlier period, supposing there had been no lease—the preventing his doing so, by that lease, will certainly have the effect of increasing his demands at its expiration. If he would not have wished for the increase, where are the benefits of a lease over a yearly tenancy with protective covenants? Supposing this presumed advantage of leases to be but a doubtful one, they at once become more dangerous to the tenant, as marking the time when the landlord may, with apparent justice, demand such an increase of rent as he probably would not otherwise have thought of. On the other hand, they may be rendered certain sources of increased income to landlords, if they make up their minds to a temporary diminution of the owner's privileges. I quite agree with Mr. Blomfield, that there is no way of making more rent of land, than by granting 21 years' leases of it, to such (and only such) tenants as are likely to cultivate it in the highest possible manner; and, when such lease has half run out, offering

to grant that tried and proved good tenant a full and renewed term, at the best rent he would then be inclined to pay. Under these circumstances it would be judicious in the tenant to submit to paying a greater rent, as a premium on certainty, than after the ebb tide of his lease's natural conclusion, with his land reduced in condition, and prepared for quitting. A large proportion of the land in this country is owned by gentlemen who would not be guilty of intentionally ill-treating any one dependent on them, but who are unwilling to grant leases, so as to be left to the mercy of others—their feelings being, in many cases, powerfully acted on by agents for their estates, possessing no better idea of serving their employers, than a determination to prevent any tenant from obtaining more than the common rate of interest for money which he has expended to the permanent improvement of another person's land! To have land cultivated in the best possible manner, or in the way which is most beneficial to the community, you must, in the first place, find those who have capital and skill equal to their task; and, in the second, you must convince them, that their time, capital, and ability will not be misapplied. In short, if the land-owners would but once determine to make it consistent with common prudence for a good and clever tenant to lay out his capital on their estates, they would not have so much occasion to take the trouble of recommending high cultivation; for every man likely to make a good tenant well knows, that much money was never made by low farming. If we inquire, we find in almost every instance, where particular parties have made more profit by the cultivation of land than their neighbours, under similar circumstances, it has been owing, chiefly, to a judicious, but at the same time a more liberal, outlay of capital. There is nothing more certain than this, that in a country like ours, which is so heavily taxed for the purposes of government and maintaining of the poor, if land will not pay for high cultivation it will not pay for neglect. Government must be supported, and the poor must be maintained; therefore, as long as the land produces anything, that produce must be chargeable to these national claims. Besides which, many of the direct expenses of cultivation are nearly the same, whether that is properly done or not; consequently, any one of good sense, who reflects a moment, must see, that the extra capital, if judiciously applied, will generally be returned with the greater interest.

It is very well known, that after cattle have been feeding for a time, they increase in weight in a greater proportion for the food consumed, than they did at first. In their lean state, a large proportion of the food they took was requisite to support them and keep them in tolerable condition; but this demand having been satisfied, and the work of fattening once commenced, every little addition of a nutritious kind would operate with increased effect

in favour of the object in view. So is it in the cultivation of land in this kingdom, and, I believe, even in a much larger degree than in the feeding of stock. The last few shillings per acre laid out may so increase the produce as to pay, on that last expense, a handsome per centage, whilst all previously laid out might be swallowed up by the common demands on the land, and thus pay no per centage at all.

Would we condense into one sentence that which best represents the general interest of Britain, it is the most perfect cultivation of its soil. Some persons may cavil at this, but few will distinctly deny it. At any rate, few, who reflect on the present circumstances of this country, will say, that the owner of land is not in duty bound to see as much labour employed on his estates, as possible, without positive loss to himself or his tenants. In this respect it is undeniable, that property has its duties, as well as its rights. It is evident, likewise, that by each land-owner seeing that everything was done on his estates likely to return 20s. and a fair interest for the pound, such an impetus would be given to the general trade and commerce of the kingdom, through all the various branches or channels along which this, the original, stream flowed, as would eventually return to the original movers of it an indirect but certain benefit. If these positions are well founded, it becomes a very important question, how an arrangement can be made between landlord and tenant, so that the former shall retain all his privileges, and the latter apply his capital, time, and energies with the greatest benefit to himself and the highest usefulness to the whole community? Leases have undoubtedly been more common in Norfolk than in many other counties; and it is quite as certain, that great and permanent improvement in the soil has generally been observed after their expiration.

Many landowners admit this, but say, however great improvements may be made for those who are to possess our estates a certain number of years hence, we should be paying dearly for them, by sacrificing in the meantime the power we have over our own property. This is a very important objection to leases, and it is well known that no amount of rent would tempt some landowners to grant a lease of a farm, especially if it were near the proprietor's residence: and, it must be confessed, there are few cases in which one could, without hesitation, recommend them to do so. It becomes, therefore, necessary to inquire into the principles of leases, and the nature of such objections as are raised against them, in order to our seeing whether we can, by any other means, secure the advantages to be derived from them, without drawbacks. Leases are recommended by some on the ground that they give a certain degree of security to the tenant for the capital he may choose to lay out on the land of another. But,

besides the objection to them already named, they are objected to on this principle—as being binding on the landlord in times of high prices, but not on the tenant when agricultural produce is depreciated in value. This objection (of their not being binding on the tenants in times of low prices) is, I believe, seldom made by those possessing sufficient practical knowledge of cultivation to enable them to appreciate properly the great advantages of having a farm in high condition—which I suppose it would be in if held under lease, or covenants of security to the tenant's capital. Indeed, I would venture to submit, that if Great Britain were divided into three parts, and each let separately under one of the following agreements, all the land might be cultivated in the highest possible manner; for, although this division would allow each owner and each tenant to select the one agreement best suited to his own feelings, all would be so far founded on justice to the party who expended his capital for the improvement of the soil, as to insure the most liberal outlay of it.

1st. Leases.

2nd. Insert a clause in the lease granted, under which the owner should have the power to cancel it, on giving 18 months' notice, and paying to the tenant such sum as two arbitrators (one for each party) should think a fair compensation to the tenant for his permanent improvements, bearing in mind all the circumstances of the case affecting landlord or tenant.

3rd. By giving the tenant a clause, under an agreement as a yearly tenancy, by which he would be entitled to a fair and equitable allowance, for all permanent improvements made at his expense, but with the sanction of the owner, on written notice of such intended improvements having been given to the latter or his agent, and not having been answered within a given period, or in time to prevent that outlay which the owner of the land would not sanction.

I have known an instance in Lincolnshire in which some large farms were held by one person as yearly tenancies, but with a covenant similar to the last above suggested; and in 21 years the whole of the land was chalked, without costing the owner 6*d.* The tenant's rent had been gradually increased, from time to time, so as to be nearly double what it was at the commencement; but, from the high state of cultivation into which the soil was brought, under the protection of the covenant alluded to, the tenant thought it judicious to submit to that increased rent, because he could afford to pay it; and I have little doubt he made much more money by his farms than he would have done had he held them during the

whole period, at the original rent, without the covenant alluded to.\*

\* The following is a copy of the covenant under which these improvements were made:—

“That if the said \_\_\_\_\_, his executors or administrators, shall purchase any bones, lime, or other manure, or dig any marl or stone, and use the same upon the said farm, the amount of such purchase, or the expense of such digging and getting, agreeably to the customary valuation of the country, shall be divided into four parts for the bones, and seven equal parts for the stones, or marl and lime; and at whatever period the said \_\_\_\_\_, his executors or administrators, shall leave or quit the farm, the said \_\_\_\_\_, his heirs or assigns, or the succeeding tenant in occupation, shall repay unto the said \_\_\_\_\_, his executors or administrators, so much of the amount of such expense as shall be in proportion to such a number of years as the said \_\_\_\_\_, his executors or administrators, shall fall short of four or seven years' occupancy of the said farm, after incurring such last-mentioned expense.”

After writing my article on tenure, ‘The Report of Lincolnshire’ appeared, and I immediately wrote to the son of the gentleman above alluded to, asking—“Whether he would have preferred a lease of twenty-one years, without any allowance at the end of it, or his chalk, lime, and manure covenant under a yearly tenancy?”

His answer to this was, “I should prefer a lease of twenty-one years without the covenant, if I could not have both.”

I also asked whether Lord Yarborough's tenants are protected by similar covenants.

The answer was, “Lord Yarborough's tenants, and all others in this neighbourhood, are protected by those covenants.”

Now, if the Lincolnshire farming is better than the Scotch farming, of which we hear so much, I think it pretty strong evidence in favour of such covenants as I am now advocating.

I feel thankful for the occasion which has supplied me, so unexpectedly, with the strongest proofs of their advantages, in the Report on Lincolnshire, by Mr. Pusey.

1844, August. From further inquiries on this important subject (and I call it so, because involving the question as to the cause of such high farming in Lincolnshire), I find that on the Earl of Yarborough's estates, and some others, the fixed allowance to an out-going tenant for linseed-cake, is “half the value of the cake he consumed with beasts in the yards during the last year.” My informant adds, “I dare say it will become general at no distant period. It certainly ought to be so.” Another Lincolnshire gentleman says, “I think the allowance for marl in this part is extended to ten years, instead of seven. It is seven years for lime, five years for clay, and three years for bones or any other artificial manure.”

However the amount of allowance may vary in different districts of the county, there can be no doubt that security to the tenant, for improvements made at his expense, is now generally recognised in Lincolnshire, as the most firm and certain foundation for prosperity to owners, occupiers, and labourers. This principle is the rock on which the splendid farming of Lincolnshire is founded.

The late Earl of Leicester gave security, in another shape, to his tenants in Norfolk, and the effects were similar.

I think this a tolerably strong proof, that it is most important to the interests of the whole community to have such agreements between landlord and tenant, generally, as shall justify the latter in liberal cultivation. The best cultivated farms in Norfolk are, for the most part, either the property of those who cultivate them for their own benefit, or held under long leases. I have stated the objection to leases; but I think it right to repeat, that they are really only objectionable to the owner in the case of his having a bad tenant—although, unquestionably, he is the proper person to decide, whether he ought to incur the risk alluded to or not. There are instances, no doubt, of good cultivation without leases; but, if we examine into each case, we shall find the occupier supposes (whether rightly or not) that he has what amounts to security, either in a written protection, or in the high character of the owner, as representing “the old English gentleman.” When all such security is wanting, the effect is lamentable to tenants; as also to their labourers, and therefore to the public: neither is it less so to the real interest of the owners themselves! This consideration reminds me of a caution I received, whilst looking over a gentleman’s farm in Norfolk—not to suppose the land on the opposite side was his; respecting which I was informed, that the land “belonged to a certain corporation, and was let by tender every 7 years; therefore, you could not expect it to make a decent appearance.” This speaks volumes as to the effect of want of security—that he who improves shall in some measure enjoy; but even this case, of letting by tender every 7 years, seems to represent a more honest feeling in the worthy corporation than is possessed by those who improve their income, for the time, by resorting to, what I recently heard described as, the “licensed robbery of a confiding yearly tenant;” a strong expression, but in many cases, unhappily, too true.

Where the tenant’s right\* to a fair allowance for all permanent improvements (made under the sanction of the owner or his agent) is admitted by written document or established custom (as I am

---

\* These covenants in Lord Yarborough’s agreements as to unexhausted improvements are merely just to the tenant in securing to him the money he has sunk in his farm. They have practically succeeded in producing very great improvements where they have been adopted. They are also accompanied by a clause in the landlord’s favour, binding the tenant to purchase artificial manures for the whole of his turnip-crop. The absence of capital from land where it might be profitably employed has been long lamented, yet few landlords have funds at command for the general improvement of their estates. I can see no means so likely to supply this old defect, and to bring England generally into the condition of Lincolnshire, as the adoption of Lincolnshire covenants. The subject of unexhausted improvements seems to me the most important of all agricultural subjects for landlords at present, and the improvement of our agreements in this respect to be a condition *sine qua non* of any steady and general improvements of the soil or its cultivation.—PH. PUSEY.



informed is the case in some parts of the county), all the most important benefits of a lease are obtained. Or, supposing the owner should give notice to quit, or increase his rent, he will recognise the right of the tenant, or his representative, to a fair allowance for such his permanent improvements (not, of course, where the tenant abandons the occupation voluntarily): even that security might justify a liberal outlay of capital, and would probably cause great and general improvement in cultivation. Thus, although 21 years' leases are common on the estates of the Earl of Leicester and others, there are some highly cultivated farms in Norfolk held as yearly tenancies; and several tenant-farmers told me, that with such landlords as the Earl of Albemarle, and such custom as the one just described, they should care little about having a lease. In other words, they would feel assured, that no new agent—ignorant of the value of land, because he did not know how to cultivate it—who could not tell which soil was most expensive to till, or whether the superior produce on a given farm resulted from a superior soil or better cultivation—that no such person as this should be sent down “to value” (as he would call it) their farms, and to report (as he, of course, would), that all who—by their liberal application of manure—by their great outlay in draining, claying, marling, &c.—had most distinguished themselves, were just the persons, and the only persons, whose rents ought immediately to be increased—because they had better crops than their neighbours; not taking into consideration that this, of all others, is the most effectual check to improvement that any one can apply.

I met with a few instances of corn-rents. Although these evince a kind and sympathizing feeling on the part of the landlord, yet corn-rents do not provide against those differences in prices which are occasioned by a very good, or very bad, harvest at home. If we take the two extremes, we find a wide difference in the quantity of corn the tenant has to sell: therefore, in some years, corn-rents would operate unjustly towards the landlord, and in others towards the tenant. I heard of a case in which a gentleman let his farms (situate at the western end of the county) under corn-rents, but some bad seasons following, the tenants were unable to pay increased rents out of deficient crops, and, therefore, were compelled to throw up their leases.

#### *Grass.*

There is only a small proportion of old grass-land in the county, and what there is, cannot generally be called good, though there are some very beautiful pastures, in and near the marshes. In treating grass, as well as arable, the farmers of Norfolk keep to the plan of giving to stock, in the first instance, what is intended to

benefit the land, knowing, that the richer food they give to cattle, the richer will their land become. The conversion of arable land into pasture, by transplanting, is peculiarly interesting, having been first done by Mr. Blomfield, of Warham, in this county, and since Mr. Young's report. The plan described by Mr. Blakie is yet followed by many. I saw it in nearly all stages of the work.

Several farmers have recently adopted, what they consider to be, an improvement on the former mode. It is this:—

They do not mark the land with scarifiers, but spread the fragments of turf in the same manner as manure; after which, it is rolled with a heavy iron roller, some small seeds being sown on the land in the spring. They state that this plan answers equally well (as the turf will grow either side up), and it saves nearly half the cost of transplanting. One gentleman states, that he had 6 acres done in this manner, and the cost in labour was only about 1*l.* per acre.

#### *Alteration in the Breed of Sheep.*

Alluding to Old Norfolk sheep, Mr. Kent says (p. 103)—“The Norfolk farmers will never be able to substitute any other sheep that will answer penning so well:” but on the next page he adds—“When land becomes much improved, stock may be improved in proportion; and in some instances the breed may undoubtedly be crossed with propriety.” Now, I find that a most remarkable change has taken place on this very principle named by Mr. Kent;—his favourite “Old Norfolk sheep” are almost totally superseded in the county. Although described as favourites in Smithfield at that time, there are now seldom any to be seen there. On two occasions the different breeds of cattle and sheep were counted for me, especially, by the Clerk of Smithfield Market; and there happened not to be one of the old and horned breed of Norfolk sheep there, on either of those days. I had previously looked for them there in vain; when it struck me, that it would be not only very interesting, but very useful, to know how many of each breed of animals had been shown at that great mart at any bygone period. This would, by showing the changes produced by time and circumstances, enable a person the better to judge what might be suitable in his own situation. With this view I had the stock counted by Mr. Shank, and on his authority I subjoin the following return. From the task being new, he had great difficulty in making out the statement I wanted, viz.—not only how many there were of each breed, but how many of each breed from several of the most important counties:—

AN ACCOUNT of the Number of BEASTS and SHEEP at Smithfield Market, on the days alluded to in this Report, and ascertained by Mr. Shank especially for the Author, in order that the numbers might be here inserted.

MONDAY, December 18th, 1843.

BEASTS.		SHEEP.	
Cross of Durham and Lincolns (called Lincolns at Smithfield) . . . . .	628	Old Norfolks . . . . .	None.
Leicesters . . . . .	526	Lincolns . . . . .	4,976
Scots . . . . .	274	Leicesters . . . . .	4,250
Norfolks (Half-Breds) . . . . .	42	Downs . . . . .	3,925
Devons . . . . .	292	Norfolk (Half-Bred) betwixt } Leicesters and Downs . . . . .	1,157
Half-Bred . . . . .	213	Mixed Breed . . . . .	4,812
Herefords . . . . .	383	Hampshire Downs . . . . .	1,935
Irish . . . . .	144	Cheviot Downs . . . . .	110
Welsh . . . . .	143	Kents . . . . .	150
Wiltshire . . . . .	39	Welsh . . . . .	41
Cows . . . . .	233	Gloucester . . . . .	230
Sussex . . . . .	98	Horned Scotch . . . . .	20
Durham . . . . .	18	West Country . . . . .	100
		Wiltshire Horned . . . . .	30
Total . . . . .	3,033	Total . . . . .	21,766

MONDAY, February 12th, 1844.

BEASTS.		SHEEP.	
Lincolns . . . . .	703	Old Norfolks . . . . .	None.
Leicesters . . . . .	58	Lincolns . . . . .	3,683
Norfolks . . . . .	507	Leicesters . . . . .	2,070
Scots . . . . .	582	Norfolks (Half-Bred) . . . . .	1,893
Devons . . . . .	127	Downs . . . . .	5,138
Herefords . . . . .	200	Hampshire . . . . .	2,260
Welsh . . . . .	117	Mixed Breeds . . . . .	4,670
Irish . . . . .	12	Herefordshire Downs . . . . .	250
Half-Bred . . . . .	160	Kents . . . . .	235
Cows . . . . .	223	Dorsets . . . . .	20
Total . . . . .	2,689	Total . . . . .	20,219

Mr. Shank's Statement, as to where the Beasts and Sheep had been fed, which were shown at Smithfield Market on MONDAY, February 12th, 1844.

BEASTS.			
Norfolk . . . . .	910	Kent . . . . .	4
Essex . . . . .	186	Somersetshire . . . . .	31
Sussex . . . . .	43	Scotland . . . . .	318
Lincolnshire . . . . .	289	Bucks . . . . .	43
Leicestershire . . . . .	142	Cambridgeshire . . . . .	29
Herefordshire . . . . .	38	Devonshire . . . . .	18
Hertfordshire . . . . .	73	Oxfordshire . . . . .	17
Northamptonshire . . . . .	171	Wales . . . . .	4
Bedfordshire . . . . .	46	Middlesex . . . . .	112
Gloucestershire . . . . .	20		
Suffolk . . . . .	195	Total . . . . .	2,689

## SHEEP.

Norfolk . . . . .	3,065	Kent . . . . .	535
Essex . . . . .	2,711	Surrey . . . . .	1,210
Sussex . . . . .	210	Hampshire . . . . .	280
Lincolnshire . . . . .	2,513	Bucks . . . . .	620
Leicestershire . . . . .	540	Cambridgeshire . . . . .	1,570
Herefordshire . . . . .	100	Devonshire . . . . .	330
Hertfordshire . . . . .	2,110	Dorsetshire . . . . .	20
Northamptonshire . . . . .	490	Berkshire . . . . .	1,450
Bedfordshire . . . . .	670	Middlesex . . . . .	485
Gloucestershire . . . . .	380		
Suffolk . . . . .	930	Total . . . . .	20,219

Mr. Shank's Account of the Number of Beasts and Sheep in Smithfield Market on  
MONDAY, February 26, 1844, from Norfolk.

	Beasts.
Home-bred Beasts, called Norfolks . . . . .	141
Durham, &c., called by some Lincolnshire, many of them being bred in that county . . . . .	633
Scots . . . . .	238
Devons . . . . .	9
	1,021
Total Number at Market from Norfolk . . . . .	

N.B. About 2,300 Beasts at Market altogether.

	Sheep.
Thorough-bred Norfolk Horned Sheep . . . . .	10
Black-faced Sheep, called Norfolk Downs, being a cross of the two . . . . .	320
Half-bred Sheep, between Downs and Leicesters . . . . .	3,302
	3,632
Total Number at Market from Norfolk . . . . .	

N.B. There were about 21,000 Sheep altogether at Market.

## APPENDIX.

*Experiments as to the best distance of the Rows in Drilling Wheat,  
by Mr. Blyth, of Sussex Farm, Burnham.*

1839. Seed per acre  $10\frac{1}{2}$  pecks; drills 7 inches; produced nearly  
2 bushels per acre more than 9-inch drills.

	st. lbs.		st. lbs.
1842. 9 in.—18 rods produced	28 6	corn and straw—	14 2
7 in.— „ „ „	32 4	„ „ „	16 0

About  $3\frac{1}{2}$  bushels of wheat per acre in favour of 7 inches.

	st. lbs.		st. lbs.
1843. 9 in.—6 rods produced	17	sheaves =	13 4
7 in.— „ „ „	20	„ =	14 6
$4\frac{1}{2}$ in. „ „ „	18	„ =	14 2

$4\frac{1}{2}$  exceeded 9 by 8 pecks nearly }  
7 „ 9 „ 11 „ 3 pints } besides straw.

*Quantity of Seed.*—Certain opinions have recently been much circulated, in Norfolk and elsewhere, in favour of, and recommending, a great and general reduction in the quantity of seed per acre to be applied.

Before I alluded to this, one of the best practical farmers of Norfolk remarked, voluntarily,—“that he thought those new doctrines more calculated to do great and extensive mischief (not only to the growers, but to the consumers of corn), than any other theory he ever remembered to have been broached.”

This gentleman's name is not given in any part of my Report, but many of his practices are described, and some of his crops alluded to, as he is considered by all who know him to be a very good authority on agricultural matters generally.

In proof, that he is not one of those said to be bigoted in favour of old opinions, I may state, that he adopted Scotch carts, cattle-boxes, and liquid-manure tanks several years ago. He tries many experiments; but, as I am not allowed to give his name, I will insert the result of one series of experiments on this point, as tried by another gentleman in a different part of the county; but think it right to state, in the first place, how the question stands. All admit, that there must be some particular quantity for each soil, and each particular situation of it, which in a certain season, supposing all circumstances to be known beforehand, would be best for sowing in any given manner. All agree, that there must be some particular quantity, which on an average of seasons, and circumstances of those seasons, would be the most profitable to apply in any particular manner, supposing the party bound to make choice of a certain quantity for sowing each year; that, if you improve the manner or method of sowing, or putting in the seed, you may thereby reduce what was before the necessary quantity; and that, if you happen to sow more than the succeeding season proved to be necessary, you in that case might lose something by “thick sowing.” But, if the whole system is to be characterized as folly, because some one, who was trained to agriculture in a counting-house, says, that such extra quantity ought not to have been sown—surely his sphere of usefulness might be extended. Why should he not advise the farmers, and the public generally, not to insure their property from fire, because many find, at the end of every year, that the expense of insurance had been, somewhat like the extra seed-corn, proved unnecessary, except as a security from the chance of a loss infinitely greater? All agree, that if the saving of a bushel per acre on the quantity of land sown in England could be effected with safety, whether by improved modes of putting it in or otherwise, the saving on the whole would be great; but all, with common sense, must see how very much greater the loss would be, if all or half the land happened to be sown with a bushel less per acre, than the season following proved to have been necessary. The result of this is fearful to contemplate; and, if we consider the proportion which the seed bears to what in this case it might have produced, we need not be surprised at the strong opinion expressed by the Norfolk farmer before alluded to. That such loss from sowing too little (and, still, more than the quantity some recommend) might occur, is proved by the following experiments; in which it will be

seen, that each increase of the quantity of seed per acre was well repaid in the crop of wheat; also, that the difference in each case is so regularly progressive, as to show no symptom of his having arrived, in that case, at the best quantity.

*Experiments, as to the thickness of Seed, by Mr. Blyth, Sussex Farm, Burnham.*

1842.	Seed per Acre.	Sheaves.	Weight.		Corn.		Excess	Excess in	
			st.	lbs.	st.	lbs.	in lbs.	Pecks.	Pints.
1.	7 $\frac{1}{4}$ pecks	12	9	9	4	4	—	—	—
2.	8 „	12	10	0	4	8	4	6	10 per acre.
3.	9 „	13	10	6	4	9	5	8	5
4.	10 „	13	10	8	4	10	6	10	0
5.	11 $\frac{1}{4}$ „	14	10	12	5	0	10	16	6
6.	12 $\frac{1}{2}$ „	14	11	5	5	2	12	20	0

On deducting seed—

No.	2 exceeding No. 1	Pecks.	Pints.
	.	5	14 per acre.
3	„	6	9
4	„	7	4
5	„	12	6
6	„	14	12

Supposing it, however, to be proved, in any case, that more seed had been sown than was necessary to get the greatest quantity of eorn, it does not, necessarily, follow, that no return was obtained for the extra quantity of seed: for, it is well known, that full crops ripen the soonest,—that they generally produce the best sample of grain,—and that the land will not be so subject to weeds, as when the crop is thin.

In proof of the first of these positions, I may state, that a large farm in Yorkshire was for some years untenanted, although offered at 5s. per acre. It had acquired a bad name; one of the things said of it being, that oats would not ripen on it. At length a tenant was found, who at once corrected the evil, by sowing two bushels more oats per acre, than any former one had done. The farm is now said to be one of the most productive in that county.

As evidence of the second, I may state, that Mr. Blomfield of Warham, near Wells, Norfolk, has been in the habit of measuring the ears of wheat, for the last 40 years; yet, he says, he never found an ear, more than 4 inches long, which had in it grain of the best quality; and he is of opinion, that no one can produce such an ear of wheat. Mr. Blomfield's opinion on this point is the more remarkable, as he happens to leave his turnips wider in the 27-inch rows (two in a yard), than any other person I ever met with. But some of the advantages of wide rows for turnips, beans, peas, &c. are not found with wheat and barley; which get the air where the grain is, although the rows may be closer.

I have not, on the present occasion, either time or space for going fully into this matter. What I have stated is intended to put the inexperienced on their guard, and, by a plain statement of the question at issue, enable such to assist (by trying experiments on a small scale) in arriving at a

proper conclusion on this very important question. I observed one of Mr. Blyth's wheat-fields staked out in equal portions; and, on asking why, he informed me, that there a second series of experiments on this subject was in progress—the result of which the harvest of 1844 will prove.\*

*Dibbling.*—Mr. Aylmer dibbles all his wheat (about 10 pecks per acre). He so much approves of the plan, that he thinks he should dibble on almost any land, if he could get the work properly done.

Many others admit that dibbling is a means of fastening the soil, and, therefore, well calculated for wheat; the only objection I heard to it being, that, in very extraordinary cases of tenacious clay-land, it may make the soil hold water, so as to rot the seed; but this is the exception, and it rather confirms the opinion, that it is well suited to such soils as are of an opposite nature—that is, too light for wheat.

*Slugs on Wheat.*—The experiments tried by Mr. Milnes, of Hilgay, for the purpose of destroying slugs, are eminently worthy of public attention.

He states, that he took several of them home on a cabbage-leaf, and first tried one with lime. This, for a time, made it seem very uncomfortable; but, at length, it emitted a slimy matter, and by that means worked its way over, and got clear away from, the lime. This he tried again, and the result was precisely similar.

He then took a very small quantity of salt, and sprinkled it on the same slug, when it immediately became swollen, burst, and died.

Thinking this one might possibly have been in some degree affected by the previous liming, Mr. Milnes tried a fresh one with salt, but the effect was the same as before.

Since that time Mr. Milnes has been in the habit of sowing on his wheat, where he happened to find slugs, 1 cwt. of salt per acre; which has invariably destroyed the slugs, without any injury to the wheat. One experiment, under different circumstances, will be sufficient to state here. Discovering slugs in a field, which he was sowing with wheat, he at once stopped the different operations, and sent for the salt. The land was in four different states:—

1. Part was set, and harrowed in.
2. Part set, and not harrowed in.
3. Part was ploughed, and not set.
4. Part was not ploughed, but remained as bean-stubble.

The salt was sowed at the rate of 1 cwt. per acre, as usual, and each

\* Trial referred to, of thick and thin sowing with Spalding Wheat. Sown by drill at 7 inches, November 17, 1843; manured with 4 cwt. of rape-cake, after carrots.

Seed per Acre.		Produce.				deduct seed	Pks.	Net Produce.			
No.	Pks.	Cmbs	Bu	Pks.	Pts.			Cmbs.	Bu.	Pks.	Pts.
1	7	10	0	3	12	7	9	0	3	12	
2	8	10	1	2	4	8	9	3	2	4	
3	9	10	2	3	4	9	10	0	2	4	
4	11	10	3	3	0	11	10	1	0	0	
5	12	10	3	0	0	12	10	0	0	0	

*Soil.*—Sandy, Loam with marl.

*Subsoil.*—Marl.

of the other operations suspended about two days; at the end of which time, the slugs had disappeared, totally and entirely.

*Scotch Carts v. Waggons.*

In some districts I found that "Scotch" carts had been introduced. Their advocates, near Acle, say of them:—

1st, They cost less;

2ndly, They do less injury to the land and roads;

3rdly, With them each horse does his own work;

4thly, When loading them in harvest, the "pitcher's" work is more easy, the carts being lower; by which means he sends the corn home faster than the man can "unpitch" it.

This last was not very clear to me, as a proof in favour of light carts. The low cart is all very well for the "pitcher," but not for the "unpitcher," even supposing the loads did not come more rapidly. If they had any means of raising the cart by the side of the rick to the level at which the waggon would have been, the advantage to the pitcher would be so much clear gain to him; and, if they raised it still more, so as to shorten his unpitching, as much as they had the pitching, they would then be more able to keep pace with each other.

I could not find that anything of this sort had been done. I therefore think, that, except with very low stacks, or with part of the stacks, the above is not at present a fair criterion of their value.

Perhaps they may find some means of raising these light loads, so as, at some future day, to put the carts in a better position for comparison.

Mr. Howard, of Halvergate, had been urged by some of his labourers (paid, by the harvest, or, the same amount of money, whether the harvest was long or short) to supply them with Scotch carts instead of waggons, because they could not get on so fast as those on another farm within sight of them. On his declining to find them just then, they requested to be allowed such carts as he had. This was the conclusion of his harvesting with waggons. Such is very strong evidence in favour of carts. The advocates for waggons state, that, by taking low loads, they can be pitched nearly as fast as unpitched, notwithstanding the advantages the unpitcher has with waggons. All speak of the advantages of small loads; the unpitching being then done with the greatest possible speed, as the exertion does not last long.

*Agricultural Labourers.*

One of the most important changes is, their making the improvement of the condition of the poor a regular system, by forming societies for the purpose, as well as by individual exertions.

To those, whose labour is their only wealth, we surely owe two duties; 1st. that of doing all we can, in our station, to find them useful employment, at such wages as will enable them to provide against a time of sickness, or infirmity, to them, or their families; that we may thus exercise and strengthen their good feelings; and by such means teach them to become better subjects, and better men. In so doing, each of their benefactors may hope for that blessing which is promised to him who "careth for the poor."



2nd. To reward such, as by their good conduct particularly merit it, with a certain sum of money, which, though small, is, to those who live by the "sweat of their brow," of considerable importance in itself; but, in many cases, infinitely more so, because of its being the public stamp of real merit, although found in a humble station.

No one capable of duly appreciating the great importance to the general community, of having good and right-minded agricultural labourers as the operative improvers of the soil, and the mainstay of the State, will consider it out of place, in a report of the agriculture of Norfolk, to mention any means there adopted for improving their general condition, by rewarding the most meritorious of the class.

In the year 1831, a society for this especial purpose was established in the hundred of Launditch; it took the name of "The Launditch Society, for the purpose of encouraging and rewarding good conduct in Agricultural Labourers and Servants;" and, as several others have since been formed, in other parts of that county and elsewhere, with marked advantage to the labourers and their employers, in the increased proportion of good work and good feeling, I think it right to state here, who was the originator of these societies, as well as what the principles were on which he, and others, founded the first of them.

From inquiries made in different parts of the county, I find the honour of their origin is undoubtedly due to Mr. Pearce, then of Weasenham Hall, Norfolk; a nephew of Mr. Kent, who wrote the Agricultural Report of the county, in 1796; Mr. Pearce being the author of the Report of Berks, also dated 1796.

The first society was confined to the extent of the hundred, in order that each candidate might be personally known, in most cases, and therefore his character more likely to be duly appreciated.

This part of the plan was strongly recommended by Mr. Pearce; and other societies seem, generally, to have adopted it.

---

In conclusion, I beg to state my firm opinion, that some of the Norfolk farmers at this moment possess as much knowledge of their business, as would be requisite (with capital, and the security alluded to in my article on Tenure),—provided, also, that this knowledge were general, and full scope given for its exercise,—to make, not only their own county, but any other I have yet seen, produce at least half as much more, in corn and stock, as they produce at present. I know not whether, in what I have said, I shall be able to impart any of that knowledge to my readers, or whether my attempts at description will be generally understood, but I do hope they will see, that my wish has been to be candid and useful.

11, *Great George Street, Westminster.*

*(This Report has been unavoidably abridged for insertion in the Journal.)*

---

XVI.—*On White Mustard.*—By GEORGE JESTY.

I BEG to offer my second report on the growth of white mustard for feed or for manure, in doing which I do not mean to exaggerate or misguide any person on the subject, but give a fair and impartial opinion that there is no plant more palatable for sheep, and of so quick growth. When ploughed in, from the quantity of vegetable matter decomposed in the soil, it cannot fail to afford food to almost every plant.

The land in which I ploughed it in last autumn was part of a field having failed twice for turnips; the other part was boned and ashed, and produced a good crop of turnips, which were fed off and folded by sheep in the usual way. The mustard land had no bone or turnip, or any other manure, but wholly manured by the mustard being ploughed in. Just before the wheat was fit to cut my neighbours inspected the whole field, and were of opinion, as well as myself, that the mustard part was quite equal to the other both in straw and in corn.

This last summer I sowed at different times a considerable breadth—first, the latter end of May, which came up cheerfully, but being on a high, dry soil, the weather took the same effect on it as it did on the turnips in general; however, a third part of the plants remained, which made very strong growth, and I fed it off by sheep. On the 6th of July I again sowed, after tares had been fed off; there was still that obstruction, by the unfavourable weather, for the growth of vegetables. Notwithstanding I had in that case a very good crop, which I also fed off with my sheep: they did remarkably well on the feed. I likewise had a thin piece of rape, in which I sowed 7 lbs. of mustard per acre the middle of August, which made very rapid growth, and filled up an excellent piece of feed, as high as the hurdles, which was fed off about Michaelmas, and since sown to wheat—in all cases I find it perfectly wholesome for sheep. In this neighbourhood there has been one instance where a good crop of oats was cut and carried the latter end of July, and sown to mustard immediately, which produced a very luxuriant crop, and fed off by sheep in October. I have had many inquiries on the subject of sowing white mustard for feed since my publication, from almost every county in England. The result has proved very satisfactory, in confirmation of which I beg to offer to your notice a communication I have just received from Mr. Hale, of Horndean, Hants: (by the writer's authority you may publish his letter,) which is very similar to many others I have been favoured with, too numerous to submit to your notice.

As there have been doubts expressed of eradicating the mustard from strong soils, I beg to say the white seed will not remain in

the land after being once ploughed up. The black is dangerous to introduce, as it has been known to remain in the soil for ages.

I do not mean to assert that any person has a right to expect a crop of mustard on thin, poor, worn-out land without manure; he may as well go for a day's shooting *without powder!*

*Druce Farm, Dorchester, Dorset,  
November 27th, 1844.*

---

DEAR SIR,—From your report on the growth of white mustard for feed, I was induced to try it. My first experiment was on one acre of very light, thin surface-soil, subsoil white chalk; this land had been previously occupied by a tenant who quitted it at Michaelmas, 1843, having taken wheat and oats consecutively as his two last crops. I made a clean fallow with thrice ploughing, &c., and *without* manure—sowed *broadcast* 16 lb. of mustard on the 22nd of July last; and on September 2nd—six weeks from the day of sowing (*scarcely a drop of rain during the whole period*)—folded it off with about 300 ewes. On commencing the first fold the ewes appeared dissatisfied, so much so that my shepherd said it would be useless to sow any more, as the sheep *evidently* disliked it; however, on the following morning *every stalk* was eaten *bare* to the ground, and ever after it was consumed as quickly and eagerly as *any other* green crop. Being so well satisfied with this experiment, I was induced to try it again in *comparison* with rape, to be fed off by sheep, as preparation for wheat. The land sown was a very thin soil, scarcely three inches, subsoil hard white chalk; the field was harvested in 1843, with oats after ley, winter tares following the oats—tares fed off by sheep in June and July, 1844; then ploughed and dressed with a light coat of farm-yard manure, and sown with rape, except about three acres, which I again sowed *broadcast* with mustard on the same day as the rape was sown alongside, both having had exactly the same dressing and previous cultivation for years back, and no difference in the quality of the soil. The mustard was folded with sheep exactly one month from my sowing, and ought to have been begun a week earlier, as one-half of the quantity sown was too old before the sheep could possibly eat it. The produce per acre was considerably more than the rape, giving far more nutritious food, without the dangerous and injurious properties belonging to the latter, and was full three weeks earlier in its growth. In the spring I shall sow mustard for early feed, both for cattle and sheep—most probably in my late wheat stubbles, intended for turnips.

I beg to remain,  
Your obedient servant,  
EDWARD HALE.

*Humbledon Manor Farm, Horndean, Hants,  
November 20th, 1844.*

---

XVII.—*On the Growth of White Mustard as a Green Crop for Sheep.* By JOHN GRAY, Agent of F. D. DICKINSON, M.P.

*To Ph. Pusey, Esq.*

DEAR SIR,—At the request of Mr. Graburn, I have much pleasure in sending you an account of our mustard crop, and also a specimen of the plant in the state that the sheep are now feeding it. The land on which it is growing is a thin stone-brash, and very poor. It had been manured, for turnips and rape, at the rate of 30 loads an acre, with compost, consisting of two-thirds lime and one-third road-earth: and, on the 10th of July, the turnip and rape-seed was drilled in with 80 bushels of ashes an acre. It came up slowly; and, with very few exceptions, was taken off by the fly. On the 28th of August I sowed 12 lbs. of *white* mustard-seed an acre, harrowing in the same: it was slow in coming up, from the dryness of the land; indeed, at one time I despaired of a crop, but when the rain fell it grew prodigiously; and on the 11th day of October I commenced feeding it. On an average it was then 2 feet high, and very thick in the ground; you will judge, from the specimen sent, of its present height—above 30 inches. I consider it a valuable artificial in sheep husbandry, and particularly so when turnips or rape fail; and, from its rapid growth, two, or even three, crops may be taken and fed off in the season. From its great succulency, some care is required in feeding it off. Our sheep are doing well upon it; but I find they make better work, having an outlet every day on their walk, than when they were wholly confined upon it. Four hundred consume about a quarter of an acre a-day, or thereabouts. One of Mr. Dickinson's tenants grew a most excellent picce of mustard last autumn, on some very heavy clay land, and without manure: his sheep being badly managed when feeding it off, he ploughed in a considerable quantity for his wheat, of which he had a splendid crop, and certainly the best he grew last season. I mention this circumstance, believing it may be grown with success on either heavy or light soils. I was led to suppose it might be greatly affected by frosts, but we have experienced sufficient to destroy the potato-haulm and the dahlias, yet it has not in the slightest degree affected the mustard; I therefore conclude it must be severe to destroy it. The seed cost 14s. 6d. per bushel, and weighed about 50 lbs. per bushel.

I remain, my dear Sir,

Yours very truly,

JOHN GRAY.

*Kingweston, Somersetshire,*

*Nov. 23, 1844.*

---

XVIII.—*Report on the Exhibition of Implements at the Southampton Meeting, in 1844.* By JOSIAH PARKES, Consulting Engineer to the Society.

IN submitting to the Council the following Report on the implements exhibited at Southampton, the writer feels it necessary to premise that the office assigned to him of Mechanical Referee to the Judges, in the event of their disagreeing in opinion on the merits of any implement, precluded his being present with them and the exhibitors during the inspection and trials of the implements; excepting in cases where his attendance was specially requested by the judges. This circumstance has naturally restricted his personal knowledge of the action and merit of the greater proportion of the machinery investigated by the judges; and, as their labours were carried on in divisions, it is certain that no single individual, officiating for the Society in the show-yard, or on the trial-grounds, can presume on possessing the amount of knowledge requisite for illustrating that vast collection of implements with the detail and exactness which may be desired by the Society, the exhibitors, and the judges themselves. Impressed with a sentiment of the extreme difficulty of the task of reporting on this show—also assigned to him—and of the doubt he had of satisfactorily fulfilling it, the author addressed a letter to the Council for his guidance and instruction. He was obligingly favoured with the following resolution:—

“It is the opinion of the Council, after considering the letter addressed to them by Mr. Parkes, that Mr. Parkes should draw up the Report from the reports made by the Judges of Implements, for which they are solely responsible; but that upon all trials which he has himself viewed it will be competent for him to make any remarks he may think necessary; as well as upon the mechanical appearance of the show.”

Relying, therefore, on the indulgence of the members of the Society, and of the exhibitors, for the imperfections and omissions of notice which will be but too evident on this occasion, as compared with former Reports, the author proceeds, however inadequately, to acquit himself of the duty entrusted to him.

As regards the show, its magnitude will be best appreciated by stating that the number of articles submitted to inspection and trial exceeded that at the Derby meeting, which was, it will be remembered, by far the largest of its predecessors. The number of exhibitors was not quite so great as in 1843, but in point of mechanical excellence, and in the number of new or improved inventions, it is the opinion of the writer that the Southampton is entitled to the credit of being the most brilliant meeting yet held under the auspices of the Society. The planning of the implement-yard gave great satisfaction, by reason of the space

allotted to the exhibitors and the public. The arrangement of the stewards for conducting the trials of chaff-cutters, threshing-machines, steam-engines, &c., in a separate contiguous yard, facilitated the operations of the judges, and materially diminished the injury not unfrequently suffered by the machines on removing them, as heretofore, to distant spots for trial. The field trials were also managed with a success so superior to that attending all former attempts to give effect to them, as to reflect the highest credit on the stewards for recommending the new system adopted on this occasion. It has solved the problem of the possibility of obtaining results to be relied upon at these great assemblages of competitors. It was proved that the selected fields may be maintained free from all intrusion by the public, or by any persons not authorized to be present during the private trials of the judges. Nothing, indeed, could be more agreeable and satisfactory to all parties concerned than the conduct of this department at the farms of Mr. Caleb Gater, of Swathling, and of Mr. W. C. Spooner, of Eling, who respectively rendered every assistance in their power. Great as has been this step in advancing one of the important objects of the Society—viz. the obtaining sound and incontrovertible knowledge of the particular and relative merits of agricultural implements—there is still reason to believe that this object may be attained to a greater extent, and with still greater certainty and satisfaction in some cases. The judges have occasionally found it necessary to refrain from deciding on the merits of certain implements for want of sufficient time, or of a fitting season of the year, to come to a fair judgment on them. The Council has, under these circumstances, appointed different members to make the necessary trials, and to report thereon; yet several remain undecided, and in abeyance: so that the prizes offered by the Society for certain implements have not been adjudged. Some plan may possibly be devised by the Council for realizing to the competitors, and to the Society, the intended effect of the Society's premiums, by assuring more prompt yet deliberate decisions in these necessarily deferred cases of judgment. The writer imagines that all will unite in opinion that when exhibitors appear at the invitation of the Society to contend for prizes, an award should surely follow, unless for the reason of insufficient merit. One other remark on the subject may be permitted. In consequence of allowing two days for judging implements in the field—a space of time which cannot be curtailed consistently with the interests of the Society and of the exhibitors—it is thought that one more day, in addition to the time allowed for judging at Southampton, and previous to the admission of the public to the show-yard, is desirable. This extension would enable the judges to deliberate with care on their awards, after the trials; and it would afford time for them to ex-

plain, personally, to the reporter appointed for the occasion, the reasons of their judgments; with the advantage of immediate and quiet reference to the various implements put in competition. This cannot be effected after the admission of the public, as has been experienced by your present reporter. From conversation he has had with several of the exhibitors, the writer thinks that no objections would be made on the part of that body to a proposition of this nature.

The following is the list of Prizes offered by the Society, with the awards of the Judges subjoined:—

For the Plough best adapted to heavy land . . . . .	{	Ten Sovereigns and Silver Medal.
For the Plough best adapted to light land . . . . .	{	Ten Sovereigns and Silver Medal.
For the Drill which shall possess the best method of distributing Compost or other manures in a moist or dry state, quantity being especially considered . . . . .	}	Twenty Sovereigns and Silver Medal.
N.B.—Other qualities being equal, the preference will be given to the Drill which may be best adapted to cover the manure with soil before seed is deposited.		
For the best Turnip Drill which shall deposit manure with the seed . . . . .	}	Ten Sovereigns and Silver Medal.
For the best Scarifier . . . . .	{	Ten Sovereigns and Silver Medal.
For the best Chaff Cutter . . . . .	{	Ten Sovereigns and Silver Medal.
For the best Machine for making Draining Tiles or Pipes for agricultural purposes. Specimens of the Tiles or Pipes to be shown in the Yard: the price at which they have been sold to be taken into consideration, and proof of the working of the Machine to be given to the satisfaction of the Judges . . . . .	}	Twenty Sovereigns and Silver Medal.
For the best Set of Harrows . . . . .		Five Sovereigns.
For the best Agricultural Carriage, with or without Springs, for the general purposes of road and field . . . . .	}	Fifteen Sovereigns and Silver Medal.
For the best Drill Presser . . . . .	{	Ten Sovereigns and Silver Medal.
For the best Churn . . . . .		Five Sovereigns.

The Society wishes to call the attention of Machine-Makers to the improvement of Apparatus for steaming Roots; of small or portable Corn-Mills; of broad Shares for paring Stubbles; of Horse-Hoes; of agricultural Harness and Gearing generally: for improvements in which, or in any other miscellaneous articles, Prizes or Medals may be awarded by the Judges if they think fit.

All Implements admitted into the Yard, will be liable to be proved

by actual trial on the recommendation of the Judges: and such Implements as cannot conveniently be tried at the time of the Show, may be tried at such time and place as the Judges may think fit.

The Judges will especially consider the selling price of the Implements exhibited, which must be stated in the Certificates; and they are instructed to withhold Prizes where there shall not appear to be sufficient merit.

## AWARD OF PREMIUMS.

AWARD OF PREMIUMS.	Prize.	Reference to Catalogue.		
		Stand.	Article.	Price.
1. PLOUGHS.				
To Messrs. J. R. and A. Ransome, of Ipswich, for their Plough for heavy land; their own invention . . . . .	£10 and Silver Medal.	} 84	6	} 3 3 0 to
To Messrs. J. R. and A. Ransome, of Ipswich, for their Plough for light land; their own invention . . . . .	£10 and Silver Medal.			
To Messrs. J. R. and A. Ransome, of Ipswich, for their Plough for laying furrows all in one direction; invented by Henry Lowcock, of Marlton, Devon . . . . .	£5	84	16	6 6 0
To John Bruce, of Tiddington, near Stratford-on-Avon, Warwickshire, for his Skim Plough; his own invention . . . . .	£5	20	3	{ 5 5 0 to 7 0 0
2. SUBSOIL PULVERIZERS.				
To John Read, of 35, Regent Circus, Piccadilly, London, for his Subsoil Pulverizer; his own invention . . . . .	£10	93	3	5 5 0
3. CLOD-CRUSHERS.				
To William Crosskill, of Beverley, Yorkshire, for his Clod-Crusher and Roller; his own invention . . . . .	£20	80	4	{ 11 0 0 to 22 0 0
4. SCARIFIERS.				
To the Earl of Ducie, of Tortworth Court, near Wootton-under-Edge, for his Scarifier, or Uley Cultivator; invented by John Morton, of Whitfield Example Farm . . . . .	£10 and Silver Medal.	} 61	13	{ 12 0 0 to 20 0 0
5. HARROWS.				
To Messrs. Sanders, Williams, and Taylor, of Bedford, for their diagonal iron Harrows; invented by Samuel Taylor, of Bedford . . . . .	£5	70	3	4 15 0
To Messrs. Sanders, Williams, and Taylor, of Bedford, for their Horse Drag; invented by Samuel Taylor, of Bedford . . . . .	£5	70	6	7 7 0



AWARD OF PREMIUMS.	Prize.	Reference to Catalogue.		
		Stand.	Article.	Price.
6. DRILL-PRESSERS.				
To Richard Hornsby, of Spittlegate, Grantham, } for his two-row Drill-Presser, depositing corn and manure; his own invention . . . . . }	£10 and Silver Medal. }	48	9	£. s. d. 14 10 0
7. DRILLS.				
To Richard Garrett, of Saxmundham, Suffolk, } for his Drill for general purposes; his own invention . . . . . }	£20 and Silver Medal. }	65	2	36 15 0
To James Smyth, of Peasenhall, near Yoxford, } Suffolk, for his Manure and Seed Drill, for ridge or broad-work; his own inventiou . . }	£10 and Silver Medal. }	74	5	23 0 0
8. HORSE HOES.				
To David Harkes, of Mere, near Knutsford, } Cheshire, for his parallel expanding Horse Hoe; his own invention . . . . . }	£5	10	4	3 10 0
To Richard Garrett, of Saxmundham, Suffolk, } for his Horse Hoe for general purposes; his own invention . . . . . }	Silver Medal.	65	10	18 0 0
9. AGRICULTURAL CARRIAGES				
To Daniel Coombes, of Skipton, near Burford, } Oxon, for his two Carts convertible into a Wagon; his own invention . . . . . }	£15 and Silver Medal. }	..	1	35 0 0
To Richard Stratton, of Bristol, for his low- tipping Manure Cart, with Liquid Manure Cask to fit; his own invention . . . . . }	£5	79	14	{ 17 17 0 to 22 17 0
To Richard Stratton, of Bristol, for his improved Harvest Cart; invented by J. Hannam, of Burcot, Oxon . . . . . }	Silver Medal.	79	7	15 15 0
To Richard Stratton, of Bristol, for his low Spring-Cart, with cranked axle; his own in- vention . . . . . }	Silver Medal.	79	11	20 0 0
To the Earl of Ducie, of Tortworth Court, } near Wootton-under-Edge, for his Richmond Cart; invented by Richard Clyburn, of Uley, near Dursley . . . . . }	Silver Medal.	61	8	19 0 0
10. CHAFF CUTTERS.				
To the Earl of Ducie, of Tortworth Court, near Wootton-under-Edge, for his Chaff Cutter with two spiral Knives; invented by himself, R. Clyburn, and E. Budding . . . . . }	£10 and Silver Medal. }	61	15	{ 8 10 0 to 20 0 0
11. TURNIP CUTTERS.				
To James Gardiner, of Banbury, Oxon, for his Turnip Cutter; his own invention . . . . . }	£5	40	1	5 5 0

AWARD OF PREMIUMS.	Prize.	Reference to Catalogue.		
		Stand.	Article.	Price.
12. CAKE CRUSHERS.				
To Richard Hornsby, of Spittlegate, Grantham, } for his Cake Crusher; his own invention . }	£5	48	12	£. s. d. 8 0 0
13. BARLEY HUMMELLER.				
To Joshua Cooch, of Harleston, near Northamp- } ton, for his Barley Hummeller, combined } with a Winnowing Machine and Elevator; } his own invention . . . . . }	Silver Medal.	54	3	6 6 0
14. HAND CORN MILLS.				
To Alexander Dean, of Birmingham, for his } French burr-stone Hand-Mill; his own in- } vention . . . . . }	Silver Medal.	64	24	10 5 0
15. CHURNS.				
To David Harkes, of Mere, near Knutsford, } Cheshire, for his double-action Churn; in- } vented by George Brown, of Capesthorne, } Cheshire . . . . . }	£5	10	5	3 0 0
16. CHEESE-PRESSES.				
To Richard Stratton, of Bristol, for his Cheese- } Press; invented by W. J. Gingell, of Bristol }	Silver Medal.	79	58	3 3 0
17. STEAM-ENGINES.				
To William Cambridge, of Market Lavington, } Wilts, for his four-wheel travelling Steam- } Engine; his own invention . . . . . }	£5	26	1	200 0 0
18. HORSE ENGINES AND MACHINERY.				
To Messrs. J. R. and A. Ransome, of Ipswich, } for their set of Horse Works for driving several } Mills or Machines combined, or separately; } their own invention . . . . . }	£30	84	25	{ 25 0 0 to 50 0 0
19. FIRE ENGINES.				
To John Read, of 35, Regent Circus, Picca- } dilly, London, for his Fire-Engine; his own } invention . . . . . }	£5	93	4	36 0 0
20. WATER-LIFTING ENGINES.				
To Messrs. Tasker and Fowle, of Andover, } Hants, for their Machine for raising Water; } their own invention . . . . . }	Silver Medal.	57	25	15 0 0
21. DRAIN-TILE MACHINES.				
To Messrs. J. R. and A. Ransome, of Ipswich, } for their Hand or Horse Drain-Tile and Pipe } Machine; invented by F. W. Ethredge, of } 11, Furnival's Inn, London . . . . . }	£20 and Silver Medal.	{ 84	32	{ 25 0 0 to 50 0 0

AWARD OF PREMIUMS.	Prize.	Reference to Catalogue.		
		Stand.	Article.	Price.
£. s. d.				
<b>22. WEIGHING MACHINES.</b>				
To H. G. James, of 44, Fish Street Hill, London, for his Weighing Machine; invented by Monsieur George, of Paris . . . . .	£5	77	4	{ 5 0 0 to 22 0 0
<b>23. MISCELLANEOUS.</b>				
To Richard Stratton, of Bristol, for his Hand Bone-breaking Machine; invented by Robert Fry . . . . .	£2	79	46	4 4 0
To Edward Hill, of Brierly-hill Iron-works, near Dudley, for his wrought-iron Cow Crib; his own invention . . . . .	£2	22	14	4 4 0
To Edward Hill, of Brierly-hill Iron-works, near Dudley, for his running Sheep Fences; his own invention . . . . .	Silver Medal.	22	20	{ 0 1 9 to 0 2 2 per yard.
To James Pearce, Andover, Hants, for his Back-band and Tugs; his own invention . . . . .	Silver Medal.	89	3	1 10 0
To Richard Garrett, of Saxmundham, Suffolk, for his wrought-iron Stack Stand; invented by J. Springall, of Ipswich . . . . .	Silver Medal.	65	32	10 10 0
To the Earl of Ducie, of Tortworth Court, near Wootton-under-Edge, for his Screw Spanners or Wrenches; invented by Richard Clyburn, of Uley, near Dursley . . . . .	Silver Medal.	61	11	{ 0 7 6 to 0 18 6 each.
To Messrs. Joseph Hall and Co., of Cambridge, for their Horse Trefoil and Clover-seed Drawing Machine; invented by — Constable, of Cambridge . . . . .	£5	67	3	40 0 0
To Samuel John Knight, of Maidstone, Kent, for his Model of a Hop and Malt-Kiln; his own invention . . . . .	£5	44	1	—

NOTE.—The prices affixed comprehend the range of the cost according to the various sizes, fittings, materials, &c. of the implement.

*Ploughs.*—The judges having selected from the immense number of ploughs exhibited such of them as they deemed particularly worthy of trial, these were apportioned to the light or stiff land farms, according to the wishes of the exhibitors. At the time of trial each plough had a separate land assigned to it; and each ploughman was desired to execute the best work he could, without regard to quantity, the excellence of the performance being the object principally sought. Some of these ploughs were entered as wheel-ploughs only; some were represented to work with two wheels, or with one wheel, or as swiggs; others were constructed purely on the swing principle. Under these circum-

stances, the judges thought fit first to order the two-wheel ploughs into action, then those with one wheel, and then the swing, or the ploughs without a wheel. By this arrangement not only was the quality of the work done by each implement separately displayed, but a fair opportunity offered itself for observing and comparing the quality of the work as executed in the same soil, and under the same circumstances, by the three classes of the implement. The skill of the individual constructor was also manifested; and, on this occasion, the remarkable result came out that one particular plough excelled all the others, whether working with two wheels, with one wheel, or without a wheel. In each case the work done by this plough was unquestionably superior to that effected by any other competing with it; and it was equally unquestionable that the order of excellence, in respect of work, was,—first, that executed by this plough when fitted with two wheels; secondly, with one wheel; thirdly, when acting without a wheel, or as a swing. This plough was one of three in the field from the manufactory of Messrs. Ransome, marked Y. L.; and to them the judges awarded the Society's prize of ten pounds and the silver medal.

These remarks have reference to the trials made on the light land at Mr. Gater's farm; and precisely similar results were recognised by the judges on the trials which took place on the very hard stiff soil at Mr. Spooner's farm. Here again the superiority of the same plough developed itself; but, to meet the condition of the soil, Messrs. Ransome had fitted it with a longer, and differently curved, mould-board. To them the judges also awarded the Society's prize "for the plough best adapted to heavy land," as well as that for "light land."

Some very good work was done on the light soil by ploughs manufactured by Mr. John Howard, of Bedford, and by Messrs. Sanders, Williams, and Taylor, of Bedford. On the stiff soil, the judges commended the performance of a plough by Messrs. J. and E. Plenty, of Newbury (an old Hampshire implement), and as being apparently of light draught; also a plough by Mr. Howard, of Bedford; both working with two wheels. The performance of the swing-ploughs was very indifferent on both sorts of soil, excepting that of Messrs. Ransome's implement on the lighter soil.

In recording these trials, the writer, who had the advantage of attending the two judges of this department, and of communicating with them during all the trials, only repeats their sentiments in marking the difference of the work under the three varied applications of Messrs. Ransome's plough. When fitted with two wheels, its performance was like that of a planing-machine; the furrow slices were cut vertically from the land, the floors or bottoms were left perfectly flat and clean, and the slices were depo-

sited at an angle of about 45 degrees, with such truth that they could be turned back to their original horizontal bed without gaining or losing ground. According to the generally-received principles of perfect ploughing (whether they be correct, and equally suitable to all soils and modes of culture, or not) it is imagined that practice has in this instance closely approached to their fulfilment.

When fitted with one wheel, though the work of the plough was excellent, yet there was an evident declining from that extreme regularity and finish belonging to the first performance.

When acting without a wheel, or as a swing, an effect was plainly discernible, and which is directly traceable to the influence exercised over the motion of the plough by the motion of the draught animals. The floor of the furrows, though cut nearly as flat in its transverse section as in the two former cases, no longer presented so continuously-even a surface as if fashioned by a tool travelling along and maintaining an unvarying plane; it was wavy, exhibiting short, burst, or broken surfaces, and answering to the impulses of the animals. Nor was this owing to want of skill in the ploughman, as compared with the skill of others who brought their best swing-ploughs and their best ploughmen to compete for the prize, for the furrow bottoms of the latter were still more jagged and irregular. Had the light soil operated upon been in a condition fit for autumnal ploughing, there can be but little doubt that all the swing-ploughs would have acted better, and that less difference would probably have been perceptible in the quality of the work; yet the writer esteems it to have been advantageous to the progress of arable mechanism that these trials occurred at a period when the merits or defects of the ploughs were prominently brought out by the excessively baked state of the soil. On the hard land especially (at Mr. Spooner's) "proof of bottom" was obtained. Several of the ploughs would not enter the ground, nor work to the depth required; others were continually thrown up on the surface; and some were quickly crippled in one way or other. The test was certainly severe, but the merit of any plough was proportionably great which could perform good work under such circumstances.

The inquiries addressed to the judges and to the writer have been numerous, and very natural, as to how it happened that the same plough proved to be equally fit for light and heavy land? The explanation has already been partly given by the statement of the fact that Messrs. Ransome changed such parts of their plough as they deemed necessary to suit a change of soil; just as a skilful workman adapts his tool to the different nature of the materials under hand: and abundant proof was afforded to, and acknowledged by the judges, that one given form of mould-board

is utterly inadequate to suit all soils. Much also of the success of this plough is due to the principles of its construction, as already explained in the Report of the Derby Meeting.

*Turn-wrest Plough.*—Under this generic name for ploughs which lay their furrows in one direction, must be classed a novel description of the implement, invented by Mr. H. Lowcock, of Marldon, Devon, and manufactured by Messrs. Ransome. Its intent is accomplished without having to turn the plough round at the end of a bout, or to change, manually, any of its acting parts. It consists, in fact, of two ploughs set back to back lengthways, and forming one body, having a double flap or wing, hinged between the vertical parts of the two mould-boards, and completing their necessary curvature. The stilts or handles are hinged on the centre of the plough, and serve to guide it in both directions by simply turning them over when the plough reaches the end of its course. The horses, whilst turning, leave the plough at rest, but pull the draught-chain to the opposite end of the beam along a rod which connects the two extremities; and, so soon as motion recommences, the flap or wing turns on its hinge from the effect of the resistance it encounters from the new furrow slice, and the new slice is deposited against the preceding one. Thus, a self-acting turn-wrest is produced, and in a very simple and efficient manner. The novelty of this arrangement consists, chiefly, in the hinged self-acting flap; but the construction of the sole is also entitled to much praise, as, though the plough is double, the usual extent only of frictional surface is in action. The plough carries one wheel at each end.

The judges awarded a premium of 5*l.* for this plough, which did its work very satisfactorily, and was considered to be the best turn-wrest yet invented.

*Stubble-paring, or Skim Plough.*—Several implements bearing this title underwent strict trial. The judges had no hesitation in determining to which of them a preference was due, as no one of them executed its work effectually, excepting that invented by Mr. John Bruce, of Tiddington, near Stratford-on-Avon, for which a premium of 5*l.* was adjudged.

Mr. Bruce appears to have thoroughly studied the requirements of an implement of this kind, and has certainly produced one which will be considered a great acquisition by the agriculturist. It was tried on a very short, dry, clover ley, cutting 3 inches deep and 26 inches in breadth. No portion was left uncut. It worked well with a pair of horses, and is capable of getting over 4 acres per day cleverly. It is so arranged as to be equally suitable to ridge and furrow as to flat land. It is readily thrown out of work at the end of a field, turns easily, and is furnished with a set of tines following the cutting shares, in order to scarify

or stir the parings, and prepare them for being well wrought upon by the harrows. These tines are raised out of the soil by pressing on independent handles and levers, and may be used or not as occasion requires. The implement is simple, and its price moderate.

*Subsoil-Pulverizers.*—Nearly all the varieties of this class which had appeared at previous meetings of the Society were again exhibited. The weight, unwieldiness, and cost of them, together with the difficulty experienced in their management, and the strength of team required to do the work—indifferently and irregularly as it has hitherto been accomplished—have set great obstacles to the adoption of a complete underworking and pulverization of the agricultural bed. It is acknowledged that the process of artificially pulverizing certain subsoils, and of admitting a free access of air and moisture to their interior parts, must be beneficial to plants, and must tend to ameliorate the texture and quality of the soil. Nevertheless, for the want of a simple, easily manageable, and moderately priced implement, this operation has been made rather the subject of private experiment than of extensive practice; it has languished in the hands of many of its advocates, and been abandoned, as too troublesome or too costly, by many firm believers in its utility. An implement was produced at the Derby Meeting, by Mr. John Read, of 35, Regent Circus, Piccadilly, London, which had not the chance of being there submitted to trial, but with the merits of which the writer shortly afterwards became fully acquainted. It reappeared at Southampton, and was put to the test by the judges, with several others, in the hard-baked soil at Mr. Spooner's farm. It is unnecessary to make particular mention of these latter, as no one of them was capable of executing even tolerable work in land so circumstanced. The pan, or old plough-floor, of this field had, evidently, never been invaded by agricultural tools; below 6 inches it was as solid as centuries of ploughing and trampling can be conceived to have made a tenacious loam, aided by a drought of several weeks' duration. Mr. Read's pulverizer was put into the furrow opened by a plough, and set to work at about 6 inches under it. The effect was "*perfectly beautiful*"—to use the judges' words. The old floor was split up into fragments like broken tiles; the soil was separated and pulverized, not heaved up in great masses and let fall again to its original berth, the common defect of the ponderous subsoil-ploughs: the depth was maintained invariably uniform, and a holder for the implement would be nearly unnecessary but for the circumstance of its coming out at the end of a furrow and of setting in again. The uniformity of depth and regularity of motion are owing to the construction of the implement, which is as simple as it is novel. A straight beam, furnished with the usual pair of handles, is carried on four wheels,

the leading pair being placed near the bridle, and the following pair near the after end of the beam. The stirrer or miner is let down through a mortice in the beam, immediately behind the after pair of wheels, and fixed to act at any required depth. By this arrangement the entire weight is carried on the wheels, which also preserve the action of the stirrer at all times parallel with the bottoms of the furrows on which they travel.

In consequence of the effective performance of this implement, and being of opinion that it required considerably less force of draught than any other with which they were acquainted, the judges awarded to Mr. Read a premium of 10*l*.

The writer may also mention that a mole-share has been applied to this implement, and used in Kent with excellent effect in making mole-drains, with a force of four horses; and he may add that, by reason of its manageableness and accurate working, the implement has been found by farmers in the same county to facilitate drainage in clay soils by sub-pulverization, in a remarkable manner, if used with due caution. They recommend that newly-drained *clays* be not broken up, in the first instance, to a depth beneath the furrow greater than six inches; that the share be set another season two or three inches lower, and so on, gradually deepening the pulverized mass, rather than disrupting the whole at once.

*Clod-crushers.*—Several clod-crushers and rollers—or implements to which that appellation was given by their makers—were put to work at Mr. Spooner's farm, on land well prepared for testing their respective properties and merits. The remarks made in the Report of the Derby Meeting relative to Mr. Crosskill's implement were fully borne out by the opinions of the judges who acted on this occasion, and who had the opportunity of giving these implements a quieter and more rigid trial. A premium of 20*l*. was adjudged to Mr. Crosskill, of Beverley, for his now almost universally known and approved machine. The improvements made in the construction of this crusher have been successively narrated and commended in previous reports; and testimonials to its useful effect in producing upon soils, not cloddy, a fine pulverulent surface, as well as its beneficial influence as a roller of young growing wheat, &c. &c., have been so recently collected and laid before the Society (Journal, vol. iv. p. 560) that it might be deemed unnecessary to add one word more on the subject. The judges, however, have particularly requested the writer to submit to the exhibitors the utter inutility of all attempts to compete successfully with Mr. Crosskill's implement, unless they can produce a machine which, like his, can be turned round about, when one of its extremities is fixed, without tearing up the soil, and half burying itself in a hole formed whilst turning. It will assuredly be wiser to prove such properties at home, than to bring



to the Society's meetings implements, either purporting to be what they are not, or such as have already been eclipsed by more excellent inventions. The most complete implement is not perfect, and there is ever ample room and verge enough for attaining distinction either by the discovery of some better or cheaper principle of construction, or by increasing the utility of that which is acknowledged to be good. At the present time Mr. Crosskill's crusher and roller is unquestionably superior to any other brought to the notice of the Society; it happily combines a sufficiency of weight with bruising action, and simplicity with durability. The inventor makes them of different lengths, to suit the circumstances of purchasers; but the farmer will do wisely, when his means permit, to procure the longest size, as it is the heaviest and most effective.

*Scarifiers.*—Of the various scarifiers contained in the show-yard, the choice of the judges lay, as at the Derby Meeting, between the Uley cultivator, exhibited by the Earl of Ducie, and Biddell's well-known implement, manufactured by Messrs. Ransome. After a short trial the judges awarded the Society's prize of 10*l.* and the silver medal to the Earl of Ducie; this award arising out of their opinion that the Uley implement required less power, and travelled farther without choking or fouling. They observe, however, that "the Biddell did its work in good style," and state their opinion that "implements of this description require a trial of longer duration to enable the judges to arrive at a mature knowledge of their respective merits." It will be in the recollection of the Council that the judges at Derby came to a similar conclusion as to insufficiency of time and circumstances, and, in consequence, no judgment was pronounced by them.

*Harrows.*—A set of diagonal iron harrows, exhibited and manufactured by Messrs. Sanders, Williams, and Taylor, of Bedford, obtained the Society's prize of 5*l.*, being considered by the judges to have pulverized the soil more effectually and neatly than any others submitted to their inspection.

A horse-drag, produced by the same makers, received an award of 5*l.*, it being found on trial against several others to collect the greatest quantity of stuff in the cleanest manner, and to possess the best delivery.

*Drill-Pressers.*—The Society's prize of 10*l.* and the silver medal was awarded to Mr. Richard Hornsby, of Grantham, for his two-row implement for depositing corn and manure. Several pressers by different makers were also tried, but no one of them approached Mr. Hornsby's in the faculty of delivering quantities of manure or compost—a faculty esteemed by these, as by former judges, to be of the highest importance to the complete effectiveness of all drills. The competing pressers did not attain the

deposition of what the judges prescribed as a sufficiency of manure ; whereas Mr. Hornsby's drill proved to be capable of depositing double the quantity of manure required by them, and in a much rougher state than that prepared for the occasion. It was also provided with an extra coulter to complete the manuring and sowing of the open furrows. This is an entirely new operation of the presser, as the sowing of the furrow had previously to be done by hand. The judges observe that "it was accomplished in good style, and gave a finish to the work corresponding with the rest of the field." The Society will be pleased to learn that the effect of the encouragement occasioned by their annual premiums for this extensively used implement has been so rapid ; for the origin of the drill-presser, more particularly in respect of its function as a manure-depositor, is but recent. The diameter of Mr. Hornsby's pressing-wheels is 3 feet  $9\frac{1}{2}$  inches (larger by  $1\frac{1}{2}$  inch than those of Mr. Caborn's excellent presser, rewarded at Derby), and the breadth of bearing, or sole, is  $1\frac{1}{2}$  inch.

*Drills.*—It appears from the notes of the trials supplied by the judges of this department, that thirteen drills of different descriptions, selected from the stands of eight exhibitors, were minutely tested by them. Of these, two are stated not to have been in working order ; and two broke on trial. Five would not pass the damp manure prepared for the Society, but four of these acted either well or fairly with coal-ashes. One did not pass manure fast enough ; and of another, being a combination of a drill with a manure-cart, produced by Mr. Hornsby, of Grantham, the judges observe, "not good, would not drill wet manure, and if it would, the judges do (not) think it desirable or profitable."

The result of these trials was the award of the Society's prize of 30*l.* and the silver medal to Mr. Richard Garrett, of Saxmundham, for his drill for general purposes ; and the prize of 10*l.* and the silver medal to Mr. James Smyth, of Peasenhall, for his two or three rowed manure and seed ridge or broad-work drill.

On the subject of the manure-depositing properties of Mr. Garrett's drill—properties which formed the principal object of the Society's largest prize—the only remarks made by the judges are :—"This drill worked fairly with coal-ashes, but would not drill the wet manure prepared for use by the Society." Also, that "it drilled manure as well as any, and in other respects was better." Mr. Smyth's drill is reported to have "worked well on ridge and flat, and to be a complete turnip-drill." Also, that "it drilled the manure as well as any, had a self-moving action roller for ridges superior to any, and covered the seed with roller behind better than others." A two-row turnip-drill by Mr. Hornsby is commended ; and a drill for general purposes by Mr. Hunter, of

Ulceby, is mentioned as having "a better invention for covering the manure than any other, and very simple," though it would "not drill wet manure fast enough.

It may be gathered from these remarks and decisions of the judges, that no one of the drills upon which their experiments were made, exactly responded to the terms of the first prize, according to their construction of them; but, as the effect of offered prizes cannot always be immediate, it may be hoped that our drill-mechanicians—and more particularly those who have turned their attention to the delivery and covering of large quantities of moist manures or composts—will realize it on the next occasion. The hint, also, may not be lost on them that their implements should be exhibited in perfect condition for work, as all are subject to the judges' call for trial.

In the Report of the Derby Meeting a succinct history was given of the rise and progress of manure-drilling in Lincolnshire, and so far as the writer's researches on this subject had then, or have since extended, it would appear that the mechanical deposition of manure originated in that county.\* Nor has the quantity of fold-yard or other manure capable of being uttered by drills appeared to have satisfied the intelligent and enterprising Lincolnshire agriculturists until very recently. The judges at the Derby meeting reported their opinion, that "Hunter's drill is capable of uttering any required quantity of such manure (fold-yard or stable-muck well chopped), and of passing lumps without obstruction, even of 5 inches diameter," &c. (*Journal*, vol. iv. p. 469). Since this statement was made the writer has sought to verify it, and to obtain some knowledge of the actual quantity and nature of the manures drilled in per acre.

Mr. William Heseltine, of Worlaby House, near Barton, Lincolnshire (one of our judges of ploughs, &c. at Southampton), states, Sept. 20th, 1844, "I have used Hunter's drill to a great extent this season for turnips, and find it answer remarkably well. The manure I used was from cattle tied up in a shed to fatten upon linseed-cake and turnips, having wheat-chaff to lie upon instead of straw. The dung was taken from them twice a day, mixed with twice the quantity of soil, and turned over twice or thrice in the spring; before drilling a quantity of dry ashes was added, which made a rich compost. I had also a heap of manure put into a hill last autumn. In the spring, soil and ashes were mixed with it in the same way as the other. Five large cart-

---

\* The writer is indebted to Mr. Richard Garrett, of Saxmundham, for some valuable information concerning the history of Suffolk drilling. At present, however, it is incomplete, more particularly as respecting the date of the introduction of manure-drilling into that or the neighbouring counties.

loads, containing 40 bushels each of these composts, were drilled per acre, and I could have got in twice as much, or any quantity, with Hunter's drill."

Mr. L. Uppleby, of Wootton House, near Barton-on-Humber, writes, October 4th, 1844: "If it be an advantage to be able to drill in a large quantity of compost, wet or dry, then Hunter's drill is by far the best yet out; and that it is an advantage few practical farmers will deny. I have drilled about 160 acres of turnips with Hunter's drill. The compost I used was the drainings and manure from our feeding beasts mixed, under cover, day by day, with dry soil; and about  $1\frac{1}{2}$  cwt. of guano per acre. The compost and guano mixed with ashes amounted to about 4 cubic yards per acre. The season was, as you know, most unfavourable, but yet the turnips are *very* good, although rather later than I should like to see them. For swedes I put in 5 cubic yards; and on 3 roods of land for a person near me (who always borrows my implements), I drilled in at the rate of 13 cubic yards per acre; thus showing that Hunter's drill is capable of depositing almost any quantity, and the delivery is so equal, the work may be done to the greatest nicety."

The manure and turnip drill referred to was exhibited at Southampton by Mr. Hunter, but as no mention is made of it in the judges' notes, it would appear that it was not tried. From several other parties expressing the highest approbation of this drill, the writer has learnt that great numbers of the common drills have been altered to the same plan, which was the invention of Mr. Tobias Cartwright, of Fordington, near Alford, Lincolnshire, in 1840; thus the acknowledgment of the value of a drill for depositing heavy tillages of manure or compost is become very extensive.

Mr. Graburn, now of Walton House, Clevedon, Somerset, has this year practised another method—remarkable for its simplicity and effectiveness—which he describes as follows:—"My drill has no manure-box; it consists simply of the seed and manure delivering machinery carried upon two wheels, and following a cart in which a man stands, whose business it is to shovel the manure on to the machinery of the drill as fast as he can. The utmost quantity he could throw out was our only stint, and amounted to about 9 cart-loads per acre, say of 30 bushels each. The advantages of this plan over large drills consist in the saving of labour, time, and expense, besides a more equal deposition of the manure. You know that in the common large drills heavy manures are apt to consolidate in the box, and it is difficult to 'keep them alive,' but on my plan the manure is always light upon the drill-works. Three carts, three men, and a drill-man, keep the drill always going. At Butleigh I have been drilling manure and soil with

seed-wheat beautifully. A quantity of road-dust was stored up in the summer, and I have obtained perfect control over the damp manure by mixing the two as required."

*Dibbling Machines.*—Particular notice was taken in the Report of the meeting held at Liverpool in 1841 (*Journal*, vol. ii., App. cvii.), of a seed-dibbling machine invented by Mr. Newberry. It has since undergone successive alterations and improvements, especially in respect of the mechanical deposition of the seed, therein alluded to. The judges at Southampton gave minute attention to this faculty, as possessed by an improved machine exhibited by Messrs. Saunder and Newberry, of Hook Norton and Bioxham. They report that the number of corns of wheat which issued in twenty-five droppings varied from one to seven, in the extreme—the average of the whole being somewhat more than four at each drop; but they observe that "the machine formed the holes and deposited the seeds very well," though with the irregularity of number mentioned. The price of the implement is considered by them as too great for the tenant-farmer: they also suggest that "the same end might be gained, and at much less expense, by using the common hand-dibble to follow in the track of a presser."

The practical value and performance of such an implement are evidently only to be measured and ascertained by its success, as manifested by the crops resulting from its use, taken in conjunction with the saving of seed, and other considerations. The writer has been furnished by Mr. Pusey with the following commentary on these practical points:—

"Mr. Newberry's dibbling machine is much liked by many farmers who have used it in Oxfordshire, and I tried it myself in the autumn before last. It is complicated, yet accurate in its construction. It is also heavy; but on light land, for which it seems calculated, that very weight is in fact an advantage, at least for wheat, because in pressing down the dibbles into the land it makes a solid bed for the seed—the advantage of which, on light land, is well known to practical farmers. In fact, the wheat-plants which had been dibbled with this machine looked as if they were growing upon strong land, being far more vigorous than those which had been drilled by their side. During the severe drought of May and June, the dibbled wheat was taller and also stronger in the straw, because the compression of the soil enabled it better to retain its natural moisture. When ripe, the ears were longer and much better filled; but, in consequence of the variations in the soil of the trial lots, the difference of yield could not be fairly tested. The quantity of seed used was  $1\frac{1}{4}$  bushel instead of  $2\frac{1}{2}$ , the amount commonly sown here with the drill. The allowance, however, is sometimes reduced to a bushel; and at Mr.

Miles's I saw the machine sowing little more than three-quarters of a bushel per acre. Although unable to give any account of my own comparative yield, I am glad to have obtained the following statement of an experiment which is very satisfactory:—

“ ‘ *Upper Swell, Sept. 21, 1844.*

“ ‘ SIR,—Having used your dibbling machine last year in opposition to the drill, I think it nothing but justice to you to state the result, which is as follows:—I planted 6 pecks per acre with the drill, which produced 26 bushels and 1 peck per acre; and on the next day I planted with the dibbling machine 5 pecks per acre in the same field (the land being the same in every respect), which produced 33 bushels  $1\frac{1}{2}$  peck, giving, in favour of the dibbling, 7 bushels and half a peck, besides 1 peck saved in the seed. The straw was much longer and stronger. The drilled weighed only  $63\frac{1}{2}$  lbs. per imperial bushel, the dibbled 64 lbs. Being so well satisfied with the experiment, I think you may safely recommend the implement, &c.

“ ‘ J. W. HAKKES.

“ ‘ *To Mr. Newberry.*’

“ The only drawbacks to the general use of this machine are the price and the draught; but the former objection is partly met by its being let out to hire like the common drill; and though it requires more horses than the drill, a saving of horse strength is made in other respects, because the dibbler is used at once on the land as left by the plough, without any harrowing or rolling as for the drill. Several neighbouring farmers have used the dibbler this season, who saw its effect on my land last summer.”

A hand-dibble, the invention of Mr. Richard Smith, of Upper Hall, near Droitwich, highly deserves record, in the opinion of the writer, as likely to prove a very useful implement. He finds no mention of it in the judges' notes. This dibble plants the seed, and possesses a principle of action which, if not already perfect, is an important step made towards the construction of a perfect self-feeding, self-depositing implement. On the top of a hollow stem is fixed a seed-box, with a delivering apparatus immediately beneath it. Below this again two handles project from the stem, one on each side, which work up and down in slides or slots formed in it. From the centre of these handles a rod descends with a tapering point, passing at bottom through a hollow conical termination of the stem, and forming part of the extremity which enters the ground and makes the hole. One of the levers of a small bell-crank is also worked by the handles, the other lever giving motion to a slider pierced with the hole which measures and lets fall the seed from the seed-box. The action is as follows:—when the dibble is pressed down into the earth, the modicum of seed is discharged from the box, and falls to the bottom of the stem; but its extremity being then closed, none of

it can escape, and no more can follow. On withdrawing the dibble the rising point is first liberated from the hole, whereon the seed instantly tumbles from the hollow stem into the hole. Next the dibble, or entire instrument, is raised out of the ground; a fresh hole is made, and so on. These two last apparently distinct actions are in fact only one to the user; since the dibble itself cannot rise until the man has lifted the handles to the top of the slot, whereby the whole instrument is raised out of the ground.

This account may not render the construction of the implement very clear, and there is perhaps no greater difficulty in descriptive writing than the illustration of a very simple piece of mechanism unaided by a diagram. The principle may be more perspicuously explained. It will be comprehended that the dibble is pressed vertically into the earth; that the seed is safely berthed in its bed before the dibble is withdrawn, which last action being also vertical, no crumbs can displace or interfere with the seed; that uniformity of depth and a considerable degree of firmness of seed-bed are also attained. In all practical respects the implement is handy and convenient to the workman.

The writer has made many experiments as to the accuracy of its discharge of seed. The result has been that the variation in the number of grains let fall is little greater than what is due to the difference in the aggregate bulk of their number. As a garden-tool, its utility must be very great, from its certainty and convenience; and if hand-dibbling be considered too slow for general agricultural purposes, this instrument will be found to be of great value in filling up spaces or spots short of plants. It will be found to be particularly useful for experimental culture, and possibly for cottagers' allotments, as its price (35s.) places it within the reach of a number of small cultivators. Since its exhibition at Southampton the inventor has much improved it, by making the shell of copper instead of tin; and he is now occupied in removing one or two objections elicited from its use by practical men.

*Horse-hoes.*—The judges awarded a premium of 10*l.* to Mr. David Harkes, of Mere, near Knutsford, for a parallel expanding horse-hoe, to work between rows of turnips, &c. In principle this implement is very similar to the one invented by Mr. John Morton, of Whitfield Example Farm, and described in the report of the Liverpool meeting. It was well constructed, and its performance highly commended.

Mr. Garrett's horse-hoe, for general purposes, was put to work on this occasion, in a piece prepared by the stewards for the trial of such implements. The judges pronounced its action to be "perfect," and assigned to the inventor the silver medal for some

recent improvements, prizes having already been awarded for the same machine at the Liverpool, Bristol, and Derby Meetings.

The improvements referred to consist chiefly in providing means for throwing the two outside hoes out of work, without stopping the horses, and quickly enough to prevent injury being done to the outside rows of corn where they may join or approach too near together at two contiguous stetches. The evil originates in irregular drilling; and has, in effect, hitherto created a practical objection to the use of the horse-hoe, but it is now, in the opinion of the judges, removed.

*Agricultural Carriages.*—The Society's prize of 15*l.* and the silver medal, offered for "the best agricultural carriage, with or without springs, for the general purposes of the road and field," was adjudged to Mr. Daniel Coombes, of Skipton, near Burford, Oxon, for his two carts convertible into a waggon. This is the combined carriage for which an encouraging premium of 5*l.* was awarded at Derby. No very material change had been made in it. An account of it appeared in the report of the Derby meeting.

Four other prizes were awarded to exhibitors in this department, three of which were obtained by Mr. Richard Stratton, of Bristol, and one by the Earl of Ducie, for the several carriages mentioned in the list of awards. Of the particular merits of these the writer finds no mention made in the notes of the judges.

Mr. Crosskill's carts and wheels are commended, particularly the latter, which were considered to be "good, cheap, and useful."

*Chaff-cutters.*—The show-yard contained, as usual, an immense number and variety of this indispensable implement. By far the greater proportion of these were submitted to careful trial by the judges. The Society's prize of 10*l.* and the silver medal was awarded to the Earl of Ducie, for his chaff-cutter with two spiral knives; thus confirming the judgment given at the Derby meeting. A description of the implement is given in the report of the Liverpool meeting. The judges observe, that "the amount of work performed, compared with the power expended, was so decidedly in favour of this implement, that all the rest in competition were quite thrown into the shade."

Messrs. Ransome's chaff-cutters are described as "never-failing workers, with a few improvements."

Mr. J. Richmond, of Salford, produced a chaff-cutter which is represented to have "a good claim to merit, particularly for the toothed feeding rollers, instead of the spiral or straight-fluted ones in common use, as also for the application of bevel wheels to give motion to them, as compared with the more common and uncertain ratchet and lever." The author may add his entire concurrence



in this commendation, having had the opportunity of seeing Mr. Richmond's chaff-cutter in work. It appeared to him that choking in the feed-rollers—an evil to which the best of these machines has hitherto been more or less liable—is scarcely possible from the form of toothed-rollers adopted by Mr. Richmond; and the getting up of the instrument was well worthy the reputation of a Manchester mechanic.

The three above-mentioned chaff-cutters are stated to have been respectively the best in the collection, and their merit in the order given. Others fell short of the duty required either in point of quantity or quality of work.

A new machine by Mr. James Gardiner, of Banbury, having a plurality of mouths, was considered by the judges to possess “considerable merit, but that the small openings for the cut create a difficulty in the feed, which is easily overdone.”

Another novelty was presented to the meeting, entitled the “Guillotine Chaff Machine,” the invention of Messrs. James Ward and William Colbourne, of Stratford-on-Avon. In this machine the cut is effected by the ascent and descent of a double-edged angular blade working perpendicularly, and cutting both upwards and downwards. The judges speak of it “as the smallest of all, and too small for general purposes, but meriting commendation as the possible forerunner of an improved chaff-cutter.” This short notice by the judges of a machine which attracted great attention in the show-yard, by reason of its apparent simplicity, truth of cut, and moderate price, is, in the writer's opinion, substantially correct, and all that can be expected from them who regarded it as an implement which, upon trial, deserved record in the report of the exhibition, but not a prize. The writer was requested by many gentlemen to examine this implement; he did so attentively and repeatedly, though unknown to the exhibitors. His opinion is that it possesses very considerable mechanical merit. The cutting blade being quite straight and flat, and presenting no difficulty of adjustment, permits of its being repaired or renewed by ordinary country blacksmiths. The feed is at rest during the ascent and descent of the knife, *i. e.*, during the cut; an excellent principle, though not original. The mode of effecting this alternate stopping and progress of the hay or straw is particularly simple and good. Notwithstanding these good points, however, it must be deemed very questionable whether their advantages be not more than counterbalanced by the limit put by them to the quantity of work it is capable of doing. The crank which impels the knife is necessarily obliged to be very long, as its length must equal the depth of cut, plus the breadth of blade, and some space more to permit the material to move forwards. A long crank and a short connecting rod are bad mechanical properties, and the

length of crank required has evidently governed the adoption by the inventors of a shallow feed or mouth; and this can only be deepened by an elongation of the crank. Its performance, therefore, is limited to the production of a quantity equal to that obtained from a two-knife chaff-entter; probably less for equal power.

*Turnip Cutters.*—A premium of 5*l.* was very properly awarded by the judges to Mr. James Gardiner, of Banbury, for his universally-csteemed implement, of which so many thousands are in use. It may be truly said that this turnip-entter, notwithstanding the many varieties introduced since its invention, is yet recognized to be the most simple, durable, and effective of its class.

*Cake-Crushers.*—An award of 5*l.* was adjudged to Mr. Richard Hornsby, of Grantham, for a cake-erusher, which is reported to have “proved itself on trial superior to any other in the exhibition, and the workmanship to be very good, its superiority arising from the form of tooth adopted by the maker.” The judges further observe, that there were among the large number exhibited “some good implements, but many very inferior from the form of tooth, and that those with two rollers worked the best.”

The form of tooth alluded to by the judges has reference to the rollers which break the cake. The writer may suggest, in addition, that this excellent implement, and others having rollers or parts which require to be adjusted at different distances asunder in order to suit their various purposes, would be rendered more durable and effective by adopting a form of tooth for the driving-wheels which would admit of their being set deeper or shallower in gear, and yet work with equal smoothness and truth. Such a form of teeth has been designed by that able mathematician and mechanician Professor Willis, of Cambridge; and a train of wheels on this principle has been mounted by Mr. Edward Cowper, Lecturer on Mechanics, &c., King’s College, London, who has obligingly assured the writer that he will explain the construction of the tooth to inquirers.

*Corn Cleaners.*—Some remarks are made by the judges on these machines, but no premium was awarded. Mr. Hornsby’s implement is considered to be the best in the exhibition, and very creditable to him. It is stated to be able to “chaff considerably more corn than any threshing machine can produce in the same time, and although not quite perfect in some points, to be a superior machine for general purposes.”

An entirely new winnowing machine, invented by George Parsons and Richard Clyburn, of West Lambrook and Uley, and exhibited by the Earl of Ducie, is represented to be “worthy of high commendation, and will, doubtless, when perfected, prove a superior implement.”

A corn-dressing or winnowing-machine, by Mr. Joshua Cooch,

of Harleston, is spoken of "as a good cleaner, when the dirty work is done for it; *i. e.*, when the corn is chaffed or half winnowed, Mr. Cooch's machine will complete it in a most masterly manner."

Of the remainder of the numerous collection it is said, "they are useful of their kind, but in general have not sufficient capacity to do much work, and are of the family of the last generation."

After this statement by the judges, founded on their trials, it is to be hoped that the attention of implement-makers will be more peculiarly directed to this subject. The dealer and miller prefer a clean to a foul sample of corn, and the agriculturist will find his advantage in the purchase and use of the best machine he can obtain.

*Barley Hummeller.*—To Mr. Joshua Cooch, of Harleston, a silver medal was adjudged for his hummeller combined with a winnowing machine and elevator, which also obtained the approbation of the judges, and a prize at Derby. It is spoken of "as an effective implement, and well manufactured."

*Corn and Seed Crushers.*—No separate prize was given in this class, the judges having involved it in the premium of 30*l.* awarded to Messrs. Ransome for their horse-engine and the machines combined with it, of which a corn and flax-seed crusher formed a component part. The judges report this crusher to be "the best implement of the kind yet brought before the public; two were tried, the one for beans and corn, the other for flax-seed, both being constructed on the same principle, and adapted either for hand or other power. Each consisted of two rollers grooved spirally, revolving at different speeds, but in the same direction, thereby causing a clipping of the grain or seed, which materially lessens the power required." These implements are "recommended as of very superior workmanship, and with the greatest confidence to the notice of agriculturists."

The "workmanship" of a crusher exhibited by the Earl of Ducie is mentioned "as very superior, and highly commendable," but in its effect "inferior to the foregoing."

The observation made on the remainder of the competing implements is, "that they were generally of good workmanship, but most of them required too much power."

*Threshing Machines.*—Five, moved by horse or steam power, were selected for trial out of the large number in the show-yard. Much interest was excited by the appearance of a threshing machine exhibited by the Earl of Ducie, being a recent and scarcely completed invention by G. Parsons and Richard Clyburn, of West Lambrook and Uley. The judges remark, "though it did not prove quite perfect, we think it worthy of the highest commendation."

The writer greatly regrets that, in consequence of his not having

seen this truly original machine in work, he cannot describe its construction and action with the accuracy he could desire. It is to be hoped that it will re-appear at the next meeting. The winnowing machine by the same makers is open to the same remark.

Of the hand-threshing machines the judges observe, "That which we considered to possess the greatest merit for originality of design, as also in its performance, was exhibited by Messrs. Barrett, Exall, and Andrews, of Reading. We highly commend this machine as likely to be useful in populous districts. Several others seem to have been copied from it."

Fry's threshing-floor is spoken of as "good and ingenious." It seemed to the writer that this simple contrivance, which permits the grain, as beaten out, to fall through a screen or grating of parallel round iron rods forming the upper surface of a large box which acts as the grain-receiver, may prove extremely useful for small farmers, and particularly for emigrants. The flail is a triple rod, and can be easily handled by a lad or a woman.

The show-yard is stated to have contained a great number of useful and good threshing machines: it appears, however, that no one of them possessed claims to superiority over those shown at former meetings so sufficiently marked as, in the opinion of the judges, to be entitled to the distinction of a prize.

*Corn Mills.*—The silver medal was adjudged to Mr. Dean, of Birmingham, for a French burr-stone hand-mill. The judges state this article "to possess great superiority over the steel mills, and will continue to do so. We do not consider any of the steel mills worthy of notice."

Mr. Cambridge, of Market Lavington, Wilts, produced some mills of which "the price was considered too high, and more suitable for a baker or flour-dealer than a farmer."

*Bone Mills.*—Two mills were exhibited by Mr. Dean, of Birmingham, the one for breaking up bones to sizes suitable for drilling; the other for grinding the produce of the preceding into fine dust. The judges observe that these were the only mills for the purpose in the show-yard, and were of "fair quality."

The attention of Mr. Dean and other manufacturers of strong and powerful machines, may be usefully directed to the construction of small-sized bone-crushers. There is a prevailing sentiment among agriculturists that the crushed bones of commerce are not unfrequently mixed with ingredients of no value, and that home collecting and crushing would save them from imposition. A very simple machine might also be made for reducing *guano* (some cargoes of which contain a considerable proportion of very hard nodules) to a fine state of pulverulence. It is a burden on the honest merchant to have to send this substance to a mill to be

prepared for agricultural use; and the writer conceives that it would greatly diminish the chance of fraudulent tampering with this valuable manure, if it were purchased by agriculturists as delivered from the ship, and reduced for use at home. It opens another source of employment for the productions of the implement-maker.

A very simple and cheap hand bone-breaking machine was produced by Mr. Robert Fry, exhibited in the collection of Mr. Richard Stratton, of Bristol, for which an award of 2*l.* was made. The preceding remarks, in respect both of bones and guano, apply equally to this simple machine and to its inventor.

*Churns.*—Of the variety of these dairy implements presented for competition, the judges selected one exhibited and constructed by Mr. David Harkes, of Mere, near Knutsford, as well deserving encouragement, and for which they gave the Society's prize of 5*l.* It is the invention of Mr. George Brown, of Capesthorpe, in the same neighbourhood. The judges report that "it has a double rotation of dashers, one set revolving within the other, and consequently operating more powerfully in producing butter."

*Cheese Pressers.*—A silver medal was awarded to Mr. Stratton, of Bristol, the exhibitor of a lever cheese-press, invented by W. J. Gingell, of Bristol. Of this implement the judges remark that "it is recommended by its simplicity and durability, and that it is within the power of a female to work it."

*Steam-Engines.*—There were four steam-engines exhibited. The judges made use of one manufactured by Mr. Cambridge, and of another by Mr. Dean, in the prosecution of their trials. Of the former they observe "that it worked well, was simple in construction, and being the best of the lot they awarded for it a prize of 5*l.*" They, however, give it as their opinion that "it would consume twice as much fuel per hour or per day as that represented by the maker."

Of Mr. Dean's engine the judges observe, "that it proved to be inefficient and dangerous in the extreme; they thought it a toy, and not useful to agriculturists." They further express their hope "that the Society will offer a prize of such importance for steam-engines, as to bring out something better than appeared in the show-yard at Southampton, now that they are of such acknowledged use to agriculturists."

The writer may observe that he did not witness the working of any steam-engines, and is, therefore, disqualified from expressing an opinion on the subject of their merits.

*Horse Engines and Machinery.*—An entirely novel combination of a horse-engine and machinery, constructed and exhibited by Messrs. Ransome, obtained from the judges an award of 30*l.*, being the highest sum they could afford out of the amount allotted by

the Society. The judges considered this compact arrangement of barn machines in connexion with a horse-engine to be of great value to the agriculturist, as bringing the means of working the principal implements of which he has need in that department, within the space of a horse-track. In the compass of a very moderate sized cast-iron framing lies the apparatus for communicating motion, either separately or at the same time, to a chaff-engine, corn-bruising or splitting-mill, &c., which are fixed upon the framing. A shaft also is connected with it for giving motion to a threshing, or other machine, at more distant parts. The writer's presence was requested by the judges to examine the arrangement and execution of this apparatus, and he concurs in their statement that "it was got up in the best style of workmanship, and does the Messrs. Ransome great credit as engineers." The judges further "express a hope that the prize given in this case may stimulate engineers and implement-makers to bring out first-rate machines." This award, as previously observed, includes the prize assigned to Messrs. Ransome for their corn and seed-crusher.

The writer has to add, as he conceives it to be his duty to do, that an erroneous impression was made on the minds of some persons respecting the practical value of this machine, from the circumstance of the mills being planted in the centre of the horses' track. For the purpose of exhibition and trial in the Society's show-yard, it was necessary that it should be erected in that form. In practice the frame and machines would be placed on the first floor of a building, as most convenient for such uses, and the horses would work below. The judges and the writer would condemn as most inconvenient and unsightly, the conveyance of materials to be cut, bruised, or ground within a horse track.

Several travelling horse-engines were experimented upon. The preference, with high commendation, is given to a set constructed by Mr. Clyburn, and exhibited by the Earl of Ducie. An overhead machine by Mr. Thomas Reeves, of Droxford, Hants, is stated to have been "very unsteady, and not firm enough in its work." The general observations by the judges on these machines are "that they are more condensed in space than heretofore, and placed on lower wheels, so as to work without the trouble of removing them; but that the greater majority are of too light a construction to be consistent with durability. Some makers have introduced the screw (worm) in place of the first or horse-wheel pinion, which we directly condemn."

*Fire Engines.*—The collection of fire and garden-engines exhibited by Mr. Read, of 35, Regent Circus, Piccadilly, is pronounced by the judges to be "superior to any other; the valves of the fire-engines are so constructed that failure is impossible, and a premium of 5*l.* was awarded for the fire-engines. They are

highly recommended to the notice of the public, both as fire and garden-engines."

The writer can safely give his testimony to the same facts. The fire-engine referred to will pass through any door of a mansion; and Mr. Read has applied so simple a method of increasing the number of persons who can act at one time upon the engine, that, as he observes, "a whole brigade of fire-men and *women* can be rendered serviceable in a moment of urgency."

*Water-lifting Engines.*—A very well arranged and well made engine for drawing water out of deep wells, was exhibited by the manufacturers, Messrs. Tasker and Fowle, of Andover, Hants, to whom the judges awarded the silver medal. The whole of the machinery is of iron: two buckets are used, the one ascending whilst the other descends; and it appeared to the writer to be a very safe and effective hydraulic machine.

*Weighing-Machines.*—A premium of 5*l.* was adjudged to Mr. H. G. James, of 44, Fish-street Hill, London, for his weighing-machine adapted to all the purposes of a farm. The judges on this occasion confirmed the opinion of those at Derby, that "the principle on which these machines are made must be correct." They cannot be too much extolled for agricultural use, whether for weighing oxen, carriage loads, or smaller articles. They have already come into extensive employ on railways and in warehouses.

*Iron-fencing, Cow-cribs, &c.*—Under these heads there was not such great competition as at Derby. The judges again considered Mr. Edward Hill, of the Brierly Hill Iron Works, near Dudley, to eclipse all his rivals in the neatness and efficiency of the various articles exhibited by him. They particularly cite the "marked advantage arising from his method of joining the lengths, giving great strength over other methods heretofore practised." They awarded to Mr. Hill the silver medal for his sheep-fences, and 2*l.* for his wrought-iron cow-crib.

Mr. Crosskill's pig-troughs and dog and sheep troughs were commended.

*Harness and Gearing.*—Of these items to which the Society had called attention, the judges remark: "The only improvement in harness is a back-band and tugs exhibited and manufactured by Mr. James Pearce, of Andover, Hants, to whom a silver medal was awarded. It will accommodate itself to the size of any shaft, is light, neat, and durable, and the back-band is readily detached in case of accident."

*Stack-stand.*—The silver medal was adjudged to Mr. Garrett, of Saxmundhām, for a stack-stand of wrought iron invented by J. Springall of Ipswich. It was considered by the judges to be "by far the best article of the kind in the exhibition."

*Screw-spanners.*—A silver medal was thought due to Mr.

Richard Clyburn for his adjusting spanners, or wrenches, exhibited by the Earl of Ducie. These will be found very useful both in the workshops and for all agricultural uses; they are much more convenient than the common monkey spanner.

*Trefoil and Clover-seed Drawing Machine.*—Messrs. Joseph Hall and Co., of Cambridge, exhibited the only machine for this purpose. The judges observe that “it proved on trial a good implement, and we awarded for it a premium of 5*l.*, although its price is considerable.”

*Hop and Malt Kiln.*—A model of an ingenious though somewhat complicated kiln for drying malt and hops, by Mr. S. J. Knight, of Maidstone, met the approbation of the judges; and as an encouragement to induce parties to a consideration of the best principles on which kilns for these purposes can be constructed, they awarded him a prize of 5*l.*

*Potato-Washers and Steamers.*—Mr. Crosskill’s and Mr. Richmond’s potato-washing apparatus are both commended by the judges; and Mr. Richmond’s steaming apparatus as “simple, cheap, and safe.”

*Haymaking Machines.*—Five of these machines were examined by the judges, and two of them commended “as working exceedingly well;” the one being manufactured by Mrs. Mary Wedlake, of Hornchurch; and the other by Messrs. R. Wedlake and C. Thompson, of Romford, Essex.

*Rick Ventilators.*—The now well-known rick ventilator invented by Mr. John Gillett, of Brailes, near Shipston-on-Stour, and rewarded at the Derby meeting, is reported by the judges “to continue to merit the strongest commendation.”

There are several other meritorious articles of minor import, well spoken of by the judges of the Miscellaneous department; but the writer finds they have to complain of the non-attendance of some of the exhibitors of these productions when called upon. Also, that others have tried to evade the scrutiny of the judges, by keeping their articles unpacked until after the judges have completed their investigation. It may be of use to state here, that in either of these cases, on a representation being made by the judges to the stewards, unpacked or unrepresented articles will be instantly expelled from the show-yard.

*Drain-Tile Machines.*—The mechanical appearance of the show derived no inconsiderable lustre on this occasion from the number of drain-tile machines exhibited in competition for the Society’s prize, enhanced as it was by the general desire of landowners and farmers to become acquainted with the best and cheapest machine for preparing tiles for so essential and costly an operation as drainage. Thirteen machines were produced, being exhibited by seven proprietors: of these, four machines are re-



ported upon by the judges of the department, three of which were worked by hand, and one by horse-power. It appears that the other nine "were not prepared for trial," and one of the four being "in an unfinished state," our attention is confined, as was the case with the judges, to the performance of three of them. Of these, two are catalogued as the invention of Mr. F. W. Etheredge, of 11, Furnival's Inn, London, and manufactured by Messrs. Ransome; and the third as the invention of Mr. H. Clayton, of 21, Upper Park Place, Dorset Square, London, manufactured by himself.

The judges first noticed the performance of Mr. Etheredge's horse-machine, of which a pretty full account is given in the 'Report on Drain-Tiles and Drainage' (Journal, vol. iv. p. 370). It appears that during six minutes—the duration of the trial—96 tiles of different shapes and denominations were produced, averaging  $16\frac{1}{2}$  inches long = 16 articles per minute, or 960 per hour. Among these articles no pipes are mentioned.

Secondly, we have the performance of a very recently-invented hand-tile machine, by Mr. Etheredge, which produced during five minutes 67 articles  $13\frac{1}{2}$  inches long, of which 33 were full inch-bore pipes, and 17 tiles with soles, and double tiles =  $13\frac{1}{6}$  articles per minute, or 804 per hour.

Thirdly, Mr. Clayton's performance is stated to have been, during five minutes, 43 pipe-tiles of various lengths, "not so sound as the last, and, being of irregular lengths, not fit to set in a kiln." This performance equals  $8\frac{1}{6}$  pipes per minute, or 516 per hour: but the clay was in too moist a state for Mr. Clayton's machine, and only one-third of the time mentioned was applied to the actual making of tiles.

The judges further observe, that "all the machines were supplied with clay from the same heap, and the exhibitors made tiles in any way they pleased." "We considered the hand-machine (Mr. Etheredge's) would be most generally useful; that it made better tiles than the horse-machine, or than Mr. Clayton's, and was the only hand-machine which made tiles that would stand well in the kiln."

In conformity with the discoveries resulting from these trials, the judges awarded the Society's prize of 20*l.* and the silver medal to Messrs. Ransome as the exhibitors of Mr. Etheredge's implement.

It is the writer's duty to throw such light as his knowledge may enable him to do on points which seem to have escaped the judges' observation, or not to have been illustrated by them. The conditions of the Society's offered prize, required that "the price at which tiles or pipes have been sold, be taken into consideration." Of this no mention is made by the judges.

The writer has ascertained that at the period of the South-

Southampton Show seventeen of Mr. Clayton's machines were in work at the establishments of different gentlemen; and at the works of Messrs. J. and W. Squire, of Yarmouth, Isle of Wight, inch bore drain-pipes, produced by Mr. Clayton's machine, were there selling at the rate of 12*s.* per thousand, 12 inches long, their prices rising through intermediate sizes to 18*s.* per thousand for pipes  $2\frac{1}{8}$  inches diameter. This fact will be very gratifying to the Society, when it is recollected that not more than eighteen months have elapsed since the publication in their *Journal* (vol. iv. p. 45) that the price of inch-bore pipes was from 20*s.* to 22*s.* per thousand, being then about the half of the average selling-price of the more common tile and sole; so that, at the present moment, small pipes are procurable from Mr. Clayton's machines at one-third or one-fourth of the cost of the ancient description of draining tiles.

With the selling price of the articles produced by Mr. Etheredge's machine the writer is unacquainted, or he would gladly have availed himself of this opportunity of stating it to the Society. He has neither seen the prize machine at work, nor been able to satisfy inquirers as to the actual number of articles produced by it in a given time, or their selling price at any establishment.

The reduction in the selling price of pipe or other tiles has necessarily arisen from a diminution in the cost of production. The little Kentish machine (described in *Journal*, vol. iv. p. 373) could not make more in ten hours than 1000 or 1200 inch-pipes. Mr. Clayton's machine, as exhibited at Southampton, has regularly produced in the same time, to the writer's knowledge, 15,000, = 1500 per hour; and by a more recent improvement in the dies, it is made capable of throwing off 25,000 feet of pipe per diem. But this increased faculty of production is not of such great importance, in the estimation of the employers of this machine, as another improvement introduced by Mr. Clayton, and engrafted on it; viz., the means of clearing from the raw clay all stones, roots, or other matter which would impede its conversion into pipes or other desired forms. It was the only tile-machine in the show-yard furnished with a process of the kind. This process has been represented to the writer by several of its employers—and is fully believed by him, from his own observation—to be superior both to pugging and washing, as well as cheaper, in the preparation and tempering of a variety of clays; and the wintering of many kinds of clay is no longer deemed by them to be essential to carry on the summer work of a tilery. At the period of the Southampton meeting six of the seventeen machines already referred to were at work without pug-mills. Since that time several others have been put into active operation where pug-mills do not exist. The pug-mill and horse have also been abandoned by parties who continued

their use, at first, from an uncertainty as to the powers of Mr. Clayton's preparing process as a substitute.

Since the meeting Mr. Clayton has devised an apparatus of a very simple and cheap nature, by which drain pipes and tiles are brought to an exactly uniform length before setting them in the kiln, and another for socketing pipes for house-drains.

JOSIAH PARKES.

---

JUDGES.

T. P. Outhwaite, Bainesse, Catterick, Yorkshire	} Ploughs, subsoil-pulverizers, clod-crushers, scarifiers, harrows, horse-hoes, drill-pressers.
William Heseltine, Worlaby House, Barton, Lincolnshire	
Chas. Clark, Aisthorpe, near Lincoln	} Barn-machinery of all kinds, dairy implements, miscellaneous.
Bryan Millington, Asgarby, near Sleaford, Lincolnshire	
Isaac Everett, Capel St. Mary's, near Ipswich	} Drills, carts and waggons, hay-making machines, tile-machines.
Charles Burness, Park Farm, Woburn	

---

XIX.—*On the Allotment System.* By SIR HENRY E. BUNBURY, Bart.

*To Ph. Pusey, Esq.*

SIR,—I FEEL myself honoured by the request that I should communicate, for the information of the Royal Agricultural Society of England, the results of my practice in letting small portions of land to farm-labourers.

I began about 28 years ago in a little way, having at that time but little land at my disposal. My earliest trials, with mere gardens, soon showed me that, while the condition of the cottagers' families was in some degree improved, the men, to whom these patches of ground were allotted, became more domestic and moral in their habits.

Encouraged by these essays, I enlarged my plans gradually as my means of disposing of land for this purpose became more ample. And a long experience and earnest attention to the subject have fully satisfied me that the letting of land to labourers on fair terms, and under proper regulations and superintendence, is productive of the most beneficial effects. I do not speak of its effects on the physical condition of the labourers only, but at the same time of the benefits resulting to the landowners, the farm-tenant, and the community at large.

I must beg leave to guard myself against being suspected of believing an allotment to be a panacea for all the ills and diffi-

culties which beset the present condition of our labourers; but it is one of the most effectual and most ready means of improving that condition.

I found a difficulty at first in persuading my tenants to give up small portions of their respective farms to form my allotments; they were prejudiced against the plan, suspicious and fearful of its effects. Some of their considerations they probably did not impart to me; those which they urged appeared to me to be groundless, or of little weight. At the end of more than twenty years I have the great satisfaction of finding my tenants convinced of the good effects resulting from the practice, and willingly co-operating with me in carrying it on. I have now introduced a clause into my agreements with tenants, that if small portions of their respective farms should be wanted for cottages or allotments (not exceeding half an acre for each labourer), such portions may be taken, and allowance made according to valuation, in the same manner as had been stipulated before with regard to land required for planting.

In allotting land to labourers I have begun with assigning a small portion to each man; frequently less than 1 rood, though sometimes more. Mathematical precision in allotting one rectangle of 40 poles, neither more nor less, has always appeared to me objectionable. One man, with sturdy children, can manage half an acre with more ease than his next neighbour, with a puny family, can work 20 poles. I took my pieces of land, such as they might be, as opportunities offered. The nearer a piece might lie to the cottager the more advantageous it was to him; but in some instances I have been obliged to assign land lying at a distance of half a mile from the man's dwelling; yet he has eagerly hired it, and I have reason to know that they have derived much profit from it. However, the nearer at hand the ground lies, the better both for the labourer and his employer.

When I have found that the allotment-man did justice to his land, and possessed a pig or two to produce manure, I have taken any opportunity that presented itself to increase his portion; for experience has shown me that a good labourer, with the help of his family, can very well cultivate half an acre without its interfering with his constant employment on a farm. But it must be borne in mind that a considerable proportion of our labourers cannot obtain constant employment on the farms in this quarter of England: many men are thrown out of work during three or four months in the year; and the inferior hands during six or seven. I do not run out of the record to discuss the question whether more constant and profitable employment might not be devised, but I see that, taking the case as it stands at present, to such men half an acre of land, on which they can work with a

certain return of profit, is of the greatest value. There are also in every village some men, such as thatchers, bricklayers, pig-jobbers, &c., who have much leisure time at their command, and can manage from half an acre to an acre with great advantage. But, on the whole, I consider half an acre to be the best average; and I believe that the labourer's net profit on this quantity of land may be rated at from 3*l.* 10*s.* to 5*l.* a-year. But as one of them said to me, "I cannot tell you, sir, what my land is worth to me in money: it helps us in so many ways; a bit here and a bit there. It helps the children, and it feeds the pigs and the fowls. It is the best thing that ever was done for a poor man." I may add to his calculation of benefits the moral good resulting from its keeping his children employed, instead of their idling about the parish, and acquiring vicious habits. They are brought up in industry, and learn its advantages in their early days.

The soil of most of my allotments in this parish is a strong clay, with a marly subsoil. The spade is used on all; but I do not insist on its being used exclusively, because I wish to leave an opening for a farmer to do an act of kindness occasionally to a good labourer, by ploughing his land for him, and thus to generate or improve kindly feelings towards his employers.

At first the allotment-men thought of nothing but wheat and potatoes. But they came to find that the potato-crop, and constant digging and rich manure, loosened the soil too much for their wheat. It was apt to become *root-fallen*. They now grow various things; and particularly a proportion of beans, which they find to answer well for their pigs, and to render the ground firmer for their wheat. The produce of the latter per rood is very great: I have seen their crops in many instances yield at the rate of 6, and, in one instance, at the rate of 7 quarters an acre.

The number of pigs kept in the parish is now very great; and in consequence most of the families use some animal food.

Many of the inferior hands, when not required by the farmers, obtain occasional employment in digging on the larger allotments.

The rents which I charge for these cottage-lands may be averaged at nearly 2*d.* a rod, tithe-free. I pay the parish-rates if the allotment does not exceed an acre. In three instances I have let as much as 4 acres each to labourers who had saved money. These men work no longer on farms; but they maintain their families comfortably, and their lands are kept in a very good condition. I may mention, by the bye, a remarkable fact, that the population of this parish increased rapidly in the twenty years preceding my residence here; while in the last twenty it has advanced very little; nay, in the last ten it has actually *decreased*. I am willing to attribute this singular circumstance partly to the operation of "the prudential check."

The rents are paid annually, on Michaelmas-day. They never fall into arrear; for the people are too anxious to retain their allotments, which would be forfeited if they neglected to make their payments without permission. In twenty years I have found occasion only once to deprive a man of his land on account of crime; and in one other instance, on account of neglect in the cultivation.

I beg leave to state that it will be found essential, especially in populous neighbourhoods, to make it a stringent article in the regulation of allotments, that no portion should be under-let, or transferred in any way to another person without leave from the landlord. Immediate forfeiture should be the penalty of such a proceeding.

Believe me, Sir,

Your very faithful servant,

HENRY EDWARD BUNBURY.

*Barton, Dec. 7, 1844.*

---

XX.—*Trial of several Artificial Manures.* By WILLIAM MILES, Esq., M.P.

MY DEAR PUSEY,

IT has often struck me when reading in the Journal the accounts of experiments made with different kinds of manures, that for the information of tenants on small holdings our trials have never been sufficiently carried out; for if the manures lately brought into use are to be of general benefit to the farming community, it appears necessary to place their merits in so intelligible a light before the farmer of small capital that he may at a glance perceive that their original cost will be amply compensated by the beneficial results which will follow their use; that their effects are not transient, and confined solely to the first crop to which they may be applied, but are fully appreciable in that which may succeed. The common farm-yard manure, could we only raise a sufficiency, would be adequate to all our wants; but taking into consideration the little care that is used to preserve its fertilizing properties from evaporation, and the few tanks which are yet placed in the yards to collect the drainings from the dung-heap, it appears to me impossible ever to obtain a sufficiency from this source to enable us to raise the fertility of the soil to that point which may enable us to cope with the moderate prices which we have obtained for our produce of late; added to which that seasons might occur like the present, when, from the almost universal deficiency of the grass crops, the necessity arises of con-

suming for food the straw which at other times would be used for litter.

Urged by these considerations, I determined in the year 1843 to try a certain number of those artificial manures most generally in use against the common farm-yard manure, with the view of ascertaining the beneficial effects resulting from their application, both to the turnip and the succeeding wheat crop. The results of these experiments I now venture to lay before the public; but from the peculiarity of the present season, beg particular attention to the previous treatment of the land on which these experiments were tried, as it is necessary to consider how much of the productiveness of the wheat was attributable to the effect of the manures, and what to the greater depth of soil obtained by subsoil ploughing. This is a preliminary suggestion which I think it right to make, as it is not my intention to reason upon the results, sufficiently satisfactory in a pecuniary light to myself, but to leave the scientific or practical man to draw his own inferences from the facts now submitted. The field was a good loamy soil. In the year 1841, preparatory to the wheat crop, 10 bushels of bones had been sown on the clover-ley previously to ploughing. In the year 1842, after the wheat crop had been harvested, the subsoil plough was used, and the land stirred to the depth of 14 inches: such was its condition when, after having got it into good turnip tilth, and having accurately marked out 6 acres, to

No. I. was applied 40 bushels of Daniel's manure marked B, sown broadcast and ploughed in previously to ridging up, in addition to which 12 bushels marked A were drilled in before the seed, so as not to come in immediate contact with it.

No. II., 10 tons of farm-yard dung, mixed with 30 bushels of Daniel's B manure one month before using.

No. III., 20 tons of farm-yard dung.

No. IV., 20 bushels half-inch bones, drilled in before the seed.

No. V., 3 cwt. of guano, mixed with 15 bushels of screened Newport coal-ashes, and drilled in before the seed.

No. VI., Stott's salts,  $2\frac{1}{2}$  bushels, mixed with 11 bushels of screened Newport coal-ashes, and drilled in before the seed.

Skiving's improved Swede was the seed drilled in on the 18th of May: the plants came up well, and during their growth were not affected by fly or any other disease; they were pulled, topped, tailed, and weighed on the 1st of December—the weights per acre will be seen in the subjoined table. The ground was soon after ploughed, and on the 24th of February Bellevue Talavera wheat was drilled in, which came up very well. On the 27th of April I find by a note that the wire-worm attacked the wheats in Nos. 4, 5, and 6, more than that in any other part of the field;

but still, thanks to the rooks and heavy rolling, plenty of plant was left. The wheat, until it came into ear, notwithstanding the drought, which in this part of the country was uninterrupted, looked admirably. When however it had attained that condition it fell away, and apparently withered from sheer lack of moisture; nor did I conceive that it would average above 18 bushels per acre. It was cut with scythes on the 10th of August, and was housed on the 20th—for the results I must refer to the subjoined table, in which, in addition, I have given the cost of manures, the proceeds derived from each of the crops, and the gross and net amount, after deducting the cost of manure, derived to me from the experiment. The rent paid for the land, tithe free, is 50s. per acre.

The effect of these different manures upon the growth of turnips, taking the greatest and smallest produce, and comparing them, is this:—

No.		Tons.	Cwt.		No.
5	produced . . .	7	10	more than . . .	1
3	,, . . .	5	12	,, . . .	1
2	,, . . .	4	10	,, . . .	1
4	,, . . .	2	16	,, . . .	1
6	,, . . .	2	4	,, . . .	1

The relative efficiency of the manures, however, undergoes a most extraordinary change as far as the growth of wheat is concerned; for adding the head and tail corn together produced on each acre, and testing their relative produce as we did the last, we find the following to be the result:—

No.		Bush.	Pecks.		No.
2	produced . . .	7	2	more than . . .	3
1	,, . . .	6	2	,, . . .	3
5	,, . . .	3	2	,, . . .	3
4	,, . . .	1	0	,, . . .	3
6	,, . . .	0	3	,, . . .	3

Now, after guano, which upon the two crops gives the greatest profit to the farmer, it will be observed that the mixture of dung and Daniel's manure stands second. I had never given this compost previously a fair trial, but had in various ways, and with different quantities, unsuccessfully applied Daniel's manure by itself.

The result, however, of this experiment, conducted for two years, leads me to infer that this manure, when properly mixed with farm-yard dung, will be most advantageous, saving much expense in leading, and giving at any rate an equal profit—in this case a considerably larger one than would be derived to the farmer by the application of double the quantity of dung unmixed; and indeed in this view I am corroborated by a commu-



	Number.	Quantities used per Acre.	Cost of Manures per Acre.	Turnip produce per Acre, 1843.	Wheat produce per Acre, 1844.		Straw per Acre.	Value of Produce per Acre, 1843.	Value of Produce per Acre, 1844.	Gross Value of Produce per Acre, for 2 Years.	Net Value of Produce per Acre, deducting the cost of Manure for 2 Years.
					Head.	Tail.					
			£ s. d.	Tons. Cwt.	Bush.	B. P.	Tons. cwt. qrs. lbs.	£ s. d.	£ s. d.	£ s. d.	£ s. d.
Daniel's . . .	1	{ 40 bush. broadcast, B; 12 bush. A, drilled before seed . . . }	1 19 0	15 8	36	3 2	1 3 2 10	7 14 0	11 1 0	18 15 0	16 16 0
Daniel's and Dung Compost	2	{ 30 bush. Daniel's, B, mixed 1 month before use with 10 tons of dung . }	3 10 0	19 18	38	2 2	1 4 0 8	9 19 0	11 8 6	21 7 6	17 17 6
Dung . . .	3	{ 20 tons . . . }	5 0 0	21 0	31	2 0	1 0 3 14	10 10 0	9 6 3	19 16 3	14 16 3
Bones . . .		{ 20 bush. drilled in before seed . . . }	2 15 0	8 4	33	1 0	0 19 1 25	9 2 0	9 13 9	18 15 9	16 0 9
„	5	{ 3 cwt. mixed with 15 bush. of ashes, drilled in before seed . . . }	2 2 6	22 18	34	2 2	1 0 1 10	11 9 0	10 5 6	21 14 6	19 12 0
Scott's Salts.	6	{ 2½ bush. mixed with 11 bush. ashes, drilled in before seed . . . }	1 16 4	17 12	32	1 3	1 0 2 9	8 16 0	9 11 0	18 7 0	16 10 8
			17 2 10	115 0	204	13 1	6 8 3 20	57 10 0	61 6 0	118 16 0	101 13 2

nication made by Sir William Heathcote, and published in our last number, of experiments instituted by him on the wheat crop of 1843 with different kinds of manure, in which I find that a mixture of 10 tons of dung and 25 bushels of Daniel's B manure yielded the greatest quantity of wheat, next to a mixture of dung and guano. The trial was made with nine different manures—dung and guano producing  $35\frac{1}{2}$  bushels, and dung and Daniel 35 bushels per acre. And although Mr. Fowlie, Sir William Heathcote's bailiff, is not willing to admit that Daniel's manure was of any use in contributing to this growth, attributing the production to the use of the dung; yet, where dung was applied alone, and precisely in the same quantities as was used by me,  $32\frac{1}{2}$  bushels was the crop. Mr. Fowlie likewise states, "that although dung has in this instance been secondary, he was inclined to believe that this is entirely owing to the season, the wet May and June having caused the wheat to be too luxuriant;" whilst I, if tempted to make a remark upon the failure of dung in my experiment, should infallibly ascribe it to the dryness of the season and to the heating qualities of the dung still remaining in the soil, from the application of a large quantity.

Of the efficiency of guano nothing need be said—this is but one of the very numerous instances in which its use has been proved most beneficial, and such as to justify the immense importation now taking place for farming purposes. I had never, however, previously tested its effects the second year: for its value I must refer to the concluding column of the table.

The Swede turnips, which were all carried from the land, I have valued at 10s. a ton; the wheat at what I sold it for, viz., 5s. 9d. per bushel; the tail at 4s. per bushel. I have set no value whatever on the straw.

Believe me,

Sincerely yours,

W. MILES.

*Kingsweston, November 13th, 1844.*

---

XXI.—*Some Account of the Process of Warping.* By  
RALPH CREYKE.

THE public attention having been of late years more particularly called to improvements in agriculture, and the different methods of rendering waste lands cultivable, I think that perhaps a short description of improvements, though of themselves of a local nature, and from circumstances not available out of a certain district, may be deemed acceptable to the public in general; and I have been requested by some of my friends to give a short description,

more of a practical than of a theoretical nature, of the system of warping, and I am tempted to do so solely from the circumstance, that I am desirous, by a description of the improvement, of giving due credit and respect to one to whom the country was so much indebted for his enlightened views on the subject, and also for carrying out those improvements which have made rich, and brought into cultivation, a large tract of land which was originally of a totally uncultivable nature.

There are considerable tracts of land on both sides of the rivers Ouse and Trent (forming at their junction the estuary called the Humber), and the tributaries the Air and Dutch river, all tide rivers, which from their low level would be subject to be flooded by these rivers at high-water, were they not contained within their present beds by banks. Science seems more particularly to have had an advantage over literature in the present instance, for while the banks, works of great labour and skill, remain, history seems particularly dark on the subject of by whom, and when they were made; they must have been made at the same period, and must have been the work of great labour, being of immense size and strength, many thousand acres of fine alluvial soil having been preserved from the action of the tide.

Considerable improvements were made in later days, during the reign of Charles the First, by a company of Dutchmen under Sir Cornelius Vermuyden (and a few Frenchmen), calling themselves "Participants," who contracted with the Crown to drain certain lands south of Thorne and in the parishes of Epworth, Crowle, &c., containing about 75,000 acres, receiving for their labour and expense one-third of the land so drained, the Crown reserving for itself one-third, the remaining third being divided amongst the commoners of the district. They amongst their numerous works widened the river Dunn, and turned its course by cutting a new river, called at present the Dutch river, flowing into the river Ouse at Goole. The Dutch seem, by numerous lawsuits, and by a *marked* dislike of the inhabitants to those *innovators*, to have been finally driven out of the country, and their property to have been taken from them (although there are many bearing Dutch names living in the neighbourhood to this day). The lands, however, originally allotted to the Participants, pay certain rates to maintain the banks and works, and to keep the drainage in proper order: this, however, only refers to the Dutch river, showing *its* origin, and to lands far removed from the district where the improvements I am desirous of describing have been, and are still being, carried on.

About two miles from the banks of the river Ouse there is a peat-moss containing about 10,000 acres, called Thorne Waste; this peat-moss is, I fancy, of the same construction as the gene-

rality of those which have been formed in parts of the country removed from mountainous districts; its foundation is sand, on which are the *débris* of a very fine forest of oak and pine, and several fine yew-trees have been found, some in high preservation. This forest was most probably laid prostrate at the time of the Deluge, as the trees do not show the action of fire, and they are mostly laid in the same direction, from south-west to north-east. The peat itself is of a very spongy nature, not so much decomposed as the Irish peat; its greatest depth is near the centre, where it measures about 18 feet.

In bygone days, when the rivers were not contained within their present banks, they must have had a natural flow up to the margin of this peat-moss, which at that period must have been above the level of the tide at high water; but years and ages passing by, and drains having been cut through the cultivable land, a considerable tract of this peat-moss became in a certain way drained, and of a much lower level than it originally was, and consequently proved capable of being covered by the tide-water from the river Ouse. This peat-moss was totally of an uncultivable nature, being a perfect morass, and in many places dangerous to approach: a considerable portion of this has been already warped.

The process of warping was first practised about eighty years ago; it was commenced in a very small way, the *sluices* or *cloughs* used then being merely what now would be called *shuttles*; and the deposit at first was very small, from want of power consequent on the works being so small; gradually, however, the benefit became more generally known, and the works were made larger. In 1821, Ralph Creyke, Esq. (having gained considerable experience in improving a certain quantity of his own land), entered into an agreement with certain proprietors of land in the townships of Goole, Swinefleet, and Reedness, for the purpose of warping their land. An Act of Parliament was obtained, and he commenced excavating a large main drain to convey the tide-water from the river Ouse, through the old cultivated land to the barren and uncultivated morass about to be improved.

The sluice or clough was built of stone, with two openings of 16 feet each in width, and 19 feet in height from the sole to the crown of the arch, with four substantial doors, made when shut to oppose the entrance of the tide, yet with power at will to keep them open for the admission of the tide during the time of warping, by means of strong staples and iron rods fixed in the stonework.

The main drain was very large, it having been proved by continued observation and calculation, that the area of a warping-drain ought to be three times that of the sluice, to prevent as much as possible any considerable resistance to the flow of the water; its

dimensions were 30 feet wide at the bottom, 90 feet wide at the surface of the land, and  $11\frac{1}{2}$  deep; the banks were placed 9 feet from the edge of the main drain, the base of each bank was 60 feet wide, and they were 10 feet high; this main drain extended originally for near 3 miles, and cost, with the purchase of land and erection of sluice, about 18,000*l*.

This main drain and its extension is now, and has been, used as a canal for vessels of about 75 or 80 tons burthen, and has been found very convenient for the purpose of conveying one of the chief productions of the warp-land, namely, potatoes, to the London market (where they command a high price under the name of Yorkshire Reds), bringing in return manure, an immense quantity of which is used in the cultivation of potatoes, and is chiefly brought from Hull and London.

In commencing the warping of any plot of land, it is first enclosed with banks, the size of which varies according to the quantity of land to be warped, and also to the level of the land about to be embanked; the general batten or slope of the banks is from 15 to 18 inches on each side for every 12 inches' perpendicular rise; they are left from 2 to 3 feet wide at the top. Particular care must be taken in erecting the banks to procure the proper levels, which should be taken by an experienced person, and laid out by the spirit-level.

The main drain being cut up to the newly-embanked compartment, the tide is suffered to flow in. At first it is very advisable only to take rather small tides in, beginning to admit the water before they are at their height, and allowing them to increase by small degrees, for the banks being generally made of very porous materials—that is, peat-moss and bad sand—they are subject to leak very much, and in some instances considerable damage has been done by a breakage of the bank. Soon after the commencement of the works in question, a breakage of the main bank incurred a loss of 1200*l*. In case of a bank being rather exposed to the action of the wind, which is one of the greatest enemies that a warper can have to contend with, it is generally what is called “puddled,” *i. e.* a trench from 2 to 3 feet wide is cut longitudinally through the centre of the bank into the foundation, the material is chopped up and mixed with water, which being pressed down and beat by repeated treading, becomes a solid mass.

The water is allowed to flow over the land during the spring-tides. The reason why the spring-tides are only generally made use of is, that the neap-tides are much smaller in body of water, and although they might in certain instances be of sufficient height to flow the land, yet as one of the greatest difficulties in warping is to keep the main drains in order by preventing the warp from being deposited in them, and as that is chiefly done by the return

of the water from the compartment under the process, which in spring-tides being a larger body of water, scours out the drains, in neap-tides there would not be sufficient flow, and they would be warped up.

The water conducted by the main drain into the embanked allotment is more or less divided into smaller ones, called "inlets" (which vary much in size), and conducted to different parts of the compartment: for *wherever the current, leaving a drain, expands itself, there the greatest quantity of warp is deposited*: as soon then as the plots of land next the mouth of the inlets have a sufficient quantity of warp deposited, the inlets are extended by what are called "call banks," which, though much smaller than the others, still conduct the current onward to parts not acted upon by the currents before, and so on according as required. One of the greatest niceties in warping is to have the land finished as level as possible, which can only be done by the strictest attention, and by proper judgment in conducting the different currents, which must not be suffered to cross one another, or to meet, as in such a case the deposit of the warp is less, not so regular, and of an inferior quality.

Care must also be taken that the currents should not be too strong, for in warp there is a considerable portion of sand which, being the most heavy of all the particles floating in the water, sinks first, the lighter particles being carried on by the violence of the current, consequently a sand-bed is formed. These sand-beds, however, if covered afterwards with warp, generally are found to crop better than warp which may be too strong. With respect to the depth of warp deposited, it depends much upon the level of the land to be warped; for, should the land be very irregular, in some places there would be a great deposit, and in others only comparatively a small one. It is generally advantageous to have the land to be warped as level as possible. A deposit may then be obtained of from 1 to 3 feet, and in some favourable instances it has been considerably more, but it cannot be generally calculated on.

It has been frequently asked what quantity may be deposited in a single tide. It was mentioned before that "wherever the current, leaving a drain, expands itself, there the greatest quantity of warp is deposited:" consequently the water, though allowed to flow over the whole of the compartment, deposits the warp in a very irregular manner. In one spring, perhaps numbering 10 or 12 tides, as much as from 10 to 15 acres have been known to have been warped the thickness of from 1 to 3 feet, and even sometimes more; but the system being conducted entirely by currents, the general deposit of a tide or of a spring cannot be given with any certainty. It however sometimes is very great during a season.

In June, 1829, a compartment was commenced (a small one only) of 160 acres, which was finished in January, 1830—a period of only seven months. During that period a general deposit took place of between 1 and 3 feet, but that was an extraordinary season, and the compartment lay in a favourable situation for being warped.

The time it takes to warp a compartment cannot be very accurately defined, there being many circumstances to take into consideration. Some of the compartments are much farther from the mouth of the drain than others; in addition to which, should the lands to be warped be very low, they can only take in perhaps every second tide, and even sometimes only every fourth, on account of the difficulty of getting the water back again, for the tide continues to flow into the compartment until perhaps nearly low water in the river. The tide then returning, as it does very rapidly, prevents the water from flowing out of the drain, and would fill the compartment too full of water: the doors are consequently closed against the tide. They open themselves, however, when the water in the river is of a lower level than that in the drain. When the compartment is near the river, that does not occur, as the water has time to get off before the tide returns. The seasons also vary very much; but I think, with the drain in question, that with a fair average season, from 350 to 450 acres might be warped in two years, or two years and a half.

The immense size of the drain, and its consequent great power, facilitates very much the warping of land of a higher level than that which could be warped by a small drain; for the current being forced on by the great flow in the drain, can be made to flow over the high ground by turning a drain towards it, provided that there be sufficient land of a lower level on the other side to draw onward the water so forced over the hill. The warp so deposited is at first of an inferior quality, the current being so strong; but in a short time the peat-moss becomes pressed down by the weight of the deposit. The current is then easier, and the deposit becomes better.

It may be asked, from whence comes this inexhaustible supply of mud or warp? There is an immense quantity of it floating about the Humber and its tributaries, and from whence it comes people differ. There have been considerable ravages (and they still continue) made by the sea on the coast of Holderness, extending all the way from Bridlington Quay to Spurn Point; but as the Humber is comparatively clear at the mouth, it is difficult to say whether it can come from that source. It does not come directly from land-floods, as these always deteriorate, for the time, the deposit, although considerable deposit being carried down into the Humber by land-floods, may return in the shape of warp.

The most likely, in my mind, is that it arises from the action of the tide on the immense and almost hidden beds of soil which form the bottom of that large estuary the Humber. It appears, however, that the warp is full of seeds of different sorts, more particularly the white clover, which it grows in great abundance, and quite naturally. The quantity of warp in the water differs considerably. There is more in the water during fine and dry weather, and the deposit is greater when there is no wind.

It is highly advisable, if possible, to avoid finishing the warping of a compartment during the very fine and hot weather of June and July; for the tides are small at that period of the year, and are apt to be strongly impregnated with saline particles, which, being left in the warp, have a very injurious effect in retarding vegetation.

The expense of warping cannot be laid down with any certainty, as the different compartments vary so much. When the land to be warped is very low, the banks require to be so much higher; and the internal works are very expensive, should the general surface of the land be irregular. The main drain, which now extends a long way (between 5 and 6 miles), requires a great deal of attention, and consequent expense. The price paid under the Act of Parliament was 21*l.* per acre for the twice warping, but it has been found quite low enough.

There is a great difference between the flow and the ebb of the tide in the river Ouse and the neighbouring rivers, the flow only taking three hours, consequently running with great rapidity, and the ebb taking the remaining nine hours. The tides frequently flow as much as from 18 to 22 feet.

There seem to be no parallel instances of any improvements of the sort out of this district. Many and large tracts of land adjacent to rivers are occasionally benefited by the deposit left by land-floods, though small. The fertility of the lands adjoining the Nile *depends* upon its periodical floods; and immense deposits are occasionally made, consequent to a breakage of the banks of the Mississippi; but they are entirely from floods, and not from the action of the tides.

The general benefit to the country cannot but be very apparent, it having created a *steady* demand for labour throughout the whole of the district where these improvements have been carried on. Between 3000 and 4000 acres of land have been brought into a state of cultivation; and where formerly was a morass may now be seen the finest crops of wheat, clover, and potatoes. The original rent was in many instances nothing—now a rent is received of from 35*s.* to 50*s.* per acre.

The most general course pursued in the cultivation of the newly-warped land is to grip it every 4 or 5 yards, throwing the soil



taken out of the grips on to the land, amongst which, as soon as it is tolerably dry (the season, of course, permitting), oats and red and white clover, and rye-grass, are sown. The oats are not expected to be a good crop: they are merely sown as a protection for the seeds, as what is chiefly wanted is to have a good coating of seeds. They are sometimes pastured, and would be better to remain so for two years. They are then followed by wheat or potatoes.

I have now stated, to the best of my knowledge, in a general way, the method of warping. I will, in the next place, give a short statement of the quantity of land that has been warped by this individual drain.

An Act of Parliament was originally obtained for the purpose of warping about 1600 acres in the townships of Goole, Swinefleet, and Reedness; and the drain was opened in 1821. These 1600 acres were divided into three compartments, and were all of them warped once over before the end of 1826.

It was considered necessary to procure an Act of Parliament; for although the parties were very desirous of the improvement, yet there being some of it church property, some leasehold, and some under trust for schools, it required the clauses of an Act of Parliament strictly to define how and by whom the different payments were to be made. This Act gave power to the owners and trustees of lands adjoining the aforesaid townships, by giving certain notices, to avail themselves of certain of the clauses; and by subsequent agreements a great deal more was added to the original quantity.

The drain was extended along the edge of the peat-moss (which was too high to allow the water to flow any distance up it) towards the township of Eastoft, where a considerable tract of land was warped—about 800 acres in quantity. About 500 acres were warped in Witgift and Ousefleet; and about 250 in Crowle, Yorkshire moors. In addition to these, about 450 acres have been embanked this year in the townships of Haldenby, Fockerby, and Adlingfleet, and are now under the process of being warped, making in all—

1600	in Goole, Swinefleet, and Reedness.
800	„ Eastoft.
500	„ Witgift and Ousefleet.
250	„ Crowle, Yorkshire moors.
450	„ Haldenby, Fockerby, and Adlingfleet.

---

3600 acres.

XXII.—*On the occurrence of Phosphorite in Estremadura.* By CHARLES DAUBENY, M.D., F.R.S., F.G.S., Professor of Chemistry, &c., Oxford; and Captain WIDDRINGTON, R.N., F.R.S., F.G.S., &c., &c.

[A paper read before the Geological Society on Feb. 17, 1844.]

It was generally believed in this country, on the concurrent testimony of most standard writers on mineralogy, that an extensive formation of phosphate of lime existed in certain parts of the Spanish province of Estremadura.

Such an opinion was calculated to excite a lively interest, not only in the minds of men of science, but likewise amongst practical agriculturists; for whilst the former would speculate as to the causes which could have brought together so large a deposit of a material, elsewhere found only in small crystals, except in connexion with animal matter, and would feel curious to ascertain whether the rock in which it occurred contained within itself any evidences of the existence of organic life, which might account for its formation, the latter would be desirous of learning whether such a substance admitted of being employed in husbandry, as a substitute for bone-earth now so extensively applied as a manure, and if it did, what might be the facilities for procuring it, and the means of its conveyance to the coast.

On inquiring into the sources from which the writers in question had drawn their information with respect to the existence of phosphorite in Spain, we soon became satisfied, that the prevalent notions on the subject might be traced altogether to some communications relative to it, which had appeared in a Spanish periodical, entitled ‘*Anales de Historia Natural*,’ published at Madrid about the commencement of the present century.

The first and most important of these is by the celebrated chemist Proust, whose name would naturally pass in the world of science as a guarantee for any statement which he might put forth on his own authority.

His memoir, however, professes to be little more than the reprint of one existing in a periodical now difficult of access, entitled ‘*Anales del real Laboratorio de Quimica de Segovia*,’ which was published so long ago as the year 1788, and had also been translated in the ‘*Journal de Physique*’ of Paris for the same year.

Nevertheless the reinsertion of the article by the same chemist in a journal of the year 1800, might be fairly regarded as an evidence that its author was still persuaded with regard to its general accuracy.\*

---

\* From information received more recently, and still more from an actual visit to the place, we became convinced, that Proust’s speculations were either founded on the early account by Bowles, or had been taken up

Proust begins by remarking, that the occurrence of phosphate of lime, forming *entire mountains* in Spain, furnishes a proof, that phosphoric acid is a substance not confined to the animal kingdom.

He then alludes to a notice, having reference to the same rock, which had appeared in the work entitled 'Historia Natural de España,' by Bowles, in which we find the following passage:—

“From thence we proceed to Logrosan, a spot situated at the foot of a range of hills which runs from east to west, and goes by the name of the Mountains of Guadalupe. On leaving the said place, we meet with a vein of *phosphoric stone*, which crosses the Royal Road obliquely from north to south. This stone is of a pale colour, without taste, and, when scattered over live coals, emits a blue flame unattended with any smell.”—(p. 60.)

It is remarkable, that this property of phosphorescing when heated, which first attracted attention, and had caused it to be commonly employed for that purpose in the neighbourhood to amuse children, though no proof in itself of the presence of phosphorus, being possessed by fluor-spar and many carbonates of lime totally destitute of all admixture of phosphoric acid, should have been the one which in the case before us led to the suspicion of its true chemical composition, for Bowles, though he speaks of the mineral as a *phosphoric stone*, seems to have affixed this name to it solely from an observation of this one character, and not from any further examination into its composition.

Though deficient however in this respect, the report given by Bowles is much more correct in the geological information it conveys, than the accounts which have subsequently appeared, and if it had been duly attended to, would have prevented a great deal of the misapprehension which has since prevailed as to the abundance and physical position of the mineral.

Indeed, it may be doubted, whether any one of the persons who have written on this rock subsequently to Bowles, were at Logrosan at all, their memoirs in general being mere paraphrases of, and speculations on, the theme given in the short description we have above translated.

After thus presenting us with the report of the mineral which had been furnished him by Bowles, Proust proceeds to describe in the first place its physical characters, and then the extraction of phosphorus directly from it, which is done by exposing it to heat in connexion with charcoal. There is also, in p. 138 of the same volume, a statement of an analysis of this stone made by Pelletier and Donadei, at Paris.

---

merely from an inspection of the specimens he had received from the spot, which he had never himself seen. Owing to his reputation throughout Europe as a first-rate practical chemist, more importance was attached to his accounts than they really deserve.

Proust then introduces a passage, which is probably the one that has given rise to all the exaggerated statements handed on from one writer to another respecting this mineral.

“The stone,” he says, “occurs, not in veins, but in entire hills (collados enteros) in the vicinity of Logrosan, a village belonging to the jurisdiction of Truxillo, in the province of Estremadura. The houses and the walls which inclose the fields are built of it.” To this however he appends a remark, which, by showing that his preceding statement was based on hearsay evidence only, ought to have suggested some caution as to the degree of credit which deserved to be attached to it.

“But,” he says, “an actual inspection of the situation of these mountains, of their elevation, and their form, of their base, and the proportion they bear to those surrounding them, would have been more to the purpose than any conjectures that might be hazarded upon the subject. Not knowing, however, when I might have opportunity or time to survey them in person, I cannot at present undertake to give a more detailed account of their extent.”

He then concludes with some speculations as to the origin of the phosphoric acid contained in the mineral, which it seems unnecessary here to repeat.

The second memoir in the same work relative to this stone is by Don Christiano Heergen, but being confined to an account of the external characters belonging to the mineral, it neither corrects nor confirms the preceding statement regarding its extent and geological relations.

Such then, so far as we have been able to ascertain, was the amount of information to be derived from Spanish authorities, that gave rise to those statements respecting this mineral which have excited so much wonder and interest; and even at Madrid so little was known as to the real nature of the formation in which it occurs, that the first authority there, the head of the mining department, and himself a very able man, informed us that it constituted a vein (“filon”) in granite.

Hence all that we could learn respecting the rock in question was only calculated, from its very vagueness, to stimulate our curiosity, and to excite our imagination as to its real nature, and thus to create in us a mutual desire to visit in person a spot remarkable for the presence of so curious a substance.

And as it was intimated to us, that several leading members of the Royal English Agricultural Society entertained a wish to learn how far the site of the mineral in question might be hereafter reckoned upon for furnishing our fields with phosphate of lime, should other sources of its supply fall off, we flattered our-

selves that our researches might also prove of practical value, even if they should terminate merely in setting at rest a question which was exciting some interest at the time in quarters connected with agriculture.

Mr. Pusey, the late active President of that Society, entered warmly into our views, and through his kind intervention we obtained from the Right Hon. the Earl of Aberdeen, her Majesty's Secretary for Foreign Affairs, such letters as were calculated to afford us the requisite means of exploring this remote and little visited province with comparative comfort and security.

We are also equally bound to acknowledge the unremitting kindness and attention shown us during our stay in Spain, by our late Minister at the Court of Madrid, Sir Arthur Aston, by the Regent, and by the Spanish Government; indeed, our obligations are due to every individual, without exception, to whom we had occasion to apply, either for assistance or information, with reference to the object of our inquiries.

The phosphorite rock is correctly stated by Mr. Bowles to be situated at a short distance from Logrosan, which is a considerable village about seven Spanish leagues to the south-east of the town of Truxillo, in Estremadura.

It lies in that extensive clay-slate formation, which, with occasional masses of quartzite, constitutes the fundamental rock over a large portion of the country, from the time of our quitting the flat table-land of tertiary origin, which occupies the greater part of both the Castiles, till we descend the south-east escarpment of the Sierra Morena, and enter upon the plain of Andalusia.

We first met with rocks, which may perhaps be referable to this formation, near the village of Calzada de Oropesa, south of Talavera de la Reyna, and were led to conjecture that a change had taken place in the character of the substratum by the appearance of the country itself, which had become more rocky, more diversified, and, at the same time, somewhat better clothed with wood\* than before.

In the steep ravine through which the Tagus flows, near to the broken bridge of Almaraz, the rocks are observed to consist of a dark blue slate, and to be disposed in nearly vertical strata.

On ascending from thence to the Puerto de Miravete, the culminating point of this formation, such a bird's-eye view is obtained of the subjacent country to the south of us, as, by causing its minor inequalities of surface to disappear in the distance, is best calculated to convey to us a just general notion of its external configuration.

We perceive extending before us, so far as the eye can reach, a vast table-land, comparatively speaking, level; but on the one hand dotted over at intervals with certain isolated and generally conical knolls, and on the other intersected by low ridges with flattened summits, rising to the height of 300 ft. or 400 ft. above the general level of the plain.

---

\* Covered, however, chiefly by dwarf shrubs, amongst which the *Cistus ladaniferus* predominated.

Of the former, the few which we either visited, or could obtain information concerning, seemed to consist of granite, which would appear to have forced its way through the midst of the slates in several places, but not, as represented in the map of the French geologist, Le Play,\* to constitute a continuous stratum over the country in which it at intervals is seen protruding.

Thus granite forms the hill on which the old town of Truxillo is built, and extends for about a league into the plain on the road towards Logrosan, where it disappears under slates. The latter continue as far as a village distant about three leagues from Truxillo, which is built on granite.

We again find ourselves on this rock for about a mile, when it gives place to slates, which maintain their ground until we approach Logrosan. To the south of that village the granite a third time makes its appearance in a hill which rises to the height of 400 or 500 ft.; but, with this one exception, the whole of the undulating surface of country which occurs round the town, and from thence to the Monastery of Guadalupe, consists either of clay-slate or of quartzite.

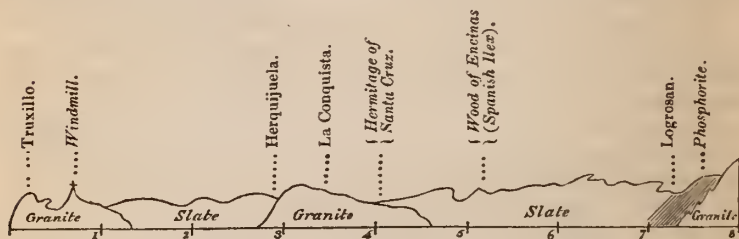

Section from Truxillo to Logrosan 7 Spanish leagues.

The granite is often so much acted upon by the weather, as to be separated into blocks, heaped one above the other, like the walls of some rude building of Cyclopean architecture; and to such an extent has the decomposition proceeded, that we are at first tempted to imagine that the blocks must have been transported from a distance, until reminded by their local occurrence, and their being piled up, so as to form considerable hills, that they are still *in situ*.

To the presence of the beds of quartz just before noticed may perhaps be attributed one feature in the physiognomy of the country we are describing, which has already been alluded to in this memoir, and which indeed has not escaped the attention of other geologists. We mean those low ridges of hills, with flattened summits, which here and there intersect the comparatively level surface of the clay-slate formation.

These summits are reported by Le Play to be commonly composed of quartz; and we are inclined to credit his statement, from what we remarked respecting the character of those above Almaden: nor does it seem improbable that the refractory nature of this rock may have enabled it to resist the action of those agents of decomposition that have worn

\* Annales des Mines, for 1836.

down the surface of the slates contiguous, and thus to maintain more nearly its original level, just as in the Tyrol the incoherent materials, which have resulted from the *detritus* of older rocks, remain standing up to the height which they possessed when first deposited, wherever there happened to lie at the top of them a mass of stone large enough to shelter the parts underneath from the action of rain.

The beds of quartzite, which occur subordinate to, and interstratified with, the slate, present many varieties of structure, being sometimes compact, sometimes granular, possessing occasionally a brecciated character, and in other places hardly distinguishable from a fine-grained sand-stone.

The clay-slate itself, which constitutes the prevailing rock about Logrosan, is sometimes a dark blue homogeneous fissile schist; sometimes soft and talcose: it at other times contains scales of mica disseminated through it; and at others consists of alternating layers of compact felspar and of talc. Brecciated varieties also occur, which, but for their fissile character, we might refer to quartz rock; but, in fact, there is no decided line of demarcation between the two.

The most important question relative to this and its concomitant rocks relates to their age, and here the evidence is chiefly negative.

During our excursions, about Logrosan, in the mountains of Guadalupe, and elsewhere, we met with no vestige of shells, or of other kinds of organic remains, nor could we learn that any such had been discovered in them.

Le Play, however, states that in the neighbourhood of Almaden slate rocks occur, in which shells are abundant; and he specifies the *Spirifer attenuatus* of Sowerby, and a *Terebratula* with small sides and large convolutions, as having been there met with.

We were also told, during our stay at Almaden, by some of the intelligent miners connected with that establishment, that Trilobites had been found in the same neighbourhood; so that no doubt need be entertained that rocks occur thereabouts which we may refer, as indeed the Spanish authorities at Madrid are disposed to do, to the Silurian epoch.

But whether the rocks surrounding Logrosan are precisely of the same age as about Almaden, or whether, as Le Play represents, those near the latter place consist of a more modern fossiliferous formation superimposed upon an ancient one in which fossils have not yet been discovered, must remain undecided, until a sufficiently extended and minute survey has been made of the entire province, either to detect the presence of petrifications in them, or to justify us in pronouncing upon their absence.

In many cases, intervening between the granite and clay-slates, occurs a formation of a more crystalline character, which we found to assume the appearance of mica slate between Almaden and Cordova, near its contact with the granite of Viso, and which M. Le Play reports to be in other cases marked by the presence of crystals of chiastolite (*schist maclifere*).

It is in this clay-slate formation, which roundabout Logrosan seems remarkably compact, that the deposit of phosphoric occurs.

It may here be traced, either along the surface, or immediately underneath the soil, for a distance of nearly two miles, and in a direction from N.N.E. to S.S.W. ; so that, if we may depend upon our own observations on this point, it runs conformably to what appears to be the direction of the rocks themselves about Logrosan.

Granting this to be the case, its position\* would lead us to regard it as interstratified with clay-slate ; and we shall therefore venture, in the remaining part of this memoir, thus to consider it, although aware that it has been spoken of by Le Play as intersecting the formation, and that the general direction assigned to the rocks of the country by that geologist is not in accordance with what appeared to us to belong to those immediately around Logrosan.

At its south-western extremity it seems to terminate not far from the base of the granite hill before noticed, but a little to the east of it.

This hill, indeed, on the side nearest to the phosphorite, consists of clay-slate, apparently heaved up by the granite, which constitutes its summit, as well as its north-eastern declivity ; but the deposit in question has no connexion with the latter rock, as was reported to us at Madrid to be the case.

At this, its south-western termination, the width of the deposit is nearly 16 ft. Of its depth we are unable to speak, as it has nowhere yet been fathomed to a greater extent than about 10 ft. ; but it may be inferred, from its being found on the surface for nearly two miles, notwithstanding that the country traversed by it presents an undulating outline, with alternate elevations and depressions, amounting to at least 50 ft., that it penetrates to a considerable depth into the substance of the rock.

We traced the course of the mass from this point for about a quarter of a mile over a ploughed field, guided by the projecting portions of the mineral which protrude at intervals through the vegetable mould, or by the fragments of it which have been brought up by the plough.

We thus followed it up a gentle acclivity, and then again down a corresponding descent, till we reached the road leading from Logrosan to Guadalupe, where it was first noticed by Bowles.

Here, as the rock had been already worked, we had the best opportunity of examining it ; and accordingly, although we caused excavations to be made in one or two other places, in order to satisfy ourselves that its general characters were the same throughout, yet our knowledge of it is principally derived from this one locality.

In this place it crosses the road obliquely from N.N.E. to S.S.W., interstratified with a rock consisting of a compact form of clay-slate, in which the slaty cleavage was indistinct, and which is disposed in almost vertical strata, inclining however from the granite of the adjoining hill, which has been already noticed.

The width of the phosphorite deposit at this spot is not more than 7 ft. ; and it is to be remarked that, out of this mass, the central portion only,

---

\* We say its position, because its mineral structure and general appearance certainly give it very much the character of a vein, as will appear from the description given below.



to a thickness of about three feet, consists of phosphate of lime in a state approaching to purity.

The remainder is made up of alternate layers of hornstone and phosphorite, disposed in an agatiform manner round certain nuclei of crystallization, the respective zones of the pure white variety being often separated, one from the other, by streaks or thin layers of the same, coloured with oxide of iron.

In consequence of the mode in which the materials filling up the fissure have been deposited round particular centres, to which they are most forcibly attracted, void spaces frequently exist between the several concretions which constitute the entire mass.

Where this has happened we often observe a mammillated structure, like that of certain chalcedonies, on the external surfaces of the mineral, with which mode of formation, indeed, the structure of the internal layers appears on examination to accord.

Crystals of quartz are occasionally found coating the external layers, and likewise lining the walls of the cavities in them.

If we examine the particular structure of any one of those zones of phosphorite, which are wrapt round each other in the manner described, we shall find them often exhibiting a *stellated* arrangement, consisting of an assemblage of fibres or crystals radiating from a centre, as is the case in wavellite, for which mineral a small specimen of phosphorite might perhaps at first sight be mistaken.

The external characters of the mineral itself have already been sufficiently described in works on mineralogy.

The description given of it by Beudant defines in a few words, but with sufficient exactness, its peculiar structure, excepting that, misled by the erroneous notion as to its constituting "entire mountains," he represents as beds what are nothing more than layers or zones, running in a direction conformable to those of the phosphorite, and as veins, those which penetrate them transversely.

"The apatite of Estremadura," he says, "exists in fibrous, dendritic, stalactitic, testaceous deposits, either intermixed with quartzous beds, or intersected by veins of quartz, constituting entire hills near Truxillo, and employed as a building stone."

The inaccuracy of the former part of this concluding passage we have already sufficiently adverted to; the latter appears to have no better foundation than the use made of a few blocks of it close to the spot in which it occurs, in the construction of a wall which separates the road from an olive plantation contiguous.

The deposit indeed is traversed by the road, and must at one time have formed an inconvenient rise across it. It had consequently been blasted or broken down, and as the fragments have been applied to patch the walls round about, we may account for the fable as to houses having been constructed of this material. At Logrosan the common building stone is the slate on which the town stands: it is dark blue, excessively hard and compact, with veins of quartz intersecting it.

The phosphorite differs, of course, in composition in different parts of the deposit; but no specimen which has been examined appears perfectly free from foreign matter, there being, in every instance, traces of

iron, partly at least in the state of peroxide, together with one or two per cent. of silica, and a large proportion of fluoride of calcium.

The following are the results of an analysis made of one of the purest specimens that could be selected, or, we should rather say, the mean of two analyses, in either of which similar quantities taken from the same specimen were operated upon, the results of the two agreeing nearly together :

Silica . . . . .	1·70
Peroxide of iron . . . . .	3·15
Fluoride of calcium . . . . .	14·00
Phosphate of lime . . . . .	81·15
	100·00

There was likewise 0·2 per cent. of chlorine, united with calcium, present in the mineral.

The silica and iron are probably accidental ingredients; but the fluoride of calcium is so commonly associated with phosphate of lime, that it may be regarded as essential to the mineral in question.

It is known to occur, not only in mineral apatite, but also in a variable, but generally small proportion, in bones, and the enamel of teeth, both fossil and recent;\* thus appearing to perform some hitherto unascertained office in the animal economy, so that a wonderful provision of nature seems to be unfolded to us, when we observe, treasured up in the older rocks, as if in anticipation of the wants of the future creation, a dépôt, not merely of an ingredient, like phosphate of lime, which was so requisite for building up all the solid parts of animals, but also, in constant association with it, a certain proportion of fluuate of lime, which appears in like manner to enter into the composition of the same fabrics.

It will be remarked, however, that the per-centage of fluuate of lime, which we have set down as existing in the mineral, is much larger than that present in any other specimen that has before been analysed.

Thus Gustavus Rose gives the analysis of 7 varieties of apatite, taken from different localities, in which the largest proportion of fluoride of calcium discovered was 7·69 per cent., the smallest being only 4·59.

We should therefore have been reluctant in stating a result so little conformable with those of this distinguished chemist, had not there been a very near accordance between the results obtained from two specimens which were examined; and also if we had not considered that the varieties of apatite which Rose analysed were probably all crystallized, whilst those of the Spanish phosphorite submitted to analysis were in a compact or amorphous condition.

The remarks just made have reference to the colourless or purer variety of the Spanish phosphorite, through which, as already observed, are disseminated streaks or thin zones of a dark brown variety. The latter was found to owe its colour to peroxide of iron, here present in a

\* See a paper on the occurrence of fluorine in recent as well as in fossil bones, by Charles Daubeny, M.D., &c., in the Memoirs of the Chemical Society, Part 9.

proportion varying from 15 to 20 per cent. ; but neither manganese nor any other new substance could be discovered in it.

The quartzous veins, which alternate with the phosphorite, especially near the sides of the deposit, though consisting principally of silica, nevertheless contain iron, and a trace of phosphate of lime.

Other small seams of phosphorite proceed to some distance obliquely out of this, the main deposit, into the clay-slate rock ; but none consisting of this mineral, unconnected with the one already mentioned, could we hear of, either in the neighbourhood of Logrosan, or in any other locality.

From the spot crossing the road above mentioned we traced the deposit in a S.S.W. direction across an olive plantation, down a gentle declivity, until we finally lost sight of it in the low ground beyond, about a mile from the road. Of course the phosphorite was only visible at intervals through the covering of soil ; but the occurrence here and there of blocks or fragments of the mineral, and the conformity between the direction in which they appeared, and that of the previously observed portions of it, left no doubt in our minds as to this point.

The phosphorite throughout its whole extent is extremely indestructible, resisting the influence of the atmosphere, as well as of all the other agents of decomposition to which its loose fragments had been subjected.

In none of those which we saw, whether on the tops of walls, or partially buried under the earth, however long they may have been exposed to the weather, was the slightest change discoverable.

We were therefore anxious to ascertain, whether any influence had been exerted upon the suitableness of the soil for agricultural purposes by the presence in it of this mineral.

The soil itself bore the character of a loam, according to the definition given in the Table on the Classification of Soils, published by one of the authors of this memoir, in Vol. 3, Part 1, of the Journal of the Royal English Agricultural Society.

1000 grains were separated by a mechanical analysis, conducted according to Mr. Rham's method, into—

	Grains.
1. Coarse pebbles . . . . .	375
2. Minute do. . . . .	88
3. Coarse powder . . . . .	388
4. Impalpable powder passing through the finest sieve . . . . .	140
Loss being . . . . .	9
	1000

Of the latter 100 grains were examined, and found to consist nearly as follows:—

Of Water . . . . .	5·0
Vegetable matter . . . . .	4·5
Sand . . . . .	50·0
Clay much charged with peroxide of iron . . . . .	40·0
Carbonate of lime there seemed to be merely a trace.	

Now a portion of this soil, after having been carefully freed from all the loose pebbles, &c., which it contained, being taken from the portion which had passed through the finest of the sieves, was carefully examined, in order to ascertain the presence in it of phosphate of lime, but only the merest trace of that substance could be discovered, less indeed than 1 grain in 2lbs. of the soil.

As this is not a chemical society, we refrain from entering upon the details of the method which was pursued, but believe that it would be regarded as conclusive, so far as relates to the detection of any considerable amount of this ingredient; and with regard to the small proportion which did exist, it might have been easily derived from the attrition of the fragments of phosphorite which were mixed with the soil, as we had no means on the spot of sifting it with any accuracy.

It may therefore be fairly considered that the result of this examination confirms the conclusion with regard to the naturally slight tendency to decomposition in the mineral, which we had been led to entertain from our observation of it on the spot.

The soil brought home for examination was taken from various parts of a corn-field, immediately along the course of the deposit, which we were told was in itself by no means productive, but required to be improved by occasional top-dressings of stable-dung.

The presence of the phosphate does not, therefore, appear in this instance to communicate fertility; but the compact texture of the stone may perhaps render it in its natural state but little adapted for being secreted by plants.

It now only remains that we should state, in conclusion, the reasons which have induced us to occupy so much of the time of this Society in the description of the deposit alluded to. It has been conceived then to deserve a more particular notice.—In the first place, because it constitutes, we believe, a solitary instance of a rock of any magnitude or extent, as yet known, in which phosphate of lime occurs as the prevailing ingredient.

2ndly. Because the deposit not only contains in itself no traces of any organic matter, and possesses a crystalline structure entirely inconsistent with an organic origin, but also would seem, so far as our present knowledge extends, to lie in the midst of materials from which the evidences of animal life, if indeed they ever existed in them, have been entirely obliterated; for even if the fossiliferous slates of Almaden should be determined to belong to the same epoch with those about Logrosan, it must be recollected that they are at least fifty miles distant from the latter, whilst the existence of phosphate of lime in other instances, setting aside a few crystals of apatite occasionally met with in mineral veins, seems always referable to the presence either of animal exuvixæ, or of animal excretions in its immediate neighbourhood.

3rdly. On account of the exaggerated reports that had been

given of its extent, which, though contradicted by M. Le Play, in the memoir already referred to, still held their ground in the public mind, as the cursory manner in which that geologist alludes to the phenomenon was so far from setting the question at rest, that it even left us in doubt whether he, any more than his predecessor Proust, ever visited the locality.

The former indeed underrates the magnitude of the deposit, as much as the latter exaggerates it; for a rock varying from 7 to 16 feet in breadth, traceable for nearly two miles along the surface of the ground, and extending into the earth to a great, though as yet an unascertained depth, cannot be regarded as either unimportant or inconsiderable.

4thly. Because a statement of its chemical and mineralogical characters, as well as of its relations to the rock in which it occurs, may lead to the discovery of it in other less distant and more accessible localities, and thus be the means of supplying a new source of phosphate of lime for agricultural purposes.

Lastly. We have been induced to enter more fully into its nature and relations in consequence of the interest which it has lately excited amongst agriculturists.

That it would prove equally efficacious as a manure with phosphate of lime derived from animal sources, must not indeed be taken for granted too readily, until this point has itself been made the subject of direct experiment; but there was a sufficient probability that such would prove the case, to induce us to take some trouble in ascertaining the price at which it might be procured, and the facilities that might offer for transporting it to our own country.

Were the Tagus now navigable up to Toledo, which, during the period when the crowns of Spain and Portugal were conjoined in the person of Philip II., it is said to have been the intention of the government to render it, two days' journey in the light carts of the country would convey the material to the least distant point on that river, near the broken bridge of Almaraz.

But at present, such is the retrograde state of things in the Peninsula, that the Tagus is not now navigable even so far as the frontiers of Portugal.

A still shorter distance separates the site of the phosphorite from the Guadiana, but much requires to be done before that river can be navigated even up to Badajoz.

At present the only practicable route by which to transport the mineral in question to the coast seems to be the one which we ourselves had recourse to, namely, that to Seville, a journey for mules of at least six days; this latter mode of conveyance, however, though the most convenient one for small quantities, is so expensive, as to be quite out of the question on the great scale,

and the cheapest method would be that of resorting to the bullock cars of the country, which are extensively used in Estremadura, but only travel in troops together.

Should, however, the political difficulties, which the Portuguese government at present interposes to the transmission of goods by the Tagus, be hereafter removed, there seems no reason to doubt, but that it might descend that river at certain periods during the floods of the winter or of spring.

But although no prospect can be held out as to this mineral being profitably employed as a manure, unless the political condition of the Peninsula should become very different from what it is at present, and the expense of obtaining bones or other substitutes for them happen to be greatly augmented, still we do not regret having personally examined the locality, both because by so doing we have set, as it were, at rest the question that had been mooted with respect to the uses to which this material might admit of being applied, and also because we have been enabled thereby to procure a quantity of it sufficient for making trial of its virtues when applied to land capable of deriving benefit from bone manure; thus, as we hope, obtaining some data which may assist us hereafter in the determination of the interesting problem, as to whether the mechanical condition in which mineral substances are presented to the secreting organs, exercises any important influence upon their adaptation to supply the demands of the growing vegetable.

---

XXIII.—*Instance of the advantage of Subsoil-ploughing, in addition to Draining.* By GEORGE TURNER.

*To Philip Pusey, Esq.*

DEAR SIR,

I SEND you a short account of draining and subsoil-ploughing. At Michaelmas, 1839, a farm came into my occupation in the parish of Cadbury, ten miles from here, on which there was about forty acres of land divided into six closes, in a very rough state, covered principally with furze, brambles, and rushes, and the greater part very wet. The soil, as is often the case in Devonshire, various, but consisting chiefly of about 6 inches of tolerably good mould on a rubbly or gravelly clay. I immediately began with a field of 6 acres, by cutting drains at various distances, from 3 to 5 feet deep, according to circumstances, getting, if possible, through the clay into the gravelly substance, and filling them to within 18 inches of the surface with well-broken stones, taken from a quarry on the farm: and I should here state that the

greater part of the land wanting draining, *in this county*, is rather steep, springs of water issuing out of the sides of the hills even to the tops; consequently, the system of cutting the drains in the direction of the fall is not applicable in these cases, but the drains must be cut in a lateral direction, so as to tap or to take the line of springs, with upright or main drains to carry off the water. Having thoroughly drained it during the winter, early in the following spring I pared it thin and burnt it, of course grubbing up the brambles and furze. I then put about 100 bushels of lime to an acre, and spread it with the ashes, ploughing all down as thinly as possible in the beginning of June, and sowing Swedish turnips, which was an excellent crop, and which I drew off for fattening beasts in the yard. In the month of February, 1841, I subsoil-ploughed it, and in April planted mangold wurtzel with about 15 tons of farm-yard manure to an acre, from which I took in November upwards of 30 tons of mangold wurtzel an acre; then ploughed it; and in March, as I wanted this field for permanent pasture, sowed 3 pecks of rye grass, 6 lbs. of red, and 3 lbs. of white clover to an acre, with a bushel of spring tares, and I have had an abundance of grass ever since that time, mowing upwards of two tons of hay per acre, the only manure used since being 40 bushels of soot an acre. At present it is looking as luxuriant as any thing can be—*except about a quarter of an acre, which was not subsoiled, and which is not half as productive as the other parts of the field.*

The remainder of the land I have managed much in the same way, except sowing on some parts common turnips, feeding off part with sheep, and sowing wheat, from which I have reaped, *where subsoiled*, abundant crops; and in no instance has the clover failed, or have I been disappointed in my expectations.

These 40 acres of land, before I began my operations, were valued at only 10s. per acre: at present it is worth more than 30s., and the crops have well paid for the rent, taxes, manure, and labour.

I should also observe that, in my opinion, all land of the above description that has not been ploughed for many years, and that is to be reclaimed, ought, as soon as it has been drained, to be pared, burnt, and limed, whereby a crop of turnips is insured, an immediate return made, and the land permanently improved. It is also necessary that lands whereon furze, brambles, &c., were growing, should be kept in tillage for four or five years, so as completely to destroy them; and I know of no better succession of crops, than—1st, turnips; 2nd, mangold wurtzel; 3rd, wheat; 4th, tares, fed with sheep, and followed by turnips; then barley or oats, with grass seeds. On one field I put 50 bushels of soot an acre instead of dung, and had a good crop of mangold; and for the turnips, after wheat I generally drill 20 bushels of bones

(where dunged for mangold); but where soot was used for the mangold, I think it best to put dung for the turnips.

In conclusion, I can only say, that in this county there is a quantity of old grass land, just in the state that mine was, producing grass only about six months in the year, which, if drained, subsoil-ploughed, &c., would produce more of the necessaries of life in five years than in twenty previous ones: whereas a vast number of acres are quite over-tilled, and would be more profitable if allowed to rest a year extra when in grass, and in good condition.

Should you, Sir, think these remarks worthy a place in the Journal of the Royal Agricultural Society, or otherwise, I shall be satisfied, and remain,

Dear Sir,

Your most obedient servant,

GEORGE TURNER.

*Barton, near Exeter, October 15, 1844.*

XXIV.—*A few Remarks on the large Hedges and small Enclosures of Devonshire and the adjoining Counties.* By JOHN GRANT, Surveyor and Land Agent.

EVERY practical farmer coming into Devonshire for the first time is struck with the fertility of the soil and the genial climate with which the county is favoured. He may not be equally struck with the quality of the farming, though this has of late made an immense stride; but he is certainly astonished at the small quantity of the produce of the soil returned per acre, a much greater being produced in districts immeasurably behind Devon in natural advantages. A superficial observer places this to the credit, or rather discredit, of the farmer: the practical man is not long in discerning that *not the least* of the causes is the baneful effect of the high hedgerows and small enclosures, which add so much beauty to the scene at so great a cost to the landlord and tenant.

Struck with these reflections I resolved to make some actual measurements, in order that the landed gentry and agriculturists of the county might see the full extent of the evil.

At the present time there is a strong tendency towards improvement in farming; the general opinion being that none of the sciences is in so backward a state. But no very great advance can be made in this, and a great part of the adjoining counties, so long as the enclosures are so small, and the hedges so many and so large, that upwards of 7 per cent. of the land is occupied, besides that which is otherwise injured, by them. "What," it has been asked me by more than one intelligent and extensive farmer, "is the use of our being told that we should



study practical chemistry, and copy the example of farmers in better cultivated districts, if we are not allowed to enlarge our fields by taking down those immense banks, or even to cut down the wood growing on them but once in seven years, and then only that which has not been previously marked for rearing? Look at what I lose from the shade of these hedges and trees, besides what they actually occupy. For nearly a ridge wide on each side the corn is hardly worth reaping." And who can deny that this is discouraging? Is it not to be seen everywhere in the county, and every year the same? The necessity of making extensive alteration in this respect will, I trust, be evident by consulting the following Table, which gives the total number of acres in each of ten parishes, all within a circuit of 15 miles of Exeter, and extending over a district of 20 miles; varying from 700 to 9000 acres, and amounting to nearly 37,000 acres. It also gives the number of miles of hedge, the number of acres and per centage occupied by them; the number of cultivated enclosures of different sizes above half an acre, all under that size being left out as gardens, &c. No enclosures are taken into account but such as are cultivated by the farmer; that is, such as are arable, pasture, or orchard. Coppices, woods, plantations, &c., are not included, as these are in most cases in the hands of the landlords. The tithe apportionments have been my authority for the number of fields of different sizes. Fractions have been as much as possible avoided, as being unnecessary, and to prevent confusion. In some of the parishes there are parks, commons, and large woods, which, if deducted, would make the per centage much greater on the portions which are divided.

In the Table it is shown that in the parish of Huxham, containing 762 acres, there are 34 miles of hedge, which occupy 54 acres, being 7 per cent., or 1 acre in 14. There are 55 in every 100 fields under 4 acres; 9 of 10 acres and upwards, being 142 acres in all: and 1 field larger than 10 acres in every 16 fields, or in 100 acres. There is a portion of the parish, containing 84½ acres, in which there are 5 miles of hedge, containing about 8 acres; being 9½ per cent., or 1 in 10½. Lately there have been more than 3 miles of hedge taken down, thus saving between 5 and 6 acres.

In the parish of St. George's Clyst, containing 1040 acres, there are 52 miles of hedge, occupying 83 acres, being 8 per cent., or 1 in 12½. There are 126, or about half the number of fields, under 3 acres; 163, or 61 of every 100 fields, under 4 acres; 9 of 10 acres and upwards: being 264 in all; and 1 field larger than 10 acres in every 30 fields, or in 115 acres. In the upper half of this parish the hedges occupy 10 per cent., but the large marshes in the lower half reduce it to 8 per cent. If we

take  $78\frac{1}{2}$  acres in one part of the parish, we find 6 miles of hedge, occupying between 9 and 10 acres; being 12 per cent., or 1 in  $8\frac{1}{4}$ .

In the parish of Rewe, containing 1341 acres, there are 65 miles of hedge, occupying 104 acres; being  $7\frac{3}{4}$  per cent., or 1 in  $12\frac{9}{11}$ . There are 56 between three and four acres; being 207, or 64 in every 100 fields under 4 acres; 8 of 10 acres and upwards; being 324 in all: and 1 field larger than 10 acres in every 40 fields, or 170 acres. If we take a separate portion of the parish, containing 81 acres, we find  $5\frac{1}{2}$  miles of hedge, occupying 9 acres, being one-ninth. This part of the parish is rented at 40s. per acre, and the outgoings are from 12s. to 15s. more; so that there is an annual loss of, at least, 23l. on these 81 acres.

In the parish of Poltimore, containing 1710 acres, there are 59 miles of hedge, occupying 94 acres; being  $5\frac{1}{2}$  per cent., or 1 acre in 18. There are 168, or 56 in every 100 fields, under 4 acres; 259 under 10 acres; 38 of 10 acres and upwards; being 297 in all; and 1 field larger than 10 acres in every 8 fields, or 45 acres. The park and roads in this parish amount to 140 acres. In a part of the parish, containing 115 acres, the hedges occupy  $10\frac{1}{4}$  per cent.: in another part containing 280 acres, they amount to 6 per cent.; but in another, containing 327 acres, they are only  $2\frac{1}{2}$  per cent. Before the apportionment of this parish was made, five years ago, Lord Poltimore's steward took down on a farm of less than 200 acres 8 miles of hedge, and thereby added 15 acres to the productive portion of the estate. Since that time there have been removed in the parish  $6\frac{1}{2}$  miles of hedge, saving about 10 acres; so that there have been taken down in the last five years, besides what were taken down before, on Lord Poltimore's property in the parishes of Huxham and Poltimore, 10 miles of hedge, and from 15 to 16 acres gained: as much as would be an allotment of a third of an acre to each of about 50 labourers. On account of these alterations the number of enclosures of 3, 4, and 5 acres would be much fewer, and those of a larger size greater, than is given in the Table. Whilst in the parish of Rewe, containing 1341 acres, there are 65 miles of hedge: in Poltimore, which is nearly a half larger, there are only 59; and if we deduct the  $6\frac{1}{2}$  since taken down, only  $52\frac{1}{2}$  miles. It will also be perceived that this, containing 1710 acres, contrasts favourably with the other parishes, having about as many enclosures above 10 acres as are in the five parishes of St. George's Clyst, Rewe, Clisthydon, Feniton, and Talaton, containing 8293 acres: also with the parishes of Silverton and Broadclyst, having two-thirds as many enclosures above 10 acres as the latter parish, which is 9188 acres.

In the parish of Clisthydon, containing 1725 acres, there are

86 miles of hedge, occupying 138 acres, being 8 per cent., or 1 in  $12\frac{1}{2}$ . There are 228, being 56 in every 100 fields, under 4 acres; 403 under 10 acres; 4 fields of 10 acres and upwards, being 407 in all; and 1 field larger than 10 acres in every 102 fields, or in 431 acres.

In the parish of Feniton, containing 1822 acres, there are 95 miles of hedge, occupying 152 acres; being  $8\frac{1}{3}$  per cent., or 1 acre in 12. There are 261, or 60 in every 100 fields, under 4 acres; 443 under 10 acres; 6 of 10 acres and upwards, being 449 in all; and 1 field larger than 10 acres in every 75 fields, or 304 acres.

In the parish of Talaton, containing 2365 acres, there are 114 miles of hedge, occupying 182 acres; being  $7\frac{3}{4}$  per cent., or 1 in  $12\frac{9}{10}$ . There are 341, or 62 in every 100 fields, under 4 acres; 535 under 10 acres; 13 of 10 acres and upwards, being 548 in all; and 1 field larger than 10 acres in every 42 fields, or in 182 acres. The divided part of this parish would appear much worse if the common, park, and roads were deducted, as they amount to 180 acres, or more than one-twelfth of the whole.

In the parish of Silverton, containing 4714 acres, there are 222 miles of hedge, occupying 356 acres; being  $7\frac{1}{2}$  per cent., or 1 in  $13\frac{1}{4}$ . There are 587, or 55 in every 100 fields, under 4 acres; 1031 under 10 acres; 35 of 10 acres and upwards; being 1066 in all; and 1 field larger than 10 acres in every 30 fields, or in 134 acres.

That 356 acres, or an average of  $7\frac{1}{2}$  per cent., should be occupied by hedges in this one parish seems bad enough; but there are parts of it much worse in proportion. In 147 acres at the south-east end, which I surveyed, I found more than 9 miles of hedge, occupying  $14\frac{1}{2}$  acres, or fully 10 per cent. When to this is added the further injury otherwise caused by these hedges, as mentioned elsewhere, it will be self-evident how utterly impossible it must be for the farmer of such densely wooded districts to compete with those who are living on more open, and therefore more productive, farms.

In the parish of Broadclyst, containing 9188 acres, there are 383 miles of hedge, occupying 613 acres, being  $6\frac{2}{3}$  per cent., or 1 in 15 acres. There are 1176, or 60 in every 100 fields, under 4 acres; 1913 under 10 acres; 57 of 10 acres and upwards; being 1970 in all; and 1 field larger than 10 acres in every  $34\frac{1}{2}$  fields, or 161 acres. The per-centage occupied by hedges in this parish is  $6\frac{2}{3}$ , or 1 in 15; but if we were to deduct 977 acres for large woods, the park, roads, &c., it is evident that the per-centage to be allowed for hedges on what would remain would be very much increased. I surveyed a part of the parish containing 133 acres, which is divided into 44 enclosures, averaging 3 acres, on

which there are  $8\frac{1}{2}$  miles of hedge, occupying  $13\frac{1}{2}$  acres, or fully 10 per cent. The hedges in this parish would make a bank of earth between the capitals of England and Scotland.

In the parish of Crediton, containing 12,309 acres, there are 541 miles of hedge, occupying 866 acres; being 7 per cent., or 1 acre in  $14\frac{1}{4}$ . There are 1455, or 58 in every 100 fields under 4 acres; 148 of 10 acres and upwards, being 2530 in all; and 1 field larger than 10 acres in every 17 fields, or 83 acres. The hedges of this parish would more than extend from the Land's End through the centre of England to Edinburgh in Scotland.

The result of this examination of ten parishes, containing 36,976 acres, being an average size of about 3,700 acres, is, that there are 1651 miles of hedge; about half as long again as the famous wall of China; or sufficient to hedge round the whole of England with an immense bank of earth, and occupying 2642 acres; being  $7\frac{1}{7}$  per cent., or 1 acre in 14; that 805, or 10 in every 100 enclosures, are between  $\frac{1}{2}$  an acre and 1 acre:—that 1347 are between 1 and 2 acres, being 2152, or 27 in every 100 enclosures; more than a fourth being under 2 acres:—1293 between 2 and 3 acres, being 3445, or 43 in every 100 enclosures under 3 acres: 1220 between 3 and 4 acres, being 4665, or 58 in every 100 fields under 4 acres: 1015 between 4 and 5 acres, being 5680, or 71 in every 100 being under 5 acres: 743 between 5 and 6 acres, being 6423, or 80 in every 100 under 6 acres: 511 between 6 and 7 acres, being 6934, or 87 in every 100 under 7 acres: 357 between 7 and 8 acres, being 7291, or 91 in every 100 under 8 acres: 231 between 8 and 9 acres, being 7522, or 94 in every 100 under 9 acres: 148 between 9 and 10 acres, being 7670, or 96 in every 100 are under 10 acres: 327 are upwards of 10 acres, being about  $2\frac{1}{2}$  in every 100 fields; or 1 field larger than 10 acres in every 113 acres; and making in all 7997 enclosures. Thus it will be seen that whilst 87 in every 100 enclosures are under 7 acres, only 13 in every 100 are larger than 7 acres. With such a disproportionate number of small fields the immense loss sustained may be still further shown by the following calculations, which I made from a great number of measurements, the average being taken. By the kind of hedges generally used, on fields of the first size given, averaging  $\frac{3}{4}$  of an acre, the loss by hedges is 17 per cent.; on fields of the second, between 1 and 2 acres, the loss is 12 per cent.; by those of the third size, between 2 and 3 acres, the loss is 10 per cent.; on fields between 3 and 4 acres,  $7\frac{1}{2}$  per cent.; on fields of 10 acres it is about 4 per cent. The per centage of course varies very much with the shape of the field and the thickness of the fence; but by this it will be seen that when the fields average 10 acres,

the hedges being of the same kind, the loss is only half of what it is when they are 3 acres and upwards.

The evils of the present system of dividing farms, general over this and great part of the neighbouring counties, may be thus summed up. The hedges occupy in some cases fully 10 per cent., but on an average of these ten parishes,  $7\frac{1}{7}$  per cent., or 1 acre in 14. They shade and injure at least half as much; most persons, landlords as well as tenants, whose opinion I have asked, say *quite* as much more. They harbour birds and vermin which injure the crops; and that this is no small evil any one may satisfy himself, by going into a field just before harvest. They are nurseries for weeds; they prevent that free circulation of air so necessary to the healthy growth of plants as well as animals: they are obstacles to the drainage of the soil, the roots found in them frequently choking up the drains. They are expensive to erect, as well as to keep in repair; the expense of new hedges in labour and planting being about 3s. 6d. per perch, and that of keeping them in order about 5 per cent. of the rental. The soil on each side of them is generally thinner, from the materials for making the banks being taken from it. So many small enclosures require a much greater number of gates, which have to be kept up and renewed: and they cause a much greater number of small lanes and cart-tracks leading from one place to another. The damage from shade is also very much greater from those hedges which run east and west. To do the least damage and to be of the greatest service as shelter, our most prevalent and severe winds being from the west and south-west, hedges should be made, and the long way of the fields be from north to south; for the same reason that Loudon lays it down as a rule in building a house, to make the diagonal line in that direction; namely, because the sun thus shines on every side of it every day. The fences being in most cases crooked, and the fields of every shape but right-angled, the labour of every operation of the farm, particularly ploughing, is most materially increased. The parishes of Huxham and Poltimore will contrast favourably with the others in this respect. This evil is anything but a trifling one, especially when to it is added the labour caused by the roots of trees which shoot out into the fields. In any parish this is felt; but in such a parish as Rewe, where there is much timber, one may see, when the ground is laid open by the plough, that *the roots of the trees cross each other from opposite sides of the field*. These roots must abstract much of the nutritive qualities of the ground. As an instance of how fast the root of a tree grows, the following fact was mentioned to me by a gentleman of Crediton:—"A drain which had been made only the year before was found to be

stopped up; and on examination the cause was discovered to be the root of an elm, which had grown into the drain more than 30 feet."

Having pointed out the evils of the existing system, I may be asked how it can be remedied, especially without inarring the beauty\* of this county, to which these luxuriantly-wooded hedges add so much. To this I would say that such a landscape gardener as the late Mr. Loudon, if asked to dispose of this timber in the most effective manner, would not have been likely to lay it out in long straggling hedgerows, but in elumps, belts, and woods, which would serve for shelter and give the best effect. Fences could then be of a much simpler and inexpensive kind. Where stall-feeding is practised there need not be anything lost by hedges; as I have seen farms without any fences but that which surrounded and divided them from the adjoining farms, a furrow being all that separated one crop from another. But even where this system is not adopted there are several methods whereby farms may be sufficiently divided, and the whole or greater part of the ground saved, which is at present lost. Besides railings of wood, wire, or iron rod, there is the sunk fence; none of these taking up any land. In wet, marshy, or boggy ground, ditches would serve for fences and drains at the same time; and in such a place as Broadelyst Moor this method of dividing and at the same time of draining the land, would very much increase its value. But in cases where it might not be thought advisable, either owing to the first expense of iron rod, or wire railings, or to other circumstances, to adopt any of these methods of dividing land, the white-thorn would make a cheap and good fence, taking up very little room, being impervious to cattle, and costing little either at first or in keeping up afterwards. A thousand plants will plant thirty perches of one row, or fifteen perches of two rows, the plants being six inches apart: they cost from 10s. to 20s. per thousand, according to their age, and the planting of them costs very little. Sir John Kennaway, by taking down 100 perches of bank and planting 50 perches of thorn hedge, thus making three fields into two, saved nearly an acre of ground. There is not any reason that I can see why a farm even so small as a hundred acres should lose more than 1 per cent. by its

---

\* Even the beauty of Devonshire and Somersetshire may be greatly improved by the removal of a large part of the fences. A few of the most beautiful trees, especially oaks, which from the depth of their roots are less injurious than ash or elm, may be spared, and will have more picturesque effect than long lines of undistinguishable foliage. The undulating lines of the surface thus unmasked, afford often a graceful landscape, with swelling knolls hidden before, and on these knolls the farmer will not grudge a little ground for single trees or clumps planted in commanding situations. In many places a confused farm might thus receive at once the character of an arable park.—*PH. PUSEY.*

hedges. In a survey of a parish road which I lately made, with a view to its being widened, I found that, for the greater part of its length, its width might have been *trebled* by merely adding to it the space taken up by its present wide fences. John Matthews, Esq., of Clisthydon, has within the last few years taken down half of the fences on his estate, and is proceeding to take down nearly all that remain. Timber need not be encouraged in hedgerows on account of its value, as, from the admission of foreign timber, this has been materially reduced. I should not think that the timber thus grown pays nearly so much annually as 1 per cent. of the rental, while it destroys about 10 per cent. of the ground; allowing 3 per cent. more than what is actually occupied for injuries sustained by the causes mentioned. What necessity is there for a farm, even so small as a hundred acres, being divided into smaller enclosures than eight ten-acre fields, and the remaining twenty into four or five, as might be most convenient? It would be a great improvement on the present state of things, if, instead of six fields of every ten being *under* four acres, there were the same proportion over ten acres. If to the loss shown to be sustained from these small enclosures and great hedges were added that from waste ground and the want of drainage, how very far short of its capabilities would appear that which is at present derived from our soil! An eminent writer of the present day says, "The introduction of thorough-draining will probably increase the productive power of the soil in Great Britain a third; scientific discovery may perhaps add another third: but at least ten years must elapse, in the most favourable view, before these effects take place,—ere the judicious and well-directed labours of our husbandmen have formed rivulets for the superfluous wet of our fields, or overspread the soil with the now wasted animal manures of our cities."

Although I have shown the loss to be so great from the present system of dividing farms, I am not so sanguine as to expect to see anything like the saving made which might be, there being in some cases many difficulties to contend with; as where property is very much intermixed, and where it is leasehold. But with willing minds, and an enlightened co-operation of landlord and tenant, this county may soon become as famous for its superior farming as it is now for its mild climate and beautiful scenery. I have given several instances where much has been done in this neighbourhood; these, and the example of other districts at present in advance of this county, form examples worthy of imitation. If every agriculturist recorded the results of his experience, much knowledge of the most practical and useful kind, at present confined to himself and frequently dying with him, would be added to the general stock, and advance the science proportion-

TABLE referred to in the foregoing Report.

NAME OF PARISH.	Total acre. in the Parishes.	Miles of Hedge in the Parishes.	Ares occupied by Hedges in the Parishes.	Per centage occupied by Hedges.	Equal to one in	Enclosures between 1 acre and 1 acre.	Enclosures between 1 acre and 2 acres.	Enclosures under 2 acres.	Enclosures between 2 acres and 3 acres.	Enclosures under 3 acres.	Enclosures between 3 acres and 4 acres.	Enclosures under 4 acres.	Enclosures between 4 acres and 5 acres.	Enclosures under 5 acres.	Enclosures between 5 acres and 6 acres.	Enclosures under 6 acres.	Enclosures between 6 acres and 7 acres.	Enclosures under 7 acres.	Enclosures between 7 acres and 8 acres.	Enclosures under 8 acres.	Enclosures between 8 acres and 9 acres.	Enclosures under 9 acres.	Enclosures between 9 acres and 10 acres.	Enclosures under 10 acres.	Enclosures of 10 acres and upwards.	Total number of cultivated Enclosures in Parishes.
Huxham . . .	762	34	54	7	14	16	14	30	23	53	26	79	16	95	14	109	9	118	8	126	4	130	3	133	9	142
St. George's Clyst . . .	1,040	52	83	8	12 <sup>1</sup> / <sub>10</sub>	35	57	92	34	126	37	163	29	192	18	210	23	233	8	241	8	249	6	255	9	264
Rewe . . .	1,341	65	104	7 <sup>1</sup> / <sub>10</sub>	12 <sup>9</sup> / <sub>10</sub>	33	47	80	71	151	56	247	33	240	29	269	13	282	14	296	9	305	11	316	8	324
Poltimore . . .	1,710	59	94	5 <sup>1</sup> / <sub>10</sub>	18	27	50	77	48	125	43	168	25	193	20	213	18	231	11	242	9	251	8	259	38	297
Clisthydon, . . .	1,725	86	138	8	12 <sup>1</sup> / <sub>10</sub>	26	52	78	69	147	81	228	59	287	39	326	41	367	15	382	14	396	7	403	4	407
Feniton . . .	1,822	95	152	8 <sup>1</sup> / <sub>10</sub>	12	48	71	119	74	193	68	261	67	328	45	373	31	404	17	421	15	436	7	443	6	449
Talaton . . .	2,365	114	182	7 <sup>1</sup> / <sub>10</sub>	12 <sup>9</sup> / <sub>10</sub>	57	105	162	90	252	89	341	76	417	49	466	31	497	21	518	10	528	7	535	13	548
Silverton . . .	4,714	222	356	7 <sup>1</sup> / <sub>10</sub>	13 <sup>1</sup> / <sub>10</sub>	92	161	253	161	414	173	587	168	755	110	865	70	935	58	993	27	1,020	11	1,031	35	1,066
Broadclyst, . . .	9,188	383	613	6 <sup>1</sup> / <sub>10</sub>	15	188	348	536	336	872	304	1,116	243	1,419	197	1,616	115	1,731	94	1,825	55	1,880	33	1,913	57	1,970
Crediton . . .	12,309	541	866	7	14 <sup>1</sup> / <sub>10</sub>	283	442	725	387	1,112	343	1,455	299	1,754	222	1,976	160	2,136	111	2,247	80	2,327	55	2,382	148	2,580
Total . . .	36,976	1,651	2,642	7 <sup>1</sup> / <sub>10</sub>	14	805	1,347	2,152	1,293	3,445	1,220	4,665	10,155	5,680	743	6,423	511	6,994	357	7,291	231	7,522	148	7,670	227	7,997



ably. The discoveries of Professors Liebig and Playfair, the improvements made by our Royal, Highland, and Provincial Agricultural Societies, and put into practice by Earls Ducie and Spencer, Mr. Pusey, and a long list of the great and intelligent throughout our island, have given an immense impetus to agricultural improvement, which I trust will not cease till our land has attained that full amount of productiveness which the Almighty intended, and which his kind providence has placed within the reach of every practically scientific agriculturist.

243, *High-street, Exeter.*

---

XXV.—*On the Indications of Fertility or Barrenness of Soils, whether of Colour, Consistence, or Vegetation.* By JOHN ARKELL.

IT has often occurred to me, when reading of analyzed soils and opinions given thereon, that there must be great difficulty in coming to a correct conclusion as to its fertility or barrenness thereby, knowing as we do that the different formations of the earth, as laid down by geologists, contain a number of veins or strata in the same formation, and that many of these veins or strata often crop out or come to the surface of the earth in the space of a hundred yards, also that each of those strata are composed of very different matter, as respects colour as well as substance; therefore, soil taken from either of those strata and analyzed cannot give the contents of any one of the others. It is true, on arable land, the different strata become mixed in a degree by the action of the plough and harrows, but not enough to make the soil of a whole field all alike. I have observed in the spring of the year, in dry weather, that scarcely any piece of arable land is of the same colour all over; some of several different shades in the space of 8 or 10 acres; and have come to the conclusion that the difference in colour is caused by the different strata coming up to the surface. As a case in point, I have in my occupation a field of arable land of about 10 acres, situated on the blue lias formation, which contains at the lowest part of it, in the space of a depth of less than 20 feet, no less than ten separate beds of stone, divided from each other by as many beds of clay or marl. Now, every one of these beds of stone and clay or marl crop out before you get three parts of the way up the same field; neither two of these beds of stone are alike in colour or matter, although all bear a resemblance to each other. The several beds of clay and marl are very different; some contain gravel and sand, others many small particles of limestone; and next to the hardest and best stone lies the marl, as soft in

the hand as soap. I am satisfied that to analyze the upper and under soils of any part of such a field as this is useless for the purpose of ascertaining its degree of fertility or barrenness, as regards the whole 10 acres. I apprehend it will be necessary, before chemistry will be able to decide the relative fertility or barrenness of a whole farm, or parish, or district of country, or even a single field, to examine every stratum that crops out in such farm, parish, district, or field, and the subsoil immediately under it; also its colour, consistency, and the vegetation thereon; and such, I suppose, are the opinions of natural philosophers, and consequently further information is required, to which I will endeavour to contribute as far as my experience and observations will serve me.

I have been the whole of my life in agricultural districts, and for the greater part of the last thirty years have been engaged in farming pursuits, and have travelled over a great part of Berkshire, Wiltshire, Oxfordshire, and Gloucestershire, and also some parts of Warwickshire and Worcestershire; and have made many observations on the different soils as I passed through the country, some districts of which I saw at all seasons of the year, and for years together. I will begin my observations on the chalk formation, the soil on which I was born. My father occupied a farm of 700 acres at the foot of the chalk hills, about midway between Swindon in Wiltshire, and Wantage in Berkshire; the farm extended to the length of six miles from end to end, and contained four sorts of soil: the upper end has a brown super or top soil, with chalk under, part arable and part downs; then comes the white land, with a white stone under that, all arable; next, the whitish, or ash-coloured land, with a subsoil of alternate veins of soapy marl and white gravel, mostly arable. The lower part of the farm is all pasture, with a clay top-soil, mellowed a little with vegetable matter; the subsoil a very tenacious yellow clay. In cultivating the land on the chalk we invariably found the darkest coloured soil to produce the best crops of every description; and this occurred mostly in the lowest situations. As the land becomes more elevated the chalk rises nearer the surface, which, by the action of the plough, is mixed with the top-soil, and gives it a paler colour; and, in addition to this index of comparative barrenness, we always found such soils more thickly covered with small stones: and this fact is observable on the worst part of the downs; but here the stones are almost black from the action of the elements. Another feature of this part of the country is an unerring guide to distinguish the good from the poor soils; the hedge-rows (where there are any) are always strongest on the darker land, and short and stunted on the light-coloured; and when a hedge may chance to go up the ascent of a hill, it will hardly grow at all towards the top. I am not aware of any plant

that is peculiar to this formation, by which we can tell its fertility or barrenness; the mathen and crow-needles grow more thickly and stronger on the poorer than they do on the richer parts; but this I think is owing to the crop being weaker, consequently giving more room for weeds to flourish. In ploughing this kind of land we found the better descriptions to be of a firmer texture (although not containing so many stones) than the poorer—that is, what farmers call having more staple to it, even in walking over it at any time the same facts may be discovered. The down lands are very various as to quality; in most of the bottoms the sheep feed sweet and close; and these would no doubt, if brought into tillage, produce good crops; the tops of the hills are mostly mossy, and produce but little feed. Some places there are which are covered with long, rough, sour grass—an indication that clay is near. Where these two last remarks apply, be assured the land is weak, and would be unproductive if ploughed.

I will next mention the white land: here, as on the chalk, the paler and weaker the colour the less the produce, let the crop be what it may, and the cause is the same—being nearer the stone. Here also the hedges grow worst on the palest land, and the best is soil of the strongest staple.

Now I will describe the whitish or ash-coloured land. This stratum is mostly arable, except a few closes near the village, which are pretty good as grass-land—or else, in a general way, this stratum is but indifferent pasture, but cultivated as arable (if well tilled), is the best land I ever saw for any crop. I know of no difference as to quality here till you come to the clay below, where, if any part of a field chance to run on that stratum, you may see to within a yard where it commences by the colour, which is darker; and the farther you advance on the clay the darker is the soil, and the worse its quality from being mixed with the clay; the staple of the soil is not near so firm on the clay as where it is free from clay. I am not aware of any plant that grows here by which the two soils can be distinguished from each other; the hedges and timber thrive equally well on both.

The pasture land at the lower end of the farm, as I have said before, is a clay top-soil a little mellowed with vegetable matter, with a tenacious subsoil of yellow clay. This land is not good as pasture, but would be still worse as arable, judging by what I have seen ploughed in its neighbourhood. The hedges and timber grow well on the whole of it; but there is much difference in the appearance of the herbage. On the higher parts of these fields the grass grows much stronger and higher, with more bents, and some small quantity of clover. As you approach the lower ground the grass becomes shorter, with less bents, and a great portion of it carnation-grass (the worst sort that grows). At

mowing-time the land actually looks white with moons; the carnation-grass is visible at all seasons of the year. In draining this land we found the top-soil to be of the same colour on the higher and lower parts: but the subsoil varied much; on the higher parts it was almost pure clay, with a few flints and pebbles; while, on the lower parts, the clay is much paler, with less of flints and pebbles, and mixed with a vein of a light-coloured mortary grit.

I shall next describe a farm of 500 acres, also occupied by my father, in the neighbourhood of Witney, in Oxfordshire, and partly on the oolite formation. On this estate there is limestone brash, a hollow moory land, a light gravel, a moory gravel, a strong gravel, a mortary loam, and a strong clay; the limestone brash is a light red loamy top-soil on the limestone. In some places the loam is a yard in depth; where this occurs the crops are much better than where the stone is near. In places on this kind of soil there are veins of clay in the subsoil, which cannot be detected at any time except when the land is very wet, and then you can hardly walk across those places for a few days; but we never found much difference in the crops, except where the clay lasted some distance. When on such places the turnips were small, and the corn short and very fine in the straw, we never discovered any variation in the colour of the topsoil.

On such soils as these a chemist may analyze either of these several veins of land, and yet not arrive at a correct conclusion as to its comparative barrenness or fertility. If the sample sent him happened to be taken from the part of the field where the subsoil is loam as well as the top, he would pronounce it a fertile and rich soil; when, on the contrary, if the sample were taken where the subsoil is clay, he would say the field was bad. In either of these cases he would be wrong as respects the whole; but if the soils analyzed were taken from the stony part of the field, the result would be much nearer the average quality of the land; for take any practical surveyor or farmer over this land, he would at once pronounce it a pretty turnip and barley soil of average quality, and such is the real character of this part of the farm.

Close to this brashy land lies the hollow moory field. It is a black hollow top-soil on a pale soapy clay; and in some places the subsoil is a mortary gravel, very weak in its nature, and of much the same colour as the clay. On entering this field, the practical man would pronounce it bad, and not worth cultivating. He would point to the white places where the subsoil peeps through the top, also to the wild tansy and rushes, as indications of poverty and stagnant water. He would say, "Look at this top-soil; see how light it is; it is almost ready to fly with the

wind. If anything is to be made of this, it must be well drained first, and then well stocked and trod with sheep to make it firm, before anything will grow here." Such is the treatment this field has had; and after being pared and burned, and a little manure added, it grew an excellent crop of swedes, and a good crop of barley after; but it will not bear wheat, neither were the swedes or the barley so good on those parts of the field where the top-soil is of a pale colour.

We next come to the light gravel. This top-soil is a darkish-coloured light gravel, with a pale weak gravel under: the whole field the same. This is good turnip and barley land, ever dry, and will bear an average crop of wheat of good quality. On walking over this field it treads firm; no indications of sponginess, or plants of bad omen, to be seen. If out of crop in the spring, the groundsel and chickweed will grow well.

Adjoining this enclosure is a large one of a moory gravel. The top-soil is of a dark colour all over, but one part of the field is of much lighter texture than the other; and where this is the case the subsoil is a weak pale gravel; and near the upper end, where the top-soil becomes of firmer staple, the gravel is stronger and lower down. This field is of weak middling quality, where the top-soil is light, and hollow to the foot, but improves as it becomes firmer.

A hedge only divides the last-mentioned field from one in which the nature of the soil entirely alters again. The land here rises to a considerable ridge, of gentle ascent either way. It covers an area of about 60 acres. At the base of this bank, facing the south-east, is a good strong gravel, of a rich yellow colour, with a subsoil of gravelly loam. On the contrary side, facing the north-west, the top-soil is a mortary loam of considerable depth, a little inclined to clay in places, which reaches over the top of the ridge, and meets the gravel on the other side in places. On this land the hedges and timber grow equally well on the gravel and the loam; and on part of it which is pasture on the loam, the furze (or whin) grows strong and well, but the turf on it is inferior. Where the clay appears, the turf is sweet and good. This mortary loam, as arable land, is more valuable than when down as pasture; but not first-rate, by any means, in that state. Its appearance to the eye is not such: the colour is a dead-looking pale yellow. It treads firm at all times; will bear pretty good wheat and oats, but no other crop for certain; it is not a turnip soil by any means. The oak thrives well on it. The gravel on the south-east side will bear turnips and barley, as well as wheat and beans, equally well. One corner of this ridge of land abuts on a piece of pasture of the same kind. It is a hungry clay, mixed with this mortary loam, which forms a more barren soil than the mortary

loam itself; of little use as arable or pasture land. Its very look is poor, although the timber grows well close by on the same soil.

In passing from this poor corner we come to the pasture just named above. A worse piece of land I hardly ever saw. It joins a brook which overflows it at times after heavy rains, and to appearance does some good—at all events, where the water goes the grass looks green in the winter and spring, but when hay-making comes there is little or no more grass than where the water does not go, neither is the hay of better quality. On the parts of this field where the water does not go, we put some farm-yard manure, also some ashes steeped in soap-suds and chamberley, and fed a flock of sheep on a portion of it, in the hope of improving the herbage; but could never see the least good either of the three manures did. The sheep-dung lay so thick that it might have been shovelled up; still the land had that russet, unkind, thick strong turf, which no animal would eat unless starved to it. Dig up a portion of this soil, and it looked good; plenty of substance to it, and not, to appearance, too much clay—a soil that would deceive most farmers. Perhaps the chemist might be the best judge here, the field being all alike, and the sub and super soils being apparently the same.

Immediately above this barren pasture is an arable field of strong clay (still adjoining the same brook), but not a very wet clay. It would grow beans and wheat. The top-soil here is inclined to be a little dark, but treads hollow after a frost. The subsoil is a yellow clay.

The remainder of the farm is pasture, mostly clay or a clay and loam mixed, with a clay subsoil, and of much the best quality on the higher parts of it. The elm grows well on the loamy and drier veins; where the clay predominates, the oak thrives better; but the turf shows indications of sourness, with a great deal of carnation-grass, and but little or no clover of either sort mixed with it. On the lower parts of the pasture the herbage is still worse. A great portion of it is what we call fire-leaves, and much carnation grass, and a few bents. The top-soil here is a little coloured with decayed vegetable matter, but evidently clay, with a clay subsoil.

I now come to the farm I at present reside on, which is on the blue lias formation, and lies within 5 miles of the city of Gloucester, and in one of the worst districts of land in Gloucestershire. I have known land produce as little grass and hay as this pasture does, and as little straw as the arable, but never so little butter and cheese from that grass and hay, or so little corn from that straw. The wheat varies from 8 to 20 bushels per acre; beans from 16 to 24 bushels per acre; and the make

of butter and cheese is as bad. The colour of the top-soil is mostly dark, inclined to blue—a clay mixed with stones from the subsoil, and pebbles, apparently transported hither: it also contains a great deal of lime-wash. The subsoil partakes of nearly the same nature, but mostly of a lighter colour, in consequence of its being excluded from the sun and air. In some places on this formation, as I have before observed at the commencement of this Essay, the veins of stone and clay, or beds, as we call them, crop out many of them in the space of a furlong, and impede the plough as badly as any of the stony land on the oolite formation. Here also I observe, the paler the colour of the soil the weaker the land, whether arable or pasture; and from the same reason—that is, the subsoil—either stone or clay approaches nearer the top, and becomes mixed, thereby causing the difference in colour. On this formation, where the stone is soft and weak, and of a light colour, there the land is worst. This district of poor land extends, from east to west, about 2 miles in breadth, and about 4, from north to south, in length. By the cause of some natural agency, there is a ridge of high land running nearly the whole length of this district; and on the highest part of this ridge, for a few acres, the soil is as good as I could wish to see, and makes excellent pasture, always dry; the turf of a rich green colour, with much clover. The best sort of bents are to be seen, and plenty of sorrel and craisies. The soil is a rich-looking gravelly loam, with a subsoil of the same earth. The elm grows well—better than the oak; but as soon as you begin to descend the hill, the soil becomes clay directly. The turf looks russet and stingy, and the herbage of the worst sort—carnation-grass for the most part, without clover or craisie. The bents are of the worst sort, and in some places scarcely anything else growing but what we call black bents. On a great deal of this pasture-land the wood-wax and gorse are very abundant, as well as many other nasty weeds which I do not know the names of. Nearly the whole of this land wants draining, pasture as well as arable. Some has been done, which has improved it much, but will never make it land of an average quality. Extreme wet or dry seasons affect it very much—I may say injure it very much. The arable land, if fallowed in very dry summers, becomes so light in the staple that the crop generally fails if planted with wheat next year, and you get a crop of weeds instead. On the other hand, if fallowed in wet summers, you cannot clean it. Here are hundreds of acres in this state now, not a morsel cleaner for having been fallowed last summer.

In March, 1842, my landlord drained a piece of arable land on this farm. I then, in the course of the summer, cleaned it as well as possible: there was not a bit of couch or other roots to be seen.

I then manured it with good farm-yard manure, at the rate of 16 cart-loads to the acre—certainly more than 20 tons. I planted it with wheat on the first two days in March last. The wheat came up very strong, and looked well for a few days: it then began to lose plant, and looked very sickly all the time till harvest. I did my best by hoeing it, but to no purpose. When harvest came I had the worst crop of wheat I ever saw, but a heavy swath of weeds, and those of almost every kind. I am not alone in this case; for many of my neighbours had fields of wheat last season that were planted at Michaelmas, and a little after (on fallows), which were no better than mine, but weeds there were in abundance. The hedges and timber grow well on this soil; the hawthorn very strong. The wild tansy, the wild withey, and the horse-mint, grow here very well. It is also very subject to wild mustard.

I have now said what my actual experience as a farmer has taught me, and will next endeavour to communicate what I have learned by observation in travelling about as a farmer. I always found there was much to be gained by watching the operations of other people. The first piece of land that excited any degree of interest in me as to its good or bad qualities was a rabbit-warren, about five miles from Marlborough, in Wiltshire. The first time I saw this land I was on my road to school. I thought little of it then; except noticing the few elder-bushes that were to be seen, and the rabbits which were in abundance: still I remembered the bushes were on the brow of the hills, and that the rabbits made their holes amongst them, and that the chalk looked white there. In a very few years after, this warren was let as a farm and broken up. I passed through this warren many times afterwards, at all seasons of the year. Those places where the bushes stood were to be seen at a great distance, and looked as if the land had been chalked. In summer the crops showed these places very much. Scarcely anything grew on them for a few years: while on the land where the chalk was not to be seen the crops were excellent; turnips and seeds as well as the corn. I always considered this difference to arise entirely from the chalk being mixed with the top-soil, partly by the rabbits and more by the plough, in consequence of the top-soil being shallow there: this fact also caused the variation in colour from the better parts, which was a dark, hollow, light loam. The chalk-hills in this neighbourhood—in fact, all the chalk-hills that I have seen—show the worst face on the sides and brows of them, and are less fertile than the tops or the bottoms, whether used as pasture or arable. These observations will apply to the same formation in Berkshire, which I have mentioned before.

I will next describe a district of country which I have been



through many times; indeed I have been over several farms which lie within this district. It extends from Cricklade, in Wiltshire, to Bampton, in Oxfordshire, about 14 miles in length, and varies from 1 to 4 miles in breadth, and lies on the left hand as we descend the banks of the Isis, to which it is contiguous the whole distance above-named. Here is quite a field for any chemist—aye, even for a natural philosopher of the best school—to define the geological properties of this district of country. It contains almost every description of soil; also good and bad of each sort; pasture as well as arable; irrigated meadows, natural as well as artificial. I think some of the former which are flooded by the Isis are as good as possible for any purpose, or for any kind of stock. Any person at all acquainted with land would at first sight pronounce these meadows to be good: through the winter it always wears a good face; its appearance is rich and good. If you examine the herbage, you will find much rye-grass and clover, with all the best sorts of bents, and a total absence of those bitter, noxious weeds which are found on poor pasture-soils—such as moons, carnation-grass, gorse (some people call it cammock), fire-leaves, hard-heads, and many others. The hay from these rich meadows, if made in good season, will stick to the fingers like good hops. The soils of these meadows are not all alike: some are a loamy gravel; others have much clay in the composition; while in other places they appear to consist entirely of alluvium left by the Isis. As respects the fertility of these meadows, much depends on the nature of the soil that is flooded by the same water; or whether the water runs right over it; or what is called flooding backwards—that is, the water runs or stands back on the land, and lies in a stagnant state till the flood subsides. In this latter case it is ever considered that the water does harm: when, on the other hand, the water, by *running* over the very same description of soil, does a vast deal of good; thereby often making in the very same meadow good land and bad land, merely by the action of the water; and yet to the chemist the super and sub soils of each shall appear the same. I will ask, How is he to decide? The experienced farmer is much more likely to point out the relative fertility of such soils: he would call attention to the unkind state in which the flood had left the land, drowned by the back-water, covered with scum and small pieces of vegetable matter, driven there by the wind; the herbage looks starved, and not of the best kind; and if this part should lie a little flat, as is often the case, it will be found full of sedge-grass and other water plants.

As the beds, or rather veins of gravel, run through the whole of this length of country, I have observed that the best upland pasture has a great portion of dark loamy earth mixed with the gravel, and in some places clay also; but where the clay predo-

minates it is mostly wet, in consequence of the gravel bringing the water from the higher ground. Here, also, the plants, which indicate poverty, will appear brought there entirely by the stagnant water; for when these pasture-fields are drained many of such weeds are not to be seen. There are some clay-soils in this district, both pasture and arable; but they differ very little from what I have before described in other parts of the country.

The most predominant soil in this district is gravel, and that of almost every shade of colour, as well as consistence, and I may say of every degree of fertility. I will first speak of the arable: that which has a mixture of loam, and has a dark brown cast or colour, is the most fertile; its texture or staple is firm, and has a rich appearance. This soil will bear heavy crops of any kind, except beans; excellent for turnips and barley. The only casualty I know of belonging to this land, is its being affected by extremely dry summers, in consequence of the subsoil consisting of gravel alone to a considerable depth. As this gravel approaches the oolite strata on which it lies, it invariably and gradually becomes of a lighter colour, and weaker in its nature, and consequently more barren.

There is also a moory gravel, and that to some extent, in this tract of country, but of a much less fertile quality than the one just mentioned: still some of it is useful arable land, if properly treated. Here also, as on the other gravel, the darkest in colour is the best. The pasture on this description of soil is of the worst character, and lies for the most part very wet, for want of draining: but even where it is drained, the turf wears a very dry, stingy appearance, nearly white for six months in the year. The subsoil under this moory gravel is mostly a weak, pale gravel, with veins of clay intermixed; and in places there appears hardly any top-soil at all; that which is, is in a great degree decayed vegetable matter.

The pasture on the best description of gravel first treated of—that is, the loamy gravel—is very good; particularly fertile as dairy-land, and makes goods of the best quality; but as you approach the oolite formation the turf becomes gradually worse.

I will now take a view of the Cotswold Hills, which include a great part of the oolite formation: but it must be a brief sketch for a work of this nature; for a full description of these hills would fill a large volume in treating of this subject alone. Here are to be found soils of many sorts and colours. These hills are mostly occupied as arable land; and much of that which is pasture, where it can be ploughed, would be more profitable as arable. The most prominent signs of the best soils here are a reddy-brown or partridge-coloured loam (most of this formation has a loamy top-soil), upon a loose rubbly subsoil;

the stones not too soft, or too small, nor too thick on the top-soil; and the top-soil of a firm texture. On the other hand, if the top-soil is inclined to look dark and moory, and appears comparatively free from stones on the top, we expect this to be sour, weak land; or if we find the stones in the subsoil of a soft texture, a pale colour, and a quantity of small stones lying on the top-soil, we judge this to be weak land, but healthy for sheep-stock; also, if we find the subsoil to consist of a *flat, compact rock*, we say this is not a fertile soil; and the nearer the rock approaches the surface the worse it is. What renders this soil unproductive is, that the roots of the plants cannot penetrate the rocks to the requisite depth, neither can the water percolate sufficiently quick, nor the moisture ascend readily in dry weather. Many of these flat rocks lie immediately under, or upon, a bed of clay. If we find clay on these hills we do not pronounce the soil good, notwithstanding the stone should be hard and good. In a general way, the harder and firmer the texture of the stone the better the land, provided the subsoil be loose, and not retentive of water.

I fear my observations will be found too lengthy and tedious for a work of this nature, therefore I shall treat of only one more district of country, and that on the lias formation, which runs (as far as I have traced it) from Bristol, through the vale of Gloucester, part of Worcestershire, and on into Warwickshire. Some persons call it the blue lias, and certain it is that all the stone which it contains has, more or less, a blue cast. The harder it is the bluer it is; that which is soft is of a pale colour; but the beds of clay are of many colours: some are red, containing gravel and sand of the same colour; some are almost white, with much lime-wash in it, having the appearance of mortar; others are yellow and blue, and between the bottom beds of stone there is a blue marl. This being the composition of the lias formation, it must, in consequence, produce supersoils of various colours, as the different beds of stone and clay come to the surface, or (to use a geological phrase) crop out; and such is the case for the whole district of country I have mentioned. There is another material cause of the difference in colour in this formation, which is this: in many places here are banks, or (perhaps more properly and correctly speaking) continuations of some extent from the oolite, which run, in some instances, for miles on this formation; and in other parts there are detached spots of alluvium, left by the water at some time. These facts, combined with the natural formation of this strata, must consequently produce many qualities of land, and those of many colours.

We have some good land, and some very bad in this district, as may be supposed from the above description; but, I believe, the

most fertile of both arable and pasture is where other soils lie on the lias, or are mixed with it: therefore I think the quality of such soils can be but little understood by their colour, without an actual inspection of the spot to be judged of. The top-soil may belong to the oolite, and the subsoil to the lias. The colour of each varying so much, the palest and most plastic of this formation (the lias) we generally find the least productive as arable-land; and, from its very wet nature, combined with its barren qualities, producing almost every sort of weed in great abundance, such as horse-mint, wild withy, wild tansy, &c. The poorer sorts of pasture are invariably found contiguous to the worst arable, and, from the same causes, produce weeds for the most part; and, like other barren pasture-land before specified, produce carnation-grass, wood-wax, gorse, moons, fire-leaves, and such like. It has ever a sour appearance, and for six months in the year the turf is nearly white, or, I perhaps ought to say, a nasty white, from the number of old stems left from the last summer.

I shall mention one more feature of this country, and then I have done, that is, the meadows on the banks of the Severn, which, by judicious management, may be made some of the finest in the kingdom. These meadows, for the most part, consist of alluvial soil, and that, in many places, to a great depth; and many of those that are not composed of such soil may be flooded to great advantage at little expense. But at present this land lies in a very neglected state, and much of it, to appearance, is very poor and barren—and it is so in reality as now managed. Nature has made the land, together with the means of enriching it, but man neglects his part. I believe this soil to contain every ingredient necessary to form good and fertile land for any purpose, but the crop is cut and carried away every year, and the land left to take care of itself till the next season. I know of a few meadows, under good management, that are excellent, and why not others? Those that are well done look rich and healthy at all times, the herbage of the best kind, and the hay of the best quality. On the other hand, where neglected, the appearance is coarse and barren, the turf covered with moss and sedge-grass, and, when cut for hay, they get but little to carry away but this sedge-grass; if any moss is cut with it the cattle will not eat it. All this difference for want of the Severn floods over it.

Such are my observations, founded on facts derived and corroborated by thirty years' experience. Before I conclude I will state my opinion how far your object is attainable, under the three heads on which you are desirous of information, namely, Colour, Consistence, or Vegetation.

*Colour.*—As regards the colour of soils, I believe there is good

and fertile land, also poor and barren land of all colours. If judgment is to be formed by the colour, it should be entirely confined to the particular soil in question, and in that case great deference should be paid to the texture also; as, for instance, all newly broken up land is of a more hollow nature, and much darker in colour than old tillage-land on the same strata, even if the fields lie side by side. It is only in the same field, farm, parish, or district that any judgment can be correctly formed as to its relative fertility, and then much *judgment also* must be exercised in examining the cause which tends to change of colour. My opinion is, that on almost all old tillage-land the supersoil takes its colour from the subsoil. There may be some, which have been very highly manured for a long course of years, that are altered a little by that means, but not many, as most manures dissolve entirely in time; also lime, applied to arable-land in large quantities, gives it a lighter colour, and tends to firm the staple of it.

*Consistence of the Component Parts which form the Super and Subsoils of the Earth.*—The most fertile soils that have come under my notice (as will be seen in the foregoing pages) are the alluvium and loams of every description, whether mixed with gravel, marl, stone, or clay. The latter is often wet, but, when drained, it will generally produce very heavy crops of wheat and beans; and most of such soils are good pasture if drained. A great deal depends on the depths of the top-soil, as well as on the nature of the subsoil. If the top-soil be of a good depth it often answers the purpose of a loose, porous subsoil, for it is impossible for any crop to flourish on a hard, compact bottom: yet I must not be understood to say that these soils will be ever fertile without good tillage and good manuring. Some pasture-land will remain in a rich state provided it be grazed at all times, and not mowed at all; but the best of arable-land will soon get poor by constant cropping. It is true the best land will (what we farmers call) answer the whip much sooner than poor, weak land.

Poor and barren soils are often composed of one individual stratum, or at best but little mixed with any others. Such is the case where stone, sand, clay, or gravel predominates. Where this happens the subsoil will be found much to resemble the top-soil, whence comes the barrenness for want of mixture of strata, or earthy matter. Some soils are barren from being of too hollow or light a texture, while others are so from being of too plastic and adhesive a nature. I never found good land yet but what would tread firm under foot if in a dry state, and even in a wet state if the water is not suffered to lie on it; but poor land I have, such as moory soils, light sands, and even clay when pul-

verized by frost, or extreme dry weather. On each of these three soils I have seen the wind blow the wheat up by the root in the spring of the year; and on pasture-land of this description I have seen the grass-plants actually drawn out of the ground by the frost.

I know of a farm in the county of Gloucester that for many ages had lain as a common. It was inclosed about twenty years ago, and most of it ploughed up, but, contrary to expectation, it proved bad, uncertain land. The tenant tried every means he could devise to improve it, but all to no purpose. He pared and burned some, and had he continued doing so he might have burned the whole of the top-soil—aye, actually consumed it. Disappointed and brought to a stand-still, he applied to his landlord for a reduction of rent. The landlord said, “No; but if you think lime will do any good, I will pay for lime to a certain amount.” The tenant procured lime from a distance of 16 miles, and dressed his land with it. The result was good crops of every description after the lime. Now, adjoining this farm, and only separated by a turnpike-road, and on soil of the same description in every particular, is another farm of old tillage-land, which always grew good crops without lime. How, in this particular case, I will ask, can chemistry tell the productive soil from the unproductive? The excess of vegetable matter in the old common land was, in a great measure, dissipated before the lime was applied; therefore but little difference in that particular could have appeared. This is a dark-brown, gravelly top-soil, with a subsoil of much the same earth.

*Vegetation.*—As regards vegetation on the best soils, much depends on its condition. If full of manure anything will grow to a good crop that may be planted, provided such crop is calculated for the particular sort of land. The elm grows well on most good soils, especially on the loams; and nearly as well on poor, thin loams, provided the subsoil be loose and dry. On the best arable lands, in good condition, and out of crop for a short time, the groundsel and land-grass will appear: a sure guide that the land is fit to be planted. But on good arable-land, *out of condition*, every description of weeds and plants the soil is or has been subject to will come again, and many will appear which are to be seen on barren soils: therefore, as regards vegetation, much caution is necessary before giving an opinion as to the relative fertility or barrenness of any soil.

Difficult cases of this sort might be multiplied to a great length, therefore I will content myself with what I have said heretofore relative to this particular, and more especially to the remarks on pasture-land, on which I cannot say more to the point.

Hoping I may have afforded, in some degree, the information you require (and that in a plain, though not in a learned or an eloquent manner), I will conclude by saying that I have inclosed a few specimens of different plants, with the names attached—at least the names by which we know them in the country,—and have classed them as they appear on the different soils, as far as they relate to indications of barrenness. The vegetation on good land, every one knows, is of the best kind, consequently it needs no description from me.

---

*Plants found on poor Wet Clay Pasture-Land.*

- No. 1. Wood-wax.
- No. 2. Moon.
- No. 3. Fire-leaves.
- No. 4. Black-bents.
- No. 5. Carnation-grass.

To which may be added gorse, rushes, and a blue-flowering plant, which does not blossom till September, when many acres of this farm actually look blue with the flowers of this plant.

*Plants found on poor Wet Clay Arable-Land.*

- No. 6. Wild tansey.
- No. 7. Wild teasel.

To which may be added those that the present season will not afford specimens, viz. :—

- Horse-mint.
- Wild withy.

*Hollow Farm, Elmore, near Gloucester.*

---

XXVI.—*On the Use of Bones as a Manure with Sulphuric Acid.*

No. 1.—*Experiments made on Turnips with different Manures, on the Home Farm of Gordon Castle, Morayshire, in the year 1843, with the effect on the succeeding crop in 1844.*—From the President, the Duke of RICHMOND.

THE soil is of a poor, light, sandy nature; the turnips, which were Dale's Hybrid, were sown in drills 27 inches apart, and one half drawn for cattle in the yards, the other half eaten on the ground with sheep. The land was afterwards sown down with Chevalier barley and grass seeds, without any manure. The lots consist of

1 imperial acre each. The tailings are not included in the underneath calculations:—

- Lot No. 1. Manured with 14 yards farm-yard dung, and 8 bushels of bone-dust.
2. ,, with 315 lbs. guano.
  3. ,, with 16 bushels of bone-dust.
  4. ,, with 2 bushels of bone-dust, dissolved in 83 lbs. of sulphuric acid, previously diluted with 12 gallons of water. This mixture was allowed to remain between 2 and 3 days in a tub, and then 388 gallons of water were added to it; the mixture was then applied to the drills in a liquid state, by means of a water-cart.
  5. ,, with 8 bushels of bone-dust, mixed with 83 lbs. of sulphuric acid, previously diluted with 12 gallons of water. This mixture, nearly in a dry state, was then sown with the hand along the drills.

Lots.	Cost of Manure.	Weight of Turnips.	Value of Turnips.	Produce of Barley.	Weight per Bushel.	Value of Barley.	Total Value of Produce.	Value after deducting cost of Manure.
	£ s. d.	Tons. cwt.	£ s. d.	Qrs. B. P.	lbs.	£ s. d.	£ s. d.	£ s. d.
1.	3 0 0	12 0	3 0 0	4 1 3	56	5 18 1½	8 18 1½	5 18 1½
2.	1 17 4	11 4	2 16 0	3 5 1½	55	4 19 1½	7 15 1½	5 17 9½
3.	1 16 0	11 0	2 15 0	3 7 1½	55	5 5 11	8 0 11	6 4 11
4.	0 11 6	12 4	3 1 0	3 4 3	56	5 0 7½	8 1 7½	7 10 1½
5.	1 5 0	11 0	2 15 0	3 6 2	56	5 6 9	8 1 9	6 16 9

No. 2.—*On the Use of Bones with Sulphuric Acid.*

By E. WAGSTAFF.

HAVING been requested by His Grace the Duke of Richmond to state the effect of various manures at the farm of Westerton, on his Grace's property near Huntly, I now do so as near as I can; but my various manuring being more from necessity (want of farm-yard manure) than for experiment, I did not go so minutely to work as I might have done. In 1843 the turnips were laid down as follows:—



Lot.	No. of Acres.	Manures used, per Scots acre.	Cost of Manure per Acre.	Result.
		<b>SKIRVIN'S SWEDISH TURNIPS.</b>	£ s. d.	
No. 1.	4	18 loads of farm-yard manure, and 10 bushels of mixed (dust and drill) bones. Good soil.	4 15 4	An excellent crop; weighing, when topped and tailed, 28 tons 18 cwt. per acre.
No. 2.	3	200 lbs. (about 4 bushels) of bone-dust, dissolved in 100 lbs. of sulphuric acid, and 300 lbs. of water. After this mixture had lain a few days, and been stirred daily, it was further diluted with water, mixed with mould, and laid into the drills dry. Poor sandy soil.	1 1 1	Crop not nearly equal to No. 1.
No. 3.	1	The same quantity of bones and sulphuric acid as in No. 2, dissolved the same way, but diluted with 55 lbs. of water to 1 lb. sulphuric acid, and put into the drills in this liquid state. Soil like No. 2.	1 1 1	Crop rather better than No. 2.
		<b>RED-TOPPED YELLOW TURNIPS.</b>		
No. 4.	6	18 loads farm manure and 8 bushels mixed bones.	4 10 8	An excellent crop.
No. 5.	1	16 bushels of mixed bones.	1 17 4	Slower in growth, and not quite so good a crop as No. 4.
No. 6.	4½	Sulphuric acid and bone-liquid, same as No. 3. The soil of Nos. 4, 5, and 6, was all good, and equally so.	1 1 1	The best crop of the yellow turnips. As a proof, I sold my turnips, to be eaten by cattle in my byres, and in December I wished to get back two acres at the price I sold them at. No. 5 were eaten. I was refused the turnips off No. 6, but got two acres off No. 4.
No. 7.	6½	Sulphuric acid and bone-liquid, same as Nos. 3 and 6. Soil poor and various; most of it lately in a crofter's, or subtenant's hands, had two and three white crops following.	1 1 1	A very good crop.
No. 8.	½	Double the usual quantity of good farm manure. Soil the same as No. 7.	7 0 0	Plants much later in starting. Crop much the same as No. 7, certainly not better.

I do not think it likely that a constant repetition on the same ground of the sulphuric acid and bone-liquid would answer; but there is no deception in this statement of its effects, and there appear to be other advantages than the small cost of the liquid, viz., the quick starting and growth of the plants, which have here on all occasions come to the hoe nine or ten days sooner than from other manures; and with proper implements the liquid can be put into the ground at less expense than most other manures.

In a circle in the centre of No. 1, there was nearly an acre of the plants extremely small and weak; about the middle of July I neutralized about 160 gallons of cattle-urine with sulphuric

acid, and with a liquid-cart put it over the weakly plants. In about four or five weeks after, and to the time they were taken up, these turnips were as good as the others.

In 1844 all this ground was laid down with oats and grass, and, except lot No. 1, where (only) the turnip-tops were ploughed in, there was no perceptible difference in the crop of oats or clover, and all good.

No. 3.—*On Bones, with Sulphuric Acid and other Manures.*

By R. W. PURCHAS.

*Lindor's Farm, St. Briavels, Gloucestershire.*

THIS trial of sulphuric acid and bone-dust with other manures was made upon a worn-out arable field of a sandy soil, sown the beginning of August, 1843, with improved stone-turnips in lots of a quarter of an acre. The ground was ridged up at 24 inches, the seed drilled on the ridge, and hoed out to 8 inches; the turnips were horse-hoed three times, and hand-hoed twice.

The measure, weight, &c., are all calculated per Imperial standard. One perch of each lot was pulled, topped, and weighed on the 8th of January, 1844.

The expense and produce per acre are as under:—

No. of Lot.	Manure per Acre.	Expense per Acre.			Produce per Acre.		
		£	s.	d.	Tons.	cwt.	qrs.
1	15 yards fat pigs' dung, rotten . . . . .	3	0	0	15	2	3
2	3½ bushels bone-dust, and 80 lbs. sulphuric acid (oil of vitriol) . . . . .	1	0	6	13	1	1
3	40 bushels coal ashes, saturated with human urine in winter 1842-3 . . . . .	1	3	0	12	12	3
4	20 cubic yards road-scrappings, mixed with 280 gallons of human urine, and twice turned over in 1842 . . . . .	2	3	6	10	12	2
5	2 cwt. guano, mixed with 12 bushels pure charcoal-dust . . . . .	2	1	0	10	5	3
6	7 cwt. urate . . . . .	2	1	6	9	11	2
7	20 bushels bones (half dust) . . . . .	2	14	0	9	1	-
8	6 bushels bone-dust, and 20 bush. charcoal-dust . . . . .	1	13	0	8	17	0
9	4 bushels bone-dust, and 20 bush. charcoal-dust . . . . .	1	14	0	8	17	0
10	16 bushels bones (half dust) . . . . .	2	4	0	8	2	3
11	15 yards common straw dung (half rotten) . . . . .	1	10	0	6	13	1
12	No manure . . . . .	. . . . .	. . . . .	. . . . .	1	10	2

The turnips on lot No. 2, sown on the 8th of August, came into rough leaf before those on any of the other lots.

It is worthy of remark that Nos. 1, 2, and 3, are now (the 8th of January) in a very growing state, the tops weighing nearly 5 tons per acre.

The autumn and winter having been so very favourable for the growth of turnips, the crop would no doubt have been much heavier if a larger sort of turnips had been sown. Another thing which operated very strongly against the crop was (the field being sidelong), the hail and rain accompanying the dreadful thunder-storm of the 9th of August washed much soil and manure from each lot, so that in the steeper parts of the field there were few turnips. So severe was the storm, that the seed that had been planted the day before, was actually washed out of the ground, to the extent of about an acre of the part manured with the sulphuric acid, so that not a single turnip made its appearance. What was then deplored as an evil may turn out to be a great saving to the farmer, for although this part was not ridged up again and replanted for nine or ten days, the turnips grown upon it were fully equal to those on lot No. 7, having 20 bushels of bones per acre; thus showing that the solution had not been all washed away with the soil.

The fact that the storm did not wash away the solution in the last acre sown (although in the steep parts of the field the other manures except the dung were nearly destroyed), shows that perhaps half the quantity will be sufficient, and that the great chemist Liebig, to whom we are indebted for this valuable discovery, is right when he says that a much smaller quantity of bones and acid (viz. 40 lbs. fine bone-dust, and 20 lbs. sulphuric acid per acre) will produce a good crop of turnips.

*Pilstone, near Chepstow,  
20th February, 1844.*

---

No. 4.—*Report by the Committee appointed by the Morayshire Farmer Club to examine the Experiments made by Candidates for the Premiums offered for the Growth of Turnips by new Manures—Season 1843. Communicated by the President, His Grace the Duke of Richmond.*

THE committee found that there were two candidates for these premiums, viz., Mr. M·William, Sheriffston, and Dr. Manson, Spynie; and they took the opportunity of examining these experiments on the same day as that of the turnip-brakes. After duly ascertaining that the requisite quantity of ground was experimented upon, they proceeded to inspect, though not to weigh, the turnips. They found Mr. M·William's extended to no less than thirty and one-half acres, comprising nearly the whole of his turnip-brake.

The experiments were conducted with the minutest care and

attention, and would prove to agriculturists a most interesting study. In all the experiments he had been eminently successful, and the committee, with much confidence, award him the first premium.

Dr. Manson, as the only other competitor, the committee consider entitled to the second premium. His experiments show that good turnips may be raised by two cwt. of guano, bones, and sulphuric acid, at an expense of 1*l.* per acre; but are not sufficiently calculated to test the values of the different manures used.

The committee refer the Club to the reports of both these gentlemen as to the mode of conducting, and the result of their experiments, and which will be found to give them explicitly and fully.

The committee cannot conclude this report without commending Mr. M·William's enterprise and perseverance in the highest manner. The great apparent care and trouble taken by him in conducting and bringing to a successful issue these numerous trials, are deserving of the highest praise, not only as being conducive to the interests of agriculture, but to the community at large. His experiments are all simple, and easy to be understood; and when his report of the minute different results is before the Club, the committee have no doubt but they will derive much practical benefit from it. They recommend that the report should be printed, and a copy sent to every member, along with his description of a cart, constructed by himself, of simple mechanism and small expense, for the application of the bones and acid when diluted.

6th November, 1843.

(Signed)

JOHN STEPHEN.

WM. STUART.

JAS. GEDDES.

*Experiments made on Turnips with five different kinds of Manure, on the Farm of Gordon Castle, in the year 1843.*

The seed (Dale's yellow Hybrid) was sown on the 15th of June; and, as it was wished to ascertain the result while the Duke was at the Castle, the Turnips, before they came to maturity, were taken up on the 3rd of November, and carefully topped and weighed.

1st, One Imperial acre manured with 8 bushels of bones and 14 cubic yards of farm-yard dung, at an expense of 3*l.*, produced 12 tons.

2nd, One ditto, manured with 2 cwt. 91 lbs. of guano, at an expense of 1*l.* 17*s.* 4*d.*, produced 11 tons 4 cwt.

3rd, One ditto, manured with 16 bushels of bones, at an expense of 1*l.* 16*s.*, produced 11 tons.

4th, One ditto, manured with 83 lbs. of sulphuric acid and 2 bushels

of bone-dust, mixed with 400 gallons of water, at an expense of 11s. 6d., produced 12 tons 4 cwt.

5th, One ditto, manured with 83 lbs. of sulphuric acid, mixed with 8 bushels of bones, and sown with the hand, at an expense of 1l. 5s., produced 11 tons.

(Signed)

THOMAS BELL,  
Farm Steward.

Spynie, 20th October, 1843.

IN offering myself a candidate for the premium to be given this year for the best turnips raised by means of sulphuric acid and bones, I may, in the first place, mention that my field of 21 acres was last autumn deeply ploughed with three horses out of oat-stubble, it having previously carried a wheat-crop, after two years' ley, well manured. In the spring it underwent the usual process of cleaning, and received, about the 1st of June, 25 quarters of Linksfield lime. Drilling and sowing commenced upon the 10th, allowing 4 bushels of bones and 96 lbs. of sulphuric acid, properly diluted with water, to the acre. The manure was prepared by putting into a large vat, placed in a corner of the field to be sown, 32 bushels of bone-dust, and for each bushel was added 96 lbs. of water and 24 of sulphuric acid: there were thus in the vat at once 32 bushels of bones, 384 gallons of water, and  $47\frac{1}{2}$  gallons of sulphuric acid. The whole was allowed to lie for a fortnight previous to use, when it was found that the acid had nearly dissolved all the bones. The mixture was then drawn off, and added to water in a large water-cart, in the proportion of 1 gallon of the mixture to 50 of water, and which was distributed to the drills from 3 spouts into 3 drills at a time. The drills were previously slightly harrowed down, and immediately drilled up on receiving the liquid manure. Owing to the great drought which prevailed at the time of sowing, and the very recent liming, very few of the seeds vegetated till after the rain, which fell about a month from the time of sowing. The heavy gale which prevailed about this time cut down the greater part of the early plants, and has thus left the field deficient in some places. I observed that after the field came to be singled that it underwent that process in the order in which it was sown,—13 acres having been sown with farm-yard manure, and the remaining 8 with the bones and sulphuric acid—the plants from the acid keeping the lead of those sown with court manure, and are to-day a heavier crop, though not looking quite so healthy in the blade, owing to their having come earlier to maturity. The expense per acre, viz.:—4 bushels of bones, at 2s. 6d.—10s.; sulphuric acid, 96 lbs., at  $1\frac{1}{4}d.$ —10s.: 1l. Those laid down with court manure received 20 cart-loads per acre, at 2s. 6d. per load—2l. 10s. Weight, per imperial acre, as ascertained on the 15th of November, the date of weighing:—

	Tons.	Cwt.	Lbs.
Sulphuric acid and bones . . . . .	12	5	80
Court manure . . . . .	10	17	104

(Signed)

D. D. MANSON.

STATE of the different MANURES used in Experimenting on the raising of TURNIPS, on the Farm of Sheriffston, for the information of the Committee and Judges, with regard to the Premiums offered by the Morayshire Farmer Club.

Number.	No. of Drills.	Imperial Measures.	A. R. P.	Rate per Imperial Acre.										Gallons of Water.	Expense per Imperial Acre.	Weight per Imperial Acre.	Second Hooping.	Dates of Hooping first time.	Dates of Sowing.	Liquid above manure. Do. Gibb's. Laing's.*
				Load- of Dung, at 25l. per Lond.	Bushels of Bones, at 2s. 4d. for Mixed, and 3s. 5d. for Dust.	Lbs. Sulphuric Acid, at 14d. per lb.	Lbs. Sulphuric Acid, at 14d. per lb.	Guanos, at 13s. per cwt.	Gypsum, at 4s. per cwt.	Sulphate of Ammonia, at 21s. per cwt.										
SWEDISH TURNIPS.																				
147	Gibb's London Seed	1 2 17	1 2 17	27	1 3-5ths	46 2-5ths	..	..	..	..	397	May 31	July 8	£ s. d.	T. C. lbs.					
215	Do.	0 2 12	0 2 12	27	1 3-5ths	46 2-5ths	..	..	..	..	198½	June 2	10, 11	2 18 2	17 15 86					
324	Do.	1 0 0	1 0 0	27	1 3-5ths	28	..	..	..	..	6	3, 5	5, 6	3 14 10	18 12 16					
445	Laing's Swedes, raised at Sheriffston	2 1 5	2 1 5	27	9 3-5ths	28	..	..	..	..	6	3, 5	7, 8	3 14 10	16 17 96					
COMMON TURNIPS.																				
446	Dale's Hybrid, raised at Sheriffston	5 1 34	5 1 34	13½	1 3-5ths	46 2-5ths	..	..	..	..	397	June 13	19, 13 14, 15	1 13 5	20 6 48 13 13 64					
539	Do.	1 2 1	1 2 1	..	3 1-5th	92 4-5ths	..	..	..	..	794	14	22	0 17 5	15 14 72					
618	Gibb's Green-Top Yellow (Hybrid)	0 2 33	0 2 33	..	3 1-5th	92 4-5ths	..	..	..	..	397	15	24	0 17 5	15 17 56					
716	Do.	0 2 14	0 2 14	..	5 1-9th	..	2 62	..	..	..	..	15	25	2 5 1	16 11 88					
816	Elgin Green-Top Yellow, 0. 2. 13.	1 0 27	1 0 27	..	5 1-9th	..	2 62	..	..	0 96	..	17	26	3 3 1	15 14 72					
914	Do.	0 2 1	0 2 1	..	..	..	4 0	1 0	..	..	..	17	26	2 16 0	15 15 0					
1024	Do.	0 3 12	0 3 12	..	16	46	..	..	..	..	10	19	27	2 2 1½	13 12 16					
PRINCIPALLY GREEN-TOP WHITE.																				
1124	Mixed Seed	1 1 8	1 1 8	..	3 1-5th	92 4-5ths	..	..	..	0 88½	794	20	28	1 14 3	17 9 72					
1229	Do.	1 1 27	1 1 27	..	3 1-5th	92 4-5ths	..	..	..	..	397	21	29	0 17 5	14 14 32					
1339	Do.	1 0 30	1 0 30	..	3 1-5th	92 4-5ths	..	..	..	1 29½	397	23	31	2 3 10½	15 16 48					
1437	Do.	1 2 0	1 2 0	..	16	46	..	..	..	..	10	23	Aug. 2, 3	2 2 2	1½ 14 0 0					
Short Drills—																				
1568	White Globe (Gibb's London)	1 0 0	1 0 0	..	..	..	2 15	..	..	..	..	27	4, 5	1 7 9	18 2 16					
1672	Dale's Hybrid (Sheriffston Seed).	1 3 11	1 3 11	..	6½	..	0 62	..	..	..	..	8, 10	Hand-wedded Jul. 17, 18	1 2 44	13 16 8					
1716	Do.	1 2 32	1 2 32	..	..	..	1 86	..	..	..	..	15, 17, 7	18, 20	1 3 0	16 11 8					
18	Do.	4 2 33	4 2 33	..	16	46	..	..	..	..	10	19, 20	21	2 2 14	16 0 0					
18	Green-Top White	2 3 21	2 3 21	..	3 1-5th	92 4-5ths	..	..	..	..	794	28, 20	Aug. 5, 6	0 17 5	11 6 88					
Common Turnips																				
Swedes, as above																				
Total																				

\* Laing's Seed, part of No. 3, are decidedly superior to Gibb's in point of quality and hardiness, and, under the same treatment, much heavier. Gibb's began to rot early. Laing's were fit for using at the table in June.  
 † Dale's Hybrid have been raised on Sheriffston for years, and properly selected, and decidedly a superior variety to the other yellow sown.  
 ‡ White Globes, Gibb's London, superior variety of Turnip to the Green-Top White, which were of an inferior description—bought seen.  
 The superiority of the weights of some of the kinds of seed, used with the same treatment, will be distinctly seen. Gibb's London, White Globes, and the Dale's Hybrid seed raised by myself, at Sheriffston, show a decided superiority in weight; that due attention to the proper selection of seed will thus appear to be of the utmost importance.  
 The whole field was half manured for the previous year; Nos. 1, 2, and 3 got no manure for Barley after the Swedes; No. 4 got no manure—in part Campbell's steep, in part clean water steep, and in part dry, quantities not yet tested—the rest of the field was equally manured (say half) all over for Baileys after the Swedes; No. perceptible difference could be observed in the crop. The whole rather too heavy and lodged.  
 GEO. M. WILLIAM.  
 (Signed)

This Report was abridged from the state I gave in.

Nos. 10 and 14.—The bones were watered with the sulphuric acid the day preceding being sown.

No. 8.—The sulphate of ammonia, guano, and bones, were mixed together.

No. 11.—The sulphate of ammonia used was dissolved with the liquid.

No. 13.—The ammonia was sown on the turnips on the 22nd September; the weather being dry, it affected the leaves for a time, but afterwards the leaves became more vigorous; but the bulb did not grow in proportion.

Nos. 16 and 17.—The bones and guano were dibbled in with a mixture of saw-dust.

Part of two drills of each experiment, measuring 4 perches, were topped, tailed, and carefully weighed on 13th and 14th December.

The quantity experimented on was 30 acres, 2 roods, 29 falls. The liquid manure was prepared in the same way as reported on last year; but in place of being applied with a watering-pan, as then, it was put on with a cart, constructed on purpose, to do three drills at a time, and so as to give a regular and uniform discharge when nearly empty as when full, which cannot be done by any common discharge pipe. When the proportion of 2 bushels of bone-dust per Scots acre, or 1 3-5th imperial with the sulphuric acid, were applied with the full proportion of water, nearly according to Liebig, a portion of the mixture, equal to half a bushel of bones, was put into the cart, and filled with water, which went over exactly one-quarter of a Scots acre, the horse going at the rate of three miles an hour. When 4 bushels were applied with the acid to the Scots acre, with the same proportion of water in like manner, a half bushel was put in and filled up, which went over the quarter of an acre as before; but this had to be repeated, and gone over a second time. In order, if possible, to save this labour, several experiments were tried, with half the quantity of water; in this case the full bushel of mixture of bones and acid was put in at once, and the cart filled up with water, and went over the quarter of an acre Scots, thus effecting a considerable saving of labour; and, as far as I can judge from the experiments, with equal effect. When the proper proportion of water to be put in the mixture is ascertained by experience, the plugs which regulate the discharge may be graduated, and a series of them made so as to regulate the quantity of mixture per acre during pleasure, the horse going at the regular and common pace, without having to do so by augmenting or lessening the quantity of water, or by making the horse go faster or slower, the latter being difficult to regulate.

---

### *Crop 1844.*

With regard to crop 1844, the Swedes were raised with manure and liquid, as last year, but less farm-yard manure applied per acre: good crop.

Having been disappointed of a full supply of bone-dust early

in the season, I only got a small portion raised as I intended, and which, from the experience I have had, I consider the most advisable, when there is a deficiency of farm-yard manure, to apply along with foreign. That is, to get the finest bone-dust I can, and to sift out the finest of that, which I apply at the rate of 4 bushels per Scots acre, made into liquid with sulphuric acid and water, as in the preceding years, 1842-3. The bone-dust that was kept up by the sieve I mixed at the rate of 10 bushels bones and  $1\frac{1}{2}$  cwt. of guano per Scots acre, and sown. In so far as this was gone into this season, the turnips in both cases are decidedly superior in weight of bulb to those raised with 3 cwt., and in part 4 cwt. guano per Scots acre: the guano throws up a flush of tops, but do not bulb in proportion. The rest of the field was completed with bone-dust alone, at 20 bushels per acre, after a supply was obtained, but rather late to compare with the others: the turnips, however, are about equal with those raised with the guano, which were earlier sown.

GEO. M'WILLIAM.

*Sheriffston, 25th Nov., 1844.*

---

No. 5.—*On the Action and Application of Dissolved Bones.*

By JOHN HANNAM.

THE results of several experiments with bones dissolved in acid have been lately published. To these the attention of the public has been called, through the pages of the Journal, as affording good hope that the application will be found to be one of the most important savings which was ever held out in use of manure, and one which is likely to be generally useful.

When, now, it is considered how extensively bones are employed in the production of the turnip crop; that any improvement in their economy must be as extensively felt; and that we are indebted to science for this suggestion; it cannot be uninteresting to inquire how far these anticipations are likely to be realized.

Our object, therefore, is to learn upon what grounds these expectations are based; for which purpose it will be necessary to examine the *action and application* of the tillage as laid down by theory or developed by practice.

The theory of the action of dissolved bones has been thus put by Mr. Pusey (Journal, vol. iv., p. 408):—

‘Bones may be roughly stated to consist of fat, of jelly, and of an earthy matter called phosphate of lime. When they were first employed as manure it was doubtful, of course, to which of these substances they owed their beneficial effect, and many persons were unwilling to purchase bones which had been boiled, and had consequently lost their



grease. It was soon found, however, that boiled bones were as good manure as those that were unboiled. There still remained in the boiled bones two substances either of which might be their active principle. But Sprengel states that he found bones which had been burnt still act as manure; and Mr. Hannam has tried the same experiment with the same result. Now, as fire drives out of the bone the solid jelly which holds it together, there remains only the earthy matter behind, thus proved to be the manuring substance. This being phosphate of lime, chemistry suggested that, since lime was in so small a quantity, the phosphoric acid united with it must be the true manure contained in bones, and that if that lime was taken from it by sulphuric acid the phosphoric acid, thus set free, would be greatly strengthened in its immediate activity."

This view of the theory of the application should be taken with certain limitations; in fact, it only refers to a solution of *burnt* bones, as it depends on the assumption that the earthy part of bones is their only manuring substance. This, it is true, is asserted by Sprengel, and followed by Liebig, and certain of my own experiments seem to bear out the assumption. Thus in one case I found 16 bushels of bones, burnt to whiteness, give a better crop than 16 bushels of fresh bones. In two other cases, where the tillage was assisted by a half-dressing of farm manure, burnt bones did not act so beneficially; and in one, upon very poor soil, they completely failed. In all the cases, however, burnt bones acted more quickly than the fresh ones, and fresh bones the more efficiently when reduced to a fine *powder*. From which facts we may infer that the superiority of burnt over fresh bones, in certain cases, is owing to the former being more accessible to the plant. And other evidence sanctions this. Thus we know that burnt bones absorb large quantities of water, by which means the organic acids in the soil the more easily act upon the phosphates and render them soluble; that, in fact, they speedily decompose, while fresh bones, if not ground very small, are very slowly acted upon by any acid, and remain for a length of time in the soil unchanged. In the above trials, too, it will be seen that where the land was partially manured, so as to give the young plant a *start*, the fresh bones were, if anything, superior to the calcined ones, and that, when the land was very poor, though the burnt bones took the lead, they could not maintain it; a proof that though the phosphate of the bone may be the *chief* fertilizing element, it cannot of itself supply *all* the wants of the crop.

The only conclusion which facts warrant is that the phosphates are the *chief* fertilizers in bones; that they are more accessible to the plant when the fat is removed from the bone; and hence, in many cases, where the soil is not deficient in organic food, such is the necessity of a supply of these phosphates, that the removal of the animal matter from the bone has a beneficial effect.

Upon this ground—that the removal of the fat and gelatine facilitates the assimilation of the phosphate of the bone by the plant—alone can we explain the fact that dry bones can in any case be superior to fresh ones; for nothing can afford us a shadow of a reason for saying that the animal matter of the bone is of *no use* to vegetation. On the contrary, we know that fat and oil, if extracted from the bone, and applied to the soil, act as potent manures, and that the gelatine is, in composition and effect, analogous to skin, wool, horn, &c.,—substances which contain a greater supply of nitrogen, which they afford the plant in the shape of ammonia, than any other animal manures with which we are acquainted.\* At the same time it is possible that, by being applied together, the fat may *retard the decomposition of the gelatine*, and render the phosphate less soluble, and thus, in some cases, injure the efficacy of the application for the turnip-crop—which is of a quick growth, and requires a ready food in its early stages.

The whole case then stands thus:—Bones consist of two parts; one of animal matter, and one of earthy. Each of these, used separately, is a potent manure; yet when both are used together the effect is in some cases less, in many not greater, than when the earthy part *only* is used—in fact, the part is equal to the whole. It is, however, known that when the two parts are combined, as in fresh bones, the earthy portion is very slow of decomposition, or change of form, and that the more this power of decomposition is encouraged by reducing the bone to powder, so as to admit moisture and those acids which dissolve the earthy part, and make it ready for absorption by the roots of the plant, the more efficacious is its action as a manure; hence the conclusion is apparent that the facility of decomposition is of great importance, and that, as the earthy part when applied singly absorbs water freely and is easily soluble, it is this facility of decomposition, and the ready supply of phosphates which it gives the plant, that renders it capable of acting more efficaciously than when combined with a large amount of fertilizing animal matter—which matter has a tendency to diminish, or at least to retard, the supply of phosphates.

Upon similar grounds we may explain the fact that boiled bones are so very generally preferred to the fresh ones by the large turnip-growers, as they do not contain that fat which retards the decomposition. At the same time they still retain the gelatine which is so powerful an animal manure. So that while their phosphates are rendered accessible to the plant by the fat being ex-

---

\* Wool, hair, and horn contain 16 per cent. of nitrogen, while farm manure does not average more than  $\frac{1}{2}$ . The animal matter of bones contains more water than these substances, and it therefore decomposes more readily, and is more immediate in its effects.

tracted—for boiled bones absorb water and speedily decompose—they have in the gelatine an immediate supply of ammonia and other organic food.

Upon no tenable grounds, then, can it be maintained that the animal matter which exists in bones has no fertilizing influence, or that their earthy or inorganic constituents are the sole manuring agents. On the contrary, it will be seen that in the case of *green* or *fresh* bones the animal matter is that which almost entirely nourishes the crop—the phosphates in this case scarcely coming into action at all during the first crop—and that it is owing to this deficient action of the phosphates from causes already explained, that fresh bones are not as active in their effects on the turnip-crop as their elements would allow them to be if placed under more favourable circumstances. On the other hand, it is evident that when calcined bones are used their *sole beneficial* action arises from their inorganic matter, and, as this action is equal, and often superior, to that of the fresh bones, it cannot be denied that the phosphates alone have an extraordinary effect, and that to them we are indebted as the *chief* manuring element of bones. The conclusion, therefore, is that *each* constituent used singly is a manure, and that when combined their defects are diminished by the animal portion preventing the earthy from coming into action. Upon these principles, then, Science builds her theory of the application of dissolved bones.

“It is evident,” says she, “that the phosphates are essential to vegetable nutrition, and that they cannot be too accessible to the roots of the plant; also, that, after the animal matter in bones is removed by fire, these phosphates, through the action of the organic acids and water in the soil, are most easily assimilated by the vegetable; it is, therefore, in my power to suggest means by which you will imitate the process of Nature, hasten on the disintegration of the bone, and, by presenting it to the plant in a form ready for use, economize that portion of the tillage, which, owing to its being unfit for the use of the growing vegetable, remains in the soil at the expense of our fixed capital, until it wastes or is required by another crop.”

This it will be seen is the ground-work and object of the theory, as detailed at the commencement of this paper—a theory which has but a limited application, and referring merely to the action of calcined bones. Science, however, does not confine herself to this.

“It has been granted,” says she, “not merely that the earthy matter of bones is an essential food of the plant, and that the presence of the animal matter retards its action, but that that animal matter is of *itself* a potent fertilizer; hence, in dispelling it for the purpose of facilitating the decomposition of the earthy part, we

destroy an agent which is valuable. Thus, in order to get a ready supply of phosphates, we, in the case of *burnt bones*, waste both the fat and gelatine—while, even in boiled bones, the oil is for the same purpose extracted; in this case, however, we get a tillage superior to burnt bones, inasmuch as, while its phosphates are obtainable by the vegetable, it has also a fund of animal manure, and superior to green bones, inasmuch as, while it has a good share of the organic, its inorganic elements are not inactive.” “Would it not, therefore,” adds she, “be desirable to devise a means by which both the animal and the earthy part of bone manure may each be made to serve its own peculiar purpose in the vegetable economy without injury to the other; so as to prevent the waste of the animal part in order to prepare it for the crop, or of the phosphates by their not being ready for the roots? If so, it is in my power to suggest means by which bones may be reduced to the finest state of division, and used in such a form that the earthy parts may be readily assimilated, and the animal matter set at liberty to mingle in the soil and to perform its part in promoting vegetation, so that a great saving may be effected in the quantity used, owing to the nature of the mixture rendering it not necessary to apply more than the plant requires—which is but a small proportion of the quantity applied in their crude state.”\*

The means proposed to carry out these aims, need I add, were those to which our attention is now drawn, viz. to reduce the bones by the action of sulphuric or muriatic acid and water to the finest state of division, and to add water so as to be able to apply the manure in the form of a solution. In this process with sulphuric acid the earthy part is extracted from the animal, the acid combines with a portion of the lime (forming gypsum), while the remainder of the acid, and the remainder of the lime originally composing the phosphate, are dissolved, and form a double phosphate. This solution therefore contains a biphosphate of lime, in which the phosphoric acid exists in a much greater quantity than in the ordinary phosphate of lime which exists in bone.†

With muriatic acid a muriate of lime, and a biphosphate, is formed in a similar manner. This muriate of lime is a salt which attracts moisture greatly.

By this process the bone earth is rendered in a fine state of division; the free acids unite with the bases contained in the earth, and form other salts beneficial to vegetation; and the *whole of*

\* “The whole of the phosphates required by three crops, is contained,” says Liebig, “in 66 lbs. of bone-dust.”

† The biphosphate, free from water, contains  $71\frac{1}{2}$  per cent. of phosphoric acid, and  $28\frac{1}{2}$  of lime; while the bone earth phosphate consists of  $48\frac{1}{2}$  per cent. of phosphoric acid, and  $51\frac{1}{2}$  of lime.

the fertilizing constituents of the bone are reduced to a state best adapted to afford the turnip an immediate supply of food—by which reason less than one-half the quantity used in their ordinary condition will suffice to supply all the wants of the crop.

Such, then, are the ground-works and the details of the theory of the action of dissolved bones. Practice has already tested that theory, and careful experiments fully developed the peculiar action and effects of the application. These experiments are not very numerous; nevertheless, they will, I think, be found sufficient to carry out the truth of the theory which their results corroborate; as they bear on themselves evident marks of the care and correct observation which has attended their execution; thus, though carried on at one time, and in various places, it will be found that each experiment was observed to develop one *certain* peculiar effect. The experiments which I have met with, having special reference to the question, are those made by Mr. M. Williams, Mr. Geddes, and Dr. Monson, and reported to the Morayshire Farmers' Club; those of the Duke of Richmond, communicated to the Royal Agricultural Society of England; of Mr. Fleming, of Barochan, Paisley, published in the Appendix to Professor Johnston's 'Lectures;' and those of Mr. Finnie, of Swanston, communicated to the Highland and Agricultural Society of Scotland. My own experiments on the same subject were reported to the same Society in my Prize Report "On the effects of Special Manures."—(*Vide* Transactions, March, 1844.)

The following is a summary of the particulars and peculiarities of the action of the dissolved bones as exhibited in the trials alluded to:—

*Mr. M. Williams's Experiments.*

No. 1.

Date.	Manures and Quantity.	Application.	Produce per Acre.	Cost per Scotch Acre.
1842.	Bones . . . 20 bush.	Drilled . . . .	Tons. cwt. lb. 12 4 3	£ s. d. 3 3 0
	Bones . . . 4 bush.	} In 6,400 lbs. or 640 } gallons of water, } in furrow . . . }	17 4 5	1 8 6
	Sul. Acid . . 116 lbs.			
	Water . . . 224 lbs.			
	Bones . . . 20 bush.	} , , }	13 0 52	3 12 6
	Sul. Acid . . 76 lbs.			
	Water . . . 126 lbs.			

*Peculiarities.*—Difference between the applications and bone-dust applied in the usual way "was most marked"—"the sulphuric solution brought the turnips to the hoe 10 days earlier than the bones alone, and 4 days before the bones sprinkled with acid." "Came

earlier also to maturity." "The early season against them, as it checked their growth sooner than an ordinary one."\*

## No. 2.

Date.	Manures and Quantity.	Application.	Produce.
1843.	Bone-dust . . 2 bush. Sul. Acid . . 46 lbs. Water . . 112 lbs.	Diluted with water, 100 times weight of the acid . . .	"Gave a good crop for quality of the ground—poor thin land."
	Nothing . . . . .		

*Peculiarities.*—Turnips on the solution "came rapidly on for the hoe."

Mr. Williams made a numerous series of trials during 1843; as however the application of the solution was principally in conjunction with other manures, and on different varieties of turnips, it will be unnecessary to quote from them further than to say that they corroborate his former trials.

*Mr. Geddes' Experiments.*

Date.	Manures and Quantity.	Application.	Produce	Cost per
			per Acre.	Acre.
			Tons. cwt. lbs.	£ s. d.
1842.	Manure . . 15 loads. Bones . . 15 bush.	. . . . .	13 19 21	3 12 6
	Bone-dust 1 bush. Acid . . 67½ lbs. Water . . 201½ lbs.		In 6600 lbs., or 660 gallons of water . . }	13 10 21
	Bones . . 12 bush.	Dibbled . . . . .		11 9 21

*Peculiarities.*—"Sulphuric acid turnips made appearance first"—"the rapidity of growth continued to be maintained, and they came to hoeing 10 days before the dibbled bones, and 7 before the dung and bones." "The superiority of the sulphuric acid was visible at a great distance." "The warm season pushed *all the sorts too* rapidly to maturity, and they came to premature ripeness for want of moisture—especially the sulphuric acid turnips, which were too far gone to be benefited when rain did come—which tells in an unfavourable manner against their weight as compared with the others."

Mr. Geddes also "tried drills here and there throughout the field, with the same proportion of bones and acid as above, and the results were, in all cases, *similar* to those detailed."

*Dr. Monson's Experiments.*

Date.	Manures and Quantities. Per Acre.	Application.	Produce per Acre.	Cost per Acre.
			Tons. cwt. lbs.	£ s. d.
1843.	8 acres ma- nured with	with 50 times weight of water . . }	12 5 80	1 0 0
	Bones . . 4 bush. Sul. Acid 96 lbs. Water . 384 lbs.		10 17 104	2 10 0
	13 acres, with court-manure, 20 loads per acre .			

\* The remarks on the peculiarities resulting from the application are in all cases extracted from published Reports.

*Peculiarities.*—"Plants from the acid keeping the lead, and are a heavier crop to-day (Oct. 20th), though not looking quite so healthy in the blade, having come earlier to maturity."

*The Duke of Richmond's Experiments.*

Date.	Manures and Quantity.	Application.	Produce per Acre.		Cost per Acre.		
			Tons.	cwt. lbs.	£	s.	d.
1843.	Bones . . . 16 bush.	. . . . .	11	0 0	1	16	0
	Bones . . . 2 bush. Sul. Acid . . 83 lbs.	{ With 400 gallons of } { water . . . . . }	12	4 0	0	11	6
	Bones . . . 8 bush. Sul. Acid . . 83 lbs.	{ Acid spread over } { Bones and sown . }	11	0 0	1	5	0

*Peculiarities.*—"The turnips came into rough leaf sooner on that (the sulphuric acid) acre than on any of the other" (Letter of the Duke of Richmond, Roy. Journ. Agr., vol. iv., p. 408). "Turnips taken up and weighed, Nov. 3rd, before they came to full maturity, as it was wished to ascertain the result while the duke was at the castle."—(Farm-steward's Report to Royal Soc. of Agr.)

*Mr. Fleming's Experiments.*

Date.	Manures and Quantity.	Application.	Produce per Acre.		Cost per Acre		
			Tons.	cwt. lbs.	£	s.	d.
1843.	Bone-dust . . 16 cwt.	. . . . .	14	17 28	5	10	0
	Do. . . . . 10 cwt.	{ Dissolved in Muri- } { atic Acid . . . }	18	11 84	3	0	0

The same application Mr. Fleming tried upon potatoes, and the result was also, in the language of Professor Johnston, "greatly in favour of dissolved bones"—(Appendix to Lectures on Agr. Chem., p. 81).

*Peculiarities.*—None noted, except that "the crops braided well," and that the applications "which show the greatest weight, kept the lead of the others all the season"—(Appendix to Johnston's Lectures, p. 55).

*Mr. Fimie's Experiments.*

The only particulars given in the Report yet published are the following:—

1843.	Bone-dust, with 12 loads of Manure, gave a loss of . . . . .	£ s. d.	1 9 11½	} as compared with the produce obtained from 16 tons of farm-manure.
	Do. dissolved in Sulphuric Acid, with 12 loads of Manure, a gain of . . . . .		0 18 0¾	

*My own Experiments shew the following particulars:—*

Date.	Manures and Quantity.	Application.	Produce			Cost per				
			per Acre.			Acre.				
			Tons.	cwt.	lbs.	£	s.	d.		
1843.	Soil very thin limestone, and poor in condition.	Bone-dust . . . 16 bush.	Drilled with seed .	15	3	4	1	13	0	
		Bone-dust . . . 8 bush.								
		Sul. Acid . . . 168 lbs.	Diluted with water, equal to 50 times the weight of the acid, and applied in the furrow-ridge, ploughed up, and then seed drilled .	17	9	1	1	15	0	
		Water . . . 604 lbs.								
		Bone-dust . . . 8 bush.		Diluted and ap-}plied as above .}	17	7	1	1	19	6
		Mur. Acid . . . 168 lbs.								
Water . . . 604 lbs.	Diluted and ap-}plied as above .}	13	7	6	1	6	0			
Bone-dust . . . 8 bush. burnt to half original weight . . . . .										
Sul. Acid . . . 84 lbs.		No Manure . . . . .	7	0	6	.	.	.		
Water . . . 252 lbs.										

*Peculiarities.*—The sulphuric acid plots “started off with the lead, which they continued to increase, being at hoeing-time full a week in advance of every other except the muriatic acid, which followed them up very closely. They almost touched each other on the ridges, while the plants on the plot with no manure could scarcely be seen.” At hoeing-time “the most remarkable feature was the decided lead taken by the dissolved bones.” In “September the plants on the dissolved bones appeared to stop growing in the top, and to form a quicker bulb than the other lots.”

October 12th. The following notes were taken (vide *Trans. Highland Soc.*, p. 177): “*Bones and Sulphuric Acid.* Bulbs equal to lot 1st (there were twenty applications made in the experiment)—top small and light colour. *Bones and Muriatic Acid.* Ditto, ditto, top a shade darker in colour. *Bone-dust.* Bulbs not so large. *Burnt Bones and Sulphuric Acid.* Not so good in appearance as they were a month since. (Vide Prize Report on Special Manures, *Trans. High. Soc.* March, 1844, vol. i., p. 178.)

From these results the conclusion I then deduced was—

“That bones dissolved in sulphuric or muriatic acid have an extraordinary beneficial effect on the turnip-crop,—hastening the early growth, encouraging the formation of the bulb in the early season, and increasing the gross produce.”

This conclusion the practice of the above authorities\* confirms in every particular, and also shows that these advantages may be

\* Since this was written, the following trials by Mr. Gardiner have been published in his Report “on Special Manures,” to which the Royal Highland Agricultural Society awarded the second prize of 30l.



secured at a less cost of application than by the ordinary method. Thus from the foregoing trials we see—1st. That a moderate quantity of bones well dissolved acts as a tillage for the turnip-crop; and that a small quantity, even two bushels, of bones per acre, thoroughly dissolved, will produce a crop superior in weight to the usual quantity applied in their ordinary condition. 2nd. That a large quantity of bones very *partially sprinkled* with acid exhibits greatly augmented fertilizing influence; so that even the *direct advantage*, or saving, which we receive is a double one; viz., a saving in the quantity and the cost of the manure, and a saving, or gain, in the quantity of produce; for both of which advantages a pound, shilling, and pence estimate is in the preceding cases supplied. There are, however, other or indirect advantages, attendant on the application of bones in a state of solution, to which a monetary value cannot be assigned; they are, however, not the less important, or unworthy of our attention. Thus, in the first place, we have a quick growth of plant in the earlier stages of the season—a point which is universally allowed to be the grand desideratum in the cultivation of the turnip; since, by being pushed on, its infancy is shortened, and the many dangers of that period lessened, and the plant is enabled to defy the ravages of the fly and to spread at an earlier period its green leaf to the atmosphere; for the turnip derives a large share of its sustenance by the absorption through its leaves of the carbonic acid of the atmosphere.

In the next place, we have a continued quick growth and a tendency to form bulbs—advantages which may be turned to account. Thus, say that we care nothing for the chance of greater produce at a less cost—nothing for the almost certainty of conquering the fly and the other enemies of the turnip's infancy—there are many circumstances under which the power to grow a crop speedily is peculiarly valuable. For instance, it will enable us to grow a crop of turnips often, instead of rape, for autumn

POTATOES, 1843.

*Top-dressed upon farm dung.*

Bones dissolved in Sulphuric Acid and Carbonate of Magnesia gave . . . . .	} at cost of 28s. . . . .	14 tons. 5 cwt. per acre.
No dressing gave . . . . .		

OATS, 1842.

Bones and Sulphuric Acid } as a top dressing . . . . .	} gave 15 bush. 38 lbs. per rood { weighing 42 lbs. per bush., at a cost of 7s. per rood.
No top dressing . . . . .	

Soil—partly moss and partly gravel.

OATS, 1843.

Bones and Sulphuric } Acid . . . . .	} gave 18 bush. 38 lbs. per rood { weighing 39½ lbs. per bush., cost 8s. 4d. per rood.
No top dressing . . . . .	

Soil—stiff alluvial loam.

food, or when we wish to sow wheat upon the turnip fallow—a practice which is now far from being unfrequent, and which the increasing demand for wheat it is probable will render still more common. Again, a season may be unfavourable, and the soil unfit, or other circumstances may interfere so as to retard the time of sowing. In either case the quick growth of the plant, by the use of the application, is an object of importance, as it, in fact, gives us the power of having a good *early* crop or a good *late sown* crop.

Such, then, is *the action* of dissolved bones, upon the turnip-crop, as laid down by science, and as developed by practice, the particulars of which afford us good and sufficient cause for asserting that we are indebted to science for a discovery of “one of the most important savings which was ever held out in the use of manure.” How far that discovery may be made generally useful will be seen from the following inquiry into its application.

*The application of dissolved bones* (a tillage which has been shown in the foregoing pages to be attended with so many peculiar results, and, I may add, so many direct and indirect advantages) is a subject worthy of particular investigation, not merely because the public use of the advantages arising from this, or from any discovery, greatly depends upon its applicability to public and general purposes, but because that investigation, should difficulties exist, will give us an opportunity of removing them, or, should they not exist, of correcting an idea or impression which is generally *made a handle of* against anything that is new—the idea of the impracticability of the discovery;—a peg upon which many who will not venture to question the theory, or to deny the facts stated, will in this case hang an excuse for condemning the application before they test it. “Its effects may be good, but it is not calculated for general use; its application is a matter not adapted for the farmer. The lancet, which in the hands of the surgeon is a simple and useful instrument, if used by a novice is a dangerous weapon,” is the purport of the popular argument, and which is taken up by many practical men to whom the words sulphuric and muriatic acids suggest visions of murky laboratories and mystic operations which the farmer has no cognizance of,—forgetful that these wonderful acids are nothing more than *oil of vitriol* and *spirits of salt*, and that the same skill which is required to mix an effervescing draught is all that is required to make ready a preparation of dissolved bones. This will be seen from the following detail of the particulars connected with the application.

The points to be considered in the preparation and application of the tillage are—1st. the bones, sort, quantity, and condition of; 2nd. the acid, sort and quantity of; 3rd. the water, sort and quantity of; 4th. the method of preparation and use.

1st. The bones to be employed may be burnt, boiled, or fresh. If burnt, they contain nothing but the earthy constituents; if boiled, they hold also their gelatine; and if fresh, they retain the whole of their animal matter (both fat and gelatine) as well their earthy matter. The animal substance being a rich manure, it would appear that these fresh bones ought to be preferred in all cases as a manure; it has, however, been shown that this is not the fact, as the oil they contain prevents the plant, in such cases, from making full use of the other matters, the phosphates, &c., in the bone, which are of still more essential use. For the purpose, however of this application I should recommend the use of bones which contain as much of their animal matter as possible, as the acid acts upon the earthy part, frees it from the animal gelatine and oil, and prepares it for the plant at the same time that that animal part is set at liberty to serve its purpose; so that it would be bad economy either to destroy the animal portion of the bone by fire or to give the same price for such as for fresh ones for the purpose of this application. It is true that calcined bones are more easily dissolved; if, however, either boiled or raw bones be ground fine the acid will act upon them powerfully. But even should there be a few small portions of the bone imperfectly dissolved, I consider this no disadvantage, as they will act at the latter periods of the growth of the crop; for it will be seen, from the foregoing experiments, that the effect of the preparation is to make the plants grow quickly—a proof that they find plenty of accessible food—and that, in one or two cases, they appeared to fail in their vigour towards the end of the season—a circumstance probably arising from the *too fine state* of division in which the bone was. And this takes place, it will be seen by a reference to my experiment, most especially where *burnt* bones are dissolved. There is no necessity, therefore, to *waste* the organic portion of the bone in order to be able to bring it into a state of division which is really not so useful as that into which we can bring it without the loss of the animal portion. Whether this reasoning be correct or not, facts (as my detailed experiments show) prove the conclusion, that the unburnt bones are preferable to use in this form.

The quantity of dissolved bones most proper to be applied per acre is, practically speaking, an unsolved problem. Theory, however, says that, as the whole of the phosphates required for three crops is not more than 66 lbs. of bone-dust contains, it is fair to presume that, by giving the plant a chance, as we do by dissolving the bones, of making use of nearly all the tillage that we put in the soil, a very small quantity will suffice for the turnip crop; and, having found theory correct in the *principle* of the application, I do not see why we should doubt that practice will

not also confirm it in *detail*. Indeed, the quantity used by the Duke of Richmond and by Mr. Geddes was only two bushels per acre. At the present time four bushels, however, may be said to be a *safe mean* quantity (my own trials were with eight bushels) and an economical one. A few years, however, will undoubtedly put us in possession of the particular quantity which it is best to use. I have in execution at the present time an experiment which will I hope, throw some light on what is the best quantity of each of the ingredients—bones, acid, and water—to use.

2nd.—The acid employed may be either sulphuric or muriatic. The only trials with the latter upon turnips which I have met with are my own and Mr. Fleming's; in both of which, so far as final result goes, it stands well. In my case sulphuric acid appeared to be quicker in its effects, and at the latter period of the season the muriatic had the advantage. The muriatic acid, however, costs about  $\frac{1}{4}d.$  per lb. more than the sulphuric; I am disposed, however, to think that upon high and dry limestone soils this extra price may be afforded for the muriatic, as when it is applied along with the bones the free acid will combine with the lime in the soil, and form a muriate of lime, which is a salt that has a great tendency to attract and absorb moisture. The experience which we have had with the sulphuric acid must, however, compel us to give it the preference, except in the case referred to above, until the muriatic has been more generally used.

The proportion of the acid is as much unsettled as the quantity of bones. The condition of the mixture must guide us, if we require the bones to be well dissolved. The Duke of Richmond used the same weight of acid as of bone in one case; on the other hand, half that weight in several cases has acted well; and it may yet be found that a *still less* proportion of acid may be effectual; for it is not yet evident that *the most perfect division* of the bones is requisite, or that by having such that we may not run the risk of encouraging growth of plant *too* much at first. The Duke of Richmond used  $\frac{1}{4}$  lb. of acid to 1 of bone, and Mr. M. Williams a much less quantity with success. Another year, however, will, I hope, afford us experience sufficient to warrant a definite opinion being given. Till then half weight of the bones is a medium quantity of acid which *my own* experience allows me recommend.

3rd.—The water employed in diffusing the dissolved bones over the soil will, in all cases, for the sake of economy of carriage, be that which is nearest the field where it is required; at the same time, there are cases in which it will be possible to use the liquid from the tank which contains the urine and drainings from the cattle sheds. I would, consequently, strenuously urge that this plan should be adopted whenever local circumstances will permit. I have no doubt that such will be found the most beneficial

application which can be made of the liquid, as the free acid in the solution will combine with the ammonia in the liquid, and form soluble salts of ammonia, which, while they materially assist vegetation, will not waste, as the carbonate of ammonia which exists in the liquid is apt to do. Nor, indeed, will 600 or 800 gallons of liquid manure be a trifling addition to the fertilizing influence of the bones.

The quantity of water hitherto used has varied from 50 to 100 times the weight of the acid, but in all cases it is the rule to mix the acid with only twice or thrice its weight of water until the bone is dissolved; the use of the larger quantity being merely to diffuse the preparation more thoroughly in the soil, and to prevent any injurious effect upon the seed or plant from the strength of the acid. As, however, the free acid which is in the mixture, when spread upon the land, soon combines with the alkalies in the soil, and forms various salts, the *smallest quantity* of water that will serve to diffuse the mixture evenly I have no doubt may be used safely; the effect of such an application has not yet been tried. Should the result, however, of such trial answer my expectations, the use of the preparation will be greatly facilitated, as the quantity of water which has to be procured is an obstacle of consequence to many. The difference in the quantity required will be seen from the number of gallons of water required for 4 bushels of bones, and 2 bushels of bones, diluted with water:—

	Water 100 fold weight of Acid.	Water 50 fold weight of Acid.	Water 25 fold weight of Acid.	Water 10 fold weight of Acid.
4 bush. Bones . } 12 st. of Acid . }	1680 galls.	840 galls.	420 galls.	168 galls.
2 bush. Bones . } 6 st. of Acid . }	840 „	420 „	210 „	84 „

4th. The mode of preparing the mixture is very simple. The general rule is to put the bones into a wooden vessel, and to pour upon them twice their weight of water and half their weight of acid. The bones, if unburnt, require to be finely powdered. After the acid has been added the mixture is covered up, and allowed to stand two or three days. In this time nearly all the bones will be dissolved, or at least reduced to a fine powder; if so it is fit for use, and the proper quantity of water may be added to dilute it. Thus, in one bushel of bones we shall have

42 lbs. of Bones . . }  
21 lbs. of Acid . . } with 1000 lbs. or 100 gallons of water,  
63 lbs. of Water . . } if 50 fold the Acid be used.

The mixture may be prepared as easily on a large scale. To do this it will be necessary in the first place to provide several large

casks—say each to hold from 60 to 70 gallons. Into each of these, in the first place, we put 4 bushels of bone-dust, weighing 168 lbs. We then weigh out 84 lbs. of acid (half the weight of the bones), and immediately pour it and three times its weight of water (252 lbs. or about 25 gallons) into one of the casks. The same being done to all the casks, each will contain (at 4 bushels per acre) manure for an acre of land. When this is wanted for use, for which in the course of two or three days it will be ready, the casks may be taken to the field, and a certain part or proportion of the mixture taken out, and the proper quantity of water (at the rate of fifty times the weight of the acid) added. In order to do this conveniently, a rod, marked so that when inserted in the mixture it should show the quantity in the cask, should be procured. When, therefore, a quantity was required we can, by the aid of the rod, take out one-tenth or one-twentieth of the mixture at convenience; thus say the quantity for the acre in one of these casks should be 50 gallons, and we take out sufficient for one-twentieth of an acre—this is  $2\frac{1}{2}$  gallons. Now the whole cask requires diluting with fifty times the weight of the acid of water—*i. e.*, with fifty times 84 lbs., or 4200 lbs., or 420 gallons—before it is applied to the soil; hence one-twentieth of 420 gallons, or 21 gallons of water, must be added to the  $2\frac{1}{2}$  gallons, when it is put into the vessel by which it is spread. This calculation once made, we should know for the future that each cask required diluting with 420 gallons of water, and each gallon of the mixture (if there were 50 gallons in each cask) with rather more than 8 gallons of water.

The method of using this liquid is by some considered a great obstacle to the general application of the tillage; one cause of which objection is said to be the inconvenience of having the manure in a liquid form. In reply to which it may be urged, that as plants require their food to be in a state of solution, any extra trouble from such an application is repaid by the extra benefit to the crop; that as the quantity of water used is not *necessarily* very great, it is probable that a much less quantity, even than has yet been ventured upon, will serve our purpose, and that mechanical arrangements may be made so as to apply the mixture to the soil with uniformity and ease. The fact, however, that as yet there has been no machine brought out for the *special* purpose of effecting the distribution of the dissolved bones, is the ground-work, in most cases, of the impression that the process is a difficult one, for the indisposition to use our ingenuity in a matter of the sort is pretty general. It was, however, always so. The progress of agricultural mechanism was slow while it depended chiefly upon the suggestions of the farmer, who, though he had the best opportunity of designing that which was most useful, did not make use of it. The encouragement afforded by our agricultural societies to talent

and enterprise has brought out the exertions of our engineers and mechanics, who have, in a short space of time, effected many great improvements and removed many obstacles which we had accustomed ourselves from long habitude to consider as immovable. In this case, therefore, I have no doubt but that the engineer will come to our aid, and put us in possession of a simple agent by which so valuable an application may be made use of without inconvenience. Indeed I have good grounds for this hope. Within the last few weeks I have drawn the attention of Mr. Crosskill, of Beverley, to the subject, and he informs me of his readiness to give it his best consideration, and hopes to be able to make such additions to his liquid manure cart as will enable it to deposit the solution in the ridges, and to act as an efficient drill for the purpose. There was a very clever drill for liquid manure and seed, made by Mr. Huckvale, shown at the Royal Meeting at Derby last year, which I have no doubt would answer *our* purpose. The main objection to such an implement is on the score of economy. It cannot be expected that the farmer should procure a fresh drill, especially one for depositing seed and tillage at one time, for every variety of fertilizer which he may use. Any arrangement which may be made to act with the common water-cart, or with a manure-cart so much used as Mr. Crosskill's, is likely to be a great acquisition to the public, as the seed does not require to be drilled at the same time as the liquid, but can be more conveniently applied with the ordinary small drill upon the ridges, after the manure has been covered up.

A light and economical liquid drill-cart may be made of a common barrel that will hold about 36 gallons. This should be fixed to shafts, and have a tube through which the liquid may run into the ridge. The speed of the horse will regulate the quantity of liquid applied. It may, however, also be well to have two or three nozzles of various diameters, which will screw upon the end of the tube, and regulate the flow of liquid. The barrel should be placed below the axle, as it would allow a stirrer to be easily inserted so as to keep the liquid in agitation, by which means a sediment would not fall to the bottom, and the even distribution of the mixture would be facilitated. With such an implement it will only be necessary to ridge the land, as for farm-manure; brush off the tops of the ridges so that a little loose soil may fall into the furrow; put such quantity of the strong mixture from the cask as will serve for one or two rows, at the rate per acre we have determined upon, into the drill-cart; add the proper quantity of water for dilution to it when put into the drill (say 8 or 10 gallons of water to 1 of mixture, or otherwise, as we may calculate the proper proportion to be), and to pass along the line of ridges dropping the liquid upon the loose soil in the furrow. After this the ridges

should be ploughed up, and the seed drilled on the top, so as to lay just above the liquid. In this manner, after the liquid had been deposited by hand, the seed was put in, in most of the foregoing experiments.

It has been suggested that the liquid should be "mixed with dry earth or ashes, so as to be used by the ordinary method of drilling." However desirable this may be to do, it is not easily practicable. My own attempts have been unsuccessful. Wet lumps are formed which it is impossible to separate, and such a *large* quantity of dry earth is required to make the compost "*run through the drill*," that so small a weight of bones cannot be *evenly* incorporated with it—a matter of vital importance to the crop which depends upon the application. Where calcined bones are used, owing to their containing merely the earthy portion of the bone and to their being so easily dissolved, a dry superphosphate of lime *may be formed*. For effecting this, Mr. Lawes, of St. Albans (whose experiments, along with those of Mr. Purchas, which were reported to the Monmouth Farmers' Club, I have not met with), gives the following excellent and simple directions for making this superphosphate:—

"Calcined bones are to be reduced by grinding to a very fine powder, and placed in an iron pan with an equal weight of water (a cast-iron trough, such as are sold for holding water for cattle, will do); a man with a spade must mix the bone with the water until every portion is wet: while the man is stirring, an assistant empties at once into the pan sulphuric acid, 60 parts by weight to every 100 parts of bone; the acid is poured in at once, and not in a thin stream, as commonly recommended; the stirring is continued for about three minutes, and the material is then thrown out. With four common farm-labourers and two pans, I have mixed 2 tons in one day. The larger the heap that is made the more perfect the decomposition, as the heap remains intensely hot for a long time. It is necessary to spread the superphosphate out to the air for a few days, that it may become dry."

These, then, are the particulars to be regarded in the application of dissolved bones, none of which, it will be seen, offer any *real* obstacle to the use, by the intelligent farmer, of a system of economy which theory and practice have alike shown to be advantageous. We may, therefore, I think, safely say that the *preamble* of our *case* is proved, and that we have, indeed, every reason to believe that the application of dissolved bones as a manure for the turnip-crop, offers us "one of the most important savings which was ever held out in the use of manure;"—one, too, which "affords good hope of being generally applicable."

---



XXVII.—*Observations on the Natural History and Economy of various Insects affecting the Corn-crops, many of them improperly called Wireworms; including Ground-beetles, Chaffers, or May-bugs, also the Caterpillars of a Moth and Saw-fly, and the larvæ of some minute flies.* By JOHN CURTIS, F.L.S., Corresponding Member of the Imperial and Royal Georgofili Society of Florence; of the Academy of Natural Sciences of Philadelphia; &c.

## PAPER VII.

It being as much my earnest desire to impress upon the agriculturist the value of scientific knowledge, as it is my constant hope that these Essays may enable him to detect more promptly his enemies, and likewise make him thoroughly acquainted with his friends, namely, the insects and other animals which Providence has ordained to subdue the noxious species, in order that the remedies suggested may be well directed, I am tempted to introduce as a preface to my present subject a paragraph from a practical and sensible author, who is equally convinced with myself of the value and importance of a knowledge of insect economy. "The different sorts of grain," says Kollar, "from the period when as seed they are committed to the earth, until they have attained perfect maturity, are exposed to the attacks of various kinds of insects. The farmer, who is entitled, when the weather is favourable, to expect a plentiful crop from the soil, often finds his hopes disappointed, without being able to imagine the cause. An insect which escapes his notice from its minute size, as well as from the difficulty of finding out its abode, is at work destroying the fruit of his labours. The agriculturist who is unacquainted with the economy of insects, seeks in vain for the author of this destruction, and not unfrequently attributes it to creatures which, in reality, are his benefactors."\*

In the investigation of the insects infesting our corn-fields, I shall proceed with the growth of the plants, as nearly as my materials will allow, and trace the ravages occasioned by the various species that feed on the roots and stems, others which attack the flowers and ears in the field, and those which consume the grain when housed. It is therefore only necessary to remind the reader, that the history of the Corn-insects was commenced in our last paper,† in our account of the Wireworms, which attack the stems close to the roots.

In the Linnean Transactions for 1808,‡ are some observations

\* Kollar's Natur. der Schäd. Insecten, p. 98; and Kollar's Treatise on Insects, p. 86.

† Journal of Royal Agr. Soc., vol. v. p. 180, and pl. I. f. 29.

‡ Ibid. vol. ix. p. 156, and pl. 18, f. 1—3.

by Thomas Walford, Esq., F.L.S., regarding an insect that was destroying the wheat, supposed by the farmers of Essex and Suffolk to be the Wireworm. In October, 1802, Mr. Thomas Olley, of Stoke, near Clare, in Suffolk, showed Mr. Walford some green wheat which was dying and losing plant very fast, the reason of which he could not comprehend. On examining the plants, Mr. W. discovered three of the larvæ (pl. K. fig. 2), two of which were in the act of destroying the wheat (fig. 4). "With their projecting jaws, these insects cut round the outside grass (fig. a), about an inch below the surface of the soil (fig. b), to get at the young white shoot in the centre, which they eat: upon this vegetation is immediately stopped, and the plant dies. I suspect that they first eat the flour in the grains, which has not been drawn up by vegetation; for, when we touched them, they ran into the husks (fig. c); and two of the three insects I carried home in the husks, which appear to be their habitations, and probably the place where they change from the larva to their perfect state."\*

It is now upwards of forty years since these facts were promulgated, and yet we know no more of the economy of this singular little animal than Mr. Walford did. He was inclined to think it might be the larva of a *Staphylinus*, or Rove-beetle, only that he considered they were entirely a carnivorous family, and the same objection may be made to its being the larva of a *Bembidium*, or some minute *Carabus*, which I suspect it to be. It is somewhat remarkable that one has never heard of the reappearance of this insect; but that may be owing to all ravages of the kind being at once attributed to the Wireworm, which unfortunately has hitherto stopped all further inquiry.

1. *Staphylinus?* or *Bembidium?* The colour of this larva, which is not a quarter of an inch long, is not mentioned; but in all probability it is ochreous or tawny: the head is armed with strong jaws for cutting, and furnished with feelers and two small horns; it has six thoracic legs, terminated apparently by single claws; there are two rows of spines down the back, and another on each side of the body, which is composed of eight segments, besides the anal one, which is furnished with a sort of tail or prehensile foot, and two four-jointed setæ or feelers, to be employed when walking backward, as the antennæ are in advancing forward (fig. 2; fig. 3 being the same highly magnified).

"The injury," says Mr. Walford, "which the public sustains by the ravages of these insects, may in some measure be calculated from Mr. Olley's loss in 1802: he sowed 50 acres of a clay soil with wheat; out of these 10 were destroyed by them, which were replanted by dibbling in one bushel of seed per acre. The

---

\* Linn. Trans. vol. ix. p. 157.

price of wheat at that time was 8s. per bushel. We here observe one-fifth part of the quantity sown was destroyed by these noxious insects."

From data furnished by a gentleman of great experience and observation,\* Mr. W. calculated that "the quantity of wheat lessened to the market by the depredations of the Wireworms is very frequently, if not annually, 60,000 bushels; which occasions to the farmer an additional expense of at least 15,750*l.*" This was merely the value of the seed resown on clover lays, old pastures recently broken up, pea and bean stubble, &c., dibbling in and harrowing.

2. *Harpalus?* or Ground-beetle.—Figure 5 represents a curious larva, two of which were transmitted to me dead, in February, 1841, by a gentleman † who considered they were injuring his corn in a similar manner to the Wireworms. As he did not succeed, I believe, in rearing them, I cannot determine what beetle they would produce, but probably some Carabideous species, in which case I should be rather disposed to consider that they lived upon the Wireworms, &c., but this is not a natural consequence, as we shall shortly prove, for although most of the Carabidæ are carnivorous, there are some which feed upon the corn-crops both in their larva and beetle states.

This larva is  $4\frac{1}{2}$  lines long, hairy, of an ochreous colour, having an enormous head, but tapering towards the tail, which is rust-coloured; the face is sloped off gently, with a group of minute black dots on each side, looking like eyes; the two antennæ are porrected, slender, hairy, and five-jointed; the jaws are very strong, not crossing, semilunate, toothed internally, the apex appearing pointed, but it is rounded and black; the maxillæ are elongated, as well as the labial palpi, which are bi-articulate, the basal joint being the stoutest, the second long, incurved, slender, and tapering; the maxillary palpi are shorter and bi-articulate; the first thoracic segment is very broad and strong, of a ferruginous tint, the two following and the eight abdominal segments are of a dull ochreous tint, gradually tapering to the tail, which is furnished with a prehensile foot and two longish, tapering, articulated feelers; the sides of the body are margined and plaited: it has six pectoral jointed legs, spiny, and terminated by two long claws: fig. 5; fig. 6, the same magnified. I ought to state, that not having seen the animal alive, it is very probable the abdomen may have shrunk, and consequently may be represented not stout enough.

The economy and history of the next depredator have been well investigated by the German naturalists, and therefore are well

\* Allen Taylor, Esq., of Wimbush Hall, Essex.

† W. J. Clark, Esq., of Buckland Tout Saint, Totsex, Devon.

known. It is a predaceous beetle which belongs to the Order COLEOPTERA; it is comprised in the Family CARABIDÆ, and forms with some other European insects the Genus ZABRUS, and the species is named

3. *Z. gibbus* by *Fabricius*, *Carabus tenebrioides* by *Panzer*, *C. spinipes* by *Scopoli*, and *C. gibbus* by *Marsham*. It is convex and elliptical, but broad, of a deep piceous colour, smooth and shining: the mouth is ferruginous; the jaws are strong;\* the antennæ are not so long as the thorax, filiform, eleven-jointed, and pubescent, excepting the three basal joints; the eyes are small, but prominent; the thorax is broad, a little narrowed before, all the angles are rounded, the sides margined, the surface is delicately striated transversely with wavy lines, and a channel down the middle, the base being depressed, thickly and coarsely punctured, with a shallow fovea on each side of the centre; the scutellum is trigonate, but minute: the elytra are a little broader than the thorax, but not so shining, with a faint olive-green tinge, and are notched towards the apex; there are eight deep-punctured furrows on each, the sutural one furcated at the base, and the outer one is strongly punctured at the shoulder and towards the apex; the wings are ample, and folded under the wing-cases; the legs are stout and bright ferruginous, the thighs are robust and piceous; the tibiæ are armed externally with series of short spines and dilated at their extremities, especially the anterior, which are well adapted for burrowing, they are notched near the apex and furnished with three spurs, the others have only two; the tarsi are slender with series of spines beneath, and are five-jointed, the three basal ones being dilated in the anterior pair in the males, the terminal joint is clavate, and produces a pair of claws. Fig. 7 represents the female slightly magnified, the length being six lines, the breadth nearly three; the male is sometimes smaller.

The female beetle lays her eggs in clusters in the ground, and the larvæ they produce appear to be three years in arriving at maturity, from their being found half grown, in company with pupæ at the same season, and they frequently are accompanied by the larvæ of *Melolontha solstitialis*, "the small or summer Cockchafer." They are of a brown colour, the sides and under side whitish, nearly linear, but tapering at the tail, somewhat depressed, slightly hairy, and about an inch long; the head is broad and armed with two strong jaws, slender palpi, and two fine four-jointed antennæ, placed before the eyes: the first thoracic segment is very large and subquadrate, the second and third are shorter, as well as the nine abdominal ones; there is a transparent line down the back, a brown callous spot on each side of the segments, where

---

\* *Vide* Curtis's *Brit. Ent.*, pl. and fol. 188, for the dissections, &c.

the stigma or breathing-hole is situated, and above these is another line of brown warts, all thickened and producing hairs; the segments beneath have a similar callous spot at the middle of each, with four behind it, excepting the penultimate segment, and the anal one is brown and small, furnished with a proleg, and two short, pointed, hairy horns composed of three joints: the six pectoral legs are jointed and terminated by claws. Fig. 8; fig. 9 being the animal highly magnified.

These larvæ, which seem to be closely allied to the preceding specimens (figures 5 and 6), bore into the earth, forming sometimes immense numbers of perpendicular burrows (fig. 10, *d*), which often commence in a curve (*e*), and extend from a few inches to two feet in depth; and when they are full grown they form at the termination of the burrow an oval cavity (fig. *f*), smooth on the inside, in which they change to an exceedingly soft and sensitive pupa of a yellowish white colour, with two little black eyes; and as it becomes more matured, the various members of the future beetle are distinctly developed. They remain in this state only three or four weeks, for the larvæ had changed to pupæ the beginning of June, and at the end of the month and the beginning of July the beetles made their appearance.

So serious was the mischief caused by these insects in the vicinity of Halle in Saxony, in 1812, "that the Society of Naturalists in that city appointed a committee of its members to examine into the case on the spot."\* They were first observed in a field of wheat which they devastated, and when wheat was again sown they destroyed it a second time: they then attacked the rye, and afterwards the barley. In the Canton of Seeburg in Halberstadt alone, about 30 acres of corn were destroyed by the larvæ, and in July the beetles came forth in enormous swarms, crawling by night up the straws and eating the grains in the ears,† but concealing themselves by day under clods of earth, stones, &c., so that the beetles were nearly as mischievous as the larvæ; but it seems probable that when the beetles appear in excess the mischief may remedy itself, for when they cannot find corn to feed upon, they will attack and destroy each other, such at least was the case with some confined in a box.

The larva, however, is the most formidable enemy; it issues from

---

\* I am indebted to Kollar and his translator for many of the following facts, which had been, however, previously made known by Germar.

† There are other *Carabidæ* which, it is presumed, live upon seeds and vegetables. Mr. Ingpen states that a specimen of *Pocillus cupreus* was taken in the act of devouring a common pea (*vide* Trans. Ent. Soc.). I frequently find some of the smaller *Amaræ* on rushes, &c. by the sides of ditches; and *Curtonotus aulicus*, a species nearly allied to *Zabrus*, is far from uncommon on the foliage of thistles.

the earth by night, and eats into the stem of the corn close to the surface and feeds upon the pith, retiring on the approach of day and lying concealed upwards of 6 inches deep in the earth. "Their devastations were confined to the *corn-fields*, and were comparatively trifling even in those fields where vetches or potatoes were cultivated with the wheat; and the wheat, rye, and barley fields contiguous to vetch and potatoe fields were not attacked. In a field which had been first sown with wheat, and destroyed, and again sown with wheat and vetches together, marks of the devastating powers of the insects on this second sowing were observed, together with a number of pupæ in the earth. The destruction commenced in those fields which lay near pastures, in the vicinity of rape, fallow, and stubble fields, and spread from them: as the ravages were greatest in the beginning of spring, the larvæ appeared to have retired to the pasture lands for their winter-quarters, and thence proceeded to attack the neighbouring fields. Their great numbers in fields lying near stubble and fallow fields is easily explained, as they are the offspring of those which, the preceding year, lived on the crops grown in those fields."

Sig. Passerini of Florence also notices in a Memoir "the ravages occasioned by larvæ in the winter and spring of 1832-3, on the wheat in the provinces of Bologna, Romagna, and Ferrara, by devouring the cellular tissue of the leaves and stalks of the young plants, and thus causing them to perish: these attacks are made during the night time, the larvæ concealing themselves under ground during the day. They had been ascertained by Professor J. Bertolini of Bologna to be the larvæ of *Zabrus gibbus* and *Calathus latus*,\* and appear to be equally injurious. Sig. Passerini suggests to plough up the land, and then to turn in a flock of poultry, which would greedily pick up the larvæ." †

The Halle committee also recommended that the crows and other birds which live upon insects should on no account be destroyed, and they suggested that children might be employed in the fields to turn over stones and clods in the daytime for the beetles, and in the evening and at night they might be swept off the ears of corn with a net formed of a ring of strong wire, having a bag attached to it made of coarse canvass, about 18 inches long; the ring must have a ferrule to fasten it to the end of a strong light stick. As soon as the first slight frosts set in, the end of autumn, the infected lands should be ploughed deep, by which means the larvæ would be exposed and killed, or picked up by rooks and other birds; but it is said that this process, to prove

\* I find Zimmermann has stated that two other Carabidæ, *Amara communis* and *A. trivialis*, feed also upon the wheat.

† Trans. Entom. Soc., vol. i. p. liv.

efficacious, must be persevered in for many successive years, and by all the farmers simultaneously. The sulphuric acid contained in peat-ashes, and liberated by rains, renders them very advantageous in destroying these insects: the ashes should be strewed thickly in the spring on the autumn-sown fields.

It is true that these insects have not as yet been ascertained to have attacked the crops in England, like those we have recorded on the Continent: favourable circumstances, however, may increase their numbers, so as to render them at some future period a pest in this country, for the beetles are found scattered about. I have not unfrequently picked up specimens in August and September in sandy corn-fields in Norfolk, Kent, and the Isle of Wight, and they have been detected at the roots of grass nearer London; several were also taken off umbellate plants in Hants;\* and that they live through the winter has been ascertained by Mr. Tulk, who kept several individuals alive for many weeks during the winter of 1837-8 by feeding them on corn.†

We learn from Kollar that there is a species of beetle called the "Field Cockchaffer," which is injurious to corn. This insect likewise belongs to the Order COLEOPTERA, the Family MELOLONTHIDÆ, and the Genus ANISOPLIA: the species was named by Linnæus

4. *A. Agricola*: head and thorax deep green, thickly and minutely punctured, with pale pubescence, and a channel down the middle: the head is narrowed before, forming a produced clypeus, with a recurved margin: antennæ small and 9-jointed, the little club being trilobed: the eyes are small and lateral: the thorax is twice as broad as the head, slightly narrowed before, the sides rounded, the base sinuated: elytra ovate, rather short, broad, shining rusty ochre, they are covered with crowded faint punctures and several indistinct striæ; a black square spot surrounds the scutellum, which is rather large, black, and semi-orbicular; the shoulders and external margin are irregularly black, and there is a curved interrupted piceous line across the back, but these spots are more or less ferruginous and brown in different varieties: wings ample: the two last segments of the abdomen are exposed, black, and densely clothed with yellowish white depressed hairs, as well as the under side of the abdomen; the apex is conical and the hairs at the tip orange: the legs are strong and punctured, piceous with a greenish tint: the anterior tibiæ are dilated and bi-lobed externally, the others are short, spiny, and spurred; the tarsi are 5-jointed, the claws are unequal,

\* Curtis's Brit. Ent., fol. 188.

† Kollar's Treatise on Insects, p. 91.

and the inner one is bifid, but obscurely so in the two hindermost: length about 6 lines, breadth 3: fig. 12, magnified.

These beetles are abundant on the Continent, and are found sitting singly or in little groups on the ears, nibbling the soft grains of rye, and of wheat, which is still more to their taste. Kollar says he has found ears which had been robbed of a third part of their seeds by these insects, but he had not ascertained whether the larvæ attack the roots of the corn, or subsist only on manure, and no means can be resorted to for destroying them, as they live in concealment: he adds, "Crows, moles, and field-mice are their greatest enemies, and should therefore be spared, when their numbers are not so great as to make them injurious."\* Although common in France, Germany, and Italy, *Anisoplia Agricola* is very rare in England, and my principal object in introducing it is to call attention to the May-bug, which is nearly related to it, and exceedingly abundant in hedges and corn-fields, but whether it be prejudicial to our crops of corn I am not able to learn at present. It seems to be a general feeder, for in May, 1833, it destroyed the roses, devouring both the flowers and leaves, so that in some gardens scarcely a plant was left untouched, and they hung upon the flowers like swarms of bees: † the previous year the apple and nectarine trees fell a sacrifice to their ravages. In the Lake districts of Cumberland these beetles are called Bracken-clocks by anglers, from their frequenting the fern, and are employed as a bait for trout. Stewart asserts that they destroy every sort of fruit-tree, excepting the common pear; and Mr. Dillwyn says, near Swansea they are "extremely common every summer, particularly on roses, and appeared in immense numbers in 1814, when on their first appearance the sparrows on my lawn were so gorged with them, that several were unable to fly." ‡ They were also in such multitudes on the acacias near Petersfield, that the foliage was consumed, and when the trees were shaken they fell down like a shower of hail. § I have also observed them in June and July feeding on bramble-leaves, which they perforated like a sieve, and likewise on the eglantine.

This beetle, which belongs to the same Order and Family as the foregoing species, was named *Scarabæus Horticola* (the Garden-chaffer), by Linnæus, and is now called

5. *Anisoplia Horticola*: it is very glossy and sparingly clothed with longish hairs, dark on the upper side and yellowish beneath: the head, thorax, and scutellum are bright green, sometimes with

\* Kollar's Natur. der Schäd. Insecten., p. 104.

† Curtis's Brit. Ent., fol. 526.

‡ Memoranda relating to Coleopterous Insects, p. 31.

§ Gardener's Chronicle, vol. 4, p. 700.



a violet tinge; the head is thickly and roughly punctured; the thorax finely and more sparingly; the clypeus is broad and nearly semicircular, the margin reflexed: the 9-jointed antennæ are ferruginous, the trilobed club and palpi are piceous: the elytra are bright tawny, elliptical-ovate, with seven distinct and several obscure irregularly punctured striæ on each: wings ample: the apex of the abdomen, called the pygidium, is exposed and bottle-green: the under side and legs are greenish black, the anterior pair being the stoutest, the hinder the longest; the first pair of tibiæ are notched externally, forming two distinct lobes or teeth in the males, the others are spurred at the apex; the tarsi are 5-jointed and spiny beneath, the terminal joint is clavate and furnished with unequal claws, the internal one being broad and bifid in the two anterior pair, the hinder ones being simple: length  $4\frac{1}{4}$  lines, breadth  $2\frac{1}{4}$ : fig. 13, the male, magnified. These beetles might be collected into bags by children, and after being crushed or killed in hot water, they may be given to poultry, which fatten well upon them. The best period for this picking is early in the morning, as the beetles are torpid and sluggish when the dew is upon them.

It is, however, the larvæ which are so destructive, especially to pasture lands, and they would therefore more properly form a portion of a future essay, but as it will be equally serviceable to complete the descriptions and economy of the insect at once, I have added a figure of the maggot, which can be referred to when we arrive at the insects affecting the artificial and other grasses, at which time the best modes of extirpation will be discussed.

These larvæ are very similar to those of the cockchaffer (*Melolontha vulgaris*), but much smaller; they generally lie curved up, somewhat in the form of a horseshoe (fig. 14), yet they are rather active, and can walk tolerably well, dragging their heavy bodies after them: they are of an ochreous white colour, but the head is deep ochreous and destitute of eyes; the two little horns are very distinct, slender, and 5-jointed, the mandibles are somewhat rust-coloured and black at their tips, the body is clothed with a few brown hairs, the heavy apex being lead-colour whilst the animal is feeding, but it is like the rest of the body when the stomach is empty: on the breast and immediately behind the chin are six longish legs, clothed with bristly hairs, they are triarticulate, the third joint short; the claws are small and acuminate, with one or two bristles on the sides. They form cells of the surrounding earth at a considerable depth in the soil they inhabit, where they undergo their transformation into delicate pale-coloured pupæ.

I shall now have to treat of some insects affecting the ears of corn, and I shall avail myself of the information obtained from

Dr. I. W. Calvert,\* to make the agriculturist acquainted with a caterpillar which is very destructive in some districts. Dr. C. says, in a letter dated January, 1841, "I have been much annoyed at Snilesworth for the last three years, by a brown streaked grub or small caterpillar, about an inch long, attacking the wheat-ear chiefly in the manner of a leech sucking. It pierces the chaff, and empties it of its contents, whether in a milky or farinaceous state (fig. 15, *g* and *h*). I have left some at the Entomological Society's rooms, and have attended two of their meetings, but could not hear of any thing of this sort ever being observed before, nor can I learn that they have been noticed by any of the tenants at Snilesworth. They first made their attacks about the beginning of September; so that if I can hasten the harvest by forward sowing in the previous autumn, they may find themselves too late to do material mischief; hitherto, however, it has been more than we could do to get the corn ripe at all, the seasons having been so wet of late. I have some of the caterpillars confined in the earth, where they have buried themselves, and hope to give a better account of their origin and history next year." The following August I received a communication from Dr. Calvert, saying that these caterpillars had not been observed in the previous year until the 1st of September, when they were from a quarter to half an inch long; that in the standing corn they perforated the chaff and nearly emptied the grains of their contents. During the reaping of the harvest they were also found lying on the surface of the ground; and in the stack or barn, after the corn was carried, committing their depredations there. In the month of November Dr. C. gave me several of the caterpillars which were feeding upon wheat-ears in a bottle; some of them were no larger than fig. 16, others had attained the length of fig. 17, but were scarcely so robust, except when they drew themselves up; these were of a dull rosy brown, freckled, wrinkled, and sparingly clothed with short hairs; the head was horny, of a dull chestnut-colour, with two black stripes on the face; the first thoracic segment was horny also, shining and piceous, with three yellow stripes, the central one extending the whole length of the back, and distinctly defined with dark edges, the lateral ones are continued along the sides, but these become duller and are less distinct; they approximate at the tail, where the intervening spaces are piceous; each segment bears four black dots, the hinder pair being farthest apart; there is a brown irregular line along the spiracles, which are black.

It is remarkable, but in conformity with the usual laws of Creation, as regards insects at least, that when a species becomes abun-

---

\* Of Snilesworth, Yorkshire; communicated by Professor Henslow.

dant in one district, in all probability it will make its appearance simultaneously all over the kingdom; and this has been the case even with species that had up to a given period been very rarely seen. Such was the case with these caterpillars, as will be evident by comparing the following dates with the previous ones: for in the beginning of September I received examples from a friend in Surrey, saying that the rubbed out produce of some rye from seeds found in a sample of Spanish wheat in 1839, was full of them; again, in August, 1841, the same party transmitted me more specimens, the size of fig. 16, which I will describe, as they differed at this stage of their growth from Dr. Calvert's full-grown examples: one of them was pale green, with four reddish brown stripes forming three yellowish green lines down the back; the head and pectoral feet were brown, the first thoracic segment slightly horny and shining, and each of the abdominal segments had four black dots between the stripes, as in the larger ones; a black dot characterized the spiracles, and there were three or four black dots on the thighs and feet, on the pale green, which extended under the body; down the centre of the belly were 5 or 6 dusky spots. I should not omit to mention, that I also received this caterpillar in the beginning of last June, from Mr. M. Saul, of Garstang, Lancashire, who discovered it upon the young wheat, but it did not appear to be very abundant: it was three-quarters of an inch long at that early period.

Dr. Calvert also informed me that he was preserving the seeds of grasses, and consequently the grass is not cropped; and as he finds these caterpillars feed upon the seeds, he suspects that they are thus nurtured until they are attracted by the wheat-crops; they are by far most abundant on the heads of grass in seed, particularly the fescues and cock's-foot, and the grass seeds matured by the end of July and beginning of August are not infested by them.

It seems probable that these caterpillars do not generally appear in great numbers, and only in their first skins, until the wheat-crops in many parts are harvested in good seasons; but in the more northern counties they may prove very destructive to the standing corn, where the crops are later in arriving at perfection, and as they must often be carried into the barn or stacked with the wheat, their presence may be dreaded anywhere, especially when we find them injuring the corn to the extent observed by Dr. Calvert, who states that Colonel Le Couteur's improved Talavera, and many other wheats, had suffered to an extent of about one-third of the crop, and what is remarkable, they had not been detected in the neighbouring fields. Many of the ears I examined were very much more injured than the one represented at fig. 15; some of the grains had only a small hole in them, but multitudes were nearly

or entirely eaten out, the skin of the wheat alone being left. One which I put upon a dried ear of corn immediately began to eat into the grain, so that in a short time it was concealed, and the pure whiteness of its excrement showed the goodness of its food as decidedly as the quantity did its rapid progress, and the celerity with which it was digested. On taking out the grain I found a hole in the top just at the base of the stigma, and on opening it nothing but a thick shell was left. It is a remarkable fact that amongst the corn infested by the caterpillars Dr. Calvert found numbers of the horny heads, which convinces him that they will live upon each other; and as the heads are not merely the horny shell, and often have the first thoracic covering of the segment adhering to them, I am of the same opinion.

These larvæ have no doubt been troublesome abroad, for in a memoir by Dr. Herpin, he says, "At the approach of harvest I have found a pretty large quantity of stems of wheat which contained near to the ear, between the leaves, a thick caterpillar of about 2 centimetres long (nearly three-quarters of an inch), of a yellowish grey, rayed upon the back, and appearing to me to be the larva of a *Noctua*. This caterpillar, which is found also in the barns many months after the harvest, gnaws and devours the interior of the grains of wheat, yet adhering to the ears, and deposits between the leaves large excrement of a whitish colour."\*

Dr. Calvert, I find, "read a notice (before the Entomological Society) of the attacks of one of the *Noctuidæ* upon the ears of standing corn, which led to a discussion, in which it was suggested that the only advisable remedy against the attacks of fresh broods of these insects, was to subject the land to repeated ploughings after the crop had been got off, and the insects gone into the earth to undergo their transformations, in order to expose them to the rooks as well as to the action of the atmosphere."† As we have seen, however, that numbers of the caterpillars remain in the ears, and are consequently stacked or housed with the grain, and fed until the winter, when in all probability they hibernate, any application to the soil in this instance would not have the desired effect.

In what way these caterpillars undergo their transformation to the chrysalis state is uncertain; if it be in the refuse chaff, then those which are housed in the barn may escape in the chinks of the floor and round the walls, or as they are very active, and great ramblers, as all caterpillars are when they are about their final change, they may succeed in getting out of the building at the appointed season, and secrete themselves in herbage or in the earth, to become chrysalides; and of course those which inhabit the

\* Extract from the Memoirs of the 'Soc. Royale et Centrale d'Agriculture,' for 1842, p. 29.

† Trans. Ent. Soc., vol. iii., p. xxxv.

stacked corn have no difficulty in finding situations suited to their wants. I have repeatedly endeavoured to rear the caterpillars, but they always shrivelled up and died.\* I once, however, found some larvæ in January so exceedingly like these, if not the same, under the bark of willow-trees outside of a stack-yard, which subsequently spun up there and produced *Noctua* (*Caradrina*) *cubicularis*, that I am strongly impressed with the conviction this is the moth which produces these destructive caterpillars, and Mr. Westwood strengthening my opinion,† I have ventured to figure it, trusting that it may induce some one to endeavour to rear and ascertain the true parent, that, should we be in error, it may thus lead to good results.

The above species belongs to the Order LEPIDOPTERA, the Family NOCTUIDÆ, and is named by Hübner

6. *Caradrina cubicularis* (the pale mottled willow-moth); it is also the *Noctua quadripunctata* of Fabricius, and the *Noctua segetum* of Esper.‡ It is of a brownish mouse-colour; antennæ like bristles; eyes fuscous; palpi short and scaly, with a pitch-coloured patch on the outside; abdomen rather slender, obtuse at the apex in the males, conical in the females: wings lying horizontally and incumbent in repose, forming an elongated triangle, superior long and narrowed at the base, with three irregular and crenated transverse lines, forming little black spots on the costa; the first is near the base, the second before the middle, and the third beyond it; between these is a round and kidney-shaped spot; between the third and the posterior margin, which has a line of black dots, is a sinuated ochreous line, reddish and suffused on the inside, the external space dark fuscous; inferior wings pearly white, slightly tinged with brown next the cilia, the nervures brownish: length 6 lines, expanse 14 or 15 lines (fig. 18, the male).

This moth is common in hay-fields and about hay-ricks in May, June, and July, as well as on willows in gardens, &c.

I have also figured the larva of a saw-fly which was found in abundance on the ears of wheat near Cardiff in Glamorganshire, and as there was something mysterious in its visit, and I have never

\* Having removed into the country, I hope to be better able to trace the metamorphoses of noxious insects, and request in future that all communications may be addressed to me at Hayes, near Uxbridge, Middlesex.

† He says in a letter, "My impression is that they are the larvæ of *Caradrina cubicularis*, as I have specimens of that insect reared from caterpillars found in stacked wheat, of which I have the drawing and specimens." I likewise remember when Mr. Raddon exhibited a large number of these caterpillars at a meeting of the Linnæan Society, which had issued in myriads from stacks near Bristol, where they did incredible mischief by feeding on the wheat; he stated that they lived through the winter, and were the produce of *Noctua cubicularis*, if I mistake not.

‡ Curtis's Brit. Ent., fol. and pl. 651.

met with any similar occurrence, the record of the fact may possibly lead to a more correct knowledge of the economy of the animal. It is of the Order HYMENOPTERA, of the same Family TENTHREDINIDÆ as "the Turnip Saw-fly;"\* and from its figure and the number of legs, it appears to associate with the Genus TENTHREDO; but without the fly which it would change to, it is impossible to speak with any certainty.

7. *Tenthredo*? On the 3rd of August, 1842, I received more than 50 specimens of these caterpillars; they were about three-quarters of an inch long, rough, and of an orange-brown cast, with a paler line down the back; they had 6 horny pectoral, 14 abdominal, and 2 anal membranous feet; the head was large, horny, hemispherical, and ochreous, with a minute prominent eye on each side surrounded by a small black ring, and a minute horn before each (fig. 19). The jaws were strong and horny, meeting in front, subquadrate, pitch-colour at the apex, one with strong irregular teeth (fig. *i*), the other more crenated (fig. *j*); the maxillæ were small, and furnished with a short, tapering, triarticulate palpus (*k*).

I will now transcribe my correspondent's account of them: he says, "I find from my friend, that on walking through a field of wheat, at noon on Monday, he saw one of these caterpillars on the top of almost every ear of corn, perfectly inactive, and the corn not injured in any way. Great numbers still remain on the ears, almost all are quite at the top, some apparently impaled upon the sharp points of the husks of the uppermost grains, and only one on each ear. A large wood adjoins the field, and I should observe that almost all the caterpillars appear dead and dried up on the ears; and it was with difficulty I could find any at all showing signs of life." It was certainly a strange phenomenon, which came so suddenly, and appeared so unaccountable, that the bailiff declared "they fell in a shower during the night."

We have now arrived at the history of a genus of small flies which is highly interesting; and although their depredations are well known, the habits of the various species had not been completely investigated until recently. Opportunities of studying their economy having been offered, I commenced my observations some years since, but did not complete them until the present year, and I now find that Dr. Herpin had been engaged upon the same subject, by a pamphlet upon *Chlorops*, &c., which has lately appeared, with plates and additional observations, by M. Guérin-Méneville. My investigations, therefore, have no longer the charm of novelty, but they may yet strengthen the observations already promulgated, and will not prove uninteresting to the agri-

---

\* Royal Agric. Soc. Journ., vol. ii. pl. B. f. 6 and 7.

culturist, when combined with the facts recorded by my fellow-labourers in science.

As the documents relating to these insects are very numerous, it may be as well to preface my narrative with an outline of their general economy. When the incipient ear is formed, but concealed in the sheath close to the first knot, or even at an earlier stage of growth, the wheat and other corn-plants often droop:\* on opening the stem a maggot is found; this changes to a pupa higher up, from whence eventually emerges the legitimate fly, or some parasite which feeds upon the larvæ. The earliest intimation we have of these pests is in the Stockholm Transactions, first by Linnæus, and secondly by Bierkander. Gmelin, Fabricius, and others have described the species in their works; and subsequently we find an excellent paper in the Linnæan Transactions, as well as more recently the Memoir of MM. Herpin and Guérin-Méneville, besides notices in many other works, which I shall endeavour to embody in my narrative.

#### 8. OSCINIS PUMILIONIS, *Bierk.*; CHLOROPS GLABRA, *Meig.*?

Bierkander † describes one of the species, which he calls the Ryeworm, and the following is his accurate account of this insect, which he named *Musca pumilionis*: ‡—“In the month of May, 1778, I perceived some dwarf stems amongst the rye, from one to three inches long. On examining them, I discovered that at their first joint there was a little worm, which caused this singular growth. In order to trace at leisure the metamorphoses of these worms, I took many specimens, which were put in a glass bottle.

“The larva is white, two lines long; it has ten segments; the head is pointed, black at its extremity, forming a  $\Delta$ . The first began to change to a pupa on the 25th of May.

“The pupæ are yellow and shining, a little more than a line long, depressed and annulated. They began to produce flies on the 12th of June.

“The imago, or perfect fly, is a little more than a line long; its head is yellow, and its eyes black; it bears at the nape a black triangle: the black antennæ are a little knotted, and produce some hairs: the thorax is yellow beneath, black upon the back, and marked with two slender yellow lines the whole length; below and near to the abdomen is a yellow crescent-formed spot: the fore-legs bear two black spots: the abdomen is black above, yellow beneath, and is composed of four segments: the poisers are white:

\* This, it will be also remembered, is the case with the Wireworms.

† *Vide* the Transactions of the Royal Academy of Stockholm, vol. xxxix. A. D. 1778, pp. 240 and 241; also the Transactions of the Linnæan Society of London, vol. ii. p. 79.

‡ Thus named from its causing dwarf and abortive grains in the ears.

the wings glitter with red and green, and extend a little beyond the body; the legs are greyish at the base, black at the extremities.\*

“I am still ignorant whether the eggs are deposited in the stalks of the rye; but the larvæ, which were yet small on the 23rd of April, had acquired their full size on the 25th of May. I do not see any holes upon the sides of the stems, for which reason it would appear that the eggs or the worms are deposited upon the leaves. When we find any holes there, they are made by ‘the Whiteworms of the ear,’ or other insects. When the fly has issued from the pupa, it climbs up the stalk and flies away.

“The quantity of dwarf rye, which began to grow yellow and decay on the 14th of June, amounted to from 8 to 12 and 14 in every 4 square feet. We see by this how much mischief the insect could do to the growth of rye; it is therefore necessary to pull up and burn the attacked plants, whilst the worms and the pupæ are inside. I have sometimes pulled up as many as 350 affected stalks in a few hours, and one or more persons could collect some thousands in a day, which would be of great importance, because then the numbers would be less considerable the succeeding years.”

Gmelin† gives the following description, in Latin, of *Musca pumilionis*, which he considers the essential characters of Bierkander’s insect:—“Black; underside, head, and two lines on the thorax yellow; halteres white; legs cinereous; apex black.” And adds, “The larva, which has an acute head and black apex, inhabits the stems of rye to an extent hurtful to their increase, as they scarcely reach 1, 2, or 3 inches in height.”

Unfortunately there is no description of the species which we shall next notice, and the figures in the plate are not sufficiently accurate to determine if it be Bierkander’s insect; but I am inclined to think not.‡ This excellent paper, being “Some Account of the *Musca pumilionis* of Gmelin’s Edition of the Syst. Naturæ, by William Markwick, Esq., F.L.S.,” was read before the Linnean Society on the 1st of November, 1791.§ He says, “Early in the course of the last spring some fields of wheat in the neighbourhood of Battle appearing to be much blighted, a friend of mine discovered it to be caused by a small insect of the grub or caterpillar kind, lodged in the centre or very heart of the stem, just above the root. About the latter end of March I procured

\* Evidently related to our fig. 20, pl. I.

† Gmelin’s Systema Naturæ, vol. v. p. 2849, No. 217.

‡ They are represented of a larger size than I conceive Bierkander’s to be, and with *pale*, in all probability yellow, *legs*; there are also indications of four black stripes on the thorax in the smaller figures.

§ Vol. ii. p. 76, of their Transactions.



some of the wheat, examined it, and found in most of it a small larva or caterpillar alive; but in some it was already changed into the chrysalis state.

“ Being exceedingly anxious to determine the species of this apparently destructive animal, I planted some of the diseased roots in my garden under a handglass, where they flourished very much, and threw out strong shoots on each side (the middle shoot withered); but whether the flies escaped through some hole in the glass, or whether they were devoured by a colony of ants which made their nest under the glass, I cannot tell, as I did not succeed in this attempt, for when I pulled up the wheat, and examined it, there was an empty chrysalis in each plant. However, I had better luck in my next attempt: I placed several of the diseased roots of the wheat in a small flower-pot filled with bran, and covered it over close with gauze, in such a manner that no insect could get in from the outside, nor could any escape from within. On the 14th of May three small flies were discovered sitting on the inside of the gauze. A few days after, three more of the same flies appeared. There were in the flower-pot of bran six roots of diseased wheat, which produced six flies. On examining the roots afterwards, I found an empty shell of the chrysalis in each, so that, I think, there can be no doubt of the identity of the insect in question.

“ I mentioned that the larva and chrysalis were always found deposited on the principal stem, just above the root. This stem it invariably destroyed, which gave the crop a most disastrous appearance, so that there was scarcely a hope of any produce: but after the larva had changed into its chrysalis state the mischief ceased, and the root was not so materially injured as to prevent its throwing out fresh shoots on each side, or stocking itself, as the farmers term it, as I experienced by those which I planted in my garden.

“ In short, at harvest-time I was most agreeably surprised to find a good crop of wheat, and the ears large and fine throughout the whole field. My friend thinks it the best crop on his farm, and supposes he shall have about three quarters and a half of thrashed corn from each acre.

“ The kind of wheat sown was a white wheat, lately introduced here from Surrey: my friend could not recollect with certainty its name, but thought it was called white Zealand wheat. None but what was sown early, about the latter end of September or the beginning of October, was affected by this insect; and in one field, where a part of it was early sown with white, and the other with red wheat, at the same time, the white wheat was much affected, and the red but very little. The reason why the early-sown wheat only was affected is, I should imagine, because the cold at the approach of winter destroyed the fly before the late-

sown wheat was sprung out of the ground : consequently it could not lay its eggs in that. The soil is rather stiff, with a gravelly bottom."

I shall now proceed to give the observations made on the ravages of these insects, and their economy, in France. In 1812 the Société d'Agriculture de la Seine was officially consulted by the Minister of the Interior upon the subject of the considerable ravages made in divers parts of France, especially in the environs of Paris, by the destructive insects attacking the corn-crops. These insects lodged between the leaves of the corn, and ate the young stems at the termination of winter. The greater part of the attacked plants withered and perished upon the spot towards the end of the following April. The celebrated naturalist, Olivier, was charged by the Society of Agriculture to study and publish the history of these insects in their Transactions, but his death prevented their completion, and the premature demise of M. Audouin again retarded this work ; and it has been resumed by Dr. Herpin and M. Guérin-Méneville.

#### 9. CHLOROPS LINEATA ?

"In 1812 it was observed that the corn recently planted presented, both before and after winter, alterations, occasioned by a larva situated above the root, which ate the leaves in the centre of the plant, causing it to turn yellow, and then to perish.\*

"In 1839 Dr. Dagonet, at Châlons-sur-Marne, and M. Philippar, detected again some larvæ which caused in the spring a considerable swelling of the young wheat-plant above the joint, destroying the central leaves and the plant itself. Towards the end of April or in May these larvæ were changed to the fly named *Chlorops*. Olivier was perplexed to explain how the eggs laid in May could be preserved and transported to the young wheat-plants, which are only sown in the October following. The pairing of the sexes takes place towards the end of May or the beginning of June, and the female is soon occupied in laying her eggs upon the stem of the wheat, which then commences to show the ear ; the egg is deposited towards the lower part of the ear, at the bottom of the sheath of the leaves. About fifteen days after, there issues from the egg an oblong larva, yellow, and without legs, which attaches itself to the stem of the corn, immediately under the ear ; it nourishes itself by nibbling a part of the surface of the straw, which is then very tender ; it there traces and excavates an external groove about two millimetres broad and one or two at most in depth, but which never penetrates into

---

\* Vide Dr. Herpin's paper in the Memoirs of the ' Soc. Royale et Centrale d'Agriculture,' 1842.

the interior canal of the straw. This furrow reaches from the base of the ear to the first superior knot, with some exceptions; for example, when the larva perishes, or when it is full-grown before having attained the first joint.

“When nearly arrived at this spot, the larva has usually acquired all its growth; it is then transformed into a pupa, and fixes itself generally towards the middle of the furrow which it has scooped out on the exterior surface of the stem. In the following September the *Chlorops* hatches, which would live during many weeks, and then deposit her new eggs upon the *rye* and the corn quite recently sown.

“The stems of the wheat attacked by the larvæ proceeding from the second laying of the *Chlorops* present some differences so singular and remarkable, that it is surprising no one has up to the present time ascertained the cause; these alterations are generally attributed to a defect of vegetation, occasioned by certain uncongenial variations of the seasons. The stalks thus attacked are scarcely more than half the height of those which are healthy; their maturation is retarded considerably; they are still very green when the others have become yellow from the effect of ripening; the ears have not yet emerged from between the leaves which sheath them; they are short, small in bulk, and contain but few grains; these, moreover, are starved, concealed, and curved; lastly, all the series or files of grains situated on the side where one finds the longitudinal channel hollowed out by the larva are entirely abortive, and contain no grains.”

It appears that in July, 1840, the pupa and perfect insect were alive, and in May the infected stems were abundant, and, from the number of ears which were injured where the researches were made, the loss was estimated at one-seventieth part of the wheat-erop. Dr. Dagonet says, “The number was at least as considerable in our country, where one could not set a step without meeting with some ears not disengaged from their envelopes. If we add to these ravages of the second laying, the considerable number of young plants which perished in consequence of the attacks of the *Chlorops* prior to and after winter, we shall be convinced that this insect is a very formidable scourge to agriculture.”

#### 10. CHLOROPS HERPINII, Guér.

Dr. Herpin also obtained a *Musca* from larvæ which only attack the ears of the barley, and which Guérin has named *Chlorops Herpinii*,\* and he says that it resembles the *C. glabra* of Meigen,†

\* Guérin's Memoirs, p. 30, pl. 2, fig. 9.

† System. Beschr., v. 6, p. 149, No. 20.

and the "Mouche jaune à bandes noires" of Geoffroy.\* This species certainly differs from all the specimens I have bred, as well as from those in my cabinet: † it is yellow, and has only three black stripes on the thorax; the antennæ are black or yellow, with the anterior margin, and seta black; crown with two black triangular spots; abdomen yellow; fascia and basal dots fuscous; tail black; legs yellow; the tarsi are all fuscous. He further says, "The barley (*Hordeum distichon*) is attacked with us by a *Chlorops* which appears to be the same as that which devours the stems of the wheat; it produces the same alterations, and scoops a longitudinal groove on the outside of the young stem, under the ear."

"Besides that insect," says Dr. Herpin, "the barley is attacked by the larvæ of another *Chlorops*, much smaller than the preceding, which are found to the number of from six to ten in each ear; they eat the sexual organs of the flowers, and render the fructification imperfect, so that the ears are quite sterile.

"We often find also upon the same piece of barley, with the first-mentioned *Chlorops*, which eats the superior part of the stem, many other little *Chlorops* of the second species, which devour the ear. These two species undergo their metamorphoses in the manner already described."

## 11. MUSCA FRIT.

I must not omit to notice this little fly, which was first made known by Linnæus's Memoir in the 'Stockholm Transactions' for 1750, and concerning which there is much difficulty regarding the species, owing to the brevity of his description, and it appears to me that its economy is different to any of the other recorded species. As, however, all naturalists are agreed that it is a *Chlorops*, it will be better to introduce it here.

In the 'Fauna Suecica' ‡ Linnæus describes this fly as having "setaceous antennæ, with black pile or short hairs; the balancers, hinder feet, and abdomen are pale green. It is the size of a flea (which is large in Sweden); the body is the form of *Musca domestica* (the common house-fly); black; very agile, as if dancing; eyes fuscous; hinder feet pale; balancers pale; abdomen fuscous, more of a pale green beneath." He says, "It resides between the glumes (husks) of the barley, and certainly destroys as much as one-tenth of the grain, causing the little, light,

\* Geoff., Hist. abrégée des Ins., v. 2, p. 508.

† Vide Curtis's Guide, genus 1345, where 35 species of these flies, comprised in *Chlorops* and the subgenus *Oscinis*, are recorded as inhabiting England.

‡ P. 456, No. 1851.

and worthless grains called Frits, which are the greatest loss to husbandmen;" and he calculates the annual loss in Sweden at upwards of 100,000 golden ducats,\* about the same sum in pounds sterling—an immense loss, if we consider the period at which Linnæus wrote and the country he alluded to. It is found much farther to the north, the fly being, according to Zetterstedt, abundant everywhere in Lapland, on grass in arid situations, from the 5th of July to the 2nd of September.†

I will now describe the first species which came under my own observation, and causes the disease termed in Oxfordshire the gout in wheat and barley, from the stalk being swollen to thrice its natural size. These flies belong to the Order DIPTERA, the Family MUSCIDÆ, and this species to the Genus CHLOROPS, so called from its green eyes, and it is named by Meigen

12. *C. tæniopus*,‡ the ribbon-footed corn-fly (fig. 20, pl. L).

Guerin considers this to be a variety of the following insects, which belong to the same species:—

*Musca lineata*, Fab.: Ent. Syst., v. 4, p. 356, No. 180.—*Oscinis lineata*, Fab.: Syst. Ant., p. 215, No. 4.

*Oscinis lineata*, Lat.: in Ency. Method., v. 8, p. 566.

*Chlorops nasuta*, Meig.: Syst. Besch., v. 6, p. 142, not of Gmelin.

*Chlorops glabra*, Westw.: in Gardener's Mag., v. 13, p. 289.

It is of a straw-colour or pale yellow; the antennæ are porrected but drooping, black, small, compressed, and four-jointed; the basal joint being cup-shaped and bristly; second nearly orbicular; the third minute, short, and slender, inserted near the base of the second; the fourth a fine, rather short bristle, often placed at an angle with the third (fig. *l*): head rather large and hemispherical (fig. 22); face smooth; profile concave (fig. *m*); mouth received into a cavity beneath, composed of a bilobed lip, two palpi, a labrum, and tongue; at the base of the crown is a black triangle, on which are placed in triangle the three minute ocelli; the eyes are lateral and orbicular, remote in both sexes, green when alive, blackish or brown after death; thorax ovate-quadrate, very convex, and as broad as the head; down the back are three broad black stripes, the centre one equal, the lateral ones tapering behind; on each side of these is a slender short black line, not extending to the shoulder, and there is a black dot on the side of the breast; the scutellum is semicircular and yellow, with a minute dark spot on each side under the margin at the base, sometimes there are two rusty converging stripes on the sides, and

\* Linnæus's *Systema Naturæ*, pars 2, p. 994, No. 90.

† *Insecta Lapponica*, col. 781, No. 12.

‡ *Syst. Besch.*, v. 6, p. 144, No. 9.

the hinder margin is relieved by a transverse black patch; the abdomen is scarcely longer than the thorax and not broader, it is ovate-conic and depressed, formed of five segments, of a pale greenish black, the margins darker, forming four black bands when alive, and there is a minute black dot on each side of the basal segment; wings incumbent in repose (fig. 23), extending considerably beyond the tail, transparent, beautifully iridescent; costal nervure brown and extending to the submarginal nervure only (fig. *n*), which is brown also, the inferior ones paler, the two transverse nervures on the disc do not approximate; halteres clavate and white; six legs moderately long, simple, and slender, of an ochreous colour; the feet five-jointed, anterior black, with the second and third joints ochreous, intermediate and hinder with the two terminal joints alone black; claws and pulvelli also black; length  $1\frac{1}{2}$  line, expanse  $3\frac{1}{2}$  (fig. 21, highly magnified).

As I have great doubts regarding this insect being only a variety of Fabricius's *Musca lineata*, I have adopted Meigen's name; their economy is undoubtedly similar, but his description is too incomplete to enable any one to determine the point, and Meigen's insect is at once distinguished from all others of the genus by the pale band on the intensely black fore-feet.

On the 7th of August, 1841, a friend informed me that, in going into a small wheat-field in Surrey, it was lamentable to see the multitude of stems and ears that were injured and disfigured. The wheat had been transplanted, the stalks were scored, and in them were the chrysalides of maggots protected by the leaf. Upon inspecting the three stems that accompanied the communication, one of which is represented in pl. K, fig. 24, and pl. L, fig. 25, the former being the upper and the latter the lower portion of the same stem, I observed an irregular brown channel commencing a short space above the joint (fig. 25, *o*), which extended to the base of the ear (fig. 24, *p*). At figure *o* I found a shining brown pupa, from whence I concluded that the egg had been deposited at a somewhat early stage of the wheat, possibly in May or June, and that the larva fed, working its way down, within an inch or an inch and a half of the joint, where it was enveloped and secured by the leaves, and would no doubt turn round before changing to a pupa. I then split the stems longitudinally, and found that the channels formed by the maggot in no instance penetrated through, but that there was occasionally a corresponding thickening inside of the straw; I had seven pupæ, all of which appeared to be dead, excepting one (fig. 26), through the skin of which I could trace the embryo fly, which eventually proved to be the *Chlorops tæniopus*.

On a second examination I found in two of the ears that the larvæ had commenced eating about half an inch above the base of the ear, and kept apparently on the surface of the stalk, which is,

of course, very rigid, and one had passed over a grain which was impressed with a small channel; in another the calyx of the basal grain was perforated with a small hole (fig. *p*), which had rendered it abortive, unless the corn had been consumed. As the channel had passed over one of the calyces, where it was much narrower than below, and the kernels swelled, the line of connexion was interrupted. Such were my first impressions, but, after reconsidering these appearances, I have come to the conclusion that the egg is deposited so that it may hatch when the ear is but just formed, and by then feeding on one side, the channel in the stalk is only the scar, which is elongated as the plant grows; if this be the case, my first theory is incorrect: but to show how carefully one must proceed, I may mention that the specimens of wheat above alluded to were carefully preserved in a closed box, and on re-examining them lately, I saw one of the stems had not been opened, and on splitting it a great quantity of white excrement fell out, which puzzled me greatly; but on proceeding in my search, I found that the canal terminated in one of the glumes, and there, to my surprise and satisfaction, I discovered a little beetle (the *Anobium panicum*),\* which had been feeding on the soft internal lining of the straw, with others which had escaped, and they were the cause of this unexpected and casual injury.

On the 16th of August, 1841, I bred the fly *Chlorops taniopus* from one of the pupæ in the stems; the others produced parasites, of which I shall speak hereafter.

The same fly attacks the barley also, but apparently at an earlier period, for on the 2nd of last July I received two plants from Sarsden, which were rank, and looked green and healthy, but, on unfolding the leaves, I found the central ones yellow, dead, and eaten, and the stem destroyed. Within an inch of the joint was enclosed a brown, shining pupa, like fig. 26, but smaller; in the other a similar one, but an inch or two higher up, and adhering to the inside of one of the outer leaves: in this plant the young ear of barley was eaten and become brown at the extremity. It was stated by my correspondent that in his neighbourhood not a yard of any of the barley-fields was free from this disease. About three weeks after, he sent me a larger supply of infected plants, which had a rank and gouty appearance; and informed me "that the disease was first detected when the barley began to shoot or stool; and when one stalk was infected, the remainder of the shoots on the same stool appeared stunted. I do not think any stalk with a maggot in it will ever throw out an ear." And of this I am also convinced; for in every instance the stalk was eaten, often nearly through, and the tender grain

---

\* *Vide* Curtis's Brit. Ent., fol. and pl. 387; and his Guide, genus 290.

was more or less consumed by the maggots, especially towards the base, where it was the most matured; but it often happened that there was no indication of grain, the chaff only being developed.

Having found two specimens of the *Chlorops* with their wings crumpled, near the top of the spathe, I am satisfied that the flies crawl out from between the leaves as soon they hatch, and there expand their wings; and the species I was able to identify by the colour of the feet.

It has been said that this disease is confined to the most luxuriant crops; but this surely arises from the rank and unnatural appearance occasioned by the swelling of the stems. Some of the naked Nepaul barley was also infested with the *Chlorops*, which in August exhibited deep channels the whole length of the stems. It seems to attack rye and barley sometimes in preference to wheat; and perhaps there is not a year that this fly is not at work, but at intervals in such small numbers that the mischief passes unnoticed. There are some other species of *Chlorops*, which occasionally make their appearance in myriads: I remember witnessing the ceiling of a room which was absolutely discoloured by a very similar species, the *Chlorops hypostigma* of Meigen, if I mistake not, which swarmed in the autumn of 1834, when many persons informed me that it was not of rare occurrence at that season in Suffolk. I also received examples of this species last October, which "literally covered the ceiling of a bed-room" that had been white-washed, after scarlet fever had visited the house, which induced a supposition that the flies were the consequence. There were thousands also on the windows of an uninhabited house in this neighbourhood in the second week of October.

I recollect that Mr. D. Sharp, a member of the Linnæan Society, presented me with specimens of the *Chlorops tæniopus*, many years since, which he had bred from the stems of wheat in Huntingdonshire; and, more recently, the late Mr. Sells stated before the Entomological Society, that many acres of rye had been killed near Kingston, in Surrey, by these larvæ burrowing into the stem at the surface of the ground. In 1837 the *Chlorops* was observed in abundance, whilst removing a wheat-stack, near Bristol, in the month of April, with the caterpillars of *Noctua cubicularis*, already noticed; and in the autumn of the same year, these little flies appeared in myriads in houses in various parts of the country. It is, however, very much to be regretted that it is impossible to ascertain if they were all of the same or different species, as the specimens are either lost or scattered about in various collections.

During the present year a species has been detected of similar habits, which had not been previously noticed. The first report of this disease was a communication from Mr. R. Arthur, of Edinburgh, published in the Gardener's Chronicle and Agricultural



Gazette, June 1st, 1844, in which the writer says, "There has been a remarkable failure of some fields of wheat around North Berwick, which have been ploughed down within the last few weeks. In early spring it promised as fine a crop as any in the country. Plants, however, here and there began to look sickly and to flag, which lay withered in the course of ten days. On examination, every stem of the plants attacked was found to contain a small grub, which enters about two inches beneath the surface of the soil, eats its way up the centre of the stem till it reaches the light, when it either dies or becomes transformed. The plants appear to reproduce fresh buds from the joint beneath the door of the grub, but the remaining vitality seems too weak to carry leaves to the air for respiration, far less to yield a crop." This was immediately followed by a letter addressed to the editor of the Preston Guardian by Mr. M. Saul, of Fort Green Cottage, Garstang, Lancashire, stating that he had discovered the grubs in wheat-fields on the estate of the Duke of Hamilton in that neighbourhood; and, with the plants forwarded to the Royal Agricultural Society, he stated that the wheat was sown in December, February, and March; the first suffering the least from their attacks. The fields are a peat-earth, and were cropped with potatoes in 1843. On the 9th of June, and again on the 19th, Mr. Saul obligingly transmitted me some plants with the living maggots in them. The first two plants of wheat I received were four or five inches out of the ground, and withering (fig. 27); on pulling open the dilated base of one of the sheathing leaves, I found a small yellowish white, shining, fleshy maggot (fig. 28), surrounded by atoms of the stalk, which might have been digested, as they adhered together. It was perfectly concealed, with its head downward, and close to the base of the plant; it had already eaten through the central stem, so that I could draw it out with ease. This maggot was a quarter of an inch long, the body was gradually attenuated to the head, which was pointed, with two black horny points; the tail was terminated abruptly, with two brown tubercles and several smaller fleshy ones (fig. 28, and f. 29, the same magnified). Unfortunately, these larvæ, as well as those forwarded a few days after, all died; for, as they were much larger than those sent at the end of June, I am disposed to think they may be different to the foregoing or following species; yet, on opening the stems in October, I found two dead larvæ, and on a leaf I detected a small empty pupa-case, very similar to that of the species I am about to notice.

### 13. OSCINIS VASTATOR.

The wheat-plants transmitted to me on the 19th of June I placed in a garden-pot, when they died I enclosed them in a stopper-

bottle, and on the 5th of July I found a small black fly hatched (fig. 31). The plants of corn, whether of wheat or barley, I could not ascertain, which I received on the 23rd of June had the outer blades green (fig. 32, s), the inner one yellow or brown (fig. t); on pulling this blade it drew out, leaving the base behind, which was completely eaten through (fig. 33, u): the stem which I had drawn out was of a yellow colour, and about half an inch of it was eaten, and dry (fig. 34, v), and just within I detected a small yellow, shining maggot (fig. w). Although it has no feet, it crawls well even upon glass; the head is attenuated, with two minute black hooks extending into the thoracic segments, through which they are visible: I counted twelve segments, the apical one being rounded, with two minute tubercles (fig. x, magnified). On the 29th of June, one or more of the maggots had changed to brown pupæ in the stem, occupying the same place as the larvæ had done (fig. y); and on the 20th of July I found two little black flies, the *Oscinis vastator* (fig. 31), dead in the box, and precisely the same as that bred on the 5th of July, with the empty cocoons also.

Owing to a variation in the nervures of the wings, and other minor differences, this species and many others\* have been separated from *Chlorops*, and are raised to a Genus bearing the name of OSCINIS; and as our species does not agree with any of the others published in the works of Meigen or Macquart, and I have no opportunity of ascertaining if it be the one described by Olivier, I am compelled to give it a name, which alludes to its destructive nature.

13. *O. vastator*, Curt. (fig. 31); *Tephritis hordei*, Oliv.? Shining greenish black: antennæ attached to the forehead, short, compressed, drooping, and approximating at the base; four-jointed, basal joint cup-shaped, second semi-orbicular, on the outside of which, near the base, is inserted the third joint, which is exceedingly minute, fourth a short pubescent bristle; lip and palpi concealed in a cavity beneath the head, which is bristly, with a large shining triangular space on the crown, on which are placed the three minute ocelli in a triangle; face smooth, and not concave as in *Chlorops*; eyes remote in both sexes, lateral and oval, brown after death, but probably green when alive; thorax as broad as the head, globose quadrate, with a scarcely visible ochreous pile, forming very indistinct lines in perfect specimens, and an impression on the disc; scutellum semi-ovate, terminated by two bristles, and finely rugose; abdomen short, not so broad as the thorax, rather depressed, ovate conic and five-jointed; wings decumbent in repose, and extending considerably beyond the tail, transparent

---

\* Vide Curtis's Guide, genus 1345, species 28 to 61.

and iridescent, but slightly smoky; the costal nervure extending beyond the submarginal one to the mediastinal nervure (fig. 31, *n*); all the nervures are pitchy, the two transverse ones are not very remote; balancers with an oval ochreous club; legs six, longish and slender, base and tips of the four anterior tibiæ ferruginous; the base of the first joint, in all the tarsi, is of the same colour: length  $\frac{3}{4}$  line, breadth 2 lines (fig. 31; *r*, the same magnified). *Obs.*—Some specimens are smaller and more slender; possibly they are the males.

This appears to be a much more formidable enemy than the *Chlorops tæniopus*, for the ten or twelve stalks I opened were filled only with powder at the base, every portion of the young ear being consumed; indeed the destruction was complete.

Let us now pause for a moment, and reflect upon the extraordinary fact, that our corn, the staff of life, is placed in the power of this pigmy race; and that, destined as man is to earn his bread by the sweat of his brow, yet famine, accompanied by its concomitants disease and death, may overtake him, notwithstanding his industry, and let his prospects be ever so promising, through the united operations of the insect race. How wonderfully displayed, therefore, are the wisdom and goodness of the Creator, in so nicely balancing the destroyer and his parasitic enemies as to keep man, naturally prone to indolence, ever on the alert; and yet, when the countless hordes of noxious insects fall like an irresistible plague upon his crops, that hand which is ever ready to befriend mankind, arrests the scourge. Myriads of parasitic insects are let loose, multiplying as their prey increases—the threatening scourge passes over with less loss than could have been anticipated, and the succeeding year, to the astonishment of the farmer, instead of the mischief being increased, not an insect enemy is to be seen.

I may now be permitted to show, with regard to these little flies, the way in which the Creator himself has devised the means of arresting their multiplication. In rearing the *Chlorops* and *Oscinis* I often found that even more parasites than legitimate flies issued from the infested stems, and their history I shall forthwith relate.

I bred a kind of *Ichneumon* from the Canada wheat, which suffered from the maggots of the *Chlorops* in 1841, and the grower of it transmitted another specimen. Likewise, on opening the spikes of barley from Sarsden in October, I invariably found, on the inside of the inner spathe enclosing the incipient ear, an empty pupa-case, from 1 to 3 inches from the base, which had either produced the fly (*Chlorops tæniopus*), or this *Ichneumon*, called *Cælinus*,\* one of

---

\* This is the genus *Chænon* of my works; but Nees ab Esenbeck having previously characterised the group under the above name, mine is superseded. I should not have referred my insect to Nees's genus had not Mr.

which stuck in the hole it had eaten with its strong jaws,\* owing, in all probability, to the plants having been kept too dry. This parasite was first noticed and described by Olivier, and Dr. Herpin obtained it in such abundance that he states the number of parasites to have been almost as considerable as that of the *Chlorops*; and from my experience I am of the same opinion as to their numerical force. He also says that both broods of the *Chlorops* are equally subject to the attacks of the parasitic *Cælinius*, which usually hatches many days before the *Chlorops*, especially the males.

With the egg and maggot of the *Cælinius* I am unacquainted—indeed the former must be too minute to be visible with the naked eye—but in all probability it is inserted into the maggot of the *Chlorops*, and feeds upon its fat until it changes to a pupa, which I found placed in the groove of the wheat-stem (pl. L, fig. 25. a; fig. b being the same magnified). A little above this pupa I observed a round hole (c) in some of the spathes, through which the parasites had made their exit; and it is worthy of remark that their wings are perfectly developed and ready for flight before they sally forth, whereas the *Chlorops* comes out with soft unexpanded wings, which it is necessary to expand and dry in the open air.

This parasite, like most of those described in former Essays, belongs to the Order HYMENOPTERA, Family ICHNEUMONIDES ADSCITI, and the Genus CÆLINIUS.† Olivier also described it under the name of *Alysia nigra*; and Guérin, to pay a compliment to that distinguished naturalist, named it *Alysia Olivierii*.‡ It is undoubtedly the *Chænon affinis* of my work, which is synonymous with Nees ab Esenbeck's *Cælinius niger*,§ and accidentally accords with Olivier's name, which has the right of priority.

14. *C. niger* (fig. 35).—Reddish brown or piceous: antennæ, head, and thorax, shining black; the former as long as the animal, slender, and composed of numerous subquadrate joints, basal joint most robust, third the largest; the head is globose-quadrate; face convex; the mouth is furnished with a pair of divaricating jaws, terminated by four unequal teeth; the four feelers are long, especially the maxillary; the eyes are remote and lateral; ocelli three, large, and forming a triangle on the crown; thorax very much elongated, and not broader than the head; postscutel large, semi-orbicular, and coarsely punctured; abdomen as long as the head and thorax, and broader at the middle, pale piceous, the

---

Haliday in his Monograph been satisfied of their identity; because Nees says the maxillary palpi are five-jointed, whereas they are undoubtedly six-jointed in the specimens of *Chænon* I have examined and figured. *Vide* Curtis's Brit. Ent., fol. and pl. 289, fig. 4.

\* *Ibid.*, figs. 1\* and 3.

† Curtis's Guide, genus 562.

‡ Notice sur quelques Insectes nuisibles, p. 26 and pl. 4, f. 1 and 2.

§ Hymenopterorum Ichm. affinis Monog. vol. i. p. 10.

basal segments very much narrowed, rugose, and brown, the others forming an elongate-ovate body; ovipositor scarcely visible; wings rather long, transparent, and iridescent; superior ample, with one marginal, two sub-marginal, and two discoidal cells; stigma elongate-ovate, and brown, as well as the nervures; inferior wings much smaller, the nervures dark and distinct; legs very slender, hinder the longest, anterior ochreous; tarsi fuscous; hinder trochanters and thighs with an ochreous ring at their union: length  $2\frac{1}{3}$  lines; expanse  $3\frac{2}{3}$ . (Fig. 36, magnified).

All the species of this parasite, of which there are twelve described in the 'British Entomology,' inhabit moist meadows, and are principally found from the end of June to September, which is strong evidence that many of the *Chlorops* are bred from the stems of grasses.

Another parasite I bred also from the same stems of wheat and barley, which is an exquisitely beautiful little creature in form and colour. This had been likewise described by Olivier,\* and M. Guérin found some specimens in the bottle containing the corn which produced the *Chlorops Herpinii* and the above *Cælinius*. On the 11th of last August, and again on the 20th, I found a male of this *Pteromalus*, which had been bred from a stem of the gouty barley from Sarsden; and I soon discovered a little hole, about three-quarters of an inch from the base, through which it had emerged (fig. 25, d). At the base of another abortive ear within the spathe, I found a second specimen of the *Pteromalus* dead, and not a vestige of a pupa-case, showing that this parasite is very different in its economy to the *Cælinius*, and lays its eggs in the maggots of the *Chlorops* at such an early period that they are devoured before they have time to change to pupæ, so that there was nothing remaining in the cavity of the stem but the excrement of the *Chlorops*' maggot. It is however the opinion of some naturalists that this family of insects destroys the true parasites by puncturing their pupæ.

In a former Essay I described and figured a little fly which was parasitic in the pupæ of the "White-cabbage butterfly." † The parasite of the *Chlorops* is closely allied to it, consequently it is of the same Order HYMENOPTERA, the Family CYNIPIDÆ or CHALCIDIDÆ, and the Genus PTEROMALUS, of which my genus *Colax* forms a section. ‡ It was named, apparently by Olivier, *Chalcis micans*; and is closely allied to, if it be not identical with, Mr. F. Walker's *Pteromalus Pione*. §

15. *P. micans*, the glittering *Pteromalus* (fig. 37).—Head and

\* Oliv., Mém. Soc. d'Agr., vol. xvi. p. 477, pl. 3, f. 12.

† Royal Agric. Jour., vol. iii. pl. E. f. 13.

‡ Vide Curtis's Brit. Ent., fol. 166.

§ Monographia Chalciditum, p. 224, No. 21.

thorax of a lovely green, more or less tinged with blue or yellow, and exquisitely shagreened; the former is large and transverse; the face more orbicular; on each side is a dark oval eye, and on the crown three ocelli in the form of a triangle; antennæ nearly as long as the head and thorax, inserted in the middle of the face, filiform, flail-shaped, hairy and brown, composed of thirteen joints, the first being long and naked, and forming an angle with the following, second pear-shaped, third and fourth like little rings, six following oblong, the remainder forming an elongated conical compressed club; mouth with two denticulated jaws, four palpi, &c.\* thorax not so broad as the head, but thrice as long, and oblong; scutellum large, rounded, and convex; abdomen black, smooth, and shining; the base and sides metallic green; the back violet, not so long as the thorax, strap-shaped, concave above, narrowed at the base, the apex pointed; four wings transparent, iridescent, and pubescent; superior ample, with a subcostal brown nervure extending to the middle, where it becomes the costal nervure, but does not reach the tip, and beyond the middle is a short clavate branch; inferior wings much smaller, and nerveless, excepting a short subcostal one; six legs, slender, and bright ochreous; coxæ bright green, hinder stout; thighs pitchy, anterior with the apex and a stripe beneath ochreous, the others tipped with ochre; tarsi five-jointed, anterior often dusky, the others, with the fifth joint, the pulvilli, and claws, black: length  $1\frac{1}{2}$  line; expanse nearly 3 lines. (Fig. 38, the male, magnified.)

Such is the description of the male; and it is a little remarkable that the female seems to be unknown, all the bred specimens being of the former sex. There are probably seven or eight hundred *species* of these insects, which have been described as inhabitants of Great Britain; † their increase is prodigious, as already shown in a former Essay; ‡ and there is scarcely a blade of grass, during the summer months, that is not ornamented with these beautiful little creatures—

“The green myriads in the peopled grass,”—

which may compete with the humming-birds in the brilliancy of their colours.

From the stems of barley containing the pupæ of the *Oscinis vastator*, I bred a third parasite, much smaller than either of the foregoing, and found many more upon the windows of my room, where the plants were placed, which no doubt had escaped. They were all females, belonging to the Order HYMENOPTERA,

\* For the dissections see Curtis's Brit. Ent., pl. 166.

† Walker in the Entom. Mag. and his Monographs.

‡ Royal Agr. Jour., vol. iii. p. 311.

Family ICHNEUMONIDES ADSCITI OF ALYSIIDÆ, the Genus SIGALPHUS, and have been named by Nees ab Esenbeck.\*

16. *S. caudatus*, from the length of the tail (fig. 39).—It is black and shining, indistinctly punctured; the head is subglobose, with two lateral eyes, and three minute ocelli on the crown; the antennæ are as long as the body, flail-shaped, slender and filiform, composed of twenty or twenty-one joints, basal one the longest; thorax oval and gibbose, the sutures very deep; abdomen broader than the thorax, and rather longer, elliptic-ovate, with three equal segments, the two first and the base of the third finely striated longitudinally; the apex polished; belly concave; ovipositor exerted, and longer than the animal, composed of an oviduct and two sheaths; wings four, transparent, iridescent; marginal cell ovate, submarginal subovate; discoidal cells two, superior the largest, rhomboidal, inferior oblong; nervures piceous, as well as the stigma, which is large and elongate-ovate; legs pitchy, anterior ferruginous, excepting the base of the thighs and the tarsi, base of the other tibiæ ferruginous: length from  $\frac{3}{8}$  to 1 line, without the ovipositor; expanse  $1\frac{3}{4}$  to  $2\frac{1}{2}$ . (Fig. 40, the female, magnified.)

As Dr. Herpin seems to have ascertained the economy of this parasite, or a closely-allied species, during its early stages, I shall transcribe his sensible observations:—"An *Ichneumon*, of which the female is armed with a long ovipositor, perforates the shell of the *Chlorops*' egg, and deposits there its own. The young larva of the *Chlorops* of the wheat grows and increases, although it encloses in its body a mortal enemy. The larva of the parasite grows and flourishes with its victim, and she nourishes herself with its fatty substance; but, how admirable! the parasite never attacks any of the essential organs of life in the *Chlorops*, for if this happened to perish, the parasite would infallibly die with it. After the diseased *Chlorops* has metamorphosed to a chrysalis, the parasite finishes by destroying it entirely; and one sees with surprise an insect come out of the pupa of the *Chlorops*, not the destructive fly of the wheat, but an *Ichneumon*, which in its turn proceeds again to persecute the progenitor of the corn-destroying *Chlorops*."

Having now completed the history of the instruments provided by Providence to check the ravages of the *Chlorops*, we will turn to those means suggested by the experience of man; and here again I shall translate a portion of Dr. Herpin's Memoir:—

"In the years when the *Chlorops* exists in great quantities, the means to destroy it consist in pulling up, carrying away, and burning the plants which are attacked by them, as well of the first as the second laying.

\* Hymenop. Ichn. affin. Mon., vol. i. p. 268.

“ The first operation can be done at the time of weeding or of clearing the corn of thistles : the young swelled and yellow plants are easily enough known. The second operation ought to be performed a fortnight or three weeks before harvest-time, when it is much more easy to execute, as the stems attacked by the *Chlorops* are very easily distinguished, even at a distance, because of their short height, more considerable thickness, and deep green colour of the head ; and, lastly, because the ear always remains sheathed and enveloped by large leaves. Moreover, these plants thus altered are almost always found situated at the lower side of the beds or furrows, so that in passing between two ridges one can easily reach them with the hand, from one side or the other, without causing any damage to the corn.

“ Another of the most certain means, the most economical, and the most advantageous, which can in general be employed to destroy the insects injurious to our crops, is to vary the culture by alternate courses, so that corn-crops may be succeeded by others which are weeded or fed off, and *vice versâ*. It will follow that the noxious larvæ deposited in the fields, not finding at the period of their hatching the nourishment which is suited to their organization, are not able to subsist, and infallibly perish.” \*

He is also disposed to attribute the apparent exhaustion of the soil from over-cropping, as much to the presence of, and the excessive propagation of, certain injurious insects, as to the land being actually tired ; and thus the rotation and changing of culture, whenever they are not called for by other powerful reasons, ought yet to be adopted and put in practice, to hinder and prevent the too great multiplication of certain species of noxious insects.

Mr. Arthur says, “ Perhaps the most efficient preventive would be to detect the insect fly when it appears to deposit its eggs, and keep it from lighting on the field by the application of some repulsive perfume, such as soot, guano, or sand that has been immersed in gas-water, &c., dried and sown over the field.” †

As the larvæ of these flies have caused considerable alarm on many occasions, and have no doubt done extensive mischief, we will take a general review of their economy before we dismiss the subject. It is now evident that there are many species of these flies to whose larvæ wheat, barley, and rye are equally acceptable, and we cannot be certain that they are not bred in grasses also ; indeed, from the swarms of the *Chlorops* fly that are found in the meadows, and the myriads that enter dwelling-houses, often not surrounded by corn-fields, it seems to be very probable. There are also, it will be observed, two broods of the *Chlorops* annually ;

---

\* Herpin's Memoir, pp. 11 and 12.

† Gardener's Chronicle for 1844, p. 365.



the maggots of one attacking the corn when the ear is formed, but yet concealed in the sheath, doing the greatest mischief in some instances, for not only are the ears not ripe at harvest-time, but they are either abortive or the grains are shrivelled and worthless, and what is equally detrimental, the lateral shoots are rendered useless, owing to the advanced period of the season. The following, or second brood, deposits its eggs in the autumn-sown corn as late probably as the middle of October, in open weather. It is true that from the attacks of this brood the central shoot perishes in the spring. This, however, only retards the growth a little; for the lateral shoots being strengthened, and having time to grow and produce ears, it appears that in some instances little or no bad consequences followed; and it may be that even a more abundant crop has been produced under such circumstances.

It is deserving of notice that white wheats are most palatable to these larvæ, and I believe are generally preferred by noxious insects. When therefore it is stated that the *Chlorops* sometimes prefers rye and barley to wheat, it may be owing to its being red wheat, but at present this has not been substantiated.

Of the two species belonging to the genus *Oscinis*, there seems to be no evidence of their producing two broods in a year. The larvæ of the Swedish species (*O. pumilionis*) were small at the end of April, they changed to pupæ at the end of May, and the flies were produced in the middle and end of June. Our British species (*O. vastator*) was found in the larva state in May and June, towards Midsummer they changed to pupæ, and the flies were hatching, during three weeks or upwards, in July. This is decidedly the most destructive species that has fallen in our way.

With regard to the successive transformations of these insects, it is positively stated that the *eggs* are laid at the base of the leaves which sheath the ear, by the first or summer brood, and it may be presumed that the autumnal eggs are similarly deposited. To detect and destroy such atoms is impossible: the only remedy, at this period, would be to anticipate the female flies, and kill them. Whether it would be possible to attract the flies to any spot by white painted boards, or any liquor that would poison them, has not been ascertained. To drive the flies away by ammonia, gas-water, or other vapours, I should not think feasible; but I doubt not that dusting the young corn-plants with soot or lime, on the first intimation of the fly in the autumn, would prevent the deposition of the eggs.

The *maggots*, or larvæ, of the summer brood live between the stem and the sheath above ground: those of the autumnal brood appear to be close to, if not below, the surface. The former could not be affected by any application, I should imagine; but strong liquid manures possibly might annoy the others. Hard frosts,

however, are in all probability one of the greatest checks to the perfecting of these larvæ.

The next is the *pupa* or chrysalis state, which the larvæ assume about the end of March and in July, when the sickly plants are easily discovered, and may be pulled up, and should be burnt immediately, unless there is a prospect of the spring corn throwing out lateral shoots, and producing, as Mr. Markwick's did, an abundant crop. I have now only to observe that as neither the eggs, larvæ, nor pupæ are deposited in the earth, of course no ploughing or harrowing can be of the least service; and as the injury, although it may be occasionally alarming, is not followed by any succession of continued attacks, the mischief caused by them hitherto appears to have been only temporary.

*Summary of the foregoing Report.*

The larvæ of some minute beetle destroying the green wheat in 1802.

One-fifth part of the wheat sown destroyed by them.

Wireworms occasioned an annual loss of 60,000 bushels of seed.

Larva probably of a Ground-beetle, or *Carabus*, feeding on the roots of corn.

*Zabrus gibbus*, a Ground-beetle, which devours the soft grains of wheat in standing corn.

The female lays her eggs in clusters in the earth.

The larvæ burrow in the earth, and do great mischief, by eating into the stem, sometimes destroying two successive crops of wheat in Germany and Italy.

They also attack rye and barley.

Both the larvæ and perfect insects feed by night, and lie concealed during the day.

Poultry and Crows will clear the land after ploughing.

Peat-ashes are an excellent dressing for infested lands in the spring.

The *Field-chaffer* feeds upon the soft grain of rye and wheat.

It is not known if their larvæ attack the roots of corn.

*May-bugs* abundant in corn-fields, feeding on leaves and flowers.

Do they injure the corn?

Their larvæ consume the roots of grasses.

A *Caterpillar* which feeds upon the grains of wheat in the field, as well as in the barn. It also lives upon the seeds of grasses.

These larvæ destroyed one-third of the produce occasionally.

Noxious insects often appear simultaneously over a great extent of country.

These *Caterpillars* will attack and destroy each other in confinement.

Repeated ploughings recommended to destroy the pupæ; but as the Caterpillars are conveyed away with the corn, that would be useless.

The "*Pale mottled willow-moth*" is the parent of this Caterpillar, and is abundant in hay-fields, &c.

*Caterpillar* of a *Saw-fly*, found on wheat-ears amongst standing corn.

*Musca pumilionis*, the larva very destructive to rye.

The *discased stems* should be collected and *burnt*. One person could collect some thousands in a day.

The same or an allied species attacked the *wheat* near *Battle*.

The *central shoot* being destroyed, lateral branches were thrown out and a *good crop* was obtained.

The *September and October sown wheats* only affected, and the *red wheat* nearly escaped.

In 1812 the *Society of Agriculture* of the *Seine* was officially consulted by the *Minister of the Interior*, regarding the ravages in France occasioned by the larvæ of *Chlorops lineata*.

The *larvæ destroyed* the central leaves and the *plant* itself.

When the *wheat* begins to show the ear early in *June*, the *female* lays her *eggs* on the stems.

The *eggs hatch* in a fortnight, and the maggot eats away below the base of the ear.

It is transformed to a *pupa* towards the first superior knot.

The *Chlorops hatches* in *September*, and then lays her eggs on the rye and recently-sown corn.

The infested *corn is stunted* and green, whilst the healthy plants are ripe: the ears are not liberated, and the grains are diminutive or quite abortive.

In 1840 the *loss* was estimated at *one-seventieth part* of the harvest, besides the number of young plants that had been destroyed at an earlier period.

*Chlorops Herpinii* attacks the ears of *barley*: from six to ten being found in each; and by destroying the flowers they render the ears sterile.

*Musca Frit.* inhabits the husks of the *barley*, and destroys one-tenth of the grain.

*Linnaeus* calculated the annual *loss* in *Sweden* at *one hundred thousand pounds sterling*.

*Chlorops tæniopus* attacked some transplanted wheat.

The *larvæ feed singly* from the first joint to the base of the embryo ear, or higher.

In *August* the *flies hatched*.

They attacked *barley* also at an earlier period.

It attacked also some naked *barley* from *Nepaul*.

A species of *Chlorops* occasionally swarms in *dwelling-houses*.

They were in abundance in a *wheat-stack* in April, and destroyed many acres of *rye*.

Another species attacked the *wheat-fields* last May.

The *larvæ* entered two inches beneath the surface, destroying the *internal stalk*.

Other fields of *wheat*, sown in *February* and *March*, were subject to the same disease.

These maggots produced in July a new species of fly, the *Oscinis vastator*.

This, from its operations, appeared to be the *most destructive* of the species.

They are kept in check by *parasites*.

One, a kind of Ichneumon, named *Cælinius niger*, feeds in the body of the maggots, and is frequently very abundant.

Another, called *Pteromalus micans*, lives in the maggots also, and destroys them before they change to pupæ.

A third parasite, the *Sigalphus caudatus*, was bred from the pupæ of *Oscinis vastator*.

It is said to deposit its *eggs* in those of the *Oscinis*.

Dr. Herpin recommends *pulling up and burning* the infested plants, which may first be done when weeding is going on, and subsequently two or three weeks before harvest, when their size and colour readily distinguish them.

*Rotation of crops* one of the best means of keeping free from noxious insects.

*Over-cropped land* refuses to bear, perhaps as much from diseases caused by an excessive increase of insects in the soil as from exhaustion.

*Soot, and sand* saturated with gas-water, sown over a field, might keep off the *Chlorops*.

It is not improbable that some species of *Chlorops* breed in the stems of *grasses*.

There are *two broods* of the *maggots* in a year, the first living in the spring, the latter through the winter, in some instances.

The *first brood* destroys the ear, the *second* the central shoot, after which lateral shoots are sometimes matured.

It is doubtful if the species of *Oscinis* produce two broods annually.

The *O. vastator* is by far the most formidable enemy.

Is it possible to *attract the flies* by white painted boards or poisonous liquids?

Dusting the young corn with *soot or lime* would drive away the flies.

Strong *liquid manures* would annoy those broods which reside in the young corn-plants.





*Do not pull up* the infested corn-plants in the *spring*, if they attempt to throw out lateral shoots.

*Ploughing and harrowing* of no use, as neither the eggs, pupæ, nor larvæ inhabit the earth.

## EXPLANATION OF PLATE K.

- Fig. 1. A young wheat-plant.  
 Fig. 2. The larva of some beetle.  
 Fig. 3.\* The same magnified.  
 Fig. 4. The same eating the wheat-stem.  
     *a* The portion consumed by the larva.  
     *b* The surface of the earth.  
     *c* The old husk, showing the hole into which the larva retreated.
- Fig. 5. Larva of some *Carabideous* beetle?  
 Fig. 6.\* The same magnified.  
 Fig. 7.\* *Zabrus gibbus*.  
 Fig. 8. Larva of ditto.  
 Fig. 9.\* The same magnified.  
 Fig. 10. A portion of earth dug up, showing the economy of the larva.  
     *d, d* The entrances to the burrows.  
     *e* The curved portion.  
     *f* One of the cavities or cells for the pupa.
- Fig. 11. A pupa resting in the cell.  
 Fig. 12.\* *Anisoplia Agricola*.  
 Fig. 13.\* *Anisoplia Horticola*.  
 Fig. 14. Larva of ditto.  
 Fig. 15. An ear of wheat eaten by the caterpillar of *Noctua (Caradrina) Cubicularis*.  
     *g* The perforated grains eaten out.  
     *h* One removed.
- Fig. 16. The caterpillar when half grown.  
 Fig. 17. Another full-grown.  
 Fig. 18. The moth (*N. Cubicularis*), supposed to be the parent of this caterpillar.  
 Fig. 19. Larva of a *Tenthredo*?  
     *i, j*\* The two jaws, or mandibles.  
     *k*\* The maxilla and palpus.
- Fig. 24. The *upper portion* of the stem of wheat affected by *Chlorops tæniopus*.  
     *p* A hole in the husk of the basal grain.

## PLATE L.

- Fig. 20. *Chlorops tæniopus*.  
 Fig. 21.\* The same magnified.  
     *n* The termination of the costal nervure.  
     *l*\* One of the antennæ, or horns.

- Fig. 22\* The head in profile.  
*m* The concave face.
- Fig. 23. The fly in repose.
- Fig. 25. The lower portion of the wheat-stem, detached from, and belonging to, fig. 24, pl. κ.  
*o* The pupa of *Chlorops taniopus*, *in situ*.
- Fig. 26.\* The same magnified.
- Fig. 25. a Pupa case from which *Cælinius niger* hatched.  
 b\* The same magnified.  
 c The hole from which the *Cælinius* escaped.  
 d The hole from whence the *Pteromalus* made its exit.
- Fig. 27. A wheat-plant as it appeared on the 7th of June.
- Fig. 28. Larva of a *Chlorops*.
- Fig. 29.\* The same magnified.
- Fig. 30. The pupa case *in situ*.  
*q*\* The same magnified.
- Fig. 31. *Oscinis vastator*, Curtis.  
*r*\* The same magnified.  
*n* The termination of the costal nervure.
- Fig. 32. Corn-plant as it appeared on the 23rd of June.  
*s* The green outer leaf.  
*t* The inner yellow one.
- Fig. 33. The same plant opened.  
*u* The base of the stem eaten through.
- Fig. 34. The interior of the stem exposed.  
*v* A slender brown portion of the stalk left by the larva.  
*w* The larva feeding.  
*x*\* The same magnified.  
*y* The pupa in the stem.  
*z*\* The same magnified.
- Fig. 35. *Calinius niger*, a parasite.
- Fig. 36.\* The same magnified.
- Fig. 37. *Pteromalus micans*, a parasite.
- Fig. 38.\* The same magnified.
- Fig. 39. *Sigalphus caudatus*, a parasite.
- Fig. 40.\* The same magnified.

*Obs.*—Wherever lines accompany the objects in the plates, they denote the natural dimensions; and those numbers and letters with a \* attached, refer to the objects that are represented much larger than life. All the figures are drawn from nature, excepting Nos. 1, 2, 3, 4, and 8, 9, 10, and 11: the four first are copied from the Linnæan Transactions, and the other four from Sturm's Deutschlands Fauna, vol. iv., pl. xxviii.

Hayes, Middlesex, Nov. 1844.







XXVIII.—*On Peat Charcoal as a Manure for Turnips.*

By W. UPPLEBY.

THE process of charring peat is very simple, if you have only plenty of water so near your fires that it can be scooped on as soon as the heaps are nearly red, though the fires want dragging down level before the water is thrown on: it is not necessary to wet the fires above half through; it then forms a coat at the top, which stops the fires doing anything more than smothering. The fires want examining next day, to see that it has not broken through anywhere, the top will be black from the water putting the fire out, and the bottom will be charred from the top smothering it. I have tried all ways with sods and clay, but could never succeed; the fires will be through them. I had almost forgot to tell you the chief thing, which is, not to light your fires while your pile is completed, as a shower of rain will not stop peat from burning when it once gets fire in it; and to light them at the outside, that is, not putting fire underneath your clumps (it will then eat its way into your clumps); and not to burn in windy weather the dried clumps. I think the best are about six feet wide at the bottom, rounding to the top, about six yards long, leaving a space for the man to walk and drag, as occasion requires. The first clump will want some fire, or something to start it, but still putting on the top, and setting on fire, the hot ashes will fall in amongst the peat, and start it; after that, hot ashes from the first fire will be the only kindling you require, and are the best, as I have always found the longer the clumps are burning the better; but everything depends upon well dragging the fires, not letting them get red hot, without putting it sideways. I have burnt very good ashes in this way without water at all, when it has been in the middle of a field; but should recommend the ditch sides for the process, when water is good to come at, and I think the peat would pay for leading then, as you might lead the peat to the water, as soon as fetch water to the fires, without injuring so much grass, or whatever may be wanted to grow there. I am certain, when water is not plentiful, your man must be constantly putting the fires outwards as they burn. I find the ditch sides for another reason the best; the fires will be ten days or more in burning, and the ashes can lie on the ditch sides any length of time without stopping so much land from being sown, and wait for a convenient time to lead them away. I cannot make an estimate of the increased quantity by this process; all I can speak from is, that one waggon load of ashes burnt this way is preferable to two burnt as long as it will burn, which is the common process. Yet by checking the fires we produce a larger quantity of ashes than by the common method. The tur-

nips that were drilled with dead burnt ashes two years since, were not fit to hoe, when the thirty-acre plot was furnished and even sown at the commencement of the field. The same year my house ashes I put on one side of the field, and black peat ashes on the other, therefore every other drill tread would be sown with them. We had to hoe all the peat-ashed sown rows first, right through the field, and both were used in the same quantities, about two waggon loads per acre. My turnips are really excellent, and I used nothing else. I am just finishing a 30-acre field, which has been eaten off with 850 shearlings: calculating the sheep at 6*d.* per head, makes the turnips come to 5*l.* 7*s.* an acre; all old sheep.

*Bonby, Lincolnshire, 9th Dec., 1844.*

---

XXIX.—*Breeding and Management of Horses on a Farm.* By  
JOHN BURKE, Jun.

WHILE the attention of English farmers is very generally directed towards improving the various breeds of sheep and cattle for which our island has become so celebrated, there are very few of this class of persons—except in some counties deemed peculiarly adapted to breeding horses—who pay more than the most ordinary attention to selecting such mares and stallions as are likely to produce stock either valuable as hunters or cart-horses; while the greater number perhaps of agriculturists are inattentive to the various points which constitute excellence in the shape or qualifications of sire and dam, contenting themselves very generally with breeding from any mare they may happen to possess, whether good or bad, and with any stallion that may chance to be in their neighbourhood. It will be my endeavour in the following pages to point out those properties in the parents which are necessary to the propagation of valuable offspring, and without which the horse-breeder can scarcely venture to hope for remuneration; and likewise to demonstrate upon physiological principles—the only true ground-work of scientific management—the most judicious plan to be pursued in rearing young stock with a view to improving their growth and consequent capabilities.

There are very many points in the various descriptions of horses which are common to all, and to which it is necessary to pay the strictest attention when choosing a stallion or mare for the purpose of breeding; but there are likewise several others which are of greater importance in one species of horse than in another. Thus, for instance, those qualities which denote superior strength, combined with a certain degree of activity in the walk, are prin-

cipally required in those animals which are exclusively bred for agricultural purposes, or for heavy draught of any kind; while not only is strength a most important feature in the horse likely to make a hunter that will probably some day put a large sum of money into the pockets of his owner, but he must likewise be noted for speed, enduring powers, and activity in every pace, united to beauty of form, so far as it can be obtained; and hence, in breeding hunters, it is advisable to select such stallions as have both a good pedigree, and are known not only to possess the above qualifications in an eminent degree themselves, but also to be the descendants of animals conspicuous for the stoutness of their blood, whether in the field or on the turf. For this reason it will be requisite to take a separate view of the different qualities to be sought in the sires and dams of each of the above breeds, by a careful attention to which the breeder may in some measure secure himself from the risk attendant upon breeding from any sort of animal in his possession, and which may have been selected without reference to procreation, and avoid the almost inevitable loss consequent upon leaving to chance what should be the result of scientific discrimination.

Let us first take a view of the most material points requiring consideration in the hunter, or nearly, if not quite, thorough-bred horse, and then proceed to notice those which constitute the chief points of excellence in the horse destined entirely for draught.

The great improvement which has taken place in the breed of hounds during the last thirty years, and the pace at which they now go, renders a corresponding degree of excellence in the hunter absolutely necessary to those who desire to be properly carried in the chase; and hence the old style of hunter, a close-knit, half-bred horse, possessed of many very excellent points, but deficient in the one grand requisite of swiftness, has almost entirely disappeared and given way to an animal of far more blood, and capable, from that circumstance alone, of vast endurance and considerable speed. Indeed a great number of first-rate hunters of the present day are thorough-bred, or at most have a stain in their pedigree so remote as to place them nearly on a par with the horse of full blood in every respect, save that of being able to claim a place in the stud-book among horses of unspotted lineage; and this very defect is to many half-bred horses (or, as they are termed, *cock-tails*) a great advantage, a certain allowance of weight being made to them in most races for which they may be entered, as some hunter-stakes, and most of the races for which thorough-bred horses contend. As it is not my intention to enter in this paper upon the subject of breeding for the turf, it is needless to advert to the subject further than to show the agriculturist that, for more reasons than one, the better

his stock is bred the more money will it in all probability realize for him. There are numbers of gentlemen at the present day who, in purchasing a hunter, look to become possessed of an animal that will not only carry them well through the season, but likewise become qualified to run, with a good chance of success, for one or two heavy hunter-stakes, and who on this account will not buy an animal of inferior pedigree; and consequently it must ever be to the farmer's advantage to breed such horses for the field as are likely to suit the greater number of purchasers; and if he himself has no private opportunity of disposing of his stock to gentlemen, he may be well assured that those dealers who are on the look-out for first-rate hunters are perfectly aware of the great superiority which a good pedigree never fails to bestow upon any horse destined for the field, and the additional advantages, independent of the chase, that may be derived from the possession of a speedy, thorough-bred hunter.

For this reason, in breeding horses for the chase, never on any account put your mares to half-bred stallions. The produce, in nine cases out of ten, will disappoint your expectations, and will probably only realize a moderate sum that will do little more than return the expenses of breeding and rearing, instead of repaying you possibly four or five times your outlay.

There are, perhaps, but few agriculturists who wish to breed hunters who do not imagine that by selecting a good-sized, roomy, and well-shaped mare, and by putting her to the first thorough-bred horse they may meet with, they have done everything needful to secure to themselves a foal of considerable value. Such men, however, imperfectly acquainted as they are with the history of the turf, may have erred materially in the selection of a stallion for the procreation of stock likely at some period to shine in the field. Thus, there are numbers of flashy-looking, pampered stallions travelling in every county during the breeding season, whose blood will be immediately known to the man versed in racing lore to be greatly deficient in the great requisite of stoutness, and he will consequently, if a judicious breeder, reject all such horses, however tempting may be the low price at which they cover; whereas the farmer, unskilled in the annals of the turf, and delighted probably with the expectation of obtaining a nearly thorough-bred colt or filly at little expense, and which he *hopes* may turn out an animal of considerable value, does not scruple to put his mares to a horse of inferior quality, provided he have a thorough-bred pedigree of any kind. This system is tantamount to the supposition that a horse of full blood must *ipso facto* be an animal likely to beget stock of a superior description; whereas those who have paid even a very moderate share of attention to the subject of breeding, must be aware that there is

perhaps no distinct species of horse among which are to be found so many absolutely worthless and useless animals as among those that are thorough-bred. This fact is fully borne out by the great numbers of weedy, thorough-bred hacks that, during the London season, may be seen ambling round the parks, and which, although possessed of some degree of showiness, which captivates the fancy of many a man unskilled in the knowledge of those points denoting superior excellence in the horse, are nevertheless quite unfit to go through a very moderate share of fatigue with a weight of twelve stone on their backs, and, in all probability, at the close of the season may be purchased for a less sum than the first cost of begetting them. The evil of breeding these weakly undersized animals unfortunately does not stop with their production, but numbers of them becoming, when good for nothing and unsound, the property of men possessed of a little land—situated perhaps by the side of a common that affords but a scanty subsistence to young stock—are put to some cheap and worthless stallion, and made to propagate animals far worse than themselves, and whose naturally undeveloped proportions are still further stunted by the insufficient nourishment they are enabled to obtain. Thus the evil of a want of knowledge on the part of the breeder of the proper formation and pedigree of stallions and mares, spreading wider and wider every year, is in point of fact a national loss as well as a national disgrace to a country hitherto famed all over the world for its breed of horses; and if allowed to continue, from ignorance of the first principles of breeding, or from the attention of agriculturists not being properly directed to the most material points to be considered in the selection of sire and dam, must eventually deteriorate the excellence of our blood and deprive us of that superiority which has so long been our boast, and which up to the present moment has never for a long series of years been disputed by any nation under the sun.

Ere I proceed to notice the principal features denoting excellence in the horse, and calling for the discrimination and judgment of the breeder, I must instil into my readers the indisputable fact that there are very few of the diseases and defects of the horse that are not hereditary, and that, if uncorrected by scientific discrimination, will not appear in the second or third generation. I must here presume that the breeder is intimately acquainted with the different diseases incident to horses, as the limits of this paper will not allow of my entering upon any notice of them. Some distinction, however, is to be made between congenital and acquired disease. Thus, for instance, a mare with curbs, although put at various times to different horses, has been known constantly to bring forth foals afflicted with the complaint of the dam, and such an animal should consequently be rejected from the stud by

the careful breeder; but should a mare throw curbs from any sudden and violent exertion of the hind legs, as in taking some extraordinary leap, or in struggling through very deep ground with a heavy weight on her back, it is questionable whether her progeny will inherit a defect thus produced by accident; as in like manner a racer, that has broken down from great exertions on the turf, does not procreate offspring similarly diseased. Still, after some lapse of time, it is not impossible, nor indeed improbable, that the progeny of such a horse may be foaled with a congenital weakness of the back sinews, which may terminate in a rupture similar to that of the sire. It is consequently better, if possible, to breed from animals that are in every respect sound; and if one of the parents have any peculiar defect—as, for example, a very large head, or somewhat straight shoulders—it should be corrected, as far as may be, by a corresponding point of superior excellence in the other.

With this proviso, I shall proceed to enter upon the consideration of the principal points to be sought after in both sire and dam by the breeder of first-rate hunters.

To begin with the dam. Having ascertained, as far as possible, what may be her pedigree, and whether she came of a stock free from disease of any kind, and if not famed for speed and endurance, at all events not noted for a deficiency of these very necessary qualifications, let her frame embrace most, if not all, of the following requisites for producing a healthy, vigorous, and valuable offspring. Let her forehead and space between the ears be broad—for in proportion to the width of the upper part of the head shall be the mass of cerebral matter which shall impart energy, spirit, and courage to her progeny, and endow them with determination to struggle through difficulties, and resolution to dare the greatest obstacles. A want of this point may be the means of producing a timid, nervous animal, that will balk his fences, and start at the most trifling noise or unusual object. Below the eyes the nose should taper gradually towards the nostrils, which should spread slightly outwards, giving free ingress and egress to the air, and be capable of expanding considerably during exertion of the body. A bright red and vascular appearance of the lining membrane of the nostril is very generally a token of good blood and plenty of spirit. If the mouth be deep so much the better, for a shallow-mouthed horse carries a bit badly; this, however, is not a point of any great importance.

The ears should be long, thin, pointed forwards, and composed entirely of cartilage covered by a fine skin: if fleshy, or hanging laterally, they are symptoms of dulness and want of fire. A short ear is by many people considered a beauty; but the long and finely-pointed ear is frequently a proof of good breeding, and



as such is desirable in a mare intended for the procreation of well-bred stock. A sharp quick motion of the ear backwards and forwards on its own axis is in many instances an indication of sprightliness and vivacity, and on that account should not be entirely overlooked by the intelligent breeder.

The eyes should be clear, bright, somewhat prominent, large, and open; a drooping eyelid being, in many instances, a symptom of periodical attacks of inflammation, besides denoting a dull and inactive disposition. If there be a white spot upon the forehead, above the eyes, it is generally considered not only a mark of beauty, but likewise of goodness.

The jaws should be lean, yet muscular, and placed far apart from each other, so as to afford plenty of space for the admission of the trachea or windpipe, which should merge between them with a gentle and regular curve, so that when the horse's head is moderately extended there may exist no impediment to inspiration and expiration, as is the case to a certain extent in the horse whose head forms rather a sharp angle with the neck. The space underneath and between the jaws should be perfectly free from swellings or grossness of any kind.

The neck should be of medium length; a short neck often accompanying thick wind, and a long one being frequently indicative of a predisposition to diseases of the respiratory organs, and a sign of a weak constitution: it should rise gradually from the shoulders with a gentle curve, diminishing in volume as it approaches the head, with which it should appear, as it were, to blend itself—few things being more ugly in the horse than an ill-placed head—and the curve of the under part of the neck should be continued to the space within the jaws.

The shoulders of the mare intended to breed horses destined for the field can scarcely be too oblique or too deep. The sloping position of this most important part is productive of higher and cleaner action than can be possessed by the horse whose shoulders are upright—a fault that seldom fails to render him unpleasant under the saddle, and frequently unsafe. The possibility of a stallion and mare, each with extremely oblique shoulders, begetting a foal whose action may turn out too high and dashing for a hunter need never deter a farmer from breeding from them if good in every other respect, since it is well known that extraordinary action will always produce an extraordinary price for some purpose or other. The wither should be high and somewhat narrow, and the whole of the shoulder or blade-bone covered with flattish, wiry-looking muscle—too great a quantity of flesh on this part being generally accompanied by a somewhat upright shoulder, whose disadvantageous position requires a greater moving power than the shoulder more obliquely placed.

The chest of the mare should be roomy in proportion to her breed; for it must be remarked that this part is generally found wider and wider the more the breed approximates to that of the cart-horse. A horse with a very broad forehead is rarely gifted with any very considerable degree of speed, and consequently such a formation is undesirable in the horse destined for quick work. To give room, however, for the play of the heart and lungs, it is absolutely requisite that there be great depth of body, and considerable girth immediately behind the shoulders, and that the ribs be well arched—a flat side being a decidedly bad point in either horse or mare.

The fore-legs, from the elbow down to the knee, should be clothed with extremely well-developed muscles, projecting considerably at the fore-arm, and gradually diminishing towards the knee, which, with the pastern, and, indeed, every other joint of the body, should be large, for the purpose of giving insertion or play to the various ligaments and tendons that are inserted into or near them. The size of the joints is a matter of very considerable importance, although frequently overlooked by many who judge of a horse's bone by spanning the shank—a part which, although requiring development for the insertion of the muscles of the leg, is by no means of so great consequence as the expansion of the joints. From the knee to the fetlock the fore-leg should be flat laterally; an appearance that is principally to be derived from the strength and position of the back sinews rather than from any unusual quantity of bone, which in the blood-horse is known to be heavier and much less porous than in the horse of inferior blood. The tendons in their passage at the back of the knee should never be contracted or too closely tied down by the ligamentous expansions over the joint, otherwise their power and freedom of action will undoubtedly be thereby considerably diminished. A moderately long pastern-joint, not too upright nor yet sloping too much forwards, should gradually expand in its descent into a well-formed hoof, perfectly smooth, and, if possible, black (for black hoofs are the hardest), and free from contraction of either quarter, or disease of any kind whatever. There are few points in a horse that require greater experience and more practical judgment than a knowledge of the proper formation and diseases of the foot; and, consequently, every horse-breeder should make himself thoroughly acquainted with the natural form and defects of this all-important part; for although a horse with bad shoulders, or even legs, may be made to go a certain pace, one with bad and crippled feet never can; and diseased feet will besides materially diminish the value of a stallion or brood-mare, since no one in his senses will use them for the stud. I shall have something to say by-and-by respecting the proper management of the feet, their diseases very

frequently arising from want of care, and ignorance of their natural functions. The position of the fore-legs is a point of some consequence. If the elbow be turned outwards, the feet will naturally turn in the contrary direction, and the mare will, consequently, cut the pastern-joints with her shoes, or, at all events, have that faulty style of action which is termed "*dishing*," and which consists in a sort of semi-circular motion of the fore-legs, by which the sole of the foot is laterally visible at every stride. Very few horses whose feet are turned outwards are speedy for a distance, the centre of gravity in them being improperly placed, and giving rise on that account in many instances to depositions of bony matter by which Nature seeks to remedy the defects of malformation. The proper position for the fore-legs, then, is straight, turning neither outwards nor inwards, the toe being immediately underneath the point of the shoulder. When it stands much under this spot the mare will probably be weak in the joints; and if it project beyond it the shank-bone will incline forwards from the knee, producing what is called the calf-leg, an essential fault which almost invariably deprives its possessor of the power to stand hard work.

I have said that the ribs of the mare should be arched, her girth behind the shoulders great, and her withers moderately high; but this latter appearance should never be caused by a depression or hollow behind them, which is a never-failing sign of weakness: a similar transverse depression of the back-bone above the hips indicates also a certain degree of want of power. The loins should be arched and broad, and the quarters long and wide behind. A considerable projection of the hip-bones, although unsightly, is by no means to be considered a fault, provided it be not caused by a narrow carcass: on the contrary, such a formation is rather desirable in a brood-mare than otherwise, as it will not only afford room for the enlargement of the uterus and expulsion of the foal, but is likewise very generally a sign of great strength of the hind-quarters.

A well-bent ham is always an excellent point in either horse or mare, and gives assurance that the hind-legs during motion will be well placed under the belly, instead of paddling behind, which species of action, or more properly want of action, can never be fast, and is frequently occasioned by a want of development in the hock, which, instead of projecting posteriorly until its cap or point be at least perpendicular to the leg, is so placed that the back of the hock-joint inclines gradually downwards and outwards, by which a great amount of leverage is lost. The thighs, from the hip to the hock, should be extremely well furnished with muscle, the hock-joint large and deep, and the shank flat and wiry.

The position of the hind-legs should be somewhat under the

belly; the toes being neither turned inwards nor outwards, though the latter, if not excessive, is the lesser fault of the two.

Such are most of the principal points to be attended to in the selection of a brood-mare; but all of them must bear a just proportion one to the other, the limbs being close-jointed, and somewhat short below the knee and hock, the carcass close but roomy, and the neck not too long. The harmony existing in the proportions of any animal will be felt and recognized at a glance by many men who have a naturally keen sense of the beauties of form, whereas many others not similarly gifted can never justly appreciate in what consist the exquisite moulding and symmetry of the choicest specimens of our best breeds of animals. With respect, however, to a horse, although a good judge may at first sight be struck with his general appearance, it is always better to form an opinion of his capabilities with reference to the various essential points I have enumerated, than to judge of him by his *tout ensemble*; and any man with a little discrimination and attention may soon make himself master of the degree of knowledge requisite for his guidance in this particular.

The chief points of excellence in the stallion are, in every respect, similar to those I have enumerated in the mare, with, possibly, the exception of his form being altogether more compact and closer ribbed up, and his joints nearer together, and more firmly knit, his whole appearance indicating the possession of great power and vigour in a comparatively small compass. In selecting a stallion for the purpose of breeding hunters, it is likewise proper to make choice of one, if possible, whose stock give general promise of power and action, and bid fair to shine in the field, if not fast enough for the turf. There are many of our racing stallions that have scarcely ever begotten a foal that turned out a good racer, but that, when put to mares not quite thoroughbred, have produced hunters of first-rate capabilities; and, when their fame in this particular is generally well-known and admitted, it is far better to send a mare a hundred miles to such a horse than to breed from one whose progeny, at five years old, may possibly not be worth the expense of rearing. On this point there can hardly be two opinions, and yet, with the exception of those mares that are kept for the purpose of breeding for the turf, there is scarcely a man in the kingdom who will take the trouble to send a half-bred mare even a score of miles, with a view to secure for himself all the probable chances of breeding a first-rate hunter. With respect to farmers in general, horse-breeding is an affair purely of luck, and the first over-fed stallion, with a big crest and a head bedecked with gay ribbons, that calls at their homesteads, has all their mares, however much their principal points may differ from his and from each other.

The height of a brood-mare may vary, according to her form, from fifteen hands two inches to sixteen hands; and where a stallion of good blood, and very compact mould, can be procured not higher than the mare, he is to be preferred, *cæteris paribus*, to a larger horse, some experiments on breeding having tended to prove that a mare put to a horse even somewhat smaller than herself is likely to throw a finer foal than when stunted to a larger stallion. The age most fitted for procreation of both sire and dam is from seven to fourteen years (or somewhat less for the dam). The records of our racing studs, which are to be looked upon as the mirror of breeding, will not, I believe, furnish many examples of any horse having, when young, proved himself a sire of superior qualifications; and many a stud-horse that has never begotten a racer in his early years, has, after the age of ten, become the sire of very first-rate stock.

When proper attention is paid to the shape and soundness of sire and dam, their progeny will bid fair to possess that grand essential, good action; but this is a point which should not, however, be overlooked in the parents, how well soever they may be formed. Really good action does not, by any means, consist in that clambering and showy style of going which so many people admire, and which not only reduces the length of a horse's stride, but, with "much ado about nothing," soon makes him show marks of work about the joints. A horse with really good action should not raise the leg more than on a level with the middle of the fore-arm, but, stepping well above the ground, should throw the leg out in a perfectly straight direction, without any circular motion, or any inclination of the foot outwards or inwards. The hind-legs should be thrown well under the belly, and every motion should be performed with ease, grace, and springiness.

Never breed from horse or mare of a bad constitution; the progeny will be weak and unthrifty, either undersized or leggy, and will never repay the cost and trouble it will occasion. The farmer will probably have little or no opportunity of ascertaining the constitution of a stallion, unless he be a horse of repute, but compactness of form, and power about the joints, will seldom prove an uncertain sign by which to form an opinion on this point; and with respect to the mare, as he will probably have every opportunity of forming his judgment of her before he puts her to the stud, it will be his fault if he breed from one that is a shy feeder, or incapable of undergoing fatigue without long intervals of rest. It must be clear that, independent of the constitutional defect of the dam descending, probably, to the foal, such an animal is not likely to be able to afford that degree of nou-

ishment to its offspring on which its growth and early development must principally, if not wholly depend.

The best time of putting a mare to horse is somewhere about the beginning of April, if possible; for then, by the time the foal is able to nibble, the weather will probably be warm, and the pastures full of sweet and nutritious grasses. A month later in the year may not be objectionable, when a farmer breeds solely for the purpose of obtaining a good hunter; but if his mare be thorough-bred, and he wish to take the chance of having a foal with some pretensions to running, then the earlier a mare is stunted the better, for all running horses date their birth from the 1st of January, be they foaled when they may, and consequently it is of great importance that they be dropped as early in the year as may be, in order that their growth may be forwarded by every means that can be devised consistent with their healthy state. It is a question, however, whether very early foals, that are kept for months on artificial food, will be more forward at two years old than those dropped towards the end of the spring, and properly attended to subsequently; but there can scarcely be a doubt that, as a mare goes somewhere about eleven months with young, and may not prove in foal for some time after she first goes to horse, the latter end of March or the beginning of April is quite late enough in the season for breeding.

So much, then, for the principal points to which attention is to be directed in the choice of stallions and mares for breeding the nearly, or quite thorough-bred hunter of the present day. Should the produce not prove fit for the field, it will rarely fail to make a harness-horse of considerable value. The same regard is to be paid to the different points of those mares and stallions that are selected for the purpose of breeding carriage-horses as to those already referred to in speaking of the hunter, but both sire and dam should be of larger mould, and it is not necessary that either of them be thorough-bred. A large, roomy, half-bred mare, if put to a three-parts-bred stallion of considerable power, and gifted with good action, will probably throw a colt well adapted for a gentleman's carriage, provided sufficient attention to soundness, and those material points which have already been noticed, be paid by the breeder in making choice of them. The greater number of these animals are bred in Yorkshire and the adjoining counties, and are generally known as the Cleveland breed. There can, however, be no reason why a similar, or indeed a better sort of carriage-horse, should not be bred by any farmer who possesses sound judgment, and a sufficiency of good pasture to ensure the proper development of his young stock. Very many of the Cleveland horses are disfigured by having large heads and Roman noses; and it is only when these parts are, to a certain extent,

concealed by the winkers of the bridles and the trappings that adorn them, and their heads are borne up by the bearing-rein, that they acquire the imposing appearance which, when well-matched, so many of them possess. When stripped, a great proportion of them appear a very different sort of animal indeed, and, in all probability, a smaller and a more compact sort of horse would go through double the quantity of work that they are capable of enduring. Fashion, however, is to be consulted by the breeder to a certain extent; and so long as he can obtain from job-masters a large sum for a pair of these overgrown animals, he will do well to breed them without reference to their being unequal in point of endurance to a smaller and better-formed sort of draught-horse. It is generally supposed that a horse destined for harness should not have a very oblique shoulder, as when so formed he is not capable of throwing so much of his weight into the collar as when his shoulders are more upright; but it must be remembered that grand and lofty action is highly prized in London for the purpose of show, and not for hard work, and hence a sloping shoulder is a point to be desired by the farmer who breeds carriage-horses for the London market; for, as I have already observed, it is one which is mostly accompanied by high action.

The different breeds of cart-horses that have acquired the greatest renown for their appearance and good qualities are the Suffolk Punch, generally of a chesnut-colour; the Lincolnshire, or black cart-horse, principally used in London by brewers, coal-merchants, distillers, and wharfingers, who are obliged to employ a large and powerful species of horse for the transport of their heavy goods; and the Clydesdale, a breed principally confined to the valley watered by the Clyde—whence their name. The most distinctive features of the first of these breeds were, its extreme compactness, and its great and instinctive disposition for draught. The original breed is at the present day, I believe, almost extinct, and has given place to a somewhat lighter description of horse, with greater nimbleness of action, and altogether better adapted to the light soil of Norfolk and Suffolk, where they are principally bred.

The black Lincolnshire cart-horse is an animal too well known everywhere to require any very lengthened description. He is a large, showy, and powerful animal, from sixteen to upwards of seventeen hands in height, and although, probably, too slow for agricultural purposes, except on heavy, tenacious, clay soils, is certainly well adapted to the work to which he in general is eventually applied, viz., to drawing heavy loads about London and its vicinity; his immense size enabling him to throw a vast weight into the collar, and to overcome a resistance that simple

muscular power alone would not permit a smaller horse to move without the greatest exertion.

The Clydesdale is a smaller and more active kind of horse, and is said to be an honest puller, and capable of going through a considerable quantity of work. There are not many of them that come very far south, as, unless they be purchased at a price that will repay the dealer, after deducting travelling expenses, they possess no particular feature that may not be found in any of the best cart-horses that are bred all over England.

A farmer who merely seeks to become possessed of a stallion or mare of any particular breed, without reference to form and capabilities, and expects, on that account, that their stock shall show that superiority for which some of the breed are distinguished, may find himself very egregiously mistaken, and, consequently, I have but little to say beyond the remarks I have just made on the principal breeds of cart-horses which, in this kingdom, have become, at one period or other, noted for any particularly good qualities; being well convinced that, by due attention to form, constitution, action, and powers of draught, a good cart-colt may be bred from any of the various sorts of cart stallions and mares that are to be met with in every county, and that are not distinguished by any such particular feature as may have led to their being considered a distinct breed. The great reason why some counties can boast of a superior sort of horse for the purposes of draught is, that, at one period or other, a successful cross has produced animals of decided excellence, and this breed having been carefully kept up, many of the descendants of these horses still inherit the good qualities of their ancestors, and are prized accordingly; but there cannot be a doubt that similar improvements may be made in every county by careful selection, and sound judgment in appreciating the different points of sire and dam which are likely to confer superiority upon the offspring.

Although most of the principal points of the horse that have already been considered are desirable in the animal solely intended for slow draught, there are a few in which he should essentially differ from the horse of better blood, the principal of which is in the formation of the shoulder. Most people affirm that the shoulders of a cart-horse cannot be too upright, as such a position enables him to lean with most advantage against the collar in drawing a heavy weight. This assertion may be true, but it should also not be forgotten that when the shoulder is extremely straight the step of the animal is shortened, and, consequently, what he gains in being able to throw most of his weight into the collar he loses in quickness of motion. If a horse's foot on being put to the ground during progression do not extend



beyond a perpendicular line dropped from the point of the shoulder, he is decidedly a slow and bad walker; and as the walk is the only pace in which a good cart-horse should excel, a moderate slope of the shoulder, sufficient to ensure free action of the fore-legs, is desirable, though not by any means equal to the obliquity of the same part necessary to the proper form of the horse required for fast work. The wither of the cart-horse should not be high; the fore-hand broad and roomy; the carcass well let down (in which respect he should to a certain extent differ from the nearly or quite thorough-bred horse of any great speed, and who is formed more after the model of the greyhound); and the hind-quarters short, wide, and particularly well clothed with muscle from the hip to the hock. The length of the hind-quarter in the well-bred horse confers upon him the advantage of a great stride; but as, in the cart-horse, we look more to power than very quick action, the quarters from the hip-bone to the point below the insertion of the tail should be somewhat short in proportion to those of the hunter, short muscles being the most powerful. In most other important respects, as in the width and formation of the loins, the strength and closeness of the joints, the soundness of the feet, &c. &c., the good points of a well-formed cart-horse should correspond with those of the better-bred animal, with the exception of such as are merely indicative of breed, as the fine ear, the tapering head, the dilating nostril, &c.

The farmer who is really desirous of improving his breed of cart-horses should never breed from any mare before the age of five years. With proper food and care she will then have arrived at maturity, and be possessed of sufficient vigour of constitution to enable her frame to afford due nourishment for the proper growth of the fœtus; whereas if, as is frequently the case, she be put to the horse at a younger age, and while she is herself growing, the efforts of Nature being principally directed towards the development of the foal, will cease to be applied to the nourishment of the dam, whose frame consequently must suffer from this deprivation of those particles which, under different circumstances, would have been applied to the general increase of her growth. Even after birth a very young mare will still continue to be stunted in her proportions by a large portion of the chyle, or nutritious particles of her food, being contained in the milk which is sucked from her by the foal, and as the debilitating effects of gestation and parturition may prevent her from subsequently acquiring that bulk and stature which she would otherwise have possessed, her future progeny may possibly be thereby greatly deteriorated.

The age of the stallion should certainly not be less than seven or eight years; and the more compact his form, the more likely

will he be to beget a powerful and healthy progeny. Many farmers like to put their mares to the biggest stallions they can find, expecting thereby to breed large stock; and give preference to those horses that, besides being of enormous proportions naturally, are overloaded with fat. An animal in this pampered state is, however, by no means in the best condition for becoming the sire of thriving stock, fat being, to a certain extent, a sign of debility, and marking a weakness in the organs of assimilation. A horse, like a man, that is extremely fat is generally of a sluggish disposition, and incapable of great or continued exertion; and as the good or bad qualities of both sire and dam are constantly propagated to the offspring, it must be manifest that a horse bordering upon a state of disease cannot be in a fit state to propagate sound and healthy stock.

In breeding the cart-horse it is of great consequence that the temper and disposition of both stallion and mare be taken into consideration. Docility, willingness to work, with sufficient energy to keep up a constant and equal pull, but without exhibiting anything like absolute spirit, together with a hardy and thriving constitution, are qualities with which, if possible, both parents should be endowed. A team of steady-pulling draught-horses is invaluable to the farmer who has to contend with a heavy soil; and if he have on his farm horses of slighter make, and better bred, either for road-work or for the lighter portions of his land, the different sorts should never, when it can be avoided, be suffered to work together. Although sufficient attention is never paid to this point, yet there are few persons who may not frequently have observed one horse in a team of more spirit and courage than his fellows, that on starting a heavy load will fruitlessly strain himself to pieces for perhaps half a minute before his companions condescend to draw an ounce. If kept back and patted occasionally by the carter while at work, his labour is performed by jerks and sudden tugs, the rest of the team not being fast enough for him. Such a temper is by no means desirable in the true cart-horse.

The great difficulty of procuring either stallions or mares that have not some defect of form, or a tendency to some species of unsoundness, renders it a matter of great importance that the farmer should be able to detect at once any deviation from that formation which has been noticed as betokening superiority, and that his judgment upon all points connected with the structure and powers of the horse should be capable of remedying any deficiency of make on one side by corresponding excellence on the other. Defects of constitution, however, are less easily combated than those of form, and in the mare are continually operating as a bar to the proper growth of the fœtus. Thus a brood-mare

whose stomach and bowels are constitutionally weak, who is a shy feeder and constantly voids her dung in a sloppy and crude state, can never digest sufficient food to supply her own wants and those of the fœtus; and, in like manner, a mare with weakness of the respiratory organs can never possess or impart that vigour which necessarily results from the perfectly-formed secretions of the different organs of the body; the blood, which may be said to be the raw material from which the different secretions are formed, being imperfectly arterialized, or vivified, in its passage through the lungs, and consequently unfit to yield those particles which should be eliminated from it in its course through the body. Hence it is of great importance in breeding that the form, powers, and constitutional vigour of the mare should receive the greatest possible attention and consideration.

Few classes of men, provided they possess sufficient knowledge, judgment, and discrimination for the purposes of breeding, should be able to rear a better species of horse than farmers, and for this reason. In the large breeding establishments in this country brood-mares and stallions are kept solely for the purpose of procreation; and, from the moment a mare is supposed to have conceived, she is turned into a paddock until the foaling-time arrives, leading a lazy, indolent, unexciting existence, tired of the same scene, and with no other occupation than that of everlastingly filling her belly with grass. Hence she frequently becomes grossly fat (which, as I have already observed, is a state bordering upon disease); her stomach is seldom empty, of itself a cause sufficient to destroy its energy, and by consequence that of every other part of the frame; her muscles waste while fat accumulates, and she is altogether "out of condition;" by which expression I mean not in a fit state to undergo any fatigue. While leading this listless life every fibre of her body and every action of her secreting organs becomes relaxed and debilitated; and there cannot be a question that the formation of the fœtus under such circumstances will neither be as vigorous nor as active as would be the case were she kept to moderate work, fed at proper intervals, and excited and exhilarated by occupation and change of scene. The farmer's mare is generally kept to labour of some kind until within a few days of foaling; and, if not strained or over-worked, such a system must be beneficial to her health and to the due development of her foal. I have myself, on more occasions than one, seen a cart-mare at work within four-and-twenty hours of her foaling, without the slightest injury to her or her offspring.

During the period of gestation, and more especially after the time of quickening, which may perhaps be about the fourth month, the food of the mare should be of a hearty and nutritious

nature, and somewhat more than her usual allowance, provided she be able to digest a larger quantity than is commonly given to her. I shall not stop here to consider the subject of feeding, which will be duly noticed in another part of this paper. Should the mare drop her foal at a period of the year when pastures are bare and artificial grasses are not in season, she must have a plentiful allowance of good corn and hay, otherwise her offspring, whose chief nourishment is derived from the dam, will become weak, puny, and unthrifty; its coat will stare on end, while it will become pot-bellied and listless, evincing in every movement a want of that sprightliness and vigour which sufficient nourishment alone can impart. With the exception of those men who are extremely careless and unobservant, there are not many farmers who do not take proper care of a draught-mare after foaling; as they are generally put to the horse at such a time as to ensure their dropping the foal at a period when grass, tares, lucerne, &c. are plenty; but there are at the same time not many who understand that on the keep and condition of the mare during gestation materially depend the growth and vigour of the newly-dropped foal.

A short time before a mare is expected to foal she should be placed in a loose box or shed, plentifully littered with straw, and carefully watched in order that proper assistance may be rendered to her in the event of her requiring it. A warm mash, or a pailful of warm gruel, should afterwards be given to her, and for a day or two she should be left to recover from the effects of parturition, and be but little annoyed by visitors. She may then, if the weather be fine, be turned into a small meadow alone with her foal, until the latter acquire strength sufficient to follow her, when they may be removed to pasture of greater extent, if requisite. During the first period of suckling it is important that the mare be kept perfectly quiet and away from other horses, as she is frequently at first extremely irritable, running at and biting any animal that approaches her foal; and the constant excitement produced by the approach of other animals deteriorates both the quality and quantity of her milk. Moreover, a mare will often be horsing within a short time after foaling, and in this case the mock gallantry of her male companions will not fail to be injurious to her. It is not desirable at any period that her pasture be extremely luxuriant; a redundancy of grass, without the necessity of some exercise to obtain a due quantity of food, inducing grossness and plethora.

Six weeks after foaling, or perhaps a little earlier if absolutely needed, the draught mare may be put to gentle work, and if the foal be strong and vigorous it may be suffered to accompany her provided her labour be near home. The nearly or quite thorough-bred mare

cannot be used so soon after foaling, unless for the purpose of merely carrying the farmer over his ground, as all quick work would be likely to injure the secretion of milk, and should consequently be avoided. Gentle harness-work, however, of a light description will not hurt her, but she must not be coupled with slower horses, or allowed to do too much of the work herself. There is one great advantage gained by early accustoming broodmares to do a little work accompanied by their foals, which is that the latter very speedily become familiar with man, and are soon rendered docile and tractable by being constantly handled, and therefore seldom prove troublesome to break in.

With these few remarks I shall close the subject of breeding, and proceed to the consideration of the management and feeding of horses on a farm. Although well aware that there are many points connected with the propagation of the best species of horses of every breed, which might be dwelt upon at much greater length, the main object I have in view is not to fetter down the intelligent farmer by absolute rules, which cannot be applicable to every case, but to give him an insight into those points of the horse and those principles of breeding, a due attention to which cannot fail to ensure a proportionate degree of improvement in his stock. Before, however, I entirely dismiss the subject of breeding the horse for heavy draught, there is one point to which I should wish to draw attention, since I believe it is one which for some years past has tended not a little to reduce the superiority of our breed of cart-horses, and has moreover been lauded by some veterinary practitioners, receiving from them that degree of authority which sanctions the farmer in continuing a practice not altogether, in my opinion, to be recommended. I allude to crossing our breed of cart-mares with the cumbersome, ill-proportioned, and slow Flemish stallions that are yearly imported into this country, and the best of which may be seen perambulating the streets of London in the drays of certain brewers, who approve of their general appearance. I have many times noticed these horses, and can safely aver, not only that I never yet saw a really well-formed one, but that they are decidedly the very worst breed of draught-horses I ever beheld. I never yet saw one whose feet were not flat, and whose fore-legs, below the knee, were not of the worst description; the tendons at the back of the joint tied in, and the whole shank utterly disproportioned to the bulk of the horse. Indeed, there is scarcely one in twenty whose legs can do much more than support his unwieldy carcass, and were it not for the large crests and heavy necks of these horses,—points which some people imagine confer a stately appearance on them,—there would be very few imported into this country. However, as many farmers are induced to make use of the first showy-looking stallion that is

brought to them, I would warn them against putting any of their mares to these brutes. Few people can mistake the breed when they have once noticed it, and lest they should never have met with it, a Flemish stallion may be recognized by being mare-headed—heavy to excess in the neck and crest—flat-sided, and weak in the loins, quarters, and legs. With all these defects, or most of them, his long mane, his bulk (for he is prone to fatten), and his *tout ensemble*, coupled with a few flaunting ribbons about the head, and a gay bridle, do not fail to entrap the man who is unable to form a correct opinion of his principal points—the only true method of judging of a horse. We possess better cart-stallions than any other nation, but did we require a cross, I should say, from what I have seen, that the light Norman cart-stallion is an animal greatly to be preferred to the ponderous, inactive specimens that I have seen of the Flemish breed.

Now for the consideration of the management, feeding, and general treatment of horses on a farm.

If the mare from which a foal is bred be put to horse again a few weeks after foaling, she should not be allowed to suckle longer than five months. Provided she have conceived, she will then be about four months gone with foal, and as at that period the fœtus will probably have quickened, if she still continue to suckle her colt her frame will have to afford nourishment to herself, the foal at her foot, and the animal of which she is pregnant. The drain thus caused to the system is not only too great for the mare herself, but every drop of milk that her foal sucks from her will deprive the fœtus of a certain degree of nourishment. Her milk should therefore be dried up, by removing her foal and giving her a gentle dose of physic once or twice (such as half a pint of cold-drawn linseed oil and a couple of bran mashes), in order that those efforts of nature heretofore directed to the supply of the lacteal vessels may be more completely concentrated upon the development of the fœtus.

The young colt or filly, when first taken from the dam, should, if possible, be turned out with one or two other young horses, in order that it may the sooner forget its loss. A large piece of pasture, where such is to be had, should be selected for it, and as the autumn will be approaching, the grasses will neither be so succulent nor so luxuriant as to afford too abundant feed without the trouble of seeking for it. Thus a certain degree of exercise must be taken by the young animal while seeking its food, and exercise is the fountain of health and vigour. Few things, indeed, are more detrimental to horses, either young or old, but particularly to the former, than deep pastures that contain a superabundance of grass. Here the horse, if greedy, fills his stomach to repletion without the slightest exertion, and then lies down to recover from the effects

of his gluttony. When his meal is perhaps half digested he begins to feed anew, and loading his stomach at night, when he requires most rest, lies down when the dews of evening are falling, and the dank mist, particularly in low meadows, is covering the ground, and which in a short period completely envelopes him. During digestion the stomach and upper portion of the bowels receive a much greater proportion of blood than at other periods, and as the same quantity is circulating through the body generally, the skin at this particular time is less fully supplied than at others, and it is just at this moment that the damp fog of an autumnal night produces constriction of the cutaneous vessels, and compels the greater portion of the blood that should circulate through them to take another course. Hence arise, first, congestion, and, secondly, inflammation of some internal organ, either acute or chronic, according to the state of the system and the activity of the cause producing it. One horse, either from hereditary predisposition or some other exciting cause, may have weak bowels, and inflammation speedily attacks them; the organs of respiration in another may be weak, and sore throat, or inflammation of the lungs, or of the pleura, is the consequence, possibly terminating in broken wind, chronic cough, or roaring, the latter from constriction of the wind-pipe, which is the natural effect of the thickening of the part consequent upon inflammatory action.

When horses, or indeed any other animals, are exposed to the depressing influence of cold while their stomachs are unduly distended with food, there is likewise another cause in operation which, in conjunction with chilliness of the surface of the body, tends to induce congestion of one or more internal organs. It is this:—The stomach lies in contact with a large muscle, termed the diaphragm, or midriff, which separates the cavity of the chest from that of the abdomen, and consequently, when much distended, not only pushes this muscle towards the thorax, but likewise in a great measure impedes that natural motion by which at every inspiration it enlarges the cavity of the chest. The form of the diaphragm is that of a vault, whose upper portion is in contact with the chest, and the expansion of the ribs, on air being inhaled, by drawing its edges outwards, tends, to a certain extent, to draw down the superior part of the arch and to reduce it to a more plain surface. This action must necessarily increase the dimensions of the chest, and is one of the means by which a vacuum is formed in the lungs, which become immediately filled by atmospheric air. Now, as the chest contains the heart and lungs, it must be manifest that repletion of the stomach, by cramping the motions of the diaphragm, and thereby diminishing the area of the chest, must impede their natural and healthy functions, and thus not only is the blood, by its languid circulation through the former,

imperfectly, or but slowly, arterialized (as I shall hereafter explain), but the heart, in some measure overpowered and weakened by the quantity of its contents, is unable to combat successfully with the resistance offered to its action, and contracting but feebly cannot propel the blood with sufficient power through every part of the frame. Those parts most remote from it are of course those which primarily suffer the most, and hence the circulation through the cutaneous vessels is first rendered sluggish and imperfect by over-distention of the stomach, and is subsequently still further enfeebled by the action of a cold and moist atmosphere. From these causes, when frequently repeated, may very readily be induced a morbid state of one or more parts of the body, slowly but surely assuming the form of chronic disease, and possibly resulting in a disorganized state of some internal organ which no future attention or skill can remedy or much improve. The diseases to which the horse, while at grass, is most obnoxious are very generally confined to the respiratory organs, and if turned out at an improper season of the year, or when imperfectly prepared for the sudden change from a warm stable to the open air, he will very frequently, when taken up, be found to be a roarer or to have chronic cough, or some other disease of the lungs, which will render him of little value. Many horses, too, of a greedy disposition, when turned into deep, succulent, and luxuriant pastures, are subject to congestion of the brain, causing the disease termed "staggers," which in some instances superinduces actual inflammation of the organ affected, and is then named "mad staggers." This malady, to which many horses that are prone to become fat and pury are extremely liable, is in some measure accelerated by the position of the head while grazing, in addition to the plethora occasioned by over-feeding. A minor species of staggers, known as "megrims," if not the actual disease itself, may also be at any time brought on by improper and too high feeding in the stable, if continued for any length of time; but there the horse being constantly under the eye of the master, such a state can only be induced by persistence in a system of bad management, which is the offspring of ignorance or inattention.

From the time the young colt is taken from the dam, if the season of the year be propitious, he should be turned into a large piece of sound, dry, upland pasture, where, to obtain his living, he will have to take considerable exercise, by which his growth, vigour, and stamina will be materially accelerated and improved; and should the grass be insufficient either in quantity or quality to afford a proper degree of nourishment, one or two quarters of old oats, weighing at least forty pounds to the bushel, should be allowed him daily. The farmer, who seeks to rear a first-rate species of young horse of any breed, cannot be too deeply impressed with the



conviction that a sufficiency of good and nutritious food throughout every season of the year is absolutely essential to obtain this end. The idea of suffering young stock of any kind to shift for themselves throughout the winter, and merely to subsist upon straw and a little hay, under the supposition that the flesh they pick up in the summer will compensate for the previous stint they have endured, is absolutely preposterous, and however good they may turn out when full grown, there can be no question that with more nutriment they would have been better. With respect to horses, let the farmer scan carefully the proportions of our racers at three years old, and then ask himself by what means such a development of their frames and muscular powers has been brought about. If he suppose that they have not had corn from the age at which they were able to eat it, he deceives himself egregiously, and if he wish to rear similar stock, he may be assured that a liberal allowance of good food is, in one particular and a most important one, the principal means to attain his object.

At the age of two years, or a little more, the young colt should be handled and accustomed to the control of man. For this purpose it is a good plan to make him wear a headstall while at grass, by which he may the more easily be caught and held while he is patted and caressed, has his feet raised, is gently rubbed with a whip of soft hay, and in other respects habituated to the man who looks after him. On no occasion should he be in the slightest degree frightened or coerced, such treatment being the surest way to spoil his temper or render him timid or fractious. The man who has the care of him should therefore be of a kind disposition, well accustomed to the charge of horses, and one whose temper is not easily ruffled. The first lesson a young colt should receive should be simply that of suffering himself to be led about with a long rein attached to the headstall, so that, if at all ungovernable, or given to start at different objects, he may have plenty of room to throw himself about, which can never be the case when led by a halter, to which the man who leads him is obliged to hang when he shows temper or fright, in order to prevent his escape. After a few days he may gradually be taught some of his paces by being lounged in a circle with great care and gentleness, being ever and anon coaxed and patted, so that he may acquire confidence in his master. The object at this period being more to accustom the young colt to obedience than absolutely to break him in, his lessons should never be very long nor at all fatiguing; and when he is once rendered thoroughly docile, he may be again turned out, and occasionally taken up for a few hours during the day for the purpose of repeating his lessons, lest he should forget what he has learned, and become wild and ungovernable. At three years old the business of breaking-in should commence in good earnest,

and he should then be accustomed to the dumb-jockey, and be otherwise thoroughly taught his paces in the usual way, upon which it is unnecessary here to dilate. There is, however, one practice common to all horse-breakers to which I shall advert as being both cruel and unnecessary. It is that of tightly reining up the head of a young colt to the dumb-jockey, and in this state turning him into a loose box for many hours during the day. This is by these gentry facetiously termed "giving the horse a good mouth," but in my opinion, it has a directly opposite tendency; a good mouth and a good bearing being best acquired by the able handling of a judicious horseman. During the process of breaking-in a young horse intended for the field, he should be constantly led over small jumps and blind ditches, not too wide, in order that he may be gradually habituated to every species of fence, and rendered confident in his own powers—a practice that will subsequently save him and his rider from many a fall. At four years of age, or probably sooner, if he be of good shape and promising appearance, and his action be clean and good, the farmer will find that there is no lack of purchasers who will be glad to buy him at such a price as will certainly leave a good profit, after deducting all expenses of breeding and rearing, and possibly a smart sum by way of remunerating the judgment displayed in breeding him.

The above remarks apply principally to the hunter. The cart-horse will not require to be lounged or handled with such precautions; but at the age of two years and a half, being generally of a docile and quiet nature, he may be made to do a little work on the farm, more for the purpose, however, of accustoming him to his subsequent duties than for that of exacting from him any great degree of labour, for which he will clearly be unfitted. Almost the first lessons received by the cart-horse, after he has been used to bear his harness, and to allow it to be put on and taken off quietly, may be given in the team, where he should be placed between two steady horses, and never urged to draw an ounce except of his own accord. Should he be restive or given to kick, he may be harnessed by himself to a light log of wood, with long traces attached, that he may have plenty of room for the exercise of his heels without the chance of doing himself injury, and led gently about, care being taken not to force him to do much work, and to coax rather than compel him to it.

A medium plan must be adopted with the carriage-horse. He is not only required to have somewhat showy action, but likewise to be steady in draught. He must, therefore, be lounged like the hunter, and taught to raise his knee and deliver his leg with freedom; motions which can never be acquired without the good exercise of the hands and legs of a perfect horseman. Previous to being made to draw, it is a good practice to drive such horses

with long reins, but unattached to any vehicle, the man who drives them running behind, and being furnished with a whip to keep them up to the proper pace. By this means, being guided in every direction, made to turn, back, &c., they will, when harnessed, be much less raw and unhandy than when simply broken in to draw by ploughing and harrowing, to which work they may be put upon light soils when about three years old. And here let me remark that, if the farmer exact but gentle work from his young stock, and can manage to employ them upon soft ground, the longer he can avoid having them shod the better; shoeing at an early age being the bane of young horses, and frequently crippling their feet so as to render them almost worthless.

Many people have an idea that the hoof of the horse, from its apparent strength and solidity, is a part incapable of motion, and are totally unaware of the internal structure of the foot and of the change of position which its component parts undergo when a horse is in action. I shall not here dilate upon the different substances, as bones, ligaments, &c. &c., of which the internal parts of the horse's foot are composed, and which may be found elaborately described in many treatises upon the horse, but shall simply content myself with noticing the fact that, during progression, the foot of the horse, in its natural state, when unfettered by any shoe, not only expands laterally at the quarters and heel, but likewise that the sole of the hoof, which in the sound and healthy state is concave, causes this expansion by being pressed downwards and somewhat flattened by the weight of the animal being thrown upon the coffin-bone, which lies within the hoof. This lateral expansion being necessary to admit of the natural action of the different parts contained within the crust of the foot, and likewise of their growth while the horse is young, must to a certain extent be cramped and confined by the application of a shoe at any time, and more particularly at an early age, when it not only restricts the functions, but also the proper development of the foot.

The part immediately under the horny sole is a soft body, called "the sensitive sole," and the frog of the foot likewise covers a substance of a similar nature. Were the external portions of the horse's foot therefore totally incapable of motion it is manifest that the weight of the body, when thrown upon the foot, would bruise the internal parts by compressing them against a hard and unyielding substance, and by so doing would speedily cause inflammation and lameness; a result which very frequently occurs from continued bad shoeing, by which the motions of the more expansile portions of the foot, the quarters and heel, are improperly restricted. Hence also the reason why horses with flat feet are to a certain extent unsound; the sole being incapable of being pushed downwards by the

descent of the coffin-bone, when the weight of the body is thrown upon the foot, without coming in contact, or very nearly so, with the ground, and thereby giving to it a convex surface by which the due expansion of the foot cannot be obtained. Being on the subject of the foot, I may as well remark in this place that for the purpose of restraining as little as possible the motions of the sole, heel, and quarters, the nails of the shoe should be as few in number as are consistent with keeping it in its proper situation, and should always be driven as far from the heel as possible, in order that the expansion of that important part may be restricted to the least possible extent; and inasmuch as the inner quarter is weaker and more pliable than the outer, the shoe on that side should be held by one nail less than on the other, in order that its motion during progression may be free and unfettered. It is likewise most important that the sole of the foot be occasionally pared down until it will bend somewhat under strong pressure of the thumb; for without this care it will in a few weeks become thickened and inelastic from the constant growth of the horn, and consequently incapable of yielding sufficiently to the pressure from above, from which state the internal soft parts will not fail to suffer to a certain extent, enduring, as they must, constant concussion from the hard substance of the coffin-bone pressing them against the inelastic sole. These precautions with respect to the feet, which are some among many others equally necessary to their preservation, are always to be sedulously attended to from the first moment the young horse is made to wear shoes. While at grass, and unshod, the natural wear and tear of the feet will generally prevent any undue or redundant growth of horn; but in the stable there are few more vicious species of economy than putting heavy and long-lasting shoes upon any horse, especially if he be valuable, as in no instance should they be left upon the feet more than three weeks without being removed, and the sole pared to a proper consistence. The space between the bars and the frog, which is naturally filled up by a substance whose function is to keep up a proper degree of expansion of the heel, should on no account be pared away—a practice common to all country blacksmiths, and which they erroneously term “opening the heels,” but which in reality lays the foundation of their gradual contraction. For further information upon the important subject of the feet, upon whose perfectly sound and healthy state mainly depends the action of the horse, I must refer the farmer who desires to be made acquainted with their natural structure and functions to those veterinary works which have received the stamp of public approbation, my present object being merely to warn him against destroying, or if possible limiting, those motions which Nature has assigned to them, and which, when once lost, are seldom if ever regained. For the

purpose of preserving as long as possible the pliable state of the hoofs, and preventing them from cracking, they should be brushed over every second or third day with a mixture of equal weights of tar and tallow melted together, and the soles should be stopped every night with soft cow-dung, which should be picked out when dry. Farm-servants will never pay this attention to their horses without the superintendence of the master, and it is very rarely that a cart-horse has his feet cleaned, except when he goes to be shod. With him the stopping of the feet is not a matter in general of such importance as with the hunter or road-horse, as nineteen stables out of twenty that are allotted to the teams are neither very frequently nor very sedulously cleaned out, and the horses are therefore at most times standing upon wet litter of some kind, which serves to keep the feet moist. This, however, is an erroneous system of management, as I shall presently explain, and is frequently a fruitful source of disease among horses, the amount of litter converted into manure by being suffered to remain long in the stable in no wise compensating for the injurious effects produced by the effluvia arising from it. A reformation in this system of neglect would no doubt tend to the advantage of the farmer in the long run, but, except in some instances, is scarcely to be expected, both from the disinclination of carters to take what they consider unnecessary care of their teams, and from the habit that farmers in general have acquired of giving themselves as little trouble with respect to them as may be.

From the age of three to four years the cart and carriage colts bred upon a farm may generally do most of the light work of the farmer's business, care being taken that the latter, as they approach the period when they are to be sent to some horse-fair for sale, be neither worked too hard nor allowed from any other cause to fall off in condition. The large breeder of horses will find his advantage in procuring, if possible, a man to look after them who has been accustomed in some measure to the craft of a dealer's stable. Such a man will well know the usual means adopted for improving the appearance of the animals entrusted to him, by trimming, singeing, pulling the manes and tails, &c.; and the extra expense, if any, of his wages will generally be compensated by the additional sum which a horse properly prepared for the eye of the dealer will generally bring.

I shall now proceed to notice those points of stable management, from the period when the young horse is first permanently taken up from grass, which are essentially necessary to his health and well-being, and explain in as familiar a manner as I am able those physiological facts upon which they should be based, a want of attention to and knowledge of which may frequently retard improvement, if not actually engender disease.

It must be remembered that a young animal of any kind that has been accustomed for the greater portion of his existence to live in the open air and to breathe a pure atmosphere, taking daily a sufficiency of exercise to keep him in good health and vigour, must of necessity experience an extraordinary change in his state and habits when first confined to the stable. For this reason, when first taken up from grass, he need not for a few days be confined to his stall, but suffered to roam about a yard where there are one or more loose sheds under which he may shelter himself from the sun and rain, and only stabled at night, when he will wish to rest. While kept in this manner he should be fed on soft bran mashes and hay, the former of which will frequently be sufficient to rid his bowels of any rubbish he may have picked up at grass, without which operation he will not subsequently thrive upon hard meat. If physic be necessary prior to feeding him with corn, the dose must be carefully apportioned to his age, form, and constitution—a close, round-barreled horse being generally better able to bear the operation of purgatives than one of narrower and lengthier formation. All proper precautions being taken to put him in a fit condition for thriving upon the diet that will subsequently be allotted him, he should be allowed corn in proportion to his size, hardiness, and work. Most people are in the habit of feeding their horses by measure with respect to oats and beans, which, without knowing their weight, is a most absurd practice. A growing young horse, if he be put to a moderate share of work from the age of three to four years, should not certainly have less than three quarters of oats per diem, and if he be large and thriving, will probably require four; and they should never weigh less than forty pounds to the bushel, which will be a daily allowance of from eight to ten pounds: if they be heavier, a smaller proportion may be given, according to their weight. The heavier the oat the greater will be the quantity of nourishment contained within a small compass—a matter of considerable consequence to the horse, which, of all animals, possesses the smallest stomach in proportion to his size. To this allowance of corn may be added from eight to twelve pounds of hay daily, or from a truss to a truss and a half per week: if the farmer be a careful man, and wish to save his expenditure of oats and hay, he will find that a smaller quantity will suffice while but little labour is required from his young horses, if he take care to have a good supply of carrots (which, when mixed with bran, are excellent food), or of Swede turnips, which are still more nutritious, although generally not so well liked by horses.

The quantity and quality of food allotted to any horse should in all cases be sufficient to keep him in a thriving condition,

especially while growing, for stint in the article of food is quite as bad as giving too much with a view to urge Nature to her greatest exertions—a species of mismanagement to which I shall presently advert, and which is frequently the foundation of many dangerous inflammatory diseases. In most farm stables that I have ever seen, no attention whatever seems to be paid to the quantity of hay allowed to each horse, but the carters are allowed to take as much from the rick-yard as they please, and to give it to their teams *ad libitum*. The least trouble being to fill the racks as full as they can stuff them, they are consequently generally crammed with hay to their fullest extent, so as to be ready for the horses at any and every period of the day at which they may reach their stable. A great quantity is of course pulled down, or blown upon, and comparatively wasted, which is the only species of damage that ever strikes the farmer as occurring from this system, as he never takes into consideration, or possibly understands, that a constant supply of food cannot fail to deteriorate the good condition of his horses, and, instead of strengthening, only tends to enfeeble them.

I shall now explain the reason why a superabundance of food is injurious instead of beneficial to the horse. Unlike those animals that are destined for the butcher, we do not wish him to become extremely fat, but rather desire to keep him in that state which is termed “condition,” and which implies the possession of the greatest possible health and vigour, coupled with a certain acquisition of flesh, or muscle, but not of fat, except to such an extent as will preserve the roundness of the different parts of the body and conduce to beauty of appearance, which the horse intended for sale should possess to the greatest extent that his form is capable of attaining. The ox, the sheep, and the hog—animals that are fattened for the purpose of being converted into food, acquire, both from feeding to repletion and from the enjoyment of perfect repose, a certain weight within a given time, but cannot be considered during the process of fattening in a healthy condition, the circulation of the blood being sluggish, and their nervous energy almost extinct, from the torpor produced from eating to excess. How is this torpor induced? I have already shown that the stomach, when extremely full, by pressing upon the diaphragm diminishes the area of the chest, thus offering an impediment both to respiration and to the circulation of the blood through the lungs and heart, which actions are in fact dependent one upon the other, respiration being more frequent in proportion as the circulation is more hurried, a familiar example of which may be noticed in the panting of any animal after severe exertion.

Now in order that any animal should continue to exist, it is necessary that the blood in its passage through some portion of

the body should be exposed to the action of the atmospheric air, by which a chemical change is effected, turning the venous or dark-coloured blood into arterial or florid blood, which alone is capable of carrying on life and supplying the different organs of the body with the stimulus necessary to their different actions. This change is effected in the lungs, where the blood is exposed to the operation of the air that is inhaled into them, and which fills the air-cells, in the delicate membrane of which the blood circulates. The arterial blood, in its transit through all parts of the body, is deprived of those vital properties which it has acquired from contact with the atmosphere, and becomes venous blood again, until it is once more propelled through the lungs and again arterialized. Venous blood contains a great quantity of carbon, and when from any cause (as, for instance, from the inhalation of charcoal) the chemical change in the blood so necessary to life does not take place, is found incapable of sustaining life, even for a very short period. Its first effects are upon the brain, which being deprived of the usual stimulus of arterial blood, becomes torpid, and thus the fountain-head of sensation being destroyed, voluntary motion is lost, the animal drops, and if not speedily relieved will die.

If such be the effects of venous blood alone circulating for a very short time through the brain, we may very readily imagine that they will be perceptible in a minor degree when any circumstance tends to limit the supply of arterial blood to that organ. As the loaded stomach, by impeding the action of the heart, deprives it of the power of propelling the blood with sufficient velocity and power through the various textures of the body, the circulation during repletion must be more languid than at other times; among other organs the lungs, therefore, become gorged with blood, which passing but sluggishly through their substance, offer within a given period a less quantity than usual to the action of the atmospheric air, and consequently the slower the circulation the more the supply of fresh arterial blood to every part is diminished. Hence it will not be difficult to conceive that the brain, while an animal is suffering from distension of the stomach, being but moderately supplied with fresh arterial blood, is comparatively less energetic than at other times, its power of infusing vigour into the system and of rendering it capable of sustaining exertion of any kind is diminished, and the natural consequence is that state of torpor, lethargy, or somnolence to which repletion seldom fails to give rise; and this state being found favourable to the deposition of fat between the various textures of the body, animals intended for the butcher are constantly supplied with a large quantity of food in order that the inactive brain may rather conduce to repose than to exertion.



In so unnatural a state as this no man would of course ever think of keeping any horse; but I have given the extreme example of the effects of over-feeding in one particular, in order that the farmer may comprehend one of the results of an undue allowance of food, and be made to understand how important is the one item of diet to the maintenance of the vigour and tone of every fibre of the body, and how nervous energy—the mainspring of power—may be sapped and destroyed by persistence in a wrong system of feeding.

There is yet another result of repletion which in the long run cannot fail to ruin the health of any animal; and there is no question that every beast that attains any great degree of obesity can never be considered in a healthy condition, and probably is in a state bordering upon disease, if the organization of one or more parts of the body be not already morbidly affected. The result to which I allude is irritation of the stomach and bowels, which, operating sympathetically upon the whole system, reduces the tone of every organ, vitiates the secretions, and renders the animal listless and inactive, a condition which of course it is our interest to avoid or remedy by every means in our power when occurring in those animals, as the horse and the dog, upon whose exertions depend our profit or amusement, and whose flesh is of no value as food for man.

There are two agents that operate simultaneously in the production of irritation of the alimentary canal. The first of these is distension, which, often repeated, never fails to superinduce debility; and the second is putrefaction. The stomach secretes a fluid called the gastric juice, whose properties are highly antiseptic, and which, by being intimately blended with the food, renders it capable of resisting the effects of decomposition, or putrefaction. So long as an animal experiences the sensation of hunger, this fluid is poured out from the coats of the stomach in sufficient quantity to saturate the aliment that is swallowed; but that feeling once appeased, the secretion of the gastric juice either ceases entirely, or its properties are so altered and weakened as to be no longer capable of offering due resistance to the putrefactive process. Thus, beyond a certain quantity, every mouthful of food, placed as it must be in the situation most likely to favour decomposition—namely, one of warmth and moisture—speedily becomes a putrid mass, evolving a large quantity of noisome gas—as does every animal or vegetable substance in this state—by which distension is increased and acidity and irritation produced. The primary effects of continued repletion are generally costiveness, from the retention of a great quantity of fecal matter in the large intestines, and occasional diarrhœa, from irritation of the mucous membrane which lines the alimentary

canal. To enumerate the secondary effects which may occur from the same cause would be to present a catalogue of perhaps all the chronic and many of the inflammatory diseases to which any animal is subject. According to hereditary or acquired disposition of any organ to disease, so will it become obnoxious to morbid changes from a long-continued habit of over-feeding; and thus in one the eyes, in another the brain, in a third the liver or lungs, and in a fourth the stomach and intestines may be affected from this cause alone. To this fact may be objected the daily examples of animals of every breed that are rendered extremely fat, and still not to all appearance diseased, by a very large allowance of food; but it must be remembered that the stomach is capable, like every other part of the body, of continuing undue exertion for perhaps a considerable time before those morbid results to which I have alluded become manifest, and almost all animals destined for food are killed so soon as they have acquired that degree of fatness which they are capable of attaining, without being kept long enough to give time for any organ to become attacked by actual disease. At all events, this is the case with most of those animals that furnish us with food, although some certainly do die while undergoing the fattening process, and many are probably when killed either actually the subjects of disease which the butcher's knowledge of morbid appearances is either unable to detect, or, if sufficiently manifest to him, it is his interest to conceal.

The natural action of the stomach in preparing the food for digestion being understood, it becomes our duty so to apportion the horse's aliment that no part of it be destitute of the gastric-juice, without the aid of which it must become a source of irritation; and inasmuch as the deposition of fat is productive of inactivity, no greater quantity of food should ever be allowed him than he is capable of well digesting, and than is sufficient to maintain his strength and increase his proportions while growing. The stomach, like all other parts of the body, cannot be everlastingly at work; it requires repose at intervals in order to perform its natural functions with energy, and on this account it is highly improper, and destructive of health, to allow the horse access to food of some sort or other at all hours of the day, especially while in his stable, where exercise is unnecessary to obtain his food. For this reason no greater portion should ever be placed before him than he seems to have a desire for, whether it be hay or corn; and an interval of four hours should always be allowed to elapse between each meal. Less time than this is insufficient for digestion; and if food be taken into the stomach while it is employed in preparing a former meal for undergoing that process, it must be clear to every one either that its powers must be over-

taxed by producing a fresh supply of the gastric juice, or that the second meal will pass into the intestines without having been saturated by that fluid.

As I have already remarked, the carter, totally ignorant of the natural laws by which digestion is regulated, thinks that the more his horses eat the more fit for work will they become; and if their allowance of corn and beans be daily meted out to them by the farmer himself, takes care that, at all events, they shall never want for a plentiful supply of hay, with which he never fails to cram the racks. Independent of the waste thus committed, I have already shown the bad effects of allowing this system to be pursued for any length of time, and need not therefore advert to it again. The power and activity of many a team is often diminished through want of supervision by the farmer in the article of diet, and more work might be got out of his horses, besides effecting a great saving of food, did he take as much pains to regulate their allowance of hay or green meat as he does of oats and beans. The smallness of a horse's stomach also in comparison to his bulk renders the allowance of a large quantity of hay doubly injurious, inasmuch as a great deal of it must be swallowed before nutriment equivalent to a feed of corn can be extracted from it, and the distension of the stomach thus produced is, as has been already observed, destructive of its power, and eventually of course produces corresponding debility of the whole system.

The plan of giving a large quantity of cut chaff to horses with their corn may be equally productive of mischief, unless care be taken to ascertain the appetite and powers of digestion of each animal; and the system of giving the whole of the food as manger-meat, under the impression that the horse will lie down and rest so soon as he has finished his meal, is in many cases liable to the objection that, even when satisfied, he will continue to eat for the purpose of getting the corn that is mixed with his food, and will then probably only lie down immediately from the feeling of oppression induced by repletion. When corn, beans and chaff, in proper quantity and proportions, are given without the admixture of cut hay, if a horse have had enough he will, unless a glutton, lie down perhaps at once, or will pull a small portion of hay from the rack before he does so, but will never leave the food that contains corn until he have eaten more than is good for him and he loathe the remainder.

The next important point to be attended to in the treatment of the horse is to ensure for him at all times and in all situations an abundant supply of fresh and uncontaminated air. Cleanliness in the stable is therefore a point to be strictly attended to on every occasion, and one to which for the most part the farmer is

lamentably inattentive. There is scarcely one farm-stable in fifty that is properly and thoroughly cleaned out even once every week, and the accumulation of dung, urine, and frequently green meat of various kinds, in different stages of decomposition, are hourly exercising their baneful influence upon the blood of every horse that is allowed to breathe an atmosphere thus loaded with noxious effluvia. The operation of pure atmospheric air upon the blood in its passage through the lungs has already been noticed, as likewise the fact that by this operation alone it is rendered capable of acquiring those properties by which healthy animal life is carried on. The purer the atmosphere in which any animal is kept, the more vigorously and the more healthily will every function of the different organs of the body be exercised, and consequently the inhalation of air impregnated with the stench of vegetable matter in a state of putrefaction, by corrupting the blood with which it comes in contact, vitiates every secretion of the body, and in time, if it cause not actual disease, which is most probable, never fails, at all events, to produce languor and debility. Independent too of the injury secondarily caused to every part of the frame by the influence of foul air upon the blood, the gases arising from dung, urine, &c., act prejudicially upon the eyes, a fact of which any person who will remain in a foul stable while it is being cleansed may practically assure himself.

There are but few farmers who will give themselves the trouble to exercise a proper degree of supervision over the malpractices of carters and ploughmen in the stable, more especially if it contain none but agricultural horses, and there are possibly still fewer who have any idea that at every inspiration a portion of the blood circulating through the body undergoes a change without which no animal could exist. Having become aware, however, of this fact, it is not only the duty but also the interest of every farmer personally to superintend the care of his horses, and to insist upon his stable being daily cleaned out; an operation which, if regularly performed, will in the end occasion far less trouble than when filth of every kind is allowed to accumulate for days, to say nothing of the beneficial effect of cleanliness upon the team. The breeder of valuable horses will no doubt be more alive to the necessity of attention to his young stock than the man who has an occasional colt or filly, the goodness of which he leaves pretty much to chance; but the principle of obtaining for every horse a due supply of fresh air, and of keeping him in an atmosphere unimpregnated with noxious vapours of any kind, is the same as far as regards the purposes of health, whether a horse be worth ten pounds or a hundred.

During the act of respiration one of the component parts of atmospheric air becomes destroyed by coming in contact with the

carbon of the blood; and hence the air that is expired from the lungs, if inhaled again without admixture with fresh air, is deficient in those particles which should effect that chemical change in the blood, so necessary to life, of which I have already spoken. For this reason closely-shut stables are highly injurious to horses, although the plan of stopping up every aperture at night and excluding the air is one which is very generally adopted by great numbers of people, alike ignorant of the injury they thus inflict upon their horses, and of the mode in which their superabundant and ill-directed care operates prejudicially upon animal life. Many men, while endeavouring to put valuable horses in condition prior to offering them for sale, are in the habit of thus coddling them up, with a view to improve the appearance of the coat, an advantage which is frequently not gained save at the risk of exciting inflammatory disease, and always with the loss of some portion of that sprightliness of movement and general vivacity so indicative of health and vigour. The true method of improving the condition of every horse consists in giving him regular exercise proportioned to his strength; allowing him such a quantity of wholesome and nutritious food as he is capable of perfectly digesting, and of paying such attention to him in the stable by good grooming, sufficient clothing to keep up the circulation in the skin, if he require it, and a proper supply of uncontaminated air at all times and in all seasons. There are very many minor points respecting condition to which I shall forbear any allusion, inasmuch as the word in its strict sense implies the highest degree of health and muscular power which any horse is capable of acquiring, and which can only be obtained by a system of training to which no young horse, merely bred for profit, need be subjected, as he will probably sell for more money when in somewhat high condition than when trained down to mere muscle and sinew.

From some of the above observations it is almost unnecessary to observe that to keep horses in good health air should not only be freely admitted at all times into the stable, in quantity according to the season, but there should likewise be some internal aperture by means of which the air may be made to circulate and perfect ventilation be ensured.

It may be expected that, before I conclude this paper, I should say something respecting the profit attached to breeding the various sorts of horses of which I have taken notice. This is a point of some difficulty, inasmuch as the breeder has many risks to run in rearing his young stock, and may also breed several colts before he succeeds in obtaining one which shall sell for a very high price. Nevertheless, I shall essay something like a tolerable calculation of the average value of the cart and carriage

horse and of the hunter, after deducting the necessary expenses the farmer will incur in rearing them and making them fit for the horse-fair; and shall then consider, as far as I am able, which of these different breeds is most likely to yield the farmer the greatest profit in the long run.

To begin with the cart-horse. Excepting in those districts where very large and showy-looking cart-horses are bred for the brewers, distillers, and others in London, a cart-colt, when four years old, must be a very good-looking animal to fetch 40*l.* at a fair; but supposing the breeder to be a man of sound discernment and knowledge in horseflesh, and to be successful in the sort of mare and stallion he selects to breed from, I am still making a computation somewhat in his favour when I value the four-year-old colt at this price. As he will not be fit to do anything like work before he is three years old, we will suppose that after that period he shall earn his keep, and will proceed to make a calculation of his expenses up to that age. They will be somewhat upon the following scale:—

	£	s.	d.
Stallion . . . . .	2	2	0
Keep of mare (say for one month) prior to and after foaling . . . . .	0	14	0
Keep of colt at grass and straw-yard at 3 <i>s.</i> per week after the first six months . . . . .	19	10	0
Allowance for corn during three months, while being broken-in (two quarters per diem) . . . . .	1	16	0
Mau's wages for breaking . . . . .	0	8	0
	<hr/>		
	24	10	0
	<hr/>		

As the calculation I am making is on a rough scale, I do not take into account the blacksmith's expenses, if any, from two years and a half to three years old; the wear and tear of harness, and other trifling sums, for which I shall presume that the little assistance a very young colt can be of in the team will be sufficient payment. I have likewise considered that the cart-colt is easily broken, and have therefore simply charged to his account the wages of a man for a few days while receiving his first lessons; and if I add to these sums the expenses of a horse-fair, and the extra quantity of food necessary to put the colt in good case prior to sending him there, I shall not be estimating his expenses at too much, under all favourable circumstances, if I put them down at 26*l.*, which will leave a profit of 14*l.* at the expiration of four years. In this estimate I have likewise not made any allowance for corn at those periods of the year when green food is scarce, although, as I have already stated, the man who wishes to

rear a fine colt of any breed will never succeed in so doing by parsimonious means.

The expense of breeding and rearing fine carriage-colts must necessarily be greater than that of breeding for the team only, inasmuch as the stallion, in the first instance, will cost more; the colt must be allowed corn from an early age, or he will never attain the size and stature requisite for his work; and, moreover, he should not be broken-in before he be full three years old, and for some period after should only be put to the gentlest work. His expenses will probably stand thus:—

	£	s.	d.
Stallion . . . . .	3	3	0
Keep of mare for one month . . . . .	0	14	0
Do. of colt for two years and a half, with corn during six months of each year . . . . .	30	0	0
Breaking-in . . . . .	2	2	0
	35 19 0		
	35 19 0		

The additional care and attention that these animals will require; the expenses of clothing, wages, horse-fair, &c. &c., will, on a rough calculation, take at least 40*l.* out of the farmer's pocket at four years old; and at that age a handsome and powerful colt, fit for the London market, may fetch on an average about 60*l.*, although many of them do realize a much larger sum from the first-rate London dealers. To do so, however, they must not only be of a very good quality and have showy action, but must likewise be five years old, as they are not fit for town-work much before that age. The average profit, therefore, of a good carriage colt at four years old may be from 20*l.* to 25*l.*

The expense of breeding and rearing the hunter will be greater than that of either of the former breeds, from various causes. The cost of the stallion will be greater; he will probably never do any, or at all events very little harness-work; and must likewise, to fetch his full value, be kept until five years old, at least, before he is sold. Adding, therefore, two guineas, at the very lowest computation, for a stallion of character, and at least 20*l.* for keep from the age of four to five years, a hunter will not cost the farmer less than sixty guineas when fit for sale, and, independent of these expenses, the prime cost of the dam may have been considerable, and she may not be powerful enough to do much hard work upon the farm.

Now, at five years old a horse should have some character in the field as a hunter to realize the sum of 80*l.*, although, if he be a horse possessed of considerable speed and power, he may fetch a good deal more. The farmer consequently prefers keeping

him at all risks until five or six years old, with a chance of obtaining a hundred, or a hundred and twenty guineas for him, to selling him at four years old without a character, and only realizing half that sum.

To say the real truth, in most instances breeding hunters is something like buying tickets in a lottery, and is a business that requires the exercise of a far greater degree of thought and judgment than most people suppose, to be made profitable in the highest degree. Any man, with a fair knowledge of horses and tolerable discrimination, may breed a horse that, being taken out with hounds, may be called a hunter, and may be worth from 50*l.* to 60*l.*; but to breed an animal of superior qualifications—one that can live with a fast pack of hounds in some of our crack counties, and subsequently stand a good chance of carrying off one or more hunter-stakes at the end of the season—is a different matter altogether, and, excepting through sheer luck, is not to be done by the man ignorant of the most important points of the horse, and of the pedigree, performances, and general character of the first mares and stallions of the day.

Nevertheless, let me ask who is there who is not fond of a lottery-ticket, and where is the young farmer who objects to possess one in the shape of a hunter? If he chance to breed a good one, and be a bold rider in the field, since he will, no doubt, keep a horse of some kind for his own use, he may as well keep his colt from four years old till six as any other, and make a hunter of him, as, when perfect at his fences, he will find plenty of admirers in every hunting country.

This choice, however, it must be admitted, is matter of fancy. The plodding farmer, who breeds a hunter for which he has no use, sells him so soon as he can make a profit of 15*l.* or 20*l.* by him, whether he be three or four years old; whereas the young man, who does not make the most rigid calculations of expense, and who is, moreover, a sportsman, and perhaps fancies himself a bit of a jockey, keeps his horse from year to year, in the hope of at last obtaining for him a considerable sum, which it is not impossible that he may eventually do, but not certainly without incurring considerable risk.

The above calculations, I must remark, have been made under circumstances most favourable to the farmer; and I believe that, in the long run, were every item of the expenses of breeding and rearing horses taken into consideration, and placed against the average sums they realize, the balance would be but very little, if anything, in favour of the breeder.

When we consider the numerous diseases and accidents to which horses are subject, and that to pay a remunerating price they must at all events be sound, we cannot be surprised at the



losses that many men incur by breeding them, more especially as the greater proportion of farmers are ignorant of the principles of breeding, and are incapable of forming a correct judgment upon the most important points of the sire and dam they may select, both with regard to their formation and their blood.

The real fact, however, is this. A farmer breeds a colt, and at five years old the expense of rearing him may be 50*l.* But this sum not having come out of his pocket at once, but having gradually and insensibly melted away in the shape of grass, oat-straw, and now and then a few quarters of corn, it has not at any one particular time made any great inroad upon his pocket, and consequently, if he want to pay his rent, or to make any purchase which is likely to be beneficial to him, he takes perhaps 40*l.* for the colt that has cost him 50*l.*, and thinks himself both lucky to get that sum, and likewise a provident man, to have kept that by him that has been so valuable in a time of need.

Now close calculators, writing upon farming matters generally, would greatly blame the farmer for a yearly expenditure in grass, &c., which, in the aggregate, amounts to a greater sum than the animal on which it has been expended will eventually realize, and would proceed, no doubt, to demonstrate, most satisfactorily to themselves, that, had the same amount of food been applied to the fattening of a few sheep, and to keeping a cow, the mutton, butter, and milk would have returned a better profit than the horse. All this *may*, possibly, be true; but we must remember that a first-rate horse of any breed may put a large sum, by way of profit, into his owner's pocket; that most men are fond of horses, and will breed them when they have an opportunity of doing so; and that, with respect to the profit and loss, human nature is prone to disregard small outlays for any particular purpose, although when summed up they may amount to more than the object they have been lavished on be worth. Such being the feeling implanted in the nature of nine-tenths of the human race, when live stock of any kind thrive, provided the farmer can rub on without being obliged to sell them at an improper time, they may be looked upon in the light of a live savings-bank, in which he weekly hoards up a certain sum which, under different circumstances, he would probably think nothing of spending. Under this view, the breeding of horses may be considered advantageous to the farmer, even if his knowledge of the subject be but imperfect; but the man of judgment and science may render it a lucrative pursuit, without incurring a great deal of risk.

Of the three different breeds of horses of which I have made mention, I should say that, upon moderately light soils, the carriage-horse is by far the most likely to be useful and profit-

able to the farmer. If any accident happen to a fine carriage-colt, he is still fit for the work of the farm, unless greatly injured, an advantage that is not to be derived from the horse of better blood and smaller bone; and, if he do well, the sum he may realize from the London dealer may be quite equal to that brought by the hunter (unless he be a very superior animal), besides the gain derived from his being able to do some farm work, at least at an early age.

The profit derivable from the cart-colt must, on the average, in most cases, be moderate, and with respect to the hunter is a speculation, agreeable, perhaps, but doubtful. Considering the first expense of the mare, and the subsequent outlay of from five to ten guineas for a stallion of some repute, added to keep for one or two years, I would strenuously recommend those farmers who are within a moderate distance of the metropolis, who are good judges of a horse, and who wish to rear hunters, to buy them at the hammer at Tattersall's, at one or two years old, or even later, rather than breed them. In the latter case you cannot possibly tell what sort of foal your mare may throw, or whether some accident may not happen to her in foaling; whereas by buying colts when young, you may form a tolerably correct estimate of what sort of horses they will make, and save the breeding expenses into the bargain: young colts being frequently knocked down at the hammer for less money than they cost their owner on the day they were foaled.

I have now taken a cursory view of the principles on which the breeding of good horses should be based, and have likewise shown the best method of rearing them, in accordance with the laws of physiology. I might, it is true, have entered into a much more minute detail of the treatment and general management of the horse, but so many works upon this subject are extant, that it is unnecessary to do more than allude to them.\* There is one remark, however, which I will run the risk of repeating, as a warning to all breeders; and that is, never to be smitten with the general appearance of either a stallion or mare, if the more important points of the frame will not bear minute investigation. It is in vain that a horse possess a showy crest, or a well-carried tail, or have a general bearing that may captivate a novice; if his shoulders, carcass, quarters, joints, and feet be not well shiaped,

---

\* The reader curious in all that relates to horses may consult 'Percival's Hippo-pathology,' 'Youatt on the Horse,' 'Bracey Clarke on the Foot of the Horse,' 'Spooner on the same subject,' 'White's Veterinary Farriery,' and 'How to buy a Horse,' in which everything connected with the purchase, soundness, and improvement of the horse by stable-management is considered.

well proportioned, and sound, be assured he is not the animal likely to beget good stock, let his spirit and *tout ensemble* be what they may.

Lastly, the farmer desirous of breeding valuable hunters cannot be too intimately acquainted with the racing calendar and stud-book, which are the fountains of all knowledge relating to the propagation of our best breed of horses, a large proportion of whose blood must enter into the composition of the first-rate hunter of the present day.

The calculations of profit in breeding horses are liable to many deductions. Amongst cart-horse dealers mares are not in request for the higher markets; but in the carriage-horse trade they are *inadmissible*, nor will they as hunters command an equal price in the fair, whatever they may do in the field, and yet the chances as to sex may be considered equal. Next to sex in importance is colour, over which the breeder has no control. In carriage-horses it most materially affects price, and has a certain influence on every description of horse.

The author admits that his calculations are in the rough, and favourable to the breeder. The very moderate profits which even under these circumstances he holds out, would be greatly decreased if average provision were made for mares missing foal, accidents in foaling, expense and risk in castration, the unavoidable series of diseases to which young horses are subject, accidental blemishes, and above all, in carriage-colts, the galled shoulders, chafings, kicks, blows, &c., leaving blemishes to which those broken-in or worked in the farm teams are so invariably subject. The circumstance, also, that the spring fairs are usually those selected for the purchase of draught and carriage horses, entails a very increased expense in getting them into condition, beyond the summer and autumn fairs, when grass has for the most part sufficiently prepared them.

H. HANDLEY.

---



---

XXX.—*On the Cultivation of Flax.* By G. NICHOLLS, Esq.

I BEG permission to address the Council on a subject which I believe to be of great general interest, as well as one of especial importance to the agricultural classes—I mean the cultivation of flax.

In my little work, "The Farmer,"\* published in the spring of this year, I endeavoured to impress upon our English farmers the policy of their introducing flax crops as a regular portion of their system of management. I did this under a conviction of its great importance to them, as well as to the country generally. We all know, however, how difficult it is to establish a new practice, more especially if it requires previous forethought and arrangement, or if the benefits derivable from it be not very obvious and immediate; and I cannot hope that the recommendations contained in my little work will have had much effect, or that the

---

\* Published by Mr. Charles Knight in his series of 'Guides to Trade.'

cultivation of flax will be speedily adopted, if it be adopted at all by the great majority of our English farmers, without other efforts being made to promote it.

The cultivation of flax, although it holds out a prospect of considerable advantage to the farmer, and that neither doubtful nor very distant, is yet, like most things which are new, beset with certain difficulties at the outset. The preparation of the land and the sowing of the seed are not, however, of the number, for these are simple enough; but the gathering and management of the flax after it has grown to maturity, the steeping, drying, scutching, hackling, and preparing it for the market, all require some training and some skill in the persons who carry through these several operations; and the great difficulty will lie in obtaining the requisite degree of practical knowledge on these matters at first. Once established, the whole will be plain and easy; but it may at the outset be not unfrequently necessary to procure the assistance of persons from a distance, to give the needful instructions; and this would entail an expense which tenant-farmers would often not be disposed to encounter. In such cases it will be for the landlords to take the initiative, and to institute inquiries and make the requisite preliminary arrangements; and if landlords will do this, their tenants will readily follow and cooperate.

The advantages resulting from flax-cultivation are daily becoming more highly appreciated in Ireland, where the quantity grown has more than doubled within the last few years; and it is every year increasing, under the auspices of a Society instituted expressly for the purpose of encouraging its growth. In Holland and in Belgium, and in some of the Prussian states, flax is also extensively cultivated, there being hardly a farm, however small, on which flax is not grown, and it is held to be the most profitable of all their crops.

In addition to the profit which in a pecuniary sense would arise from the cultivation of flax in this country, another very important advantage would be obtained, for it would afford a large amount of employment, more especially for females, in those rural districts where employment is at present most needed. The various operations connected with the management of flax require many hands, and much of the work may be performed by females. If flax were generally grown, employment at once suitable and profitable would be found in its preparation for the female population of our villages and rural parishes, without resorting to common field-labour, as they are now too often compelled to do; and this would doubtless be a great benefit, socially and morally.

Our rural population is generally found to be most abundant, and

not unfrequently most in excess, in those districts where the farms are small; and it is to these districts that the cultivation of flax is more especially suited, and where it would confer the greatest benefit. The farms in Belgium are universally small, from 20 to 50 acres being about the average, but many are under 10 acres. In Ireland the holdings are likewise small; and in both countries the population is great in proportion to the area. In both countries likewise the cultivation of flax is found to be highly profitable, and to afford beneficial employment to the people.

I do not mean to discuss the comparative advantages and disadvantages of large and small farms; but I may venture to remark, that neither small farms exclusively, nor large farms exclusively, appear to me to be desirable, but rather an admixture of both. By such admixture, a gradation of employment is found for different degrees of farming skill and capital, and a stimulus to exertion is held out to the man with small beginnings, who may hope, as his knowledge and his means increase, to rise progressively in his profession, from a farm of 20 to one of 50 and 100 acres. If farms were either all large, or all small, this incentive to exertion would be wanting. If small, there would be no room for improvement or extension; and if large, the man of slender means, however skilful and industrious, would look hopelessly above him: there would be no intermediate steps, no gradation by which he might hope to climb upwards to a farm of 100, 200, or 500 acres; and he would too probably sink back into inertness, if not into despondency.

A variety in the size of farms, proportioned to the various amounts of skill and capital of the farmers, appears therefore the most desirable for all classes. This variety exists, with few exceptions, throughout England, and coupled with the circumstances of our rural population, cannot but be considered as favourable to the introduction of flax culture.

The Belgians and Dutch are very skilful in the cultivation of flax, and Flemish flax bears a high price in the market. In Ireland until recently, the cultivation was much neglected, and the flax raised was of a very inferior quality. This was not so much owing to the inferior nature of the plant, as to the mode of managing it after it was drawn; and the Society which was established a few years ago in the north of Ireland for encouraging the growth and improving the preparation of flax, directed its earliest attention to correct this defective management. They brought over skilful cultivators from Belgium to instruct the people; and afterwards, finding that this was not sufficient for the purpose, they selected a number of intelligent young men, and sent them to Belgium to learn the Flemish mode of cultivating and preparing the flax; and the result has been, that not only has the quantity of flax grown greatly increased since the

Society commenced its operations, but the quality of the flax has likewise greatly improved; and Ireland may now look forward, at no very distant day, to produce as much as she requires of this the great staple of her manufactures.

Can we doubt that what has thus, it may be said within a recent period, been done in Ireland, ought also to be done in England? The soil and the climate are at least as favourable for the growth of flax here as they are there, or as they are in either Holland or Belgium. Instructors may readily be obtained from either of these countries, or persons might be sent from hence to learn the various processes, and on their return they might impart instruction to others. The result would, I am confident, amply repay the outlay by the benefits it would confer, and the art once acquired would not be in danger of being lost.

The quantity of flax and tow imported into the United Kingdom in the year 1843, chiefly from Russia, Prussia, Holland, and Belgium, was, according to the Parliamentary Returns, no less than 1,437,150 cwts.; and the value of linens exported in the same year amounted to a million sterling, the official value given in the tables, which is always under the real value, being 898,829*l*. The quantity of the raw material imported, added to that produced within the United Kingdom, not only provided for our immense home consumption, but also allowed of an export to the above amount; and the importance to this country of encouraging the growth of flax, in an economical point of view, cannot therefore I think be doubted.

It has often been said that flax is a very exhausting crop, but it certainly is not more so than any of the usual grain crops, neither does it require a very rich soil. Indeed, a rich or highly manured soil is injurious, causing the plant to grow too strong and luxuriant, and rendering the fibre coarse and less valuable. Flax is grown on light, poor land in Belgium and in Holland, and I have seen it growing on mere bog in Ireland.

The general introduction of flax culture in England, would constitute a new and most valuable element in the rotation, and would enable the farmer to vary and extend his successions, which is in itself a highly important consideration. The water in which flax has been steeped is highly fertilizing when applied to the land, and the seed, when properly saved and prepared, constitutes excellent provender for cattle and milch cows. It may be safely asserted, therefore, that a flax crop rightly managed is not only valuable as affording increased means of employment for our agricultural population, and highly profitable for the purposes of the manufacturer, and for the feeding of cattle, but that it moreover returns to the soil, in the shape of manure, as much, if not more than any of the grain crops; in addition to which it

ought not to be overlooked by the agriculturist, that clover always does well after flax.

The directions given in my little work 'The Farmer,' were carefully compiled from more detailed instructions prepared and circulated by the Society for encouraging the Cultivation and Improvement of Flax in Ireland. These directions will, I believe, be found generally applicable, and always useful, although they may not always be sufficient, without other assistance, for enabling beginners to conduct the several operations. Where this is the case, and whenever there is a deficiency of practical knowledge within the district, recourse must be had to aid from a distance, for the purpose of obtaining the necessary information.

*London, November 26, 1844.*

---

XXXI.—*On the cheapest Method of making and burning Draining Tiles.*

*To the Earl Spencer.*

MY LORD,—The active interest you have so long taken in every thing connected with British agriculture, induces me to address to you the following communication on the subject of making and burning draining tiles, of whatever form, in the readiest and cheapest manner.

My attention has been very forcibly drawn to this subject by the high prices demanded by the manufacturers of these indispensable instruments of agricultural improvement, prices indeed so high, that even without the expense of carriage, they must have the effect of confining within comparatively very narrow limits their adoption.

It is true that the application of machinery to the producing of draining tiles, promised, and in some degree effected a reduction in the price of tiles previously made by hand, but owing to the mistaken views of those who worked these inventions, in fancying they could secure a monopoly of machine-made tiles, in requiring a seignorage on tiles made by their machines, and in the high cost of those machines, they offered the tiles to the public at so high a price that it soon became evident, if draining tiles were to be used to the extent required throughout the United Kingdom, that some other machinery of a less costly description, with equal, if not greater powers of production, and with unfettered liberty of using it, would be discovered—and this result has accordingly taken place. Two machines, worked by hand, have been discovered in the course of this year, viz. "Clayton's Machine," which is a fixture wherever set up, and for which a patent has been taken out; the other, called "Hatcher's Machine,"

easily movable, and manufactured and sold by Messrs. Cottam and Hallen, Winsley-street, London. The latter machine is the invention of Mr. John Hatcher, brick and tile maker and potter, living in the parish of Benenden, in Kent, where I reside, and is the one I have adopted; and all the subsequent calculations and quantities are made in reference to the producing power of that machine: and I beg to assure you that, as my sole object is to put the public in possession of the readiest and cheapest way of obtaining these tiles, if any other machine as yet discovered could make them better and cheaper, I should instantly adopt it, as I certainly shall if any such be hereafter invented; and it is quite certain that the public will apply the only real test of merit to these machines in determining their choice of one, viz., the cheapest rate at which tiles can be produced by them, taking into account the price of the machine, the amount of labour necessary to work it, the goodness and the quantity of tiles it can produce in the day, and the simplicity of its construction.

Being fully aware that Hatcher's machine was not excelled by any other yet discovered in all these essential points, and therefore assuming that machinery had accomplished much, if not all that could reasonably be expected from it, I still felt that the heavy expense of erecting kilns, as they are now constructed, together with the necessary sheds and other buildings incidental to a regular brick and tile yard, required so large an outlay, that the price of draining tiles would still continue too high for universal use, notwithstanding every improvement in the mechanical production of them. To this difficulty another must be added, no less serious, in attempting to reduce the price of tiles, viz., the expense of carriage of an article so bulky. Every one must be aware that beyond a certain distance from every brick and tile manufactory (unless it stands on the bank of some navigable water), the expense of carriage of tiles will impose the limit of their application to land drainage. What then is to become of those immense districts in the United Kingdom that are so situated? It will not much reduce the evil to incur all the heavy expenses of erecting kilns, sheds, &c. &c., after the usual manner; for interest on capital embarked in the business, together with rent, must be added to the cost of making them; and after all, *if the object be to make draining tiles only*, it is obvious that these buildings of a permanent and expensive character will become useless, whenever the circle around them is furnished with tiles, the extent of that circle being always determined by the expense of carriage beyond it.

Reflecting on these obstacles to universal drainage, where required, I conferred with Mr. John Hatcher on the possibility of erecting a kiln of common clay, that would be effectual for burning these tiles, and of cheap construction—and the result



was the building one in my brick yard in July last, and the constant use of it until the wet weather at the commencement of this winter compelled its discontinuance, but not until it had burnt nearly 80,000 excellent tiles; and in the ensuing spring it will be again in regular use.

I shall now proceed to take in order the six points enumerated under the 9th head of the Prize Essays for 1845, as printed in the last volume of the Royal Agricultural Society's Journal, viz. :—

1st. Mode of working clay according to its quality.

2nd. Machine for making tiles.

3rd. Sheds for drying tiles.

4th. Construction of kiln.

5th. Cost of forming the establishment.

6th. Cost of tiles when ready for sale.

1st Point. Working the clay.

All clay intended for working next season must be dug in the winter, and the earlier the better, so as to expose it as much as possible to frost and snow. Care must be taken if there are small stones in it, to dig it in small spits, and cast out the stones as much as possible, and also to well mix the top and bottom of the bed of clay together. It is almost impossible to give minute directions as to mixing clay with loam, or with marl when necessary, for the better working it afterwards, as the difference of the clays in purity and tenacity is such as to require distinct management in this respect in various localities; but all the clay dug for tile-making will require to be wheeled to the place where the pug-mill is to work it; it must be there well turned and mixed in the spring, and properly wetted, and finally spatted down and smoothed by the spade, and the whole heap well covered with litter to keep it moist and fit for use through the ensuing season of tile-making.

2nd Point. Machine for making tiles.

For the reasons already alluded to, I prefer Hatcher's machine. Its simplicity of construction, and the small amount of hand-labour required to work it, would alone recommend it; for one man and three boys will turn out nearly 11,000 pipe tiles of one-inch bore in a day of ten hours, and so in proportion for pipes of a larger diameter; but it has the great advantage of being moveable, and those who work it draw it along the shed in which the tiles are deposited for drying previously to their being burnt: thus each tile is handled only once, for it is taken off the machine by the little boys, who stand on each side, and at once placed in the rows on either side of the drying shed; thus rendering the use of shelves in the sheds wholly unnecessary, for the tiles soon acquire a solidity to bear row upon row of tiles till they reach the roof of the sheds on either side; and they dry without warping or losing their shape in any way.

The price of this machine is 25*l.*: and it may be proper to add, that the machine makes the very best roofing-tiles that can be made, and at less than half the price of those made by hand, as well as being much lighter, and closer, and straighter, in consequence of the pressure through the die.

It is necessary, in order to ensure the due mixing of the clay, as well as to form it into the exact shape to fill the cylinders of the machine, to have a pug-mill. Messrs. Cottam and Hallen make these also, and charge 10*l.* for them. This mill must be worked by a horse; in general one day's work at the mill will furnish rather more prepared clay than the machine will turn into tiles in two days.

3rd Point. Sheds for drying.

The sheds necessary for this system of tile-making will be of a temporary kind: strong hurdles pitched firmly in the ground in two parallel straight lines, 7 feet apart, will form the sides of the sheds, and the roof will be formed also of hurdles placed endways and tied together at the top, as well as to the upper slit of the hurdle, with strong tarred twine, forming the ridge of the roof exactly over the middle of the shed. They must then be lightly thatched with straw or heath, and the sharpness of this roof will effectually protect the tiles from rain. Two of these sheds, each 110 feet long, will keep one of the kilns hereafter described in full work.

N.B.—These sheds should be so built as to have one end close to the pug-mill and the clay-heap, only leaving just room for the horse to work the mill, and the other end near the kiln. Attention to this matter saves future labour, and therefore money.

4th Point. Construction of kilns.

The form of the clay-kiln is circular; 11 feet in diameter, and 7 feet high. It is wholly built of damp earth, rammed firmly together, and plastered inside and out with loam. The earth to form the walls is dug out round the base, leaving a circular trench about 4 feet wide and as many deep, into which the fire-holes of the kiln open. If wood be the fuel used, three fire-holes are sufficient; if coal, four will be needed. About 1200 common bricks are wanted to build these fire-holes and flues: if coal is used, rather fewer bricks will be wanted, but then some iron bars are necessary—six bars to each fire-hole.

The earthen walls are 4 feet thick at the floor of the kiln, are 7 feet high, and tapering to the thickness of 2 feet at the top; this will determine the slope of the exterior face of the kiln. The inside of the wall is carried up perpendicularly, and the loam plastering inside becomes, after the first burning, like a brick wall. The kiln may be safely erected in March, or whenever the danger of injury from frost is over. After the summer use of it, it must be protected by faggots or litter against the wet and the frost of winter.

A kiln of these dimensions will contain

47,000	1	inch	bore	pipe	tiles.
32,500	1 $\frac{1}{4}$	"	"	"	"
20,000	1 $\frac{3}{4}$	"	"	"	"
12,000	2 $\frac{1}{4}$	"	"	"	"

and the last-mentioned size will hold the same number of the inch pipes inside of them, making therefore 24,800 of both sizes. In good weather this kiln can be filled, burnt, and discharged once every fortnight; and 15 kilns may be obtained in a good season, producing—

705,000	1	inch	pipe	tiles;
Or, 487,500	1 $\frac{1}{4}$	"	"	"
Or, 300,000	1 $\frac{3}{4}$	"	"	"

and so on in proportion for other other sizes.

N.B.—If a kiln of larger diameter be built, there must be more fireholes, and additional shed room.

5th Point. Cost of forming the establishment.

The price charged by Messrs. Cottam and Hallen for the machine, with its complement of dies, is	£.	25
Price of pug-mill	.	10
Cost of erecting kiln	.	5
Cost of sheds, straw	.	10
		—
		£ 50

The latter item presumes that the farmer has hurdles of his own.

6th Point. Cost of tiles when ready for sale.

As this must necessarily vary with the cost of fuel, rate of wages, easy or difficult clay for working, or other local peculiarities, I can only give the cost of tiles as I have ascertained it here according to our charges for fuel, wages, &c. &c. Our clay is strong, and has a mixture of stones in it, but the machine is adapted for working any clay when properly prepared.

It requires 2 tons 5 cwt. of good coals to burn the above kiln full of tiles. Coals are charged here at 28s. per ton, or 1000 brush faggots will effect the same purpose, and cost the same money; of course some clays require more burning than others; the stronger the clay the less fuel required.

The cost of making, the sale prices, and number of each sort that a waggon with 4 horses will carry, are as follows:—

	Cost.		Sale Price.	
	s. d.	per 1000	s.	Waggon holds.
1 inch Pipe Tiles	4 9	"	12	8,000
1 $\frac{1}{4}$ "	6 0	"	14	7,000
1 $\frac{3}{4}$ "	8 0	"	16	5,000
2 $\frac{1}{4}$ "	10 0	"	20	3,500
2 $\frac{3}{4}$ "	12 0	"	24	3,000
Elliptical Tiles			24	2,000
Soles			10	

All these tiles exceed a foot in length when burnt.

The cost price alone of making draining tiles will be the charge to every person making his *own* tiles for his *own* use. If he sell them, a higher price must, of course, be demanded to allow for some profit, for credit more or less long, for bad debts, goods unsold, &c. &c.; but he who makes his own saves all expense of carriage, and, as his outlay will not exceed 50*l.*, the interest on that sum is too trifling to be regarded, and he has no additional rent to pay; and after he has made as many tiles as he wanted, his machine and pug-mill will be as good as ever with reasonable care, and will fetch their value.

I fear that no drawing could be made that would ensure a person erecting one of these kilns by it from the chance of failure; and I do not know any way by which these kilns can be erected, and the mode of using them taught, so as to obviate disappointment, except by Mr. Hatcher being engaged to erect one or two in a county, which will serve as models.

It will not be improper to put those who may adopt any machine for tile-making upon their guard against the prejudices of tile-makers. The necessity and the demand for draining tiles has infinitely outstripped the possibility of the supply being furnished by hand work alone in the old way: but as the services of every man who has been used to this work will be more than ever needed, the employer will find his account in securing them for the working of his machine by giving liberal wages, and by convincing the men that their earnings by work, not so laborious, but more effective, will be at least equal, and they will soon really be greater than they obtained from their former occupation.

I hope that this paper will prove the means of saving a large expenditure on buildings of a permanent character, where *draining tiles only* are wanted to be made; as such buildings, under such circumstances, will become useless when they have supplied the district immediately around them: for land once thoroughly drained with tiles, and on true principles, is, generally speaking, drained for ever.

With sincere regard I remain, my Lord,

Very truly yours,

*Hemsted, Kent, Dec. 18, 1844.*

THOS. LAW HODGES.

---

#### NOTE BY MR. PUSEY.

IF Mr. Hodges should succeed in rendering the making of draining-tiles a domestic manufacture, he will have set the seal to their cheapness, and thereby conferred a great boon on farmers. As there is no point in which our Society has been more successful than in reducing the cost of drainage, we may take this occasion of looking back to what we have done.

In the first number of our Journal, published in 1839, I find

the following passage :—“ The expense (of thorough-draining) is estimated from 3*l.* to 12*l.* per acre, according to the frequency of their application.” The price in my own neighbourhood and in the Isle of Wight was then 60*s.* per 1000 for tiles, and 30*s.* for soles, being 90*s.* for every 1000 feet of materials.

In 1841, we discovered that Mr. Beart in Huntingdonshire was selling tiles of about the same size for 22*s.*, and the soles for about 10*s.*, being 32*s.* for every 1000 feet of materials.

In 1843 we found that pipes of various shapes were sold in Suffolk and Kent at 20*s.* per 1000, being 20*s.* for every 1000 feet of materials.

I was thus enabled in May, 1843, to give the following reduced estimate for draining an acre of land :—

Distance between Drains.	Pipes.	Total Expense.
Feet.	£ s. d.	£ s. d.
66	0 13 4	1 0 0
44	1 0 0	1 10 0
33	1 6 8	2 0 0
22	2 0 0	3 0 0
16½	2 13 4	4 0 0

Our engineer, Mr. Parkes, has since examined the subject of pipe-drainage most minutely. He has proved that in theory an inch-pipe can discharge the heaviest rains from the land, and he has gone far to shew their efficacy in practice. Mr. Parkes, in his Report on the Implements shown at Southampton, announces that such pipes are actually now selling in the Isle of Wight for 12*s.* per 1000. I may, therefore, after so short an interval again have the pleasure of laying before the Society further reduced estimates of the price of drainage. The most convenient measure is, I think, the furlong, because that is the old dimension in length of an acre, the width being 66 feet; and if the cost of one drain for that width be known, it is easy of course to calculate for nearer distances. A furlong, too, is equal to 40 poles, a common length in calculation for the digging of drains.

*Cost of Thorough-draining one Acre.*

Distance between Drains.	Length of Drains in Furlongs.	Feet of Pipes.	Cost of Pipes.	Forming Drains 30 in. deep.	Total Cost.
Feet.			s.	s. d.	£ s. d.
66	1	660	8	8 0	0 16 0
44	1½	990	12	12 0	1 4 0
33	2	1320	16	16 0	1 12 0
22	3	1980	24	24 0	2 8 0
16½	4	2640	36	36 0	3 12 0

A trifling addition must be made for main-drains. In laying

down the pipes we should look to those counties where draining was invented, and has been practised most largely. I mean our eastern counties—Essex, Suffolk, Norfolk, Herts, &c. For, as Mr. Copinger Hill\* informs us, “On the heavy lands of Suffolk and the adjoining counties under-draining at a distance of  $16\frac{1}{2}$  feet and a depth of 26 or 30 inches *is as much a matter of routine as hedging and ditching.*” Now the usual shape of drains there is extremely narrow at bottom, tapering down from a width of 4 to that of 2 inches, as shown in the drawing given by him, and here repeated.

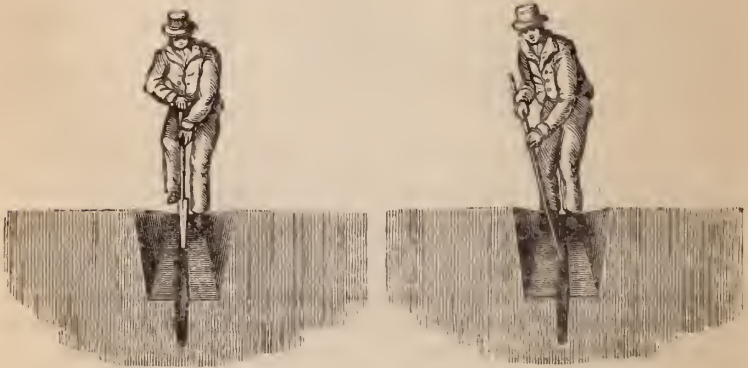

It so happens that this old and approved shape from the birth-place of thorough-draining is precisely adapted to our most modern improvement, the small pipe. The Essex tools which have been for some time employed by my workmen, were found by them last winter equally adapted, at least in very strong clay, for pipe as for thorn-draining. They are the old-fashioned narrow spade and the scoop. With this narrow spade three cuts are made, two on the sides of the cut, and one across; but in clays perfectly free from stones, I believe that the biting tool mentioned by Mr. Arkell in his Prize Essay on Drainage is even better. I will only add that if Mr. Hodges's temporary kilns and sheds should enable the farmer to make inch-tiles at 4s. 9d. per 1000, the estimates for draining an acre must be further reduced as follows: on clay-lands without stones—

Narrow Spade.

Scoop.



\* Society's Journal. Vol. iv. p. 26.

Distance between Drains.	Length of Drains in Furlongs.	Feet of Pipes.	Cost of Pipes.	Forming Drains.	Total cost per Acre.
Feet.			s. d.	s.	£ s. d.
66	1	660	3 2	8	0 11 2
44	1½	990	4 9	12	0 16 9
33	2	1320	6 4	16	1 2 4
22	3	1980	9 6	24	1 13 6
16½	4	2640	12 8	48	3 0 8

The ordinary distances may be taken at 33 and 22 feet, giving the length of drains 2 or 3 furlongs per acre. If land can be thus permanently drained for little more than a pound or a guinea and a half per acre, and if the closest drainage that can probably be required may be done for three pounds per acre, there will really be no longer any excuse for an undrained field in any part of the country.

PH. PUSEY.

---

XXXII.—*On the Indications which are practical Guides in judging of the Fertility, or Barrenness of the Soil.* By JOHN BRAVENDER, F.G.S., Land-Surveyor, Cirencester.

PRIZE REPORT.

IT appears rather surprising that the natural indications of barrenness and fertility should have received little or no attention from agriculturists. They have hitherto appeared to pass over the subject as one that is not worthy of the notice or the study of the cultivators of the soil of Great Britain. Nevertheless this subject is really so important, that I feel totally incapable of doing it justice, and were I certain that any other person was now preparing a paper on the subject, I could not persuade myself to proceed: being only induced to do so from believing that it has been altogether neglected, and that any remarks, however meagre and imperfect, may arouse the attention of others better qualified; that, possibly, any attempt, however feeble, to enlarge the means of securing a correct conclusion in matters of such importance might not be deemed altogether useless, although they might have originated with an individual in a humble sphere of life; and that a few simple observations might pave the way for the introduction of a system more worthy of the notice of the world than any I could write or suggest.

I need not describe the manner in which my attention was first called to this subject, or state the motives for undertaking,

unassisted by others, such an arduous business as an examination into the character and produce of the soil of Great Britain. Surface appearances seemed to fall short of what I expected would be made use of to direct the judgment in such an important business. I felt disappointed at not finding in use something of a more scientific and definite character, having, from early pursuits, been insensibly led to set rather too high a value on science, deeming it then of quite as much importance as experience. On farther consideration I appeared to have tacitly objected to what I had not the power to remedy, nor could a substitute be easily found of a more satisfactory nature. Everything that suggested itself appeared to be surrounded by insuperable difficulties. However, I determined to ascertain what could be devised to meet the objections which, in these circumstances, presented themselves, and finally was obliged to admit that I should not accomplish the object in view, except by a long and tedious course of experiment and observation, which then did not appear practicable for me to undertake. Circumstances happened which soon afterwards caused me to move straight across the principal geological strata of the kingdom, and I saw and minutely examined them all, with the exception of the granitic or plutonic rocks, and one or two formations allied to them. But, what was of infinitely more importance to my project, I had the opportunity of inspecting whole districts, field by field, with the value of each in my hand, which had been fixed by gentlemen of great experience and of the nicest judgment, whose opinions, founded on those alone, have been for many years acknowledged to be as accurate as the nature of the subject admitted.

The due consideration of the fertility or barrenness of soils will require us to introduce other subjects than those named in the advertisement of the Royal Agricultural Society. I propose to arrange them under the following heads:—Colour; Consistency; Vegetation; Aspect, and Elevation above the level of the Sea; Geological Position and Character; and General Indications.

---

#### I.—COLOUR.

##### *Indications of Barrenness.*

The colour of the herbage of pasture-land varies so much, both with the season, the period of the year when observed, and from other circumstances, that it cannot be relied on as an indication either of barrenness or fertility, except in some very obvious cases. The herbage of barren pasture-land generally appears brown, or reddish brown; it scarcely ever appears green,



either in spring, summer, or winter. All pasture-land that produces rough, coarse, unpalatable grass, which stock will not touch unless compelled by hunger, has the appearance of *hay half made*, although the grass is not cut; and all pasture-lands having this appearance, that is, having the colour of half-made hay, must be accounted barren.

The soil of barren land is exceedingly various in colour, embracing almost all shades that can be mentioned, some of which are also indications of fertile land. Barren soils are generally of a lightish brown, fox, fawn, pale red, and whitish yellow colour; a deep yellow is a certain indication of barrenness.

Soils having the following colours and appearances are barren:—

Thin chalk soil which is nearly white.

Chalk soil where the flints are of a pale white colour.

Diluvial soils which contain a dead white gravel near the surface.

Moors and bogs which are nearly black, or of a dark brown colour, to a considerable depth; and the same kind of soil with a white soil under it, or with white gravel near the surface.

Soils principally composed of white silvery sand, black sand, pink sand, yellow sand, white clay, blue clay, yellow clay, and pink clay.

Gravelly soils are barren where a scum rests on the surface of the water in the ditches of a ferruginous appearance, and shining bright, like the bloom on a plum or a peach. The scum resting on the surface shows that the water is stagnant, or has but a very slight draught, which may have more to do with the barrenness of the soil than the colour of the scum on the surface. The cause is not an inquiry of ours, but, however simple and unconnected with the colour of the soil this may appear, I have no doubt that the scum of a ditch exhibiting this colour is a sure indication of the original barrenness of the adjoining lands. Such is the appearance of the water, generally, in or near to bogs. A familiar example of a district having this appearance in the ditches may be witnessed at or near Knapton, called "Knapton over Car," in the vale of the Derwent, about 8 or 9 miles east of Malton, Yorkshire. Other localities might be enumerated, but this is named on account of its being rather extensive.

### *Indications of Fertility.*

The colour of the surface which arises from the grasses and plants is not to be relied on as an indication of fertility or barrenness. It will vary very much with the alterations of the weather, and the changes of temperature which generally accompany such alterations. It will also vary with the time of the year when the land is seen; the colour of the grass is not the

same in spring, summer, and autumn. Land that is fertile possesses a much greater power to withstand the effects of a change in temperature and continued drought than barren soil, and will often retain a nice, fresh, green colour, when lands that are barren will appear brown and scorched, or burnt up.

In winter the colour will appear more of a whited-brown than that of barren land, and on examination it will be found that the stems of the best grasses are visible, appearing like very fine barley-stubble which has been mown close, but not so conspicuous, being mixed with other grasses not furnished with strong stems. The stems give to the surface a whitish appearance in winter.

From elevated spots I have often looked over a district in the vale, and have remarked that lands which had been manured were of a darker green colour than those adjoining of a similar quality which had not been so manured; and, on a nearer inspection, I have found the dark green-coloured herbage to be more luxuriant in growth, the grasses thicker and taller, and the leaves broader, and the produce altogether more forward and promising than that of the adjoining lands. This would lead us to conclude that a dark green-coloured herbage is an indication of fertility.

The colour of the soil itself in pasture-lands is seldom very particularly observed, but the soil of all fertile pasture is invariably dark for its kind: even the chalk-marl is a darkish grey colour, and sometimes nearly black at the surface when a thin turf is removed. Garden-mould is invariably dark brown in districts where the soil in the fields is of a light brown, or a fox, or fawn colour. This dark colour is derived from the decomposed vegetable and animal matter with which it becomes mixed after a few years' cultivation.

All top-soils that I have seen, except some in the coal-districts and bogs, are darker at or near the surface than at a few inches beneath. The decomposed animal and vegetable substances become, in some degree, the colouring matter of soils, and where this colouring matter is most abundant the soils will be dark; and, the same substances being also the fertilizers of soil, it would appear that there is a connexion between fertility and the dark colour of the soil sufficiently apparent to induce us to suppose that dark soils are invariably fertile soils. It is believed they are so with the exception of those of a peaty and boggy nature, and that of black sand, which is of very limited extent.

Fertile arable lands have various shades of colour, but all of them are of a much darker shade than lands in the same district which are barren.

---

## II.—CONSISTENCY.

*Indications of Barrenness.*

The consistency of soils is a matter of great importance, and must always be closely observed, having an intimate connection with their barrenness or fertility. Naked rock is always barren, and the soils composed of what we call sand and what we term clay, unmixed with other substances, are likewise always so. Land, the subsoil of which is composed of those substances, with but a thin coat of vegetable mould, of not more than 2, 3, or 4 inches in depth, is always naturally barren. A large quantity of land in England, occupied as sheep-walks, called downs and wolds, is of this description, having sand and rock for subsoil; and the coal-fields are examples with a clay subsoil. Other clay districts might be named, but they are not so uniformly barren as those mentioned.

The soil of pasture-land is seldom exposed, and if the consistency cannot be ascertained by looking over the surface, it is usual to inspect the ditches, banks, pools, grips, furrows, and, if none of these exhibit any sufficient characteristics, a spade is used and sods are cut out of the turf, here and there, all over the land. In cases where the surface soil, or the soil that has been turned over by the plough, if the land ever has been ploughed, is very thin, the subsoil, if not a solid rock, will appear attached to the turf which is turned up: but, where a considerable depth of this soil exists, a second or third application of the spade becomes necessary, and if, at the depth of 18 inches or 2 feet or more, the subsoil\* does not appear of a decisive character, the consistency of what has been exposed is examined, and a note made of its character, for future consideration, should such be necessary.

If the sod, when turned up in various places, shows the subsoil, at the depth of 2, 3, or 4 inches, to be one regular compact mass of clay, such will be a certain indication of the barrenness of the land, notwithstanding any surface appearances to the contrary.

I have seen many fields that are situated on a clay subsoil, with a slight covering of surface soil, as well as on a thin, dry, rocky, gravelly, and even sandy subsoil, appear nice and fresh, and the herbage of a lively green; but such appearances always have their source in manure and good farming, and are liable to deceive the superficial observer. An examination into the depth of the soil, and the nature of the subsoil will at once show that such lands

---

\* In many situations there is a considerable quantity of soil unmixed and unstained with vegetable matter, and which has never been exposed by the plough. It will be convenient, but perhaps not quite accurate, to consider such undersoil as the subsoil, although it may not be formed exclusively of the soil, or be derived from the rock peculiar to the formation on which it rests.

have a better face upon them than the original nature of the soil will warrant.

Soils possessing the consistency described in the following condensed remarks, are always barren. It may be as well to observe that all soils are considered to be thin if less than 4 or 5 inches deep from the surface to the rock, clay, or subsoil:—

Dry, rubbly, slaty, or compact rock, under a thin surface soil.

Flinty or chalk rock under ditto.

Clay ditto ditto.

Sand, particularly black sand ditto.

Gravel ditto.

Clay, gravel, or sand, under a thin peaty surface.

Sand and gravel composing nearly the whole of the surface-soil, as well as the subsoil.

Clay ditto ditto.

Rock and stone ditto ditto.

Clay soil which cuts like soap, and afterwards dries like a brick.

Sand which is light and liable to drift with the wind.

Clay soil which is not mixed with a large quantity of vegetable matter in a state of decomposition.

Sandy soils ditto ditto ditto.

A mixture of sand and clay, in such proportions as to run together after a brisk rain, and set on the surface like cement.

Sand and clay, not mechanically mixed, but found in alternate layers, and the clay of various colours.

Quicksands wherever found. They are frequently found in the last-mentioned soils, composed of alternate bands of clay and sand.

The Cotswold Hills, in Gloucestershire, and the whole western summit of the continuation of the same hills, extending southward from Charlton Hill near Cheltenham, to near Sherborne in Dorsetshire, and northward to near Whitby in Yorkshire, and a large portion of North and South Wales, are familiar examples of the first-mentioned kind of soil, which is well known to be naturally barren.

The summit of the Chalk Hills, which extend from the southern coast of Dorsetshire to Flamborough Head, in the East Riding of Yorkshire, is a familiar example of the second kind of soil mentioned in the foregoing list, which is well known to be naturally barren.

The Coal-Measures are familiar examples of the third kind of soil, as well as some parts of the Lias, Oxford, Gault, and Weald Clays. The Coal-Measures are well known to form the most sterile districts in the kingdom. And examples of the fourth kind of soil mentioned are to be found profusely scattered over Norfolk, Yorkshire, Hampshire, and other counties.

Some portions of these districts, by good management, change their natural appearance and productive quality; but, if that superior management which gradually causes such change were to be withdrawn for a time, those lands so cultivated would fall back to their primitive state of barrenness, and would produce but very short and scanty herbage and very inferior crops of grain.

Many also of the other kinds in our list are rendered fertile by manure, management, and draining, &c. Thousands of acres are at this moment, to all outward appearances, fertile, which are not permanently so, but which have been artificially made and kept so, and which, with the exception of land, the unproductive quality of which had been caused by a want of draining, will eventually, if neglected, return to a state of sterility.

#### *Indications of Fertility.*

All unmixed clay soils are too tenacious to be fertile; all unmixed silicious soils are too loose to be fertile; and all unmixed chalk soil, that is a soil of carbonate of lime only, is too pure to be fertile.

One would perhaps, without reflection, suppose, from those simple statements, that a mixture also of these three kinds of soils would not be fertile. We should be ready to suppose it impossible that good could arise out of a mixture of evils. But, however paradoxical this may appear, it is, nevertheless, certain, that a mixture of the kind of soils named constitutes the medium through which the fertilizing properties contained in them are rendered active, which, in their unmixed state, would have remained dormant and useless. The mixture becomes a new soil, possessing new powers of absorbing and transmitting moisture; and all that is necessary to give greater activity to its fertilizing powers is, to add a quantity of animal or vegetable matter, or of both, in a state of decomposition, if none be apparent in either, and afterwards to take care to return to this soil at least as much fertilizing matter as we have abstracted from it in our crops, in order to secure its permanent fertility.

This will serve to show what an important feature consistency is, in fertile or barren soils, and what an easy thing it would be to make it available for the purpose of assisting the judgment, if it were uniform, or even if the consistency of fertile soils only were uniform. But unfortunately there are as many kinds of consistency as degrees of fertility, the limits being a sand, or soil the particles of which do not adhere except when wet, and a clay, which forms a paste when wet and something like a brick when dry. Between these two conditions fertility seems to oscillate, and can only be estimated between the highest and lowest point, by an assumption which is perfectly arbitrary, depending on the skill and judgment of the party employed to decide.

Fertility and barrenness are but relative qualities, and, taken as we commonly use the terms, they are liable to vary with the ideas of individuals. It would be presumption in me to attempt to assign limits to, or give a precise definition of, either. I may venture an opinion, which may be reckoned as one amongst a

hundred others. I will suppose pasture-land which does not produce more than 1 ton of hay per acre, when mown in its proper turn, to be barren. And with regard to arable land, considering it to be planted with such crops as are suitable, if it does not produce on the average more than 20 bushels of wheat, or 30 bushels of barley, beans, or oats, we will suppose it to be barren, and call these the limits. This would leave a very great range for fertile soils, which would in practice require to be classed into three divisions at least, which might correspond with the terms *fertile*, *more fertile*, and *most fertile*. In arable lands the extreme limit of *most fertile* would be at least three times the quantity of that which is simply *fertile*, having, in many instances, reached 60 bushels of wheat, 72 of barley, 90 of beans, or 96 of oats per acre, without any extraordinary management. Taking these figures, we should assume the range of the produce per acre of land of the lowest degree of fertility, or that which is simply called *fertile*, to be from 20 to 30 bushels of wheat: the more fertile, or land of the second degree of fertility, from 30 to 40 bushels; and the most fertile, from 40 to 60 bushels per acre. Land that will, with the ordinary course of husbandry, produce the last-mentioned quantity, is justly entitled to the term "most fertile;" but this quantity has really been produced by large tracts of land which have the name of alluvial deposits given to them by geologists. (*See Alluvium.*) To return to the subject of consistency, the tenacity will be sufficiently destroyed when, on taking a lump between the fingers, it can be reduced into smaller portions without forming into paste. If the soil be such as to admit of being formed into marbles by boys, and so tenacious as to stand baking, the consistency is too adhesive to be fertile. Also, if after being formed into marbles and stuck on the end of a stick, if the tenacity be such as to allow of the marble being thrown to a considerable distance, without crumbling or breaking, the soil is too adhesive to be fertile.

It would appear from these simple considerations that soil which will not admit of being formed into marbles, or stuck on the end of sticks, and thrown to a distance, if not of a coarse silicious character, possesses a consistency favourable to fertility, and that such fact may be taken as an indication.

If the land, when ploughed, cuts out as it were in one entire piece, and the furrow-slice does not break into lengths and become cracked across at very short intervals, its tenacity is too great to be fertile; but if these things happen, and, on walking across the lands the exposed edges of the furrows are crushed by the feet, and crumble and leave the edges of the footmarks ragged, such will indicate the proper consistency of a fertile soil; but, if the footmarks appear clean at the edges, and pressed down flat and

smooth, not ragged and loose, such will indicate a soil too tenacious to be fertile. Of course, much will depend on the weather, and whether the land has been recently ploughed. I have assumed the land to have been lately ploughed, and the state of the soil to be a medium between wet and dry.

Fertile lands generally plough clean, and the surface of the furrow, when turned over, retains a shining, glossy appearance, not occupying the entire surface, but intercepted by cracks and fissures, which show that the consistency is of a medium kind, between sand and clay, with sufficient adhesive power to retain moisture, and sufficient porosity to allow of such moisture being transfused through the soil, and so equalized that plants and vegetables growing thereon may be benefited to the greatest extent possible.

In arable districts there is a kind of accidental barrenness, occasionally produced by mismanagement, and sometimes it has its origin in the want of draining. We call it accidental, because it is frequently in operation only for a season. A difficulty may arise as to whether lands found in this state are to be deemed barren. Lands of good texture and naturally fertile are sometimes so harassed, by taking a long-continued succession of corn crops, without returning manure, as to be reduced to a state of unproductiveness. Such lands appear, to the superficial observer, to be barren, when they are only apparently so: unproductive it is true, but only so for a time, until a judicious manager, with little more than his common farm resources, effects one revolution of a proper system of crops, and the soil will be restored to its natural state, and ready to receive improvement from his future exertions.

That state of barrenness which operates only for a season arises from land having been ploughed, sown, and harrowed, at an improper season, or under unfavourable circumstances. This happens generally when the land is too wet to be sown. The surface is worked into a mortar by the harrows, and the soil, consisting of clay with some sand, afterwards becomes baked in the sun and forms a stiff hard crust, which is very difficult to reduce and pulverize by the application of the hoe. I have seen lands really fertile when so managed, which have run together and set on the surface like cement, and the crops, in consequence, have been very deficient.

---

### III.—VEGETATION.

#### *Indications of Barrenness.*

The quantity and quality of the natural vegetable productions of any pasture-land are not only the principal guides in judging

of the barrenness of soils, but at the same time the most certain of any. It is said "every tree is known by its fruit," and it might also have been said, with as much truth, that pasture-land is known by its natural vegetable productions.

To ascertain the quality and probable quantity of produce to that degree of certainty which is desirable, the herbage will require to be very closely inspected. I am aware that it has been customary to estimate the produce, and, at the same time, the permanent capability of the land for continuing that produce, from surface-appearances, without taking into consideration the *description* of herbage which formed the principal portion of the crop. In certain circumstances such an estimate will be found to furnish a more accurate idea than could be expected; but, if the judgment of the party thus attempting to give an opinion has not been matured by experience, it will be folly for him to allow himself to be guided solely by such an uncertain indication as mere surface-appearance.

It is well known that a man cannot jump into all the necessary experience, and have his judgment disciplined at once, and at a period when he chooses. If so, how then can persons without this experience—which is often the labour of a life—be induced to rely on surface-appearances, as is sometimes, I was about to say frequently, the case? It is impossible that an accurate opinion can be given of anything which is uncertain. All mere surface-appearances are liable to change from sundry causes, such as temperature, drought, too great abundance of moisture, manure, cultivation, &c. They scarcely ever remain the same for a week together. Then how absurd to presume to judge from such alone! On the contrary, if a man takes into consideration the *description* of the herbage, knows what it is when he sees it, and can name it, and at the same time knows from experiment made, either by himself or by others who have preceded him, that the herbage he sees is unproductive in favourable circumstances of cultivation, or productive in unfavourable circumstances, or has a tendency to either, he can with greater confidence rely on the opinion he finally comes to being founded on, and derived from something possessing the character of certainty, having been tested and established by observation and experiment.

The time of the year when examined, and a wet or dry season, often make a great difference in the surface-appearances, but they never alone change the vegetation with which the land is covered. There is a difference in the state of the growth of the grass: it is more luxuriant than usual, or the contrary; but its nature and description are changed only by a change of soil from a state of barrenness to fertility, and the contrary. By making



the *kind, description, and character* of the natural grasses subservient to our purposes, and adopting them as guides to our judgment, we at once secure assistance of a more definite kind, and our decisions, whatever they may be, partaking of the source from whence they are derived, cannot fail not only to be more satisfactory, but more rational and scientific.

It is a common practice, when land is inspected for the purposes of a valuation, to make remarks respecting the herbage for future guidance, such as the following:—

The herbage is of a bad quality. The bottom is mossy. The herbage is short, but sweet, and thick at the bottom. This piece will produce very tough fodder; it is coarse and benty. This piece will produce a rough, peaty, sour grass. This is covered with poor, benty herbage. And, where the land is good, similar remarks of an opposite character and meaning are made use of.

Without meaning to dictate to any one, I propose that, in addition to these and all similar kinds of remarks in all circumstances, the quality and *description* of the prevailing grasses should be particularly noticed, for it is on those that the quantity of produce depends, and which are sure evidences of the barrenness or fertility of the soil that produces them.

I should be sorry hastily to condemn established practices, or complain of such not being capable of supplying that kind of information which is expected of them. It is believed that the usual way of noticing the herbage of grass lands, and of allowing the judgment to be made up or guided by such observations as we have just enumerated, must lead to uncertainty. It is true such observations, when made by reason of such appearances being very plainly exhibited, are indications of poverty or barrenness, and so far ought to be made use of; but, certainly in all matters of importance, there should be a test applied if one is known to exist. In matters of this kind one of easy application may be introduced, namely, that of ascertaining the prevailing kinds of natural grasses which are found to have usurped the greater portion of the surface of the soil. Here we shall find that we possess a test which is not only as certain as the nature of such things will admit of, but which is definite and universal in its application.

To ascertain the prevailing kinds of herbage we must get at the names of the several grasses which we know, from repeated observation, to grow upon and occupy, almost to the exclusion of any others, the lands that are barren; and, having made a list of them, let some land be visited, and if certain grasses and herbage which are conspicuous in the list are found to occupy the greater portion of the surface, such land may safely be pronounced to be barren. An inquiry here suggests itself—Why is it barren?

Because it is found that the surface is occupied by grasses which are known from experiment to be unproductive. And why is the surface thus occupied? Because it requires a fertile soil to produce and bring to perfection a great quantity of produce of a good quality; and the reason why all soils do not naturally do so is because they are not fertile, that is, they are barren. And further, it is known that any surface occupied by natural grasses of an unproductive kind may be improved by manuring, and made fertile by a long continuance of good management. But barren land can never be made fertile without changing its herbage, and, as certain as we begin to manure and improve our grass land, that herbage which is a never failing indication of barrenness will gradually disappear, and will be replaced by that of a better kind, and the land will finally become clothed with good natural grasses, the presence of which is a certain indication of fertility.

There are also other vegetable productions always present in pasture-lands which are indications of barrenness and fertility, and point out, almost to as great a certainty as those which constitute the principal produce, whether land producing them be barren or fertile. Those also are capable of being formed into a list and made use of, and are an admirable test of the ideas derived from previously-observed surface-appearances.

Thus, by stating in our observations that certain lands produce this or that kind and description of plants, at the same time writing down their names, such observations will point out, in a definite and simple manner, the inferiority or fertility of soils much more distinctly than by stating that the herbage is coarse, sour, benty, and peaty. If the herbage be really coarse, sour, benty, and peaty, the names of the prevailing grasses found upon such soil will not only convey to the mind that such herbage is unproductive, but, in addition, the certain knowledge that the land producing it is absolutely barren.

The very appearance of many of the plants in the following list is a certain indication of the barrenness of the soil that produces them, but a few are enumerated that cannot be considered to be so decisive in their indications, and must be found in considerable quantities before they are put down as *certain*. Such are the daisy, plantain, cowslip, &c. Their appearance, however, is calculated in any circumstances to excite suspicion, and ought to be taken as an indication of barrenness, until it is found from examination that the proportion of the surface they occupy is not so great as to warrant their presence being taken as a decided indication.

NAMES of PLANTS, HERBS, FLOWERS, &c. and NATURAL GRASSES, which are Indications of Barrenness where they have elected to grow spontaneously, and where the Grasses are observed to have usurped the greater portion of the surface.

BOTANICAL NAMES.	ENGLISH AND LOCAL NAMES.	OBSERVATIONS, LOCALITIES, &c.
Agrimonia eupatoria . . . Apargia hispida . . . Bellis perennis . . .	Agrimony . . . . . Rough dandelion . . . . . Common daisy . . . . .	Dry sandy soil. Dry barren pastures. Grows on lands of a medium quality, as well as on barren lands. In the best pastures it is prevented from appearing, because of the best and more powerful grasses usurping its place.
Botanica officinalis . . . Campanula glomerata . . .	Wood betony . . . . . Clustered bell flower, Canterbury bells.	Woods and shady places. Elevated chalk pastures.
Campanula rotundifolia . . . Carduus acanthoides . . . and others of the same tribe.	Heath bell-flower . . . . . Prickliest thistle . . . . .	Heaths, dry barren pastures. Cora-fields, banks, amongst rubbish.
Carex præcox . . . . . Carex pulicaris . . . . . and others of the same tribe, including the famous carnation grass so much disliked by farmers.	Early flowering rush . . . . . Flea rush, Fica sedge . . . . .	Wet heaths and poor meadows. Boggy meadows and wet elevated places.
Centauria calcitrapa . . .	Star knapweed, blue bottle, and star thistle.	Barren meadows.
Chenopodium album . . . . . Chrysanthemum leucanthemum . . . . .	White goosefoot . . . . . Common ox-eye or greater daisy, moon flower.	Injurious weed. Dry pastures and walls.
Chrysanthemum segetum . . .	Corn marygold, or yellow ox-eye, goulans.	Sandy soil.
Cnicus arvensis . . . . .	Creeping plume or cursed thistle.	Injurious weed.
Cnicus palustris . . . . . Crepis tectorum . . . . .	Marsh plume thistle . . . . . Smooth hawkbeard . . . . .	Wet clayey pastures. Walls, roofs, pastures.
Digitalis purpurea . . . . .	Foxglove . . . . .	Dry, gravelly, and sandy soils.
Draba verna . . . . .	Whitlow-grass, nailwort . . . . .	Walls, dry places.
Erica vulgaris . . . . .	Common heath, ling, hether . . . . .	Heaths, woods, commons.
Euphrasia officinalis . . . . .	Common eyebright . . . . .	Heaths, dry barren meadows.
Galium verum . . . . .	Yellow ladies' bed - straw, cheese rennet, yellow goose-grass.	Dry hilly pastures.
Glechoma hederacea . . . . .	Ground-ivy, catsfoot, alehoof, tuchoof.	Shady places.
Guaphalium Germanicum . . . . .	Common cudweed, chafe-weed.	Barren meadows.
Hypochoeris glabra . . . . .	Smooth catsear . . . . .	Sandy, gravelly soils.
Jasione montana . . . . .	Hairy sheep-scabious, scabious sheep's-bit.	Very dry situations, sandy barren fallows, pastures, meadows, and heaths.
Juncus campestris . . . . . and others of the same family.	Rush, sieve . . . . .	Wet poor soil generally.
Ononis spinosa . . . . .	Cammoek, petty whin, ground furze, rest harrow.	Barren pastures.
Onopordium vulgare . . . . .	Wild earline thistle . . . . .	Dry meadows and pastures.
Plantago media . . . . .	Hoary plantain, lamb's lettuce.	Grows on good and bad soil, when in large quantities it prevents better herbage from growing.
Potentilla aserina . . . . .	Silver weed . . . . .	Low places and lands, which are subject to winter floods.
Potentilla fragaria . . . . .	Barren strawberry . . . . .	Dry, barren, stony places.
Primula veris . . . . .	Cowslip . . . . .	Strong land, clayey soil.
Primula vulgaris . . . . .	Primrose . . . . .	Woods, thickets, and heaths, clayey soils.
Rhenanthus Christi galli . . . . .	Yellow rattle, penny grass, coxcomb, henpenney.	Meadows and pastures.
Rumex acetosella . . . . .	Sheep's sorrel, or dock . . . . .	Sandy meadows, pastures, gravel-walks.
Spartium scoparium . . . . .	Common broom . . . . .	Dry pastures.
Tussilago farfara . . . . .	Coltsfoot . . . . .	Moist, stiff, clayey soil, limestone rubbish.
Thymus serpyllum . . . . .	Wild thyme . . . . .	Heaths, and barren elevated places.
Ulex nanus . . . . .	Furze, gorse, whins . . . . .	Barren commons.
Verbascum nigrum . . . . .	Black or sage-leaved mullein, claf's tail.	Sandy dry lands.

NATURAL GRASSES which are Indications of Barrenness by reason of their electing to grow on dry, sandy, elevated, or on wet, damp, peaty, boggy soils, and on which Soils the Natural Grasses which constitute the principal portion of our best Meadows and Pastures refuse to grow or remain permanent, even when sown on them.

BOTANICAL NAMES.	ENGLISH AND LOCAL NAMES.	OBSERVATIONS.
<i>Agrostis vulgaris</i> . . .	Common or fine bent grass . . .	Dry heaths and pastures. Disliked by cattle. Limit of elevation, 2000 feet above the sea.
<i>Agrostis canina</i> . . .	Brown bent grass . . .	Poor wet peaty soil in patches.
<i>Agrostis alba</i> . . .	White-rooted bent grass . . .	Dry sandy meadows and pastures. Limit of elevation, 2000 feet.
<i>Agrostis repens</i> . . .	Creeping-rooted bent grass . . .	Clayey soils; a troublesome weed. Its root is called couch.
<i>Agrostis stolonifera angustifolia</i> . . .	Narrow-leaved creeping bent grass . . .	Sides of ditches, clayey soils. Limit of elevation, 2000 feet.
<i>Agrostis palustris</i> . . .	Marsh bent grass . . .	Damp, shady, stagnant places. Limit of elevation, 2000 feet.
<i>Agrostis stricta</i> . . .	Rock bent grass . . .	Damp boggy soils.
<i>Aira aquatica</i> . . .	Water hair grass . . .	Grows only in wet muddy places, ditches. Limit of altitude, 500 feet above the level of the sea.
<i>Aira cæspitosa</i> . . .	Tufted hair grass . . .	Very coarse, and seldom eaten by cattle. Grows in large tufts called rough-caps. Limit of elevation, 1500 feet.
<i>Aira flexuosa</i> . . .	Wavy mountain hair grass . . .	Heaths, and hilly places. Limit of elevation, 3500 feet.
<i>Aira cristata</i> . . .	Crested hair grass . . .	Dry pastures, and on rocks. Limit of elevation, 1500 feet.
<i>Alopecurus agrestis</i> . . .	Slender foxtail grass . . .	Black bent of the farmers. It is difficult to get rid of, and is troublesome amongst wheat.
<i>Alopecurus geniculatus</i> . . .	Floating foxtail grass . . .	Wet clayey soils, pools, ditches. Limit of elevation, 2000 feet.
<i>Briza media</i> . . .	Common quaking grass, dodder. <i>Doddering Toms.</i>	Poor soils; manure is said to injure it. Limit of altitude, 1500 feet above the sea.
<i>Bromus sterilis</i> . . .	Barren brome grass. <i>Drank</i>	Dry sandy soil, under hedges, and in shady places. Limit of altitude, 600 feet.
<i>Bromus mollis</i> . . .	Soft brome grass . . .	Poor exhausted pastures. Limit of elevation, 1000 feet.
<i>Festuca ovina</i> . . .	Sheep's fescue grass . . .	Dry sandy soils. Favourite food of sheep on downs and wolds. Limit of elevation, 4000 feet.
<i>Festuca vivipara</i> . . .	Viviparous fescue grass . . .	Elevated light sandy soils.
<i>Festuca rubra</i> . . .	Purple fescue . . .	Sandy places. Frequent near the seashore.
<i>Festuca dumetorum</i> . . .	Wood fescue . . .	Cattle refuse it. Damp woods, soft shady places. Limit of altitude, 1000 feet above the sea.
<i>Festuca myurus</i> . . .	Wall fescue . . .	On walls and dry barren places.
<i>Festuca glabra</i> . . .	Smooth fescue . . .	Moist pastures.
<i>Hordeum murinum</i> . . .	Wall barley . . .	Dry light soils under walls. Limit of elevation, 500 feet.
<i>Holeus lanatus</i> . . .	Woolly soft grass . . .	Shady banks, woods, moist pastures of a peaty nature. Limit of altitude, 1500 feet.
<i>Holeus mollis</i> . . .	Creeping soft grass . . .	Impoverishing to the soil, and a troublesome weed. Light sandy soil; not eaten by stock. Limit of elevation, 1500 feet.
<i>Hedysarum onobrychis</i> . . .	Wild sainfoin . . .	Dry, barren, chalky pastures.
<i>Melica cærulea</i> . . .	Purple melic grass . . .	Damp heathy places, moors on or near peat bogs. Limit of altitude, 1500 feet.
<i>Nardus stricta</i> . . .	Upright mat grass . . .	Dry moors and heaths. Limit of altitude, 4000 feet.
<i>Phleum pratense minus</i> . . .	Minor meadow cat's-tail grass . . .	Stiff tenacious land.
<i>Poa alpina</i> . . .	Alpine meadow grass . . .	Wales, and elevated places in the North of England. Limit of altitude, 3000 to 4000 feet.
<i>Poa compressa</i> . . .	Flat-stalked meadow grass . . .	An early grass, but very short produce. Limit of altitude, 3000 feet.

The tribe of mosses are indications of barrenness.



AGRICULTURAL WEEDS  
NAMED IN M<sup>r</sup> BRAVENDERS'S ESSAY  
ON THE  
BARRENNESS OR FERTILITY  
OF SOILS.

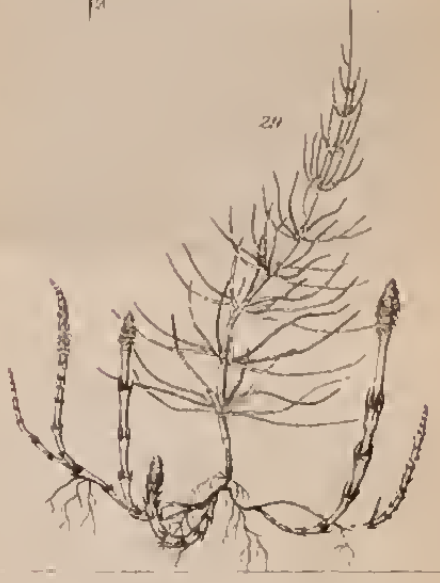
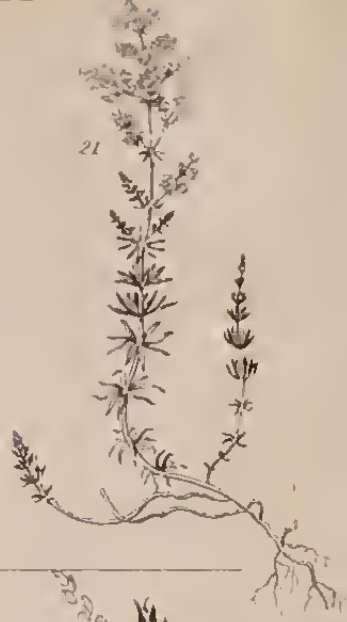

The following is a List of some of the weeds which are frequently troublesome, and occupy so much of the surface as to render the produce of the farmer's crop of little value. Excepting those which are enumerated in other schedules, they cannot be taken as indications of either barrenness or fertility; most of them are not very particular in the choice of soil. They are, with some exceptions, found on all kinds of soils, and the only indication that may be worthy of consideration is the difference in the state of their growth. They will appear stronger and more luxuriant on fertile than on barren soils. Some few may not often be found on barren soils, and others not on fertile lands, but the majority will grow on either. They are introduced here as temporary indications of barrenness, with the view of encouraging the farmer to engage in a universal war with them, until he finally extirpates them from his soil altogether.

BOTANICAL NAMES.	ENGLISH NAMES.	BOTANICAL NAMES.	ENGLISH NAMES.
1. <i>Agrostemma githago</i>	Cockle, corn campion.	24. <i>Chrysanthemum leucanthemum</i> .	Ox-eye daisy.
2. <i>Bellis perennis</i>	Common daisy.	25. <i>Chrysanthemum segetum</i> .	Corn-marigold, gools, gou-laus.
3. <i>Fumaria officinalis</i>	Common fumitory.	26. <i>Polygonum convolvulus</i> .	Black bindweed.
4. <i>Convolvulus arvensis</i> .	Corn bindweed.	27. <i>Cnicus arvensis</i>	Creeping plume-thistle, small purple thistle.
5. <i>Galium aparine</i>	Hariff, cleavers, goose-grass.	28. <i>Ranunculus arvensis</i> .	Horse-gold, corn buttercup, frogwort.
6. <i>Papaver rhœas</i>	Corn poppy, cop rose, red weed, blinders.	29. <i>Equisetum arvense</i>	Corn horse-tail.
7. <i>Rumex obtusifolius</i>	Broad-leaved dock.	30. <i>Centaurea cyanus</i>	Bluc-bottle, knapweed, hurt sickle.
8. <i>Rumex crispus</i>	Curled dock, clover dock.	31. <i>Sinapis arvensis</i>	Charlock, wild mustard.
9. <i>Senecio vulgaris</i>	Groundsel.	32. <i>Tragopogon pratensis</i> .	Yellow goat's beard.
10. <i>Tussilago petasites</i>	Common butter bur.	33. <i>Mentha arvensis</i>	Corn-mint.
11. <i>Tussilago farfara</i>	Coltsfoot.	34. <i>Holcus avenaceus</i>	Tall, oatlike, soft grass.
12. <i>Stellaria media</i>	Chick-weed.	35. <i>Agrostis stolonifera angustifolia</i> .	Surface twitch, narrow-leaved bent grass, red robin.
13. <i>Alopecurus agrestis</i>	Black bent spear grass, slender foxtail grass.	36. <i>Senecio Jacoba</i>	Common ragwort, segrum St. John's wort.
14. <i>Carex</i>	Sedge, carnation grass.	37. <i>Centaurea nigra</i>	Common black knapweed, hard heads, horse knops.
15. <i>Anthemis cotula</i>	Mayweed or mattheru, stinking camomile.	38. <i>Conyza squarrosa</i> .	Ploughmau's spikenard.
16. <i>Agropyrum repens</i>	Couch, squitch, quicks, wicks.	39. <i>Lolium temulentum</i>	Darnel.
17. <i>Carduus arvensis</i>	Saw-wort, common field-thistle.	40. <i>Avena fatua</i>	Wild oats, haver.
18. <i>Heraclium sphondylium</i> .	Common cow-parsnip, hog-weed.	41. <i>Bromus secalinus</i> .	Drank, smooth brome grass.
19. <i>Allium vineale</i>	Crow garlic.	42. <i>Ouonis arvensis</i>	Rest-harrow, cammock, petty wlin.
20. <i>Hippuris vulgaris</i>	Mare's-tail.	43. <i>Carduus acaulis</i>	Dwarf thistle, stemless thistle.
21. <i>Galium verum</i>	Cheese rennet or rennet, yellow ladies' bed-straw.	44. <i>Centaurea calcitrapa</i>	Star-thistle.
22. <i>Sandyx pecten Veneris</i> .	Crow needles, shepherd's needles.		
23. <i>Rumex acetosella</i>	Sheep's sorrel, or dock.		

The following is a LIST of a few of our TIMBER TREES, with the kinds of Soils which they are partial to, or on which they flourish most; and, in consequence, their appearance and condition may become indications of Fertility or Barrenness.

BOTANICAL NAMES.	ENGLISH NAMES.	LOCALITY, SOIL, SITUATION, &c.
<i>Acer</i>	Sycamore.	Sandy lightish soil; but is found on rich soil in or near villages.
<i>Acer (campestris)</i> .	Maple	Deep sandy soil, and deep soil, on a strong subsoil.
<i>Alnus</i>	Alder	Wet boggy places, low marshy land. Used in Herefordshire for hopenoles.
<i>Betula</i>	Birch	Light, moist, sandy soil.
<i>Corylus</i>	Hazel-nut.	Deep sandy soil, and on lands moderately fertile.
<i>Fagus</i>	Beech	Thin, elevated, calcareous soils in woods. Flourishes singly when planted in fertile soil.
<i>Fraxinus</i>	Ash	Deep soil, inclined to be sandy, but of a medium character. Flourishes on the inferior oolite, the lower portion of which is a fertile soil.
<i>Juglans</i>	Walnut	Dry loamy soil of a medium character, and on rich fertile soil.
<i>Larix</i>	Larch	Thin, dry, rocky soil.
<i>Populus</i>	Poplar	Wet boggy land, and on wettilsh lands of a medium character.
<i>Pinus</i>	Pine	Light, dry, rocky soil.
<i>Quercus</i>	Oak	Deep, strong, fertile land, with clay subsoil.
<i>Salix</i>	Willow	Low wet places. By the sides of brooks in rich soil.
<i>Ulmus</i>	Elm	Deep rich loam, and near farm yards, where the ditches contain the liquid that escapes from the dunghills.

*Indications of Fertility.*

From repeated observations I long since satisfied myself that, in the vegetable creation, there are certain plants which spontaneously grow and flourish on certain soils which do not spontaneously grow and flourish on other kinds of soils differently constituted; and those plants, thus electing to grow or not to grow, are certain indications of the barrenness or fertility of the soil. To test the truth of this proposition became at once a matter of great importance, because I could easily see that it would require more than the simple belief of any individual to render it of any value, if true. I therefore resolved to follow up a series of observations on the quality and kind of herbage of all the lands I could spare time to visit, particularly the land of districts that were notorious for barrenness or fertility. Since the year 1825 the valuation of not less than 300,000 acres of land has come under my observation, situated on all kinds of soils, and on almost all the various geological formations; and, whenever practicable, such has been made the ground-work of my observations, and rendered subservient to the necessary proof of the before-named proposition. Where I found the normal value to be high, I anticipated that the land would be found to be fertile; and, on the contrary, where low, I expected to find the soil barren. I did not hesitate to adopt the extremes as the proper representatives for the time being of barren and fertile soil, then believing that land which was *high* must be *fertile*, and that which was *low* must be *barren*. After thus adopting the extremes, which had been fixed by parties whose experience and judgment in the value of land cannot be doubted, I visited the fields with the view of examining the herbage and geological character of the soil, and of ascertaining the names of the most prevailing plants and grasses. I very soon found that I had set myself a most difficult task, and, what was more serious than all, I was totally unable to master the difficulties I encountered at every step. For a while in many of my excursions I amused myself with observing the changes from barren to fertile, and the contrary. I did not long remain satisfied with what appeared to amuse rather than inform, but, after some consideration, determined to suspend all operations whatever for a more dry and severe undertaking, namely, the study of botany and geology.

Having in some few months made a little progress, and but a little, in those sciences, I resumed my pursuits with considerable zeal, and, by dint of perseverance, after about a dozen years' practice and observation, I at length succeeded, or thought so at least, in surmounting most of the difficulties that lay in my way. I commenced collecting together from a great variety of memorandums such observations as appeared to be of importance, and, after some trouble, succeeded in condensing them into something



like the shape they now have assumed in the tabular forms inserted in different parts of this essay.

Fertile arable lands are those which are so constituted and situated as to produce all the ordinary crops of the farmer in abundance, with the usual cultivation only. The vegetation on arable lands will be, or ought to be, unless such lands are fallow, the crops which have been sown upon them by the farmer, and cannot be depended upon as indications with safety. Their appearance may assist, but must not be considered to be sufficient. Soils of a medium and inferior quality, which are observed to produce as good crops as naturally fertile soils, are made to do so by cultivation, and their fertility is only apparent; and they must not, under the sense to which we have limited the term, be denominated fertile. Their fertility is due to cultivation, and not to natural causes. Considerable difficulty may here arise in distinguishing how far their apparent fertility is due to cultivation. The best tests are geological position, the subsoil, the natural herbage at the sides of the fields, the timber in the hedgerows, and the elevation above the level of the sea: the surface-appearances are altogether inadequate. Certain geological formations are ascertained to be more productive than others, and I have from observation satisfied myself that this is no vague theory; but, further, that some of the formations are composed almost entirely, with slight exceptions, of either barren or fertile soils. If so, what an important test we have hitherto neglected! And I imagine enough has been said to induce us to admit that the natural herbage and plants which may have elected to grow on the parts of the fields where the sward is untouched by the plough, will afford another strong proof of barrenness or fertility; and the stunted or luxuriant growth of the timber and the thorns in the hedgerows may also be a guide; and, lastly, at great elevations above the level of the sea but few corn-crops ever arrive at maturity, and are late in being harvested. Fertile soil always ripens its crops early.

The following is a Table, which has been drawn up from observations made during a series of years, commencing with 1826, and continued up to the present date. To exhibit it is only to show its imperfections, but I have had abundant opportunity of satisfying myself that it is calculated very materially to assist the judgment, and to afford information, if rightly applied, which cannot be drawn from any other source, not even from geology itself. It will be desirable to understand that it is not meant that any single species of the natural grasses, here tabulated, will, if found alone, be sufficient to warrant us in predicting a future abundant crop, but simply that its presence, wherever found, is an indication of fertility in the soil that produces it. It is well known that, to constitute a good permanent pasture, there must be a

great variety of grasses present: it is not necessary that there should be a combination of all the known kinds. I have selected about twenty of what appear to be the best, and in all fertile meadows they will all, or nearly all, be present in greater or less proportion; and also some grasses of an inferior kind, the presence of which, in small proportions, will be of great use to fill up vacancies that will arise amongst the stems of the superior kinds, especially such as come to perfection at different periods of the season. It may be proper to ascertain what proportion of the surface is occupied by the superior kinds; and if it is found that three-fourths, or more, are so appropriated, such fact will be a very strong indication of fertility.

There appear to be about 150 distinct species of natural grasses, which are natives of this country, none of which, if cultivated alone, is so productive as when associated with others. The number of these grasses, and other plants, found growing on a square foot of our best meadow-land is about 1100; and in water-meadows they are increased to about 1800.

It has also been observed, that the number of plants found growing on a square foot of arable land, laid down in the usual way with seeds, is about 80.

From this we very easily deduce that land in seeds, especially that which is to continue down for two years, is not so productive as old sward of the same quality of soil; and, that old sward-land is not so productive as water-meadow, possessing the same natural fertility. These are facts so self-evident that no one, I apprehend, will attempt to contradict them. Thus the number of natural-grass plants, found on any defined space, may be very fairly taken as an indication of fertility or barrenness. It is a very poor unproductive piece of old sward which does not produce as much fodder as is grown on a piece of second year's seeds.

NAMES OF PLANTS, HERBS, FLOWERS, &c., and of NATURAL GRASSES, which are indications of fertility, where they have elected to grow spontaneously, and where the grasses are observed to have usurped the greater portion of the surface.

BOTANICAL NAMES.	ENGLISH AND LOCAL NAMES.	BOTANICAL NAMES.	ENGLISH AND LOCAL NAMES.
<i>Anthemis cotula</i> . .	Stinking May-weed.	<i>Galium aparinc.</i> . .	Goose-grass. Cleavers. Har- ruff.
<i>Atriplex patula</i> . .	Fat hen.	<i>Leontodon taraxacum</i>	Dandelion.
<i>Carduus marianus</i> . .	Milky thistle.	<i>Polygonum lapathifolium.</i>	Pale-flowered persicaria.
<i>Cherophyllum sylvestic.</i>	Cow parsley, cudweed, or wild cheveril.	<i>Sonchus arvensis</i> . .	Corn sow-thistle.
<i>Chenopodium bonus Henrica.</i>	Good King Henry. Mercury.	<i>Sonchus oleraceus</i> . .	Common sow-thistle.
<i>Clematis vitalba</i> . .	Virgin's bower, or traveller's joy. Honesty. I have not noticed this plant in the northern counties.	<i>Senchus palustris</i> . .	Tall marsh sow-thistle.
		<i>Stellaria media</i> . .	Chickweed.
		<i>Urtica dioica</i> . .	Common nettle.

Fern, it will be observed, is omitted in this list.\*

Several others might be enumerated, but I have not succeeded in identifying them so as to get their proper botanical names.

\* The fern is a certain indication of a deep, silicious soil, that may be much improved by cultivation and management, but is not an indication of naturally fertile soil. In commons, wastes, and moor-land tracts, which are covered by heath and furze, it serves to point out the portions that are superior to the rest, and which are worthy of a man's first effort to reclaim such land.

NATURAL GRASSES, which are indications of Fertility by reason of their electing to grow on all the richest, best, and most fertile Pastures in England, and by their usurping the greatest portion of the surface of such Pastures.

BOTANICAL NAMES.	ENGLISH NAMES.	OBSERVATIONS.
<i>Alopecurus pratensis</i> .	Meadow fox-tail . .	This grass constitutes a large portion of the herbage of the best and richest pastures and meadows in England, and is very grateful to cattle.
<i>Anthoxanthum odoratum</i>	Sweet-scented vernal grass.	This grass forms a portion of the herbage on all soils. It is found rather abundant on wet lands. It does not appear to be a profitable grass to the farmer, but its presence is always pleasing, on account of the delightful odour it gives to newly-mown hay.
<i>Avena pratensis</i> . .	Meadow oat grass . .	This is not a very productive grass, but it is liked by stock, and forms a useful constituent, in company with others of a superior kind.
<i>Avena flavescens</i> . .	Yellow oat grass . .	Cattle are not very fond of this grass, but it is very useful in water-meadows. It is the best of the kind for the farmer.
<i>Agrostis stolonifera latifolia.</i>	Broad-leaved creeping bent or florin.	The root of this grass is a troublesome weed, and known as squitch. However, it appears to be an essential constituent in a smaller proportion of all fertile meadows, and is an excellent water-meadow grass, where the water issues from calcareous rock.
<i>Bromus arvensis</i> . .	Field brome grass . .	This grass is not very much relished by cattle, and it is found in all neglected pastures; and, although rather a coarse grass, its presence in small quantities need not be an object of complaint.
<i>Cynosurus cristatus</i> . .	Crested dog's-tail grass .	This grass is found in all good pastures, and seems to grow on all soils, but with different degrees of luxuriance. It appears to be more suitable for pasture than meadow to be mown.
<i>Dactylis glomerata</i> . .	Cocksfoot grass . .	This grass is very productive, and is not disliked by cattle. It will grow under trees, and its presence indicates clay to be a constituent of the soil.
<i>Festuca pratensis</i> . .	Meadow fescue . .	This grass is fond of a rich soil, and constitutes a large portion of the herbage of all our best sward-land, and is useful in water-meadows.
<i>Festuca duriuscula</i> . .	Hard fescue grass . .	This is an excellent grass for the farmer, and is grateful to stock. It is found to be an essential constituent of down pastures as well as of meadows.
<i>Holcus avenaceus</i> *	Tall oat-like soft grass .	This grass produces an abundant crop of rather light spongy hay, and is not very agreeable to stock; but will always be a desirable constituent, in moderate proportion, of all the best meadow-land.
<i>Hordeum pratense</i> . .	Meadow barley grass . .	This grass is not one of the best for the farmer, but in some soils it is very useful, where found in not too great a proportion.
<i>Lolium perenne</i> . .	Rye grass . . . .	This is a most excellent grass on lightish, sandy, chalky soils; and, for early spring-feed, is justly esteemed.
<i>Phleum pratense</i> var major.	Greater meadow cat's-tail grass.	This grass is rather coarse, but highly valuable in a due proportion, which should be rather small in comparison with some of the others named.
<i>Poa annua</i> . . . .	Annual meadow or Suffolk grass.	This grass is not productive, but is desirable as a constituent of pasture-land, forming the under crop. It is liked by stock.

\* The hay-crop of 1844, in the neighbourhood of Cirencester, is almost entirely composed of this grass, except that of water-meadows, which is principally the *Poa trivialis*. The *Holcus avenaceus* stood the extraordinary dry weather this season better than any other grass.—J. B.

BOTANICAL NAMES.	ENGLISH NAMES.	OBSERVATIONS.
<i>Poa trivialis</i> . . .	Rough-stalked meadow grass.	This is an exceedingly valuable grass, and flourishes luxuriantly on rich land in company with others. It forms the greater portion of the produce of the famous <i>Orchiston Meadows</i> in Wiltshire.
<i>Poa pratensis</i> . . .	Smooth-stalked meadow grass.	This grass is rather particular in its choice of situation, not relishing damp soils, but is an excellent constituent of dry meadows.
<i>Trifolium pratense</i> perenne.	Perennial red clover . .	Natural red clover is an essential constituent of all our best meadows and pastures in moderate quantities. Its absence is a matter of regret.
<i>Trifolium repens</i> . . .	White or Dutch clover . .	This plant is indispensable as a component of every pasture, and, where it abounds spontaneously, is an indication of the goodness of the soil; but its produce is not very great in meadows, and therefore a moderate proportion will be desirable, to leave room for more productive grasses.
<i>Vicia sepium</i> . . .	Creeping vetch . . .	This grass is very palatable to all kinds of stock, and is one of the most nutritive of pasture plants.

## IV.—ASPECT.

The aspect of land is believed to have a considerable influence over the produce of the soil; and, in consequence, if such belief be founded in reason, and I see nothing to the contrary, it becomes an indication of barrenness or fertility.

What is meant by the aspect of a piece of land is, not only its position or direction towards any point of the compass, by being narrower in one of its dimensions than in the other, but the slope, or elevation of one end above the other. If a field slope away towards the north (a gentle descent of four or five degrees is a very common angle), it is said to have a northern aspect; and, on the contrary, if another field slope, in the same manner, towards the south, the east, or the west, it is said to have a southern, eastern, or western aspect. Now it is well understood that the more directly the rays of the sun fall upon any land, the more powerful will be the effect upon vegetation. In consequence of land sloping towards the south, and thus causing the rays of the sun to fall on the surface more perpendicularly than on a level, or on land that slopes northward, we are led to believe that a southern aspect is favourable, and a northern aspect unfavourable. From repeated observations, we are so satisfied of the accuracy of this, that, in cases where the soil and herbage are of a doubtful character, we do not hesitate to state, that a northern aspect is sufficient to give a bias to the judgment, and, in such circumstances, becomes an indication of barrenness; and, generally, a south-eastern, south, south-western, or western aspect is a favourable

indication ; and a north-eastern, north, or north-western, unfavourable. Pasture-lands having a northern aspect are more subject to be overrun with moss than those of the same quality of soil having a southern aspect.

To what extent the several aspects become favourable or unfavourable indications must depend on the judgment of the party, but the degree of inclination, or slope, must not be great, not greater than about fifteen degrees, to be considered an indication of fertility. Soils of more elevated angle than this are always found to be thin and near the rock or subsoil, and, independent of aspect, are barren from causes of a more apparent character.

---

#### V.—ELEVATION ABOVE THE LEVEL OF THE SEA.

All lands, as far as my observation has extended, that are much elevated above the level of the sea, are to be denominated barren. There are very few, if any, naturally fertile fields at an elevation of upwards of 1500 feet above the sea. Very few of the native grasses, that constitute the herbage of fertile lands, will grow above that altitude. Some few may grow, or rather linger, but I scarcely know of one that flourishes so as to be of value to the agriculturist. And one grass alone, of superior kind and quality, mixed with those of an inferior description, is not sufficient to constitute a fertile pasture or meadow. When old sward-land is mown in such elevated situations the hay-crop is late and light, and a late crop, where spring-feeding is not practised, is always an indication of the barrenness of the soil.

Arable land, at a considerable elevation, and consequently much exposed, is never so fertile as land on a lower level. It requires very little discernment to discover that bleak and elevated countries are universally barren. I have for years observed that crops of any kind do not grow so luxuriantly and arrive at maturity at great elevations, where the soil is of a similar quality and texture as that of a much lower level. Wheat seldom ripens properly at an elevation of more than 1000 or 1200 feet above the level of the sea, with the common resources and management of the farmer ; and, in seasons when it does ripen, the sample is never so good as that grown on a level of not more than 500 or 600 feet above the sea.

The application of artificial manure, bones, town-dung, soil, &c., the practice of what is called "high farming," is known in some degree to remove this inconvenience, affording a striking proof that management and art combined will secure what unassisted nature denies us. This high farming, embracing the best modes of cultivation, is found to ameliorate the severity of

climate, and to place us, as it were, in well-cultivated districts, several degrees nearer the equator, and reduce the highest of our cultivated hills several hundred feet.

---

#### VI.—GEOLOGICAL SITUATION.

The geological character of the district in which lands are situated is also a criterion by which to judge of fertility or barrenness. From a long-continued series of observations, I have satisfied myself that certain geological districts, which are more accurately defined and more easy to identify than one would at first imagine, are composed, almost entirely, of fertile land, and others almost entirely of barren land. And it will be found on examination that where two differently constituted geological formations come in contact with each other, the land will be fertile at that point; and in many cases it extends for a considerable distance on each side of the junction. If this be the case, we have in geology, or at least in that information which is the result of a study of geology, a very powerful means of assisting the judgment. The limits of the different great geological deposits being so marked, and the general character and capability of the soil of each being so uniform, it would appear rather a matter of surprise that geology, and the immense body of information that the practical study of the science cannot fail to supply, have not hitherto been made use of as an important feature by which to judge of the barrenness or fertility of soils. I am aware it will require time and labour to obtain a sufficient knowledge of this science, so as to be of any use to the person attempting to apply it as a test; and it will require much more labour and time to master as much of botany as is absolutely necessary: but this will only show how absurd has been the practice of calling in the assistance of persons who have never spent five minutes of their lives in the practical study of either. To show how geology may assist in the important business of judging of the fertility or barrenness of soils, it will be necessary to give a cursory description of the principal strata, classified and geologically arranged, as they are naturally exhibited in the rocks and soils of Great Britain.

The rocks and soils of Great Britain have been classed under three general divisions, denominated the *Tertiary System*, the *Secondary System*, and the *Primary System*; and those have been subdivided into several series of formations, each containing a great number of alternating deposits, which have undergone a further subdivision by geologists, which we will proceed to notice, in a summary manner, without entering into minute details.

*The Tertiary System.*

The Tertiary System is subdivided into four portions, known by the name of deposits: 1, Alluvium; 2, Diluvium; 3, London-clay; 4, Plastic-clay.

1. *Alluvium*.—Alluvial deposits are accumulations of soil which have been carried away by the force of water down the existing rivers, and which have formed, and are forming, tracts of level land, at the junction of those rivers with the sea, or, on their banks, before they arrive at the sea.

The localities of alluvial deposits are numerous. All soils of this description that I have seen and examined are fertile. The principal of these are situated on the banks of the Esk, Derwent, Ouse, Trent, Humber, Thames, Avon, Wye, Monnow, Usk, Severn, including the Bristol Channel, on the Monmouth and Glamorgan coast, with numerous other localities.

The meadows are occasionally subject to damage by sudden floods happening in summer, not only by sweeping off the entire hay-crop, but sometimes before the hay is mown, by carrying over the lands considerable quantities of sand and small gravel, which becomes entangled in, and deposited amongst the grass, thereby rendering it harsh and difficult to cut; and, when mown and made, the hay is found to have lost its virtue, being little better, if so good, for fodder as straw.

It has been said that rivers running over or through a sandy soil, or silicious rock, will be very likely to produce an alluvial deposit of a barren character. I am not acquainted with a barren alluvial soil. The most likely rivers to produce a soil of this character are the Monnow and the Wye, in some measure assisted by the little whimsical Trothy. The Wye has its origin in the Silurian formation, well known for its barrenness, and takes its course through the silicious rocks of the old red sandstone. The entire course of the Monnow is over the same rocks; but these two rivers have formed at their junction a fertile meadow of considerable extent, known by the name of "Chippenham Meadow," close adjoining to the town of Monmouth. And there are others on the banks of those rivers that are much superior in fertility to the adjoining lands, and which do not fall very far short in their produce of those meadows on the Trent, Ouse, and Humber, which are formed of immense masses of putrid mud. Some of these alluvial deposits have been the work of ages, and in consequence of the materials forming them having been washed away from comparatively barren districts, it may appear singular that out of the ruins of barren materials a fertile soil should be formed. It may arise from a change in the mechanical structure of both, and a mixture of animal and vegetable matter. In a gradual

dissolution of any soil or rock, and the subsequent re-union, after a journey for miles through a country covered with vegetables, it would be impossible to avoid a mixture of this kind. The transported soil which forms Chippenham Meadow would be deposited there when the country was very thinly peopled, or we might easily suppose it to contain the essence of millions of dunghills floated down the stream. No doubt it contains the essence of many, which, together with vegetable matter and the dead carcasses of animals, mingled in a journey of some 150 miles by the Wye alone, may be sufficient to account for the fertility of the soil on the banks and at the junction of these picturesque rivers.

Some of the alluvial deposits in the rivers which run eastward are more recent accumulations, and some are now in a state of gradual formation. The richness of the soil of the more recently formed does not appear difficult to be accounted for. Ever since this island has been inhabited, the night-soil of all the villages and towns has been discharged into streams and rivulets, and all the urine, and a great deal of the best of the dung, from almost countless numbers of farm-yards in Great Britain, at present escape, and have done so for ages, into gutters, ditches, and streams of water, and those empty their contents into brooks and rivulets, and those into rivers, and the rivers again into estuaries. Here the great mass of floating manure is interrupted in its course by the rising tide and conveyed to the shores, and there deposited in the shape of mud. We need not wonder at alluvial deposits formed in this manner being universally fertile.

One large deposit of this kind is situated in the river Humber, about 20 miles eastward of Hull, and is known by the name of Sunk Island. This tract of land has been taken from the large estuary at the mouth of the Humber, apparently at three different periods. A considerable time must have elapsed since the first reclaimed portion was taken possession of by man. It has timber-trees growing upon it which appear to be nearly or quite a hundred years old, and at one time it formed a complete island, with the mainland at a distance of a  $1\frac{1}{2}$  mile or 2 miles to the northward.

About 40 years ago an embankment was made, running northward, from the eastern end of the island to the land, and another, extending westward, to meet the northern bank of the Humber, where there is a small harbour called Stone Creek, at the point where the drainage-water of the lands on a higher level is, by means of flood-gates, allowed to empty itself into the river. This large tract between the island and the northern shore of the estuary thus became reclaimed, and was laid out into several farms, possessing a soil of a most fertile description, much of the land scarcely exhibiting, after 20 years' tillage, any symptom of



benefit from the application of manure. About 10 or 12 years since another large tract, containing 1700 acres, was embanked, reclaimed, and cultivated, somewhat of a triangular shape, which was effected by making an embankment to extend from the eastern extremity of the part first reclaimed, in a north-eastward direction, to or near to a small inlet called Patrington Haven. The whole of this land, containing about 6000 acres, is undoubtedly an alluvial deposit, and forms an exceedingly productive soil. It is sometimes rather difficult to cultivate, and requires a powerful team to plough up the seeds and stubbles. It is customary with the farmers to fallow for wheat, and the fallows are very difficult to reduce to a fine state. After being baked in the sun until the clods become as hard as bricks, should a day or two of heavy rain ensue, the large lumps, which had resisted the pressure of the heaviest roller, melt and fall down, like slaked lime, into a fine powder. The land then becomes as easy to plough as the ash-heap, and does not readily run together and set on the surface.

2. *Diluvium*.—This deposit is found spread over almost all the other formations, in patches of variable extent; but the greatest portion of it is found on the tertiary formation. It consists of large quantities of sand, gravel, and rubble, apparently the broken-down portions of all, or most of the known geological formations, and is often found near to the rocks from which it has, by the action of water and the influence of the atmosphere, become separated. It varies in some degree with the character of the parent rock, and is observed frequently to ameliorate the texture of the clay soils where it is found, and actually to render soils which would produce only beans, wheat, and broad clover, capable of producing any crop the farmer may wish to cultivate: but without cultivation this soil cannot be said to be generally fertile. The arable is easy to cultivate; the pasture generally produces poor, unprofitable herbage, and is liable to suffer from drought in dry seasons.

There is a large quantity of this soil in Norfolk and the adjoining counties, which is proverbial for being naturally poor and barren, but which is very much improved by cultivation. The diluvium on the lias and Oxford clay, when deep and not too gravelly, is very productive. The towns of Cheltenham in Gloucestershire, and Cricklade in Wiltshire, are situated on diluvium, and I do not know of *better* land anywhere than some in the neighbourhood of those towns.

3. *London Clay*.—This division of the tertiary series is composed of a strong clay, which is chiefly of a bluish-brown colour, but varies, like all other clay formations, and appears sometimes to be yellow or grey. It forms a very wet, tenacious soil, and in

consequence the arable generally is difficult and expensive to cultivate. There are exceptions, where the clayey soil is mixed with sands, so as to form a loam, and where a considerable depth of soil, created by the decomposition of vegetable matter, has accumulated. In such circumstances the soil is very fertile.

The pasture-land is generally very good and fertile, probably made so by artificial means, and by an accumulation of soil on the surface, assisted by a long-continued application of manure. The subsoil being clay, this deposit would have been as barren as any other of the clay formations, without the deep covering of mould, or artificial or natural mixture of sand, and other ameliorating substances, which are generally found on the surface.

4. *Plastic Clay.*—This division of the tertiary series is composed of deposits of sand, clay, rubble, and loam; the latter formed by a mixture of the two first mentioned. It is very variable in colour, assuming almost all the varied appearances of the rainbow.

Its texture is not uniform, because of the sands and clays alternating with and succeeding one another, sometimes one appearing at the surface, and then the other; in some places forming a wet tenacious soil, very expensive to cultivate, and in others a deep porous soil, possessing a considerable degree of fertility. In Dorset and Hants the sands of this deposit prevail, and there the soil is barren.

### *The Secondary System.*

The secondary system is subdivided into seven portions, known by the name of formations. It extends from the tertiary system westward, down to the old red sandstone, where it comes in contact with the primary system. The formations which compose the secondary system are—1. the Chalk; 2. the Wealden; 3. the Oolitic; 4. the Lias; 5. the new Red Sandstone; 6. the Carboniferous; and 7. the old Red Sandstone.

#### I.—The Chalk Formation.

The chalk formation is separated into four subdivisions, which, for convenience, we will call deposits:—1. the Upper Chalk; 2. the Lower Chalk; 3. the Gault Clay; and 4. the Green Sand.

1. *The Upper Chalk.*—The upper chalk is known by having horizontal layers of flint imbedded in it. The colour is white. The chalk-rock is generally near the surface, and covered by a very thin coat of mould. The pasture is principally *down*, and fed with sheep, producing but a scanty herbage, which, however,

is palatable to sheep. In some parts, where in arable, it forms a thin, dry, loose, hazel-coloured soil, and in the valleys a deep, dry, light chocolate-coloured soil, which, under the good management pursued on the chalk hills, produces good crops of barley, turnips, wheat, and sainfoin: not naturally fertile land.

2. *The Lower Chalk.*—The lower chalk is without the layers of flint. The colour is mostly white, or a dusky-white, but it varies, being in some districts red, yellow, and grey. The lower portions form what is called chalk marl. The soil is of a dark-grey colour, and in places is deep and adhesive, and expensive to cultivate. This soil is the most productive of any that I have seen, with the single exception of some alluvial deposits. The water-meadows are peculiarly productive. The whole of this deposit is naturally fertile. There are exceptions, but they may be shown to arise from causes unconnected with the mechanical structure or capability of the soil.

3. *Gault.*—This deposit is formed of a stiff blue, or dark-coloured clay, but it sometimes varies, so as to become yellow or brown. The gault is but a limited deposit, and does not extend farther north than the midland counties. It is very expensive to cultivate, and unproductive when not mixed with soils transported from other deposits. In the vale of the White Horse it forms some very good pasture-land. The gault is situated in the midst of the green sand, next described.

4. *Green Sand.*—This deposit consists of two parts, with a bed of clay between them. They are composed of greenish-coloured earth, mixed with sand and small rounded particles of chalk. The colour is variable, and frequently greenish-grey, but sometimes yellow, brown, grey, orange, red, and mixed or mottled, or arranged in alternate streaks. The green sand is not always visible under the chalk, being overlaid and hid by it. This deposit is naturally fertile. It forms a friable, deep, rich soil, and produces every kind of crop in the greatest luxuriance. Exceptions, however, might be pointed out. It forms a barren soil in two or three places in England, especially where it extends to a greater breadth than usual.

## II.—The Wealden Formation.

The Wealden formation is limited in its extent, is situate between what are called the North and South Downs, and is subdivided into four deposits:—1. Wealden Clay; 2. Hastings, or Iron-Sand; 3. Ashburnham Beds; 4. Purbeck Beds.

1. *Weald Clay.*—This deposit is a stiff blue clay, varying in colour, in some places appearing of a whitish fawn-colour, in others possessing a deeper yellow shade, and sometimes is formed of a mixture of colours. The rock found in it is a shelly lime-

stone, called Sussex marble. Its consistency is that of soap when cut by the plough, and in consequence it is difficult and expensive to cultivate as arable, and the pasture is wet and poor.

2. *Hastings, or Iron-Sand*.—This deposit consists of sands and sandstones, alternating with clay and limestone. It has been called “iron-sand” from its ferruginous brown colour.

3. *Ashburnham Beds*.—These beds are composed of clays, shales, and bluish-grey limestones and sandstones.

4. *The Purbeck Beds*.—These are composed of clays, sandstones, and shelly limestones, called Purbeck marble. In this deposit layers of vegetable mould are found, and the stumps of trees in a vertical position.

Considerable tracts of land on the three last-named deposits, being unmingled with soils of a tenacious tendency, are covered with heath and furze, and are consequently barren.

### III.—The Oolitic Formation.

This is the next below the chalk, where the Wealden is deficient, and forms a broad belt of elevated land running through the centre of England, from the Isle of Portland to the north of Scarborough, in Yorkshire. It has a great many subdivisions, the principal of which we shall enumerate:—1. Upper Oolite; 2. Kimmeridge Clay; 3. Coral Rag; 4. Oxford Clay; 5. Cornbrash and Forest Marble; 6. Great Oolite, Stonesfield Slate, and Fuller’s Earth; and 7. Inferior Oolite.

1. *Upper Oolite*.—This deposit is not a continuous one, being overlaid by others, and hid from observation. It consists of Portland and Aylesbury rock, and has partings of sand and even clay, so as to be quarried for building-stone, and for clay and sand for brick, at the same time, which has been made and burnt in the quarry. The soil is light and sandy, and easy to cultivate. In damp seasons it produces excellent crops of corn; but the pasture is poor and unproductive.

2. *Kimmeridge Clay*.—This deposit is a stiff blue clay, very tenacious and retentive of water, and very difficult and expensive to cultivate. It is made, by cultivation, to produce good crops, but is naturally unproductive, without a deep covering of mould. Where this occurs, the old sward is good. The extensive embankment near Swindon, on the Cheltenham and Great Western Union Railway, where a very troublesome slip took place soon after the line was opened, is situated on this formation, and was caused by its extreme retentiveness of, or solubility in, water.

3. *Coral Rag*.—This deposit forms a nice clean, light, arable soil, but is not particularly fertile. Most of it is easily made so by cultivation. The pasture is poor and unproductive in its

natural state. The coral rag is well developed at Pusey, in Berkshire, on the estate of Philip Pusey, Esq.

4. *Oxford Clay*.—This is a well-defined deposit, consisting of a dark, sometimes yellowish, tenacious clay, which is very difficult and expensive to cultivate; and, where it is not mixed with diluvial sands and gravel, it is barren. In the midland counties—at Braydon in Wiltshire, and at Longworth in Berkshire—it is found in this state, without any great depth of mould, and, of course, is barren; but in Oxford, Gloucester, and Wilts, a great portion of the land, both arable and pasture, is fertile. There are portions of land to be found, in this deposit, with several feet in depth of a dark brown loam, on the top of the subsoil of this clay, and such lands are known to be very productive. Some of the old sward-land in Gloucestershire and Wilts, having a soil of a considerable depth of decomposed vegetable matter, on the top of a diluvial soil, with this clay and the lias clay for subsoils, is known to be as good as any land in England.

5. *Cornbrash and Forest Marble*.—The cornbrash is a coarse shelly limestone. The forest marble is composed of beds of limestone, alternating with thin partings of clay; sometimes the limestone is found in thin beds, forming planks and rough paving-stone, and sometimes slates. The soil of this deposit is of a good quality, with some exceptions, but is apt to be injured by wet. The land is variable. The thin beds of clay sometimes disappear, and a thin rubbly soil forms the surface, and then a thin clay bed again. These alternate exhibitions of clay and rubbly soil at the surface, render the land wet and unproductive, and, in some cases, expensive to drain: but where they do not appear to come to the surface, and succeed one another so rapidly, whole fields of productive land are met with. With the usual management, the whole may be considered to be fertile, rather than otherwise. A little more draining would remove the doubtful character of this soil, and it might then be ranked with those of a fertile description. This is the prevailing kind of soil in the neighbourhood of Cirencester.

6. *Great Oolite, Stonesfield Slate, and Fuller's Earth*.—This deposit forms an immense mass of calcareous limestone and free-stone. The Bath building-stone forms a part of it. A slight portion on the eastern side, which adjoins and comes in contact with the clays of the cornbrash and forest marble, is occasionally found to be fertile.

The whole surface of this series of deposits is barren, with very few exceptions. A single field, situate in a hollow towards the eastern range, may be found here and there, to which the term barren would scarcely apply. Generally, the soil is light and thin,

and towards the western extremity attains a considerable elevation above the sea. Thus, in addition to being light, the land is much exposed to easterly winds.

7. *Inferior Oolite*.—This deposit is composed of a coarse shelly limestone, with ferruginous sands and sandstones, and is of a darkish brown colour, and very porous. The soil on the lower beds of this rock is dry and healthy, deep and fertile. It is particularly so where it comes in contact with the lias below. Its position is generally very favourable, forming a slope towards the west.

#### IV.—The Lias Formation.

The lias formation is the next, in a descending order, to the extensive oolitic formation; and it follows on the western side, through all its windings, from Lyme Regis in Dorset, to Whitby in Yorkshire. It is subdivided into four deposits:—1, Upper Lias Shale; 2, Lias Marls; 3, Lower Lias Clay and Shale; and 4, Lias Rock; forming a series of laminated limestones, with partings of clay.

1. *Upper Lias Shale*.—This deposit is mostly covered with the soils and diluvium of the lower oolite. It is in colour and appearance like a schoolboy's slate, of a dark purple, or blueish purple colour. Where not covered with the diluvium, as above named, it forms a poor, tenacious, unproductive soil. Where the diluvium, which is rather extensively scattered over the upper members of this formation, occurs in sufficient depth, or where there is a considerable depth of decomposed vegetable mould, this soil is very rich and fertile, and forms some of the best old sward in the kingdom, being famous for producing excellent cheese.

2. *Lias Marls*.—This deposit partakes of the qualities and character of the preceding. Sometimes the upper lias shale is covered by the debris of the inferior oolite, and this deposit is brought in contact apparently with it.

3. *Lower Lias Clay and Shale*.—This deposit forms a considerable portion of the vale of Gloucester; and where the clays are unmixed by decomposed vegetable matter, and not covered by soil formed of a mixture of sand and the lias clay to a considerable depth, the soil is barren; but where they are mixed, or possess a great depth of mould, no soil, that I am acquainted with, is more productive, either in the state of arable or pasture. The same observation will apply to all the four divisions of this formation.

4. *Lias Rock*.—A series of laminated limestones, with partings of clay, sometimes nearly white, whilst the clay is of a dark purplish blue. The rock burns into very excellent lime for architectural purposes, possessing the quality of setting under water.

## V.—The New Red Sandstone Formation.

This important formation is subdivided into upper and lower. It is the most extensive geological series of deposits in the kingdom.

1. *Upper New Red Sandstone*.—Sometimes called the saliferous system, because of its containing large quantities of gypsum, soda, and common salt. The soil consists, chiefly, of an unctuous clay, or red marl. In some parts of the formation it forms sandy tracts of land, and such, without cultivation, are barren; but by far the greatest portion is very fine rich meadow, or very fertile arable land. The crops on the red marl are always fine and of luxuriant growth.

2. *Lower New Red Sandstone*.—This division is separated into two portions, one forming the deposit called the magnesian limestone.

The magnesian limestone is considered excellent for architectural purposes, and is rendered notorious by having been selected to form the masonry of the New Houses of Parliament. The soil is thin, light, and dry, and the pasture-land barren. The arable is nice light working land, producing crops of a medium description under excellent cultivation.

## VI.—The Carboniferous Formation.

This highly valuable formation is subdivided into three series of deposits, called—1, Coal-Measures; 2, Millstone Grit; and 3, Carboniferous, or Mountain Limestone.

1. *The Coal-Measures*.—The coal-measures consist of shale, sandstone, and grit, with occasional seams of coal and layers of ironstone. The coal-measures, or coal-basins, as they are sometimes named, do not form a regular stratum extending across our island, like the chalk, the Oxford clay, the oolite, the lias, and the new red sandstone, but lie in detached beds, having mostly the magnesian above, and the carboniferous limestone below. The soil of these deposits is of a wet clayey description, producing herbage of an unproductive kind; and the arable, without very superior cultivation, is very poor and barren.

2. *The Millstone Grit*.—This deposit is composed of coarse quartzose sandstone, used for millstones, and often reaches a high elevation above the sea. It is very poor and unproductive, whether in arable or pasture.

3. *Carboniferous, or Mountain Limestone*.—This deposit is a calcareous rock, and is always present in the neighbourhood of coal-fields. The soil is very thin, dry, loose, and barren. The rock is perfectly naked in many parts of the kingdom, without vegetation of any kind, is situated at a great elevation above the

sea, is consequently very much exposed, and is cold, bleak, and barren.

### VII.—The Old Red Sandstone.

This formation is the lowest of what have been termed the secondary series. It occurs in Wales, Devon, Hereford, Shropshire, and is largely developed in Scotland. This soil is sometimes loose and sandy, and sometimes found to be rather a strong clay. It has a glossy appearance, and is excellent for the growth of hops. Generally it is very fertile.

On the lias, new red sandstone, and the old red sandstone, a large quantity of apples and pears is grown, and converted into cider and perry. A scientific friend of mine thinks, that fruit grown on the old red sandstone is superior in flavour to that of any other geological formation.

#### *The Primary Series.*

These rocks may be arranged under three different divisions—1, Silurian system of Mr. Murchison, the Cambrian and Cumbrian system of Professor Sedgewick; 2, the Metamorphic rocks; and 3, the Plutonic or melted rocks of Dr. Buckland.

1. *The Silurian, Cambrian, and Cumbrian*, are composed of slate-rocks, and embrace a considerable portion of Wales, and great part of Westmoreland and Cumberland. The land is elevated, cold and wet, and of little value, with some exceptions. It may safely be denominated barren.

2. *Metamorphic Rocks*.—These rocks are composed of several subdivisions, two only of which we shall notice—the mica-schist, and the gneiss. The mica-schist is barren. The gneiss is a kind of slaty granite, often highly metalliferous. The soil is barren.

3. *The Plutonic Rocks*.—The Plutonic rocks are composed of basalt and lava, which are fertile; serpentine, which is barren; sienite, which is fertile; and the granitic rocks, the soils of which are barren.

From the foregoing short and imperfect description of the geological strata of England, it will be easy to collect the following table, in which the prevailing properties of all the soils become distinguished, by being classed under three simple divisions—namely, *Clay Soils*, *Sandy and Rocky Soils*, and *Loamy Soils*. The last kind of soil will, as usual, embrace all the soils that appear to have been a natural mixture of the two former, in such proportions as have produced a decidedly beneficial effect. The first two are always naturally barren, and the last is always fertile.



SYSTEM.	FORMATION.	DEPOSIT.	PREVAILING QUALITY OF SOIL.		
			Clayey.	Sandy and Rocky.	Loamy.
Tertiary	.	1. Alluvial . . . . .	. . . . .	. . . . .	Fertile.
		2. Diluvial . . . . .	. . . . .	Barren.	Fertile.
		3. London clay . . . . .	Barren	. . . . .	. . . . .
Secondary	The chalk formation . . . . .	4. Plastic clay . . . . .	Barren	. . . . .	. . . . .
		1. Upper chalk . . . . .	. . . . .	Barren.	. . . . .
		2. Lower chalk . . . . .	. . . . .	. . . . .	Fertile.
	The Wealden formation . . . . .	3. Gault . . . . .	Barren?	. . . . .	. . . . .
		4. Green sand . . . . .	. . . . .	Barren?	Fertile.
		1. Wealden clay . . . . .	Barren	. . . . .	. . . . .
	Oolitic formation . . . . .	2. Hastings, or iron sand . . . . .	. . . . .	Barren.	. . . . .
		3. Ashburham beds . . . . .	. . . . .	. . . . .	. . . . .
		4. Purbeck beds . . . . .	. . . . .	Barren.	. . . . .
		1. Upper oolite . . . . .	. . . . .	Barren.	. . . . .
		2. Kimmeridge clay . . . . .	Barren	. . . . .	Fertile?
	Lias formation . . . . .	3. Coral rag . . . . .	. . . . .	Barren?	. . . . .
		4. Oxford clay . . . . .	Barren	. . . . .	Fertile?
		5. Cornbrash and forest marble . . . . .	Barren	. . . . .	Fertile?
		6. Great oolite . . . . .	. . . . .	Barren.	. . . . .
Fuller's earth . . . . .		Barren	. . . . .	. . . . .	
7. Inferior oolite . . . . .		. . . . .	. . . . .	Fertile.	
1. Upper lias shale . . . . .		Barren?	. . . . .	Fertile.	
New red sandstone . . . . .	2. Lias marls . . . . .	. . . . .	. . . . .	Fertile.	
	3. Lower lias shale . . . . .	Barren?	. . . . .	Fertile.	
	4. Lias rocks . . . . .	Barren?	. . . . .	Fertile.	
	1. Upper new red sandstone . . . . .	. . . . .	Barren?	Fertile.	
Carboniferous formation . . . . .	2. Lower do. . . . .	. . . . .	Barren?	Fertile.	
	Magnesian limestone . . . . .	. . . . .	Barren.	. . . . .	
	1. Coal-measures . . . . .	Barren	. . . . .	. . . . .	
	2. Millstone grit . . . . .	. . . . .	Barren.	. . . . .	
Primary	Old red sandstone . . . . .	3. Carboniferous or mountain limestone . . . . .	. . . . .	Barren.	. . . . .
		. . . . .	. . . . .	Barren?	Fertile.
	Silurian rocks . . . . .	. . . . .	. . . . .	Barren.	. . . . .
	Cumbrian rocks . . . . .	. . . . .	. . . . .	Barren.	. . . . .
	Metamorphic rocks . . . . .	1. Mica schist . . . . .	. . . . .	Barren.	. . . . .
		2. Gneis . . . . .	. . . . .	Barren.	. . . . .
Plutonic rocks . . . . .	1. Basalt . . . . .	. . . . .	. . . . .	Fertile.	
	2. Serpentine . . . . .	. . . . .	Barren.	. . . . .	
	3. Sienite . . . . .	. . . . .	. . . . .	Fertile.	
	4. Granite . . . . .	. . . . .	Barren.	. . . . .	

Most of the foregoing formations take a north and south range, and extend from the south and south-west to the north-east of the kingdom, so that any person taking a journey from Cardigan, in a straight line to the Forest of Dean, and thence to Gravesend at the mouth of the Thames, will pass over all those formations, with the exception of the Wealden, the Metamorphic and Plutonic rocks; which do not form regularly-developed strata, being found in England in detached portions of no very great extent. This table has been formed from a personal examination of all those formations, with the exception of the Plutonic rocks. It will be seen how far the object has been attained—namely, a classification of the soils, with regard to their fertility and barrenness. The classification of the rocks was accomplished, by following the same plan adopted to identify the natural grasses which are indications of barrenness or fertility—that of first ascertaining the opinions of others respecting certain lands, who could not be con-

scious of my proceedings, and then visiting the spot and examining into, and testing the truth of my preconceived notions, which had been derived from a consideration of the geological situation of the same land. It is true I was sometimes disappointed, on visiting the new red sandstone, the lias, the lower oolite, and chalk marl, to find here and there patches of barren land. In due time, however, I had the satisfaction to discover that those barren patches were few, and formed only a minor portion of the formation, which had been previously understood to be generally fertile. This table affords a condensed view of the nature of the soils of this island; but it must not be expected to be perfect. Such as it is, the result of the labour of years, it exhibits to what extent the efforts of a solitary and humble individual have succeeded in applying the science of geology, so as to make it subservient to this most important subject.

---

#### GENERAL INDICATIONS.

##### *Barrenness.*

The following may be considered to be indications of barrenness when a cursory view of any district or country is taken:—

Mountains, hills, moorlands, heaths, bogs, marshes, swamps, commons, downs, wolds, extensive beech woods; stone walls for fences, instead of quickset hedges; extensive plantations of Scotch and larch firs; stunted knotty-looking timber in the hedgerows; thorn trees of a considerable age standing here and there in an open country in the fields; extensive deer-parks; where mansion-houses and gentlemen's seats are thinly scattered over the country—(this is not intended to have any reference to new colonies, and countries but yet partially inhabited)—where stagnant water is abundant, and where temporary lakes are formed during autumn, winter, and spring; where very large flocks of sheep are kept, and scarcely any cattle, and but very few cows.

Where young beasts are bred and reared in large numbers, and afterwards annually sold off to the graziers of a richer country, for them to fatten and send to the market.

Where rabbits are numerous, and especially where warrens are formed.

Where bramble-bushes, furze, and black-thorns usurp a broad belt round the margin of the fields.

Where villages are thinly scattered over the country, being several miles apart.

Where ant-hills occupy a considerable portion of the surface.

Where the lapwing, plover, and curlew are numerous.

Where the wild-goose descends and feeds on the stubbles. On

the Yorkshire Wolds I have seen them follow the ploughman like rooks, but at a much greater distance.

Where large flocks of goldfinches are observed in the autumn. They assemble in great numbers on downs, warrens, &c., to feed on the seed of the thistle.

### *Fertility.*

The following may be considered to be indications of fertility when a cursory view of any district or country is taken :—

The absence of mountains, rocks, moorlands, bogs, heaths, marshes, swamps, wolds and downs, &c. Hills of gentle ascent and all cultivated, except small patches for ornament. Broad valleys, intersected by large rivers. The whole district thickly studded with timber trees in a flourishing condition. Small oak woods here and there, which have the appearance of having been introduced for ornament rather than to cover a barren spot.

Where the villages are thickly scattered over the country, and gentlemen's seats and pleasure-grounds are numerous, and also where the neat snug little villas of the merchant and retired tradesman are to be seen in tolerable profusion.

Where gentlemen's parks are small, and not fed by deer.

Where orchards are numerous, and the trees in a flourishing state.

Where water is plentiful, and springs, brooks and rivulets are numerous.

Where horned cattle are kept in large numbers, and particularly cows, for the purposes of a dairy.

Where oxen, bullocks, and beasts are grazed, to fatten for the butcher.

The foregoing observations constitute what I denominate general indications, and must only be considered as guides to a general conclusion. It often happens in this country, and I dare say in all others, that in the midst of a large district, the indications of which are such as lead us to believe it to be barren, there are smaller tracts, frequently embracing whole farms, which are fertile lands; and, on the contrary, districts possessing general fertile appearances have, in the midst of them, considerable quantities of land which in reality are barren.

It would be difficult to say how far these general indications may be useful. In some parts of the country the farmer finds it more difficult to get a just opinion respecting one single arable field than to make use of something similar to the foregoing rules, to ascertain whether a whole district in general be barren or fertile; because the indications are not so obvious and plain; and when taken away from his immediate neighbourhood, and especially on to a different geological formation, he is greatly puzzled

to arrive at a conclusion that he dare confide in. This need not be a subject of wonder. He has always been led by surface-appearances, and the same surface-appearances that are favourable indications in one district may be, and are, unfavourable in another.

Farmers in general have hitherto been in the habit of judging of the fertility or barrenness from colour, consistence, and surface-appearances, the two former sharing more or less in the business, according to the extent of information on the subject possessed by the party. These things, it must always be understood, will materially assist us; but I think enough has been shown to demonstrate that, if relied upon alone, they are inadequate to the purposes for which they have hitherto been in use.

28th February, 1844.

---

XXXIII.—*Addition to Mr. Hannam's Paper on Sulphuric Acid.*

SINCE the foregoing article was written, my attention has been called to the experience of Mr. Tennant of Shields, near Ayr. The particulars of these experiments have, through the kindness of Mr. Campbell of Craigie, been forwarded to me, and I cannot, on account of the intrinsic value of the information which they afford us, omit to call special attention to them. Mr. Tennant's trials extend over *several years*, and during the present season have been on a scale of magnitude much greater than any which have yet been recorded—a better proof than any other that can be given of the satisfactory results of the earlier trials.

The following are the particulars politely furnished by Mr. Tennant himself:—

“After reading Liebig's work on agricultural chemistry, about four years ago, I resolved to try the experiment of using dissolved bones, and procured 26 bushels of bones, and 2 bottles of sulphuric acid, at 1*d.* per lb.; about 190 lbs. each. This mixture I applied to 9 acres of land, with 20 carts of dung per Scotch acre, and was highly satisfied with the result. Some drills on which I omitted the solution *appeared one-third deficient*; and one drill to which I gave a *double quantity* appeared to have nearly *double the weight of crop* to the row next it, which had no solution. The whole 9 acres were equal to the remainder of the field, which had farm-manure, and 1½ ewt. of Peruvian guano, at 26*s.* per cwt.

“The amount of dressing applied in the above trial was, therefore, about 3 bushels of bones and 42½ lbs. of acid per acre, costing about 1*l.* per acre.

“Next year (1843) I dissolved 200 bushels, and gave 5 bushels

per acre, upon 20 carts of dung, for turnips. The remainder of the field had 2 cwt of guano, with farm-manure. The crop was in both cases good: the dissolved bones having the advantage in bulk, and the guano in leaf, of any crop I grew the same year.

“ I also gave 60 bushels of bones dissolved to a fallow-field for wheat, and it appeared to do well. *The seeds* after the wheat were, however, *the best I ever had.*”

“ To 12 acres of grass-land I also applied about 2 bushels per acre, and it had a good effect, especially upon the clover.

“ This year (1844) I dissolved 600 bushels of bones, and applied it to turnips as before, and *the bulbs of the turnips grown upon it are very large.*”

“ Had not guano been discovered, the dissolving of bones would have been *already considered as an invaluable boon.* We consider guano at 6s. per cwt. and dissolved bones about equally cheap as an application; but think that the *bones excel* in producing *bulb.*”

To this conclusion of Mr. Tennant's I would only add that, should the supply of guano fail, the value of the solution will soon be appreciated. Whether or not, however, its value as an adjunct, or as a substitute for guano, is equally great. Indeed, this I find to be fully allowed in Scotland, where guano has become so generally, I may say universally, used and esteemed by all those who have experimented with it. Thus, I am told by Mr. Campbell, Mr. Finnie of Swanston, and several other eminent agriculturists, that the only question in the case now is the means of rendering the preparation and application of the mixture convenient to the farmer generally.

That this may be done I have already shown, and the more easily as it has been proved that it is by no means essential, or even necessary, that the *whole* of the particles of the bones—after being ground pretty fine before the acid is applied—should be dissolved; while the method of applying it is merely a matter of ingenuity and mechanical skill, which was never yet found wanting when called upon to meet an emergency, or to facilitate the application of any useful principle to practical purposes.

I am fully justified in this opinion, not only by the facts and arguments adduced in the foregoing pages, but, so far as relates to Scotland—where, I am free to confess, the motto of the farmer appears to be “ Ready, aye ready,”—so speedily is the force of a legitimate argument on matters pertaining to improvement *felt*, and the suggestion which it conveys made use of,—by what has already been done.

For instance, as regards the preparation, I am informed by Mr. Campbell that Mr. Tennant of St. Rollox, Glasgow, the proprietor of the largest chemical manufactory in the world, had stated

his intention of preparing and dispensing to the public the bones in a state of solution. Should Mr. Tennant carry out this intention, the south and west of Scotland may command a supply without inconvenience, and, I have no doubt, at an economical rate.

The means of distribution have also been considered; for example, the model of an efficient drill-cart for *manures in solution* was exhibited at the late meeting of the Aberdeen Agricultural Society.

On both points, however, the methods adopted by Mr. Tennant of Shields bear, and are worthy of attention, not only because they are matters of extensive experience, and refer, to use Mr. Tennant's own language, to "*an easy way of it,*" but because they point out a "way" which may be adopted in the event of the liquid form of application not being attainable, or in case of the compact form being preferred.

Mr. Tennant's practice is as follows:—"I put," says he, "25 bushels into three old boilers (of which every farm here has a supply), and next pour in 2 bottles of acid of about 170 lbs. each, and 36 Scotch pints (18 imperial gallons) of boiling water into each boiler. It boils away at a great rate for some time, and in a day or two we empty the boilers into two carts of light mould, and turn the mixture over. At this stage the bones are only partially dissolved, but they heat and decompose in the heap, after being turned over three or four times; and in the course of seven or eight weeks the compost becomes dry, and breaks down with a shovel in a state fit for spreading with the hand in the drill."

---

## MISCELLANEOUS COMMUNICATIONS AND NOTICES.

XI.—*Thin-Sowing of Wheat.*

## REPORT.

“ Report of the Deputation of the Maidstone Farmers’ Club, who were appointed, at the September meeting, for the purpose of visiting Mr. Hewitt Davis’s Farms in Surrey, and reporting to the Club on his general Agricultural System, and particularly that portion of it which relates to Thin-Sowing.

“ Mr. Davis having politely consented to receive the deputation, consisting of four members and the secretary, they proceeded, on Wednesday the 16th of October, to effect the object of their appointment. They met Mr. Davis at Spring Park Farm, about two miles from Croydon, who showed them over his farms.

“ Spring Park Farm consists of about 200 acres. The most striking feature observable on entering the land was the care that had been taken in grubbing hedge-rows, &c., to lay the land open to the influence of the sun and air. The soil of this farm consists of black sand and beach gravel, with a subsoil of white sand and gravel. The moor-pan formerly consisted of exceedingly hard conglomerate masses of gravel, and apparently ferruginous sand, some of which were so large as to require six horses to draw them off the field. They were very similar to what is called pudding-stone; and the soil is evidently, from its appearance, a very inferior one, and requires pressure to consolidate it. Previous to Mr. Davis’s occupation, a field, termed Starve Acre, from its unproductive quality, would scarcely grow anything; but under his management it has become the best on the farm, and has produced, with thin-sowing, no less than 5 quarters of wheat per acre. The whole of this apparently intractable land has been subsoiled, and a very large portion drained by Mr. Davis, who, although his lease has only five years to run, is now draining a further portion, 4 feet deep; the labour alone costing him 9d. per rod. So convinced is Mr. Davis of the value of draining, that he believes even this expense will be fully repaid to him. His practice is to lay the land in ridges, varying from 12 to 24 feet in width. The seed having been got in, he generally runs Smith’s (of Deanston) subsoil-plough down each furrow, between the ridges, even through the drained land.

“ With reference to the system of thin-sowing, the deputation had an opportunity of seeing the stubbles that were still remaining unbroken. The strength of the stubble-roots was remarkable, and they were found to

have tillered to from 8 to 10 stalks each. The next criterion for judging presented to the deputation was Mr. Davis's stack-yard, consisting of five large stacks of wheat, two of oats, two of buck-wheat, one of pulse, and three of hay. Besides these stacks, there was a barn full of pulse, and another of wheat and barley. The appearance of the crops was excellent. The straw was exceedingly strong, and the ear was very fine. The pulse crops were remarkably well podded. The wheat was the Essex rough-chaff, which Mr. Davis had been told could not be grown on the system of thin-sowing, as it had been said that thin-sowing produced mildew, a disease to which this sort was particularly liable. Mr. Davis states, however, that mildew is a disease that he has scarcely ever been troubled with.

“As the members may not all be aware of Mr. Davis's rotation, it is as follows:—

1st year . . .	Rye	{ For green meat and feeding-off with sheep, in April, May,
„	Tares	{ June, and July; and followed by
„	Mangold-wurzel	} With a liberal dressing of farm-yard dung.
„	Swedes . . .	
„	Cabbages . . .	
„	Turnips . . .	

2nd year . . . Oats or barley, sown with clover.

3rd year . . . Clover, twice mown for hay.

4th year . . . Beans or Peas { The beans have turnips drilled between the rows,  
and which come into feed in September and  
October.

5th year . . . Wheat.

“The quantities and periods at which he sows are the following:—

Rye . . . .	1½ bushels . . .	In August and September.
Tares . . . .	1½ „ . . . .	{ In three sowings, in August, Sep- tember, and October.;
Mangold-wurzel . . . .	6lb. . . . .	
Swedes . . . .	1 quart . . . .	In May.
Turnips . . . .	1 „ . . . .	In July.
Cabbages . . . .	1 every 3 feet . . .	In June.
Oats . . . .	7 pecks . . . .	In January, February, and March.
Barley . . . .	6 „ . . . .	In January, February, March, & April
Wheat . . . .	3 „ . . . .	In September and October.
Peas . . . .	8 „ . . . .	In December, January, and February.
Beans . . . .	8 „ . . . .	In September and October.

“Mr. Davis's rye and tares for green-feeding are sown in rows at 9 inches apart; all his white at 10½ or 12 inches; his pulse at 27 inches, as are also his root-crops and cabbages, on the ridge. The growing tares, winter beans, wheat, rye, and winter barley, also cabbages and turnips, had a very healthy and flourishing appearance. The general appearance of the winter barley and rye, for spring feed, which is now a few inches above the ground, would lead a person passing by to the conclusion that the usual quantity of seed had been sown, till on examination he would find that it consisted of separate vigorous plants, which had each tillered out some seven or eight stems.

“Mr. Davis's general system of growing turnips is that of planting double rows of turnips and cabbages alternately; a plan which has this advantage, that, however severe may be the weather, the sheep always find food in the cabbages, which, although they draw the ground more



than swedes, yet produce a much larger weight of food per acre. These swedes and cabbages, considering the soil and the season, were exceedingly good. The number of stock upon the farm was 14 cows, 1 bull, 200 pigs, about 30 colts and brood-mares, 300 fattening down-sheep on green crops and oil-cake, and 260 ewes in lamb. Mr. Davis uses the Kentish turn-wrest plough, Smith's subsoil-plough, and Finlayson's harrow. He has discarded the old dished wheels of his waggons and carts, and substituted for them others, nearly straight, for their lighter draught. He prefers the flail to the thrashing-machine. His cart-horses were all of the heavy Cleveland carriage-breed, about sixteen hands high, clean-legged, with strong bone, and of great activity. Mr. Davis has selected them from the job carriage-horses which are sold off in London at the end of the season. They cost him from 12*l.* to 20*l.* each.

"At Addington Farm the deputation had the opportunity of seeing Mr. Davis's wheat drilled, and a Kentish plough at work in an adjoining field, ploughing to the depth of 12 inches. This farm, though of nearly similar soil in other respects, is yet of better quality than that of Spring Park; but, before Mr. Davis took it, it had four tenants within seven years. Mr. Davis's system appeared to have been equally successful here as at Spring Park.

"Selsdon Farm, the property of G. R. Smith, Esq., however, offered the best criterion of Mr. Davis's mode of cultivation. Eleven years ago it was offered at 10*s.* per acre, tithe-free, and no one would hire it, only 8*s.* having been offered for it. It then consisted of a thin soil of about 5 inches upon the chalk, comprising 136 acres of arable land, with 120 acres of poor park-land. It never had had more than three stands for stacks in its stack-yard; there are now fourteen stands in this yard, which were last year filled, besides the barns. Mr. Davis has turned up 6 inches of pure chalk, which has all become disintegrated, and mixed with the soil; by this means he has been enabled to apply his system of rotation to it, entirely dispensing with fallows. On one of the fields—in which, under the old system, nobody would have thought of trying to grow tares or beans—is now to be seen a most luxuriant crop of cabbages and swedes; and the whole of the farm bears striking evidence of the great success of Mr. Davis's management, who states that he had of last year's growth fourteen large stacks and the barn full of corn, three stacks of clover-hay, and root-crops for the fattening of 200 wether sheep and 100 ewes with their lambs, besides 12 oxen.

"Healing Farm, which has been under Mr. Davis's management for only nine months, presents no point worthy of particular observation beyond those that have been mentioned with reference to the other farms, except the decided inferiority of the last year's wheat and straw, now being thrashed, as compared with those upon Mr. Davis's other farms.

"Perhaps the most remarkable feature observable in the farms which have had a fair trial of Mr. Davis's system, was the perfect cleanliness of the land.

"The leading features of Mr. Davis's system are, deep ploughing, early and thin sowing, and frequent cultivation between the drills; which system, as applied by him to the farms above named, the deputa-

tion feel themselves called on to state, appears to have been most eminently successful.

“The deputation cannot conclude without noticing in warm terms the very courteous manner in which they were received and attended to by Mr. Davis, and the great readiness with which he not only candidly and elaborately answered and courted every inquiry, but also devoted to them a day of his valuable time, where his motive could possibly have been none other than his desire to promote the public interest.”

Considerable conversational discussion followed the reading of this document, and the following resolution was unanimously agreed to:—

“That, in the opinion of this meeting, it is highly desirable, in a national point of view, that Mr. Hewitt Davis’s system of drilling and cultivation, as expounded in his pamphlet, and reported upon this evening by the deputation from this club appointed to inquire into it, should receive the serious attention of agriculturists, and should be tried as generally as possible by way of experiment.”

It was also unanimously resolved that the best thanks of the club were due to the gentlemen composing the deputation for the zeal with which they had devoted their time and attention to carrying out the wishes of the club. A vote of thanks was also directed to be communicated by the secretary to Mr. H. Davis, for the great courtesy with which that gentleman had received the deputation, and the pains he had taken to make them thoroughly acquainted with his system of cultivation.

---

## XII.—*On Grafting Turf.* By B. BAKER.

*To W. F. Hobbs, Esq.*

DEAR SIR,—You some time since requested I would give you an account of my mode of laying down arable land with turf; I now beg to observe there are two plans, one by small pieces of turf, the other by grinding it and sowing it on the surface of the land; the latter will sometimes succeed, but if the weather sets in dry the roots of grass wither, and disappointment follows. I have laid down above 100 acres. In the autumn of 1842 I laid down 13, which this summer produces more feed than any pasture in my neighbourhood. My plan is nearly the same as was recommended by the late Earl of Leicester:—first to make a good fallow, and then drill in wheat 9 inches apart; as soon as the wheat is up I have the turf ploughed out in strips, about 2 inches thick and 3 or 4 wide, from the best old pasture, a line of the pasture being left between each strip of turf taken away; the turf is then carted on to the wheat, if not wet, but if the carting injure the young wheat, I have the turf left on the headland, and men carry it on the land in baskets; it is then spread

about, and a man with a few boys tear the turf in pieces about 3 inches square, and lay it, 8 or 9 inches apart, between the rows of wheat; it is then trod in, which finishes the work. In the spring I sow 10 pounds an acre of white clover-seed—the first and second year I have always had plenty of feed, and the third year few people know it from old pasture. The price I pay is 8s. per acre for spreading, tearing, and laying the turf; and 4s. per acre for treading it in. In the autumn of 1842 the men offered to carry the turf on in baskets at 3s. per acre, but, as they often lost half a day's work in consequence of rain, I paid them 4s., at which price they earned good wages.

In one meadow of 8 acres I have taken nearly all the turf, with which I have laid down above 100; on some part of it I ploughed the turf five separate times, but by giving the meadow a coat of dung after the turf is taken away, and a good rolling *after a frost*, I find very little injury is done to the pasture.

Perennial grasses spread rapidly by the roots, and seed at various times during the summer, consequently you cannot collect the seed of each sort: they also like to congregate together. Sinclair found thirty-two distinct species of grass in one square foot of turf in the Vale of Aylesbury. I transplanted a square foot from my meadow into my garden, and during the following summer I found twenty-eight.

Landlords might very much improve their farms by getting their tenants to lay down in pasture, if only for a few years, some of their worn-out arable land, provided they have but an acre or two of good pasture from which to take their turf: I say good, for if a good herbage once takes possession of the land, it keeps out bad.

Believe me, dear Sir,  
Yours most faithfully,

*Maldon Hall, May 22, 1844.*

B. BAKER.

---

### XIII.—*On the Application of Sulphate of Ammonia to Wheat.*

By JOHN BARTON.

As the effect of any system of management can only be known by comparing the results of a great number of individual experiments, I venture to lay before the Society of Agriculture the result of an experiment just completed, on the application of Sulphate of Ammonia to wheat.

In a field of 6 acres, consisting of gravel of indifferent quality, worth perhaps 14s. or 15s. per acre, I sowed every other ridge, in the month of March last, with sulphate of ammonia: the whole quantity used was 5 cwt. During the first few weeks no difference was visible in the crop, but, as the spring advanced, the blades on the salted land became considerably darker in colour and more vigorous than the rest. Just before harvest I walked through the field with some agricultural friends, and we estimated the difference at 6 or 8 bushels per acre. As such estimates are, however, not to be depended on, I marked off two spaces of

20 rods each, and have this day caused the produce to be separately thrashed: the result is as follows:—

	Wheat.	Gals.		Straw.
	Bsh.	Gals.	.	lbs.
Salted land . . .	4	2	.	274
Unsalted . . .	3	6	.	232
Difference	0	4	.	42
This gives, per acre, 4 bushels of wheat, at 6s.				£. s. d.
,, ,, 3 cwt. of straw, at 1s.				. 1 4 0
				. 0 3 0
				£ 1 7 0
The 5 cwt. of Sulphate of Ammonia cost, including } carriage from London and expenses . . }				4 14 7
This being laid on 3 acres, gives the cost per acre .				1 11 6
Deduct difference of produce, as above . . .				1 7 0
Loss per acre . . .				£ 0 4 6

When wheat sells for 7s., instead of 6s. per bushel, the expense would just be covered by the increased produce. But, on the whole, the result of my experiment is, I think, in favour of the conclusion formed by Mr. Pusey, that these saline manures do not answer the purpose of the agriculturist.\*

I apprehend, however, that in estimating the value of these, and indeed of other manures, we are apt to confine our attention too much to the immediate results. Manures differ exceedingly as to the condition in which they leave the land in the year following the first crop. Of stable-dung it is estimated that one half is left in the land after a crop of wheat. As to some other manures (lime, for instance), it seems to be now admitted by the most accurate observers that they ultimately exhaust the soil, though they produce an immediate benefit. In fact, manures of this class act as *stimulants* merely; they bring into an active and soluble form the humus previously existing in the soil, but add nothing to the store of nutritive matter. Instead of leaving the land in better condition, they actually deteriorate it. That deterioration may indeed be compensated, or even more than compensated, by the immediate profit; the farmer may gain such an increase of crop as, if laid out in the purchase of manure, may place him and his land, on the whole, in a better position than if the stimulating manure had not been applied. But it must always be a most important question in what *way* does any given application tend to increase the produce of the soil? And when I see comparative statements of the crops yielded by different manures, without any notice of the tendency of such manures to benefit

\* Journal of Agricultural Society, vol. iii. p. 211.

or injure the soil in succeeding years, I cannot but fear that they tend to mislead many readers.

To which of these two classes do Nitrate of Soda and Sulphate of Ammonia belong? That is a question which I am myself unable to answer: but it is possible that some of the Members of the Council may be able to answer it; and if so I should be very thankful for such information. With regard to Guano, looking at its reported origin and its chemical composition, one can scarcely doubt that it enriches the soil; but its very caustic quality may raise a question whether a part of its beneficial effect does not arise from its stimulating properties. If so, its value cannot surely be truly estimated by comparing the increase of crop yielded by Guano and by yard-dung.

How might this question be brought to the test? Might it not be done by dressing a piece of land heavily, year by year, with Guano or other of these new manures; applying no dung to it, and cropping it in the usual manner? If the manure under trial operates as a stimulus merely, the land would be found, under this management, to grow progressively poorer every crop: if, on the contrary, it operates as nutriment, the land would grow progressively richer. But perhaps this experiment has already been tried.

I am, dear Sir,

Very truly yours,

JOHN BARTON.

*East Leigh, Emsworth,  
Aug. 13, 1844.*

#### XIV.—*On Socket Drain-Pipes.*

*To the Secretary.*

DEAR SIR,—When I had the pleasure of meeting you at Mr. F. Hobbs's I promised to send you some specimens of socket drain-pipes, as I make them in my yard. They are applicable particularly to loose springy soils, and cannot fail to be safe. Some persons prefer holes to be made in pipes; but they appear to me to be in all cases unnecessary. These pipes may be made of any length—the most convenient and useful is probably from 15 to 18 inches; and the cost of the socketing by the machine (I use Ford's patent) is from 2s. 6d. to 3s. 6d. per thousand. I have enclosed with the pipes a curious evidence of the facility with which the roots of trees will destroy drains, if carelessly placed. The mass of fibres are the roots of a willow-tree, growing about 5 or 6 feet from the drain, which had been put down only twelve months, and the pipe from which I took it was a four-inch socketed one.

I am sorry that thin one-inch pipes find advocates; they have no recommendation but cheapness, and must fail. In my judgment, as well as in that of many experienced drainers here, no pipe should have a less bore than 2 inches in the clear; and, in many cases, even for surface-draining, it should be larger; and it should possess substantial thickness, to give it durability.

On Wednesday last, so soon as the heavy rain of that day ceased, I

examined the outlets of a field of 18 acres of young clover, which was surface-drained, five years ago, 24 inches deep and 21 feet apart. The outlet, or discharging conduits, were fifteen in number, so that each had to carry the water from but little more than an acre of land; and yet the water from each of those outlets would have filled at least three one-inch pipes; and, if such small pipes had been used, every drain would have been blown.\* Upon fallow-land of the same description the water would have been discharged in even a larger volume.

I think the time is come for our Society to examine into this important question, for the purpose of giving to the public the best information on the subject in an early number. Two or three gentlemen, appointed for the purpose, should examine on the spot the different methods practised in different localities, as well as the materials used, the nature of soil, &c. I should be well pleased to see such a deputation here, where I think draining is done in a superior manner.

Yours faithfully,

HENRY DIXON.

*Witham, Nov. 18, 1844.*

XV.—*Experiments on the Use of old Hop-bines as Manure in Hop-Gardens.* By SIR JOHN TYLDEN.

*To the Secretary.*

SIR,—One of the great objects of a farmer ought to be to make as much manure as possible *at home*. Impressed with the great utility of this axiom, I send you the following experiment in support of it.

About this time last year I read an account of a vine-grower in Germany, who had manured his vineyard for several years with the cuttings of his vines; and it struck me that the same good might be obtained by using the old hop-bines in the hop-garden, instead of burning or otherwise wasting them, which is too generally the practice in Kent. I therefore (not being a hop-grower) requested Captain Pattenson, of Ibornden, in the Weald of Kent, a successful hop-grower, and one of my tenants in this neighbourhood, to try the experiment. I proposed that the bines should be cut or chopped in pieces of about 1 inch or 2 inches long, and either lightly dug at once into the soil, or laid up in heaps of about 4 or 6 bushels, and covered with earth for the winter, then spread abroad and dug in. The tenant had as many bines cut in November last as two men could cut with a common chaff-cutter in two days; half of these were dug in at once, the rest laid up in heaps and dug in in the spring of the year; by which time the bines had decomposed into a rich

\* It appears that each of these furrow-drains, if they were only fifteen for the whole length of the field, must have been 640 yards long. If inch-pipes had been used, the mischief apprehended would have been easily remedied by crossing them with two or three main-drains emptying in the side-ditches: a precaution useful in all drainage, but doubly so in drainage with narrow bores, because the damage from any stoppage is thus limited to a portion of the length of each drain.—Pn. P.

oily black compost. To part of each he put *half* the quantity of dung used in the other part of the garden, whilst to the other no dung was added. On looking over the hops just before picking commenced, *no difference* could be perceived where the bines were dunged or where manured with the cut bines; but, where both were put, the hops were better. So satisfied is my tenant with the saving that this will make that he means to cut all his bines this year.

I am just returned from a visit to Captain Pattenson, and the experiment on his ground is, if possible, more marked, because it was tried in a hop-garden which had been well dunged last year, but had received none this year—all looking well. He did not cut his bines till the spring, when he employed two women, who cut enough, or chopped them rather, with a bill, in three days to manure upwards of a quarter of an acre, at an expense of 5*s.* These were dug in at the usual time; and now there is a marked difference where the bines were put, the leaves being fresher and greener, the hops larger; and, the workmen say, at least 200 lbs. more per acre. He expects at least 800 lbs. per acre on this part, and 600 lbs. on the rest of the garden. So that, for an outlay of 5*s.* cutting, he will make this year not less than 4*l.*; the present price being 8*l.* per cwt. Surely this experiment is worth other hop-growers trying; and it is with this view that I send you the account now, as I think the greener the bines are cut the more weight will be got, and the easier the operation will be performed.

Now I am on the subject of manures I must mention that I have never tried anything for turnips at all equal to Lawe's super-phosphate of lime. I tried it on an old ley that had been broken up two years, against Potter's, Peruvian, and African guano; it beat them all, particularly in coming to the hoe—a week at least before the Peruvian, ten days before the African, three weeks before Potter's; whilst the expense is nearly 1*l.* per acre less: and I make no doubt that the weight per acre will be more, from the plant being so regular, which is not the case with the other manures. I find also, from a neighbour, who put 4 bushels to the acre on clover in March last, that his produce was doubled.

I remain your humble servant,

JOHN MAXWELL TYLDEN.

*Milsted, Sittingbourn,*  
*Sept. 11, 1844.*

---

---

XVI.—*Trial of Superphosphate and other Manures.* By  
EDWARD STROUTS.

THE following is the result of an agricultural experiment of the Right Hon. Thomas Pemberton Leigh, of Tory Hill, in the county of Kent; who requested his tenant, Mr. Edward Strouts, of Kingsdown, Kent, to carry out the experiment—being paid the cost price of the four manures used as a top-dressing. The experiment was upon a clover-ley wheat crop, with farm-yard manure, ploughed in at the time of wheat-sowing

about the 22nd November, 1843; and guano and other manures used as a top-dressing in the spring, on Tuesday, 19th March, 1844.

No.		£	s.	d.
1	One acre of Farm-yard Manure, 30 cart-loads . . . . .	4	10	0
2	One acre of Peruvian Guano, 3 cwt. 2 qrs. 18 lbs. at 12s. per cwt. . . . .	2	4	0
3	One acre of Rape-dust, 5 cwt. at 6s. 6d. per cwt. . . . .	1	12	6
4	One acre of Urate, 6 cwt. 2 qrs. at 5s. per cwt. . . . .	1	12	6
5	One acre of Super-phosphate of Lime, 6 cwt. 1 qr. 4 lbs. at 7s. per cwt. . . . .	2	4	9
6	One acre with no dressing . . . . .	0	0	0

No.	Produce.	Pounds of Straw.	Number of Shocks.	Weight per Bushel.	Increase.
	Bush. Galls.				Bush. Galls.
1	40 6	2,376	32	62½	11 4
2	40 6	2,156	30	62	11 4
3	38 3	1,872	37	61	9 1
4	38 5	2,028	35	60	9 3
5	53 5	2,940	45	61	24 3
6	29 2	1,472	29	61	0 0

*Kingsdown, near Sittingbourne.*

XVII.—*On Medical Treatment for Sick Trees.* By Sir C. LEMON, Bart., M.P.

*To Ph. Pusey, Esq.*

MY DEAR SIR,—Some time ago I mentioned to you that I had in hand some experiments on the effect of chemical manures on young fir-trees. The plan of these experiments was as follows:—As the growth of trees is slow, and much time must be spent before any sensible effect can be produced by changes in the soil in which they are planted, it occurred to me that a quicker result might be obtained by working in an opposite direction. That is, not operating on healthy plants, and measuring effects by the comparative increase of growth; but by taking sickly plants, and treating them as patients whose constitutions were debilitated, and ought to be renovated by the addition of such ingredients as might be required for healthy vegetation. I imagined that the effect of such medical treatment would be more rapidly visible; and that it would at least reveal a secret in vegetable nosology with respect to the individual cases under trial. I do not imagine that my results are of any value in their details. Extensive experiments, carefully collected facts, and a minute observation of the circumstances which modify the course of nature in her secret operations, are absolutely necessary before positive conclusions can be drawn as to the full measure of effect produced on the vegetable constitution by any given mode of culture; and with respect to trees in their ordinary growth such a course of inquiry is to be measured only by the life of man. Still I think that my results are so



plain and indisputable as to the mere fact of a check given to the approach of death, and a renewed vitality being obtained in a space of time comparatively short, that I venture to point out my experiments as indicating a short road to knowledge which others may travel, and take a more extensive view of the country than I myself have been able to do. First, then, as to the condition of the soil and subsoil as shown by the analysis.

*Analysis of Soils from Carclew.*—1st. Surface soil from the plantation on Mylor Downs. The water in which this soil was infused yielded a little muriate of soda, and gave traces of iron.

The soil was freed of the larger stones by being sifted through a coarse sieve, and the vegetable fibre was carefully picked out (The other soils were treated in the same manner):—

	Hunt.
Silica and silicious sand . . . . .	83·25
Alumina . . . . .	4·10
Carbonate of lime . . . . .	1·
————— magnesia . . . . .	·15
Sulphate of lime . . . . .	·75
Peroxide of iron, with a trace of protoxide . . . . .	4·50
Potash . . . . .	2·25
Humus . . . . .	2·
Vegetable matter, insoluble in alkalies . . . . .	1·58
Muriates . . . . .	·42
Phosphate of lime . . . . .	. . .
	100·00

100 grains of this soil lost in drying, at common temperatures, six grains of water; and by exposure to heat insufficient to char the vegetable matter it contained, it lost three grains more of water and volatile matter.

2nd. Subsoil from the same spot about 18 inches below the surface. The water in which this was infused gave indications of muriate of soda, but nothing else.

100 grains lost in drying at common temperature four, heat dissipated seven grains of water, &c.

	Hunt.
Silica and silicious sand . . . . .	76·50
Alumina . . . . .	10·10
Carbonate of lime . . . . .	1·20
————— magnesia . . . . .	·25
Peroxide and protoxide of iron . . . . .	5·10
Sulphate of lime . . . . .	1·25
Phosphate of lime . . . . .	·25
————— magnesia . . . . .	·15
Potash . . . . .	3·
Humus . . . . .	1·15
Vegetable matter, insoluble in alkalies . . . . .	·30
Muriates . . . . .	·75
	100·00

It will be seen that this subsoil contains some phosphates which could not be detected in the surface soil or in the clay below it.

3rd. Clay from the same spot below the subsoil. Infused in water



- April* 1844. No. 2 recovering; generally alive; shoots 2 inches; not very good colour.  
 No. 3. Alive at top, but dead below. All around it dead at top.
- No. 4. *Sulphate of soda and water*, same proportion as No. 1.  
*Sept.* 1842. Shoot 1 inch, scarcely any difference observable.  
*April* 1844. Weak shoots, but better than anything around it, and alive at top.
- Nos. 5 and 6. *Sulphate of soda sown dry*, same proportion as No. 1.  
*Sept.* 1842. Shoots from 3 to 4 inches long, of a good colour, and apparently more healthy than any around them.  
*April* 1844. No. 5 recovering and gaining strength. No. 6 quite recovered and healthy; all around it dead.
- No. 7. The surface broken around the tree, and a mixture of bones and earth applied at the rate of 8 quarters of bones to 22 loads of earth per acre.  
*Sept.* 1842. But little effect; shoots  $1\frac{1}{2}$  inch; not good colour.  
*April* 1844. Recovered, but not very strong.
- No. 8. *With lime* mixed in the soil at the rate of about 300 Winchester bushels per acre. The surface being broken as in No. 7.  
*Sept.* 1842. Shoots 2 inches, colour good. Plant apparently healthy, whilst most around it are dead.  
*April* 1844. Shoots  $1\frac{1}{2}$  inch long. Alive, but not strong; all around it dead.
- Nos. 9 and 10. *Watered with Ammoniacal liquor* at the rate of 8 gallons to 50 gallons of water.  
*Sept.* 1842. Shoots generally  $1\frac{1}{2}$  inch; thin of foliage, but tolerably coloured.  
*April* 1844. No change on either.

The manures were severally applied early in March, 1842, and repeated in 1843.

I draw no inferences from these experiments, except the following:—  
 That liquid manures pass off, and leave no permanent effect.

That various dry substances affected the broken constitutions of the plants in different degrees.

That dry sulphate of soda (Nos. 5 and 6), is the specific remedy suited to the case.

I am, my dear Sir,  
 Yours sincerely,

Carclew, April 18, 1844.

C. LEMON.

XVIII.—*A Plan to prevent the Waste of Manure in Rivers which flow through Towns.* By W. POPHAM, Esq., B.A., Oriel College.

No. 1.—*Fleet Ditch Sewer.*

IN the bank of the river, which at low water is dry, let there be formed a sewer parallel with the stream, joining Fleet Ditch Sewer at an obtuse angle, a few feet from its mouth; at the bottom of this additional sewer let there be apertures, under which, in chambers, let there be placed half-decked punts, built with air compartments, so as to render them, when laden with deposit of sewer, the specific gravity of water.

When tide is a few inches below the level of port-holes, let the punts, filled with water, be floated into their respective chambers: after they are laden with deposit, at the same depth of water, let them be towed out, and replaced by duplicates. A valve closes aperture of sewer while boats are changed, and sliding hatch secures the punt.

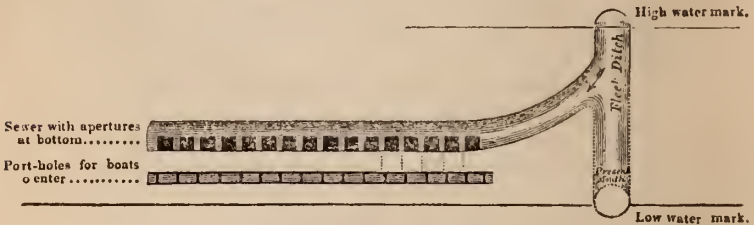

No. 2.—*King's Scholars' Pond Sewer.*

IN the open reservoir, near junction with Thames, let barges of similar construction, long enough to reach across the channel, with decks hinged at bow and stern, and opening in the centre, be fixed side by side, so as not to rise from the bottom. The decks to be kept open against the walls of the canal while the stream, which is very gradual, is passing: at falling tide let the laden barges, with closed decks, be towed out and replaced by empty ones.

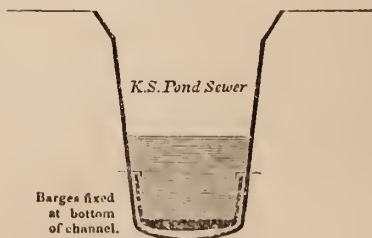

XIX.—*On the Hainault Scythe.* By Sir G. H. ROSE.

SIR—As an old, though retired, Hampshire farmer, and grateful for the good which your noble institution is calculated to promote, I use the freedom of writing to you now, but am fully aware that at this present moment it can neither be attended to nor noticed.

In about the year 1811 I introduced here the use of the Hainault scythe, bringing hither two Flemish labourers. It prevails through the whole old Netherlands seventeen provinces, and probably is of very ancient date. For its advantages I refer you to a report of the Christchurch Agricultural Society in 1814, made in my absence, fairly and openly. The facts established are such as were proved for a few years together; and they would have been better established then, had any one person present well understood the subject. They enumerate three advantages. The first is dispatch; this is so; half the time of reaping is saved, a result most beneficial in many ways; secondly, straw and corn are saved; this is so; you gain the whole of the straw with no more trouble to the labourer; thirdly, the sheaves are more easily and better made; you have much longer straw to bind with. Besides this, very great fatigue is spared to the reaper; he steadies, and finally collects, what he cuts, with his staff and crook in his left hand, and uses his peculiar scythe, only leaning to the right, and sparing his back, and swinging it with his right arm, with a loose shoulder, as in fencing; the blade enters the corn obliquely, so as not to shake the standing crop, but giving what with the sabre is called the drawing cut. The use of this scythe is most easily learned, as the Report, which I subjoin, shows. My gardening lad (Felix Edgell), with very little practice, beat a very fine man, the Flemish instructor. Hiscock, Footner, and Hascall were mere recruits. Should there be a wish for further information, I shall willingly give it. There are men here who could instruct learners, especially my gardener, who won the first prize when a lad. My direction (the Right Hon. Sir G. H. Rose) is, till Friday, at Wilton House, Southampton, afterwards as dated above.

I am, Sir, your very obedient humble servant,

*Sandhills, Christchurch, Hants,*  
July 23, 1844.

G. H. ROSE.

The implements are somewhat like the following rough sketch:—



Staff and Crook.

Scythe.

“ *Christchurch (Hants) Agricultural Society.*

“The Report of the Committee of this Society for the year preceding the 31st of October, 1814, to the General Meeting of the Society held on that day.

“Your committee report that the gentlemen appointed a committee for conducting the exhibition of the Hainault scythe, appointed a meeting for the 23rd of August. There were 15 candidates for the premiums, 13 men and 2 boys; and the premiums were awarded by the judges, G. R. Eyres, Esq., &c. &c., as follows:—

	£.	s.	d.
To Felix Edgell, of Christchurch, who learned last harvest, and completed half a statute acre in 5h. 12m. . . . .	2	2	0
To a foreigner, who came to instruct Sir G. H. Rose’s men, and who cut the same quantity in 5h. 16m. . . . .	1	11	6
To John Fell, of Christchurch, aged 40, who cut the same quantity in 4h. 39m., but not so even . . . . .	1	1	0
To — Hiscock, aged 21, a learner of this harvest, who cut the same in 5h. 40m. . . . .	0	15	0
To Hen. Footner, under 16 years of age, a learner of this year only, who cut his proportion within the time allowed	1	11	6
To J. Hascall, a boy of the same description . . . . .	1	1	0

“That three men with reap-hooks contended against the scythe, but none of them, though all picked men, nearly completed the half acre within the limited time.

“The judges also signed the following opinion, which, with the above, was published in the respective newspapers:—

“‘We, the judges, consider the superior advantages of the Hainault scythe to consist—1st, in dispatch nearly one half; 2nd, in saving straw and corn; 3rd, in the sheaves being tied with a single band and hooded in style, and thereby less liable to injury by weather.’

“That your committee, on account of the expense of this exhibition, are of opinion that it can only be exhibited at a time of year when farmers are necessarily otherwise engaged, and do not think it necessary to continue the premiums, particularly as so full and fair a trial of its powers has now been made.”

---

SIR,—As you will be so good as to lay before the Board of Agriculture my letter on the Hainault scythe, I will, with your leave, offer a few particulars respecting it, which I omitted I believe. I say nothing of it as compared with the common scythe for mowing wheat, a practice now gaining much, as I understand; but I should doubt, from the facts stated in the Christchurch Report, which I sent to you, whether it (the scythe) would beat the Hainault scythe in speed, half a statute acre having been completed by a novice lad in 5h. 12m., by a Fleming in 5h. 16m., and by a mere novice in 5h. 40m.

The Flemish scythe-man stands with the corn to the left hand, lays the staff in his left hand against the corn to steady it to receive the stroke, turning the iron crook from it, and swings his scythe against the corn; but the blade is so contrived, that the point enters first, and the

stroke is a drawing stroke, so as not to shed the corn : he goes on, leaving what he has cut leaning on the corn behind it, and when he reaches the point at which he judges he should stop, he turns the crook towards the corn, and facing to it, cuts back to where he set out from, dragging in his crook what he cuts both in going out and back ; he then disengages the crook, and, with his right foot, lays the corn cut in a line with the standing corn for the binder, whose work is facilitated by the length of the straw. The closeness of cutting depends on the length of the handle, which is of wood ; of course every good farmer will have the handle long to save all the straw. The blade which is so constructed and placed that it must enter by the point, has the edge a little raised to save it from stones, and the point a little raised that an awkward man may not catch the ground. A great advantage is, that it cuts from without and not from within ; thus it is excellent for laid crops ; it is not inserted and then drawn out ; it strikes against the prostrate crop, which the late Lord Winchelsea found much benefit from with heavy crops of laid oats. I had an immense crop of tares so matted as to be very difficult to cut, except by this instrument, which did it most easily. As to the facility of labour with it, I should mention a conversation which I had with my head carter, at the introduction of it a few days after the beginning of harvest. I asked him how he liked it? He said, " Particularly, for he could do exactly double the work he did in reaping, and that when he went to bed, after the whole work of a July or August day in harvest, and straightened his back he cried like a child from pain, and could not sleep, while, with the new instrument, the instant he laid down he slept like a child."

The right hand is placed on the part of the handle from A to B, grasping it. The nob at A is meant to prevent the hand slipping off. At C a leather loop is nailed to the handle, through which the man passes his fore-finger, to give him more power of holding, using, and directing the instrument.

I sent it to the Agricultural Society of Ireland, with a labourer ; but he beat so decidedly the reapers there, that he was soon obliged to be sent back for his safety. I told them, on sending him, that he would cut closer and do twice the work in the same time ; but it seems that their reapers cut very low, but of course more slowly. Thus they replied to me, that their people cut as low as my man, but that he beat them, not as 2 but as 3 to 1 in time. He (Braker) is now alive at Christchurch.

I beg leave to refer you to a communication to the old Board of Agriculture, vol. vi., Journal 213, from Mr. Philip Howard, of Corby Castle, of the 3rd of March, 1794. He says :—" What greatly facilitates the expeditious harvest of the grain-crops in Flanders is the use of the Hainault scythe, the best instrument yet invented to unite expedition with neatness, very different in this last respect from the cradle-scythe ; it lays all the corn as regularly for the binders as could be done by the reapers with the sickle." Mr. Howard failed in his attempt to introduce this scythe for want of a teacher, as did the Earl of Marchmont in 1709 (Marchmont Papers, vol. iii. p. 349).

As to sheaves, as you have the whole length of the straw, they are of

such a size as to be bound by a single length of the plant, a great saving of time.

I observed very lately the operation of the cradle-scythe in mowing wheat, and saw the full weight of Mr. Howard's objection to it.

The use of this scythe went down, because I went abroad in 1813 on foreign missions for several years, and there was no one left to carry it on.

I have for one had this instrument tried publicly by my gardener (Edgell), who won the first prize, and he did very good work, though the tools were in bad order, and the man disused for 30 years.

*Sandhills, Christchurch, Hants, Aug. 5, 1844.*

SIR—To complete the facts which I have submitted to you, I learn from Edgell, my gardener, whom I can entirely trust, that, whilst I was abroad, he cut 2 acres of very fine Talavera wheat, which yielded 40 bushels an acre, and was completely laid within two days easily. I lay this additional fact before you as to the Hainault scythe.

I am, Sir, your most obedient servant,

*Sandhills, Aug. 6, 1844.*

G. H. ROSE.

XX.—*On the Analysis of Soils.* By ANDREW URE,  
M.D., F.R.S., &c.

HAVING been recently engaged in a minute chemical examination of the soil of a large farm, remarkable for perennial fertility without manure,\* I have been led to adopt some simplified methods of analysis, which may to a certain extent be practised by ordinary farmers, and may throw some light on the means of improving permanently the composition of their lands. The field from which the sample subject of analysis was taken, is situated on Marsh Farm, in Haveling Level, in the parish of Hornchurch, Essex, not far from the banks of the Thames, and nearly opposite to Erith. R. M. Kerrison, Esq., M.D., F.R.S., the proprietor, informs me that no manure has ever been applied to this farm of 200 acres during a period of at least fifty years, except once; and in that season the wheat became so heavy as to be in a great measure spoiled. It produces every variety of crop most abundantly.

The substratum, which lies beneath a three feet bed of the soil, is an alluvial deposit, replete with decaying vegetable matter; the remains probably of some ancient forest, which existed prior to the formation of the Dagenham Breach, through which the river had inundated a large district of country, and kept it submersed till about two centuries ago; when it was stopped out by the aid of a Parliamentary grant, administered under the direction of a skilful engineer. The soil over the whole farm

\* All the stable-yard dung is sold by the farmer.



is of very uniform texture and appearance; being a finely comminuted friable loam, quite free from stones, consisting of a fortunate mixture of fine siliceous sand, clay, oxide of iron, and carbonate of lime, with minute proportions of phosphate of lime and magnesia, but very little organic matter. It would seem, therefore, to derive its principles of fertility chiefly from the atmosphere, and the emanations from the sub-soil.

The specific gravity of the soil, in its average state of dryness, is 2.2 to water called 1.0; indicating the presence of but little vegetable matter.

100 parts of it collected after a period of ordinary dry weather lose 11.2 by a steam heat of 212°, and readily re-absorb that portion of moisture when again exposed to damp air. When the dried residuum is calcined at a dull red heat, six parts of vegetable substance are burned away; at a higher temperature the carbonate of lime would become calcined, and cause an additional loss of weight, which might inconsiderately be mistaken for organic matter.

The first problem in an agricultural analysis, is to find the proportion of calcareous matter, as carbonate and phosphate of lime. This may be easily solved with the aid of the following instrument (see page 621), which may be called the *Lime-stone Meter*, one of which was presented and explained by me to the Council of the Royal Society of Agriculture on the 29th of May last.

A, is a cylinder of glass, two inches in diameter, and fourteen inches long, graduated on one side with a scale, into spaces of 100 water-grain measures from 0 to 12,000, marked 10, 20, 30, &c.; and graduated on the other side into spaces of 240 water-grain measure, each. The former scale is used for the analysis of all sorts of alkaline carbonates, and also of acids; the latter is adapted to the direct analysis of carbonate of lime and marls; and indirectly to that of phosphate of lime and carbonate of magnesia.

The cylinder A, has a tubulure in its side near to the bottom; this is closed with a cork, in the axis of which a short glass tube is cemented, hooped externally to a collar of caoutchouc E, which serves as a joint to the upright long glass tube B, held near its upper recurved end in a hooked wire.

The top of the cylinder A is closed with an elastic cork, through a perforation in which the taper tail of the little phial C passes air-tight. The small tube F, open at both its ends, is cemented on its outer surface, into the bottom of the phial C, so as to close it, while the tube itself opens a free passage to gas, from the shoulder of the phial, down into the cylinder A.

The mouth of the phial C is shut with a cork, through which the small end of the tube D passes air-tight. The tube D is graduated into spaces of 10, 20, &c., water-grain measures up to 250, and is closed at top with a stop-cock. Its lower and capillary extremity is recurved.

In ascertaining with this instrument the proportion of real carbonate of lime, in any limestone, marl, or soil, proceed as follows:—

Lift out the phial C, and pour water into the cylinder A till it stands

about half an inch below the line marked 0, and fill up this space with common linseed-oil. Restore the phial C to its place, pressing it in air-tight. Then take out its cork with its graduated tube, and introduce into the phial as many grains weight of the soil or marl as it is proper to operate upon. Of an average limestone 50 grains are sufficient, because the magnified scale of the *lime-proof* is adapted to the analysis of 50 grains of pure carbonate of lime. Of soils and marls, 100, 200, or even 500 grains, may be taken, because these substances will rarely contain one-tenth their weight of carbonate of lime. But as the result may always be obtained within five minutes, at the cost of half a farthing, several successive experiments may be made on different weights of the sample. Having introduced the proper weight of the object into the phial, cover it with water, till this stands a little above the point to which the recurved tube descends. Holding D in the hand, dip its bent point into a phial containing ordinary muriatic (hydrochloric) acid, diluted with its own bulk of water, and applying the mouth to the opened stop-cock, suck up the acid into the tube till this be about two-thirds full, then turn the key of the cock before it is taken from the lips, and the acid will not drop out when the tube is held upright. Replace the cork with its tube D in the phial C. Detach the long tube, B, from its wire-rest with the left hand, and hold its curved extremity above an empty basin; then with the right hand open the stop-cock of D, to let a little acid run down upon the marl, but shut it almost instantly again, lest too much acid should escape, and cause so brisk an effervescence as to occasion an overflow of the mixture into the small tube, F. The disengaged carbonic acid escapes through the tube F, presses on the surface of the oil in A, and causes a stream of water to flow from the tube B, into the subjacent basin. When the water ceases to run, open the stop-cock again, when more acid will descend, cause a fresh extrication of gas, and a further flow of water. The curved end of the tube B should be progressively lowered, as the oil falls in A, so as to maintain its level and that in the tube in the same horizontal plane. Whenever gas ceases to be extricated by the muriatic acid, the experiment is completed, and the number on the *lime-meter* scale opposite to the upper surface of the oil, denotes the number of grains of carbonate of lime, in the quantity of limestone, marl, or soil, put into the phial C for experiment. A little carbonic acid gas remains condensed in the muriatic solution, but this is not more than equivalent to the bulk of liquid acid introduced into the capacity of the apparatus; so that no compensation need be made in this account. For the purpose of minute chemical research, that portion of gas may be expelled by surrounding the phial C with a cloth wrung out of hot water, and the volume of dilute acid added, may also be taken into the account. Thus the composition of carbonates by an acid, and of acids by a bicarbonate, may be determined by means of this instrument with equal rapidity and precision.

The contents of the phial may be poured out into a porcelain capsule, gently heated, and thrown on a filter. The lime of the carbonate, as well as the phosphate of lime and the magnesia, will pass through in solution along with a very little iron. On super-saturating the acidulous

liquor with water of pure ammonia, phosphate of lime (if present) will fall, and may be drained on a filter and dried. Taken off the dried filter, and digested with a little dilute sulphuric acid, sulphate of lime will result, characterized by its entire insolubility in dilute alcohol. Hence the sulphate washed with vinous spirits, dried and calcined, will represent by its weight one-fifth more than the original weight of the phosphate. By the action of the sulphuric acid, the iron precipitated by the ammonia with the phosphate is got rid of.

The magnesia, unless its proportion had been very great, will all remain dissolved as ammonia-muriate, and its quantity may be ascertained by precipitating it either with soda, or phosphate of soda. In the former case, the substance obtained when washed on a filter, dried and ignited, is pure magnesia; in the latter, it is the ammonia-phosphate of magnesia, and when dried at the moderate heat of  $120^{\circ}$  Fahr., it represents by its weight about six times that of the magnesia present; or for 100 parts,  $16\frac{1}{2}$  of magnesia.

When a complete analysis of a soil is to be made, the following apparatus is convenient:—

A large glass flask, or matrass, with a sucked-in or concave thin bottom. This should hold at least a quart of water; and when the soil and dilute acid are introduced, it is to be placed on a stand over the gentle flame of a spirit lamp, while the beak of a large glass funnel, having its mouth covered with a porcelain basin, filled with cold water, is inserted into the neck of a flask. By this arrangement a continual ebullition may be maintained in the mixture of soil and acid, without loss of acid, or nuisance from its fumes, because the vapours are condensed whenever they reach the cold basin above the funnel, and a perpetual cohobation takes place. A boiling heat may be kept up in this way till every constituent of the soil, except the silica, becomes dissolved. Muriatic acid is generally preferred for the analysis of soils, and in somewhat greater quantity than the bases in the given weight of soil can neutralize. The funnel and porcelain basin should be properly supported upon the rings of the chemical stand. I generally subject 100 grains of soil to the action of boiling dilute acid in this way for 6 or 8 hours; at the end of that period I throw the contents of the matrass upon a filter, and supersaturate the filtered liquid with ammonia. The silica which remains on the filter having been washed in the process, is dried, ignited, and weighed.

The alumina, iron-oxide, and phosphate of lime, thrown down by the ammonia, being washed in the filter, and dried to a cheesy consistence, are removed with a bone or tortoise-shell blade into a silver basin, and digested with heat in a solution of pure potash, whereby the alumina is dissolved, when its alkaline solution is to be passed through a filter, then saturated with muriatic acid, and next super-saturated with ammonia. Pure white alumina falls, which is to be separated on a filter, washed, dried, ignited, and weighed.

The iron and phosphate of lime on the alkaline filter may be dried, gently ignited, and weighed, or otherwise directly separated from each other without that step, by the action of dilute alcohol, acidulated with sulphuric acid, at a gentle heat. Thus the iron oxide will be dissolved, and its solution may be passed through a filter, while the sulphate of

lime will remain upon it, to be dried, ignited, and weighed. Five parts of it correspond to four of phosphate. The iron is obtained by precipitation with water of ammonia, filtration, and ignition.

The first filtered liquor, with excess of ammonia, contains the lime of the carbonate, and the magnesia. The former is separated by a solution of oxalate of ammonia, with digestion in a gentle warmth for a few hours, filtration, and very gentle ignition of the washed dry powder, when the pure carbonate of lime is obtained. The magnesia, existing in the filtered liquor as an ammonia-muriate, may be obtained by precipitation with soda, or phosphate of soda, as already described.

For some refractory soils, in which the alumina exists as a double or triple silicate, it becomes necessary to fuse 50 grains of the sample, in fine powder, mixed with four times its weight of dry carbonate of soda, the mixture being put into a platinum crucible, and into a cavity in its centre, 50 grains of hydrate of potash being laid.

The crucible being slowly raised to a red-white heat, affords a fused liquid quite homogeneous, of a gray or brown colour, according to the metals present in it. Manganese gives a purple tint; and iron a reddish brown. The fused matter should be poured out into a shallow platinum basin; and, whenever it cools, it should be pulverized, dissolved in dilute muriatic acid, the solution evaporated to dryness, the dry mass again digested in hot water, acidulated with muriatic acid, and the whole thrown upon a filter. Pure silica will remain on the filter, to be washed, dried, ignited, and weighed.

The filtered liquor contains the remaining constituents of the soil, and is to be treated as already described.

Besides these systematic investigations, researches may be made for certain peculiar substances, and especially the neutro-saline constituents. In this view 100 grains of the soil may be triturated with 20 times their weight of distilled water, placed in a beaker, till the clayey matter subsides, and the clear portion then be decanted into a filter. A little of the filtered liquor should be tested with nitrate of barytes, and also with oxalate of ammonia; and if each portion yields a precipitate, they show the presence of sulphate of lime; and the following steps ought to be taken to eliminate it entirely: 200 grains of the soil should be triturated with a quart of distilled water, holding 50 grains of sal-ammoniac, in solution. The mixture should be allowed to clarify itself by subsidence, when the supernatant clear liquor should be filtered, and evaporated down to 2 ounce measures, and then mixed with that bulk of strong whiskey (11 per cent. overproof). The whole sulphate of lime will be now separated from the fluid, and after being drained on a filter, may be dried, ignited, and weighed.

For determining the alkaline salts, the water filtered from the 100 grains of the soil should be evaporated down to one-fifth of its bulk, and then treated—1st, with nitrate of barytes for the sulphates; 2nd, with nitrate of silver for the muriates; 3rd, with oxalate of ammonia, for the nitrate or muriate of lime (provided no sulphate of lime is indicated by the first test); 4th, with litmus paper, for alkaline or acid reaction; 5th, with soda-chloride of platinum for potash salts, which are very valuable for the vigorous growth of many plants.

The portion of soil tested for potash salts should, before being digested

in water, be gently calcined, to insure the expulsion of every particle of ammoniacal salt, otherwise the precipitate afforded by soda-chloride of platinum would be fallacious.

Another peculiar research of great importance is that which determines the amount of ammonia in a soil; and which may exist either ready formed, or in its elements, capable of affording a portion of the azotic food so indispensable to vigorous vegetation. The actual ammonia is easily obtained by distilling the soil along with some milk of lime. The distilled water will contain all the volatile alkali, which may be measured by the number of drops of a standard dilute acid, which it will saturate.

The *potential* ammonia, slumbering, so to speak, in its embryo elements, may be estimated by igniting 200 grains of the soil with its own weight of a mixture of hydrate of soda and quicklime, as described in my memoir on 'The Analysis of Guano,' in the last number of this Journal, page 296, § 16.

I have subjected the soil of Dr. Kerrison's farm to the various modes of research above enumerated, and have obtained the following results:—

1. By the application of my *limestone-meter* I obtained carbonic acid gas, equivalent to 9 grains of carbonate of lime.

2. By igniting 200 grains of the soil along with 200 grains of mixed quicklime and hydrate of soda, in the appropriate apparatus, I obtained 0·34 grains of ammonia, or 0·17 per cent. of the weight of the soil. Hence 600 grains of the soil contain the azotic equivalent of one grain of ammonia. This remarkable fact reveals most plainly one secret source of the uninterrupted production of rich crops of cereals and other plants from it, without receiving any manure. How appropriate to such land is Virgil's beautiful title of the subject of his 'Georgics,' *justissima tellus!*

3. By the process of cohobation for 8 hours, with dilute muriatic acid, as also by the process of fusion with alkalis in a platinum crucible, and the subsequent treatment above detailed, I obtained—

1. Silica	56·0
2. Alumina	8·0
3. Oxide of iron	5·5
4. Carbonate of lime	9·0
5. Sub-phosphate of lime	0·4
6. Magnesia (carbonate)	0·5
7. Moisture separable by steam heat	11·3
8. Organic matter, chiefly vegetable mould	6·6
9. Moisture separable at a red-heat	2·7

---

100·0

Besides traces of muriate of soda, and muriate of lime (chlorides of sodium and calcium). The iron exists mostly in the state of protoxide, a circumstance owing, probably, to exhalations from the subsoil of sulphuretted, phosphuretted, and carburetted hydrogen. The fresh soil is of a grey colour, but becomes ochrey-red by calcination.

100 grains of the said soil, dried at  $212^{\circ}$ , absorb 8 grains of moisture in 24 hours; while 100 grains of the comparatively sterile soil of Regent's Park, dried equally, absorb only 5 grains: a difference due chiefly to the finer comminution of the former.

Since the phosphates are such precious ingredients towards fertilizing soils, it is desirable to possess a clear and simple test of their presence. For this purpose digest the soil, for an hour or so, with a moderate heat, in dilute nitric acid, free from muriatic (viz. which affords, when largely diluted, no precipitate, by the addition of a solution of nitrate of silver). Throw the mixture on a filter, and to the filtered liquid add potash-water, cautiously, till the instant that a precipitate begins to appear; then drop into it a weak solution of nitrate of silver. If any phosphoric salts be present, a yellowish precipitate will immediately fall, which is re-soluble in an excess of nitric acid. Whatever is not thus dissolved is chloride of silver, and ought to be separated by filtration: on adding then weak water of potash (not ammonia) cautiously to the filtered liquid, the pure phosphate of silver will be obtained, without any alumina or iron, provided the liquid be still acidulous in a slight degree. It ought to be remembered that chloride of silver falls in a *white* curdy form, quite different from that of the phosphate of silver. The portion of soil used for this experiment should be fresh, and not calcined, because the *phosphates*, when ignited, afford white precipitates with salts of silver. The stronger the solution of the phosphoric saline compound is, the more characteristic is the yellow precipitate with silver; and then ammonia may be used for effecting the partial saturation of the acid excess. Sulphate of magnesia is an excellent re-agent for detecting phosphoric acid, and for separating it from the above acid solution, when it is partially neutralized with ammonia; for the magnesia forms, with the phosphoric acid and ammonia, the insoluble granular precipitate of ammonia-magnesian phosphate. A solution of sulphate of magnesia, containing a little sal-ammoniac, is probably the best test-liquor for detecting phosphates in faintly acidulous, but still better in neutral, solutions.

In almost all soils of an arable nature under cultivation in this country, there is a sufficiency of calcareous matter present to counteract the combination of phosphoric acid with alumina or oxide of iron, for which reason it would be an idle refinement of agricultural analysis to search for phosphates of alumina and iron. As for manganese, often associated with iron, it exists in too small a proportion, and is possessed of too little value to make it worth while to effect its separation. It gives to calcined iron-oxide a black hue, and is characterized in its saline solutions by the flesh-coloured precipitate which it affords with hydro-sulphuret of ammonia, after the whole of the iron has been thrown down by boiling the solution of the two metals with pure carbonate of lime.

The organic matter in any soil may be correctly estimated by calcining its powder pretty strongly till the carbonic acid be expelled from the lime in it. The loss of weight, deducting that due to the carbonic acid gas (which is known from an independent experiment), gives the quantity of organic matter. Its quality is determined by the ultimate analysis by means of hydrate of soda and quicklime, as previously stated.

Dr. Ure's Limestone Meter.

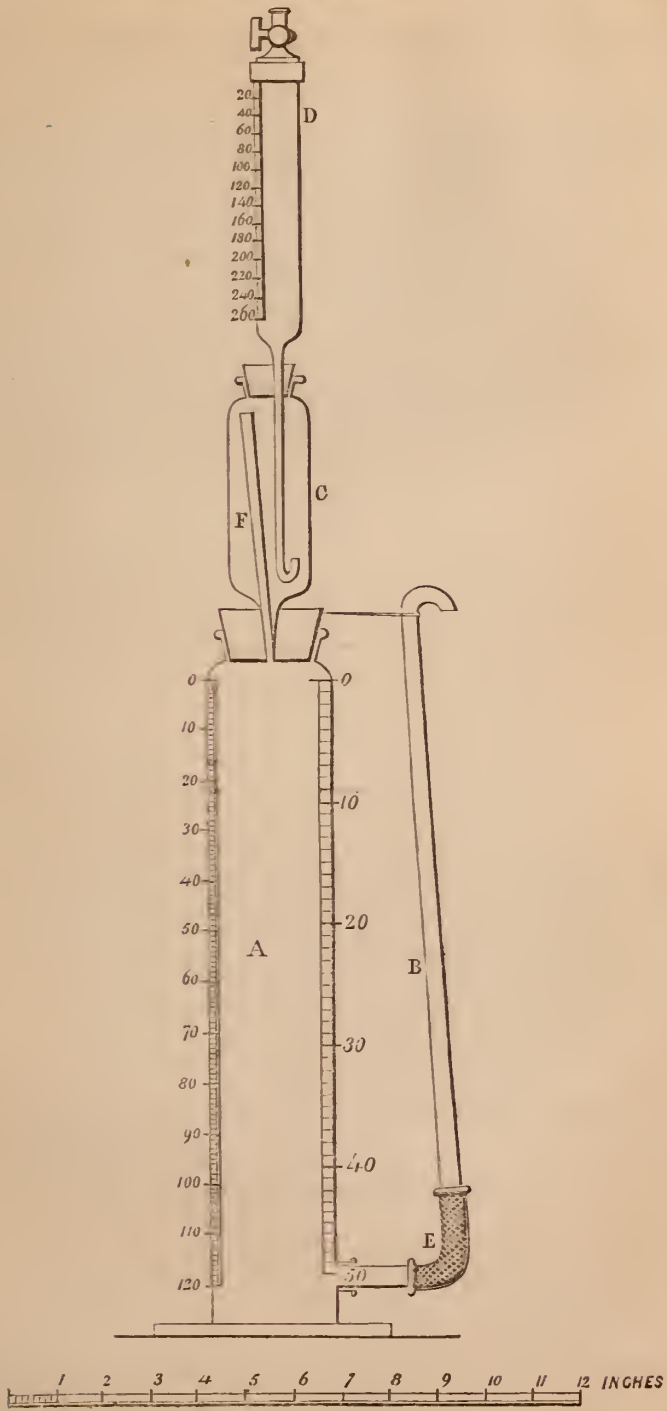

XXI.—*On Stacking Sainfoin.* By the EARL of ESSEX.*To Ph. Pusey, Esq.*

MY DEAR MR. PUSEY,—If you think the following experiment worthy of insertion in our journal, it is very much at your service :—

On Monday and Tuesday of the last week in June, last summer, I cut 9 acres of sainfoin, a good crop for the season, averaging  $1\frac{1}{2}$  load to the acre, and in full flower. On Wednesday it was once turned, and on Thursday and Friday it was carried and stacked. The weather was dry and hot, so that the hay was somewhat dried, but still so green, that on working it between the finger and thumb, abundance of moisture exuded. In stacking it, I put alternate layers of oat-straw (in all 200 trusses). All hands prognosticated heating and burning ; and my bailiff suggested that I should put a perpendicular chimney, in the centre of the stack, of rough timber, communicating at the bottom with a horizontal one, extending to the outside of the stack, thus—

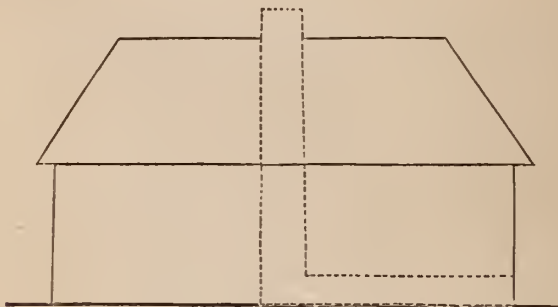

No heating whatever took place ; I have now reached the centre of the stack, and nothing can be finer than the hay. It has retained its green colour ; and the flower, especially near the chimney, is as bright and purple as when first cut. The straw seems to have absorbed all the superabundant moisture, and is almost as good as the hay : and the whole together cuts up into most admirable chaff. This year I should certainly wish to repeat the process with all my hay, but fear there will be a great deficiency of straw.

Believe me, yours very faithfully,

ESSEX.

3, *Chapel Street, Park Lane, January 6.*



XXII.—*Experiment on Manures.* By ISAAC EVERITT.

Weighed this day, December 18th, 1844, after 10 days' very severe frost, without any snow having fallen, consequently the turnips must have lost considerably in weight; the following 6 rods of green-top yellow turnip, drilled on ridges, 27 inches wide, on the 22nd June, 1844:—

Quantity Weighed.	Description of the Manures per Acre.	Value of Manure per Acre.	Number of Turnips per Rod.	Weight per Rod.	Weight per Turnip.	Weight per Acre.
		£ s. d.		lbs.	lbs.	Tons.
1	{ With Pigeons' Dung, at the rate of 6 tumbrel loads per acre, at 10s. 6d. per load. }	3 3 0	112	196	1 $\frac{3}{4}$	14
1	{ With 2 cwt. of Guano, at 14s. per cwt., mixed well with 8 bushels of burnt quick ashes per acre, at 4d. per bushel. . . . . }	1 10 8	108	175	1 $\frac{3}{4}$ rather less.	12 $\frac{1}{2}$
1	{ With farm-yard Manure, 12 tumbrel loads per acre, at 4s. 6d. . . . . }	2 14 0	103	175	1 $\frac{3}{4}$ rather less.	12 $\frac{1}{2}$
1	{ With Bones, at the rate of 12 bushels per acre, at 2s. 6d. . . . . }	1 10 0	120	168	1 $\frac{1}{2}$ rather less.	12
1	{ With Rape-Cake, at the rate of 12 bushels per acre, at 2s. 6d. . . . . }	1 10 0	111	154	1 $\frac{1}{2}$ rather less.	11
1	{ Without any Manure what- ever . . . . . }	. . .	115	21	3 oz. per Turnip.	1 $\frac{1}{2}$

## OBSERVATIONS.

It will be observed by these experiments, that the above turnips can be grown, with either guano, bones, or rape-cake, at about 2s. 6d. per ton, and allowing that 1 bushel of turnips weighs 4 stones, which is very near the mark, they can be also grown at the cost of about 3 farthings per bushel. But there is another very obvious circumstance attending all experiments in growing turnips, viz., so much depending upon the men hoeing them, one man setting his turnips much more regularly than another; consequently the result of all experiments is influenced very much by this fact. The manures were all deposited between the ridges, and they were then split or ploughed on the manure, then rolled down, and the turnips drilled on the ridges.

*South Creake, near Fakenham, Norfolk.*

LONDON :  
Printed by WILLIAM CLOWES and Sons,  
Stamford Street.

# Royal Agricultural Society of England.

1843—1844.

## President.

EARL SPENCER.

## Trustees.

Acland, Sir Thomas Dyke, Bart., M.P.  
Clive, Hon. Robert Henry, M.P.  
Downshire, Marquis of  
Grafton, Duke of  
Graham, Rt. Hon. Sir Jas., Bart., M.P.  
Handley, Henry

Lawley, Sir Francis, Bart.  
Neeld, Joseph, M.P.  
Richmond, Duke of  
Rutland, Duke of  
Spencer, Earl  
Sutherland, Duke of

## Vice-Presidents.

Buckingham, Duke of  
Chichester, Earl of  
Ducie, Earl of  
Exeter, Marquis of  
Fitzwilliam, Earl  
Gooch, Sir Thomas Sherlock, Bart.

Morgan, Sir Charles Gould, Bart.  
Northumberland, Duke of  
Portman, Lord  
Talbot, Earl  
Wellington, Duke of  
Worsley, Lord, M.P.

## General Members of Council.

Austen, Colonel Thomas  
Barclay, David, M.P.  
Baring, Hon. William Bingham, M.P.  
Barker, Thomas Raymond  
Benett, John, M.P.  
Bennett, Samuel  
Blanshard, Henry  
Bramston, Thomas William, M.P.  
Buller, Edward, M.P.  
Burke, J. French  
Cavendish, Hon. George Henry, M.P.  
Challoner, Colonel  
Childers, John Walbanke, M.P.  
Compton, Henry Coombe, M.P.  
Ellman, John  
Etwall, Ralph, M.P.  
Fellowes, Edward, M.P.  
Gihbs, Humphrey  
Grantham, Stephen  
Hatherton, Lord  
Hayter, William Goodenough, M.P.  
Hillyard, C.  
Hobbs, William Fisher  
Hoskyns, Sir Hungerford, Bart.  
Hudson, John

Hyett, William Henry  
Johnstone, Sir John V. B., Bart., M.P.  
Jonas, Samuel  
Kimberley, George  
Kinder, John  
King, Fielder  
Lemon, Sir Charles, Bart., M.P.  
Miles, William, M.P.  
Pendarves, Edward W. Wynne, M.P.  
Pole, E. S. Chandos  
Price, Sir Robert, Bart.  
Pusey, Philip, M.P.  
Pym, Francis  
Sanford, Edward Ayshford  
Sewell, Professor  
Shaw, William  
Shelley, John Villiers  
Sotheron, Thomas H. S. E., M.P.  
Spencer, Hon. Captain  
Stansfield, W. R. Crompton, M.P.  
Stokes, Charles  
Thompson, Henry Stephen  
Wilbraham, George, M.P.  
Wilson, Henry  
Wood, Colonel Thomas, M.P.

## Secretary.

JAMES HUDSON, 12, Hanover Square, London.

*Consulting Chemist*—Dr. LYON PLAYFAIR, Manchester.

*Consulting Engineer*—JOSIAH PARKES, C.E., 7, Great College Street, Westminster.

*Seedsmen*—Messrs. THOMAS GIBBS, & Co., Corner of Halfmoon Street, Piccadilly.

*Publisher*—JOHN MURRAY, 50, Alhemarle Street.

*Bankers*—Messrs. DRUMMOND, Charing Cross.

**Honorary Members.**

- BUCKLAND, The Rev. WILLIAM, D.D., F.R.S., Vice-President of the Geological Society.
- CARR, Captain J. STANLEY, Duchy of Lauenburg.
- COLMAN, HENRY, Agricultural Commissioner of the State of Massachusetts.
- DAUBENY, CHARLES, M.D., F.R.S., Professor of Rural Economy, University of Oxford.
- DE LA BECHE, Sir HENRY THOMAS, F.R.S., Director of the Ordnance Geological Survey.
- EVERETT, The Hon. EDWARD, United States' Minister.
- HENSLow, The Rev. J. S., F.R.S., Professor of Botany, University of Cambridge.
- JOHNSTON, JAMES F. W., F.R.S., Reader in Chemistry, University of Durham.
- LIEBIG, Dr. JUSTUS, University of Giessen.
- MURCHISON, RODERICK IMPEY, F.R.S., President of the Royal Geographical Society.
- PLATFAIR, Dr. LYON, Royal Institution, Manchester.
- SOLLY, EDWARD, Jun., Horticultural Society of London.
- SPRENGEL, Dr. CHARLES, Prussia.
- STEVENSON, The Hon. ANDREW, Washington.
- VAN DE WEYER, M. SYLVIAN, Belgian Minister.

## Royal Agricultural Society of England.

---

### GENERAL MEETING,

12, HANOVER SQUARE, MONDAY, DECEMBER 9, 1843.

---

#### REPORT OF THE COUNCIL.

THE Annual Country Meetings of the Royal Agricultural Society of England have already been attended with so many important results to the particular districts in which they have taken place, and to the kingdom at large, that the details affecting their future regulation, and the best means of rendering them still further useful and effective, are topics which have engaged much of the attention of the Council during the past half-year.

The Meeting at Oxford was eminently successful, and its arrangements, for so novel an undertaking, were in every respect adequate to the occasion. As a spontaneous assemblage of the friends of agricultural improvement, formed for the purpose of carrying out a great national object, that memorable first Country Meeting of the Society will, perhaps, never be rivalled; but, in point of magnitude and detail in the department of the exhibition of stock and implements, a rapid increase has annually taken place, and in a ratio this year so unprecedented, that at Derby the show-yard occupied twice the space of that of either Oxford or Cambridge, and contained nearly four times the number of animals, and more than seven times the number of implements, at Oxford; exceeding, in this amount, the successful exhibition even of Bristol by 165 animals and 251 implements, there having

been exhibited at the recent Derby Meeting, in July last, no less than 878 head of stock and 700 distinct implements. While, however, the excellence of the stock, and the number, variety, and importance of the agricultural implements exhibited on that occasion, formed a most gratifying proof of the success resulting from the Country Meetings of the Society, the corresponding increase in the details of the arrangements, and the general expenses attending the show, are circumstances which have required and received the serious consideration of the Council.

The Society have already voted their best thanks to the Mayor and corporation of Derby for the aid they so efficiently rendered to the Meeting in the preservation of the peace and good order of the town; to Mr. Colvile, M.P., and the Local Committee, for their zealous co-operation in carrying out the details of the business immediately connected with the local arrangements; and to the various Railway Companies for the accommodation of special trains, and the remission of one-half the usual charges in favour of agricultural implements conveyed along their respective lines, which they granted to the members and the public. The Council are also sensible of the attention shown to the Society by the Magistrates, in the grant of the use of the County Hall for the purpose of the Council dinner; by the various owners and occupiers who placed their land at the disposal of the Society; and by Mr. Bromley, the Secretary of the South Derbyshire Agricultural Society, in the devotion of his time and exertions in fulfilling the duties of Secretary to the Local Committee.

The Council and Members of the Society, as well as the implement-makers and public at large, experienced considerable disappointment at the Derby Meeting, that they were deprived of the opportunity of witnessing a trial of implements on lighter soil than that at Rough Heanor, on which the heavy-land implements were worked, and for the use of which the Society were indebted to the liberality of Mr. Chandos Pole, the proprietor. The Council have taken every measure which they think best adapted to prevent the recurrence of a similar disappointment; and in the meantime, at the suggestion of the Judges of Implements, they

have requested Mr. Jaques, of Easby Abbey, near Richmond in Yorkshire, to subject Lord Ducie's Uley cultivator and Messrs. Ransome's improved Biddell scarifier, with the consent of the respective makers, to the comparative trial of a whole season's work on soils of various texture. The Duke of Richmond, the Hon. Captain Spencer, and Mr. Jaques, have undertaken to test the respective merits of the dynamometers of Messrs. Cottam and Hallen, and Mr. Clyburn, when applied to the trial of the draught of agricultural implements; and Mr. Graburn has expressed his willingness to ascertain the effects of Messrs. Ransome's and Mr. Alexander Dean's portable metallic and stone corn-mills by constant use in his own household.

A Deputation of the Society was appointed to visit Southampton immediately at the close of the Derby Meeting, for the purpose of inspecting the various sites for the show-yard, pavilion, and Council-dinner; and being received by the mayor and corporation, they were conducted to the several localities considered to be most suitable for those objects. After receiving their report, the Council decided to select as the site of the show-yard a portion of Southampton Common, originally offered to the Society by the mayor and corporation, and directed a communication of that decision to be made to the mayor, who has since that time transmitted to the Council the resolutions of a public meeting of the rate-payers and commoners of the town, unanimously expressing their most cheerful and cordial co-operation with the corporation in sanctioning the application of any portion of the common that may be required for the purposes of the Society. Mr. Miles, M.P., Mr. Shelley, and Mr. Gibbs, were deputed accordingly to inspect the localities most suitable for the show-yard and pavilion; and those gentlemen, having made their report to the Council on those points, it was found that the site most advantageously situated for the show-yard would comprise a considerable portion of the race-course; and the president having therefore communicated that circumstance to the mayor, he informed the president in reply, that the portion of the race-course thus included within the proposed area of the show-yard would be willingly ceded, and every

accommodation in the power of the authorities and inhabitants of Southampton to grant, would be readily arranged on their part to meet the wishes of the Society.

The Council have appointed Mr. Miles, M.P., and Mr. Shelley, to be the Stewards of the Implement Department, with full power to take every measure to render the exhibition and trial of implements in every respect satisfactory at the Southampton Meeting.

The Council have appointed Mr. Parkes to be the Consulting Engineer of the Society; to be remunerated, when employed in that capacity, either by the Council from the funds of the Society, or by individual members at the usual rate of professional charge. Mr. Parkes, as a civil engineer, has long maintained a high standing in his profession, and as a judge of implements, and author of the valuable reports on the exhibition and trial of the implements at the Liverpool and Bristol Meetings, is well known to the members of the Society at large. In addition to Mr. Parkes as the Consulting Engineer of the Society, the Council have decided that a greater number of judges of implements, including practical farmers, shall be appointed: also, that the exhibition of implements on the Tuesday and Wednesday previously to the principal day of the show, shall be open at 2s. 6d. on each of those two days, instead of at 5s. as heretofore. They have limited the accommodation in the pavilion to the number of 1400 persons; and decided that tickets for the pavilion dinner shall be reserved for members until twelve o'clock of the day of the dinner, and afterwards sold to the public. They have fixed the time of the meeting as the fourth week of July, Thursday, the 25th, being the principal day of the show. The Council have settled all the prizes for the Southampton Meeting, including among those for stock special local prizes for cattle of the Channel Islands' breed, and for short-woolled sheep not qualified to compete as Southdowns: all certificates for implements being required to be sent to the Secretary on or before the 1st of May, and all others on or before the 1st of June; and the Council have decided that, after those dates respectively, no certificate shall be received under any pretence whatever.



The Finance Committee have laid before the Council the detailed balance-sheet of the Derby Meeting account, from which it appears that the receipts on account of that Meeting were 3390*l.*, while the expenditure had been 5090*l.* 17*s.* 1*d.*, being an excess of expenditure over the receipts of 1700*l.* 17*s.* 1*d.* chargeable on the funds of the Society. The Council trust that they will be enabled to prevent the recurrence of such a deficit at the ensuing country meeting.

The Finance Committee have also laid before the Council the following statement of the arrears of subscription at the present time, in comparison with their amount at the last December meeting:—

	£.	s.	d.
Amount of Arrears in December, 1842 . . . . .	3705	0	0
Ditto of the same Arrears in December, 1843 . . . . .	1614	0	0
Total amount of such Arrears paid or discharged } 2091 0 0			
during the last twelve months . . . . .			

By the new regulation, all subscriptions of the present year, due in advance on the 1st of January last, became in arrear on the 1st of June ensuing; and agreeably with such rule, the amount of subscriptions in arrear for 1843 is only 1879*l.*, a proportion of the year's subscriptions by no means great when it is taken into consideration that the fact of such new rule being in operation may not be known by the members generally who are thus in arrear.

The Committee have laid before the Council the following Statement of the Members remaining on the list of the Society after the removal of such names as were referred to by the Council in their last Report to the General Meeting in May:—

Life governors . . . . .	94
Governors . . . . .	209
Life members . . . . .	429
Members . . . . .	6155
Honorary members . . . . .	15
	6902

The Journal Committee have reported to the Council the adjudication of the Society's gold medal, along with Mr. Slaney's

addition of 10*l.* to the prize, for the best Essay on the Construction of Cottages, to the Rev. COPINGER HILL, of Buxhall, near Stowmarket; and the completion of the new part of the 'Journal,' which will be published in a few days.

The Council have to acknowledge the favour Professor Brande has conferred on the members, in delivering to them, at the request of Earl Spencer, your President, two Lectures in the Theatre of the Royal Institution, on the Chemical Constitution of Lime and Clay.

The judges of the seed-wheat selected for trial at the Bristol Meeting having made their respective reports of the results obtained in cultivating the selected wheats along with well-known varieties of the neighbourhood in which each trial was made, the Council have decided, that although the white wheat promised favourably under certain circumstances, they had not at that time sufficient proof before them that it possessed the requisite amount of merit for the Society's prize; while the two reds were very inferior in every respect. As the comparison had been made during an unfavourable season, the Council have decided that the white wheat shall have the advantage of a further trial.

Agreeably with the Charter, the Council have filled up the vacancies in their body occasioned by the lamented deaths of Mr. Woods Page, Mr. Webb Hall, and the Rev. Mr. Rham, by the election of Mr. Compton, M.P. *vice* Mr. Page, to go out by rotation in 1844; Mr. Etwall, M.P. *vice* Mr. Webb Hall, to go out by rotation in 1844; Mr. John Hudson, of Castleacre, Norfolk, *vice* the Rev. Mr. Rham, to go out by rotation in 1845.

In conclusion, the Council have much satisfaction in reporting the increasing recognition of the utility of the Society, by the accession of members of all classes throughout the various districts into which the kingdom has been divided for the purposes of holding its country meetings; and though the increasing numbers will generally be found in the peculiar locality of the year, still a very large addition is at the same time going on from every part of the country.

By order of the Council,

JAMES HUDSON, SECRETARY.

### General Meetings of 1844-5.

---

The ANNUAL COUNTRY MEETING, at Southampton: principal day of the Show, Thursday, July 25, 1844.

The GENERAL DECEMBER MEETING, in London, on the Saturday of the Smithfield Club Show-week: 1844.

The GENERAL MAY MEETING, in London, on Thursday, May 22, 1845.

The ANNUAL COUNTRY MEETING, at Shrewsbury, in 1845.

---

---

COTTAGE ECONOMY.—Mr. Main's article on Cottage Gardening, and Mr. Burke's compilation on Cottage Economy and Cookery, have each been reprinted from the Journal in a separate form, for cheap distribution. Either or both of these tracts may be obtained by members at the rate of 1s. per dozen copies, on their enclosing to the Secretary a Post-office money-order for the number required; at the same time stating the most eligible mode of conveyance by which the copies can be transmitted to their address. They are also sold to the public at 2*l.* each, by the Society's Publisher, Mr. MURRAY, 50, Albemarle Street, London.

VOLUMES OF THE JOURNAL.—The first Volume of the Journal consists of *four* parts, the second and third Volumes of *three* parts each (the second and third parts of the third Volume being comprised in a double number), and the fourth of *two* parts. The Journal is now published half-yearly, namely, in half-volumes, at the beginning and middle of each year.

SUBSCRIPTIONS may be paid to the Secretary, in the most direct and satisfactory manner, by means of Post-office orders, to be obtained on application at any of the principal Post-offices throughout the kingdom. They are due in advance, for each year, on the 1st of January; and are in arrear if unpaid by the 1st of June ensuing. No Member is entitled to the Journal whose subscription is in arrear.

---

---

ROYAL AGRICULTURAL SOCIETY OF ENGLAND.

Statement of Accounts from January 1 to June 30, 1843.

RECEIPTS.		PAYMENTS.	
£.	s. d.	£.	s. d.
Balance in the hands of the Bankers, Dec. 31, 1842 . . . . .	656 3 4	Investment of 988 <i>l.</i> 12 <i>s.</i> 5 <i>d.</i> Stock . . . . .	1013 6 8
Balance in the hands of the Secretary, Dec. 31, 1842 . . . . .	26 12 4	Permanent Charges . . . . .	531 5 0
Dividends on Stock . . . . .	114 0 6	Taxes and Rates . . . . .	50 1 10
Governors' Life Compositions . . . . .	90 0 0	Establishment and Building Work . . . . .	1235 5 11
Members' Life Compositions . . . . .	345 0 0	Postage and Carriage . . . . .	61 15 11
Governors' Annual Subscriptions . . . . .	890 10 0	Advertisements . . . . .	95 15 0
Members' Annual Subscriptions . . . . .	3688 8 0	Expenses of Journals . . . . .	564 2 1
Sale of Cottage Tracts . . . . .	13 19 8	Country Meetings (during the half-year) . . . . .	701 3 3
Sale of butter sent in for competition for the Society's prize . . . . .	0 14 8	Prizes for Essays, half a year . . . . .	60 0 0
Receipts on account of Bristol Meeting . . . . .	30 10 0	Miscellaneous Charges . . . . .	31 16 8
		Balance in the hands of the Bankers, June 30, 1843 . . . . .	1509 19 10
		Balance in the hands of the Secretary, June 30, 1843 . . . . .	1 6 4
			<hr/> £5855 18 6

Audited December 8, 1843.

(Signed) C. H. TURNER.  
CHAS. TAWNEY.

(Signed) THOMAS R. BARKER, Chairman, Finance Com.  
C. B. CHALLONER.  
THOMAS AUSTEN.  
HENRY BLANSHARD.



## Royal Agricultural Society of England.

---

### GENERAL MEETING.

MAY 22, 1844.

---

### REPORT OF THE COUNCIL.

THE Council, in laying before the Members, at their present General Meeting, their Half-yearly Report on the state and prospects of the Society, at the completion of the sixth year from the date of its foundation, have the satisfaction of recording the progressive fulfilment of its various objects

The excitement which attended its original formation, and the rapidity with which the importance of those objects was recognised by the friends of agriculture in every part of the kingdom, at once swelled the list of its members to an extent unprecedented in the history of any similar institution. That excitement, having roused the attention of the cultivators of the soil to the fact of the great resources within their own immediate power, has led them to seek, with practical caution, but with an energy also proportionate to the advantages to be gained, those means by which the objects in view have appeared to them most likely to be attained, and rendered applicable to their local circumstances. Not only have the leading agriculturists of the kingdom come forward to aid the Council in carrying out, to the best of their power, the general collection and discussion of facts having an important bearing on

the various branches of agricultural improvement, both personally at their meetings and as contributors through the pages of the *Journal*; but within their own local sphere in the country they have, in many instances, been instrumental in reviving the spirit of existing associations, or of establishing new societies or clubs of practical farmers, for the observation, collection, and discussion of such practical results as more immediately refer, in the first instance, to the improvement of their own local agriculture, but become afterwards generally applicable to other localities placed under the same circumstances of aspect, soil, and cultivation.

It has been the uniform desire of the Council to avail themselves of every opportunity by which the operations of the Society may extend their influence, and convey sound and practical information, through the numerous classes of its members, distributed over the various districts of the kingdom. While preserving its fixed locality for the transaction of official business in the Metropolis as a centre, the Council have the satisfaction of referring, with great confidence, to the signal success which has attended the means of communication afforded by the distribution of the *Journal*, the circulation of *Cottage Tracts* reprinted from its pages, and the change from year to year of the locality in which the country meetings are held. In the more concentrated sphere of its legislative and official duties, the Council have to report the active measures taken by their various committees to simplify the details connected with their respective departments, and to avail themselves of such results of experience as render the general transaction of business gradually more uniform, exact, and satisfactory.

The Society consists of the following members, namely,—

Life governors . . . . .	95
Annual ditto . . . . .	214
Life members . . . . .	442
Annual ditto . . . . .	6161
Honorary ditto . . . . .	15

making a total of 6927 members on the books of the Society at the present time; and the Council have the satisfaction of reporting the steady accession of candidates from every part of the

kingdom, at each of their weekly meetings—no less than 274 new members having been elected during the last three months and a half. Since the last General Meeting in December, the Council, at the recommendation of the Finance Committee, have ordered the names of 249 members to be removed from the list of the Society. Of these, 31 were lost to the Society by death, and 157 struck out, either at their own request, on account chiefly of their having entered the Society, at the country meetings, for temporary purposes only, or on the decision of the Committee, who have maturely taken each case of exemption, claimed under a variety of circumstances, into their special consideration, while the remaining 61 have withdrawn their names from the Society for reasons assigned by them at variance with the fundamental rules of the charter.

The Finance Committee will lay before you the Auditors' Balance-Sheet of the accounts to the end of the year 1843; and, at the same time, report the actual state of the funds of the Society at the present time. They have also reported that at the last General Meeting in December, the arrears of subscription, due on previous years, to that date inclusively, amounted in the whole to 572*l.*, since which time they have been reduced by the sum of 112*l.* The Finance Committee having represented to the Council that in some instances they found great difficulty in recovering the arrears of subscription due to the Society, the following Resolution was passed, namely:—

“That a professional person be appointed to write letters, demanding arrears of subscription, to all such parties as shall be designated from time to time by the Finance Committee; and, in case of such applications not being successful, to take further legal steps for enforcing the payments due.”

That Committee have accordingly already taken preliminary steps, under professional direction, for the recovery of some of the remaining arrears; but they still trust that, by the prompt payment of what is due, ulterior legal measures may be rendered unnecessary.



The Council feel it their duty distinctly to state that the Charter gives to them the undoubted right of enforcing the demand for any money due to the Society in a court of law. If they are ever compelled to resort to that extreme measure, it will be with great regret; but it is their positive duty not to permit the useful objects for which the Society was established to be frustrated by allowing the actual receipts to fall short of the legitimate claims of the Society.

The Journal Committee have reported the unusual excellence and sound practical character of the whole of the numerous essays sent in this year to compete for the prizes of the Society. They have announced the decision of the Judges in reference to an outstanding essay of 1843, namely:—

TO MR. JOHN CLARKE, of Long Sutton, Lincolnshire, the award of the Society's prize of 15*l.* for the best essay on the management and application of farm-yard manure; and the following awards already made of the prizes for the present year, namely:—

TO MR. R. N. BACON, of Norwich, the prize of 50*l.*, for the best report on the present state of the agriculture of Norfolk.

TO MR. ROBERT BAKER, of Writtle, near Chelmsford, the prize of 50*l.*, for the best report on the present state of the agriculture of Essex.

TO MR. EDWARD LITTLE, of Lower Sheldon Farm, near Chippenham, the prize of 50*l.*, for the best report on the present state of the agriculture of Wiltshire.

TO MR. JOHN BRAVENDER, of Cirencester, the prize of 50*l.*, for the best essay on the indications of the fertility or barrenness of soils.

The Judges appointed to decide on the relative merits of the essays in the latter class have not only awarded the prize to Mr. Bravender, as announced, but have "highly commended" four of the remaining essays; and the Council having received from Mr. William Stace, of Berwick, near Lewes, Sussex, and Mr. John Arkell, of Hollow Farm, near Gloucester, the authors respectively of two of those essays, their full permission for the Journal

Committee to make any use of them of which they may be found available in carrying out the objects of the Society, have ordered their thanks for such favour to be returned to those gentlemen accordingly.

There having frequently existed a doubt how far it has been the intention of some of the writers of the essays to enter into communication with the officers of the Society, in reference to points of detail connected with their essays, the Council have adopted the following recommendations of the Journal Committee on this subject :—

- “ 1. That competitors shall be required to enclose their names in a cover, on which only their motto and the subject of their papers, with the number of that subject in the Prize List of the Society, shall be written.
- “ 2. That the Chairman of the Journal Committee alone shall be empowered to open the motto-paper of such essays not obtaining the prize as he may think likely to be useful for the Society’s objects; with a view of consulting the writer confidentially, as to his willingness to place such paper at the disposal of the Journal Committee.”

The following recommendation of the Journal Committee on the subjects and amount of prizes for the essays of next year, has also been adopted by the Council—the conditions of which will be announced, as usual, in the Appendix to the next Journal,—the essays for these prizes being required to be sent to the Secretary on or before the 1st of March, 1845 :—

50*l.*—On the farming of Nottinghamshire.

50*l.*—On the farming of Cornwall.

50*l.*—On the farming of Kent.

20*l.*—On the best method of reclaiming heath-land.

10*l.*—On the advantages of one-horse carts.

20*l.*—On catch-meadows.

20*l.*—On fences.

10*l.*—On the best method of fattening cattle.

20*l.*—On the cheapest mode of establishing a tile-yard.

50*l.*—On the Dutch method of curing butter.

20*l.*—For the best experiment in agriculture.

The General Southampton Committee have reported their arrangements for the Meeting of the present year at that town in July next; and the Council have ordered an extensive announcement of the prizes to be awarded on that occasion, amounting to upwards of 1400*l.*, to be made by publication in the Journal, distribution of the prize-sheets, and advertisement in the public papers. They have the satisfaction of announcing that the implements entered for exhibition and trial at the Southampton Meeting already exceed by 123 the number of those at the Derby Meeting. The Council have decided that the Annual Country Meeting for the North Wales District shall be held at Shrewsbury in 1845.

The Council have entered into a satisfactory arrangement with the executor of the late Mr. Webb Hall for the purchase, by valuation, of the library of the late Board of Agriculture, bestowed upon his father at its dissolution.

The Council have unanimously appointed Messrs. Thomas Gibbs and Co., of Half-moon Street, Piccadilly, to be the seedsmen to the Society.

The Council think it desirable to state, in conclusion, that all their Weekly Meetings, excepting that on the first Wednesday of the month, are set apart for the reception and discussion of agricultural communications, and that all members of the Society have the privilege of being present on those occasions. The experience which the Council have already had of the sound and practical suggestions made to them at those Meetings, and the interesting discussions which have frequently arisen thereupon, induces them to invite all the members who may happen to be in London on the days of meeting to avail themselves of this privilege,—begging to assure them that their attendance on such occasions will be as acceptable to the Council, as it is at all times uniformly desired.

By order of the Council,

JAMES HUDSON, SECRETARY.

## ROYAL AGRICULTURAL SOCIETY OF ENGLAND.

Statement of Accounts from June 30th to December 31st, 1843.

RECEIPTS.		£. s. d.	PAYMENTS.		£. s. d.
Balance in the hands of the Bankers, June 30th, 1843		1509 19 10	Permanent Charges		260 12 6
Ditto in the hands of the Secretary, June 30th, 1843		1 6 4	Taxes and Rates		17 1 5
Half-Year's Dividends on Stock		130 16 6	Establishment Charges		408 3 9
Life Compositions of Governors		90 0 0	Postage and Carriage		12 12 10
Life Compositions of Members		217 0 0	Advertisements		13 10 0
Annual Subscriptions of Governors		183 0 0	Expenses of Journal		641 16 3
Annual Subscriptions of Members		1124 3 0	Prizes		1271 0 0
Sale of Journal		83 14 1	Miscellaneous Payments		24 5 11
Sale of Cottage Tracts		9 6 6	Payments during the half-year on account of the Country Meetings		922 4 1
Receipts during the half-year on account of the Country Meetings		856 14 3	Balance in the hands of the Bankers, Dec. 31st, 1843		657 11 8
			Balance in the hands of the Secretary, Dec. 31st, 1842		11 2 1
					<u>£4246 0 6</u>

(Signed)

THOMAS RAYMOND BARKER, Chairman.

C. B. CHALLONER.

HENRY BLANSHARD.

Examined and audited the 17th day of May, 1844.  
(Signed)

C. H. TURNER.

CHARLES TAWNEY.

# Annual Country Meeting of 1845,

TO BE HELD AT

## SHREWSBURY,

IN THE NORTH WALES DISTRICT, COMPRISING THE COUNTIES OF ANGLESEY, CARNARVON, MERIONETH, MONTGOMERY, DENBIGH, FLINT, CHESTER, SALOP, AND STAFFORD.

THE PRIZES ARE OPEN TO GENERAL COMPETITION.

FORMS OF CERTIFICATE TO BE PROCURED ON APPLICATION TO THE SECRETARY, 12, HANOVER SQUARE, LONDON.

ALL CERTIFICATES FOR IMPLEMENTS MUST BE RETURNED, FILLED UP, TO THE SECRETARY ON OR BEFORE THE 1ST OF MAY, AND ALL OTHER CERTIFICATES BY THE 1ST OF JUNE; THE COUNCIL HAVING DECIDED THAT IN NO CASE WHATEVER SHALL ANY CERTIFICATE BE RECEIVED AFTER THOSE DATES RESPECTIVELY.

### *Prizes for Improving the Breed of Cattle.—1845.*

#### SHORT-HORNS.

CLASS

1. To the owner of the best Bull calved previously to the 1st of January, 1843 . . . . . Thirty Sovereigns.  
To the owner of the second-best ditto ditto . . . . . Fifteen Sovereigns.
2. To the owner of the best Bull calved since the 1st of January, 1843, and more than one year old . . . . . Twenty Sovereigns.
3. To the owner of the best Cow in milk or in calf . . . . . Fifteen Sovereigns.  
[In the case of the cow being in calf, and not in milk, the prize will not be given until she is certified to have produced a calf.]
4. To the owner of the best In-calf Heifer, not exceeding three years old . . . . . Fifteen Sovereigns.
5. To the owner of the best Yearling Heifer . . . . . Ten Sovereigns.
6. To the owner of the best Bull-calf, not exceeding one year old . . . . . Ten Sovereigns.

#### HEREFORDS.

1. To the owner of the best Bull calved previously to the 1st of January, 1843 . . . . . Thirty Sovereigns.  
To the owner of the second-best ditto ditto . . . . . Fifteen Sovereigns.

## CLASS

2. To the owner of the best Bull calved since the 1st of January, 1843, and more than one year old . . . . . Twenty Sovereigns.
3. To the owner of the best Cow in milk or in calf Fifteen Sovereigns.  
[In the case of the cow being in calf, and not in milk, the prize will not be given until she is certified to have produced a calf.]
4. To the owner of the best In-calf Heifer, not exceeding three years old . . . . . Fifteen Sovereigns.
5. To the owner of the best Yearling Heifer . . . Ten Sovereigns.
6. To the owner of the best Bull-calf, not exceeding one year old . . . . . Ten Sovereigns.

## DEVONS.

1. To the owner of the best Bull calved previously to the 1st of January, 1843 . . . . . Thirty Sovereigns.  
To the owner of the second-best ditto ditto . . . Fifteen Sovereigns.
2. To the owner of the best Bull calved since the 1st of January, 1843, and more than one year old . . . . . Twenty Sovereigns.
3. To the owner of the best Cow in milk or in calf Fifteen Sovereigns.  
[In the case of the cow being in calf, and not in milk, the prize will not be given until she is certified to have produced a calf.]
4. To the owner of the best In-calf Heifer, not exceeding three years old . . . . . Fifteen Sovereigns.
5. To the owner of the best Yearling Heifer . . . Ten Sovereigns.
6. To the owner of the best Bull-calf, not exceeding one year old . . . . . Ten Sovereigns.

## CATTLE OF ANY BREED:

*Not qualified to compete in the foregoing Classes.*

1. To the owner of the best Bull calved previously to the 1st of January, 1843 . . . . . Twenty Sovereigns.  
To the owner of the second-best ditto ditto . . . Ten Sovereigns.
  2. To the owner of the best Bull calved since the 1st of January, 1843, and more than one year old . . . . . Fifteen Sovereigns.
  3. To the owner of the best Cow in milk . . . Fifteen Sovereigns.  
[In the case of the cow being in calf, and not in milk, the prize will not be given until she is certified to have produced a calf.]
  4. To the owner of the best In-calf Heifer, not exceeding three years old . . . . . Ten Sovereigns.
  5. To the owner of the best Yearling Heifer . . . Ten Sovereigns.
-

HORSES.

CLASS

1. To the owner of the best Stallion for Agricultural purposes, of any age . . . . . Thirty Sovereigns.  
     To the owner of the second-best ditto ditto . . . . . Fifteen Sovereigns.
2. To the owner of the best three-years-old ditto . . . . . Fifteen Sovereigns.
3. To the owner of the best two-years-old ditto . . . . . Fifteen Sovereigns.
4. To the owner of the best Mare and Foal for Agricultural purposes . . . . . Twenty Sovereigns.  
     To the owner of the second-best ditto . . . . . Ten Sovereigns.
5. To the owner of the best two-years-old Filly . . . . . Ten Sovereigns.
6. To the owner of the best THOROUGH-BRED STALLION, which shall have served Mares at a price not exceeding three guineas (and with a groom's fee of not more than five shillings), in the season of 1845 . . . . . Thirty Sovereigns.

S H E E P.

*Prizes for Improving the Breed of Sheep.—1845.*

LEICESTERS.

1. To the owner of the best Shearling Ram . . . . . Thirty Sovereigns.  
     To the owner of the second-best ditto . . . . . Fifteen Sovereigns.
2. To the owner of the best Ram of any other age . . . . . Thirty Sovereigns.  
     To the owner of the second-best ditto . . . . . Fifteen Sovereigns.
3. To the owner of the best pen of Five Shearling Ewes . . . . . Ten Sovereigns.  
     To the owner of the second-best ditto ditto . . . . . Five Sovereigns.

SOUTH-DOWN SHEEP.

1. To the owner of the best Shearling Ram . . . . . Thirty Sovereigns.  
     To the owner of the second-best ditto . . . . . Fifteen Sovereigns.
2. To the owner of the best Ram of any other age . . . . . Thirty Sovereigns.  
     To the owner of the second-best ditto . . . . . Fifteen Sovereigns.
3. To the owner of the best pen of Five Shearling Ewes . . . . . Ten Sovereigns.  
     To the owner of the second-best ditto ditto . . . . . Five Sovereigns.

LONG-WOOLLED SHEEP :

*Not qualified to compete as Leicesters.*

1. To the owner of the best Shearling Ram . . . . . Thirty Sovereigns.  
     To the owner of the second-best ditto . . . . . Fifteen Sovereigns.
2. To the owner of the best Ram of any other age . . . . . Thirty Sovereigns.  
     To the owner of the second-best ditto . . . . . Fifteen Sovereigns.
3. To the owner of the best pen of Five Shearling Ewes . . . . . Ten Sovereigns.  
     To the owner of the second-best ditto ditto . . . . . Five Sovereigns.

## SHEEP BEST ADAPTED TO A MOUNTAIN-DISTRICT.

## CLASS

1. To the owner of the best Ram of any age . . . Fifteen Sovereigns.  
    To the owner of the second-best ditto . . . Ten Sovereigns.  
    To the owner of the third-best ditto . . . Five Sovereigns.
  2. To the owner of the best pen of Ewes of any age Ten Sovereigns.  
    To the owner of the second-best ditto . . . Five Sovereigns.
- 

## PIGS.

1. To the owner of the best Boar of a large breed . Ten Sovereigns.  
    To the owner of the second-best ditto ditto . . . Five Sovereigns.
  2. To the owner of the best Boar of a small breed. Ten Sovereigns.  
    To the owner of the second-best ditto ditto . . . Five Sovereigns.
  3. To the owner of the best breeding Sow of a large  
    breed . . . . . Ten Sovereigns.
  4. To the owner of the best breeding Sow of a small  
    breed . . . . . Ten Sovereigns.
  5. To the owner of the best pen of three breeding  
    Sow-Pigs of the same litter, above four and  
    under ten months old . . . . . Ten Sovereigns.
- 

## AGRICULTURAL IMPLEMENTS.

A sum not exceeding Three Hundred Sovereigns.

---

## CHEESE.

- To the exhibitor of the best hundredweight of  
 Cheese (of any kind) made within the dis-  
 trict . . . . . Ten sovereigns.  
 To the exhibitor of the second-best ditto . . . Five Sovereigns.
- 

## EXTRA STOCK, ROOTS, AND SEEDS.

For Extra Stock of any kind, not shown for any of  
 the above Prizes, and for Roots, Seeds, &c.,  
 Prizes may be awarded and apportioned, by the  
 Committee and Judges, to an amount not ex-  
 ceeding in the whole . . . . . Fifty Sovereigns.

---

## ANY NEW IMPLEMENT.

For the Invention of any new Agricultural Implement, such sum as  
 the Council may think proper to award.



SEED-WHEAT, BARLEY, AND OATS.

I. Fifteen Sovereigns, or a Piece of Plate of that value, will be given to the Exhibitor, at the Meeting at Shrewsbury, of the best 14 bushels of White Wheat, of the harvest of 1844, and grown by himself.

II. Fifteen Sovereigns, or a Piece of Plate of that value, will be given to the Exhibitor, at the Meeting at Shrewsbury, of the best 14 bushels of Red Wheat, of the harvest of 1844, and grown by himself.

III. Ten Sovereigns, or a Piece of Plate of that value, will be given to the Exhibitor, at the Meeting at Shrewsbury, of the best 14 bushels of Spring Wheat, of the harvest of 1844, and grown by himself.

IV. Ten Sovereigns, or a Piece of Plate of that value, will be given to the Exhibitor, at the Meeting at Shrewsbury, of the best 14 bushels of Barley for malting, of the harvest of 1844, and grown by himself.

V. Ten Sovereigns, or a Piece of Plate of that value, will be given to the Exhibitor, at the Meeting at Shrewsbury, of the best 14 bushels of Oats, of the harvest of 1844, and grown by himself.

Competitors are requested to send with their wheat, barley, or oats, specimens, fairly taken, of the same in the ear, with the whole of the straw, in a sheaf not less than one foot in diameter, and with the roots attached.

[12 bushels of the wheat, barley, or oats will be sealed up by the Director or Stewards, and one of the remaining bushels of each variety will be exhibited as a sample to the public; the other being kept for comparison with the produce of the next year. At the General Meeting in December, 1846, the prizes will be awarded.]

The two best samples of each of these classes of wheat, barley, or oats, without at that time distinguishing, in any of the cases, between the comparative merits of either sample, will be selected by the Judges appointed for the Meeting at Shrewsbury; and will be sown, under the direction of the Council (the winter wheats in the autumn of 1845, and the spring wheat not earlier than the 1st of March, 1846), by four farmers, who will make their report, upon which the prizes will be awarded, provided there be sufficient merit in any of the samples. Ten Sovereigns will be given at the Meeting at Shrewsbury to each Exhibitor whose Wheat has been selected for trial, and Six Sovereigns for the Barley or Oats.

\* \* No variety which has been selected for trial at any previous show shall be qualified to compete in the same class.

---

ESSAYS AND REPORTS ON VARIOUS SUBJECTS.

---

Prizes for 1845.

---

PRIZE ESSAYS.

I. FARMING OF NOTTINGHAMSHIRE.

FIFTY SOVEREIGNS, or a Piece of Plate of that value, will be given for the best Report on the Farming of the County of Nottingham.

Competitors will be expected to describe the different varieties of soil which prevail in the county, the ordinary modes of farming and courses of cropping adopted accordingly in its various districts, and to state how far any peculiar practices in its husbandry are or are not justified by peculiarities of soil or climate. They will also be expected to state what improvements have been made in the farming of Nottinghamshire since the Report of Mr. Robert Lowe in the year 1798; and especially to point out what further improvements ought to be effected, either by better farming on land already cultivated, or by taking new land into cultivation.

II. FARMING OF CORNWALL.

FIFTY SOVEREIGNS, or a Piece of Plate of that value, will be given for the best Report on the Farming of the County of Cornwall.

Competitors will be expected to describe the different varieties of soil which prevail in the county, the ordinary modes of farming and courses of cropping adopted accordingly in its various districts, and to state how far any peculiar practices in its husbandry are or are not justified by peculiarities of soil or climate. They will also be expected to state what improvements have been made in the farming of Cornwall since the Report of Mr. G. B. Worgan in the year 1811; and especially to point out what further improvements ought to be effected, either by better farming on land already cultivated, or by taking new land into cultivation.

III. FARMING OF KENT.

FIFTY SOVEREIGNS, or a Piece of Plate of that value, will be given for the best Report on the Farming of the County of Kent.

Competitors will be expected to describe the different varieties of soil which prevail in the county, the ordinary modes of farming and courses of cropping adopted accordingly in its various districts, and to state how far any peculiar practices in its husbandry are or are not justified by peculiarities of soil or climate. They will also be expected to state what improvements have been made in the farming of Kent since

the Report of Mr. John Boys in 1805; and especially to point out what further improvements ought to be effected, either by better farming on land already cultivated, or by taking new land into cultivation.

#### IV. HEATH-LAND.

TWENTY SOVEREIGNS, or a Piece of Plate of that value, will be given for an account of the best method of Reclaiming Heath-land.

Competitors will be required to describe methods which have been successfully adopted in the reclaiming of heath-land, reference being had especially to the following points:—

1. The mode of breaking up, whether by paring and burning, or by simple ploughing.
2. The application of lime.
3. The course of cropping.
4. The conversion of heath-land into pasture, where either the steepness of the land, or its elevation above the sea, does not allow the culture of corn.

#### V. ONE-HORSE CARTS.

TEN SOVEREIGNS, or a Piece of Plate of that value, will be given for the best Essay on the advantages of One-horse Carts.

Competitors will be required to point out the saving in horse-labour, and other advantages which undoubtedly arise from the substitution of one-horse carts for waggons.

#### VI. CATCH-MEADOWS.

TWENTY SOVEREIGNS, or a Piece of Plate of that value, will be given for the best Essay on Catch-Meadows.

Competitors will be required to describe the best and cheapest method of forming water-meadows on the sides of natural slopes, as practised in Somersetshire and Devonshire; the mode of managing them, and of applying their produce; the increase of value thereby given to unproductive hill-sides; and to state how far this mode of improvement might be applied to the mountainous districts of Wales and of the North of England.

#### VII. FENCES.

TWENTY SOVEREIGNS, or a Piece of Plate of that value, will be given for the best Essay on Fences.

Competitors will be required to describe the best and neatest methods of maintaining hedges, whether for arable or for grazing ground; and to point out how far the present fences in various parts of England are injurious to the farmer, whether by their size, their excess in number, or the over-abundance of timber which they contain.

#### VIII. FATTENING CATTLE.

TEN SOVEREIGNS, or a Piece of Plate of that value, will be given for an account of the best method of fattening cattle; as to the places in which they are kept, large or small yards or stalls; as well as the food, roots, hay, &c., on which they are fed during the time of fattening.

## IX. TILE-YARDS.

TWENTY SOVEREIGNS, or a Piece of Plate of that value, will be given for the cheapest and best method of establishing a Tile-yard.

Competitors will be required to attend to the following points:—

1. Mode of working the clay, according to its quality.
2. Machine for making the tiles.
3. Sheds for drying the tiles.
4. Construction of the kiln.
5. Cost of forming the establishment.
6. Cost of the tiles when ready for sale.

## X. CURING BUTTER.

FIFTY SOVEREIGNS, or a Piece of Plate of that value, will be given for the best description of the Dutch method of salting butter; pointing out the causes of its superiority to other salted butters.

## XI. EXPERIMENT IN AGRICULTURE.

TWENTY SOVEREIGNS, or a Piece of Plate of that value, will be given for an account of the best Experiment in Agriculture.

*These Essays must be sent to the Secretary, at 12, Hanover Square, London, on or before March 1st., 1845.*

## RULES OF COMPETITION FOR PRIZE ESSAYS.

1. All information contained in Prize Essays shall be founded on experience or observation, and not on simple reference to books, or other sources.

2. Drawings, specimens, or models, drawn or constructed to a given stated scale, shall accompany writings requiring them.

3. All competitors shall enclose their names and addresses in a cover, on which only their motto, and the subject of their Essay, and the number of that subject in the Prize list of the Society, shall be written.

4. The President or Chairman of the Council for the time being, shall open the cover on which the motto designating the Essay to which the Prize has been awarded is written, and shall declare the name of the author.

5. The Chairman of the Journal Committee shall alone be empowered to open the motto paper of such Essays, not obtaining the Prize, as he may think likely to be useful for the Society's objects, with a view of consulting the writer confidentially as to his willingness to place such paper at the disposal of the Journal Committee.

6. The copyright of all Essays gaining prizes shall belong to the Society, who shall accordingly have the power to publish the whole or any part of such Essays; and the other Essays will be returned on the application of the writers; but the Society do not make themselves responsible for their loss.

7. The Society are not bound to award a prize unless they consider one of the Essays deserving of it.

8. In all reports of experiments the expenses shall be accurately detailed.

9. The imperial weights and measures only are those by which calculations are to be made.

10. No prize shall be given for any Essay which has been already in print.

11. Prizes may be taken in money or plate, at the option of the successful candidate.

12. All Essays must be addressed to the Secretary, at the house of the Society.

## LAWS, BYE-LAWS, AND REGULATIONS.

---

### I.—LAWS CONTAINED IN THE CHARTER, WHICH CANNOT AT ANY TIME BE ALTERED OR DEPARTED FROM.

1. The Society is a corporate body, by the name of the Royal Agricultural Society of England, and a Common Seal.

2. It is a condition of the Royal Charter that a principle of the constitution of the Society shall be the total exclusion of all questions, at its meetings, or in its proceedings, of a political tendency, or having reference to measures pending or to be brought forward in either House of Parliament; which no resolution, bye-law, or other enactment of the said body politic and corporate shall, on any account or pretence whatever, be at any time allowed to infringe.

3. The number of subscribers shall be indefinite; and classed into Governors and Members.

4. Power is given to elect Honorary, Corresponding, and Foreign Members.

5. Three General Meetings to be held in each year: two of these in London, in the months of May and December; and the other in such part of England or Wales as shall be deemed most advantageous for the advancement of the objects of the Society. The General Meeting in London to be held on the 22nd (or, should that date fall on a Sunday, on the 23rd) of May.

6. The Governors and Members have full power to elect a President and Council at the general May Meeting; which President and Council, although then duly elected, shall nevertheless not come into office till the conclusion of the ensuing Annual Country Meeting to be held that year. All vacancies occurring in such officers and appointments, by resignation, death, or otherwise, to be filled up by election and the majority of votes of the remaining Members of such President and Council. The Council to consist of one President, twelve Trustees, and twelve Vice-Presidents, to be elected from the class of Governors only; and of fifty other Members, to be elected indiscriminately from the Governors and Members of the Society. The President to be an

annual officer of the Society; and not re-eligible to the office of President for three years. Twenty-five of the fifty general Members of the Council to go out each year by rotation, but may be re-elected.

7. The General Meeting in May shall elect the President, Trustees, Vice-Presidents, and other Members of Council, from the Governors and Members.

8. The Council to be regulated in their proceedings by such bye-laws as may and shall from time to time be enacted by them, conformably with the tenour of the Charter: no established bye-law being in any case altered, or new one proposed, without at least one month's notice of such intention being given to each Member of the Council.

9. The Council shall have power to appoint, and remove, one general Secretary to the Society; such Secretary to sue and be sued in their name and on their behalf.

10. The Council shall have the sole management of the income and funds of the said body politic and corporate; and also the entire management and superintendence of all other affairs and concerns thereof; and shall or may—but not inconsistently with or contrary to the provisions of the Charter, or any existing bye-law, or the laws of the land—do all such acts and deeds as shall appear to them necessary or essential to be done for the purpose of carrying into effect the objects and views of the said Royal Agricultural Society of England.

---

## II.—BYE-LAWS.

All existing Bye-Laws, Rules, and Regulations shall be rescinded, and the following be adopted in their places.

### *Governors and Members.*

Every candidate for admission into the Society must be proposed by a Member, the proposer to specify in writing the name, rank, usual place of residence, and post-town, of the candidate, either at a Council, or by letter to the Secretary. Every such proposal shall be read at the Council at which such proposal is made; or, in the case of the Candidate being proposed by a letter to the Secretary, at the first meeting of the Council next after such letter shall have been received. At the next Meeting of the Council the election shall take place, when the decision of the Council shall be taken by a show of hands; the majority of the Members present to elect or reject. The Secretary shall inform Members of their election by a letter, in such form as the Council may from time to time direct. All Members belong to the Society, and are

bound to pay their annual subscriptions, until they shall withdraw from it by a notice in writing to the Secretary. Governors to pay an annual subscription of 5*l.*, and Members of 1*l.*; all subscriptions being due on the 1st of January in each year; but when the election takes place in December, the subscription paid in that month will be considered as the subscription of the following year. Governors may compound for their lives by paying 50*l.*; Members, by paying 10*l.* On and after the 1st of June, the subscriptions due at that date, and remaining unpaid, are in arrear; and no Member whose subscription is so in arrear shall enjoy any of the privileges of the Society; nor will any such Member be allowed to enter into a composition for his future payments until such arrear be paid: and no Governor or Member shall be allowed to transfer his name from one class of Members to the other, respectively, without the express leave of the Council. Governors have the privilege of attending and speaking at all Meetings of the Council, but not of voting, unless forming part of such Council. All Members not in arrear are entitled, gratuitously, to the volume of the Journal in the course of publication at the date of their election, and to all subsequent Numbers; and have the privilege of inspecting all models presented to the Society, and of referring to the books in the library. An alphabetical Register shall be kept of all the Governors and Members, exhibiting the date of their election, and the subscriptions received or due from them, with the dates respectively of payment and arrear.—The Council having the power of electing Honorary Members, shall elect as Honorary Members such eminent individuals as have distinguished themselves in promoting the objects for which the Society was established; such Honorary Members shall not be called upon for the payment of any Subscriptions: they shall have the privilege of attending and speaking at the Meetings of the Society and of the Council, but not of voting at either.

Members may be dismissed from the Society in the following manner:—Any ten Members of the Society may send, in writing, signed by their names, to the Council, a request that any Member of the Society shall be dismissed from the Society. Such request shall be placed in a conspicuous part of the Council-room, and a copy thereof transmitted by the post to the Member proposed to be so dismissed signed by the Secretary. At the monthly Meeting of the Council which shall take place next after one month shall have elapsed after such request shall have been placed in the Council-room, the Council shall take the matter thereof into their consideration; but the Council shall not so take it into consideration unless twelve Members of the Council at the least shall be present. If this number is not present, the consideration of the request shall be adjourned to the next monthly Meeting of the

Council, and so on till a monthly Meeting shall take place at which twelve Members are present. If the Council so constituted shall unanimously agree to the dismissal of such Member, he shall be no longer a Member of the Society; but if they do not unanimously agree to his dismissal, their decision shall be considered to have been made in his favour: Provided always, that his dismissal shall not relieve him from the payment of any debt previously due by him to the Society; and that if a Life-Governor or Life-Member, he shall not have any claim to any portion of the commutation he has paid.

### *General Meetings.*

The two London General Meetings of the Society shall be held in the Council-room: public notice of such meetings being given in such newspapers as the Council may decide: and all elections (excepting that of the Council) and resolutions shall be determined by a show of hands. The General Meeting in December shall be held at such date in that month, and the Annual Meeting in the country at such time and place, as the Council may decide. Such place of Meeting in the Country being settled by the Council at the first Wednesday in May, and declared at the ensuing General Meeting in the year preceding such meeting. At the General Meetings in London, reports from the Council, with a financial statement, will be read: Members only, or individuals bearing the President's written order, will be allowed to be present, each person giving his name in writing on being admitted.

At the General Meeting in May, the election of the President, Vice-Presidents, and Trustees, having taken place by a show of hands, the election of the twenty-five members of the Council, who are to replace the twenty-five members who retire by rotation, shall take place in the following manner:—

1. A list of the members of the Council who retire by rotation, but who may be re-elected, shall be prepared on or before the 1st of May, for the inspection of members at the rooms of the Society.
2. The Council shall prepare a list of the twenty-five members whom they propose for election or re-election, which shall be printed on paper large enough to admit of additions being made to it; and a copy of this printed list shall be given to any member who applies for it of the Secretary, either on the day of the General Meeting, or on any of the three days previously (Sundays excepted), between the hours of ten and four.
3. The voting shall take place by each member who wishes to vote giving in one of these lists signed by himself, with such names



struck out or added as he thinks fit, to the President, at the General Meeting, before the commencement of any other business. When the lists have been given in, three scrutineers shall be appointed by the President, who will retire into another room, and inspect the lists which have been given in, and report forthwith to the meeting, in writing, the names of the twenty-five members who shall have the majority of votes; after which, the papers shall be immediately destroyed by the scrutineers. If any of the lists should contain the names of more than twenty-five members, it will not be counted as a valid vote. No member will be allowed to vote who does not personally deliver his list to the President. In the event of any equality of votes, the election to be decided by the meeting on a show of hands.

#### *The President.*

The President shall not be re-eligible to the office of President for three years from the day of his election. In all the official relations of the Society, he shall take precedence of all other Governors, Members, or Honorary Members, and shall have full power to summon at his pleasure meetings of the Council, and shall take the chair at every Council when present, he, and every other Chairman of the Society, having the privilege of a casting vote, in addition to his own, in all cases of equality in the division on any question. He shall sign all such letters, votes of thanks, and other documents, as the Council may direct, in the name and on the behalf of the Council.

#### *The Council.*

The Council may adjourn from time to time, at their discretion: when not so adjourned, they shall hold a meeting on the first Wednesday in every month, at twelve o'clock, for the transaction of the business of the Society; and shall also meet on every other Wednesday, at the same hour, for the purpose of receiving the proposals of candidates and for the election of Members, and hearing papers read: such Meetings to be held without summons; but should the business of the Society require a Special Council to be held at any other time, the President shall have full power to direct such a Council to be summoned, at such time and place, and with such notice, as he may think fit: provided that, in case of necessity, the President may summon a special Council to be held forthwith. In the absence of the President, one Trustee, together with one Vice-President, and three other Members of the Council, shall have power to summon the Council in any case of emergency, on deli-

vering to the Secretary an order signed by them for issuing the summonses, and allowing not less than seven days to elapse between the date of summons and the day appointed for the meeting of such Council.

The Monthly Meeting of the Council shall have the full power of originating, discussing, and deciding, by the majority of votes, on a show of hands, all questions brought before it on the business of the Society. Should, however, any Member then present regard any proposition brought forward as too important for immediate decision, he will be at liberty to take the sense of the Meeting whether such proposition should be postponed, in order that it may be duly discussed at the next Monthly Meeting; and should one-third of the Members present agree with him on that point, such proposition shall be postponed, and due notice of such motion and postponement shall be given to all Members of the Council by the Secretary.

In the absence of the President, the chair shall be taken by a Trustee or Vice-President; and should neither of such officers be present, then by such Member as the Council shall choose as their Chairman by the majority of votes. The Quorum of a Monthly or Special Council shall be five, and that of a Weekly Council three. At every Meeting of the Council the minutes of the previous Meeting shall be first read, and postponed matters shall take precedence in the order of business of new motions, excepting in the case of a Report from the Finance Committee, which shall always be taken first into consideration, immediately after the minutes have been read and the election of Members and proposal of candidates have taken place. All minutes or reports read at the Council shall be signed by the Chairman. The Common Seal of the Society shall be kept in a box with three different locks, the keys of which shall be respectively held by the President of the Society, the Chairman of the Finance Committee, and the Secretary: the Common Seal not being affixed to any instrument except in the Council-room during a Meeting of the Council. The Reports from the Council to the General Meetings in London, in May and December, shall be prepared at the Council on the first Wednesday in May and the first Wednesday in December, respectively, or at some adjournment of such Councils.

#### *Committees.*

The Standing Committees shall be appointed by the Monthly Council in December, but shall not enter on their respective duties until the first day of January, nor remain in force after the 31st of December of the ensuing year, unless re-appointed. Any other Committees may be appointed at a Monthly Council.

Each Committee, at its first Meeting, shall elect its own permanent Chairman, who shall always take the chair at the Committee, when present; the chair being taken in his absence by a Chairman to be elected by the Committee for the occasion: and all Committees shall meet by summons issued by direction of their respective Chairmen, or the President, or of any three Members of the Committee, or by adjournment. The President, Trustees, and Vice-Presidents, are Members *ex officio* of all Committees.

All Committees during their sittings may report the progress of their proceedings to the Monthly Meetings of the Council: such Committees shall sit till they have made their respective general reports; but in case such reports shall not have been made previously to the 31st of December next following their appointment, their powers shall then cease.

#### *Secretary.*

The Secretary shall devote the whole of his time to the affairs of the Society, and shall be immediately responsible to the Council for the discharge of the various duties they require him to perform. He shall attend the sittings of all Meetings of the Council. He shall also attend on any Committee requiring his presence, when not in attendance on the Council. He shall take the minutes of the Council; and also, when attending upon any Committee, the minutes of such Committee, if required to do so by the Chairman. He shall conduct the correspondence of the Society, preserving the letters he may receive in a classed arrangement. He shall keep letter-books, in which copies of all letters received by him, which he shall lay before the Council or any of the Committees, shall be entered, as well as copies of all those which he writes by direction of the President, Council, or Committees. Under the direction of the Finance Committee he shall receive or be responsible for all moneys received at the rooms of the Society, paying such sums into the hands of the Bankers, and producing at each Finance Committee their receipts for the same. He shall have the charge of the expenditure of petty cash: he shall have the custody of all books, models, and papers belonging to the Society. He shall have the immediate superintendence over the Clerks and the Servants of the Society; and shall be required to report to the Council any instances of misconduct on their part which he thinks of such a nature as to require the consideration of the Council. Agreeably with the Charter, the President and Council have the power by him, as their Secretary, of suing or being sued, and of contracting or discharging obligations, according to the special nature of the authority with which they may from time to time invest him, as their representative, for these several objects.

The Council shall have the power of appointing and removing such Clerks and servants as they may deem necessary; and of fixing their salaries.

*Finances.*

The Finance Committee shall have the immediate care of the Society's accounts, and no payment of money shall be made excepting at a Monthly Council, and unless recommended by the Report of the Finance Committee, which shall always meet on the first Wednesday in every month, without summons, previously to the sitting of the Council, in order to prepare a Report on the state of the Society's funds, which they shall present to each Monthly Meeting; and lay before it the following account:—

	£. s. d.		£. s. d.
Amount of Cash received } during the past month by } the Secretary, and paid } into the hands of Messrs. } Drummond, as per Bank- } ers' receipts . . . . }		Payments by order of the } Council . . . . }	
Ditto, received by Messrs. } Drummond on account of } the Society, as per Bankers' } book . . . . . }		Amount of expenditure } of Petty Cash . . . }	
Balance of Petty Cash in the } hands of the Secretary . }		Outstanding Bills . . .	
Balance at the Bankers' . .			

together with all the books in which entries of cash receipts or payments are made, and such documents as the business of the day may require. Should a sufficient number of Members to form a quorum not have assembled on the first Wednesday of any month, the Secretary shall report the balance-sheet of the Society's funds to the Council.

Twice in every year—namely, on the Friday previously to each of the London General Meetings—there shall be an audit of the accounts of the Society at eleven o'clock, when a balance-sheet shall be prepared, and reported to the General Meeting, and such balance-sheet published in the ensuing part of the Journal. The Auditors shall consist of the President, the Members of the Finance Committee, and of three Members not being Members of the Council or of any of the Committees (of whom two shall always be present) to be chosen at the

London General Meeting in December. The Trustees of the Society shall be ex-officio Members of such audits.

All drafts on the Bankers shall be signed by the President (or, in his absence, by the Chairman of the Council) and by one of the Trustees, being countersigned by the Secretary; and a book shall be kept in which a consecutive entry shall be made of all such payments.

#### *Journal.*

The Journal Committee shall have the care of the publication of the Journal; of which two parts shall be published every year. They shall decide on the papers which shall be printed in the successive parts of the Journal, and shall also recommend, at their discretion, the disposal to be made of communications important or interesting in their nature, but of a character unsuitable for the immediate objects of the Journal. The Committee, though responsible for the selection of matter, and the importance of its bearings in an agricultural point of view, are not responsible for the positive accuracy of the facts stated in the several papers—a circumstance depending on the judgment, caution, and observation of the authors themselves.

Each Member is entitled gratuitously to those parts of the Journal which have been published in the course of any year for which his subscription has been paid: but no Journals shall continue to be forwarded to any Member whose subscription is in arrear.

#### *Prizes.*

A List of all Prizes to be offered by the Society, for any particular year, shall be laid on the Table for suggestions and revision, at or before the Annual Meeting in the month of May in the year preceding; and shall be finally settled by the Council at a Special Meeting to be held on one of the last seven days in the following month of June; after which time no new Prizes shall be offered, or any alteration or increase of an old one made for the year in question.

#### *Prize-Essays.*

All information contained in Prize Essays shall be founded on experience or observation, and not on simple reference to books or other sources.

Drawings, specimens, or models, drawn or constructed to a stated scale, shall accompany writings requiring them.

All competitors shall enclose their names and addresses in a cover, on which only their motto, and the subject of their Essay, and the number of that subject in the Prize list of the Society, shall be written.

The President or Chairman of the Council, for the time being, shall open the cover on which the motto designating the Essay to which the Prize has been awarded is written, and shall declare the name of the author.

The Chairman of the Journal Committee shall alone be empowered to open the motto-paper of such Essays, not obtaining the Prize, as he may think likely to be useful for the Society's objects, with a view of consulting the writer confidentially as to his willingness to place such paper at the disposal of the Journal Committee.

The copyright of all Essays gaining prizes shall belong to the Society, who shall accordingly have the power to publish the whole or any part of such Essays; and the other Essays will be returned on the application of the writers; but the Society do not make themselves responsible for their loss.

The Society are not bound to award a prize unless they consider one of the Essays deserving of it.

In all reports of experiments the expenses shall be accurately detailed.

The imperial weights and measures only are those by which calculations are to be made.

No prize shall be given for any Essay which has been already in print.

Prizes may be taken in money or plate, at the option of the successful candidate.

All Essays must be addressed to the Secretary, at the house of the Society.

### *Library.*

There shall be a Library of the Society; of which a catalogue shall be kept: and all donations of books shall be referred to the Journal Committee to decide whether the books shall be accepted. A register shall be kept in which an entry shall be made of all presents of books which are so accepted, and of all seeds, implements, and models, together with the names of the donors.

No model, implement, or other object can be exhibited to the Society without leave from the Council.

### *Bye-Laws.*

No existing bye-law shall be altered, or any new one made, except at the Meeting of the Council, on the first Wednesday in May, or the first Wednesday in December, one month's notice having been

previously given in writing to the Council, and a copy of such notice having been sent by the Secretary to each of its Members: Provided always, that nothing in this bye-law shall prevent the bye-law proposed being altered or amended by the Council at the time it is under consideration.

All bye-laws shall be entered in a book to be kept for that purpose, and signed by the President and Secretary for the time being.

Passed at a Special Council held on the 16th of July, 1844.

(Signed) SPENCER, President.

JAMES HUDSON, Secretary.

### NOTICE.

It is requested that all communications, addressed to the Society, of experiments on land—whether of draining, liming, manuring, or other operation—be accompanied with the cost of such operation, with the value of the land to rent previous and subsequent thereto, and an analysis of the soil upon which such experiments have taken place; or a specimen of the soil, to be analysed by persons employed by the Society: it is also further requested that, in communications relative to experiments on land in foreign countries, the measures be stated in English values.

Those members who have tried subsoil-ploughing, whether successfully or otherwise, are requested to communicate the result to the Secretary, in the hope that, by comparison of the statements, some judgment may be arrived at as to the soils and situations which are, or are not, suited for this operation.



# Royal Agricultural Society of England.

1844—1845.

## President.

THE DUKE OF RICHMOND.

## Trustees.

Acland, Sir Thomas Dyke, Bart., M.P.  
Clive, Hon. Robert Henry, M.P.  
Downshire, Marquis of  
Graham, Rt. Hon. Sir Jas., Bart., M.P.  
Handley, Henry  
Lawley, Sir Francis, Bart.

Neeld, Joseph, M.P.  
Pusey, Philip, M.P.  
Richmond, Duke of  
Rutland, Duke of  
Spencer, Earl  
Sutherland, Duke of

## Vice-Presidents.

Buckingham, Duke of  
Chichester, Earl of  
Ducie, Earl of  
Exeter, Marquis of  
Fitzwilliam, Earl  
Gooch, Sir Thomas Sherlock, Bart.

Morgan, Sir Charles Gould, Bart.  
Northumberland, Duke of  
Portman, Lord  
Talbot, Earl  
Wellington, Duke of  
Worsley, Lord, M.P.

## General Members of Council.

Austen, Colonel Thomas  
Barclay, David, M.P.  
Baring, Hon. William Bingham, M.P.  
Barker, Thomas Raymond  
Benett, Johu, M.P.  
Bennett, Samuel  
Blanshard, Henry  
Bramston, Thomas William, M.P.  
Browne, W. R.  
Buller, Edward, M.P.  
Burke, J. French  
Challoner, Colonel  
Childers, John Walbanke, M.P.  
Ellman, John  
Fellowes, Edward, M.P.  
Gibbs, Humphrey  
Grantham, Stephen  
Hatherton, Lord  
Hayter, William Goodenough, M.P.  
Hill, Viscount  
Hillyard, C.  
Hobbs, William Fisher  
Hoskyns, Sir Hungerford, Bart.  
Hudson, John  
Hyett, William Henry

Johnstone, Sir John V. B., Bart., M.P.  
Jonas, Samuel  
Kimberley, George  
Kinder, John  
King, Fielder  
Lemon, Sir Charles, Bart., M.P.  
Meire, Thomas Lockley  
Miles, William, M.P.  
Pendarves, Edward W. Wynne, M.P.  
Price, Sir Robert, Bart.  
Pusey, Philip, M.P.  
Pym, Francis  
Ransome, James Allen  
Sanford, Edward Ayshford  
Sewell, Professor  
Shaw, William  
Shelley, John Villiers  
Slaney, Robert Aglionby  
Sotheron, Thomas H. S. E., M.P.  
Spencer, Hon. Captain  
Stansfield, W. R. Crompton, M.P.  
Stokes, Charles  
Thompson, Henry Stephen  
Wilbraham, George, M.P.  
Wilson, Henry

## Secretary.

JAMES HUDSON, 12, Hanover Square, London.

*Consulting Chemist*—Dr. LYON PLAYFAIR, Manchester.

*Consulting Engineer*—JOSIAH PARKES, C.E., 11, Great College Street, Westminster.

*Seedsmen*—Messrs. THOMAS GIBBS & Co., Corner of Halfmoon Street, Piccadilly.

*Publisher*—JOHN MURRAY, 50, Albemarle Street.

*Bankers*—Messrs. DRUMMOND, Charing Cross.

*Honorary Members.*

BUCKLAND, The Rev. WILLIAM, D.D., F.R.S., Vice-President of the Geological Society.

CARR, Captain J. STANLEY, Duchy of Lauenburg.

COLMAN, HENRY, Agricultural Commissioner of the State of Massachusetts.

DAUBENY, CHARLES, M.D., F.R.S., Professor of Rural Economy, University of Oxford.

DE LA BECHE, Sir HENRY THOMAS, F.R.S., Director of the Ordnance Geological Survey.

EVERETT, The Hon. EDWARD, United States' Minister.

HENSLOW, The Rev. J. S., F.R.S., Professor of Botany, University of Cambridge.

JOHNSTON, JAMES F. W., F.R.S., Reader in Chemistry, University of Durham.

LIEBIG, Dr. JUSTUS, University of Giessen.

MURCHISON, RODERICK IMPEY, F.R.S., President of the Royal Geographical Society.

PLAYFAIR, Dr. LYON, Royal Institution, Manchester.

SOLLY, EDWARD, Horticultural Society of London.

SPRENGEL, Dr. CHARLES, Prussia.

STEVENSON, The Hon. ANDREW, Washington.

VAN DE WEYER, M. SYLVIAN, Belgian Minister.

## Royal Agricultural Society of England.

---

### GENERAL MEETING,

12, HANOVER SQUARE, SATURDAY, DECEMBER 14, 1844.

---

#### REPORT OF THE COUNCIL.

THE COUNCIL have again the satisfaction of reporting to the Members, at their present General Meeting, the effective state of the Society in every branch of its operations; and the continued influx of new Members from all parts of the kingdom. The communications of practical results in farming, furnished by correspondents from the various localities of the country, and again disseminated among the Members by means of the Journal; the increasing extent and importance of the Annual Country Meetings, at which not only the agricultural community have the immediate advantages of personal communication and direct interchange of experience on farming topics of common interest to all, but where from year to year specimens of the most approved breeds of cattle are in succession exhibited to their notice, and the rapid improvements now made in the implements of husbandry submitted to their inspection, and their real value brought at once to the test of practical trial,—form the leading points on which the Council have to congratulate the Members, as evidences of the progressive advancement of the Society in the fulfilment of its various objects.

In the application of science to the improvement of agriculture as an art, the Council are fully aware that results will only be

conclusive and satisfactory in proportion to the perfection of the particular science itself, whose principles are proposed for the regulation of agricultural practice. The laws of mechanics being simple and determinate, their application to the improvement of the principles on which the machines and implements of agriculture may be most economically effected, has been attended with results correspondingly decisive in their character: but while the simple and well-established principles of inorganic chemistry may with confidence be expected to serve as safe guides in leading us to a knowledge of the properties of every variety of soil, and the means of their required modification to particular objects, any new light to be thrown upon agriculture by organic chemistry, a less perfect branch of the science, must as yet be received with greater diffidence, though it ultimately promises the most important results. The Council are convinced that the perfection of agriculture as a science or farming as an art, is only to be attained by the establishment of scientific principles derived from practice, and their judicious application under the given circumstances and conditions of each particular case of climate, soil, or aspect. While, however, they deem this caution requisite in exposition of the practical objects and character of the society, they witness with great satisfaction the rapid advances made by the distinguished chemists of the present day in that comparatively new and infant branch of chemical philosophy connected with investigations into the laws of organic matter and the principles of vegetable life; and they have to congratulate the Society on the zeal with which their consulting chemist, Dr. Playfair, has entered this new and valuable field of scientific inquiry, and the kindness with which he has again favoured the Members on the occasion of their General Meeting, with two highly interesting lectures, elucidating the application of the most recent discoveries of chemical science to the practical operations of agriculture. The Council feel that if any circumstances could enhance the obligations under which they are laid in reference to these lectures, they would be the readiness with which Dr. Playfair, at a very short notice, and regardless of personal inconvenience, prepared him-

self for their delivery, and the liberality with which the Royal Institution of Great Britain at once placed their theatre at the disposal of the Society for the occasion.

The Society's recent country Meeting at Southampton was most successful in every department of its arrangements, and fulfilled the most sanguine expectations of the Council. The extent of the show-yard and the number of entries for exhibition on that occasion, exceeded those of any previous meeting; and the trial of implements, so dependent on circumstances for failure or success, was conducted to the satisfaction of the stewards of that department and the exhibitors whose implements were selected for trial, and proved an object of much attraction to the numerous spectators by whom it was witnessed. The success, in a financial point of view, was greatly promoted by the means so liberally placed at the disposal of the Council by the committee of the town and neighbourhood of Southampton, in the contribution of 1000*l.* to the funds of the Society for the purpose of meeting the expenses of the occasion. To the mayor, corporation, and authorities of the borough, the local committee, the commissioners of police, the occupiers of the trial ground, and the South Western Railway Company, the Society, before leaving Southampton, conveyed by unanimous resolutions their best acknowledgments of the essential services which those parties, by their cordial and zealous co-operation, had respectively rendered to the Council in promoting the objects of the Meeting.

From the agricultural character of the district in which the next annual Country Meeting of the Society at Shrewsbury is appointed to be held, the Council anticipate with confidence a result no less gratifying than that obtained at Southampton; and they have already taken the requisite steps in preparation for that Meeting, and have also decided that the Judges of Stock shall be appointed from recommendations made by the Members of the Society at large at the General Meeting in May.

The Finance Committee will lay before the Meeting the balance-sheets of the accounts as examined and approved by the auditors on the part of the Society. Their chairman will also

report to the Members the large amount of arrears of subscription discharged during the past half-year, as well as the mode proposed for facilitating the future collection of subscriptions. Since the last Half-yearly Meeting upwards of 300 new Members have been elected, and the Society now consists of the following Members :—

Life governors . . . . .	97
Annual Governors . . . . .	208
Annual Members . . . . .	6037
Life members . . . . .	470
Honorary members . . . . .	15

making a total of 6827 Members on the list of the Society at the present time. The Council have unanimously requested Mr. Pusey to accept the office of a trustee of the Society, vacant by the death of the Duke of Grafton, and have elected Mr. Thomas Lockley Meire, of Cound Arbour, near Shrewsbury, a member of the Council, in the place of the late Mr. Edward Gough, of Gravel Hill, near Shrewsbury.

The increasing importance attached by the Members to the possession of the Society's Journal, has led the Journal Committee to continue its best consideration of the means by which the distribution on each publication may be effected with the greatest certainty, and least loss of time, among the Members throughout the kingdom; and they trust that this desirable object will gradually become attained, as the addresses of Members are more accurately known, and the most convenient modes of transmission to them more distinctly ascertained. For the convenience of Members availing themselves of their privilege of attending the rooms of the Society, the Council have ordered a catalogue of the library, and an inventory of the implements, models, &c., to be prepared for their reference.

Four years having elapsed since the date of the charter, and the bye-laws then framed agreeably with the new powers conferred upon the Society, the Council have been desirous of rendering the experience gained during this period available for the regulation of their proceedings; and they have accordingly made a complete

revision of their former bye-laws, and enacted a code of bye-laws and regulations, not only embodying the tenor of such of their special resolutions as had a permanent operation, but rendering the whole more exactly in accordance with the provisions of the charter. A printed copy of these bye-laws was appended to the Journal on its last publication, and thus brought under the immediate notice of the Members.

The Council, in conclusion, beg to congratulate the Members on the present sound and vigorous condition under which the Society is steadily advancing in the gradual fulfilment of its national objects ; and, supported as it is by the continued accession of new Members, they hope to extend annually its sphere of usefulness.

By order of the Council,

(Signed)

JAMES HUDSON,

*Secretary.*

---

# ROYAL AGRICULTURAL SOCIETY OF ENGLAND.

## Statement of Accounts.

Statement of Accounts from January 1st to June 30th, 1844.

RECEIPTS.	£. s. d.	PAYMENTS.	£. s. d.
Balance in the hands of the Bankers, December 31st, 1843 . . . . .	657 11 8	Permanent Charges . . . . .	270 12 6
Ditto in the hands of the Secretary, December 31st, 1843 . . . . .	14 2 1	Taxes and Rates . . . . .	20 7 2
Half-Year's Dividends on Stock . . . . .	130 16 6	Establishment Charges . . . . .	562 7 6
Life Compositions of Governors . . . . .	150 0 0	Postage and Carriage . . . . .	37 7 1
Life Compositions of Members . . . . .	268 0 0	Advertisements . . . . .	9 19 0
Annual Subscriptions of Governors . . . . .	827 10 0	Expenses of Journal . . . . .	1268 8 6
Annual Subscriptions of Members . . . . .	3904 8 0	Prizes . . . . .	320 10 0
Sale of Journal . . . . .	232 17 8	Miscellaneous Payments . . . . .	47 1 7
Sale of Cottage Tracts . . . . .	10 1 0	Payments during the half-year on account of the Country } Meetings . . . . .	1291 2 9
Receipts during the half-year on account of the Country } Meetings . . . . .	1030 6 9	Balance in the hands of the Bankers, June 30th, 1844 . . . . .	3456 19 8
Payment made in error by Sir R. C. Glyn and Co. . . . .	25 0 0	Ditto in the hands of the Secretary, June 30th, 1844 . . . . .	15 17 11
	£7300 13 8		£7300 13 8

(Signed) THOMAS RAYMOND BARKER, Chairman.  
 THOMAS AUSTEN.  
 HENRY BLANSHARD.  
 D. BARCLAY.  
 C. B. CHALLONER.  
 DOWNSHIRE, *Trustee*.

Examined and audited this 13th day of December, 1844.  
 (Signed) C. H. TURNER }  
 THOMAS KNIGHT }  
 Auditors on the part  
 of the Society.



ANNUAL COUNTRY MEETING OF 1844, AT SOUTHAMPTON: IN JULY.

RECEIPTS.		£.	s.	d.	PAYMENTS.		£.	s.	d.
Subscription from Southampton	.	1000	0	0	Dinners	.	946	1	0
Dinner Tickets	.	849	4	0	Ladies' Gallery Refreshments	.	25	0	0
Ladies' Gallery Tickets	.	83	10	0	Pavilion	.	794	12	0
Show-yard	.	2432	3	2	Show-yard and Trial of Implements	.	2630	11	7
Sale of Catalogues	.	363	19	0	Police	.	121	15	0
Sale of Hurdles	.	192	19	8	Judges	.	354	14	6
Sale of Badges for Council and Stewards	.	7	10	0	Consulting Engineer	.	65	1	2
Excess of Payments over Receipts at the Southampton Meeting, chargeable on the Funds of the Society.	}	806	19	4	Auctioneer	.	21	0	0
	.				Surveyors	.	7	14	0
					Printing	.	399	5	9
					Stationery	.	19	1	7
					Advertisements	.	255	5	4
					Carrriage	.	36	14	10
					Postage	.	11	4	7
					Official Staff	.	32	0	4
					Extra Clerks	.	15	8	0
					Swearing in Special Constables	.	0	15	6
							£5736	5	2

(Signed) RICHMOND, President.  
 THOMAS RAYMOND BARKER, Chairman of Finance.  
 C. B. CHALLONER.  
 THOMAS AUSTEN.  
 HENRY BLANSHARD.

## Meeting at Southampton.

PRINCIPAL DAY OF THE SHOW, JULY 25, 1844.

---

### AWARD OF PRIZES.

#### CATTLE: I. *Short Horns.*

- JOHN COOPER, of Bankwood, Thurgarton, near Southwell, Nottinghamshire: the Prize of THIRTY SOVEREIGNS, for his 3 years 1 month and 13 days-old Short-horned Bull; bred by himself.
- WILLIAM GOODENOUGH HAYTER, M.P., of Wells, Somersetshire: the Prize of FIFTEEN SOVEREIGNS, for his 2 years and 10 months-old Short-horned Bull; bred by H. Unsworth, of Blackrod, Lancashire.
- WILLIAM FOULDS, of Kirklington, near Southwell, Nottinghamshire: the Prize of TWENTY SOVEREIGNS, for his 2 years 3 months and 22 days-old Short-horned Bull; bred by the late Richard Milward, of Hexgreave Park, Southwell.
- JOHN BOOTH, of Killerby, near Catterick, Yorkshire: the Prize of FIFTEEN SOVEREIGNS, for his 3 years 2 months and 5 days-old Short-horned Cow; bred by himself.
- His Grace the DUKE OF DEVONSHIRE, of Chatsworth, Derbyshire: the Prize of FIFTEEN SOVEREIGNS, for his 2 years and 5 months-old Short-horned In-calf Heifer; bred by Henry Watson, of Walker-ingham, near Bawtry.
- RICHARD BOOTH, of Warlaby, near Northallerton, Yorkshire: the Prize of TEN SOVEREIGNS, for his 1 year 2 months and 3 weeks-old Short-horned Heifer; bred by himself.

CATTLE: II. *Herefords.*

WILLIAM PERRY, of Monkland, near Leominster, Herefordshire: the Prize of THIRTY SOVEREIGNS, for his 2 years 7 months and 28 days-old Hereford Bull; bred by himself.

GEORGE BROWN, of Avebury, near Marlborough, Wiltshire: the Prize of FIFTEEN SOVEREIGNS, for his 2 years and 7 months-old Hereford Bull; bred by himself.

JOHN NELSON CARPENTER, of Eardisland, near Leominster, Herefordshire: the Prize of TWENTY SOVEREIGNS, for his 1 year 8 months 3 weeks and 4 days-old Hereford Bull; bred by himself.

GEORGE DRAKE, of the Manor Farm, East Tytherley, near Stockbridge, Hampshire: the Prize of FIFTEEN SOVEREIGNS, for his 8 years and 10 months-old Pure Hereford Cow; bred by the late John Price, of Poole House, Upton-on-Severn.

JOHN NELSON CARPENTER, of Eardisland, near Leominster, Herefordshire: the Prize of FIFTEEN SOVEREIGNS, for his 2 years 8 months and 18 days-old Hereford In-calf Heifer; bred by himself.

JOHN WALKER, of Burton, near Worcester: the Prize of TEN SOVEREIGNS, for his 1 year and 8 months-old Herefordshire Heifer; bred by Charles Walker, of Sutton, near Tenbury, by a bull the property of the exhibitor.

CATTLE: III. *Devons.*

GEORGE TURNER, of Barton, near Exeter, Devonshire: the Prize of THIRTY SOVEREIGNS, for his 2 years and 8 months-old Devon Bull; bred by himself.

THOMAS NURCOMBE, of Hopcott Farm, near Minehead, Somersetshire: the Prize of FIFTEEN SOVEREIGNS, for his 4 years and 9 months-old Pure Devon Bull; bred by himself.

THOMAS REYNOLDS, of Raddon Court, Thorverton, near Exeter, Devonshire: the Prize of TWENTY SOVEREIGNS, for his 2 years and 5 months-old Pure North-Devon Bull; bred by Amos Parsons, of Lifton, near Launceston.

GEORGE TURNER, of Barton, near Exeter, Devonshire: the Prize of FIFTEEN SOVEREIGNS, for his 6 years and 2 months-old Devon Cow; bred by himself.

GEORGE TURNER, of Barton, near Exeter, Devonshire: the Prize of FIFTEEN SOVEREIGNS, for his 2 years and 2 months-old Devon In-calf Heifer; bred by himself.

JAMES HOLE, of Knowle, near Dunster, Somersetshire: the Prize of TEN SOVEREIGNS, for his 1 year 7 months and 2 days-old Devon Heifer; bred by himself.

CATTLE: IV. *Channel Islands' Breed.*

The Rev. WILLIAM JOSEPH GEORGE PHILLIPS, of Eling Vicarage, near Southampton: the Prize of FIFTEEN SOVEREIGNS, for his 2 years and 4 months-old Bull of the Channel Islands Breed: bred by himself.

WATKINS WOOLCOCK, of Saint Peter's Parish, near Winchester, Hampshire: the Prize of TEN SOVEREIGNS, for his 1 year and 5 months-old Pure Jersey Bull; bred by Colonel Le Couteur, of Belle-Vue, Jersey, by a prize-bull of the exhibitor.

CHARLES WILLIAM ROBIN, of Petit Ménage, near St. Helier, Jersey: the Prize of TEN SOVEREIGNS, for his 2 years and 6 months-old Pure Jersey Cow; bred by John Hocguard, Gronville, Jersey.

[No Stock was shown for the Prize of TEN SOVEREIGNS, "for the best In-calf Heifer not exceeding 2 years old."]

JOHN HUME, of Beau-Regard, near St. Helier, Jersey: the Prize of SEVEN SOVEREIGNS, for his 1 year 1 month and 10 days-old Pure Jersey Heifer; bred by Major Bridgeham, of The Grove, St. Laurens, Jersey.

CATTLE: V. *Any Breed or Cross* (not qualified to compete in the foregoing Classes).

WILLIAM BRINE, of Tolpuddle, near Dorchester, Dorsetshire: the Prize of THIRTY SOVEREIGNS, for his 4 years and 5 months-old Pure Long-horned Bull; bred by the late Thomas Wyatt, of Hanwell Park, near Banbury.

THOMAS JENNER, of Cowdray Park Farm, near Petworth, Sussex: the Prize of FIFTEEN SOVEREIGNS, for his 3 years and 4 months-old Pure Sussex Bull; bred by himself.

THOMAS DOWDEN, of Mitcheldever, near Andover, Hampshire: the Prize of TWENTY SOVEREIGNS, for his 2 years and 2 months-old Bull, by a Hereford Bull out of a Durham Cow; bred by himself.

The Hon. M. W. B. NUGENT, of Higham Grange, near Hinckley, Leicestershire: the Prize of FIFTEEN SOVEREIGNS, for his 10 years and 2 months-old Pure Leicester Long-horned Cow; bred by Thomas Ball, of Snowford Lodge, near Southam, Warwickshire.

His Grace the DUKE OF BUCKINGHAM AND CHANDOS, of Stowe, near Buckingham: the Prize of FIFTEEN SOVEREIGNS, for his 2 years and 10 months-old Long-horned In-calf Heifer; bred by himself.

WALTER J. CALHOUN, of Binderton, near Chichester, Sussex: the Prize of TEN SOVEREIGNS, for his 1 year and 2 months-old Heifer, of the Short-horn and Hereford Cross; breeder unknown

HORSES.

THOMAS CATLIN, of Butley, near Woodbridge, Suffolk: the Prize of THIRTY SOVEREIGNS, for his 4 years-old Stallion for agricultural purposes; bred by himself, as executor of the late T. N. Catlin.

The EARL OF ST. GERMAN, of St. Germans, Cornwall: the Prize of TWENTY SOVEREIGNS, for his aged Stallion for agricultural purposes; breeder unknown.

LORD ST. JOHN, of Melchbourne Park (Beds.), near Kimbolton, Huntingdonshire: the Prize of FIFTEEN SOVEREIGNS, for his 2 years and 2 weeks-old Stallion for agricultural purposes; bred by himself.

WILLIAM FOWLE, of Market-Lavington, near Devizes, Wiltshire: the Prize of TWENTY SOVEREIGNS, for his Mare and Foal for agricultural purposes; breeder unknown. The sire of the foal belonged to H. Ings, of Pen-selwood, near Wincanton, Somersetshire.

GEORGE WHITEBREAD ROBERTS, of King's Walden, near Hitchin, Hertfordshire: the Prize of TEN SOVEREIGNS, for his Mare and Foal for agricultural purposes; bred by himself. The sire of the foal belonged to James Hayden, of Arrington, Cambridgeshire.

WILLIAM FOWLE, of Market-Lavington, near Devizes, Wiltshire: the Prize of TEN SOVEREIGNS, for his 2 years-old Filly; bred by Richard Daintree, of Hemingford Abbots, near St. Ives, Huntingdonshire.

RICHARD CURTIS, of Basingstoke, Hampshire: the Prize of THIRTY SOVEREIGNS, for his 5 years-old Thorough-bred Stallion; breeder unknown. Got by Langar: dam by Cervantes, out of Mariana by Selim.

SHEEP: I. *Leicesters.*

JOHN GREGORY WATKINS, of Woodfield, Ombersley, near Stourport, Worcestershire: the Prize of THIRTY SOVEREIGNS, for his 16 months-old Pure Leicester Ram; bred by himself.

THOMAS EDWARD PAWLETT, of Beeston, near Biggleswade, Bedfordshire: the Prize of FIFTEEN SOVEREIGNS, for his 15 months-old Leicester Ram; bred by himself.

THOMAS EDWARD PAWLETT, of Beeston, near Biggleswade, Bedfordshire: the Prize of THIRTY SOVEREIGNS, for his 28 months-old Leicester Ram; bred by himself.

THOMAS EDWARD PAWLETT, of Beeston, near Biggleswade, Bedfordshire: the Prize of FIFTEEN SOVEREIGNS, for his 40 months-old Leicester Ram; bred by himself.

JOHN GREGORY WATKINS, of Woodfield, Ombersley, near Stourport, Worcestershire: the Prize of TEN SOVEREIGNS, for his 16 months-old Pure Leicester Ewes; bred by himself.

JOHN BEASLEY, of Chapel-Brampton, near Northampton: the Prize of FIVE SOVEREIGNS, for his 16 months-old Improved Leicester Ewes; bred by himself.

SHEEP: II. *Southdowns.*

JONAS WEBB, of Babraham, near Cambridge: the Prize of THIRTY SOVEREIGNS, for his 16 months-old Southdown Ram; bred by himself.

His Grace the DUKE of RICHMOND, of Goodwood, near Chichester, Sussex: the Prize of FIFTEEN SOVEREIGNS, for his 16 months-old Southdown Ram; bred by himself.

JAMES BEAVEN, JUN., of Gore Farm, near Market-Lavington, Wiltshire: the Prize of THIRTY SOVEREIGNS, for his 52 months-old Southdown Ram; bred by himself.

STEPHEN GRANTHAM, of Stoneham, near Lewes, Sussex: the Prize of FIFTEEN SOVEREIGNS, for his 28 months-old Southdown Ram; bred by himself.

His Grace the DUKE of RICHMOND, of Goodwood, near Chichester, Sussex: the Prize of TEN SOVEREIGNS, for his 16 months-old Southdown Ewes; bred by himself.

DAVID BARCLAY, M.P., of Eastwick Park, near Leatherhead, Surrey: the Prize of FIVE SOVEREIGNS, for his 17 months-old Southdown Ewes; bred by himself.

SHEEP: III. *Long-Wools* (not qualified to compete as Leicesters).

CHARLES LARGE, of Broadwell, near Burford, Oxfordshire: the Prize of THIRTY SOVEREIGNS, for his 16 months-old New Oxfordshire Ram; bred by himself.

CHARLES LARGE, of Broadwell, near Burford, Oxfordshire: the Prize of FIFTEEN SOVEREIGNS, for his 16 months-old New Oxfordshire Ram; bred by himself.

EDWARD HANDY, of Sevenhampton, near Andoversford, Gloucestershire: the Prize of THIRTY SOVEREIGNS, for his 40 months-old Improved Cotswold Ram; bred by himself.

EDWARD SMITH, of Charlbury, near Enstone, Oxfordshire: the Prize of FIFTEEN SOVEREIGNS, for his 52 months-old Long-woolled Oxfordshire Ram; bred by himself.

EDWARD SMITH, of Charlbury, near Enstone, Oxfordshire: the Prize of TEN SOVEREIGNS, for his 16 months-old Long-woolled Oxfordshire Ewes; bred by himself.

The REV. JAMES LINTON, of Hemingford-Abbots, near St. Ives, Huntingdonshire: the Prize of FIVE SOVEREIGNS, for his 16 months-old Ewes of the Lincoln and Leicester cross; bred by himself, by a ram belonging to Richard Daintree, of Hemingford-Abbots.

SHEEP: IV. *Short-wools* (not qualified to compete as Southdowns).

[The Judges decided to withhold the Prize of TWENTY SOVEREIGNS, "for the best Shearling Ram," in this Class, on account of the want of merit in the animals shown in competition for it.]

THOMAS HUTTON, of Upton-Gray, near Odiham, Hampshire: the Prize of TWENTY SOVEREIGNS, for his 29 months-old Hampshire-Down Ram; bred by himself.

WILLIAM HUMFREY, of Chaddleworth, near Newbury, Berkshire: the Prize of TEN SOVEREIGNS, for his 18 months-old Berkshire Short-woolled Ewes; bred by himself.

PIGS.

Lieut.-Colonel WILLIAM THORNHILL, of New Park, near Lyndhurst, Hampshire: the Prize of TEN SOVEREIGNS, for his 36 weeks-old Boar (of a large breed); bred by William Pole Thornhill, of Stanton, near Bakewell, Derbyshire.

PHILIP PUSEY, M.P., of Pusey, near Faringdon, Berkshire: the Prize of FIVE SOVEREIGNS, for his 2 years and 1 month-old Berkshire Boar (of a large breed); bred by John Harris, of Hinton, near Abingdon.

WILLIAM FISHER HOBBS, of Marks Hall, near Kelvedon, Essex: the Prize of TEN SOVEREIGNS, for his 10 months-old Improved Essex Boar (of a small breed); bred by himself.

THOMAS MILLS GOODLAKE, of Wadley House, near Faringdon, Berkshire: the Prize of FIVE SOVEREIGNS, for his 1 year and 2 months-old Wadley Boar (of a small breed); bred by himself.

PHILIP PUSEY, M.P., of Pusey, near Faringdon, Berkshire: the Prize of TEN SOVEREIGNS, for his 1 year and 8 months-old Berkshire Sow (of a large breed); bred by the late John Blandy, of Kingston, Berkshire.

ALEXANDER PYTTS FALCONER, of Beacon-Hordle, near Christchurch, Hampshire: the Prize of TEN SOVEREIGNS, for his 11 months and 3 weeks-old Sow of Lord Wenlock's Yorkshire (small) breed; bred by J. W. Nutt, near York.

JOSEPH HOUSE, of South Bestwall, near Wareham, Dorsetshire: the Prize of TEN SOVEREIGNS, for his 34 weeks-old Dorset Sow (of a small breed); bred by himself. The sire of these pigs was bred by W. Fisher Hobbs, of Marks-Hall.

## EXTRA STOCK.

- MICHAEL GOODALL, of Evelith Manor, near Shiffnal, Shropshire: the Sum of SEVEN SOVEREIGNS, for his 5 years and 1 month-old Cow of the Indian and French cross-breed; bred by the late John Jellieoe, of Beighterton, near Shiffnal.
- GEORGE DRAKE, of the Manor Farm, East Tytherley, near Stockbridge, Hampshire: the Sum of TWO SOVEREIGNS, for his 10 months-old Bull-Calf of the pure Herefordshire breed; bred by himself.
- GEORGE DRAKE, of the Manor Farm, East Tytherley, near Stockbridge, Hampshire: the Sum of ONE SOVEREIGN, for his 6 months and 3 days-old Heifer-Calf of the pure Herefordshire breed; bred by himself.
- RICHARD CURTIS, of Basingstoke, Hampshire: the Sum of FIVE SOVEREIGNS, for his 4 years and 2 months-old Stallion; bred by himself.
- JOHN THOMAS GLASSPOOL, of Southampton: the Sum of FIVE SOVEREIGNS, for his 2 years and 3 months-old Mare; bred by Arthur Seory, of Minstead, near Lyndhurst.
- CHARLES LARGE, of Broadwell, near Burford, Oxfordshire: the Sum of TEN SOVEREIGNS, for his 4 years and 4 months-old New Oxfordshire Long-woolled Ewe; bred by himself.
- THOMAS BARNES NORTHEAST, of Tedworth, near Marlborough, Wiltshire: the Sum of FOUR SOVEREIGNS, for his 3 years and 5 months-old Southdown Ram; bred by himself.
- THOMAS BARNES NORTHEAST, of Tedworth, near Marlborough, Wiltshire: the Sum of TWO SOVEREIGNS, for his 3 years and 5 months-old Southdown Ram; bred by himself.
- WILLIAM SAINSBURY, of Market-Lavington, near Devizes, Wiltshire: the Sum of FOUR SOVEREIGNS, for his 3 years and 7 months-old Southdown Ram; bred by himself.
- WILLIAM FISHER HOBBS, of Marks Hall, near Kelvedon, Essex: the Sum of TWO SOVEREIGNS, for his 8 months-old Improved Essex Boar; bred by himself.
- WILLIAM FISHER HOBBS, of Marks Hall, near Kelvedon, Essex: the Sum of TWO SOVEREIGNS, for his 7 months-old Improved Essex Boar; bred by himself.
- WALTER J. CALHOUN, of Binderton, near Chichester, Sussex: the Sum of ONE SOVEREIGN, for his 10 months-old Sow-Pig of the small Sussex black breed; bred by himself.
- WILLIAM FISHER HOBBS, of Marks Hall, near Kelvedon, Essex: the Sum of THREE SOVEREIGNS, for his 9 months-old Improved Essex Sow; bred by himself.
-



**Commendations.**

- \*JOHN FORREST, of Stretton, near Warrington: for his 4 years 2 months and 25 days-old Pure Short-horned Cow; bred by himself.
- JOHN BOOTH, of Killerby, near Catterick, Yorkshire: for his 2 years 6 months and 1 week-old Short-horned In-calf Heifer; bred by himself.
- \*WILLIAM FISHER HOBBS, of Marks Hall, near Kelvedon, Essex; for his 2 years and 4 months-old Hereford Bull; bred by himself.
- \*LORD PORTMAN, of Bryanston, near Blandford, Dorsetshire: for his 5 years and 2 months-old Devon-Bull; bred by the Earl of Digby, Sherborne Castle, Dorsetshire.
- \*Colonel JOHN LE COUTEUR, of Belle-Vue, Jersey: for his 1 year and 5 months-old Bull of the Channel Islands' Breed; bred by himself, from a first-prize bull and first-prize cow.
- WILLIAM BRACHER GATER, of West End, Southampton: for his 2 years and 5 weeks-old Bull of the Channel Islands' Breed; bred by William Gibbs, of Itchenor, Sussex.
- JOHN ROUGIER, of St. André Parish, Guernsey: for his 4 years and 8 months-old Cow of the Channel Islands' Breed; bred by Miss Le Marchant, of Ste. Mary-de-Castro, Guernsey.
- JOHN ALLSOP, of East-Wellow, near Romsey, Hampshire: for his 1 year and 20 days-old Short-horn and Devon-Cross Bull; bred by himself.
- EDWARD HANDY, of Sevenhampton, near Andoversford, Gloucestershire: for his 40 months-old Improved Cotswold Ram; bred by himself.
- EDWARD HANDY, of Sevenhampton, near Andoversford, Gloucestershire: for his 17 months-old Improved Cotswold Ram; bred by himself.
- JOHN POPE, of Symondsburry, near Bridport, Dorsetshire: for his 31 months-old Dorset-horned Short-woolled Ram; bred by himself.
- JOHN POPE, of Symondsburry, near Bridport, Dorsetshire: for his 31 months-old Dorset-horned Short-woolled Ram; bred by himself.
- JAMES RAWLENCE, of Heale, near Salisbury, Wiltshire: for his 30 months-old Hampshire Short-woolled Ram; bred by himself.
- JAMES RAWLENCE, of Heale, near Salisbury, Wiltshire: for his 42 months-old Hampshire Short-woolled Ram; bred by himself.
- JOHN SHRIMPTON, of Easton, near Winchester, Hampshire: for his 30 months-old Short-woolled Ram; bred by himself.
- \*THOMAS SIMS GODWIN, of Broughton, near Stockbridge, Hampshire: for his 16½ months-old Hampshire-Down Ewes; bred by himself.
- JOHN POPE, of Symondsburry, near Bridport, Dorsetshire: for his 19 months-old Dorset-horned Short-woolled Ewes; bred by himself.
- JAMES BECKINGHAM, of Ashe, near Overton, Hampshire: for his 41 months and 25 days-old Ram, of the Hampshire and Sussex-Down Cross; bred by himself.
- WILLIAM HUMFREY, of Chaddleworth, near Newbury, Berkshire: for his 42 months-old Berkshire Short-woolled Ram; bred by himself.
- WILLIAM HUMFREY, of Chaddleworth, near Newbury, Berkshire: for his 30 months-old Berkshire Short-woolled Ram; bred by himself.
- WILLIAM HUMFREY, of Chaddleworth, near Newbury, Berkshire: for his 30 months-old Berkshire Short-woolled Ram; bred by himself.

- JOHN PAIN, of Houghton, near Stockbridge, Hampshire : for his 53 months-old Hampshire-Down Ram ; bred by himself.
- HENRY PAIN, of Mitcheldever, near Winchester, Hampshire : for his 29 months-old Hampshire-Down Ram ; bred by himself.
- WILLIAM PAIN, of Compton, near Winchester, Hampshire ; for his 41 months-old Hampshire-Down Ram ; bred by himself.
- WILLIAM SANDERS, of Cranbourne, near Sutton-Scotney, Hampshire : for his 30 months-old Hampshire Short-woolled Ram ; bred by himself.
- \*WILLIAM FISHER HOBBS, of Marks Hall, near Kelvedon, Essex : for his 13 months-old Improved Essex Boar (of a small breed) ; bred by himself.
- \*WILLIAM FISHER HOBBS, of Marks Hall, near Kelvedon, Essex : for his 37 weeks and 3 days-old Improved Essex Sow-pigs (of a small breed) ; bred by himself.
- EDWARD GEORGE BARNARD, M.P., of Gosfield Hall, near Halsted, Essex : for his 16 months-old Improved Essex Boar (of a small breed) ; bred by himself.
- EDWARD GEORGE BARNARD, M.P., of Gosfield Hall, near Halsted, Essex : for his 8 months-old Improved Essex Boar (of a small breed) ; bred by himself.
- EDWARD GEORGE BARNARD, M.P., of Gosfield Hall, near Halsted, Essex : for his 11 months-old Improved Essex Boar (of a small breed) ; bred by himself.
- EDWARD GEORGE BARNARD, M.P., of Gosfield Hall, near Halsted, Essex : for his 8 months-old Improved Essex Boar (of a small breed) ; bred by himself.
- JOHN WILLIAM CLARK, of Timsbury, near Romsey, Hampshire : for his 31 months-old Neapolitan Boar (of a small breed) ; bred by Edmund Tattersall, of Willesden.
- HENRY COMBE COMPTON, M.P., of The Manor House, near Lyndhurst, Hampshire : for his 5½ months-old Improved Middlesex Boar (of a small breed) ; bred by himself.
- HENRY COMBE COMPTON, M.P., of The Manor House, near Lyndhurst, Hampshire : for his 8 months-old Improved Middlesex Boar (of a small breed) ; bred by himself.
- His Grace the DUKE of DEVONSHIRE, of Chatsworth, near Bakewell, Derbyshire : for his 11 months-old Chinese and Essex-Cross Boar (of a small breed) ; bred by himself.
- ALEXANDER PEARSON FALCONER, of Beacon-Hordle, Christchurch, Hampshire : for his 1 year and 2 weeks-old Boar of Lord Wenlock's Yorkshire (small) breed ; bred by John Walton Nutt, of York.
- CHARLES FIELDER, of Sparsholt, near Winchester, Hampshire : for his 6 months and 5 days-old Hampshire Boar (of a small breed) ; bred by himself.
- The Hon. SAMUEL HAY, of Clyffe Hall, near Market-Lavington, Wiltshire : for his 10 months old Suffolk Boar (of a small breed) ; bred by H.R.H. Prince Albert, at the Home Farm, Windsor.
- WILLIAM FISHER HOBBS, of Marks Hall, near Kelvedon, Essex : for his 15 months-old Improved Essex Boar (of a small breed) ; bred from a boar of the exhibitor's breed, by Henry Quibampton, of Little Totham, near Maldon, Essex.
- The Rev. WILLIAM HOCKEN, of St. Endellion, near Camelford, Cornwall : for his 27 weeks and 3 days-old Improved Small Essex Boar ; bred by himself.
- The Right Hon. CHARLES SHAW LEFEVRE, of Heckfield Place, near Hartfordbridge, Hampshire : for his 1 year and 4 months-old Heckfield Boar (of a small breed) ; bred by himself.
- The Right Hon. CHARLES SHAW LEFEVRE, of Heckfield Place, near Hartfordbridge, Hampshire : for his 1 year and 4 months-old Heckfield Boar (of a small breed) ; bred by himself.

- CHARLES OSBORN, of Fareham, Hampshire : for his 1 year and 2 months-old Small Essex and Sussex-Cross Boar : bred by himself.
- GEORGE PENFORD, of Hill Street Farm, near Totton, Hampshire : for his 10 months-old Small-breed Boar ; bred by himself.
- GEORGE PENFORD, of Hill Street Farm, near Totton, Hampshire : for his 18 weeks-old Small-breed Boar ; bred by himself.
- The EARL of ST. GERMANS, of St. Germans, Cornwall : for his 9 months-old Leicestershire Boar (of a small breed) ; bred by himself.
- JAMES SINGER TURNER, of Old Shoreham, near New Shoreham, Sussex : for his 2 years and 4 months-old Small-breed Boar ; bred by himself.
- The late LORD WESTERN, of Felix Hall, near Kelvedon, Essex : for his 1 year and 4 months-old Improved Essex Boar (of a small breed) ; bred by himself.
- JOSEPH WILLIS, of Bucknowle, near Corfe-Castle, Dorsetshire : for his 10 months and 2 weeks-old Improved Essex Boar (of a small breed) ; bred by Henry Fookes, of Monkton, near Blandford, Dorsetshire.

[These Commendations are arranged in the order of the numbers of the Certificates to which they refer. The mark (\*) signifies "HIGHLY COMMENDED;" the omission of it, "COMMENDED;" by the Judges. Mr. Godwin's Ewes were "VERY HIGHLY COMMENDED."]

---

## SELECTION OF SEED WHEAT AND BARLEY.

- CALEB HAMMOND GATER, of Swathling Farm, near Southampton : Fourteen bushels of White Wheat, grown in 1843, on a hazel-mould, or gravel subsoil, on his farm at Swathling. The seed, obtained from William Payne, of New Barn Farm, near Winchester, was called the *Brittany* or *Breedon* Wheat ; and was sown broadcast and pressed on a one-year's clover-ley, dressed with farm-yard manure once turned in heap.
- EDWARD DAVIS HODDING, of Odstock, near Salisbury : Fourteen bushels of Barley, grown in 1843 on a chalky soil, on his farm at Odstock. The seed, obtained from Leghorn by J. Rowden, of Bishopstone, and by him called *Leghorn* Barley, was sown after turnips (drilled with 40 bushels per acre of night-soil and ashes) preceded by a crop of wheat.

[The result of the cultivation of this Wheat and Barley, and the comparison of their productiveness with that of other varieties commonly grown in the respective neighbourhoods where the trials are made, will be reported to the General December Meeting in 1845.]

# Annual Country Meeting of 1845,

TO BE HELD AT

## SHREWSBURY,

IN THE NORTH WALES DISTRICT, COMPRISING THE COUNTIES OF ANGLESEY, CARNARVON, MERIONETH, MONTGOMERY, DENBIGH, FLINT, CHESTER, SALOP, AND STAFFORD.

PRINCIPAL DAY OF THE SHOW, THURSDAY, JULY 17, 1845.

*A General Meeting will be held at Shrewsbury on Friday, July 18, 1845, at Twelve o' Clock precisely.*

---

THE PRIZES ARE OPEN TO GENERAL COMPETITION.

---

FORMS OF CERTIFICATE TO BE PROCURED ON APPLICATION TO THE SECRETARY, 12, HANOVER SQUARE, LONDON.

ALL CERTIFICATES FOR IMPLEMENTS MUST BE RETURNED, FILLED UP, TO THE SECRETARY ON OR BEFORE THE 1ST OF MAY, AND ALL OTHER CERTIFICATES BY THE 1ST OF JUNE; THE COUNCIL HAVING DECIDED THAT IN NO CASE WHATEVER SHALL ANY CERTIFICATE BE RECEIVED AFTER THOSE DATES RESPECTIVELY.

---

### *Prizes for Improving the Breed of Cattle.—1845.*

#### SHORT-HORNS.

CLASS

1. To the owner of the best Bull calved previously to the 1st of January, 1843 . . . . . Thirty Sovereigns.  
To the owner of the second-best ditto ditto . . . . . Fifteen Sovereigns.
2. To the owner of the best Bull calved since the 1st of January, 1843, and more than one year old . . . . . Twenty Sovereigns.
3. To the owner of the best Cow in milk or in calf . . . . . Fifteen Sovereigns.  
[In the case of the cow being in calf, and not in milk, the prize will not be given until she is certified to have produced a calf.]
4. To the owner of the best In-calf Heifer, not exceeding three years old . . . . . Fifteen Sovereigns.
5. To the owner of the best Yearling Heifer . . . . . Ten Sovereigns.
6. To the owner of the best Bull-calf, not exceeding one year old . . . . . Ten Sovereigns.

#### HEREFORDS.

1. To the owner of the best Bull calved previously to the 1st of January, 1843 . . . . . Thirty Sovereigns.  
To the owner of the second-best ditto ditto . . . . . Fifteen Sovereigns.

CLASS

2. To the owner of the best Bull calved since the 1st of January, 1843, and more than one year old . . . . . Twenty Sovereigns.
3. To the owner of the best Cow in milk or in calf . . . . . Fifteen Sovereigns.  
 [In the case of the cow being in calf, and not in milk, the prize will not be given until she is certified to have produced a calf.]
4. To the owner of the best In-calf Heifer, not exceeding three years old . . . . . Fifteen Sovereigns.
5. To the owner of the best Yearling Heifer . . . . . Ten Sovereigns.
6. To the owner of the best Bull-calf, not exceeding one year old . . . . . Ten Sovereigns.

DEVONS.

1. To the owner of the best Bull calved previously to the 1st of January, 1843 . . . . . Thirty Sovereigns.  
 To the owner of the second-best ditto ditto . . . . . Fifteen Sovereigns.
2. To the owner of the best Bull calved since the 1st of January, 1843, and more than one year old . . . . . Twenty Sovereigns.
3. To the owner of the best Cow in milk or in calf . . . . . Fifteen Sovereigns.  
 [In the case of the cow being in calf, and not in milk, the prize will not be given until she is certified to have produced a calf.]
4. To the owner of the best In-calf Heifer, not exceeding three years old . . . . . Fifteen Sovereigns.
5. To the owner of the best Yearling Heifer . . . . . Ten Sovereigns.
6. To the owner of the best Bull-calf, not exceeding one year old . . . . . Ten Sovereigns.

CATTLE OF ANY BREED:

*Not qualified to compete in the foregoing Classes.*

1. To the owner of the best Bull calved previously to the 1st of January, 1843 . . . . . Twenty Sovereigns.  
 To the owner of the second-best ditto ditto . . . . . Ten Sovereigns.
2. To the owner of the best Bull calved since the 1st of January, 1843, and more than one year old . . . . . Fifteen Sovereigns.
3. To the owner of the best Cow in milk or in calf . . . . . Fifteen Sovereigns.  
 [In the case of the cow being in calf, and not in milk, the prize will not be given until she is certified to have produced a calf.]
4. To the owner of the best In-calf Heifer, not exceeding three years old . . . . . Ten Sovereigns.
5. To the owner of the best Yearling Heifer . . . . . Ten Sovereigns.

## HORSES.

## CLASS

1. To the owner of the best Stallion for Agricultural purposes, of any age . . . . . Thirty Sovereigns.  
To the owner of the second-best ditto ditto . . . . . Fifteen Sovereigns.
2. To the owner of the best three-years-old ditto . . . . . Fifteen Sovereigns.
3. To the owner of the best two-years-old ditto . . . . . Fifteen Sovereigns.
4. To the owner of the best Mare and Foal for Agricultural purposes . . . . . Twenty Sovereigns.  
To the owner of the second-best ditto . . . . . Ten Sovereigns.
5. To the owner of the best two-years-old Filly . . . . . Ten Sovereigns.
6. To the owner of the best THOROUGH-BRED STALLION, which shall have served Mares at a price not exceeding three guineas (and with a groom's fee of not more than five shillings), in the season of 1845 . . . . . Thirty Sovereigns.

## S H E E P.

*Prizes for Improving the Breed of Sheep.—1845.*

## LEICESTERS.

1. To the owner of the best Shearling Ram . . . . . Thirty Sovereigns.  
To the owner of the second-best ditto . . . . . Fifteen Sovereigns.
2. To the owner of the best Ram of any other age . . . . . Thirty Sovereigns.  
To the owner of the second-best ditto . . . . . Fifteen Sovereigns.
3. To the owner of the best pen of Five Shearling Ewes . . . . . Ten Sovereigns.  
To the owner of the second-best ditto ditto . . . . . Five Sovereigns.

## SOUTH-DOWN SHEEP.

1. To the owner of the best Shearling Ram . . . . . Thirty Sovereigns.  
To the owner of the second-best ditto . . . . . Fifteen Sovereigns.
2. To the owner of the best Ram of any other age . . . . . Thirty Sovereigns.  
To the owner of the second-best ditto . . . . . Fifteen Sovereigns.
3. To the owner of the best pen of Five Shearling Ewes . . . . . Ten Sovereigns.  
To the owner of the second-best ditto ditto . . . . . Five Sovereigns.

## LONG-WOOLLED SHEEP :

*Not qualified to compete as Leicesters.*

1. To the owner of the best Shearling Ram . . . . . Thirty Sovereigns.  
To the owner of the second-best ditto . . . . . Fifteen Sovereigns.
2. To the owner of the best Ram of any other age . . . . . Thirty Sovereigns.  
To the owner of the second-best ditto . . . . . Fifteen Sovereigns.
3. To the owner of the best pen of Five Shearling Ewes . . . . . Ten Sovereigns.  
To the owner of the second-best ditto ditto . . . . . Five Sovereigns.

SHEEP BEST ADAPTED TO A MOUNTAIN-DISTRICT.

CLASS

1. To the owner of the best Ram of any age . . Fifteen Sovereigns.  
 To the owner of the second-best ditto . . . Ten Sovereigns.  
 To the owner of the third-best ditto . . . Five Sovereigns.
2. To the owner of the best pen of Ewes of any age Ten Sovereigns.  
 To the owner of the second-best ditto . . . Five Sovereigns.

Pigs.

1. To the owner of the best Boar of a large breed . Ten Sovereigns.  
 To the owner of the second-best ditto ditto . . Five Sovereigns.
2. To the owner of the best Boar of a small breed. Ten Sovereigns.  
 To the owner of the second-best ditto ditto . . Five Sovereigns.
3. To the owner of the best breeding Sow of a large  
 breed . . . . . Ten Sovereigns.
4. To the owner of the best breeding Sow of a small  
 breed . . . . . Ten Sovereigns.
5. To the owner of the best pen of three breeding  
 Sow-Pigs of the same litter, above four and  
 under ten months old . . . . . Ten Sovereigns.

AGRICULTURAL IMPLEMENTS.

A sum not exceeding Three Hundred Sovereigns.

CHEESE.

- To the exhibitor of the best hundredweight of  
 Cheese (of any kind) made within the dis-  
 trict . . . . . Ten sovereigns.
- To the exhibitor of the second-best ditto . . . Five Sovereigns.

EXTRA STOCK, ROOTS, AND SEEDS.

For Extra Stock of any kind, not shown for any of  
 the above Prizes, and for Roots, Seeds, &c.,  
 Prizes may be awarded and apportioned, by the  
 Council and Judges, to an amount not ex-  
 ceeding in the whole . . . . . Fifty Sovereigns.

ANY NEW IMPLEMENT.

For the Invention of any new Agricultural Implement, such sum as  
 the Council may think proper to award.

## SEED-WHEAT, BARLEY, AND OATS.

I. Fifteen Sovereigns, or a Piece of Plate of that value, will be given to the Exhibitor, at the Meeting at Shrewsbury, of the best 14 bushels of White Wheat, of the harvest of 1844, and grown by himself.

II. Fifteen Sovereigns, or a Piece of Plate of that value, will be given to the Exhibitor, at the Meeting at Shrewsbury, of the best 14 bushels of Red Wheat, of the harvest of 1844, and grown by himself.

III. Ten Sovereigns, or a Piece of Plate of that value, will be given to the Exhibitor, at the Meeting at Shrewsbury, of the best 14 bushels of Spring Wheat, of the harvest of 1844, and grown by himself.

IV. Ten Sovereigns, or a Piece of Plate of that value, will be given to the Exhibitor, at the Meeting at Shrewsbury, of the best 14 bushels of Barley for malting, of the harvest of 1844, and grown by himself.

V. Ten Sovereigns, or a Piece of Plate of that value, will be given to the Exhibitor, at the Meeting at Shrewsbury, of the best 14 bushels of Oats, of the harvest of 1844, and grown by himself.

Competitors are requested to send with their wheat, barley, or oats, specimens, fairly taken, of the same in the ear, with the whole of the straw, in a sheaf not less than one foot in diameter, and with the roots attached.

[12 bushels of the wheat, barley, or oats will be sealed up by the Director or Stewards, and one of the remaining bushels of each variety will be exhibited as a sample to the public; the other being kept for comparison with the produce of the next year. At the General Meeting in December, 1846, the prizes will be awarded.]

The two best samples of each of these classes of wheat, barley, or oats, without at that time distinguishing, in any of the cases, between the comparative merits of either sample, will be selected by the Judges appointed for the Meeting at Shrewsbury; and will be sown, under the direction of the Council (the winter wheats in the autumn of 1845, and the spring wheat not earlier than the 1st of March, 1846), by four farmers, who will make their report, upon which the prizes will be awarded, provided there be sufficient merit in any of the samples. Ten Sovereigns will be given at the Meeting at Shrewsbury to each Exhibitor whose Wheat has been selected for trial, and Six Sovereigns for the Barley or Oats.

\* \* No variety which has been selected for trial at any previous show shall be qualified to compete in the same class.

---



ESSAYS AND REPORTS ON VARIOUS SUBJECTS.

---

Prizes for 1845.

---

PRIZE ESSAYS.

I. FARMING OF NOTTINGHAMSHIRE.

FIFTY SOVEREIGNS, or a Piece of Plate of that value, will be given for the best Report on the Farming of the County of Nottingham.

Competitors will be expected to describe the different varieties of soil which prevail in the county, the ordinary modes of farming and courses of cropping adopted accordingly in its various districts, and to state how far any peculiar practices in its husbandry are or are not justified by peculiarities of soil or climate. They will also be expected to state what improvements have been made in the farming of Nottinghamshire since the Report of Mr. Robert Lowe in the year 1798; and especially to point out what further improvements ought to be effected, either by better farming on land already cultivated, or by taking new land into cultivation.

N.B. The writers of County Reports are requested, if possible, not to exceed the length of 40 or at most 50 printed pages.

II. FARMING OF CORNWALL.

FIFTY SOVEREIGNS, or a Piece of Plate of that value, will be given for the best Report on the Farming of the County of Cornwall.

Competitors will be expected to describe the different varieties of soil which prevail in the county, the ordinary modes of farming and courses of cropping adopted accordingly in its various districts, and to state how far any peculiar practices in its husbandry are or are not justified by peculiarities of soil or climate. They will also be expected to state what improvements have been made in the farming of Cornwall since the Report of Mr. G. B. Worgan in the year 1811; and especially to point out what further improvements ought to be effected, either by better farming on land already cultivated, or by taking new land into cultivation.

## III. FARMING OF KENT.

FIFTY SOVEREIGNS, or a Piece of Plate of that value, will be given for the best Report on the Farming of the County of Kent.

Competitors will be expected to describe the different varieties of soil which prevail in the county, the ordinary modes of farming and courses of cropping adopted accordingly in its various districts, and to state how far any peculiar practices in its husbandry are or are not justified by peculiarities of soil or climate. They will also be expected to state what improvements have been made in the farming of Kent since the Report of Mr. John Boys in 1805; and especially to point out what further improvements ought to be effected, either by better farming on land already cultivated, or by taking new land into cultivation.

## IV. HEATH-LAND.

TWENTY SOVEREIGNS, or a Piece of Plate of that value, will be given for an account of the best method of Reclaiming Heath-land.

Competitors will be required to describe methods which have been successfully adopted in the reclaiming of heath-land, reference being had especially to the following points:—

1. The mode of breaking up, whether by paring and burning, or by simple ploughing.
2. The application of lime.
3. The course of cropping.
4. The conversion of heath-land into pasture, where either the steepness of the land, or its elevation above the sea, does not allow the culture of corn.

## V. ONE-HORSE CARTS.

TEN SOVEREIGNS, or a Piece of Plate of that value, will be given for the best Essay on the advantages of One-horse Carts.

Competitors will be required to point out the saving in horse-labour, and other advantages which undoubtedly arise from the substitution of one-horse carts for waggons.

## VI. CATCH-MEADOWS.

TWENTY SOVEREIGNS, or a Piece of Plate of that value, will be given for the best Essay on Catch-Meadows.

Competitors will be required to describe the best and cheapest method of forming water-meadows on the sides of natural slopes, as practised in Somersetshire and Devonshire; the mode of managing them, and of applying their produce; the increase of value thereby given to unpro-

ductive hill-sides: and to state how far this mode of improvement might be applied to the mountainous districts of Wales and of the North of England.

#### VII. FENCES.

TWENTY SOVEREIGNS, or a Piece of Plate of that value, will be given for the best Essay on Fences.

Competitors will be required to describe the best and neatest methods of maintaining hedges, whether for arable or for grazing ground; and to point out how far the present fences in various parts of England are injurious to the farmer, whether by their size, their excess in number, or the over-abundance of timber which they contain.

#### VIII. FATTENING CATTLE.

TEN SOVEREIGNS, or a Piece of Plate of that value, will be given for an account of the best method of fattening cattle; as to the places in which they are kept, large or small yards or stalls; as well as the food, roots, hay, &c., on which they are fed during the time of fattening.

#### IX. TILE-YARDS.

TWENTY SOVEREIGNS, or a Piece of Plate of that value, will be given for the cheapest and best method of establishing a Tile-yard.

Competitors will be required to attend to the following points:—

1. Mode of working the clay, according to its quality.
2. Machine for making the tiles.
3. Sheds for drying the tiles.
4. Construction of the kiln.
5. Cost of forming the establishment.
6. Cost of the tiles when ready for sale.

#### X. CURING BUTTER.

FIFTY SOVEREIGNS, or a Piece of Plate of that value, will be given for the best description of the Dutch method of salting butter; pointing out the causes of its superiority to other salted butters.

#### XI. EXPERIMENT IN AGRICULTURE.

TWENTY SOVEREIGNS, or a Piece of Plate of that value, will be given for an account of the best Experiment in Agriculture.

*These Essays must be sent to the Secretary, at 12, Hanover Square, London, on or before March 1st, 1845.*

## XII. GORSE.

TWENTY SOVEREIGNS, or a Piece of Plate of that value, offered by the Right Hon. Lord Kenyon, will be given at the Annual Country Meeting of the Royal Agricultural Society of England, to be held at Shrewsbury, in 1845, for the best account of the use of Gorse for the food of cattle, horses, or sheep, founded on actual experiment.

Competitors will be required to state the following points:—

1. The quality of land on which the gorse is grown.
2. The age of the plant when cut.
3. The mode and expense of cutting.
4. The mode and expense of preparing for food.
5. The mode of feeding with gorse, and the quantity of other food given therewith.

*Essays competing for this last Prize must be sent to the Secretary, at 12, Hanover Square, London, on or before May 1st, 1845.*

---

## RULES OF COMPETITION FOR PRIZE ESSAYS.

1. All information contained in Prize Essays shall be founded on experience or observation, and not on simple reference to books, or other sources.

2. Drawings, specimens, or models, drawn or constructed to a stated scale, shall accompany writings requiring them.

3. All competitors shall enclose their names and addresses in a cover, on which only their motto, and the subject of their Essay, and the number of that subject in the Prize list of the Society, shall be written.

4. The President or Chairman of the Council for the time being, shall open the cover on which the motto designating the Essay to which the Prize has been awarded is written, and shall declare the name of the author.

5. The Chairman of the Journal Committee shall alone be empowered to open the motto-paper of such Essays, not obtaining the Prize, as he may think likely to be useful for the Society's objects, with a view of consulting the writer confidentially as to his willingness to place such paper at the disposal of the Journal Committee.

6. The copyright of all Essays gaining prizes shall belong to the Society, who shall accordingly have the power to publish the whole or any part of such Essays; and the other Essays will be returned on the application of the writers; but the Society do not make themselves responsible for their loss.

7. The Society are not bound to award a prize unless they consider one of the Essays deserving of it.
8. In all reports of experiments the expenses shall be accurately detailed.
9. The imperial weights and measures only are those by which calculations are to be made.
10. No prize shall be given for any Essay which has been already in print.
11. Prizes may be taken in money or plate, at the option of the successful candidate.
12. All Essays must be addressed to the Secretary, at the house of the Society:

---

---

NOTICE.

It is requested that all communications, addressed to the Society, of experiments on land—whether of draining, liming, manuring, or other operation—be accompanied with the cost of such operation, with the value of the land to rent previous and subsequent thereto, and an analysis of the soil upon which such experiments have taken place; or a specimen of the soil, to be analysed by persons employed by the Society: it is also further requested that, in communications relative to experiments on land in foreign countries, the measures be stated in English values.

Those members who have tried subsoil-ploughing, whether successfully or otherwise, are requested to communicate the result to the Secretary, in the hope that, by comparison of the statements, some judgment may be arrived at as to the soils and situations which are, or are not, suited for this operation.

## General Meetings of 1845.

---

The GENERAL MAY MEETING, in London, on Thursday, May 22, 1845.

The ANNUAL COUNTRY MEETING, at Shrewsbury, in 1845.  
Principal Day of the Show, Thursday, July 17.

The GENERAL DECEMBER MEETING, in London, on the Saturday of the Smithfield Club Show-week : 1845.

---

---

COTTAGE ECONOMY.—Mr. Main's article on Cottage Gardening, and Mr. Burke's compilation on Cottage Economy and Cookery, have each been reprinted from the Journal in a separate form, for cheap distribution. Either or both of these tracts may be obtained by members at the rate of 1s. per dozen copies, on their enclosing to the Secretary a Post-office money-order for the number required; at the same time stating the most eligible mode of conveyance by which the copies can be transmitted to their address. They are also sold to the public at 2*d.* each, by the Society's Publisher, Mr. MURRAY, 50, Albemarle Street, London.

VOLUMES OF THE JOURNAL.—The first Volume of the Journal consists of *four* parts, the second and third Volumes of *three* parts each (the second and third parts of the third Volume being comprised in a double number), and the fourth of *two* parts. The Journal is now published half-yearly, namely, in half-volumes, at the middle and end of each year.

SUBSCRIPTIONS may be paid to the Secretary, in the most direct and satisfactory manner, by means of Post-office orders, to be obtained on application at any of the principal Post-offices throughout the kingdom. They are due in advance, for each year, on the 1st of January; and are in arrear if unpaid by the 1st of June ensuing. No Member is entitled to the Journal whose subscription is in arrear.

---

---















New York Botanical Garden Library



3 5185 00257 6823



Made in Italy

02-11 STD



8 032919 990020

[www.colibrisystem.com](http://www.colibrisystem.com)

