

**NBSIR 74-616**

# **Parcel Post and You**

---

Joel J. Kramer and Clare P. Goodman

Technical Analysis Division  
Institute for Applied Technology  
National Bureau of Standards  
Washington, D. C. 20234

November 1974

Final Report

Prepared for  
**Engineering Department**  
**U.S. Postal Service**  
**Washington, D. C. 20260**



NBSIR 74-616

## PARCEL POST AND YOU

Joel J. Kramer and Clare P. Goodman

Technical Analysis Division  
Institute for Applied Technology  
National Bureau of Standards  
Washington, D. C. 20234

November 1974

Final Report

Prepared for  
Engineering Department  
U.S. Postal Service  
Washington, D. C. 20260



---

U. S. DEPARTMENT OF COMMERCE, Frederick B. Dent, Secretary  
NATIONAL BUREAU OF STANDARDS, Richard W. Roberts, Director



Parcel Post and You

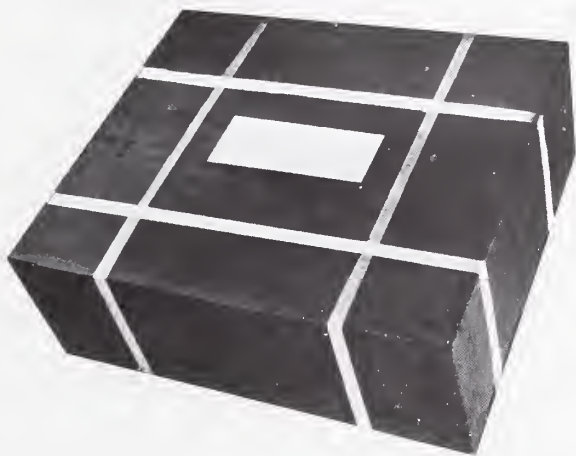



## QUICK REFERENCE

<u>Subject</u>	<u>Page</u>
US Postal Service and Parcel Post	2
How You Can Help Your Parcel to be Delivered Safely and on Time	4
Outer Containers, Boxes, Bags, Packs, Crates, Mailing Tubes	5
Inside Packaging	9
How to Use Wadding for Mailing Fragile Carry-Home Packaged Merchandise	13
Closure and Reinforcement	14
Wrapping the Parcel	21
Labeling and Marking Your Parcel	22
Special Markings Such as "Handle With Care"	24
How Good a Packaging Job Have You Done?	24
Packaging Products or Articles Most Subject to Parcel Damage	25
Specific Packaging Guidelines	26

## I. THE U.S. POSTAL SERVICE AND PARCEL POST

Prompt delivery of your Parcel Post packages in good condition is the aim of the U.S. Postal Service. Millions of parcels are handled each day in about 35,000 postal facilities in the United States. Parcels of all different sizes, shapes, weights and types enter the mailstream through the receiving window or the unloading dock. Figure 1 shows a sample of the variety in parcel post for any day.



(NBS)

Figure 1. A variety of parcels.

A brief look at how your parcel moves through the Parcel Post system will help you to understand the environment into which your parcel goes. Basically, it travels from the acceptance window through various forms of processing and transportation to its final destination. Packages are moved both manually and mechanically. At large modern facilities, parcel movement and processing are carried out by semi-automated equipment. Figure 2 shows one form of mechanization.





Figure 2. Conveyor--one type of postal mechanization. (NBS)

Between cities, parcels are moved by rail, truck, or air and on a single journey your parcel may be transported by several different means of transportation. Figure 3 shows how parcels are stacked in a truck for transport to the next distribution point.



Figure 3. Parcels being loaded for highway travel. (NBS)  
Long parcels are loaded last.

While your parcel is being carried on its way it may occasionally experience some of the vibrations and shocks found in all handling, transportation and distribution centers. Your basic responsibility as the mailer is to get your parcel off to a good start by packaging your goods adequately and securely.

## II. HOW YOU CAN HELP YOUR PARCEL TO BE DELIVERED SAFELY AND ON TIME

An adequately packaged parcel will protect your merchandise and help the Postal Service to process and deliver it without delay. At some time during processing and transportation your parcel may have others stacked on top of it or bumped against it.



A parcel may be crushed.

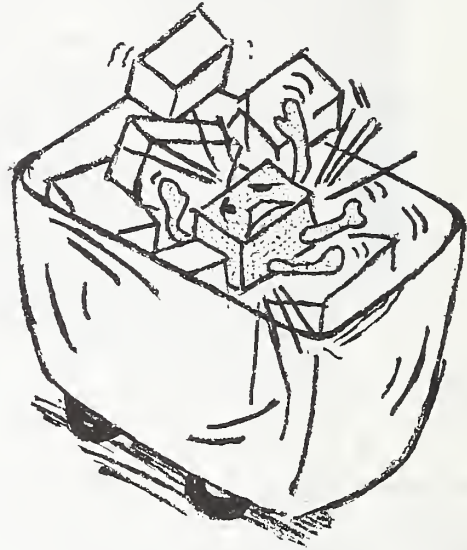

A parcel may receive bumps.

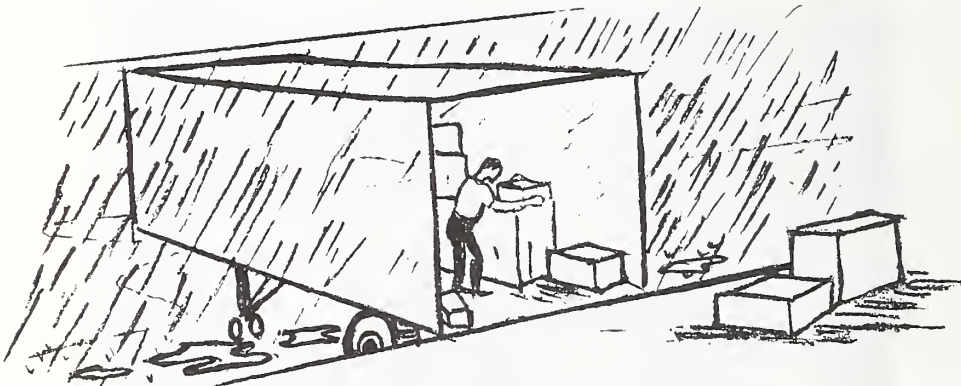

A parcel may be exposed to heat, cold, humidity or rain.

Figure 4.

This brochure presents some basic steps and general information that will help you package your goods for safe delivery. More specific details and technical information can be found in the Handbook "Packaging for Parcel Post." Your postmaster or his representative will have a copy available.

## OUTER CONTAINERS

- Should be strong enough to protect against situations like those shown in Figures 1-4.
- Should be big enough to hold all the items being packed, but not much larger. Too much space inside allows excessive movement which weakens internal support for the container.
- Should never be too tight for the contents and packing. The container below was too small for its contents.



Figure 5. When a container is too small for its contents. (NBS)

- Should be made stronger with internal packaging or blocking when holding fragile or soft merchandise.
- May be:
  1. A Box, made of solid or corrugated fiberboard, (See Figure 6).

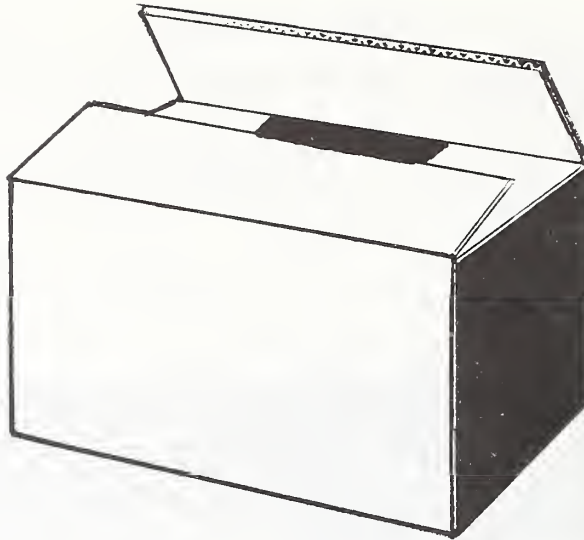

(Courtesy, Fibre Box Assn.)

Figure 6. Corrugated fiberboard box.

2. A Bag, like those in Figures 7, 8, and 9. Cushioned, reinforced, utility or corrugated bags are intended for relatively small, light-weight, non-fragile items without pointed projections or sharp edges. Cushioned bags can be purchased at post offices.

3. A Container of other type, style, construction, or material suitable for the contents. Such containers include but are not necessarily limited to: paperboard boxes, film packs, bookpacks, wooden boxes and crates, record packs, drums, cans, mailing tubes, and textile bags.

Figure 7. Two types of cushioned or padded bags in common use: one with internal plastic cells; the other with recycled paper fibres (macerated newsprint).

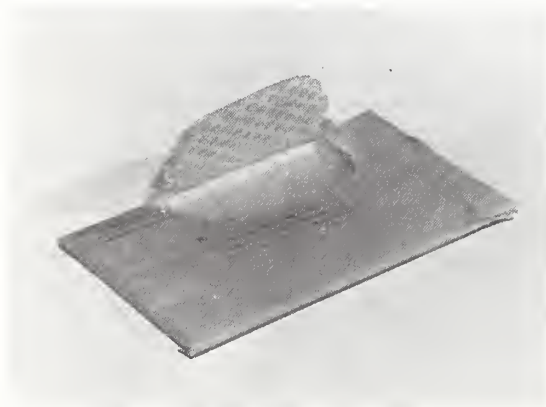

Bag has been cut to show bubble structure. (NBS)



Internal wall of bag bonded to paper cushioning. (USPS)



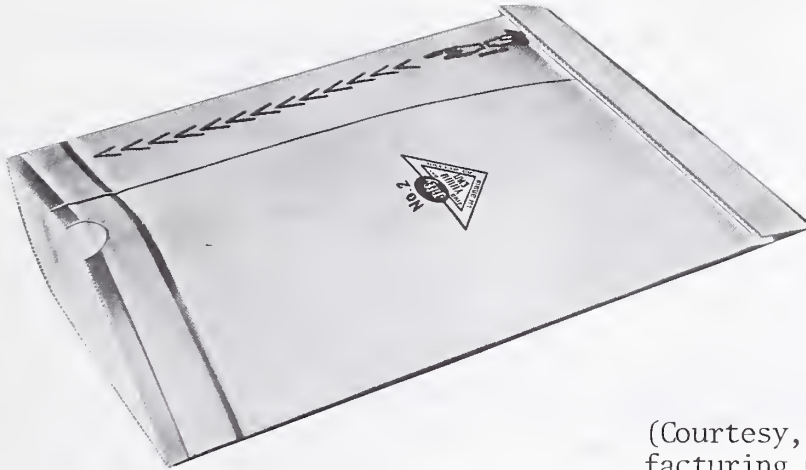

(Courtesy, Jiffy Manufacturing Company)

Figure 8. Heavy duty unpadded bag.

- If you use a cushioned, reinforced, utility, or corrugated bag, choose a size that allows your goods to be slipped in easily but which holds them snugly in position after they are inside.
- If you must use a regular paper bag or envelope, make sure that it is reinforced with strong packaging tape. Lightweight paper will not give the sturdy protection needed from an outer container.

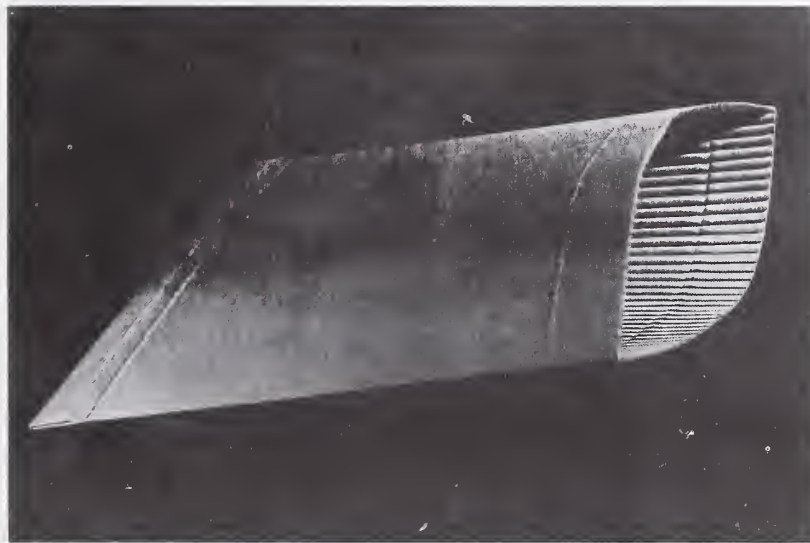

Figure 9. Corrugated bag.

(Courtesy, St. Regis Paper Co.)

- If your box is too small or too snug, get a larger box and cut it down, as shown below.

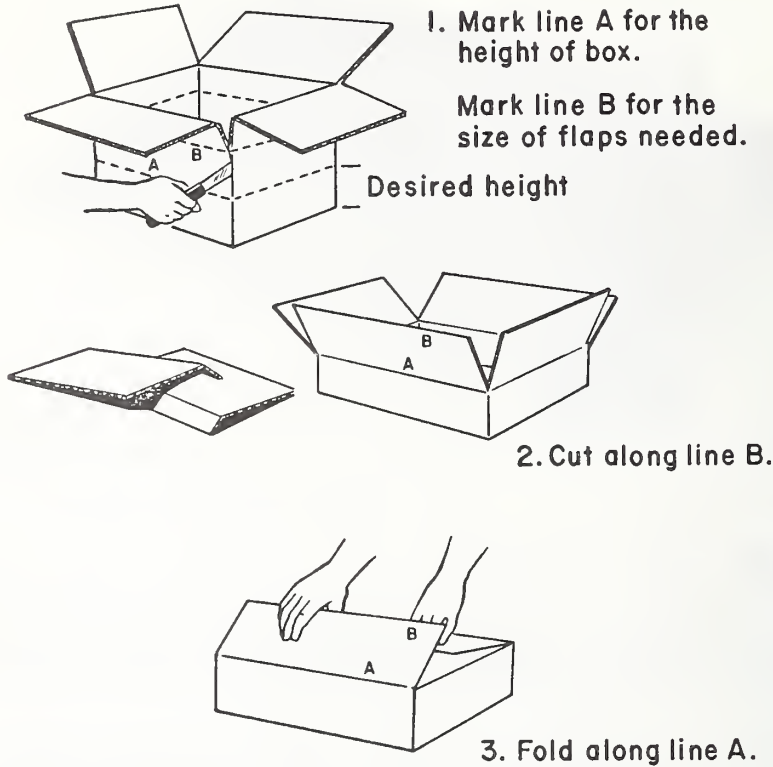
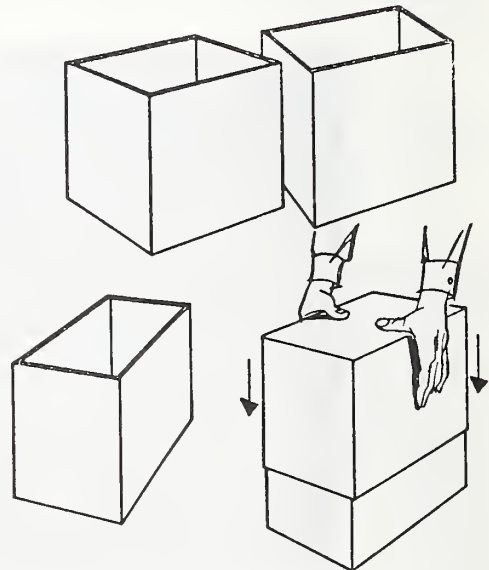

Figure 10. Procedure for cutting down a box.

(NBS)

- If your box needs to be made stronger, find another box a little larger but of similar shape. Remove the flaps of both boxes, turn the smaller box open side up and slide the larger box down over it. This "telescoping" greatly increases the strength of the box walls. The bottom and top may also need reinforcement.



Making a stronger container

(NBS)

Figure 11. Making a telescoping container.

### INSIDE PACKAGING:

- Inside packaging prevents damage to the article being mailed and gives the outside container support and strength.
- Choose one or more of the packing materials described below to hold your goods in position inside the container. Heavier items need sturdier, more rigid packaging materials.
  1. Cushioning. For relatively fragile goods, many other internal packing materials are available whose prime function is cushioning against shock and vibration. These materials include but are not necessarily limited to: polyethylene, expanded polyethylene, urethane foam, polyurethane foam, rubberized hair, polyvinyl chloride, plastic foam sheeting, and cushioned wrapping.
  2. Loose-fill. This material fills up space all around the item being packed. Use clean shredded newspaper; a soft, spongy material cut into strands; or small plastic foam pieces. Plastic foam pieces of loose-fill are good for packing light and medium weight items of any shape. Follow the steps shown in Figure 13 when using loose-fill.



(NBS)

Figure 12. Shredded newspaper as loose-fill.

Packing with loose fill is simple and easy. Maximum protection for the packaged item is provided by using the packing technique described.

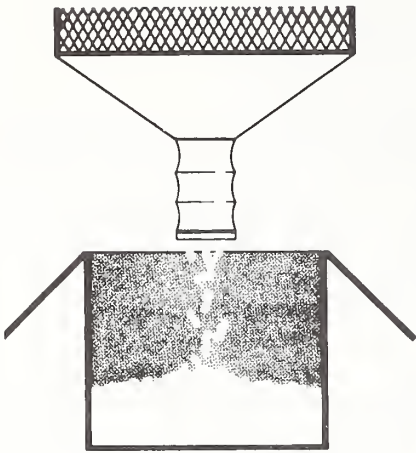

1. Dispense a layer of loose fill in the bottom of the box. If the application is critical, be sure the proper thickness for adequate protection is used.

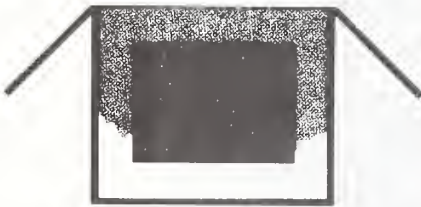

2. Place the item to be packaged on the bed of loose fill.



3. Fill side voids with additional loose fill.

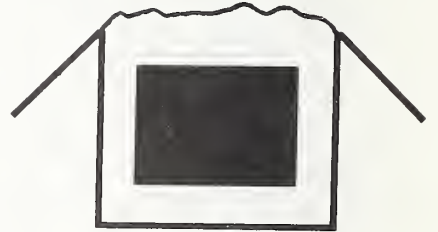

4. Fill the remainder of the carton or container to an excess.



5. Press down firmly to close. Cushioning material will interlock. Then seal the carton.

(Courtesy, Dow Chemical Co.)

Figure 13. Procedure for packing with loose-fill.



3. Partitions and Internal Supports. Partitions separate items from each other inside a container so that each piece has its own snug-fitting section. Supports also are used to protect items from contact with each other inside and from shock or crushing by other containers. See the Figures below for examples. Partitions or supports are usually made from corrugated fiberboard, chipboard, or paperboard although the latter two should be used only for lightweight items. Within each cell, there may be a need for filler material to prevent movement.

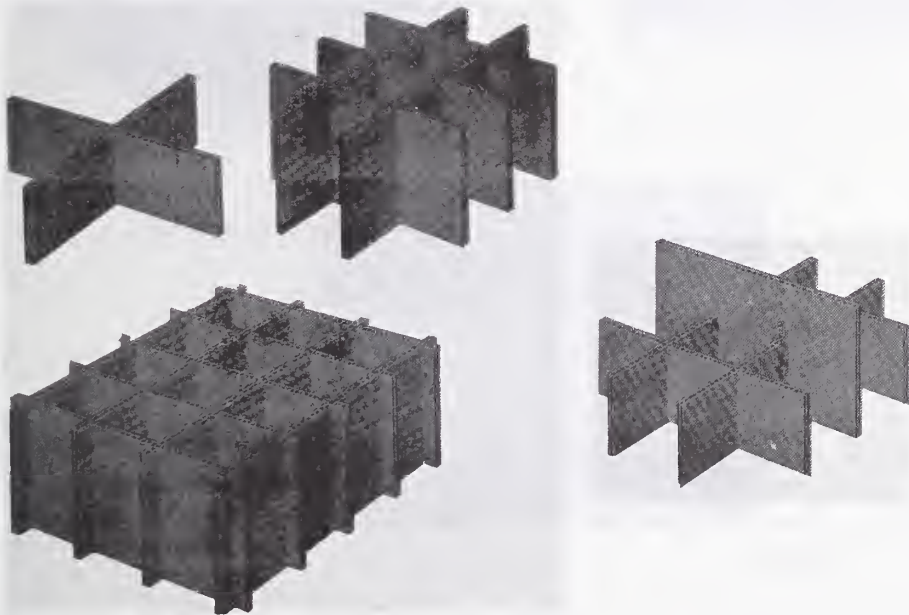

Figure 14. Partitions.

(Courtesy, Fibre Box Assn.)



Figure 15. One type of product support.

(NBS)

4. Corner Pads. Such pads fill the corners of the container to support the container and help prevent parcel contents from shifting position inside. Fiberboard, newspaper, plastic, or fabrics make good corner pads. This figure shows one type.

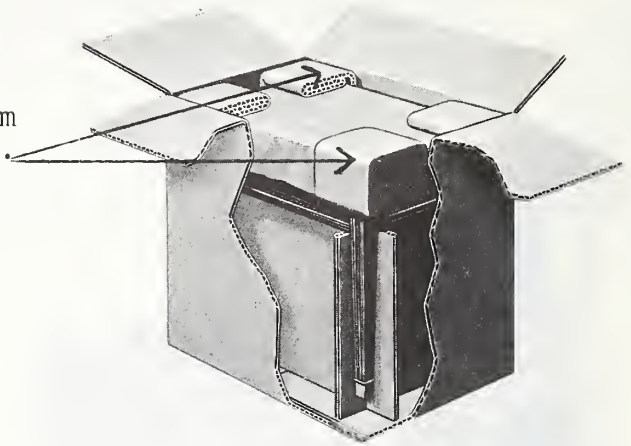

(Courtesy, Fibre Box Assn.)

Figure 16. Corner Pads

5. Plastic Bags. These bags protect your merchandise against dirt, dust, scratching, etc. Plastic bags should be used mainly inside other containers but some of heavy grade are now being employed as external shipping containers for unbreakable goods that have no sharp corners or edges. Make sure the bag has no holes or tears. Plastic bags should have an adequate tie or tape closure.
6. Wadding. This material wraps, pads, lines, blankets, or simply stuffs the inside of a container. Wadded and compressed newspaper or wadding made of cellulose or cotton materials will pack non-fragile items satisfactorily. Suit the thickness to the needs of the item. Follow the steps in Figure 17, and make sure that: (a) All critical points of the merchandise are protected; (b) All spaces are filled; and (c) The wadding is crumpled tight enough to provide protection but not overly tight.



1. Make a bed in the bottom of the container.



2. Place merchandise and stuff the sides.



3. Pad all points, edges, and corners.



4. Cover merchandise with enough wadding to provide cushion.



5. Close the top with a little pressure to make the package a secure unit.

Figure 17. Procedure for using wadding for mailing fragile carry-home packaged merchandise.

CLOSURES AND REINFORCEMENT:

● Tapes:

1. Gummed or Pressure Sensitive Tape. For light packages under 20 pounds, use tape of at least 60 pounds basis weight, two inches wide. See Figure below for application steps. Do not use for heavy packages over 20 pounds. For heavy packages use the tape described below.

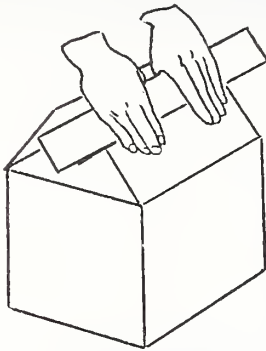

1. Apply first strip to far flap, then close flaps and seal center seam.

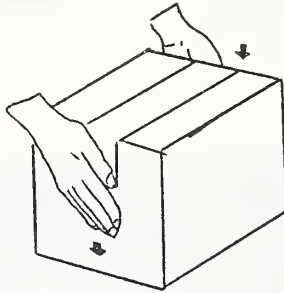

2. Press down overlap on ends (3 inch overlap on each end.)

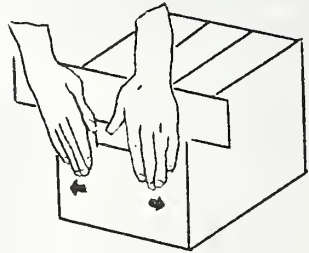

3. Seal edge seams with 3 inch overlap beyond corners.

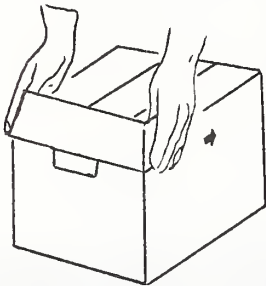

4. Bend around sides and pull tightly into position.

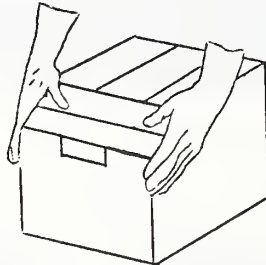

5. Fold corners over the top and press firmly, then fold and press top.

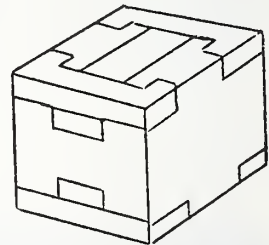

6. Repeat steps 3, 4, and 5 on the other end of the box.

Figure 18. Applying gummed or pressure sensitive paper tape.

2. Reinforced Tapes. These gummed tapes consist of a rolled or laminated paper structure with glass, rayon, or polyester fibers embedded throughout. Three different reinforcement patterns are shown below.

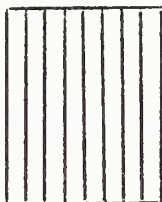

Lengthwise

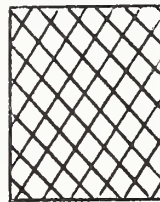

Combination



Bi-Diagonal



To apply reinforced gummed tapes, activate the gum with warm water or other specified liquid. Firmly apply to the box, allowing the tape to extend three inches over the adjacent side of the box. Two strips of tape are necessary for light duty packaging when used as shown in Figure below. Only one strip is needed if the bottom has been stitched, stapled, or glued. However, if the container has been used before, tape should also be applied to the bottom.

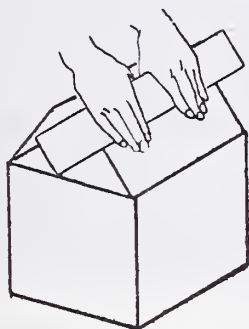

1. Apply one strip of tape, at least 2" wide, to far flap. Overlap 3" on each end.

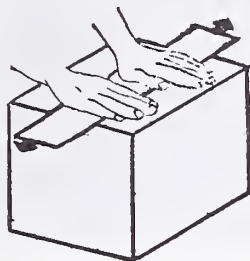

2. Close flaps and seal center seam.

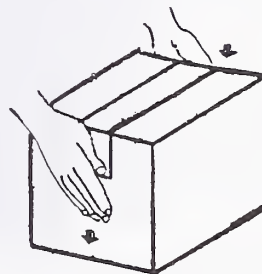

3. Fold down and press overlaps on each end.

Figure 19. Applying reinforced gummed tape or pressure sensitive plastic tape.

3. Pressure-Sensitive Plastic Tape (requires no wetting). Use only polyester backed plastic tape at least two inches wide and apply as shown in Figure 19 (above). For gross weight over 20 pounds, the polyester backed tape must be at least 0.0015 inches (1 1/2 thousandths) thick. Thinner polyester tapes may be used for light weight parcels. Polyester backed tapes can be distinguished from other plastic tapes by their extreme resistance to tear and puncture.
4. Pressure-Sensitive Filament Tape (requires no wetting). Recommended for reinforcing cartons. This is an extremely strong tape of plastic film with reinforcing strands of glass or synthetic fibers.

A reinforcing strip of pressure-sensitive filament tape is called a "clip". Large boxes (over 20 pounds) which need more reinforcement should have two or more C-clips as shown in Figure 20. L-clips are suitable for ends of light-weight parcels. When added strength or security is needed, closures can be reinforced with C-clips of pressure-sensitive filament tape. (See Figure 20).

C-Clip  
(3-surfaces;  
far side  
hidden)

L-Clip  
(2-surfaces)

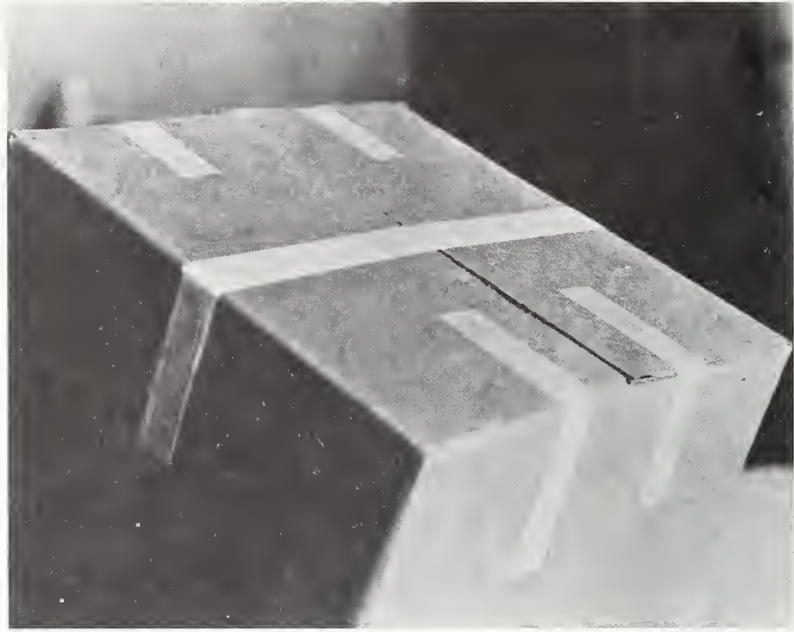

(NBS)

Figure 20. Pressure-sensitive filament tape clip application.

When applying any type of tape, make sure that:

- All materials are at normal room temperature and free of dust or other foreign matter.
- The tape sticks securely. Gummed and reinforced kraft must be adequately wetted and properly smoothed onto the carton. Figure 21 shows a parcel taken from the mailstream because of inadequately wetted gummed tape.
- The tape sticks to the whole surface of the container, particularly at the ends.
- Do not use plain cellophane or masking tape for closing or reinforcing packages.



(NBS)

Figure 21. Results of improperly wetting and applying gummed tape.

- Stapling and Stitching:

Stapling is the process of closing a parcel with a piece of preformed metal wire dispensed from a magazine-fed machine. Stitching is the process of closing a parcel with a machine which uses a short piece of wire formed from a continuous coil at the moment of use. Stapling and stitching are useful for closing cushioned and corrugated bags, unpadded utility bags, and reinforced bags. Boxes may also be closed by using staples or stitching.



(Courtesy, Jiffy Manufacturing Co.)

Figure 22. Stapling a cushioned bag.

When using staples or stitching:

- Use only heavy duty staples. The typical lightweight home or office stapler is not usually adequate.
- Space staples evenly across the area to be closed. Do not leave gaps greater than three inches. Bags should be closed with at least three staples.
- Cover the closure with tape if staples are used.
- Staples do not provide a dust or moisture-proof closing. When contents can be damaged by foreign substances, apply tape to seal closure.
- Staples must pass completely through at least two thicknesses of container material to be effective. For fold-over closures, the staples must pass through four thicknesses and be clinched.
- Use another method such as tape or glue for closing rather than staples, if the outside packaging material is weak.
- Staples can be hazardous (as shown below) if they are not properly applied or become loose during handling. Be sure the staples do not show sharp ends. When loose or oversize, staples injure postal customers and employees, scrape or mar equipment, snag clothes, and damage other parcels. Staples should be clinched tightly and covered with tape to prevent snagging. Staples too long for the job should not be used.



Figure 23. Hazardous staple.

(NBS)



- Locking Tabs:

Certain types of containers are designed with their flaps cut in such a way that they will interlock when closed. These closures must be taped for security.

- Cuffs:

Cuffs are extensions on certain types of mailing tubes that are tucked inside the tube to retain the contents after they have been inserted.

- Metal Clips:

Metal clips are used to secure lids of cans or similar containers. The specific design used by the mailer must be approved by the Postal Service.

- Adhesives:

To achieve a good closure with adhesives, it is necessary to allow sufficient drying time while adequate contact pressure is maintained between the two adhering surfaces. Depending on the container, the adhesive should cover 50-75% of the overlapping area.

When applying adhesives to a regular slotted container, the top and bottom flaps of the fiberboard box should be firmly glued together. At least 50% of the surface area of contact between the flaps should be covered with adhesive, and the adhesive should be spread to within 1/4 inch of the edges of the inner flaps as shown below.

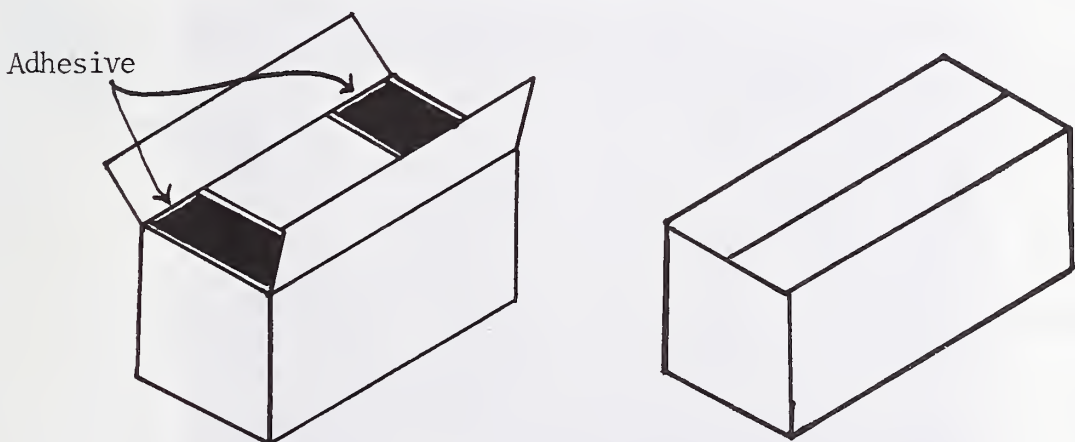

Figure 24. Proper adhesive application for a regular slotted container.

### When using adhesives:

- Make sure the adhesive is applied securely so as to prevent lifting of edges in handling.
  - Make sure the adhesive selected is recommended for the packaging material. Many containers are treated to repel water, grease, or both and exceptional care must be taken in the selection of adhesives for such packaging materials.
  - When adhesive has been applied, make sure adequate time and enough contact pressure have been given to form the bond properly.
  - Make sure adhesive has not been applied too thinly. A thick film is generally stronger than a very thin one.
  - Take special care with glossy surfaced shipping containers, the glaze sometimes causes adhesion problems.
  - If you are using plastic containers, be sure the adhesive is appropriate to the type plastic involved.
- Banding or Strapping:

Bandings and strappings are primarily used for self-containing and reinforcing containers after they have been properly closed or sealed. Plastic and metal strapping as well as reinforced filament tape are typically used for this purpose. Care must be taken in application to make certain that bandings are tight and will not loosen and fall off.

- Ties:

If you have closed your container properly with tape or staples, tying cord or twine around it probably isn't necessary even though it will give added support and reinforcement. Ties should not be used as the only means of closing a parcel. If you do tie your parcel:

1. Use strong twine or cord.
2. Don't skimp on the amount, use enough.
3. Follow the steps shown in Figure 25.

Reinforced tape may be used as an alternative to tying.

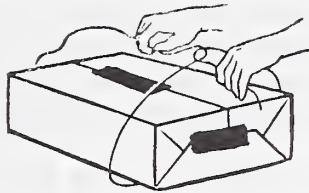

1. Loop twine around parcel as shown



2. Tie a Knot

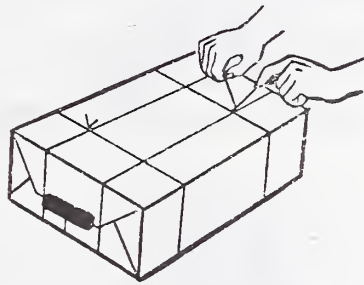

3. Repeat 1 and 2 as shown

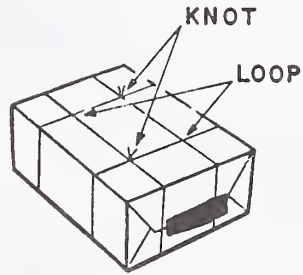

4. Completed parcel

Figure 25. Tying procedure.

WRAPPING THE PARCEL:

- Do not rely on wrapping alone to serve as a container for sending goods through the mail; the mailer of the parcel in the Figure below did just that!



(NBS)

Figure 26. Do not rely on the wrapping alone to protect a parcel.

- Heavy paper wrapping may be used on the outside of a parcel to cover a reused box if there is unnecessary printing on it. To eliminate needless use of wrapping paper, unwanted markings can be covered with paper tape, blotted out with ink, or simply crossed-out.
- To wrap a container, follow the steps shown in the Figure below.

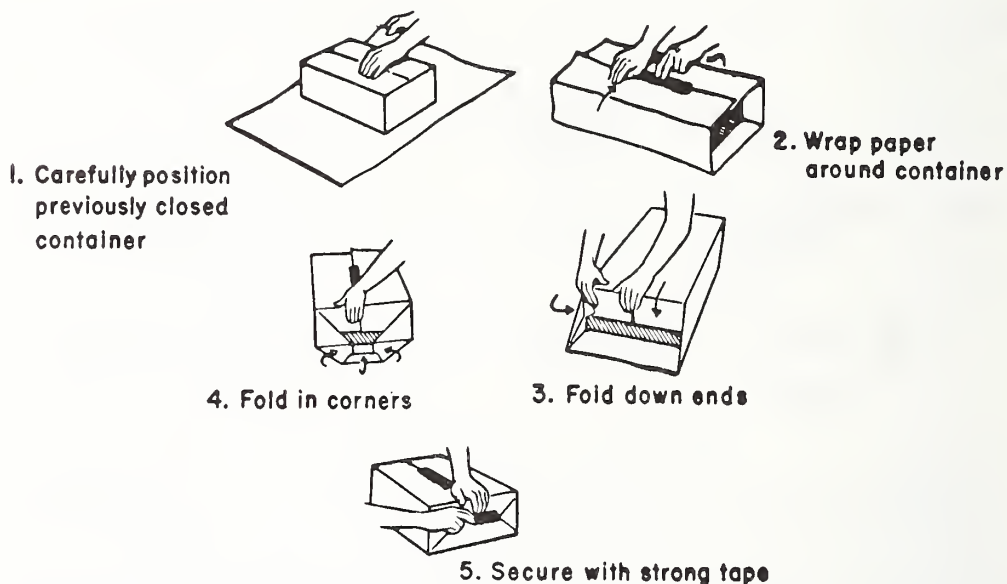

Figure 27. Wrapping a container with paper prior to tying or banding.

### LABELING AND MARKING YOUR PARCEL:

- Addressing the Parcel

A good address label is absolutely essential to get your parcel to the right addressee:

1. Print or type clearly all letters and numbers.
2. Use letters and numbers big enough to be read easily from a distance of 30 inches.
3. Use an ink or other printing medium which is not soluble in water and cannot be rubbed off easily with light finger pressure.

4. Put no other information within two inches of any edge of the address label.
5. For added protection, place a supplemental address label inside the package.

● Attaching the Label

1. Apply label to a flat surface free from dust, dirt or other particles that might reduce sticking power.
2. Be sure that all of the label makes contact with the surface.
3. Smooth out all folds or wrinkles.
4. Use extra smoothing pressure on corners and edges.
5. If tags must be used, attach them firmly, preferably with a wire leader, making sure that sharp edges are clinched or blunted and taped.
6. Avoid unprotected flimsy, multi-copy or carbon-copy labels. The Figure below shows what can happen to labels of this kind. Use plastic label protection tape for added security in holding and protecting the label.



(NBS)

Figure 28. What may happen to a carbon-copy label.



7. Place label on only one side or surface of the package.
8. Use transparent plastic label protection tape when there is doubt about ability of label to stick or the ability of inks to resist smudging.
9. Use of an additional "From" and "To" address label inside of the package is encouraged.

● Special Markings Such as "Handle With Care":

1. Use only when your merchandise really is fragile or breakable, but remember that since mechanized equipment can't read caution markings, such markings will not make up for inadequate packaging.
2. Use markings approved by the Postal Service in preference to others.
3. Use "Fragile" only for delicate items such as glass.
4. Use "Perishable" only for contents that will degrade or decompose rapidly such as meat, produce, plants, or certain chemical samples.
5. Use "Do Not Bend" only when contents are protected with stiffeners inside the container.

III. HOW GOOD A PACKAGING JOB HAVE YOU DONE?

The Postal Service makes every effort to handle your parcels with care, but you can still test the adequacy of your packaging by asking yourself some of the following questions. If you can answer "Yes" to all of them, your package will have a better chance for successful delivery.

1. Would you let your parcel roll off a table? (A drop of this kind may be experienced in transportation or mail handling.)
2. Would you let another parcel roll off a table and hit yours on the top? (Your parcel could experience this.)
3. Is your parcel protected against internal leakage or from possible exposure to rain, cold, or heat?
4. Is the address label easily readable from a distance of 30 inches and is it securely attached?

If you cannot answer "Yes" to all of these questions, repackage or reinforce your parcel before you mail it. When in doubt about how to package special articles, check with your postmaster or his Customer Service Representative.

#### IV. PACKAGING PRODUCTS OR ARTICLES MOST SUBJECT TO PARCEL DAMAGE

Some items shipped through the mail exert unusual and unexpected pressures on their containers. USPS survey data indicate that improper packaging of books, fabrics, and unrestrained hardware results in greater parcel damage than is normally found with other categories of merchandise.

- Books

Always band or tie books together (in both directions) before putting them into any container. The Figure below shows what frequently happens to books when the box is all that holds them together.



Figure 29. How Not to package books.

(NBS)

- Heavy or Awkward Goods

If you are planning to ship heavy or awkwardly shaped units such as metal parts or hardware, good internal packing is essential. Package these items so that:

1. They cannot move, hammer, or shift inside the container;

2. The container closure or corners will be strong enough to bear the load; and
3. Additional protection is provided by the use of two-way taping or tying on the outside of the parcel.

The Figure below shows what happened to one shipper's product when the package did not prevent shifting of the contents.



(NBS)

Figure 30. Unrestrained hardware.

- Fabrics

When a tightly sealed corrugated container filled with soft goods is struck by a heavier parcel, the container will literally "explode" like an inflated paper bag. Ventilation of the external container helps greatly in reducing these internal pressures.

## V. SPECIFIC PACKAGING GUIDELINES

For specific guidance on packaging a particular item or type of item, and for a more comprehensive and complete description of materials and containers, please refer to the handbook Packaging For Parcel Post available from your postmaster or his Customer Service Representative.



## VI. LET USPS HELP YOU

In this little booklet the U. S. Postal Service has tried to show you some basic ideas about how to package your goods to help them get to their destination in acceptable condition. The Postal Service will take the best possible care of your parcel, but it is your responsibility as the mailer to build into your package the necessary protection for its journey. For further help, please call on your local postmaster or his Customer Service Representative.

U.S. DEPT. OF COMM. BIBLIOGRAPHIC DATA SHEET	1. PUBLICATION OR REPORT NO. NBSIR 74-616	2. Gov't Accession No.	3. Recipient's Accession No.
4. TITLE AND SUBTITLE  Parcel Post and You		5. Publication Date November, 1974	
		6. Performing Organization Code	
7. AUTHOR(S) Joel J. Kramer and Clare P. Goodman		8. Performing Organ. Report No. NBSIR 74-616	
9. PERFORMING ORGANIZATION NAME AND ADDRESS  NATIONAL BUREAU OF STANDARDS DEPARTMENT OF COMMERCE WASHINGTON, D.C. 20234		10. Project/Task/Work Unit No. 4314436	
		11. Contract/Grant No.  73-01268	
12. Sponsoring Organization Name and Complete Address (Street, City, State, ZIP) Engineering Department U.S. Postal Service 475 L'Enfant Plaza West, S.W. Washington, D.C. 20260		13. Type of Report & Period Covered Final	
		14. Sponsoring Agency Code	
15. SUPPLEMENTARY NOTES			
<p>16. ABSTRACT (A 200-word or less factual summary of most significant information. If document includes a significant bibliography or literature survey, mention it here.)</p> <p>The U.S. Postal Service has been implementing a program aimed at reducing damage to Parcel Post. One phase of this program concerns the relationship between packaging and parcel damage. This report briefly describes the Parcel Post processing environment and presents packaging guidelines for the occasional mailer of Parcel Post packages. Topics covered include: outer containers, inside packaging, closure and reinforcement, and labeling and marking.</p>			
<p>17. KEY WORDS (six to twelve entries; alphabetical order; capitalize only the first letter of the first key word unless a proper name; separated by semicolons)</p> <p>Damage reduction; packaging; Parcel Post</p>			
<p>18. AVAILABILITY <input type="checkbox"/> Unlimited</p> <p><input checked="" type="checkbox"/> For Official Distribution. Do Not Release to NTIS</p> <p><input type="checkbox"/> Order From Sup. of Doc., U.S. Government Printing Office Washington, D.C. 20402, SD Cat. No. C1?</p> <p><input type="checkbox"/> Order From National Technical Information Service (NTIS) Springfield, Virginia 22151</p>		<p>19. SECURITY CLASS (THIS REPORT)</p> <p>UNCLASSIFIED</p>	<p>21. NO. OF PAGES</p> <p>27</p>
		<p>20. SECURITY CLASS (THIS PAGE)</p> <p>UNCLASSIFIED</p>	<p>22. Price</p>