

CORNELL
UNIVERSITY
LIBRARY



GIFT OF

Prof. O. D. von Engeln

Corneil University Library
QE 501.L53

Structural geology,



3 1924 004 094 623

enpr

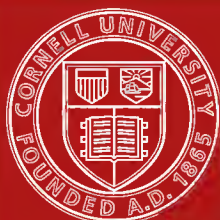

Cornell University
Library

The original of this book is in
the Cornell University Library.

There are no known copyright restrictions in
the United States on the use of the text.

<http://www.archive.org/details/cu31924004094623>

STRUCTURAL GEOLOGY

BY

C. K. LEITH

UNIVERSITY OF WISCONSIN



NEW YORK
HENRY HOLT AND COMPANY
1913

COPYRIGHT, 1913
BY
HENRY HOLT AND COMPANY

PRESS OF T. MOREY & SON,
GREENFIELD, MASS., U. S. A.

P. O.

INTRODUCTION

The central feature of structural geology is the interpretation of structures produced in rocks by earth movements. The outer limits of structural geology are not clearly defined, for in one way or another the subject is interrelated with nearly all phases of geology. Its purpose is the study and interpretation of rock structures, not for themselves, but for the light they may throw on stratigraphic problems, on economic geology, on the causes underlying the general configuration of the earth, and on earth's history.

The structural geologist has in recent years found it necessary in his field work to give much attention to the genetic relationships of rock structures produced by deformation. Some of these relationships have not yet found expression in the available literature on the subject. The student reads in general text-books about individual structures but seldom of their relations, with the result that at least in his early field work he may fail to utilize methods which are helpful or essential in the interpretation of the geology of a district. Emphasis upon geological structures as related parts of a record or process rather than as isolated facts determines the method of presentation in this book. Illustrations are chosen principally from the United States.

Primary structures of rocks, such as bedding and igneous structures, are to be considered in the study of structural geology, but these receive more or less adequate treatment in stratigraphic and petrographic geology. The writer will therefore treat these subjects only incidentally, putting the emphasis on secondary structures developed in rocks by earth movements.

The writer is indebted to Professor Eliot Blackwelder of the University of Wisconsin for several of the illustrative examples of the expression of structures on the erosion surface, and to Professor W. J. Mead for important suggestions relating to experimental deformation. Greatest of all is the writer's obligation to President C. R. Van Hise, who as teacher and associate in geologi-

cal field work originated and developed many of the ideas expressed in this book. For some years the structural discussion in Van Hise's "Principles of North American Pre-Cambrian Geology"¹ has been widely used by American teachers of structural geology. The writer had the privilege of association with Dr. Van Hise in the development of that work, and the present volume is partly a development and revision of the ideas of that paper.

¹ Van Hise, C. R., Principles of North American Pre-Cambrian Geology: 16th Ann. Rept. U. S. Geol. Survey, pt. 1, 1896, pp. 571-874.

CONTENTS

	PAGE
INTRODUCTION	iii
FRACTURE AND FLOW	1
KINDS OF FRACTURE AND FLOW STRUCTURES	1
DISTRIBUTION OF FRACTURE AND FLOW STRUCTURES	1
CONDITIONS FAVORING FRACTURE OR FLOW	4
DEPTH NECESSARY FOR ROCK FLOW	9
VOLUME CHANGES IN FRACTURE AND FLOW	11
SURFACE EXPRESSION OF THE ZONES OF FRACTURE AND FLOW	12
FRACTURES	14
ATTITUDES OF FRACTURES WITH REFERENCE TO STRESSES	14
TENSION FRACTURES	14
COMPRESSION FRACTURES	16
JOINTS	21
Joints which can be classified as due to tension	22
Joints which can be classified as due to compression	23
Joints developed under unknown stress-strain conditions	28
Widening of joints by the linear force of growing crystals	29
Surface expression of joints	30
Suggestions for laboratory work on joints	31
FAULTS	31
Nomenclature	32
Apparent and real fault displacements	36
Normal faults	39
<i>Normal faults associated with igneous rocks</i>	42
<i>Normal faults in unfolded sediments</i>	43
<i>Association of normal faults with folds</i>	43
<i>Vertical and steeply-dipping normal faults and joints in intersecting systems</i>	44
Reverse or thrust faults	46
<i>Distributive thrust faults</i>	48
Faults with horizontal displacements	50
Hinge or pivotal faults	50
Curved and folded faults	51
Faults passing into folds or into schistose zones	51
Correlation of faults	53
Relative number of normal and reverse faults	54
Relative shortening and elongation of the earth's crust by faulting	55

FAULTS— <i>Continued</i>	PAGE
Evidence of faulting	56
Surface expression of faults	57
Suggestions for laboratory study of faults	60
FRACTURE CLEAVAGE AND FISSILITY	61
BRECCIAS AND AUTOCLASTICS	64
EARTHQUAKES	67
Earthquakes as cause and effect of rock fracture	67
Kinds of fracturing accompanying earthquakes	69
Earthquakes and oscillations of glaciers	70
Earthquakes and vulcanism	70
Earthquakes and magnetic disturbances	70
Earthquakes and rock density	70
Earthquake zones	71
Instruments for determining and measuring earthquakes	71
Earthquake waves	72
Condition of earth's interior as inferred from earthquake waves	72
Location of the origin of earthquakes	73
Prediction of earthquakes	74
ROCK FLOWAGE	76
FLOW CLEAVAGE	76
Manner in which the parallel arrangement of minerals is brought about	79
<i>Recrystallization</i>	79
<i>Granulation and rotation of original particles</i>	82
Cleavage in its relations to differential pressures	84
<i>Relations of cleavage to strain</i>	85
<i>Relations of cleavage to stress</i>	86
GNEISSIC STRUCTURE	87
IDIOMORPHIC OR PORPHYRITIC TEXTURES DEVELOPED BY ROCK FLOWAGE	90
ROCK FLOWAGE WITHOUT RETENTION OF CLEAVAGE	92
OBLITERATION OF TEXTURES BY ROCK FLOWAGE	93
IDENTIFICATION OF SCHISTS AND GNEISSES	97
Field relation as a means of identifying schists and gneisses	97
Mineral composition as a means of identifying schists and gneisses	98
Chemical composition as a means of identifying igneous or sedimentary origin of gneisses and schists	100
Conclusion as to methods of identifying gneisses and schists	102
STRUCTURES COMMON TO BOTH FRACTURE AND FLOW	104
FOLDS	104
Elements of folds	104
Folds in the zone of fracture and zone of flow contrasted	108

STRUCTURES COMMON TO BOTH FRACTURE AND FLOW—

Continued

PAGE

Control of structures in weak beds by differential movements between competent beds on limbs of folds	114
(1) <i>Minor folds as evidence of differential movement between beds</i>	114
(2) <i>Cleavage as evidence of differential movement in folding</i>	119
(3) <i>Jointing, fracture cleavage, and fissility as evidences of differential movement between beds in folding</i>	121
Localization of folds	124
Determination of depth affected by folds	124
Field observations on folds	127
<i>Strike and dip</i>	127
<i>Emphasis on relations of major and minor structures</i>	128
<i>Field observations on relations of cleavage to folds</i>	128
<i>Determination of top and bottom of sedimentary beds in a folded area</i>	132
Suggestions for laboratory study of folds	134
MOUNTAINS	136
TYPES OF MOUNTAINS	136
MOUNTAINS AND NORMAL FAULTS	137
MOUNTAINS AND THRUST FAULTS	137
MOUNTAINS AND FOLDS	137
MORE COMPLEX RELATIONS OF MOUNTAINS TO STRUCTURE	138
LOCALIZATION OF MOUNTAINS	138
SUGGESTIONS FOR LABORATORY STUDY OF MOUNTAINS	140
MAJOR UNITS OF STRUCTURE (GEANTICLINES, GEOSYNCLINES, OCEAN BASINS, CONTINENTS, PLATEAUS, POSITIVE AND NEGATIVE ELEMENTS)	141
SHAPES OF MAJOR ELEMENTS OF STRUCTURE	141
ACTUAL AND APPARENT UPLIFTS	143
ULTIMATE FORCES OF SECONDARY DEFORMATION	144
OUTLINE OF PRINCIPAL THEORIES	144
ISOSTASY	145
Support of hypothesis by recognition of weakness of rocks	145
Dutton's and Gilbert's observations on isostasy	146
Hayford's observations on isostasy	146
Earth movements in relation to isostasy	148
Isostasy in relation to rigidity of rocks	148
Depth of isostatic compensation	149
Criticism of theory of isostasy	149
CAUSES OF TENSION	152
CONCLUSION AS TO MAJOR CAUSES OF DEFORMATION	152
LOCAL AND MINOR CAUSES OF DEFORMATION	153
RELATION BETWEEN DEFORMATION AND VULCANISM	154

	PAGE
UNCONFORMITY	156
IDENTIFICATION OF UNCONFORMITY	157
INTERPRETATION OF UNCONFORMITY	159
SUGGESTIONS FOR LABORATORY STUDY OF UNCONFORMITY	161
INDEX	163

STRUCTURAL GEOLOGY

FRACTURE AND FLOW

KINDS OF FRACTURE AND FLOW STRUCTURES

Rocks are deformed by fracture and by flowage. Rock fractures are known geologically as joints, faults, brecciation, autoclastic structures, fracture cleavage, etc.

Rock flowage may be defined as a permanent change of form by pressure without conspicuous fracture. It does not include igneous fusion. It is accomplished by interior readjustments of rock substances by chemical, mineralogical, and mechanical changes, these changes being favored by high pressure and temperature, moisture, and by the presence of rock substance easily susceptible to these changes. The results of rock flowage are commonly a parallel arrangement of the constituents of the rock mass, producing a schistosity, cleavage, or banded structure. Where the rock is made up of minerals not adapted dimensionally to taking on a parallel arrangement, rock flowage may leave no evidence of itself in parallel arrangement. There are gradational structures between flow and fracture, for rock may be deformed mainly by minute fracture or slicing and still be a coherent mass. It has, in effect, flowed.

Folds are developed by both flowage and fracture.

DISTRIBUTION OF FRACTURE AND FLOW STRUCTURES

The prevailing manner of deformation at the earth's surface is by fracture, as is known by observation and experiment.

The prevailing manner of deformation deep below the surface may be inferred to be by flowage. Rock flowage has been actually observed in process, as, for instance, the flowage of schists in the Simplan and other deep tunnels and the creep of soft shales in

mines. For the most part, however, rock flowage takes place at depths beyond our range of observation, and our conclusions as to the existence, locus, and conditions of a zone of rock flowage rest principally on inference. We observe some rocks at the earth's surface with textures which have been developed by rock flowage. We see that flowage is not now taking place in them. We know that the rocks were once far below the surface and now appear at the surface because erosion has uncovered them. We conclude that they flowed when beneath the surface, under physical conditions other than those under which they now rest, and that therefore rocks are today flowing beneath the surface. We reverse the statement of the Huttonian principle that the present is the key to the past, and argue that the past is the key to the present.

Artificial rock flowage may be accomplished under conditions which seem to us probably analogous to those existing at depth. (See p. 4.)

The existence of a zone of rock flowage beneath the surface is inferred also from the behavior of earthquake waves. These are initiated by the shock of fracturing; and it is significant that their point of origin, as determined by many independent observers, has never been found to be far below the surface. This fact indicates that fractures go only to a comparatively shallow depth, and that below this rock deformation must be accomplished in some other way.

The wrinkling of the earth's surface into mountain ranges involves a slipping of the crust which renders plausible the existence of a zone of flow.

If the earth's surface is in a state of isostatic adjustment, the conclusion seems inevitable that this adjustment has been maintained by means of deep-seated flowage to compensate for transference of surface loads by erosion.

It is concluded, therefore, partly by direct observation but largely by inference, that somewhere beneath the earth's crust is a zone in which deformation is by flowage. It may seem superfluous to use so many words to argue that there is a zone of rock flowage yet if we think to ask ourselves how we know this, we are obliged to confess that inference has been an important factor in reaching this conclusion. Actual observation does not go below a zone of combined fracture and flow. Even the Keewatin

and Laurentian rocks, the oldest of the pre-Cambrian of North America, have only partly undergone rock flowage, and even in these rocks the flowage is in considerable part a direct result of plutonic intrusion rather than depth alone.

The existence of a zone of fracture and a zone of flow was inferred by Heim¹ from his studies of the Alps. Gilbert² also separated the two types of deformation on basis of depth, but did not use the term zone. Van Hise³ first proposed a classification of the lithosphere on a basis of vertical distribution of the dominant kinds of deformation, into an upper zone of fracture, a middle zone of combined fracture and flowage, and a lower zone of flowage. In view of the fact that flowage in certain soft rocks may begin almost at the surface, nearly all of the zone of the lithosphere within our range of observation is that of combined fracture and flowage. Also rocks which have been deformed by flowage below the surface in the past and are now exposed by erosion lie alongside of rocks now being fractured at the surface within our range of observation. The depth necessary for flowage differs for different rocks, and is dependent upon a variety of conditions. A general statement of the distribution of structures is that at the surface most rocks fracture and some flow; that far enough below the surface all rocks may flow. Van Hise emphasized the variation of depth of the zones of fracture and flow for different rocks and under different conditions; but the use of the word "zone" has caused undue stress to be placed on uniformity of depth by students who have used these terms. The emphasis should rather be on conditions. As expressed by a student in an examination, the zone of fracture or flowage "like Heaven, is a condition, not a place." If "zone" were understood to convey the notion of both condition and place, it would more clearly express the fact. A hard quartzite fractures, while a shale lying either above or below may flow. A quartzite may fracture at one place, while near at hand, without increase of depth but under different conditions, it may flow. In order that the terms "zone of fracture" and "zone of flow" may have definite significance, they should be related to specific rocks,

¹ Heim, Albert, *Untersuchungen über den Mechanismus der Gebirgsbildung*, Basel, 1878.

² Gilbert, G. K., *Geology of the Henry Mountains*: 2nd ed., Washington, 1880.

³ Van Hise, C. R., *Principles of North American Pre-Cambrian Geology*: 16th Ann. Rept. U. S. Geol. Survey, p. 589.

for instance, "the zone of fracture for quartzite," "the zone of flow for shale."

As rocks approach the earth's surface by erosion of overlying rocks or through volcanic agencies they become fractured and disintegrated. As they are buried beneath the surface they may come under conditions of rock flowage which weld and integrate them. Structural changes may thus be in cycles. As the depths of fracture and flow vary widely for different rocks and under different conditions, one rock may be in the destructive phase of its structural cycle while a nearby rock may be in a constructive phase. The terms "zone of fracture" or "zone of flow" may therefore be considered as applying to a given rock in a phase of its structural cycle. Depth is only one of the important factors determining the phase of the cycle.

CONDITIONS FAVORING FRACTURE OR FLOW

Most rocks fracture at the surface; some of them flow. It may be supposed that far enough below the surface all of them may flow. Practically, our zone of observation is that of combined fracture and flow. These kinds of deformation may occur side by side in different rocks or in the same rocks. The specific combination of factors which determines fracture rather than flow in the given location can seldom be more than approximately ascertained.

Rock flowage has been experimentally accomplished on a small scale. Kick¹ in 1892 put crystals in a copper box, filled the space with imbedding material such as paraffine wax and fusible metal, covered the box with brass plates, and put it under great pressure. The resistance to deformation offered by the copper as well as by the imbedding material is transmitted through the bedding material to the specimen, which thus receives a very considerable lateral support. In this manner Kick secured permanent deformation in salt, talc, gypsum, fluorspar, and marble.

Adams subsequently repeated these experiments on a more elaborate scale, using a variety of limestones and marbles, with similar results.² This method produces rock flowage. The essen-

¹ Kick, Prof. Friedrich, Die Prinzipien der mechanischen Technologie und die Festigkeitslehre: Zeit. des Ver. Deut. Ingen., Vol. 36, 1892, p. 919.

² Adams, F. D., An experimental investigation into the action of differential pressure on certain minerals and rocks, employing the process suggested by Professor Kick: Jour. of Geol., Vol. 18, No. 6, 1910, pp. 489-525.

tial condition was apparently the lateral support. The method, however, is qualitative, in that it is difficult to measure the pressure acting upon the specimen itself, as distinguished from that on the copper box and on the paraffine.

A more nearly quantitative method, and one allowing far greater pressures, has been used by Adams,¹ who fitted cylinders of marble, granite, and diabase into steel jackets and compressed them by a piston to such a degree that the sides of the steel casing were made to bulge (see Fig. 1). All of the stresses were above the crushing strength of the rocks, but they differed much in intensity. When the casing had been cut away the rock was found to have nearly as great strength as it had before deformation. Similar results have been observed in concrete cylinders incased in steel jackets which have been hardened for sixteen hours and then allowed to stand under great pressures. The result was deformation by "flow."²

Strength tests on building stone cubes afford good illustrations of rock fracture. The block is compressed in one direction, the sides being left free. The maximum pressure required for fracturing the strongest rocks is from 25,000 to 30,000 pounds per square inch.

In the most general terms, experimental results seem to show that when a rock is free to escape in some direction, it will break when under pressure greater than its crushing strength. When not free to escape except by exerting a pressure greater than its crushing strength, it flows if sufficient pressure is brought to bear upon it. Expressed more technically, the pressure acting upon any one unit of the rock mass may be resolved into three mutually perpendicular components, called the three principal axes of stress. Where one or two of these axes of stress are less than the crushing strength of the rock and the others are above it, the rock breaks, in directions determined by the relative intensities of the three principal stresses. Where all of the stresses are greater than the crushing strength of the rock, that is, when the rock mass is confined on all sides by pressures greater than its crushing strength,

¹ Adams, Frank D., and Nicolson, J. T., An experimental investigation into the flow of marble: *Phil. Trans. Roy. Soc. of London*, Vol. 195, 1901, pp. 363-401. See also, Adams, Frank D., and Coker, Ernest G., *The flow of marble: Amer. Jour. Sci.*, Vol. 29, 1910, pp. 465-487.

² *Engineering News*, Vol. 54, Nov. 2, 1905, p. 459.



a

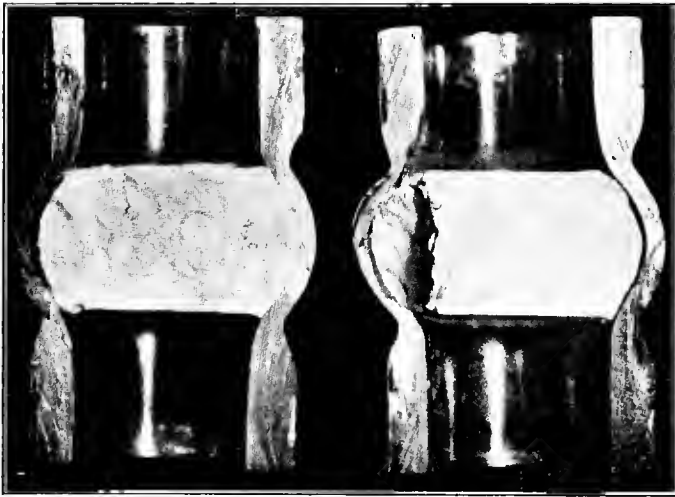

b

FIG. 1. Flowage of marble. After Adams. a. Columns of marble before and after deformation. b. Deformed column of marble as it appears in the steel jacket.

one or more of the stresses greatly preponderating over the others, the rock yields by rock flowage.

In rock flowage the stress-difference (i. e., difference in intensity of greatest and least of the principal stresses) necessary to deform

the rock may be much greater than the crushing strength of the rock. Experimental evidence points in this direction, although there are insufficient data to warrant satisfactory quantitative statements. Hallock¹ has shown that a substance like a dime or a brass tack, when imbedded in steel and then subjected to enormous pressure, acquires a rigidity which allows deformation only when the stress difference has become very large. The silver coin acquires so great a rigidity that it will impress itself in the steel before flowing. Adams² and Pfaff³ also found in their experiments that when rocks were under pressure enormously greater than their ordinary crushing strength, they would not flow through a small hole bored in the side of the steel jacket nor would small holes in the rock become closed; and it was concluded that a high degree of artificial rigidity had been induced in the rock, which could be overcome only by excessive stress difference. High rigidity would seem to be a probable condition deep in the earth, and hence enormous stress difference might be required to effect deformation.

While under certain conditions of compression the rock may flow, it may fracture under tension stresses of equal or greater magnitude. The breaking strength of rocks under tension is less than its resistance to fracture by compression or to flowage by compression.

A substance may be deformed by compressive stress at the same time that it is being pulled in another direction by a tensional stress (see. pp. 16 and 25). It is entirely conceivable, if the rock is soft, that under these conditions the response to compression may be rock flowage and the response to tension may be rock fracture, for it is known that under tension a rock breaks under much less stress than under compression, and under the higher compressional stresses there may be rock flowage.

The conditions of rock flowage in the earth may be quite different in some cases from those experimentally determined, due to factors of time, moisture, and character of the rock. Given long enough time, even the strongest substances may become deformed without

¹ Hallock, William, The flow of solids, or liquefaction by pressure: *Am. Jour. Sci.*, Vol. 34, 1887, p. 280.

² Adams, Frank D., An experimental contribution to the question of the depth of the zone of flow in the earth's crust: *Jour. Geol.*, Vol. 20, 1912, pp. 97-118.

³ Pfaff, F., *Der Mechanismus der Gebirgsbildung*, pp. 16-19.

fracture under stresses less than their crushing strength. For instance, marble gravestones sag when suspended at both ends for many years. Structural materials are known to do the same. In both cases the load is less than that necessary for crushing.

Deformation by flowage may be facilitated by high temperature and moisture content. Such factors favor rapid chemical changes and recrystallization, thereby enabling flow to take place more easily. It is a matter of observation that rocks have undergone rock flowage by means of recrystallization of the mineral particles, and that such recrystallization has seemed to be at a maximum in rocks which were once at a high temperature, as near intrusive igneous contacts, or had a high content of moisture, or both. High temperature and moisture have been found experimentally to aid recrystallization.

Another factor which helps to determine fracture or flow under given conditions is the character of the rock itself—its weakness, and its susceptibility of recrystallization, the latter in turn depending on mineral content, texture, degree of hydration, and other conditions. Thus it is that under the same pressures one rock may fracture and the other flow. In general, muds, shales, slates, and limestones flow much more readily than the harder types such as quartzite and igneous rocks.

The scope of this paper does not call for any attempt to explain the physical and chemical basis of recrystallization, beyond calling attention, as has been done, to the general factors which seem to be effective according to field and experimental observation. Much remains to be done to get these factors on a quantitative basis. It is entirely likely that as progress is made in this regard there will be a considerable change in the emphasis on the several factors cited. For instance, the presence of moisture seems to favor recrystallization, judging from field conditions. Of two rocks of different moisture content, the one containing the more water seems to recrystallize more readily, yet in experiments in the artificial recrystallization of minerals in the Carnegie Institution of Washington it has been found that recrystallization occurs with unexpected readiness under conditions of dry heat. Artificial rock powders when heated dry have been found to recrystallize, giving particles large enough for microscopic study.

DEPTH NECESSARY FOR ROCK FLOW

A shale may be deformed by flowage near the surface, while a brittle quartzite may require great depth. A rock at a given depth may fracture in one locality, while in another locality, because of vulcanism, or high pressure and temperature developed by mechanical thrust, or because of its relations to adjacent strata, may be deformed by flowage. Therefore no one figure may be taken as the depth of the zone of rock fracture. It is apparent that the depth beneath the surface necessary to produce rock flowage is only one of a number of variable factors determining the manner of deformation of a rock. Among these are the following: whether stresses are tensional or compressional, variation of minor compressive stresses and thus of induced rigidity, variation in strength of the materials, variation in chemical and mineralogical composition, variation in moisture-content and temperature, duration of time, and possibly other unknown variables. Notwithstanding our lack of quantitative measurements of some of these factors, it is still possible to arrive at some approximation for the minimum depth at which all rocks will flow even when not favored by factors other than depth.

An early attempt to use quantitative methods in determining this depth was made by Van Hise and Hoskins.¹ Their calculation of the depth of covering which would give a pressure sufficient to close a cavity gave a range of from three to seven miles. In making this calculation they made assumptions favorable to the greatest depth—for instance, that the rock was of the strongest known kind, that conditions of temperature and moisture were the least favorable to recrystallization, that lateral stress was absent, that the pressure is lessened by the buoying effect of underground water. One of their assumptions, however, tends to make the calculated depth too small, namely, that the stress difference necessary to close a cavity is just equal to the crushing strength of the rock. Experiments of Adams, Pfaff, and Hallock, cited above, have shown that the rock acquires a high degree of rigidity when compressed on all sides, and that enormously greater stress difference is necessary to cause deformation of any kind. How much greater the pressure would need to be is yet uncertain.

¹ *Op. cit.*, pp. 589-593.

Adams¹ has shown experimentally that a cavity will not close 11 miles below the surface at a temperature of 550° C. even if a pressure is used that is 50% greater than that obtaining at this depth. For granite, in fact, he finds that cavities remain open at ordinary temperatures even with pressures corresponding to depth of 30 miles. These experiments may lead to overestimate of depth for flowage in general, for the reason that the cavities used were very minute, the factor of moisture was not included, and the time element was only partially accounted for by increasing the pressure. Also with larger openings than used in the experiments, presumably less stress difference would be required to close cavities. Under the conditions of the experiment cubical compression played an important part.

A factor not considered in the above estimates is the fact that under tension of whatever magnitude the rock will fracture rather than flow. So far down in the earth as tension exists, therefore, rock fracture may extend.

The possibility is suggested on page 7 that a rock may yield to compression by flowage—at the same time it is yielding to tension by fracture. If this is possible, the fractures are really minor and subsidiary to the flowage and therefore require only a minor modification of our discussion of the depth at which a rock will flow.

Estimates of the depth of the zone of rock fracture have also been made by studying the amount of erosion necessary to uncover evidences of rock flowage. This method, by its very nature, must yield indefinite results; and yet, as applied in different parts of the world by different observers, it indicates that the depths below the surface necessary for rock flowage for strong rocks are possibly a little larger than those derived from the computations of Van Hise and Hoskins.

Another line of evidence on the same point is afforded by a study of earthquake shocks. Earthquakes originate in the fracturing of rocks, and in no case has their point of origin been estimated to be more than nine or ten miles below the surface. Also it has been found that waves traveling along a chord which passes ten or twelve miles below the surface at the deepest point are

¹ Adams, Frank D., An experimental contribution to the question of the depth of the zone of flow in the earth's crust: *Jour. Geol.*, Vol. 20, 1912, p. 115.

sharply discriminated in speed and in position of their planes of vibration from waves traveling along the circumference. Waves traveling along chords at shallower depths are not thus easily differentiated. Some difference in medium at great and small depths is assuredly indicated.

Suggestive, but not to be cited as definite evidence, is the fact that the mountains of the earth's crust never rise much above five miles in height. There are many factors which control summit levels. One of them has been suggested to be the yielding of the rocks at the base by flowage when the mountains had reached a height of over five or six miles. Prevalence of flowage structures in the cores of mountains are in accord with this view, though many of them may be otherwise explained.

From various sources, therefore, there is evidence or suggestion that the zone of rock fracture is comparatively shallow, perhaps less than twelve miles deep for the strongest rocks. No one line of evidence cited is decisive. Yet there is such accordance of the various kinds of evidence that the figures above given may be tentatively accepted. The figures may be increased when more is known of the ratio of rigidity to increase of depth.

VOLUME CHANGES IN FRACTURE AND FLOW

Fracturing itself involves increase of volume of the fractured mass, because of displacement of the parts. In the zone of fracture rocks also are accessible to weathering agencies of the atmosphere and hydrosphere and undergo metamorphic changes which increase their volume. Calculations of the changes of volume of the common rocks of the earth's crust indicate a maximum increase in volume at the surface of 50% by development of pore space and of minerals of low density. In the zone of flow there is a tendency to diminish volume by closing pore space and by developing minerals of higher density.

If the three principal stresses are equivalent, the rock may be cubically compressed, but experimentally no permanent compression has been accomplished, the rock expanding as soon as pressure is released. The experiments of Adams¹ show that acid rocks are

¹ Adams, Frank D., and Coker, Ernest G., An investigation into the elastic constants of rocks, more especially with reference to cubic compressibility: Pub. No. 46, Carnegie Inst. of Wash., 1906, pp. 66-68.

more elastic than glass, basic rocks less so, marbles and limestones about the same. Of the minerals, quartz is highly elastic, and therefore he concludes that the high elasticity of granite is probably due to this cause.

SURFACE EXPRESSION OF THE ZONES OF FRACTURE AND FLOW

Erosion takes advantage of fracture planes in etching the earth's surface. Where rocks are homogeneous and the fracture planes are in well-defined systems, drainage lines may be in more or less regular patterns, especially in non-glaciated regions. Where fractures are curved and discontinuous and not in regular systems, this may be represented in the irregularity of the erosion channels. It must be remembered that fractures are not the only structures which localize erosion channels. Differing resistance of rocks, bedding, dip of impervious layers, etc., have their influence. Hence it should not be assumed that all drainage patterns correspond to fracture systems, and it is especially unsafe to read into the actual pattern a more regular pattern based on a hypothetical conception of fracture systems.

Dislocations of the earth's crust may, independently of erosion, cause topographic irregularities, some of which are referred to in a later section on faults (pp. 57-58).

Rocks which have undergone rock flowage are for the most part easily eroded, and are consequently likely to be relatively low areas. Schistosity obliterates expression of original structures. The schistose structure resulting from rock flowage may give linear elements to the topography, but these elements are likely to be curving, overlapping, discontinuous, and not in the more or less regular intersecting sets characteristic of rock fracture.

By the time erosion has exposed at the surface rocks which have undergone rock flowage, these have come through the zone of rock fracture, with the result that fractures may be superposed upon schistosity, in which cases the surface expression may combine features characteristic of rock flow and fracture.

Other things being equal, evidence of flowage is likely to be more conspicuous in areas from which there has been a large amount of material eroded than elsewhere. The rocks showing at

the surface in such areas have been buried to great depths below the surface. Older rocks are likely to have been more deeply buried below the surface than younger rocks, and therefore to have been at one time in the zone of rock flowage, but this does not always follow.

It is frequently possible to determine from the study of geologic and topographic maps, whether the rocks of an area are characteristic of the zone of rock flowage or rock fracture. Note for instance the contrast between Archean and Algonkian areas in most parts of the Lake Superior region, and between the pre-Cambrian and Paleozoic areas in the Piedmont and southern Appalachians. The student may study to advantage the evidences of fracture and flow on the following maps with their accompanying sections:

Roan Mountain folio, Tennessee-North Carolina, No. 151, U. S. G. S.

Pisgah folio, North Carolina-South Carolina, No. 147, U. S. G. S.

Gadsden folio, Alabama, No. 35, U. S. G. S.

Geology of the Lake Superior Region, Mon. 52, U. S. G. S., particularly maps of the Marquette and Gogebic districts.

Note the areal distribution and relations of rocks, presence of linear elements, evidences of thickening or thinning by flowage, schistosity, drainage, depth to which rocks have been covered, etc. More specific expressions of the zones of fracture and flow at the rock surface are discussed on later pages.

FRACTURES

Rock fractures are usually designated by terms such as joints, faults, fracture cleavage, autoclastic structures, etc. The variety of names and classifications of rock fractures should not obscure the fact that after all they are only expressions of the ordinary mechanical principles of the breaking of solid materials. We may for the time avoid some complexity of names, therefore, by outlining first some of the simpler mechanical features of the fracturing of rocks, applicable to all rock fractures regardless of names. To do this adequately would require the use of many of the technical terms of mechanics, which, for the purpose of this volume, would be undesirable. In the following account of the principles of fracturing the attempt is made to use non-technical language, even though this may seem to the technical reader to be at the expense of accuracy and conciseness. Some technical terms are unavoidable.

ATTITUDES OF FRACTURES WITH REFERENCE TO STRESSES

Stress is defined as the reaction of the interior parts of a solid against forces tending to deform it, and strain is the change in shape of the solid resulting from these reactions. All stresses acting at any point may be resolved into three mutually perpendicular components or principal axes of stress. There are correspondingly principal axes of strain.

Fractures form in the following relations to stress:

TENSION FRACTURES

Under tension, fractures tend to develop in planes normal to the maximum stress. There are also shearing stresses inclined to the maximum tension, just as there are in compression (see p. 16), but only rarely does the breaking of the rock mass follow these

planes of shearing stress, because the resistance of the rock to tension is less than its resistance to shearing.

Tension fractures may develop also when a mass is deformed by shearing in the manner described on page 16.

By torsion, intersecting sets of fractures have been simultaneously produced at angles of 45° to the axis of torsion. These

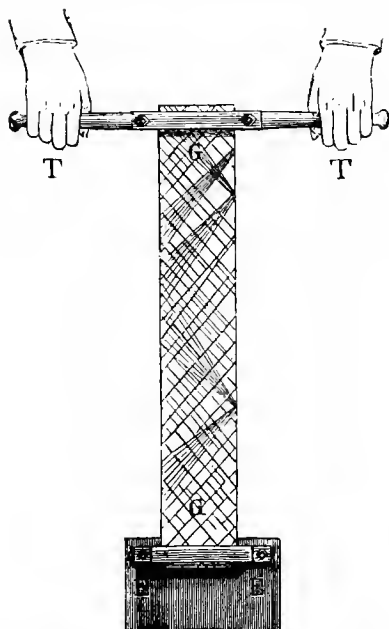

FIG. 2. Diagram to illustrate the development of rectangular sets of tension fractures under torsion. After Daubree.

fractures are probably due to tension rather than compression. If a circle be drawn on the flat side of a rubber eraser and the eraser twisted it will be noted that the elongation of this circle, indicating tension, is normal to the planes followed by fracture in torsion tests¹ (Fig. 2).

¹ Becker, G. F., The torsional theory of joints: Trans. Am. Inst. M. E., Vol. 24, 1895, p. 136.

COMPRESSION FRACTURES

Under compressive stresses, fractures tend to develop along planes of "maximum shear," which are inclined to the direction of principal stresses; but the degree of inclination and the direction of dip of the planes away from the direction of maximum stress vary between the following limiting cases:

A building stone cube, subjected to pressure on one pair of opposite sides, shears in planes 45° or less from the line of maximum pressure. These planes may dip in one direction away from this line or may dip outward in all directions, developing a cone. If the cube be subjected to pressure as before, while it is being rigidly supported on another pair of opposite sides, the remaining surface being free, fractures will develop dipping toward the free sides. Portions of the rock mass will thus be displaced in the direction of these free sides. This presumably is a common case in nature, as, for instance, where a horizontal stress affecting a homogeneous rock mass is relieved principally by displacement upward. The planes of fracture dip from the surface toward the greatest compression and displacement along these planes will carry the rock mass upward, in the manner of a thrust fault.

The compressive strains thus far described are known as *non-rotational*;¹ that is, the principal directions of stress remain constant with reference to the principal axes of strain throughout the deformation. Fully as common in nature are *rotational strains* or *shears*, in which the strain axes are being constantly rotated during the deformation, illustrated by Fig. 7. The fractures are then not symmetrically grouped with reference to the principal stress but they retain much the same relations to the elongation and shortening of the deformed mass, as in the case of non-rotational strain above described. The principal stress usually intersects the obtuse angle between such fractures.

One of the incidental accompaniments of fracture by shearing under a rotational compressional stress may be development of tension fractures in planes normal to the elongation of the mass.

A convenient way to remember and picture the system of fractures developed under the above stress-strain relations is by

¹ Hoskins, L. M., Flow and fracture of rocks as related to structure: 16th Ann. Rept. U. S. Geol. Survey, pt. 1, 1896, p. 845 et seq.

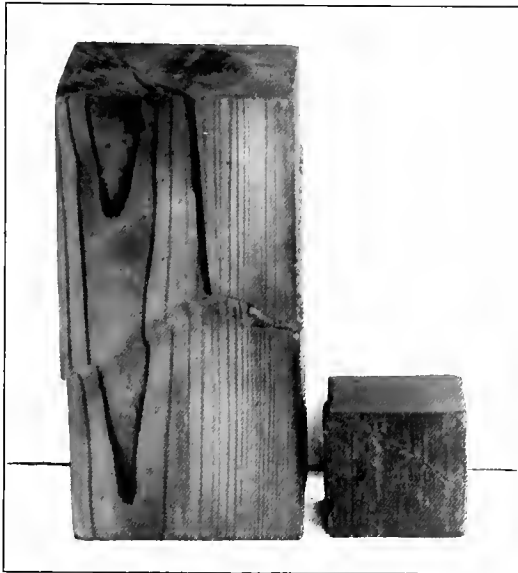

FIG. 3. Results of crushing wooden blocks by non-rotational strain. Note tendency of fractures to follow shearing planes 45° to the pressure (which was from above) regardless of the grain of the wood.



FIG. 4. Fracture of building stone (brown sandstone) along shearing planes. After Buckley.

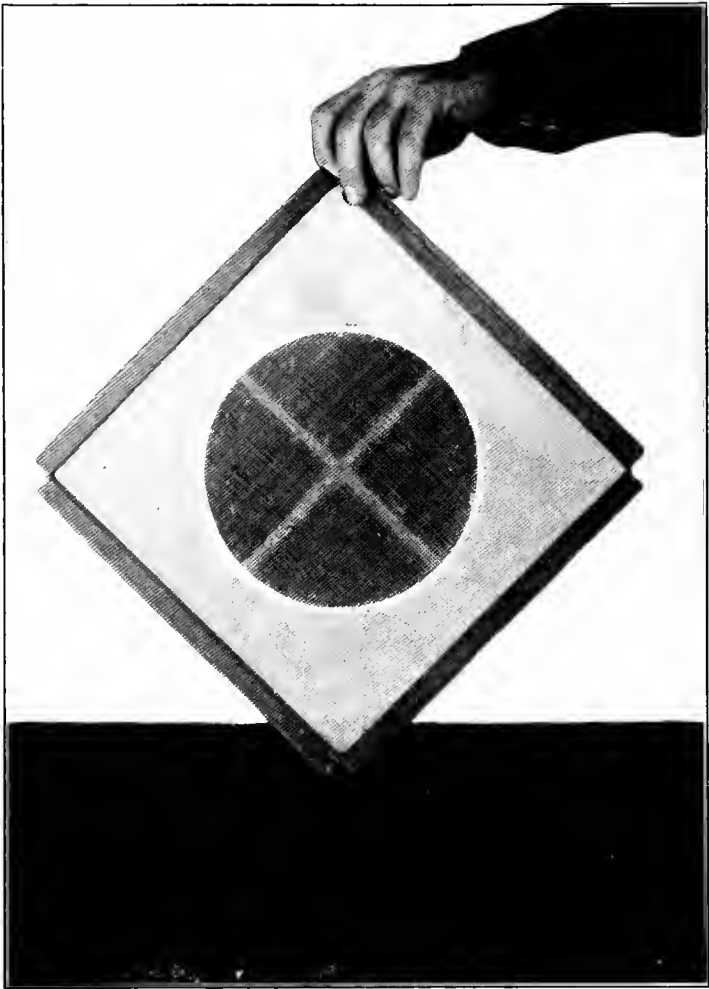

FIG. 5. Wire netting model undeformed. See also Figs. 6 and 7.

the use of the sphere as the unit of original structure and the strain ellipsoid as its deformed equivalent. Fractures under compression tend to follow the cross sections in the strain ellipsoid which are the same in dimensions as those of the original sphere; in other words, planes (called *planes of no distortion*) determined by the intersections of the original sphere with the strain ellipsoid.

A simple device for illustrating the position of strain ellipsoid and shearing planes in both rotational and non-rotational strain is shown in Figs. 5, 6, and 7. A cardboard upon which is inscribed a circle is laid between two sheets of wire netting. The three are then fastened together by a rivet in the center of the circle. A wooden hinged frame fastened to the netting allows and controls the distortion of the netting, while the interior sheet remains undis-

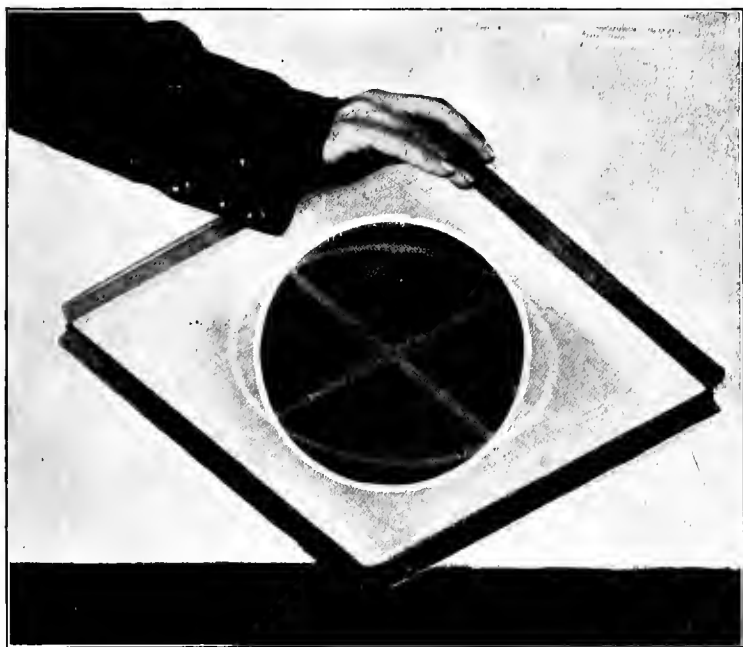

FIG. 6. Wire netting model deformed by non-rotational strain. Straight lines connecting intersections of circle and ellipse mark positions of "planes of no distortion" or planes of maximum shear.

torted. A circle and diameters are painted on the netting corresponding with those on the central sheet. When the screen is distorted the circle on the wire becomes an ellipse or a cross section through the greatest and least principal axes of a "strain ellipsoid," which is superposed upon the undeformed circle of the cardboard.

In Fig. 6 a non-rotational strain is represented, called "pure shortening and elongation." The circle elongates normal to the

maximum shear, stand normal to the surface of the screen. Their intersections with the plane of the screen are to be seen at about 45° to the pressure. It will be noted that the lines representing the planes of shear are parallel to the wires. The distortion of the screen actually occurs by shearing of the wire mesh. This should

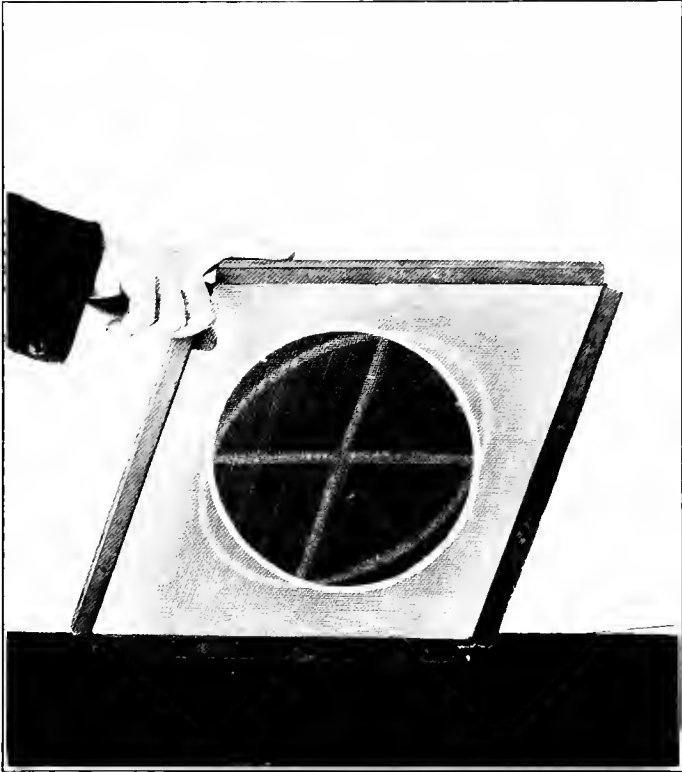

FIG. 7. Wire netting model deformed by rotational strain, or shear. Straight lines connecting intersections of circle and ellipse mark positions of "planes of no distortion" or planes of maximum shear.

make clear the fact that the painted lines of "no distortion" are actually shearing planes.

In Fig. 7 the strain is a rotational one. A strain ellipse is produced by shearing of the top over the bottom of the model, obviously by movement along the shearing planes of the wire mesh.

The planes of no distortion are indicated as before. It will be noted that they have the same relations to the ellipse as before, though the pressure has been applied at a different angle. It is evident that the net result is the same as in a non-rotational strain, so far as the shape of the strain ellipse is concerned. The rotation of the one figure in space would make it coincide with the other.

It cannot be too strongly emphasized that in nature what we usually see is the net result, which we may interpret in terms of strain ellipsoid. This strain ellipsoid may have been developed either by rotational or non-rotational strain, and we must be careful not to assign the strain ellipsoid to either kind of strain on insufficient evidence. There are cases where it is possible to make such definite assignment.

Rock fracture tends to occur under any one of the stress-strain relations, or some combination of them, described above under the headings Tension Fractures and Compression Fractures. Initial planes of weakness may modify these relations. In homogeneous masses these are the limiting cases which cover all rock fractures. In the field study of fracture it is sometimes possible to determine what the stress-strain relations have been; commonly it is not. It seems to the writer, therefore, that great care should be taken in choosing a general nomenclature for fractures which would not imply a knowledge of stress-strain relations we do not possess.

JOINTS

It is sometimes convenient to classify joints as strike joints or dip joints, to indicate concisely their parallelism in direction with the strike or dip of beds. Joints are ordinarily classified as tension and compression joints to express their relations to stresses. In nine cases out of ten the student sees nothing in the joint itself which tells him whether the joint results from tension or compression, and the attempt to use this classification may lead to unwarranted conjecture, or may throw him into the discouraged state of mind of a person who believes that he should be able to tell something which the facts do not readily indicate. It is pertinent to inquire as to what conditions tell definitely whether any particular system of joints is due to tensional or compressive stress.

JOINTS WHICH CAN BE CLASSIFIED AS DUE TO TENSION

(a) Faulting may imply extension of surface (see pp. 55-56), and hence the association of joints with such faulting would suggest their development by tensional stresses.

(b) Open joints indicate tension, but it is difficult to determine whether tension existed at the time the joints were formed or was subsequent to their genesis.

(c) Tension joints have been found along the crests of anticlines, developed as indicated in the diagram (Figs. 8 and 53). These, however, are usually on a small scale. The writer knows of

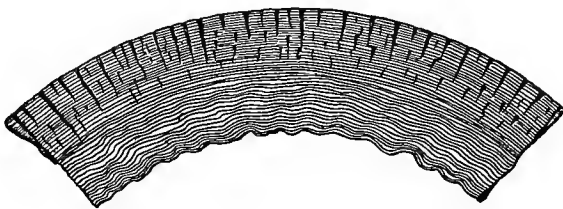

FIG. 8. Tension joints on anticline. After Van Hise.

no cases described for the United States in which any regional set of joints has been positively related to tensional stresses developed along major anticlines, but the existence of such cases is reasonably inferred where joints are parallel to the axial planes of folds.

(d) During the process of cooling in igneous rocks, tensional stresses are set up in them; and these stresses result in the formation of joints, not only in the igneous masses themselves, but in the adjacent rocks. The remarkably complicated fractures of Tonopah and other mineral-bearing districts of the Great Basin first suggested this origin, and it seems to be now an established fact that much of the complex fracturing of igneous rocks may be related definitely to their cooling. (See page 43.) Such joints may not be persistent or in regular systems. Locally the fractures take certain curved or concentric forms about loci of cooling, as for instance, in the gabbro of the Cobalt district of Ontario, or in the slates with which the gabbro has come into contact. These slates have been heated and caused to expand under the influence of the intrusive and have subsequently cracked on loss of heat. Basaltic parting is only a special type of tension jointing developed by

cooling. Radial and peripheral fractures seem in some cases to have been developed by the cooling of laccoliths and batholiths. Laccoliths have sometimes been supposed to pull away from the walls in the manner of a cooling melt from a mold, as for instance, in the Iron Springs district of Utah.

(e) Another type of local tension jointing is developed by the drying out of a sediment, resulting in the formation of mud cracks; or the desiccation of sediments on a large scale. The joints so formed lack regularity and persistence. It is possible that many of the fairly extensive joints in flat-lying sedimentary beds like the Paleozoic of the Mississippi valley may be due to the drying and settling of the formation.

(f) In some cases where dominant joints can be identified as the result of shearing stresses, as for instance, in a shaly layer sheared between two hard quartzite beds, small tension gash joints have been an incidental development. (See pp. 16 and 25).

JOINTS WHICH CAN BE CLASSIFIED AS DUE TO COMPRESSION

(a) Compressive joints may be sometimes identified by evidences of slipping, such as slickensides, developed along the jointing planes; but these evidences do not necessarily indicate that the compressive stresses were applied at the time the joints were formed.

(b) Where these joints pass into overthrust faults or folds, as, for instance, in the southern Appalachians, they are likely to be compression joints.

(c) Compressive joints may also be identified frequently on the limbs of folds by the manner in which they follow closely the theoretical directions required for compressive shear by the stress conditions occurring at those places (see pp. 20-21). For instance in the Baraboo quartzite in Wisconsin (see Figs. 9 and 11), there are joints parallel to the bedding, along which there has been a slight amount of slipping; there is another set inclined to the bedding; this latter set is continuous in direction only through homogeneous beds and passes to other beds by an offset or a curve along the bedding planes. In the softer beds the joints are so closely spaced as to yield a "fracture cleavage" (see p. 63). The joints have positions accordant with the supposition that they have been

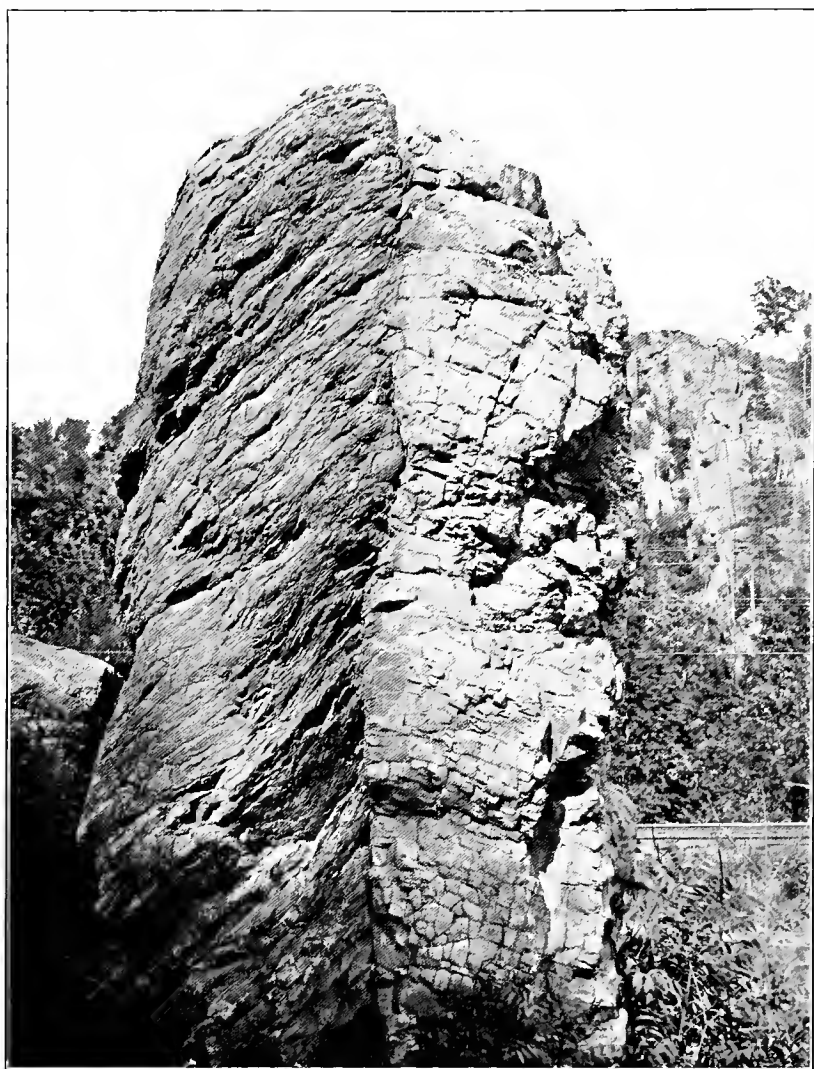

FIG. 9. Fracture cleavage and jointing developed by shearing between beds in Baraboo quartzite. After Atwood. The light portion on the right is a bed of brittle quartzite. The dark portion on the left is a bed of softer shaly quartzite. The outcrop is a part of the north limb of a syncline. The right hand bed is on the south. It has obviously moved upward with reference to the beds to the north of it, as would be expected from this position on the syncline. The fractures here have been developed by rotational or shearing stresses described on pp. 16, 20. It is suggested that the student superpose on these beds the theoretical positions of the strain ellipsoids and the planes of maximum shear. Note relations of fracture cleavage to jointing in adjacent bed. (See also page 121).

formed by compressional shearing, caused by slipping between the beds. Short open gashes or joints are also developed here by tension, as indicated in the figure.

(d) The sheet structure so commonly observed and utilized in granite and other quarries is a system of jointing probably at least in part developed under compressive stresses. (Figs. 12, 13 and 14.)



FIG. 10. Fracture cleavage developed in slaty quartzite layer between two massive beds of quartzite, on south limb of the Baraboo syncline, Wisconsin. Note the direction of differential movement and correlate this with position on the fold. What are the relations of the cleavage to pressure? Note relations of fracture cleavage to joints in the adjacent massive layers. (See also Fig. 37 and page 121).

The sheets are thinnest near the surface and rapidly thicken below. They may be curved, and in general are parallel with the rock surface. Usually they are found to be lens-shaped when traced some distance. Many instances have been noted of a lengthening of blocks when quarried out, sometimes with explosive violence, indicating that in the ledge they were under compressive stress.

Compression is indicated also by the occasional flattening, by faulting, of drill holes and other openings.¹ The sheet structure is developed artificially by the use of explosives, by hot air, and by heating the surface. These compressive stresses have been referred to various causes—solar heat, weathering (or kaolinization), expansion of the surface due to removal of overlying load by erosion, and to major earth movements.²

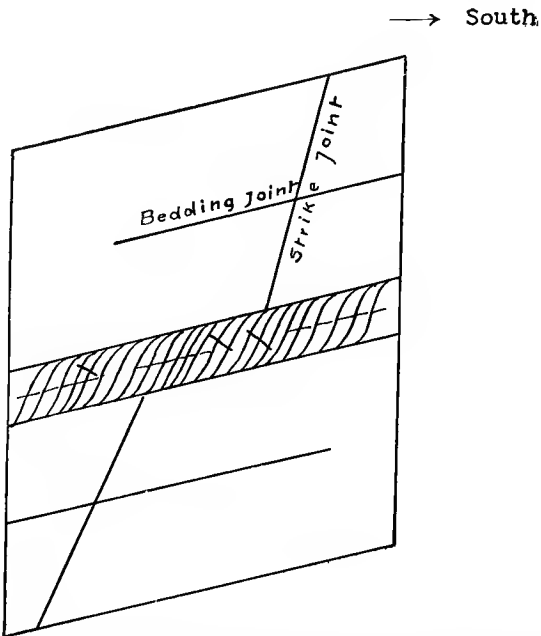

FIG. 11. Vertical section Baraboo quartzite, normal to the strike, on the South Range, Baraboo district, Wisconsin, showing joints formed by the folding of weak, thin beds interstratified with thick, strong beds. After Steidtmann. Short open gashes or tension joints may be seen crossing the curved compression joints in the softer layers.

Whatever the cause, the upper layers tend to extend themselves farther than the lower layers by shearing, producing the sheeting planes between them. The same structure has been referred also to tension due to cooling of the igneous rocks while still under sedimentary load, the sheets being approximately parallel to the

¹ Dale, T. Nelson, *The granites of Vermont*: Bull. 404 U. S. G. S., 1909, pp. 17-18.

² *Idem*; also Bulls. 354 and 484, U. S. Geol. Survey.

original contact surface of the intrusive. Bearing in mind the parallelism of the sheets to the present erosion surface, and their diminution in number below the surface, the explanation of tension by cooling involves the assumption that the present erosion sur-



FIG. 12. Sheet structure in granite. After Dale.

face is nearly the same as the original contact surface, which certainly is not always true.

The sheets are crossed by vertical joints which partly result from tension due to gravity acting on the thin sheets. Some of them also may be compressive. By application of the principles of breaking under rotational or shearing strain given above, it will appear that a complementary set of compression fractures should be

expected approximately at right angles to the sheeting planes. In quarries these vertical joints may be in one or more intersecting sets. They are characteristically intermittent, extending through a given set of sheets and offsetting in the sheets above and below. Not infrequently they are curved.

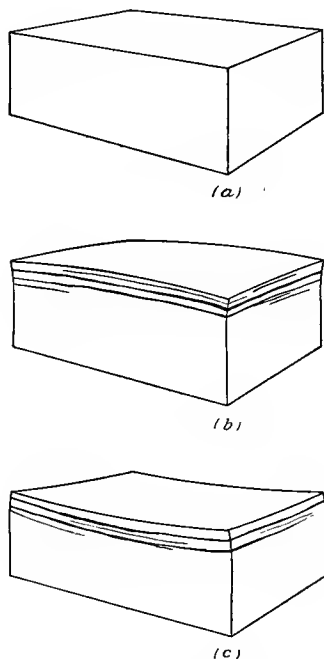

FIG. 13. Spalling of surface by shearing due to heating or cooling. After Van Hise (a) shows the condition of a block of uniform temperature. (b) illustrates the manner in which the upper portion of a rock surface expands when heated above average temperature; where the difference in temperature is sufficiently great, this results in the splitting off of the upper layers. (c) illustrates the contraction of the upper surface by cooling below the average temperature; where the difference in temperature is sufficiently great, this results in the splitting off of the upper layers.

JOINTS DEVELOPED UNDER UNKNOWN STRESS-STRAIN CONDITIONS

Probably the great majority of joints has not yet been satisfactorily determined as belonging to the tension or compression class. Many instances might be cited of attempted classification without

sufficient proof. Especially numerous have been the attempts to classify joints as compressive when they are in vertical intersecting sets, on the assumption that the intersection of the joints is an indication of compression stresses. On the other hand, identically similar sets of joints have been referred to tension acting in mutual perpendicular directions, or to torsion in the manner indicated by Daubree's experiment. (See p. 15.)

WIDENING OF JOINTS BY THE LINEAR FORCE OF GROWING CRYSTALS

It has long been known that crystals exert very considerable force in growing. Crystals of pyrite, for instance, drive apart the laminae of slates. Experiments on the pressure exerted by growing crystals of alum and other salts have shown that they exert a pressure of the same order of magnitude as the ascertained resistance which the crystals offer to crushing stresses.¹ It is supposed that this force exerted by crystals may be a factor in widening mineral-filled fissures, like the gold-bearing quartz veins of the Mother Lode of California, some of which have a width of several hundred feet. This width is not observed in unfilled fissures. In fact, the unfilled fissures are in general very narrow as compared with the fissures which have been filled and cemented. According to Becker,² laminae of the slates on two sides of Mother Lode veins have locally been driven apart and contorted. He concludes that when such occurrences cannot be accounted for by faulting the inference is almost unavoidable that the laminae have been driven apart by the force of growing crystals of quartz, the axes of which stand sensibly at right angles to the planes of the laminae. The ribbon ore, consisting of parallel laminae of slate, separated by quartz, has been regarded as due to faulting, but evidence of faulting is often lacking and it is difficult to conceive how faulting could separate these slate bands so evenly. Separation by the growing force of quartz crystals is an alternative explanation.

If quartz during crystallization exerts a pressure on the sides of the vein which is of the same order of magnitude as the resist-

¹ Becker, G. F., and Day, Arthur L., The linear force of growing crystals: Proc. Wash. Acad. Sci., Vol. 7, 1905, pp. 283-288.

² Op. cit., p. 284.

ance which it offers to crushing, as Becker¹ thinks probable, then this force is also of the same order of magnitude as the resistance of wall rocks, and thus it becomes possible that the widening of the filled fissures may be largely due to this cause.

SURFACE EXPRESSION OF JOINTS

What has already been written about the surface expression of the zone of fracture applies specifically to joints. One need only cite the Grand Canyon, Yosemite Valley, or the Dells of the Wis-

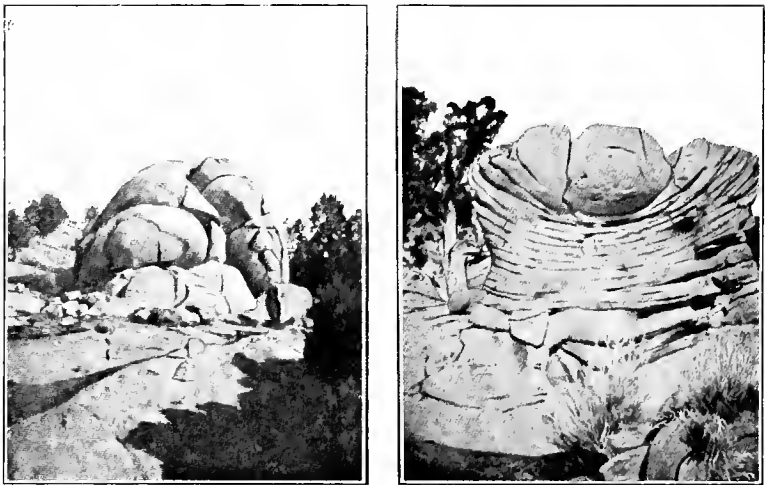

FIG. 14. Spalling of andesite outcrops, presumably due to alternate heating and cooling in weathering.

consin river, where the drainage has been controlled almost entirely by joints. In other areas, especially in drift-covered areas, the relation may be a very slight one. In some cases the assumption of relationship has been carried so far that drainage lines have been taken as evidence of joints without further information, and continuity and regularity of joint systems have been assumed on a basis of too little information. Attention has been called above to joints of wide distribution which characteristically lack regularity.

¹ *Op. cit.*, p. 287.

SUGGESTIONS FOR LABORATORY WORK ON JOINTS

(See also pp. 60-61)

On the experimental side the suggestions made in connection with faults on pages 60-61 apply equally well to joints. Much can be done with maps of joints. In this connection it is to be remembered that it is the interpretation of joints that is wanted and not a mere description of joints.

It is suggested that the student study the joints of the areas named below and make the attempt to classify them as tensional or compressional; and if compressional to discriminate between rotational and non-rotational strains. He should not go farther in inferences than the facts warrant. If he becomes satisfied of the origin of certain joints he should not assume that all joints in this area have the same origin. Inferences from the facts should be drawn regardless of what is said about the joints in the accompanying reports.

"Joint system in the rocks of southwestern Wisconsin and its relation to the drainage network" by Edmund Cecil Harder, *Bulletin of University of Wisconsin, Science Series, Vol. 3, No. 5*. The joints here described are fairly typical of the joints of the flat-lying Paleozoic beds of the Mississippi valley. Careful reasoning from the facts will eliminate certain hypotheses of the origin of these joints and point with a reasonable certainty to the true origin. Somewhat similar conditions in the Grand Canyon and Yosemite Valley should be studied; also the Watrous, New Mexico, topographic map. The relation between topography and jointing, due to interaction of climate, rock structure, and lithology, is to be noted.

"The secondary structures of the eastern part of the Baraboo quartzite range, Wisconsin" by Edward Steidtmann, *Journal of Geology, Vol. XVIII, No. 3, 1910*. The problems of jointing in folded rocks are here illustrated and discriminated with unusual clearness.

"Granites of Maine, Massachusetts, New Hampshire, Rhode Island, and Vermont" by T. Nelson Dale, *Bulletins 313, 354, 404, U. S. G. S.* The jointing of igneous rocks is here admirably illustrated and discussed. Before reading Dale's discussion of origin, the facts of jointing which he describes should be carefully considered and an attempt made to formulate a reasonable hypothesis of origin to fit these facts. Then compare with Dale's conclusion.

FAULTS

Faults are fractures along which there has been some relative displacement of the rocks. They differ from joints mainly in the extent of the displacement and in the emphasis on the displacement parallel to the plane of fracture rather than normal to it. All fractures are accompanied by some displacement—in fact, frac-

tures would not occur were not some displacement required by the stresses.

NOMENCLATURE

The elements of a fault are: *hade*, or the angle made by the fault plane with the vertical; *dip*, or the angle made by the fault plane with the horizontal; *throw*, or the displacement of the beds measured parallel to the dip of the fault plane; and the *heave* or *shift*, or the displacement of the masses measured parallel to the strike of the fault plane. When a fault plane dips toward the downthrow side, the fault is called a *normal* or *gravity* fault (Fig. 17). The displacement of the crust by such faults is apparently downward and therefore apparently due to gravitational forces. Where the fault plane dips toward the upthrow side of the fault, the fault is called a *reverse* or *thrust* fault (Fig. 18). The displacement of the crust is then apparently of the nature of tangential shortening. Normal faults may result in the dropping of blocks called *graben*. These usually have polygonal outlines. Blocks standing up between graben are called *horsts* or *bridges*. A fault with vertical displacement is expressed at the surface as a small cliff or scarp to which the name "fault scarp" has been given. "Fault trace," "furrow," and "rift" are terms given to the line of intersection of the fault plane with the surface. They are especially used where the fault displacement is horizontal and there is no fault scarp, or where the fault scarp has been worn down by erosion.

It will be noted that the classification of faults into normal or gravity and reverse or thrust faults, takes account only of apparent relative displacement in a vertical section normal to the fault plane. It takes no account of horizontal or oblique displacement. It expresses merely the present relations of the beds in a two dimensional cross section rather than in three dimensions. It tells us nothing of the actual displacements of the beds. *Hinge* or *pivotal* faulting about an axis normal to the plane of faulting may produce a fault which on one side of the pivotal axis would be called normal and on the other side reverse, and yet there may not be any differential movements in the centers of the mass of the two parts of the faulted body (Fig. 23). A purely horizontal displacement may appear either as a normal or reverse fault at any one place, de-

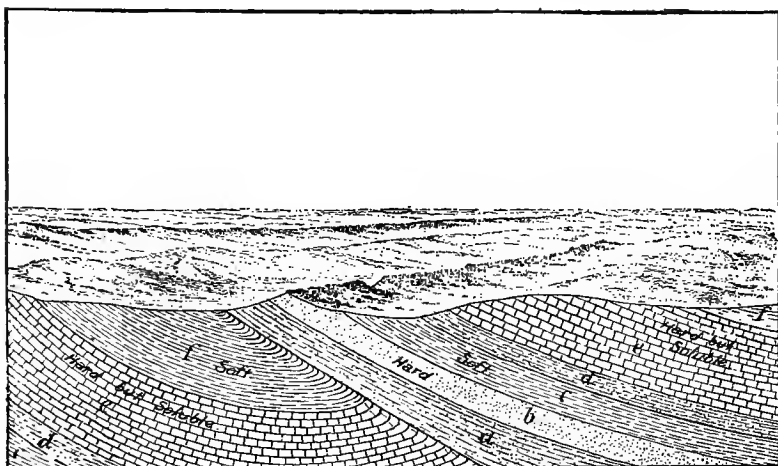

FIG. 15. Perspective view and vertical section of a thrust fault. After Willis.

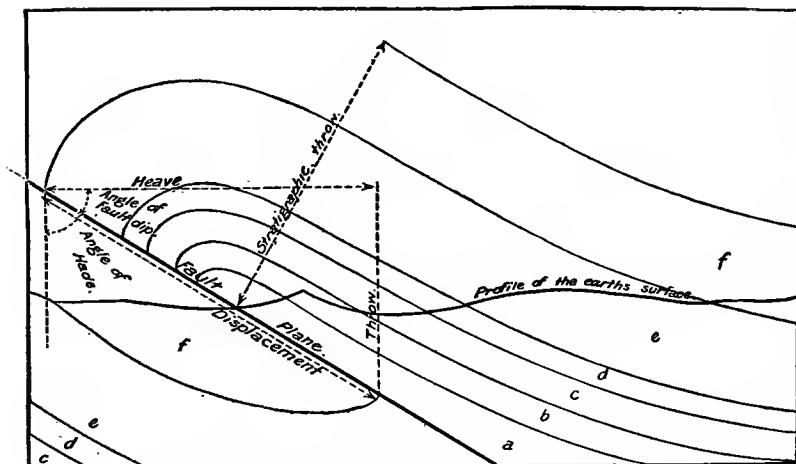

FIG. 16. Diagram of a thrust fault. After Willis.

pending upon the attitude of the beds with regard to the plane of the fault (Figs. 19, 20, 21, 22, 24, 25).

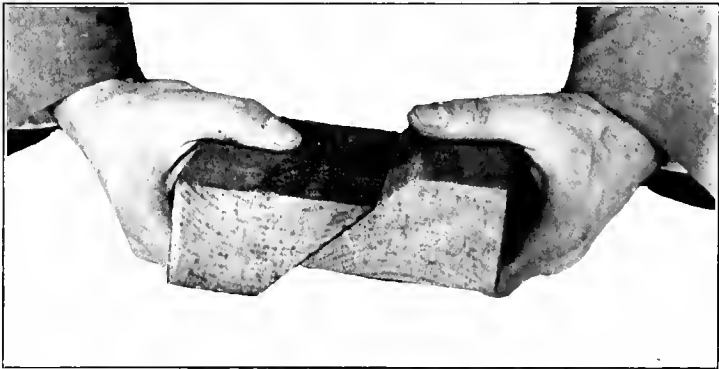

FIG. 17. To illustrate relative positions of blocks in normal or gravity faulting.

In general we have attempted to use too simple a nomenclature by which to classify faults. The classification is inadequate to give any accurate description of the great variety of relative dis-

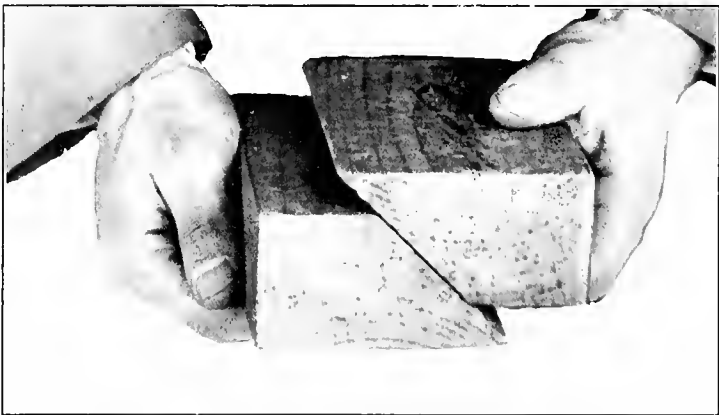

FIG. 18. To illustrate relative positions of blocks in thrust or reverse faulting.

placements possible along a fault plane. The inadequacy of the old method has been realized in recent years by many workers in the field, especially by men who have found it necessary to work

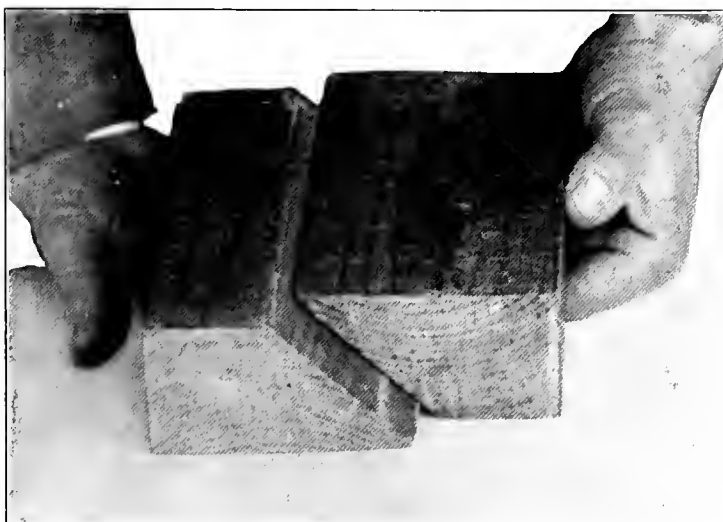

FIG. 19. Normal faulting produced by horizontal movement along table top.

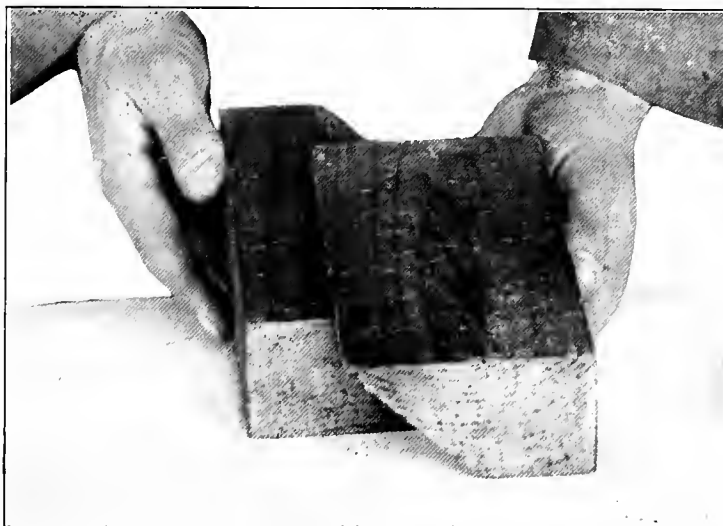

FIG. 20. Reverse or thrust faulting produced by horizontal movement along table top.

out in detail the extremely complicated fault systems in rocks associated with certain ore deposits. Consequently there have been several attempts to develop a more adequate nomenclature to describe the great variety of conditions met with in the field. Some of these attempts are very elaborate. There is yet no general agreement on any of these schedules.¹ Therefore none of these classifications will be given here. It may be questioned whether special nomenclature of faults is necessary. There has been developed in mechanics a technical nomenclature to describe displacements of all solid substances, which may as well be used for faults as a long series of names, difficult to remember, coined for the special use of the geologist. Quoting from Chamberlin²: The complaint "that our predecessors have trammelled us with premature and ill-chosen classes and names has for its logical response a forbearance on our part from further imposition of the kind on our successors; perhaps also it suggests an effort to free ourselves from our hamperings by dropping embarrassing terms, and by de-technicalizing such as it seems best to retain."

The terms "normal fault" and "thrust or reverse fault" have become so well entrenched in the literature of the subject that it is difficult to avoid their use. The writer believes that the two terms should be retained to express *apparent* displacements in a plane of section normal to the fault plane—not as implying real displacement. This restricted usage involves no wide departure from that of the past, but it emphasizes that which has too often been overlooked, i. e., that the terms have reference essentially to displacements as they appear in a two dimensional cross section.

APPARENT AND REAL FAULT DISPLACEMENTS

Fault displacements shown in a two dimensional cross section should be assumed to be apparent until the actual displacement has been proved. Arrows, commonly used to indicate displacements upon cross sections, are often misleading. They show only the

¹ Jaggard, T. A., Jr., How should faults be named and classified? *Econ. Geol.*, Vol. 2, 1907, pp. 58-62; Spurr, J. E., *idem*, pp. 182-184, 601-602; Willis, Bailey, *idem*, pp. 295-298; Cushing, H. P., *idem*, pp. 433-435; Tolman, C. F., Jr., *idem*, pp. 506-511; Evans, John W., *idem*, pp. 803-806; Chamberlin, T. C., *The Fault Problem*, *idem*, pp. 585-601, 704-724.

² *Econ. Geol.*, Vol. 2, 1907, p. 585.

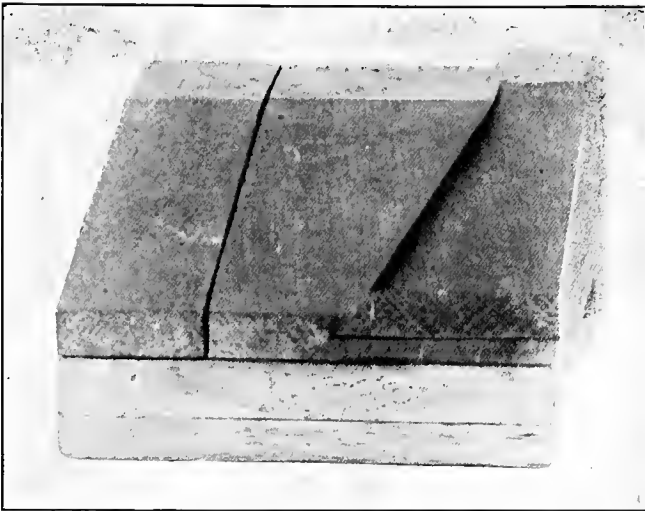

FIG. 21. Thrust fault relations produced by horizontal movement.



FIG. 22. Normal fault relations produced by horizontal movement.

apparent displacement in the plane of the cross section. They are likely to be assumed to show the real displacement.

Until the real displacement is actually proved, we cannot avoid the consideration of any of the possibilities. The limiting cases have been discussed on preceding pages. Yet seldom indeed do we keep a sufficiently open mind in this regard. To illustrate, in the southern Appalachians where there are repeated overthrust faults associated with overthrust folds, the structural facts are commonly shown on vertical sections normal to the trend of the fault traces or of the mountain ranges. Without analyzing the possibilities, we are likely to assume that the shortening is in the plane of the cross section, and may overlook the fact that the apparent displacement shown in the cross section may not be the real displacement and that the same structural features might have been produced by a couple of forces acting in directions inclined to apparent shortening, producing a shearing movement. If a deformed area of this type be regarded as a whole as a strain ellipsoid (see pp. 16-20) with its longer dimensions parallel to the trend of the range, there is perhaps less difficulty in realizing that the deformation may have been accomplished either by pure shortening or by shearing (see pp. 19-20), or more probably by some combination of the two limiting cases.

Even the use of the strain ellipsoid may be misleading, if care is not taken to ascertain whether the longest principal axis is vertical or horizontal or inclined. For instance, any ellipse superposed upon the Appalachian area with its longer axis parallel to the range is a cross section of an ellipsoid. It must not be assumed that the longer axis of this ellipse is really the greatest principal axis of the ellipsoid. In other words, the extension may have been greater upward than along the trend of the range. If it is true that fractures develop along the planes of no distortion in a strain ellipsoid and that the thrust faults of the Appalachians are controlled by this law, then it follows that the longest axis of the strain ellipsoid must have been essentially vertical. This is a natural expectation, for there are reasons to believe that the relief has been easier upward than laterally.

With alternative hypotheses open, how may the actual displacement be ascertained? It is frequently impossible to do this but there are certain ways in which the actual displacement

has in some localities been worked out. These ways are as follows:

Striations may mark the direction of displacement. In some cases in repeated movements later striations have destroyed earlier ones, perhaps formed in different directions.

The matching of the ends of broken dikes often makes it possible to determine the actual displacement of faults. This method has been used very effectively by the geologists of the Geological Survey of Scotland in determining both the direction and amount of the displacement of some of the large overthrust faults of the northwest Highlands of Scotland. Careful petrographic discrimination of these dikes and their uniformity and trend has aided greatly in tracing the dikes individually and in sets.

The matching of displaced ore-bearing veins has often indicated the actual displacement of faults. Probably in few other cases have the displacements of faults in three dimensions been considered so carefully as they have in many mining camps. The student is referred to Weed's monograph on the Butte district¹ and Emmons' and Garrey's bulletin on the Bullfrog district² for quantitative studies of actual fault displacements.

NORMAL FAULTS

Under this heading are considered faults in which the apparent displacement is downward on the overhanging side. In some cases the apparent displacement is known to be the real displacement—in other cases it is not.

Ordinarily a normal or gravity fault is regarded as the expression of tension, and a reverse or thrust fault as evidence of compression; but, as noted under the preceding headings, the elongation and shortening expressed by the terms normal faulting and reverse faulting have reference to the relations of the beds expressed in a plane normal to the fault plane. When considered in three dimensions, normal faulting may not show any extension of the mass as a whole, and reverse faulting may not show any shortening of the mass as a whole. Hinge faulting about an axis may produce on one side normal fault relations and on the other

¹ Weed, W. H., *Geology and ore deposits of the Butte district, Montana*: Prof. Paper U. S. Geol. Survey No. 74, 1912.

² Ransome, F. L., Emmons, W. H., and Garrey, G. H., *Geology and ore deposits of the Bullfrog district, Nevada*: Bull. 407, U. S. Geol. Survey, 1910.

reverse fault relations although there may have been no differential movements of the centers of mass of the two parts of the faulted body. Horizontal movement alone may result in apparent normal and reverse faults. (See Figs. 19, 20, 21, 22, 24, 25.)

Also faults which may prove to be tension phenomena may be merely subsidiary expressions of a major compressive thrust. Sometimes it is necessary to know only the actual displacement of



FIG. 23. To illustrate hinge faulting. This would appear as a normal or gravity fault on a plane normal to the fault plane passing through the ends of the blocks nearest the reader and as a thrust or reverse fault in a plane passing through the ends of the blocks farthest from the reader.

a minor portion of the faulted mass, as for instance, in a mine, regardless of any relation to major deformation. Ordinarily, however, it is desirable to relate the minor faulting to major deformation, and this is a much more difficult problem. An extreme case cited by Chamberlin¹ is that of a fault passing through the slope of a hill and displacing talus blocks. Knowledge of the relative displacement of the blocks in the talus slope may give

¹ Op. cit., p. 589.

little clue to the major and controlling displacement. In almost any complexly faulted area the local displacements may be varied and yet the major and controlling displacement be a comparatively simple phenomenon. A great thrust fault resulting in uplift may be accompanied by a considerable variety of local displacements which would be interpreted locally as both thrust and tension faults. These are subsidiary and local phenomena due to relaxa-

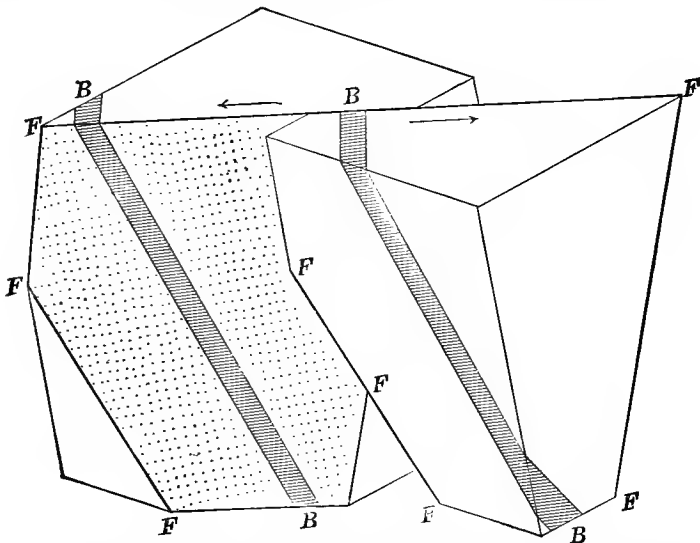

FIG. 24. Block dislocated by heave fault, showing apparent reverse faulting of bed BB. After Ransome.

tional movement, to the concurrent action of gravity, and to other causes.

Whether a given fault is really tensional or compressional when considered in three dimensions, whether it is subsidiary to a major fault of different displacement, has been satisfactorily determined in comparatively few instances. While the terms tension and compression are freely applied to faults, this is really done on the unreliable assumption that the apparent displacement in a vertical plane represents the actual displacement.

Means of identifying tension joints discussed on pp. 22-23 may be used also for determining local tension faults.

Normal Faults Associated with Igneous Rocks:—Faults are likely to be numerous within and adjacent to areas of igneous activity. They are especially numerous in surface volcanics. Such faults are more or less irregular and discontinuous, and offset along cross faults and joints, breaking the rocks into heterogeneous polygonal blocks. Displacements are both horizontal and vertical. Normal

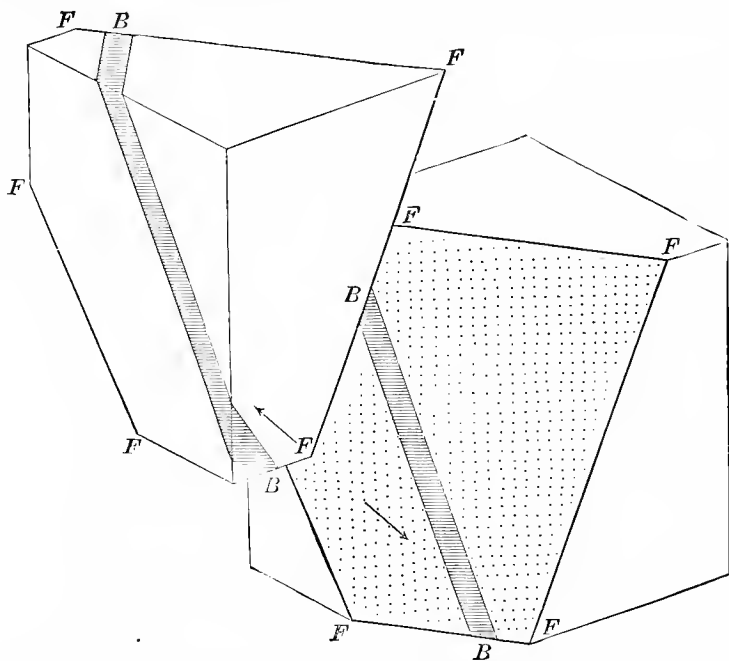

FIG. 25. Block dislocated by movement between heave and upthrust, showing apparent normal faulting. After Ransome.

faults predominate. Hinge faults are not uncommon. These faults are well illustrated on many maps of western mining districts prepared by the U. S. Geological Survey, notably those of the Tonopah,¹ Goldfield,² Bullfrog,³ and Clifton⁴ districts.

¹ Spurr, J. E., *Geology of the Tonopah Mining District, Nevada*: Prof. Paper No. 42, U. S. Geol. Survey, 1905.

² Ransome, F. L., *Geology and ore deposits of Goldfield, Nevada*: Prof. Paper No. 66, U. S. Geol. Survey, 1909.

³ Ransome, F. L., Emmons, W. H., and Garrey, G. H., *Geology and ore deposits of the Bullfrog district, Nevada*: Bull. 407, U. S. Geol. Survey, 1910.

⁴ Lindgren, Waldemar, *Copper deposits of the Clifton-Morenci district, Arizona*: Prof. Paper No. 43, U. S. Geol. Survey, 1905.

It has long been suspected that there is some genetic connection between faulting and igneous activity. Spurr expressed this specifically as follows:¹ "It is plain that the faulting was the result of adjustments of the crust to suit violent migrations of volcanic rock; that it originated with the swelling up of the crust and its forcible thrusting up and aside to make way for the numerous columns of escaping lava; and that after the cessation of the eruptions it was continued by the irregular sinking of the crust into the unsolid depths from which the lavas had been ejected. It can readily be seen that all sorts of pressure (from below upward, lateral, and downward, by virtue of gravity) must have been concerned in such movements, and that the first faults were due rather to upward and lateral irregular thrusts, while the later ones (in many cases along the same planes as the first) were due to gravity. So reversed and normal faults are equally natural, and both occur frequently."

"The writer at first looked upon the faulting at Tonopah as exceptional and local, and not to be connected with ordinary faulting in the Great Basin, but there now appears no reason for doubting that the phenomena within this small, carefully studied area are typical of the unstudied similar volcanic region beyond the limits of the map."

In discussing joints, attention has been called to the common development of joints and partings during the cooling of igneous rocks, including peripheral, radial, concentric, basaltic, and irregular partings. Faulting may follow any of these surfaces of weakness.

Normal Faults in Unfolded Sediments:—Normal faults may be locally developed in nearly flat-lying sediments. Here the cause of tension may be shrinkage and settling due to drying and recrystallization. Often no other causes are discernible, but it is not possible to exclude hypotheses of regional or deep-seated tension related to major earth movements.

Association of Normal Faults with Folds:—The reconstruction of an area with abundant normal faults may develop a fold or dome of low slope, suggesting that the normal faults result from the action of gravity upon a mass elevated by folding but inadequately supported. Normal faults associated with overthrust folds, to be

¹ Op. cit., p. 80.

seen, for instance, in the southern Appalachians, seem to be the natural consequence of settling following disturbance of equilibrium by thrust, in other words, of relaxation so commonly following compression.

The attempt has been made also to correlate tension faults existing over a great area with the collapse of a very gentle arch. For instance, the great normal faults in the Great Basin area are referred to the collapse of an arch originally extending from the Wasatch on the east to the Sierra Nevadas on the west.¹ Where broad, gentle arches are thrown up through compression or through changes in support below, the inherent weakness of the rocks may cause them to break almost from the start and allow certain blocks to settle within the arch. Chamberlin² has called attention to the inherent weakness of rocks and their inability to support themselves in large masses. For instance, a dome 80 miles in diameter, of any thickness, with the curvature of the earth, will bear only $1/48$ of its own weight. It is therefore apparent that when any great earth movement is initiated, tending to arch any part of the earth's surface, unless this arch is thoroughly and evenly supported by great masses below, it will be unable to sustain itself by its own strength alone; and one would expect a settling of blocks, giving the tension or normal type of faulting and jointing, with consequent extension of surface.

No such relation as that discussed in the above paragraph has been proved on any large scale. The existence of such a primary arch or tendency for arching is inferred as a possibility from the existence of supposed tension faulting.

Vertical and Steeply-Dipping Normal Faults and Joints in Intersecting Systems:—While thrust faults with low dips are frequently related to overthrust folds and have been usually ascribed to horizontal compression, in many cases such pressures have also been held responsible by some geologists for intersecting systems of vertical or steeply-dipping faults and joints.³ Becker⁴ called attention to the fact that it is mechanically possible for inter-

¹ Gilbert, G. K., Report on the geology of portions of Nevada, Utah, California, and Arizona, examined in the years 1871 and 1872: U. S. Geog. Surveys W. 130th Mer., Vol. 3, 1875, pp. 54-56.

² Chamberlin, T. C., and Salisbury, R. D., Geology, Vol. 1, 1904, p. 555.

³ Hobbs, W. H., The Newark system of Pomperaug Valley, Conn.: 21st Ann. Rept., U. S. G. S., pt. 3, 1901, pp. 7-162.

⁴ Becker, Geo. F.: Bull. Geol. Soc. Amer., Vol. 4, 1893, p. 50.

secting vertical or steeply-dipping faults and joints to develop under horizontal compressive stresses *only* when lateral relief were easier than upward relief, and that such conditions prevail over certain areas. (See pp. 28-29) Many other geologists apparently have not analyzed the subject and have overlooked this qualification of Becker's, having assumed that the fact of intersection in sets implies compressive stresses, without considering alternative hypotheses.

The possibilities of lateral relief rather than upward relief are difficult to determine in the field, and ordinarily it is not possible to be sufficiently certain about these to draw inferences from them as to the origin of the fault by tension or compression. Irregularities of surface, like valleys, may permit easy lateral expansion in intervening ridges, thus allowing the formation of vertical intersecting faults or joints by compressive stresses. However, in these cases it is altogether likely that, for each vertical fracture, the complementary fracture (see pp. 27-28) may be a horizontal shearing fracture rather than another vertical one, and that the existence of intersecting vertical fractures may be due to tension acting simultaneously or successively from two or more horizontal directions. The intersecting vertical joints then have purely fortuitous relations. They do not intersect at definite angles determined by the shearing stresses.

On the assumption that vertical or steeply dipping joints and faults are the result of tension, there have been two explanations to account for their existence in intersecting sets or systems. One explanation is that they were developed by torsion (see page 15). The other explanation is that they are the results of successive earthquake shocks from different directions, in which case they form under the tensional component of the wave, normal to the direction of propagation of the earthquake wave (see pp. 67-68). Still other explanations are possible. Joints and faults formed by the cooling of an igneous mass, or the settling and drying of a sediment may be in more or less regular sets. Relaxational settling after a period of compressive faulting or folding may develop normal or steeply dipping joints and faults in intersecting sets. The systems in these cases are not likely to be uniform and yet for small areas may have a considerable regularity of arrangement.

Another explanation is that one of the vertical sets may be

tensional and the intersecting set may be compressional, in the manner determined experimentally (see p. 16).

REVERSE OR THRUST FAULTS

Sections in the southern Appalachian folios show thrust faults associated with overthrust folds. The fault planes may be inferred to have the relations to stress indicated on pp. 20-21, in rotational or shearing compressive strains. The inference is usually made that there is an overthrust, and therefore shortening, of so many feet. This is true in the plane of the section. It tells us nothing of the movements inclined to the plane of the section,

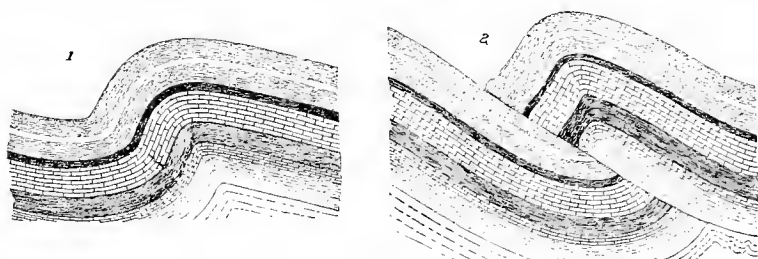

Fig. 26. Overthrust faulting localized by tension fracture "break thrust." After Willis. 1. Shows break in the massive limestone bed which determines the plane of the break thrust along which the displacement shown in 2 takes place.

which may have been fully as great. The association of "thrust" faults with overthrust folds usually indicates compression, but not so much compression as a two-dimensional cross section might indicate. Consideration of many cross sections is the same in effect as considering the fault in three dimensions, and leads to closer estimates of actual shortening.

An examination of the United States Geological Survey folios brings out this interesting fact that in the southern Appalachians 83% of the thrust faults, as indicated on the cross sections, are definitely related to overthrust folds. Willis¹ classifies them as (1) *break thrusts* where the thrust fault plane follows a previously formed tension fracture on the crest of the anticline; (2) *shear* or *stretch thrusts*, when the break follows the sheared and stretched

¹ Willis, Bailey, *Mechanics of Appalachian Structure*: 13th Ann. Rept. U. S. G. S., pt. 2, 1893, pp. 222-223.

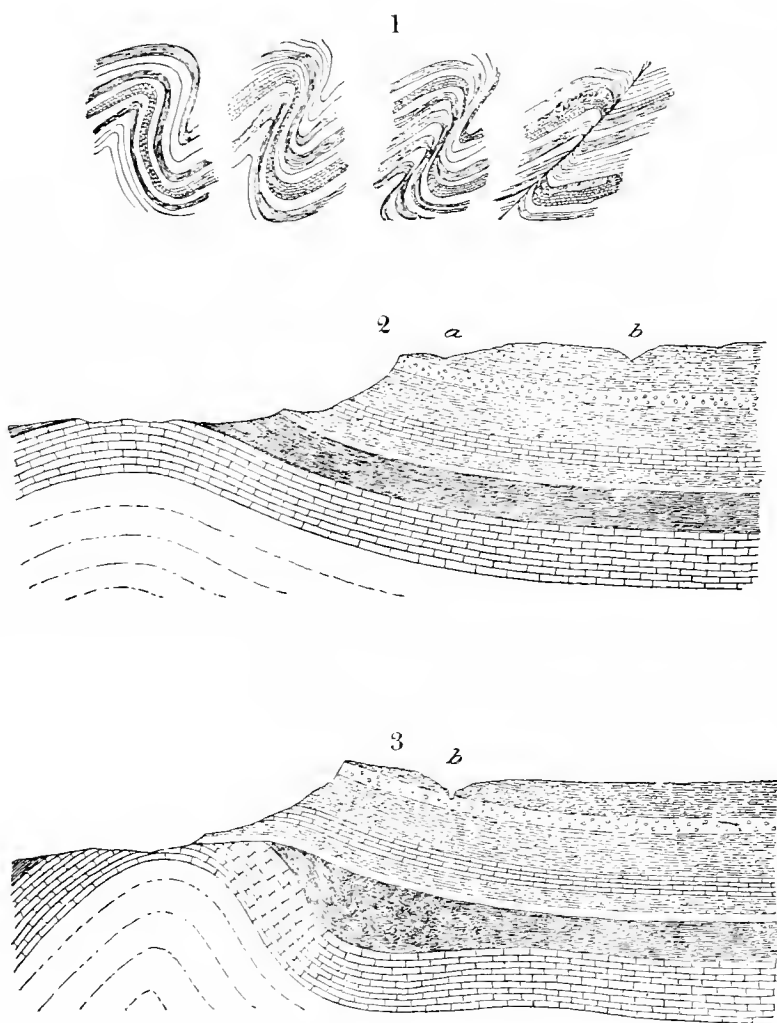

FIG. 27. Illustrating thrust fault developed by stretching and by erosion. After Willis. 1. Stretch thrust developed from an overturned fold by stretching of the middle limb; 2. Erosion profile and section of a simple anticline; 3. Erosion thrust developed from the condition shown in 2 by compression from the plateau side, accompanied by continued erosion.

underlimb of an overturned fold; and (3) *erosion thrusts* where the competent layer carrying the thrust is first weakened by erosion at or near the crest of the anticline. (Figs. 26 and 27.)

Distributive Thrust Faults:—Not uncommonly faulting takes place along several parallel closely-spaced planes—in a fault zone rather than in a single fault plane. The relations to stress are the same as in thrust faults. The total displacement may be large and yet the relative displacement along single planes may be slight. This faulting has been called distributive faulting. It is similar to

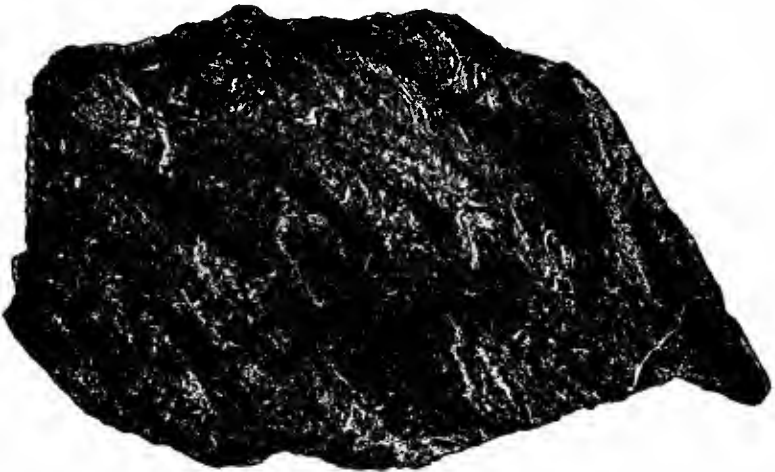

FIG. 28. Fault-slip cleavage in gneiss from southern Appalachians. The gneiss has been closely crenulated and the minute folds may be observed to pass into minute faults which now represent planes of fracture cleavage. The faults may have been cemented or may have been welded by actual pressure. Parallel to the faults there has also been developed a parallel arrangement of the mineral particles, perhaps due in part to the slipping along the fault planes, and it is exceedingly difficult to distinguish between the fracture cleavage and the flow cleavage.

the "Schuppen" structure of the Germans. It is well illustrated in the southern Appalachians. Fig. 28 shows some of these distributive faults associated with minute overthrust folds. Distributive faults may be on a minute scale, a dozen of them being seen in a single hand specimen, or on an indefinitely larger scale. Inspection of the Roan Mountain folio of the U. S. Geological Survey of eastern Tennessee and western North Carolina shows a remarkable

series of parallel faults which on a large scale can be regarded as distributive faults.

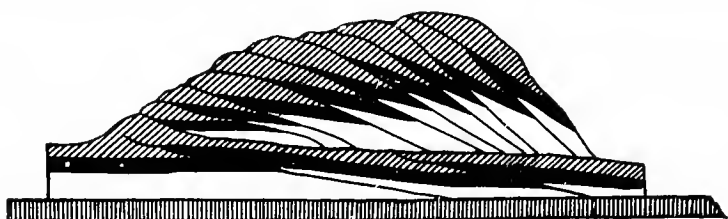

FIG. 29. Major fault plane or fault sole. After Cadell.

In the northwestern Highlands of Scotland is a similar phenomenon, there called *imbricate or schuppen structure*. The fault planes are in shearing planes formed by compression in a rotational strain (see pp. 16-21). The beds are minutely sliced and piled one on top of the other. As the deformation continues these beds may ride forward as a group over a major fault plane at the bottom, sometimes called the "sole." The reports and maps of the British Geological Survey¹ on the Scottish highlands afford an unrivaled opportunity for the study of faults of this type. Experimental reproductions of these faults by Cadell² throw light on the process. (Fig. 29). Some of his conclusions are quoted:

1. Horizontal pressure applied at one point is not propagated far forward into a mass of strata.

2. The compressed mass tends to find relief along a series of gently-inclined thrust-planes, which dip towards the side from which pressure is exerted.

3. After a certain amount of heaping-up along a series of minor thrust-planes, the heaped-up mass tends to rise and ride forward bodily along major thrust-planes.

4. Thrust-planes and reversed faults are not necessarily developed from split overfolds, but often originate at once on application of horizontal pressure.

5. A thrust-plane below may pass into an anticline above, and never reach the surface.

¹ Peach, B. N., Horne, John, Gunn, W., Clough, C. T., and Hinxman, L. W., *The geological structure of the northwestern highlands of Scotland, with petrological chapters and notes by J. J. H. Teall*, edited by Sir Archibald Geikie: Mem. Geol. Survey of Great Britain, 1907.

² Op. cit., pp. 473-476.

6. A major thrust-plane above may, and probably always does, originate in a fold below.

7. A thrust-plane may branch into smaller thrust-planes, or pass into an overfold along the strike.

8. The front portion of a mass of rock being pushed along a thrust-plane tends to bow forward and roll under the back portion.

9. The more rigid the rock, the better will the phenomena of thrusting be exhibited.

10. Fan-structure may be produced by the continued compression of a single anticline.

11. Thrust-planes have a strong tendency to originate at the sides of the fan.

FAULTS WITH HORIZONTAL DISPLACEMENTS

The faulting in which the California earthquake originated followed a vertical plane along which the rocks were horizontally displaced. This is one of the few cases of definitely proved horizontal displacement.¹ Illustrations on a much smaller scale may be found in the faulting of the igneous rocks of many western mining districts, cited on pages 42-43. Striations on fault surfaces not uncommonly show that there has been some degree of horizontal displacement, even though the major displacement is vertical. More attention is now given than formerly to possibilities of horizontal displacement, with the result that more information in regard to this type of movement is becoming available. As yet, however, good illustrations are few.

HINGE OR PIVOTAL FAULTS

A common type of faulting is displacement about an axis normal to the fault plane, one part of the block going up and the other part going down. (See Fig. 23.) If the fault plane is inclined, pivotal faulting may give an apparent normal fault on one side of the axis and an apparent reverse fault on the other side. Faults of this kind are numerous in the areas of surface volcanics in the West. (See map of the Iron Springs District, Utah, Bull. 338, U. S. G. S.)

¹ Gilbert, G. K., Bull. 324, U. S. Geol. Survey, 1907, p. 4.

CURVED AND FOLDED FAULTS

Curved fault and joint surfaces, especially joint surfaces, may be formed by spalling of surfaces, caused by insolation, and other processes. Fractures related to the cooling of igneous rocks may be curved. Curved fractures are found in other relations where it is not easy to analyze causes, though there is no reason to doubt that they are governed by principles already described.

After fracture planes are formed, they may be faulted or folded. Folded thrust fault planes are described and figured by Keith in the Roan Mountain folio of the southern Appalachians¹ (Figs. 30, 31 and 32), and by Richards and Mansfield² in the Bannock overthrust in southeastern Idaho. When previously fractured rocks undergo conditions of flowage, the fractures are obliterated.

Folded fault planes should not be confused with the curving of fault lines on the erosion surface, due to irregularities of topography.

FAULTS PASSING INTO FOLDS OR INTO SCHISTOSE ZONES

A fault may pass into a fold along the strike, down the dip, or even up the dip. The intimate relation of thrust faults and overthrust folds has already been cited for the southern Appalachians. Cadell in his experimental work illustrating the faults of the Scottish Highlands showed that the displacement by faulting below might take place above by folding.³ The Kaibab fault of the high plateaus of Utah, a normal fault, grades along the strike into a monocline.

Below the surface fractures die out, at depths varying with the strength of rocks, when the zone of flowage for these given rocks is reached. Displacement may be accomplished by rock fracture above and by rock flowage below. If a cube of soft clay be compressed from one side, held stationary at the ends, and with room for escape upward, a thrust fault will be developed on its upper side dipping toward the thrust. Lower in the cube this thrust

¹ Geol. Atlas U. S., Roan Mountain folio, No. 151, U. S. Geol. Survey, 1907.

² Richards, R. W., and Mansfield, G. R., The Bannock overthrust; a major fault in southeastern Idaho and northeastern Utah: Jour. Geol., Vol. 20, 1912, pp. 681-709.

³ Cadell, H. M., Geological Structure of northwest Highlands of Scotland: Mem. Geol. Survey of Great Britain, 1907, pp. 473-476.

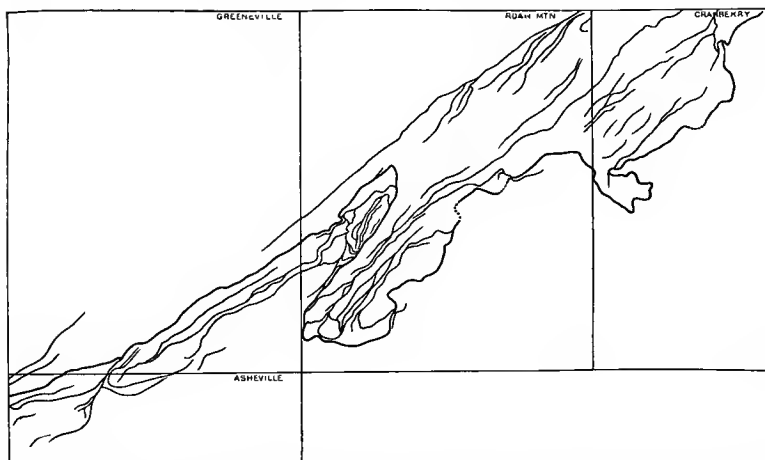

FIG. 30. Map of the faults in the Roan Mountain and adjacent quadrangles, Tennessee and North Carolina, showing the relation of the minor faults (lighter lines) to the earlier major overthrust (heavy line). Curved fault traces result from folding and unequal erosion. After Keith.

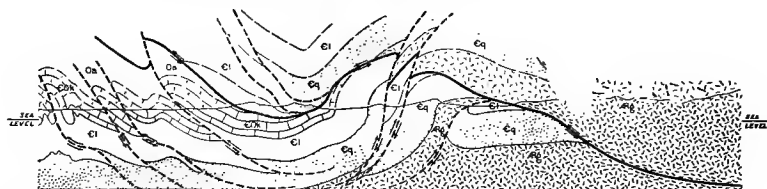

FIG. 31. Theoretical section across Buffalo Mountain and Limestone Cove, Tennessee. After Keith. Shows the character of the deformation and the relation of the younger faults to the older overthrust. Major overthrust, heavy continuous line; minor faults, broken heavy line; Oa, Athens shale and overlying beds; COk, Knox dolomite; Cl, Cambrian limestones and shales; Cq, Cambrian quartzites and slates; Arg, Archean granite and gneiss.

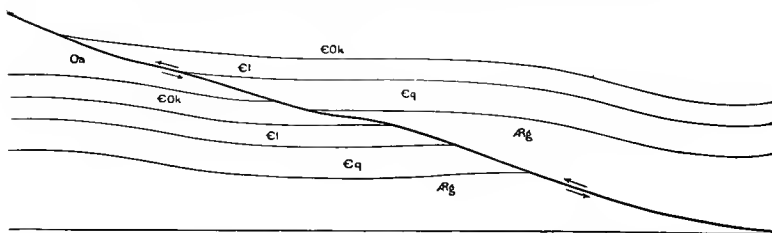

FIG. 32. Theoretical section showing supposed relations of beds in Fig. 31 after the major faulting but before the later folding and faulting. After Keith.

fault will grade into a deformation which approximates rock flowage.

Chamberlin¹ has suggested that certain great thrust planes, such, for instance, as the one described by Willis in the Front Range of the Rockies in Montana² may be the equivalent of deformation by flowage down the dip of the fault plane. Van Hise and Chamberlin have both regarded as probable the slipping of an outer brittle and competent zone of fracture over a lower zone of flowage by tangential shearing in the upper part of the zone of flowage. Chamberlin would regard thrust faults as merely the surface manifestations of this deep-seated shearing.

CORRELATION OF FAULTS

The complexity of fault phenomena makes it difficult to discover true causes or displacements. For the same reason, it is hardly legitimate to infer extensions or correlation of faults between separated areas. In only a few districts are the fault directions sufficiently uniform to warrant their correlation with faults of substantially the same directions in other districts. Especially is the extension and correlation of faults unwarranted in regions of igneous rocks where, as shown by the various maps of western mining districts (such, for instance, as the Tonopah, Clifton, Globe, and Bisbee) faults run in nearly all directions, intersect at all angles, change their directions, are cut off suddenly, and in fact, show all the irregularities to be expected from interior strains of intrusion and cooling. One is scarcely warranted in one of these camps in extending a fault on the map ten feet beyond where definite evidence of it is seen, for it may suddenly end or change its direction entirely. Scarcely less irregular are the joints caused by drying and settling of sediments. When one considers the heterogeneity of rocks taken on a large scale, it is to be expected that even though the stresses are applied in a uniform direction over a large area, these stresses will be carried and resolved in such directions and intensities as to develop fractures with great variety of attitudes. Hence the difficulty of correlating faults over wide areas or

¹ Chamberlin, T. C., *The fault problem*: Econ. Geol., Vol. 2, 1907, pp. 585-601; 704-724.

² Willis, Bailey, *Stratigraphy and structure, Lewis and Livingston ranges, Montana*: Bull. Geol. Soc. Amer., Vol. 13, 1902, pp. 331-336.

between heterogeneous systems of rocks can scarcely be overestimated.

Moreover, after rocks have been fractured they may be deformed by folding, in which case the fault and joint planes may be so distorted that they will appear on the surface as curved lines. The folded thrust fault planes in the southern Appalachians illustrate the remarkable complexity which may be developed in a joint or fault plane. Topographic irregularities cause a fault plane with low dip to appear curved on the surface. The surface distribution of such folded faults has little similarity to the idealized sets of straight line intersecting faults often presented as typical of fault conditions.

RELATIVE NUMBER OF NORMAL AND REVERSE FAULTS

The prevailing impression is that normal faults are more common than reverse or thrust faults, as indicated by the use of the term "normal." Chamberlin and Salisbury estimate that probably 90% of the known faults are normal.¹ A compilation made from all the faults indicated in the cross sections of U. S. Geological Survey folios fails to show such large dominance of normal faults. Whatever the true relative abundance, it should be kept in mind that this comparison only covers cases of apparent displacement in a vertical plane. It is likely that faults with nearly horizontal displacement are much more abundant than has been supposed.

A subject for inquiry is suggested in the relative abundance of normal and thrust faults in rocks which have been deformed only at the surface, as compared with rocks which have been deformed deep below the surface and subsequently exposed by erosion. Casual inspection of the available data, particularly the frequent association of thrust faults with phenomena of the zone of rock flowage, suggests that thrust faults are more common in rocks which have been deformed deep below the surface, while normal faults seem to be characteristic of surface deformation. Normal faults may imply extension of area which is possibly only at the surface. Of course there can be no clean-cut discrimination of two zones. When thrusts are exposed by erosion they may have superposed on them normal faults characteristic of surface conditions.

¹ Chamberlin, T. C., and Salisbury, R. D., *Geology*, Vol. 1, p. 498.

RELATIVE SHORTENING AND ELONGATION OF THE EARTH'S CRUST BY FAULTING

Detailed studies of actual fault displacements are so few and far between that little can be said as to the actual elongation or shortening of large parts of the faulted earth's crust. Until this is done, it is perhaps premature to consider general questions like the shortening or elongation of the earth's crust in a faulted area. Attempts have been made which suggest some of the following tentative and rather vague considerations.

The displacements in normal faults may be assumed to be dominantly radial with regard to the globe, and as the dip of the fault plane is seldom exactly vertical, the downward movement requires extension of the horizontal surface. Compression faults may be supposed in general to represent tangential shortening, with subsidiary vertical displacement.

In view of the difficulties, already cited, of determining locally whether a fault represents tension or compression in three dimensions, it is obviously impossible yet to answer the question for large areas as to the quantitative effect of faulting on the extension or shortening of the earth's surface. For a given area tension faults at the surface may be much more numerous than thrust faults, yet the lengthening of the surface represented by the tension faults may be of less amount than the shortening of the surface by a thrust fault. The dip of a thrust fault plane is usually low, that of a normal fault plane, high. An average from the United States Geological Survey folios gives a dip of 36° for reverse fault planes and 78° for normal fault planes. A displacement of a foot on the thrust fault plane means nearly a foot of horizontal shortening; a displacement of a foot on the normal fault plane means but a few inches of horizontal lengthening. A single thrust plane of low dip, then, may accomplish a horizontal shortening which would require for compensation a large number of normal faults.

If the crust as a whole has been shortened by mountain folds, it might appear that thrust faults are probably the dominant structure, and that all tension faults are ultimately subsidiary phenomena.

Geologic history seems to point to alternations of great compressive and relaxational movements. During a period of mountain-making, compressive stresses develop, resulting in tangential

deformation in a comparatively short space of time, with subsidiary radial deformation in areas of uplift. During the succeeding period of quiescence it may be supposed that the action of gravity on uplifted areas may develop normal faults which partially compensate for the earlier shortening.

The extension of areas caused by normal faults due to the cooling of igneous rocks or the drying and settling of sediments is commensurate with the shrinkage of these rocks during these processes; such faults cause no real extension of the earth's surface.

There have been some attempts to calculate the lengthening or shortening of an area on the assumption that the displacements shown in cross sections are the real displacements, without taking into account the probability of displacement in the third dimension. One of the few attempts to consider the problems in three dimensions is that of Emmons and Garrey who have estimated the actual extension by faulting of the Bullfrog district of Nevada.¹ They show that the apparent extensions in individual cross sections are greater than the real extensions because there has been much movement in directions inclined to the plane of the cross section shown by striations on fault surfaces. From somewhat careful quantitative study they conclude that the apparent extension should be reduced by at least one-third to approximate the real extension of the area.

EVIDENCE OF FAULTING

The existence of faults may be determined by:

1. Fault scarps, where the faults are recent, and erosion has not had time to reduce them. Excellent examples are the Hurricane fault scarp of the Wasatch front and the scarps so conspicuous in the Basin Ranges.
2. Linear features in the topography may be caused by faulting which brings into juxtaposition rocks of differing resistance to erosion.
3. Areal distribution of rocks or of erosion forms follows certain general laws, the variation from which requires the consideration of faulting as a disturbing factor. Illustrations may be found in any faulted district.

¹ Ransome, F. L., Emmons, W. H., and Garrey, G. H., *Geology and ore deposits of the Bullfrog district, Nevada*: Bull. 407, U. S. Geol. Survey, 1910, p. 88.

4. Erosion may develop drainage lines on fault planes. This and the other fault evidences above mentioned are further discussed on a later page under the heading "Surface expression of Faults."

5. Faulting is usually accompanied by a shear zone or the division of the rock into slices parallel to the plane of the fault.

6. Faulting may be accompanied by brecciation.

7. Faulting may be accompanied by the grinding up of the rock into a clay-like mass, ordinarily called "gouge." Fault gouge is some times really clay; more often, however, it is the ground up rock from which the bases have not been removed.

8. Striations on fracture surfaces of course suggest faulting.

9. Displacements of dikes and veins give some of the most easily recognizable evidence of faulting.

It is seldom that any one of the above criteria will be entirely decisive in itself. Particularly is it true that an apparent fault scarp should not be accepted as conclusive proof of faulting until faulting has been otherwise substantiated. Still less is it true that drainage lines can be accepted in themselves as evidence of faulting. Even gouge, breccias, etc., may be developed under conditions other than faulting.

SURFACE EXPRESSION OF FAULTS

Normal faults may find expression at the surface in escarpments, fault traces, drainage lines, or modified distribution of the rocks. Escarpments may appear where the displacement is recent and erosion has not had sufficient opportunity to reduce the inequalities or where the deformation has brought into juxtaposition rocks of differing hardness, thus permitting inequality of erosion on the two sides of the fault plane. In this case the downthrow side of the scarp may or may not be the downthrow side of the fault.

Among the best known instances of faults still represented by the original escarpments are the Hurricane fault separating the Wasatch Mountains from the Great Basin, and the faults of the Great Basin ranges, which were originally classified by Gilbert¹

¹ Gilbert, G. K., Report on the geology of portions of Nevada, Utah, California, and Arizona, examined in the years 1871 and 1872: U. S. Geog. Surveys W. 100th Mer., Vol. 3, 1875, pp. 17-187.

as an example of the block type of mountains. A fault scarp resulting from recent displacement accompanied by earthquakes in Alaska is illustrated in Fig. 33. The criteria used by Gilbert for the recognition and delineation of fault scarps of the Great Basin are (a) their steepness, (b) their association with shear zones and displacement of beds, (c) displacement of plateau level as in the Hurricane fault of Utah, (d) the fact that the scarps may not converge toward the end of the mountains as they would if they



FIG. 33. Fault scarp developed during earthquake of 1899, Yakutat Bay region of Alaska. After Martin.

were normal erosion scarps, (e) the existence of triangular facets across the ends of ridges as though the ridge had been sliced off, (f) the recent displacement of alluvial fans, lake beds, and other surface features, indicating that the faulting has been going on to very recent times and has not had time to be masked by erosion. Spurr¹ questions these criteria for the surface delineation of faults, or rather, the degree of emphasis to be placed on them. He calls attention to the fact that erosion has been conspicuously effective in producing the present topographic features of some of the Great Basin ranges, that anticlines and synclines play an important

¹ Spurr, J. E., Origin and structure of the Basin Ranges: Bull. Geol. Soc. Am., Vol. 12, 1901, pp. 264-266.

part, and that the recognized faults in these ranges are often quite independent of the topographic features. The student may study maps of these ranges to advantage, keeping in mind the criteria above cited. On these and on the Terlingua, Texas, topographic map, specific topographic features seem to indicate recent faulting.

In districts of older deformation, like the southern Appalachians, erosion has had a longer time to develop the topographic features, with the result that original fault scarps are practically non-existent. The effect of faults on the topography is due to their bringing into contact rocks of unequal hardness, thus permitting differential erosion. The flat and curved attitudes of the fault planes here also tend to make them less conspicuous in the topography.

Thrust faults are not likely to produce steep vertical escarpments, either before or after erosion. By pushing forward successive slices of rock they tend to cause linear features in the topography, and yet these features are not different from those which might have been produced by folding and probably they would not be identified as related to thrust faulting unless the thrust faulting had been otherwise proved.

In regions of vertical faults, especially in flat-lying beds and non-glaciated areas, the lines of the faults are very likely to be marked by drainage channels which have developed along these planes of weakness. All faults are not marked by drainage lines, nor do all drainage lines mark faults. (See p. 12.)

One of the most fully studied cases of the surface expression of a fault with horizontal displacement is that of the fault which caused the California earthquake of 1906. "At the surface the cracks had great variety of expression. Some were barely perceptible as partings; others gaped so widely that one might look down them several yards. Some were mere pullings apart; others showed small differential movements of the nature of faulting. Some were solitary; others, especially those exhibiting faulting, were in groups."¹ Where the fault crossed a spur or shoulder of a mountain a scarp appears. Small basins or ponds, many having no outlets and some containing saline water, are frequently found at the base of small scarps. Troughlike depressions appear on both

¹ Gilbert, G. K., Bull. 324, U. S. G. S., 1907, p. 7.

sides, also bounded by scarps. Small knolls or sharp little ridges are common at the fault line and these are bounded on one side by a softened scarp and separated from the normal slope of the valley side by a line of depression. Other effects of this fault are slides of earth or rock from the hillslopes. Finally, there are many conspicuous dislocations of the works of men.¹

The relations of valleys and particularly lakes to fault displacements may be studied to advantage in the northern part of the Santa Cruz, California, folio.

SUGGESTIONS FOR LABORATORY STUDY OF FAULTS

(See also page 31)

Much can be done in the study of faults on geologic maps, referred to on the foregoing pages, particularly in the section on the surface expression of faults. It is suggested that these maps and others named below be studied with a view of answering specifically the following questions:

How are the faults indicated by the topography, or the distribution of the outcrops? What is the dip of the fault plane? What is the apparent displacement? Is there any way of ascertaining the real displacement? Considered in three dimensions, what has been the deformation accomplished by the faulting? The dip of a fault plane may be determined in some cases by actual measurement, in others by the relation of outcrops to topography. What are the possible relations of the fault plane to stresses producing it?

Morristown, Tennessee, folio (No. 27) U. S. Geol. Survey.

Roan Mountain, Tennessee-North Carolina, folio (No. 151) U. S. Geol. Survey.

Stratigraphy and structure, Lewis and Livingston Ranges, Montana, by Bailey Willis: Bull. Geol. Soc. Am., Vol. 13, 1902, pp. 305-352.

Anthracite-Crested Butte, Colorado, folio (No. 9) U. S. Geol. Survey.

Silverton, Colorado, folio (No. 120) U. S. Geol. Survey.

Bisbee, Arizona, folio (No. 112) U. S. Geol. Survey.

The Bannock overthrust; a major fault in southeastern Idaho and northeastern Utah, by R. W. Richards and G. R. Mansfield: Jour. Geol., Vol. 20, 1912, pp. 681-709.

The interpretation of topographic maps, by R. D. Salisbury and W. W. Atwood: Prof. Paper No. 60, U. S. Geol. Survey, 1908, p. 77.

The geological structure of the northwest Highlands of Scotland: Memoir Geol. Survey, Great Britain, 1907, pp. 463-476.

Report on an investigation of the geological structure of the Alps, by Bailey Willis: Smithsonian Misc. Collections, Vol. 56, No. 31, 1912.

Experiments on faulting must be limited to the equipment available in the laboratory. If there is available equipment for compression tests of

¹ Lawson, A. C., Preliminary report of the State Earthquake Investigation Commission, 1906, and final report, 1908.

stone or building materials, this can be advantageously used in experiments of the kind referred to on page 16.

There are other simple and inexpensive devices for showing most of the facts discussed on the foregoing pages. One of these is the wire screening, described on pp. 18-20. It is easy to devise apparatus for the deformation of clay and small plaster of Paris blocks, because the stresses required are very moderate. Much can be done with these materials with an ordinary vise or in using clay with a box with movable sides working under screw compression.

Another simple device is a rubber sheet mounted on a frame with extension screws, so that it may be stretched or contracted in any direction. The sheet is coated with paraffine and stretched. Tension fractures develop normal to the stretching. If the rubber sheet be first extended in one direction and then coated with paraffine and allowed to contract, compression fractures develop in planes dipping toward or away from the compression or contraction and striking normal to the direction of movement. Contraction in one direction is accompanied by expansion in a direction normal to it, resulting in tension fractures normal to the compression fractures. This simple equipment also allows of experiments involving warping and rotational stresses.

The deformation on the surface of an expanding or contracting rubber sheet is perhaps more nearly like rock deformation in nature than the deformation produced by applying external pressure through the sides of a rectangular box, for so far as the conditions can be inferred in nature, the stresses are ordinarily not applied externally against definite faces of the deformed mass, but are distributed throughout considerable rock masses.

FRACTURE CLEAVAGE AND FISSILITY

Fracture cleavage may be defined as a structure inherent in a rock mass whereby under stress it breaks along closely spaced parallel incipient joints. It differs from flow cleavage in features noted below. The term fissility has been used by Van Hise¹ for the actual parallel partings; but he uses it also to include capacity to part along such parallel planes. In the latter usage it is practically synonymous with fracture cleavage. It may be desirable to retain the term fissility as strictly defined by Van Hise for the actual partings, as distinguished from fracture cleavage, which applies to the capacity to part. Other terms more or less synonymous with fracture cleavage are close-joints cleavage, "ausweichungs" cleavage, fault-slip cleavage, rift, etc. (Figs. 34-37).

Fracture cleavage is a fracture phenomenon and is developed

¹ Van Hise, C. R., Principles of North American pre-Cambrian geology: 16th Ann. Rept. U. S. G. S., pt. 1, 1896, p. 633.

under the general stress-strain relations already discussed for joints and faults. In some cases the surfaces of weakness are clearly cemented joint surfaces. In other cases there is no evidence that there has ever been actual parting followed by cementation; the surfaces seem to be incipient fracture surfaces along which the rock is still coherent, like cracks in a plate which has not yet fallen apart. Arrangement of the mineral particles with their longer axes in the plane of fracture cleavage is not a necessary condition, though this arrangement is often secondarily developed by rubbing between the parts. Fracture cleavage may be partly the result of

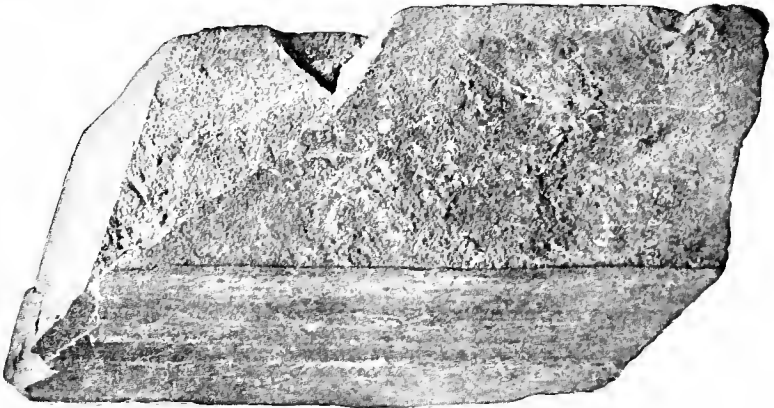

FIG. 34. Fracture cleavage developing polygonal blocks in slate previously possessing flow cleavage.

minute relative displacements along incipient fracture planes by minor monoclinical folding or faulting of the distributive type mentioned in another place. (See p. 48 and Fig. 35.)

Fracture cleavage planes are more widely spaced than "flow cleavage" planes (see p. 76) and are characteristically in two or more intersecting sets, allowing the rock to break into various polygonal forms. In some rocks one set is so dominant and so closely spaced as to give a structure very closely simulating flow cleavage; indeed, there are many rocks in which the structure cannot be satisfactorily designated either as fracture or flow cleavage, but is in reality some combination of the two.

Fracture cleavage, as a phenomenon of the zone of rock frac-

ture, may be superposed upon rocks which had before been in the zone of rock flowage. The previous existence of a good rock cleavage developed in the zone of flow favors the development, in the

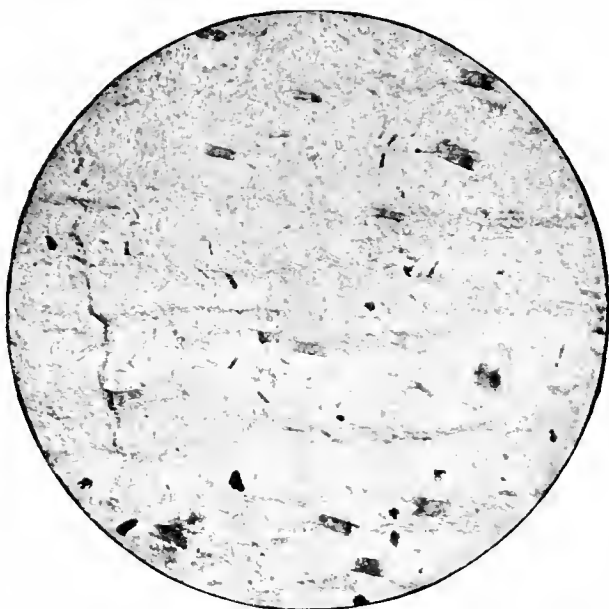

FIG. 35. Photomicrograph of slate with false or fracture cleavage from Black Hills of South Dakota. The longer diameters of the particles, mainly mica, quartz, and feldspar, lie, for the most part, in a plane intersecting the plane of the page and parallel to its longer sides, but in well-separated planes at right angles to this plane the longer diameters of the particles have been deflected into minute monoclinic folds represented by the darker cross lines. In these cross planes also porphyritic biotites have developed with their longer diameters parallel. The rock has two cleavages, one conditioned by the prevailing dimensional arrangement of the minute particles and the other conditioned by the planes of weakness along the axes of the minute monoclinic folds crossing the prevailing cleavage. The first cleavage is flow cleavage developed in normal fashion during rock flowage, and the second is of the nature of fracture cleavage developed later along separated shearing planes in the zone of fracture or in the zone of combined fracture and flowage. The rock cleaves into parallelepiped blocks.

zone of fracture, of closely-spaced parallel planes of parting, yielding fracture cleavage or fissility.

On the other hand, if a rock with fracture cleavage comes into the zone of rock flowage, the structure is obliterated.

A common example of the development of fracture cleavage

or fissility is found where a soft bed is deformed by fracture between two stronger beds, as for instance, the Baraboo quartzite. Here curved fissures are formed by compression (see Figs. 9, 10, and 11), and these are crossed by tension cracks. The mechanics of this problem are discussed on pp.16-21.

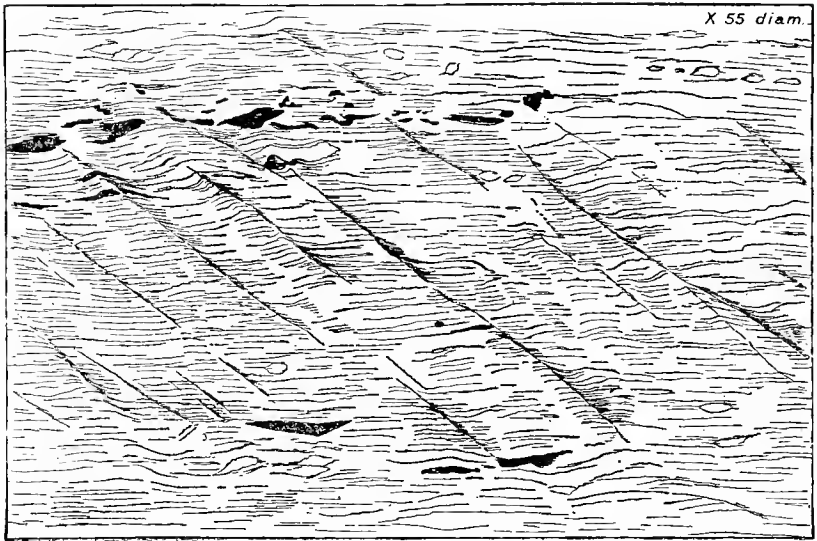

FIG. 36. Fracture cleavage crossing flow cleavage. After Dale.

BRECCIAS AND AUTOCLASTICS

When rocks are broken into irregular angular fragments they are called "breccias," "friction breccias," or "autoclastics" ("self-broken" rocks). They may be cemented by infiltration. Such rocks may be difficult to discriminate from conglomerates or "clastics" formed by the ordinary processes of erosion. Some of these differences are as follows: (a) The fragments in the autoclastic rock are usually more angular than those of the conglomerate, but to this there are exceptions. (b) They are likely to be more homogeneous in character; ordinarily they are of one kind of rock. Clastic rocks may have several kinds of fragments coming from different sources. However, many clastics are made up dominantly of one kind of fragment; hence this criterion is also

inconclusive. (c) The cement of an autoclastic rock is likely to be vein material, while that of a clastic is usually fine-grained fragmental material. This is one of the safest criteria. (d) An autoclastic rock may be developed in zones crossing the bedding. This

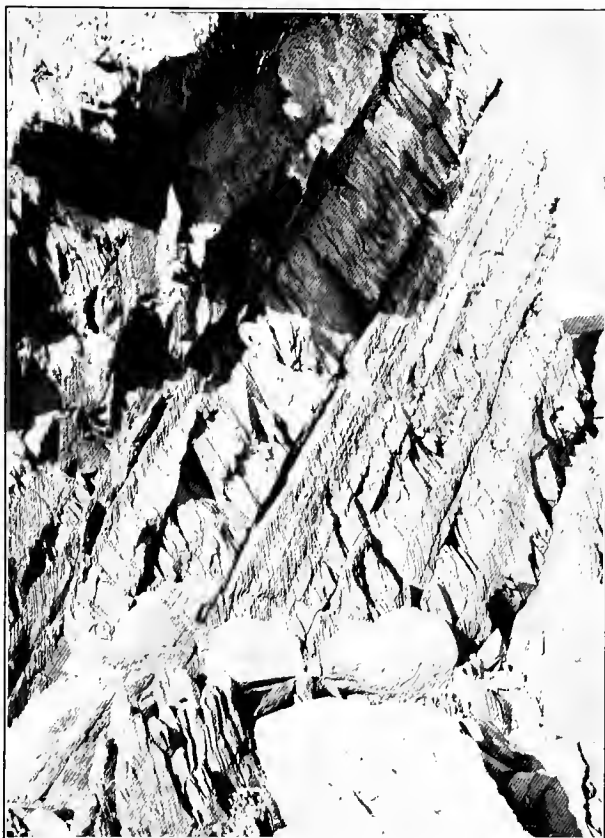

FIG. 37. Fracture cleavage, jointing and flow cleavage developed in graywacke and slate, Alaska. After Gilbert (photograph by U. S. Geol. Survey.) Use principle of strain ellipsoid (See pp. 18-21) to ascertain direction of relative displacement and theoretic position of fracture planes and flow planes. (See also Figs. 9 and 10).

occurrence sometimes gives a clue as to its origin. No one of the above distinctions is decisive. Collectively they may be so, but not in all cases.

In so far as autoclastics and conglomerates have been rendered schistose, the difficulty of discrimination is increased. An Archean porphyry of the Vermilion district of Minnesota is sheared into rhombs, which have been flattened by flowage, and brought out by weathering as elongated lenses, like pebbles. This pseudo-conglomerate can be discriminated only with the greatest difficulty from the overlying true conglomerate forming the base of the Algonkian which is made up dominantly of pebbles of porphyry, likewise elongated by flowage.

Volcanic tuffs and breccias often simulate autoclastic rocks in many respects. Tuffs result from fracture, but differ from autoclastics in that the fracture is caused by volcanic explosion rather than by mechanical stresses acting directly through the earth. Volcanic "flow breccias" produced by the cooling, hardening, and breaking up of the lava surface while still flowing, likewise resemble autoclastics. Means of identification of tuffs and volcanic breccias are often found (1) in the homogeneity of their fragments, (2) in the possession of volcanic textures such as amygdules peripherally arranged, (3) in the cementation of their fragments by volcanic dust or rock, and (4) in the angularity of the fragments. None of these criteria are decisive in discriminating tuffs from clastics or autoclastics. Tuffs formed under water are distinguished only with very great difficulty from water-deposited clastics resulting from erosion. The fragmental rocks associated with the immense basaltic flows of Ontario and the Lake Superior region well illustrate the difficulties of this discrimination.¹

Autoclastics may be confused with volcanic rocks having amygdaloidal fillings or porphyritic textures especially when the volcanics are schistose, and also with concretionary structures of limestone.

It may seem that the above discussion of the character of autoclastics emphasizes too strongly the difficulties of their discrimination from conglomerates, tuffs, and other rocks. It has been the writer's experience, however, that these difficulties have been a much too common source of mistake and confusion, especially in schistose areas. Hasty judgments based on the superficial aspect of the rock lead to unreliable results. Criteria should be applied in detail and the conclusion verified by all possible geologic evidence.

¹ Van Hise, C. R., and Leith, C. K., *Geology of the Lake Superior region*: Mon. 52, U. S. G. S., 1911, pp. 118-143.

A geologist who has been working in an area where there is clear evidence of autoclastics may carry preconceived notions of the abundance of that kind of rock into another area, and fail to recognize there the existence of a conglomerate of great structural significance. Another, who has dealt principally with conglomerates and seen little of autoclastics, may assume a rock to be a conglomerate without sufficiently considering the possibilities of its being autoclastic. Owing to the bias of preconceived opinions various interpretations of the origin of the fragmental rocks at the base of the Huronian series in the "Original Huronian" district north of Lake Huron for a long time caused controversy and delayed a true understanding of the geology of this important area. The base of the Algonkian in northern Minnesota is made up of fragments of the underlying Archean basalts and porphyries, which still retain their angular form and evidently have been but little worn and transported. Lying unconformably beneath them, and associated with the basalts and porphyries, are various autoclastic and tuffaceous forms so similar in characteristics to the basal conglomerate that even with the application of the most careful criteria, it is frequently difficult or impossible to tell whether a given exposure of rock should be mapped as Algonkian or Archean. In the progress of the mapping the interpretation of the geology has changed from time to time according as these rocks came to be better known.

Autoclastic and clastic rocks should be studied with an open mind, and with an appreciation of the varied possibilities of origin. When, after all criteria have been used, there is still uncertainty, this should be clearly indicated, in order to keep the subject open for further investigation.

EARTHQUAKES

EARTHQUAKES AS CAUSE AND EFFECT OF ROCK FRACTURE

Earthquakes are not in themselves rock structures, but are the accompaniments and results of rock fracturing.

Earthquakes may be also the cause of fracturing. Crosby¹ has argued that earthquakes are one of the important causes of jointing, the joints developing normal to the direction of propagation

¹ Crosby, W. O., *Am. Geol.*, Vol. 12, 1893, pp. 368-375.

of the wave by the tensional component. Intersecting sets therefore would require successive earthquake waves from different directions. He further has shown experimentally that where rocks are already under strain the earthquake wave may bring the stresses beyond the breaking point simultaneously in many parts of the rock mass, the joints occurring in planes determined by the initial strain, or, in a sudden and violent shock, in planes determined by the direction of the earthquake wave. So far as the writer knows, there are comparatively few cases of joint systems which can be definitely proved to be related to earthquakes, notwithstanding the inherent probability that earthquakes accomplish such results, and notwithstanding known associations of earthquakes with a plane or zone of faulting (see p. 58.) Independent of any real bearing that earthquakes may have on jointing, it is to be remembered that the actual stress-strain relations at the point of rupture must fall within the range of the limiting cases of tension and compression already described. So far as the earthquake merely accentuates the strain already present, it is obvious that the strain may be either the result of tension or compression. So far as the earthquake wave itself develops the strain, it seems likely also that both tensional and compressive joints might be expected, although actual proof of one or the other is difficult to cite. Earthquake waves may vibrate parallel or normal to the direction of transmission. Those vibrating parallel to the direction of transmission may cause both compression and tension. The question difficult to answer is, which of these waves, or which component of these waves, first surpasses the breaking strength of the rock? In general rocks may be expected to yield to tension first.

The effects of earthquakes on building and other structures need not be detailed from our point of view, because they do not constitute a part of the geological record under consideration. They are of interest from a geological standpoint as showing the direction of transmission and vibration of earthquake waves, (see page 74) the displacements along faults, etc. The maximum shaking and destructive effects of earthquakes appear to be in loosely consolidated rocks, gravels, and soils which are saturated with water. The reason for this is not entirely clear. It has been suggested that the water affords opportunity for the materials to move

easily, and by filling all the pore spaces that it aids in the transmission of the shock.

Observations taken in sounding and on the breaks in cables following earthquakes have shown that large segments of the bottom of the ocean have dropped hundreds of feet as a result or cause of such shocks. Ordinarily, the accompanying continental changes have been of smaller magnitude and usually uplifts rather than depressions. Continental changes, while considerable, are, as listed by Milne, commonly measured by units of a few feet or a few tens of feet.

Within our zone of observation earthquakes are clearly related to rock fracturing, but it is not certain that they may not also have relation to sudden deformation by rock flowage at points below our observation. When it is remembered how intimate is the association of fracturing and rock flowage, how the two processes seem in some places to go on side by side under the same stresses, it becomes obviously difficult to exclude rock flowage from consideration in connection with earthquakes.

Rock flowage as a *result* of earthquake shock is even more probable. If local stresses are almost of the necessary magnitude to produce rock flowage, it is conceivable that the earthquake shock may carry these stresses past the resistance of the rock and require rock flowage. Also, it may be supposed that rock flowage already started may be accelerated by earthquake shocks.

KINDS OF FRACTURING ACCOMPANYING EARTHQUAKES

It is not easy to correlate earthquake shocks with particular kinds of fractures. It is the natural assumption that faults with great displacements cause great earthquakes, yet so far as historical records go, great earthquakes have sometimes been associated with apparently slight breaks. There is nothing yet to show that earthquakes are associated alone with compressive or with tension fractures. So far as field observations inform us, earthquakes are most frequently related to vertical fissures, but certainly one must suppose that great thrust faults initiate earthquakes. The fact that so many earthquakes can not be definitely connected with fractures at the surface may indicate their relation to thrust faults forming beneath the surface. Milne regards the minor earth-

shakers or "microseisms" as the result of minor settlements near the surface, along previously formed vertical fissures.¹

EARTHQUAKES AND OSCILLATIONS OF GLACIERS

Glacial oscillations have been shown recently to be related to earthquake shocks,² making it possible to interpret certain remarkable advances of glaciers otherwise inexplicable.

EARTHQUAKES AND VULCANISM

There is a relationship between earthquakes and vulcanism, both in time and place. Vulcanism has been accompanied in many places by earthquakes, and vice versa. However, there are many cases of earthquakes not associated with vulcanism, and of many volcanic outbreaks not accompanied by earthquakes. Since vulcanism is now generally regarded as involving mechanical disturbances of the crust, lessening the pressure upon the hot rock, and thereby allowing it to liquefy, it may be reasoned that earthquakes, by disturbing the equilibrium of pressures, may be a local cause of vulcanism. Or, both may result from larger earth movements.

EARTHQUAKES AND MAGNETIC DISTURBANCES

Earthquakes are often, though not always, accompanied by magnetic disturbances. There are still differences of opinion as to whether or not these magnetic disturbances are mere incidents of the mechanical readjustments. There is some evidence that the magnetic disturbance is not entirely related to mechanical changes, suggesting the possibility of some further, and as yet unknown, underlying relationship.

Another interesting relationship, as yet unexplained, is observed between some earthquake zones and regions of permanently steep magnetic gradients of the earth's magnetic field.

EARTHQUAKES AND ROCK DENSITY

Earthquakes are likely to be numerous in regions which show steep rock density gradients, that is, regions in which light and heavy earth masses are in close contiguity.

¹ Milne, John, Seismological observations and earth physics: Geographical Jour. Vol. 21, 1903, page 21.

² Tarr, R. S., and Martin, Lawrence, The earthquakes at Yakutat Bay in September, 1899: Prof. Paper No. 69, U. S. Geol. Survey, 1912.

EARTHQUAKE ZONES

The distribution of earthquakes corresponds with zones of more or less intense deformation or vulcanism or both. In a very general way there are two great earthquake zones, the so-called Mediterranean zone or belt passing through the Himalayas and eastern China, from which have started 53% of the recorded earthquakes; and the Pacific belt bordering the Pacific basin, in which have originated 41% of the recorded earthquakes.¹ More specifically, earthquakes are likely to follow along the margins of continents or of smaller areas of great relief, along mountain chains, especially of recent origin, along volcanic belts, along margins of two areas differing considerably in density, as for instance in the zone of the Messina earthquake, and along areas where there are great irregularities in distribution of the earth's magnetism. It has been ascertained that earthquakes have been especially numerous in the geosynclines of Mesozoic rocks. As many of these rocks have been folded into mountain ranges in comparatively late geological time, this is only a specific case of the abundance of earthquakes in mountains of recent origin.

INSTRUMENTS FOR DETERMINING AND MEASURING EARTHQUAKES

Seismographs are instruments for the detection and measuring of earthquakes. They are made in a variety of forms but are all essentially devices for determining more or less independently the three principal components of a wave, that is, the vibrations in three mutually perpendicular planes. A pendulum makes an automatic record, mechanically or photographically, on a sheet moving at a uniform rate beneath it. The record is a straight line until it is disturbed by an earthquake wave, when the line becomes crenulated. The earthquake wave is expressed in the amplitude and spacing of the crenulations. It is more correct to say that the wave is expressed partly on any one record, for only those components of the wave that are normal to the plane of the pendulum are expressed. In order to get a complete record there must be three seismographs oriented in mutually perpendicular directions.

¹ Montessus de Ballore, F. de, *Les Tremblements de Terre*, Paris, 1906.

EARTHQUAKE WAVES

Earthquake waves are supposed to be (1) compressive or longitudinal, vibrating parallel to the direction of transmission of the shock, and (2) transverse, vibrating normal to the direction of transmission of the shock. Earthquake waves reach a distant point on the earth's surface both by passing along the chord and by going around the circumference, arriving at different times. The circumferential wave travels about one-third as fast as the chord wave. The chord wave travels through the earth's diameter in 22 minutes. The chord waves are regarded as compressive, the circumference waves as transverse. Milne regards it as uncertain whether the circumferential wave is undulatory in vertical dimension, like a wave propelled in water, involving tilting of the surface, or whether it is distinctly a horizontal shaking. The Kingston earthquake sent out two principal shocks. The first of these, the one traveling along the chord, was registered on a seismograph at Washington (almost due north), and principally on the pendulum which vibrated east and west; the wave therefore was vibrating north and south; it was a compressive wave. The second one, traveling along the circumference of the earth, was registered principally on the pendulum vibrating north and south; the wave was vibrating east and west; it was a transverse wave. This is the kind of evidence upon which the directions of earthquake vibrations are determined. It is not always regarded as conclusive.

A third wave may follow at an interval which suggests that it has gone around the longer arc of the earth's circumference. There is evidence of convergence of waves at antipodal points, and of their resurgence to points of observation.

CONDITION OF EARTH'S INTERIOR AS INFERRED FROM EARTHQUAKE WAVES

If earthquake waves have both circumferential and chord paths, their behavior points to certain differences in the physical condition of the media they traverse. Within 600 miles of their origin, the first and second waves are confused. It may be calculated that neither of these waves would get below 12 miles from the surface in traveling to a point within 600 miles. Beyond 600 miles the two waves become sharply separated in time, suggesting that the chord

wave, which now passes more than 12 miles from the surface, is in a different kind of medium. It is possible that in the first instance the waves were passing entirely through the zone of rock fracture; in the second instance the deeper waves were passing partly through the zone of rock flow. Milne also notes that chord waves registered at antipodal stations and therefore traveling along a path nearly through the center of the earth, behave differently from waves passing through intermediate depths or along the surface. The former are much dampened and confused, suggesting still a different physical state at the center. In general, however, the deep or chord waves travel with such a speed as to indicate a rigidity nearly twice that of steel, and their uniform speed argues for homogeneity of the medium traversed.¹

The evidence bearing on the nature and paths of earthquake waves is complex, and agreement has not been reached among seismologists. Some of the principal conclusions of seismologists on the subject have been merely noted.

LOCATION OF THE ORIGIN OF EARTHQUAKES

So far as earthquake shock results mainly from rock fracture, its origin is in the zone of rock fracture and hence probably not far beneath the surface. Doubtless there are readjustments in the zone of flow at the same time, but these may be subsidiary as causes. A shallow depth for the origin of earthquakes has been found wherever it has been possible to determine the directions of emergence of earthquake waves, either from instrumental observations or from the study of the destructive results of earthquake shocks. Nowhere have these determinations indicated a depth of origin greater than 12 miles, and usually less. The very fact that an earthquake shock is usually so well localized at some spot on the earth's surface, that there is some one zone which may be regarded as the locus of activity, is evidence that its origin is not far below the surface. These observations have already been cited as evidence that the zone of rock fracture is not deep. Granting that earthquakes originate in the zone of fracture, it may be argued that their depth of origin at the maximum is about 10 or 12 miles,

¹ Milne, John, *Seismological observations and earth physics: Geographical Jour.*, Vol. 21, 1903, p. 7.

since there is some evidence that the zone of fracture does not generally extend beyond that depth.

In the area most affected by the quake, the origin is located by the intensity of the shock and by noting the direction of emergence of the waves. The area most affected is usually roughly oval or elliptical and within it there is usually a line or spot at which the intensity of the shock is clearly at a maximum. It is assumed that near at hand the waves are both transverse and compressive, that both shearing and tensional stresses are set up in the structures affected, and that the breaking strength is first surpassed by tensional stresses, the dominant one of which would be normal to the direction of transmission of the wave. Hence fracture planes in buildings are regarded as due to tension, and therefore normal to the path of the wave. The plane of fracture is best determined at the corner of a building. Lines drawn normal to these fracture planes in widely distributed areas may tend to converge in a point, or plane, which are then regarded as the origin of the quake. This method is of doubtful value, because the attitude of fractures is so influenced by local conditions, and it is difficult to prove that they are tensional.

The location of the earthquake from more distant points is accomplished mainly by noting the difference in time of the receipt of the principal shocks, chord and circumferential. The greater the difference in time between the receipt of the two the greater the distance from the point of origin. At any one point the distance, not direction, is determined. It needs observations of distance from three points to determine, by the intersection method, the locus of origin.

PREDICTION OF EARTHQUAKES

It has not been possible thus far to predict with any considerable degree of success the time and place of earthquakes. As to place, there is the probability that earthquakes will be confined to certain broad zones in which they have commonly originated in the past. Within an earthquake zone the records seem to show that a great disturbance at one locality may mean that the next disturbance is to be looked for in some other part of the great belt. There have been too many exceptions to this, however, to establish the rule. When one notes the widespread distribution of faults over the

earth's surface, most of them doubtless accompanied in their formation by earthquakes, and considers the possibilities for faulting in the geologic future, predictions as to the localization of earthquakes, based on the meagre records of historical time, can not be accepted with any great confidence.

Attempts to establish a principle of periodicity for earthquakes have been equally futile. Gilbert¹ calls attention to the fact that many attempts at working out the periodicity of earthquakes are apparently successful because the great frequency of earthquakes of some magnitude furnishes examples for any time system postulated.

¹ Gilbert, G. K., Earthquake forecasts: *Science*, Vol. 29, 1909, pp. 121-138.

ROCK FLOWAGE

A rock is said to have flowed when it is deformed without conspicuous fracture, remaining at the end of the deformation an integral body. This interpretation does not exclude minor fractures in the constituent minerals during rock flowage. Rock flowage produces hard and crystalline types. The process is essentially a constructive and integrating one. As here used, it has no necessary relation to fusion, though it is possible that the high pressures involved may cause minerals to melt at comparatively low temperatures.¹

One of the conspicuous results of rock flowage is a slaty or schistose or gneissic structure, giving the rock a cleavage. All such structures are described below under the heading of "Flow Cleavage." In so far as gneissic structure shows banding, without cleavage, as it sometimes does, this is discussed under another head (p. 87). Some rocks flow without taking on either a schistose or slaty or gneissic structure. These are likewise discussed under a subsequent heading. Fracture cleavage or fissility, already discussed, is a phenomenon of rock fracture rather than of rock flow.

FLOW CLEAVAGE²

Flow cleavage is a capacity of some rocks to part along parallel surfaces, not necessarily planes. These surfaces are determined by the parallel dimensional arrangement of the mineral constituents, that is, by the mutual parallelism of the greatest, mean, and least dimensional axes of the mineral particles making up the rock mass. They may also be determined by the parallelism of the *mineral cleavages* of the constituent particles.

A few minerals, such as mica, hornblende, quartz, and feldspar, in various ratios, make up all but a very small percentage of schistose or cleavable rocks. To make the discussion concrete, therefore, cleavage will be discussed principally in relation to these four

¹ Johnston, John, and Adams, L. H., On the effect of high pressures on the physical and chemical behavior of solids: *Am. Jour. Sci.*, vol. 35, 1913, pp. 205-253.

² For fuller discussion see: Leith, C. K., *Rock cleavage*: Bull. 239, U. S. Geol. Survey, 1905, pp. 23-118.

minerals. The technical reader will at once think of qualifications and additions necessary where other minerals are considered, but in the writer's judgment these do not essentially affect conclusions based on the study of a few of the principal schist-forming minerals.

One of the peculiar features of a cleavable rock is the uniformity in shape of the grains of each of the characteristic minerals, determined by their crystal habit. The average ratio of the greatest to the mean dimensions of a mica plate is about 10:1, of hornblende 4:1, and of quartz and feldspar 1.5:1. These ratios are the same whether the rock cleavage is good or poor. In other words, the better rock cleavage does not necessarily mean a greater drawing out or elongation of mineral particles.

When in the laboratory crystals are allowed to develop under stress, they elongate in the plane of easiest relief, supposedly, regardless of habit, but this is not certain, because the experiments have been conducted principally with isometric crystals.¹ Also, crystals not under conditions of growth have been elongated by pressure alone, again more or less regardless of habit. But notwithstanding these experimental results, the minerals in schists have an elongation ordinarily determined by habit alone. The difference between a schist with poor cleavage and one with good cleavage is not so much that the particles of one have been elongated more than the particles of the other, but that it has more of the kinds of particles which by habit are elongated.

There is, in the schists, relative perfection of crystal forms, dependent on the character of the minerals, as compared with igneous rocks, where shape of the minerals depends more largely on order of crystallization. This mineral form and arrangement in schists is the "*crystalloblastic*" structure of Milch² and Grubenmann.³

The parallel dimensional arrangement of the mica and hornblende, and sometimes the feldspar, implies a parallelism of their mineral cleavages, because these minerals tend to occur with definite crystal habit within the rock, and the mineral cleavages are definitely oriented with reference to the dimensional axes.

¹ Becker, G. F., and Day, A. L., Linear force of growing crystals: Proc. Wash. Acad. Sci., Vol. 7, 1905, pp. 283-288.

² Milch, L., Die heutigen ansichten über Wesen und Entstehung der kristallinen Schiefer: Geol. Rundschau, vol. 1, 1910.

³ Grubenmann, U., Die kristallinen Schiefer, part 1, 1904, part 2, 1907.

The orientation of the dimensional axes of the particles therefore carries with it an orientation of the mineral cleavages. Mica crystals, for instance, lying dimensionally parallel in a schist, have their mineral cleavages in the plane of the two greater dimensional axes, that is, in the plane of rock cleavage. Hornblende crystals lie with their long dimensional axes parallel; the mean or least dimensional axes of hornblende crystals, being so nearly of the same length, may not be parallel. The two cleavages of hornblende are parallel to the major dimensional axes, but are inclined to the minor dimensional axes. Thus the hornblende cleavages in the schistose rocks are parallel to an axis, but not to a plane. The feldspar habit does not give such great dimensional differences. Most of the feldspars in schist show only a slight tendency to assume elongated or tabular shapes due to crystal habit. Their dimensional arrangement is more or less independent of crystallographic arrangement and therefore there is only a slight tendency toward parallelism of the feldspar cleavages.

The dimensional elongation of mica and hornblende parallel to their cleavage faces in schists has been cited as indicating some sort of genetic relationship between mineral elongation and mineral cleavage.¹

A schistose rock cleaves either between the mineral particles, following the plane of their greatest and mean dimensional axes, or within the mineral particles along their cleavage planes. The first is known as inter-mineral cleavage, and is a capacity to part determined by the dimensional arrangement of mineral particles; the second may be called inter-molecular cleavage, and is related to the ultimate molecular structure of the crystal. Ordinarily when a rock is cleaved the two surfaces show the glistening faces of hornblende or mica or of other minerals of this type, indicating that the break has followed the mineral cleavages. The parting here has obviously been easier than between the mineral particles. In places where mica and hornblende are not abundant, the cleaved surfaces of the rock show quartz and feldspar, indicating that the breaking has been principally of the inter-mineral type.

Whatever the relative importance of inter-mineral and inter-molecular cleavage, it should be remembered that all mineral

¹ Trueman, J. D., The value of certain criteria for the determination of the origin of foliated crystalline rocks: *Jour. Geol.*, Vol. 20, 1912, pp. 228-258, 300-315.

particles in cleavable rocks are dimensionally arranged, and that this dimensional arrangement involves parallelism of the mineral cleavages only for part of the minerals. Therefore the conclusion is justified that the dimensional parallelism of mineral particles is the controlling factor in rock cleavage; that to this control is due the mutual parallelism of mineral cleavages of mica or hornblende cleavages. Nevertheless it may to some extent be true that the cleavages of these minerals have some influence on their elongation, and therefore on their arrangement. As the dimensions of the minerals of schists are controlled by mineral habit, this becomes an important factor in the structure of schists.

MANNER IN WHICH THE PARALLEL ARRANGEMENT OF MINERALS IS BROUGHT ABOUT

The arrangement of the mineral constituents of a cleavable rock is the result of the differential pressure, which caused the rock to flow. The conditions under which this occurred are discussed on pp. 4-10. Briefly, the general conditions of rock flowage have been found to be great pressure from all sides, high temperature, abundance of altering solutions, susceptibility of the rock to mineral and chemical change depending on its composition, and slow deformation; in other words, rock flowage, judging from the field and laboratory evidence, is accomplished by means of physical and chemical changes combined. These general observations do not indicate just in what manner the parallel arrangement of mineral constituents producing the cleavage, the most conspicuous result of rock flowage, has been accomplished.

Recrystallization.—A study of cleavable rocks shows that much of the hornblende and mica, minerals which are responsible for some of the best rock cleavage, is of entirely new generation in the secondary rock. A shale or mud may have no mica; a phyllite, its altered equivalent, may have as high as 50%, by weight, of mica. Chemical analysis shows that this change may occur in some instances with little addition or subtraction of materials. A correct inference is that the new minerals of the hornblende and mica types have developed principally from the recrystallization of substances already in the rock mass. Even where there is quantitative evidence that substances have been introduced or extracted, the mass has still been recrystallized. Since hornblende

and mica are the common minerals producing the best rock cleavage, it must be concluded that recrystallization is the important process in the development of parallelism of the mineral constituents.

Corroborative evidence of the importance of recrystallization is the general lack of fractures or other strain effects in the minerals of a cleavable rock, such as would be expected if the parallelism had

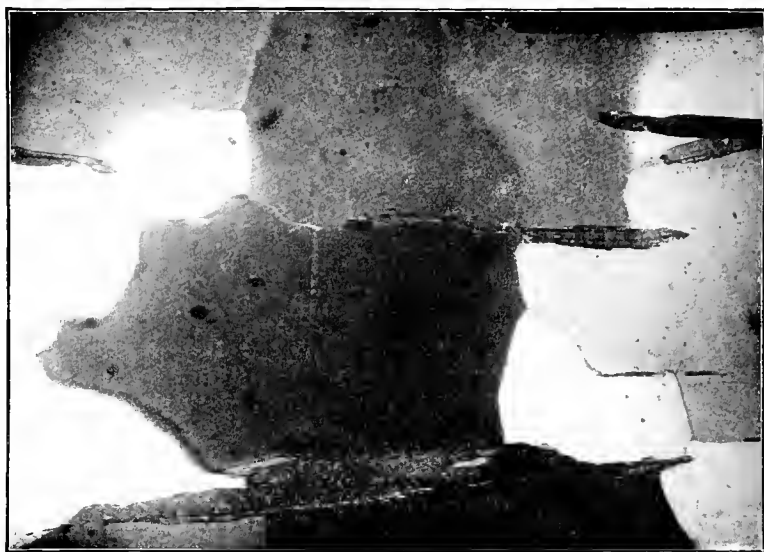

FIG. 38. Photomicrograph of micaeous and quartzose schist showing recrystallized quartz. From Hoosac, Mass. The view illustrates in detail the relation of recrystallized quartz grains to recrystallized mica flakes. The mica flakes for the most part separate different quartz individuals, but they may be seen to bound two or more individuals and to project well into them. It is not probable that such a relation could be brought about by granulation, slicing, or gliding, and it seems best explained by recrystallization.

been brought about entirely or largely by mechanical processes. It may be inferred, then, that some constructive process, which may be called generally recrystallization, has been at work.

Most of the mineral particles in the cleavable rocks are individually larger than the particles in the same rocks before flowage had occurred. For instance, the gradation of a shale to a phyllite means an increase in the size of the grains. Recrystallization is the constructive process which has accomplished this result.

The cleavable rock is likely to show a great uniformity in size and shape of the grains of the same mineral as compared with the non-schistose rock, and again recrystallization explains the phenomenon.



FIG. 39. Photomicrograph of micaceous schist from Hoosac tunnel. The micas, which are entirely new developments by recrystallization, lie in flat plates with their greater diameters roughly parallel. Each individual exhibits several twinning lamellae. It will be noted that, while there is apparently a bending and irregularity in the mica plates, the individuals are for the most part not deformed, and the impression of irregularity is caused by the individuals feathering out against one another at low angles. This sort of arrangement is frequently seen about rigid particles which have acted as units during deformation, indicating that the arrangement is due to differing stress conditions at different places.

Much detailed microscopical evidence might be cited, such as dove-tailing of quartz individuals in quartz bands, the feathering out of mica plates against an adjacent mineral surface, the lack of bending and breaking of hornblende needles by mutual interference, the segregation of minerals into bands, to show that the parallelism could not have been produced by mechanical adjustment

alone, but must have been aided by the chemical and mineralogical changes involved in recrystallization. (See Figs. 38, 39 and 43.)

Granulation and rotation of original particles:—But recrystallization is not the only process instrumental in the production of rock cleavage. The quartz and feldspar in the cleavable rock may be



FIG. 40. Photomicrograph of schistose quartz-porphry showing sliced feldspar phenocryst in planes inclined to the prevailing cleavage. After Futterer. (Fig. 2, Pl. III of *Ganggranite von Grosssachsen und die Quarzporphyre von Thal in Thüringer Wald*: Mitt. Grossh. Badischen geol. Landesanstalt, Vol. 2, Heidelberg, 1890.)

largely original quartz and feldspar; some of the mica and hornblende also may be original. Parallelism may be partly due to rotation from original random positions. This process may be aided by granulation and slicing of the original mineral particles. Broken, unequidimensional mineral fragments are often strewn out in such a manner that their longer dimensions lie approximately parallel. Evidence of rotation is seen principally in the quartz

and feldspar, which have not much effect in producing rock cleavage. It is concluded, then, that the rotation of original particles, diversely oriented, to a parallel position is a minor factor quite subordinate to the dominant process of recrystallization. (See Figs. 40, 41, 42 and 43.)

In the incipient stages of rock flowage the larger and more brittle particles are granulated and elongated. At the same time recrystallization, beginning on the finer particles, builds up new minerals. In the intermediate and advanced stages it gradually dominates over granulation and ultimately obliterates any evidence of it. It may be inferred that granulation aids recrystallization in

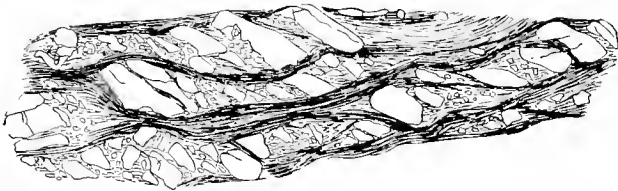

FIG. 41. Sliced feldspars in micaceous and chloritic schist from southern Appalachians.

that it grinds the particles into small pieces and affords greater surface upon which the chemical process may act.

In experimental deformation the conditions are not favorable for recrystallization, and granulation is the important process.

Slipping or twinning along the cleavage planes of minerals, called "gliding"—such as may be observed in calcite and ice crystals—has been cited as a possible cause of the elongation and parallel arrangement of mineral particles. This has been observed only in minerals of the calcite type, which are not important in cleavable rocks; and even in the calcite of schistose rocks gliding has been found to be subordinate to processes of recrystallization and granulation. In experimental deformation of marble it seems to play a greater part, because conditions of recrystallization are not present.

There is no evidence that the flattening of original mineral particles to a dimensional parallelism, without regard to crystallographic arrangement, has played any important part in the production of rock cleavage; indeed, some of the facts already cited

constitute decisive evidence to the contrary. Such is the evidence that hornblende and mica, essential minerals of schistose rocks, are in many cases, and perhaps in most cases, entirely new developments in the rock. Of the same nature is the evidence derived from the uniformity of dimensional characteristics of the particles of a given mineral species and the control of dimensions by crystal habit. The most cleavable rock is not made up of flatter particles of hornblende, mica, quartz, or feldspar than the less cleavable rock. But it certainly contains more particles of hornblende and mica than of quartz and feldspar; consequently it has more particles which are flat or elongate, which give it a better and smoother cleavage.

If this is true, the development of rock cleavage would seem to require change in chemical composition necessary to increase the proportion of the cleavage-making minerals, such as hornblende or mica. Chemical evidence seems to the writer to point this way, though it is not yet sufficient for proof.

CLEAVAGE IN ITS RELATIONS TO DIFFERENTIAL PRESSURES

It has been shown that rock cleavage is determined by the parallelism of mineral constituents and that this parallelism is developed by rock flowage, which implies differential pressures. It now remains to discuss the attitude of cleavage with reference to specific pressure conditions.

What experimental evidence there is indicates that in a non-rotational strain (see page 16) mineral particles tend to arrange themselves with their longest dimensions normal to the direction of the pressure. There is practically no experimental evidence bearing on the arrangement of particles under rotational strain or shearing, so common in nature.

Wright¹ melted about 50 grams each of wollastonite, diopside, and anorthite, and plunged the melt into water, thereby forming a glass. Cubes were then cut from these glasses, heated to a viscous state at which crystallization first begins, and subjected to vertical pressure. Microscopic examination showed that the three minerals named had crystallized with their longer dimensional axes normal to the pressure.

¹ Wright, F. E., Schistosity by crystallization. A qualitative proof: *Amer. Jour. Sci.*, 4th ser., Vol. 22, 1906, p. 226.

Becker and Day¹ have shown that although crystals are able to grow in a given direction in spite of contracting forces, their growth in the plane normal to the pressure is vastly greater, whether this be the normal direction of elongation due to habit or not. Ordinarily in schists the elongation of the crystal is that of its normal habit, indicating perhaps that the crystals favorably oriented to grow with normal habit have grown at the expense of those not favorably oriented.

Relations of cleavage to strain:—Field observations have to do principally with the relation of cleavage to rock *strain* (see page 14), which can be seen, and not with *stress*, which can not be seen and may only be inferred from the strain. After having proved the relation of cleavage to strain, the general relations of strain to stress may be considered.

It seems self-evident that the longer dimensions of mineral particles in a cleavable rock lie parallel to the elongation of the rock mass developed during rock flowage. This relationship has been so generally assumed by geologists that at first thought it would seem entirely superfluous to present evidence in proof of it. But it has been questioned by able geologists. Becker² has held that the elongation of the rock mass may be inclined to the common direction of the major axes of the mineral particles. The student, when asked how he knows that cleavage is parallel to rock elongation, is often completely at sea. It is simply a matter of observation to determine definitely whether the cleavage is parallel to the elongation of the mass as a whole. Evidence indicating this parallelism is as follows: (1) *Distortion of pebbles of a conglomerate.* Schistose conglomerates show by the distortion of their pebbles the plane of elongation, although it may sometimes be difficult to distinguish the shapes of undeformed pebbles from those of deformed ones. The cleavage of the matrix is approximately parallel to the greater diameters of the flattened pebbles, although it curves somewhat at the ends of the pebbles. (2) *Distortion of mineral crystals.* The plane of cleavage is marked by mica plates or hornblende crystals, while the associated quartz and feldspar particles may be fractured at angles with the plane of cleavage.

¹ Becker, G. F., and Day, A. L., The linear force of growing crystals: Proc. Wash. Acad. Sci., Vol. 7, 1905, pp. 283-288.

² Becker, G. F., Current theories of slaty cleavage: Amer. Jour. Sci., 4th Ser., Vol. 24, 1907, pp. 7-10.

The displacement of the parts, which often accompanies such fractures, is observed to extend the fractured parts in the plane of rock cleavage. (3) *Distortion of volcanic textures*. The original ellipsoidal parting of basalts frequently shows a flattening, with or without fracture; in such cases the ellipsoids and the matrix have a flow cleavage parallel to the longer diameters. The elongation of amygdules and spherulites in planes parallel to the rock cleavage is likewise of common occurrence. (4) *Distortion of fossils*. The elongation of fossils in the plane of cleavage has been observed in cleavable rocks. (5) *Distortion of beds and attitude of folds*. Folds often show the direction of shortening of the deformed rock mass. (6) *Relations to intrusives*. Intrusions of great masses of igneous rocks, and particularly deep-seated batholiths, exert pressure against their walls. Any cleavage developed in the surrounding rocks is parallel to the periphery of the intrusive masses.

It is concluded then that the longer dimensions of mineral constituents are parallel to the directions or planes of elongation of the rock mass. Thus an adequate statement of the relations of rock cleavage to the stresses which have produced it must be a statement which will cover the various ways in which stress has elongated and shortened rock masses.

Relations of cleavage to stress:—In the simplest possible terms stress has been effective in distorting rock masses (1) (see pp. 16–21) by non-rotational strain, in which the axes of stress and strain remain mutually constant throughout the deformation, and (2) by rotational strain in which there is a continuous change in the position of the strain axes as compared with the stress axes during the distortion. In the first case the elongation of the rock mass is normal to the greatest stress and remains so through the deformation; in the second case the elongation of the rock mass is constantly changing in direction with reference to the principal stress, and ultimately the elongation may be considerably inclined to the maximum stress. It is held by Hoskins¹ that at any instant the tendency for elongation is approximately normal to the greatest stress, but that the rotational tendency results in inclining the final elongation to the greatest stress.

Substituting rock cleavage for greatest elongation of the rock

¹ Hoskins, L. M., Flow and Fracture of rocks as related to structure: 16th Ann. Rept. U. S. G. S., Pt. I, 1896, pp. 845–874.

mass, the statement of the relations of cleavage to pressure is as follows: In a non-rotational strain cleavage is developed normal to the greatest stress; in rotational strain, while at any instant there may be a tendency for it to be developed normal to the greatest stress, there is here a rotational element which brings it into position inclined to the greatest stress. All distortional strains in rock masses belong to these two classes, rotational and non-rotational, and usually to some combination of the two. Cleavage, therefore, is developed under some combination of rotational and non-rotational strains and may be said to be produced both normal and inclined to pressures.

Specific inferences from field observations as to the pressure conditions controlling cleavage are discussed on pp. 119 and 128 in connection with folds.

GNEISSIC STRUCTURE

Gneissic structure means a banding of constituents, of which feldspar is important, with or without the parallel dimensional arrangement necessary for rock cleavage. A schist always has a parallel dimensional arrangement and may or may not contain feldspar. A gneiss may or may not have a parallel arrangement, but always has a banding and contains feldspar. So far as this parallel arrangement is present, gneissic structure has been discussed under the heading of rock cleavage. In many cases, however, cleavage in gneisses is not good. The essential mineralogical difference between gneisses and schists is the possession by the gneisses of a relatively small amount of the platy and columnar minerals so necessary for a good rock cleavage, and correspondingly more feldspar and quartz.

The origin of perhaps the majority of gneisses is not yet known. In a few instances the structure has been identified as an original magmatic flow structure, the "protoclastic" structure. In other cases it is the result of secondary rock flowage, either of igneous or sedimentary rocks, the "crystalloblastic" structure. Some criteria which have been useful in discriminating the igneous and sedimentary gneisses resulting from rock flowage are the broader field relations, the chemical composition, the possession of igneous or crystalloblastic textures, and the content and form of the heavy

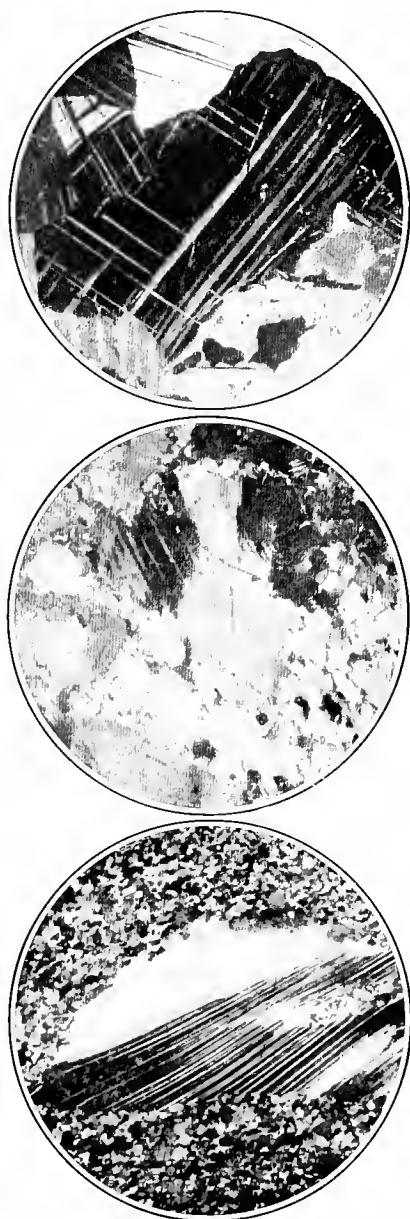

FIG. 42. Photomicrographs showing the progressive granulation of the Morin anorthosite under the influence of pressure. After Adams.

residues such as zircon.¹ These criteria may often be decisive when applied collectively, but seldom when used separately. They are discussed on a subsequent page (97).

Gneisses have been known to develop by rock flowage from rocks which under other conditions have yielded schists. What,

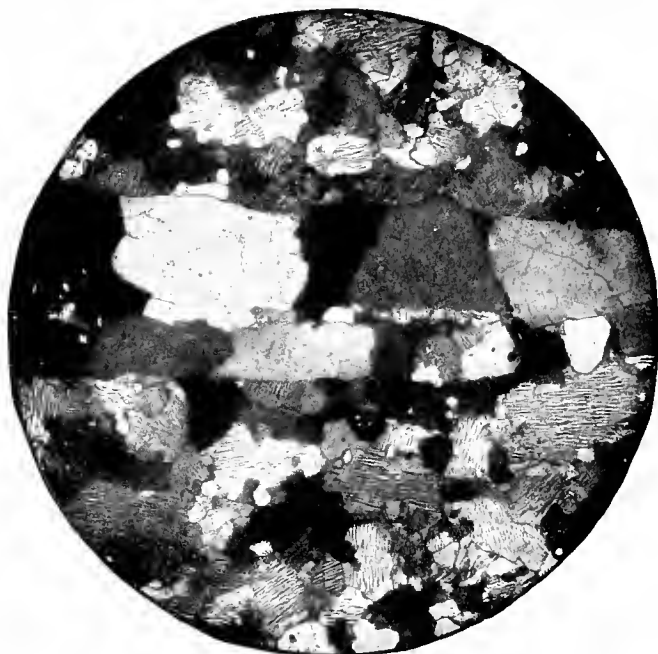

FIG. 43. Photomicrograph of leaf gneiss from the Laurentian area north of Montreal. Slide furnished by Frank D. Adams. Doctor Adams has described the leaf gneiss as resulting from granulation of a hornblende granite, all stages of the process having been noted. (See Part J of Vol. VIII of the Geological Survey of Canada, 1895.) The striated feldspars have irregular angular shapes such as characteristically result from granulation. The two bands of quartz crossing the slide evidently owe their form and arrangement finally to recrystallization, although granulation may have been an important initial process. It will be noted that the quartz individuals have dimensional but not crystallographic parallelism.

then, are the conditions which determine whether the gneissic or the schistose structure will result from the rock in question? Study of all analyses available of schistose and gneissic rocks

¹ Trueman, J. D., The value of certain criteria for the determination of the origin of foliated crystalline rocks: Jour. Geol., Vol. 20, 1912, pp. 228-258, 300-315.

indicates a higher percentage of moisture for the schists than for the gneisses. The moisture is concentrated largely in the tabular and columnar minerals which so largely determine rock cleavage. Many schists are found along shearing planes in non-schistose types. Water has been allowed access here by means of the fractures. Other schists represent anamorphosed sediments which originally contained a good deal of water. The principal change in the development of secondary gneissic structure is one of granulation and recrystallization of substances present, not the development of new tabular or columnar minerals requiring water. A good illustration is the case of the sheared anorthosites, or gneisses, described by Adams¹ as developing from fresh anorthosites entirely by granulation accompanied by a minimum of recrystallization and consequent development of hornblende and mica. (See Fig. 42.) Adams also has experimentally deformed diabase, under dry conditions unfavorable for recrystallization. The deformation was principally by granulation. The result was a gneiss.

If water is essential to the development of the best cleavage-giving minerals, it may be argued that its absence may be responsible for the lack of development of a good cleavage during rock flowage. Although it is not proved, it seems entirely plausible that many of the gneisses, especially if they developed from granite, have been formed under deep-seated conditions unfavorable either to the original presence of water or to its introduction during deformation. There may be other and more decisive factors, as yet unknown.

IDIOMORPHIC OR PORPHYRITIC TEXTURES DEVELOPED BY ROCK FLOWAGE

Garnet, staurolite, tourmaline, andalusite, chloritoid, and other heavy anhydrous minerals of this kind are uniformly idiomorphic or porphyritic in cleavable rocks. They develop by recrystallization after rock flowage has ceased, but probably while the rock is still under high pressure and temperature, as is evidenced by their high specific gravity and characteristic

¹ Adams, F. D., Report on the geology of a portion of the Laurentian area lying to the north of the island of Montreal: Ann. Rept. Geol. Survey of Canada, Vol. 8, pt. J, 1896, p. 85 et seq.

occurrence in the proximity of intrusive igneous rocks. Their late development by recrystallization is shown by the following considerations: (1) They appear in rocks clearly derived by rock flowage from others originally lacking such minerals. (2) They frequently lie at large angles to the prevailing cleavage in the rock. (3) They do not show the degree of mechanical deformation that they would necessarily have possessed had they developed in their present positions before flowage had ceased. Many



FIG. 44. Photomicrograph of chloritoid crystal in micaceous and quartzose schist from Black Hills. The chloritoid crystal here shown has developed later than the rock flowage producing the prevailing cleavage of the rock. The chloritoid has grown at the expense of the other constituents of the rock, using all the material necessary for its growth and leaving the excess of material in the form of inclusions, which retain their dimensional parallelism with the prevailing rock cleavage.

of the crystals are long and acicular, and would surely have been broken if any considerable movement had occurred subsequent to their development. (4) They include, within their boundaries, minerals in part similar to those in the remainder of the rock, and which have an arrangement of their greater diameters in the

plane of rock cleavage, showing that to some degree at least they were formed during rock flowage. (5) The mica and the other constituents of cleavable rocks, which are certainly developed by recrystallization during the process of deformation, are frequently seen to end abruptly at the periphery of a mineral of this group and not to curve around it as they often do about the resistant minerals in schists. If the rock had flowed after the formation of the porphyritic crystals, crowding and bending of the micas must inevitably have occurred. (6) The usual large size of minerals of this group, as compared with their associated mineral particles, suggests their development subsequent to rock flowage, when granulation is no longer tending to break down the crystals.

While the development of this group of crystals is believed to have been mainly later than the formation of the cleavage, it is true also that in some cases subsequent flowage has resulted in their being fractured and crowding the other constituents. The very fact that the effects of further movement are so conspicuous confirms the conclusion that the secondary porphyritic minerals not showing these effects developed after the movement ceased.

We may only speculate as to the conditions of this peculiar development of non-arranged minerals. They are probably high temperature and pressure, but apparently no differential stress, requiring movement. If the pressure and temperature may be considered as having become so great as to develop hydrostatic conditions, there would be no differential pressures necessary for a parallel arrangement of constituents and this might afford a plausible explanation of the development of these non-oriented porphyritic minerals.

ROCK FLOWAGE WITHOUT RETENTION OF CLEAVAGE

Marble is the commonest example of a rock which undergoes flowage without retaining cleavage. It often occurs between schistose beds which have flowed, without doubt the marble itself has flowed, and yet it possesses no cleavage. Cleavage may be produced experimentally in marble by pressure alone, when the conditions are not favorable for recrystallization.¹ Microscopic

¹ Adams, F. D., and Nicolson, J. T., An experimental investigation into the flow of marble: *Phil. Trans. Roy. Soc. of London*, Vol. 195, 1901, pp. 363-401. See also Adams, F. D., and Coker, E. G., The flow of marble: *Amer. Jour. Sci.*, Vol. 29, 1910, pp. 465-487.

examination indicates that this has been accomplished by granulation, slicing, and gliding of the calcite crystals. Rarely such a cleavage is observed in marble deformed under natural conditions. It may be supposed that many marbles have shown this structure in the early stages of their flowage, but calcite recrystallizes so easily that the parallel structure caused by mechanical deformation is soon destroyed. The recrystallized calcite crystals do not have the habit necessary for a good dimensional arrangement in schists.

So far as the limestones have impurities in them, secondary silicates are likely to develop, such as actinolite and tremolite, which by their arrangement may give the rock a cleavage.

OBLITERATION OF TEXTURES BY ROCK FLOWAGE

Recrystallization, the dominant process in rock flowage, tends toward an increase in the size of grain, the segregation of minerals into bands, a uniformity in size and shape of the mineral particles, and the growth of new minerals such as mica or hornblende not previously existent in the rock. Previous textures are commonly destroyed. Bedding is locally not completely obliterated, because alternation of beds of originally different mineralogic character and texture determines to some extent the kinds and size of the secondary mineral particles formed in these beds by rock flowage. Thus a faint banding of dark or light minerals or of fine or coarse minerals may mark the original bedding in a schistose rock. (See Figs. 45, 46 and 47).

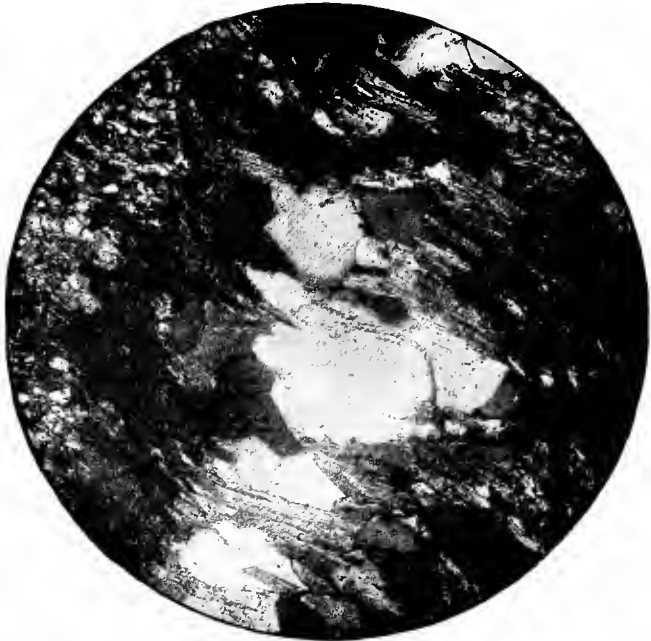

FIG. 45. Photomicrograph of micaceous and quartzose schist with cleavage developed across original bedding, from Little Falls, Minn. A graywacke-slate, in which the banding has been marked by difference in texture as well as in composition, has been subjected to deformation, with the result that a cleavage has been superposed at right angles to the original bedding. Originally the longer diameters of the particles of the bedded rock were parallel to the bedding. Accompanying the development of flow cleavage most of the constituents of the rock have been recrystallized. The quartz particles shown in the light band have been drawn out with their longer diameters nearly at right angles to the former plane of their longer diameters, and abundant new mica has developed with its greater diameters and mineral cleavage normal to the plane of bedding.



FIG. 46. Cleavage crossing bedding of slates, St. Louis river, Minnesota. The broad plane surface dipping to the right is a bedding plane. The structure dipping more steeply to the right is cleavage.

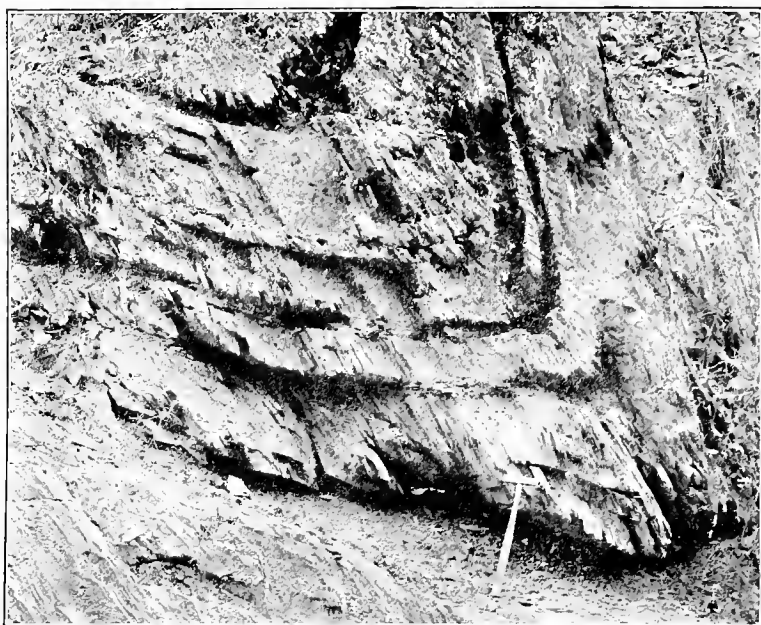

FIG. 47. Slaty structure and its relation to bedding planes. Two miles south of Walland, Tenn. After Keith.

IDENTIFICATION OF SCHISTS AND GNEISSES

Not only does rock flowage tend to obliterate primary textures but it modifies the chemical and mineralogical composition.

In proportion, then, as rocks have undergone rock flowage, there may be difficulty in ascertaining their origin. The identification of the origin of schists and gneisses is more largely a metamorphic than a structural problem, but it is difficult to separate the two phases of the problem. Both are covered in the following summary of criteria.

FIELD RELATION AS A MEANS OF IDENTIFYING SCHISTS AND GNEISSES

Field and microscopic observation of gradations from undeformed rocks into schists or slates gives certain empirical methods for recognition of origin of some schists and gneisses. For instance, a shale alters to a slate and this in turn to a phyllite. While it is difficult from the study of the phyllite alone to determine its origin, it so often has been observed as the end-product of this series of changes that there is little danger of mistake if it is referred back to a shale or a mud. A sandstone or quartzite may be traced into a mica-quartz-schist, seldom into a hornblende schist. A similar schist may be derived from the secondary deformation of certain acid igneous rocks. A quartz-mica-schist therefore is regarded as the natural development of an acid rock, but whether sedimentary or igneous may be doubtful, when field relations do not decide. A basalt is observed to grade into a chloritic and micaceous schist. The same result may be observed where certain shales are altered. Basic igneous rock (especially in the vicinity of intrusives) by rock flowage may pass into coarsely crystalline hornblende schists or gneisses. Amphibolites are known to be formed also by alteration of limestone. Some banded gneisses, by their association with, and gradation to, granites, and by their mineralogical composition, seem to be surely the result of rock flowage of a granite, though cases of proved gradation are rare. It has been observed, however, that certain sediments, such as an impure quartz sand, have gone over to gneisses with general aspects similar to those presumably developed from a granite. The passage of a dolomite into a talc schist is not uncommon.

Schists or gneisses may be interbedded with sediments and be themselves in beds strongly suggestive of sedimentary origin. They may be in an igneous complex and have irregularity of form or distribution or relations to adjacent rocks more characteristic of an igneous mass than of sedimentary beds. Some gneisses of the Laurentian are clearly original igneous rocks intrusive into adjacent rocks. Where the schist or gneiss shows marked differences in composition in different beds or bands, and this composition is persistent throughout these bands for long distances, it is suggestive of sedimentary origin, especially if some of the beds have mineral or chemical composition of sediments. The Baltimore and Carolina gneisses of the Piedmont Plateau,¹ and the Idaho Springs formation of the Georgetown area of Colorado² are of this type. Yet analogous structure has been produced, perhaps on a smaller scale, by injections of igneous masses along parallel planes.

On the whole, with our present knowledge, field observations are likely to yield more satisfactory conclusions as to origin than other criteria below discussed.

MINERAL COMPOSITION AS A MEANS OF IDENTIFYING SCHISTS AND GNEISSES

A great preponderance of quartz is perhaps more often characteristic of a sedimentary than an igneous rock. Where a gneiss or schist is dominantly quartz, one looks for other evidences of sedimentary origin. But the existence of highly quartzose rocks of the pegmatite and alaskite types makes quartz content alone a doubtful criterion. Preponderance of calcite is more satisfactory evidence of sedimentary origin.

The abundant development of aluminum silicate minerals such as staurolite and sillimanite³ has been more commonly ob-

¹ See: Keith, Arthur, Washington folio (No. 70), Geol. Atlas U. S., U. S. Geol. Survey, 1900.

Mathews, E. B., Correlation of Maryland and Pennsylvania Piedmont formations: Bull. Geol. Soc. Am., Vol. 16, 1905, pp. 329-346.

Bascom, F., Piedmont district of Pennsylvania: Bull. Geol. Soc. Am., Vol. 16, 1905, pp. 289-328.

² Spurr, J. E., and Garrey, G. H., Economic geology of the Georgetown quadrangle, Colorado: Prof. Paper U. S. Geol. Survey No. 63, 1908, p. 44.

³ Emmons, W. H., and Laney, F. B., Preliminary report on the mineral deposits of Ducktown, Tenn.: Bull. 470, U. S. Geol. Survey, 1911, p. 158.

Spurr, J. E., and Garrey, G. H., Economic geology of the Georgetown quadrangle, Colorado: Prof. Paper U. S. Geol. Survey No. 63, 1908, p. 44.

served in metamorphosed sediments than in igneous rocks. Any of these minerals, however, may be found also in igneous rocks.

Where gneiss is strongly feldspathic, it is not likely to be regarded as of sedimentary origin. Yet so far as the sediment is undecomposed, it may be largely feldspathic, and also the anamorphism of a nonfeldspathic sediment might make it feldspathic, though it is a question whether to a degree common to many gneisses.

The presence of graphite disseminated evenly through a band or zone becomes presumptive evidence of sedimentary origin, especially where, as in the Adirondack graphites, there are other evidences present.¹ Some graphite may be igneous in origin, but when evenly distributed in amount up to about 6% in a generally slaty or quartzose zone, the hypothesis of igneous origin becomes untenable.

Mica or chlorite or hornblende affords no satisfactory criterion of identification of origin, for these minerals develop both from sedimentary and from igneous rocks. But so far as present evidence goes, they seem to develop more readily from sediments than from igneous rocks, perhaps because water is necessary. This criterion must be most carefully used, in view of the fact that sedimentary composition may be approached by the weathering of igneous rocks prior to anamorphism. The basalts of the Menominee district described by George H. Williams alter by katamorphism into chloritic rocks and under pressure alter to chlorite-schists. The mineral change from the fresh rock is the same in both cases. It may be that the chlorite-schist was preceded by katamorphism of the basalt.

The separation of minute accessory constituents by washing is a means for identifying origin which has not yet been sufficiently used. In deeply weathered rocks like those of central Brazil this method has been used effectively by Dr. Derby and associates in determining whether the weathered material is igneous or sedimentary.² Minerals of igneous rocks like monazite, zircon, sphene, garnet, and so on, are remarkably resistant to weathering, and will remain in well defined crystals when all the other constituents have

¹ Bastin, E. S., Origin of certain Adirondack graphite deposits: *Econ. Geol.*, Vol. 5, 1910, pp. 134-157.

² Derby, O. A., On the separation and study of the heavy accessories of rocks: *Proc. Rochester Acad. Sci.*, Vol. 1, 1891, pp. 198-206.

altered. When these are found unmodified in the weathered rocks, it is assumed that the rock is of igneous origin. The argillaceous sediments lack these substances. Quartzites may possess them, but they are there likely to show distinct wearing by attrition. In the schistose equivalent of the quartzite the rounded grains persist, particularly in zircon. Where, therefore, in an argillaceous schist these heavy accessory minerals are lacking or in a quartz schist are rounded, a sedimentary origin is probable.¹

CHEMICAL COMPOSITION AS A MEANS OF IDENTIFYING IGNEOUS OR SEDIMENTARY ORIGIN OF GNEISSES AND SCHISTS

If the composition of a schist or gneiss is substantially that of an igneous rock, their igneous origin is usually regarded as probable at first thought, yet the basis for this supposition is an unsatisfactory one, for so far as sediments are produced from igneous rocks by disintegration rather than decomposition, the primary composition of the sediments approaches that of the igneous rocks. Also facts have been found to show that the general tendency of anamorphism of sediments is toward the reproduction of the composition of igneous rocks, both by dynamic and contact metamorphism. The tendency is not known fully to accomplish this result, but certainly it approaches it closely enough to give a composition which is not so different from that of the igneous rock that it may be certainly classed as sedimentary. So far as quantitative evidence yet goes, igneous composition of a schist may indicate igneous origin, it may indicate that the schist came from a sediment of igneous composition, or it may represent an extreme of anamorphism of sediments which has tended to reproduce igneous composition in them.

If the composition of the schist or gneiss is that of a sedimentary rock, it has been somewhat generally assumed that this proves the sedimentary origin of the schist or gneiss.² Distinctive features of sedimentary origin, as summarized by Bastin,³ are dominance of

¹ Trueman, J. D., The value of certain criteria for the determination of the origin of foliated crystalline rocks: *Jour. Geol.*, Vol. 20, 1912, pp. 244-258.

² Adams, F. D., Geology of a portion of the Laurentian area lying to the north of the island of Montreal: *Ann. Rept., Geol. Survey of Canada*, Vol. 8, part J, 1896, p. 57 et seq.

Adams, F. D., and Barlow, A. E., Geology of the Hailburton and Bancroft areas, Ontario: *Geol. Survey Can., Mem. No. 6*, 1910.

³ Bastin, Edson S., Chemical composition as a criterion in identifying metamorphosed sediments: *Jour. Geol.*, Vol. 17, 1909, p. 472.

magnesia over lime, of potassa over soda, excess of alumina, and high silica. To these must be added all other known chemical peculiarities of sediments. These criteria should be used with knowledge and consideration of the general chemical processes involved in the development of sediments. However, so far as an igneous rock is katamorphosed before or after it becomes schistose, its composition approaches that of a sediment, in which case the composition might be that of a sediment and yet the rock may never have been a sediment. Bastin recognizes this possibility, but considers it of minor significance. Some schists and gneisses develop from igneous rocks and retain original igneous composition. It is known that others do not. It has not yet been proved which is the common case, but quantitative evidence is less satisfactory for the former than for the latter. Plutonic rocks may be less katamorphosed than volcanics prior to anamorphism, but direct evidence of this is not available. In addition to surface weathering it is necessary to include all hydration and solution which may take place in the zone of fracture, and also hydrothermal alteration which has essentially the same chemical effect as weathering as far as lime-magnesia and soda-potassa ratios are concerned. The conclusion that a sedimentary composition of a gneiss or schist means sedimentary origin is based simply on the fact that some igneous rocks become schistose or gneissic without change in composition and ignores the equally well established fact that others have approached the sedimentary rocks in composition prior to or during or after the alteration to schist or gneiss. Application of the chemical criteria for sedimentary origin outlined by Bastin to the green schists of the Menominee district of Michigan, shown by Williams¹ and others to be largely schistose basalts, illustrates the uncertainty of these criteria in determining origin. Under these criteria, part of Williams' analyses are those of sediments, part are those of igneous rocks, and part have intermediate characters.

Chemical composition, therefore, in the present state of knowledge, must be regarded as an extremely uncertain basis for determining igneous or sedimentary origin. If the composition is that of an igneous rock, it is plausible to assume that the probability

¹ Williams, G. H., The greenstone schist areas of the Menominee and Marquette regions of Michigan: Bull. 62, U. S. Geol. Survey, 1890.

slightly favors igneous origin, but the same composition may be possessed by a sedimentary rock, either because of its primary character or because of composition which has been induced in it by anamorphism. If the composition of the schist or gneiss is that of a sedimentary rock, the balance of probability would perhaps slightly favor its sedimentary origin, but igneous rocks are known also to take on this composition, either prior to or during their anamorphism. When vastly more chemical analyses of well selected sets of rocks become available to show specifically the range of chemical changes in anamorphism of both igneous and sedimentary rocks, it may be possible to use chemical criteria which will aid in determining the origin of the schists and gneisses.

CONCLUSION AS TO METHODS OF IDENTIFYING GNEISSES AND SCHISTS

The writer knows of no case where all the evidences above cited have been used in the determination of sedimentary origin of a gneiss. As one surveys the methods used in the conclusions reached in various investigations of gneisses and schists, it becomes apparent that no one criterion is sufficient to establish sedimentary origin.

Gneisses developed secondarily from igneous rocks by pressure and recrystallization have been positively identified in even fewer cases than sedimentary gneisses. Many gneisses are known to be original igneous rocks with flow structure; a few have been found to be the result of mechanical breaking down by granulation, for instance, the granulated anorthosites described by Adams.¹ Many gneisses have been described as the foliated equivalents of granites as result of pressure and recrystallization, but often without adequate proof of this relation. Lehmann has apparently shown the development of gneisses from granites in the Saxony area. In parts of the Lake Superior country there are gneisses which seem to have such relations to granite gneisses as would result from secondary pressures and recrystallization, but there is not a single proved case there. Many pairs of analyses of granites and equivalent gneisses have been published, but these

¹ Adams, F. D., Report on the geology of a portion of the Laurentian area lying to the north of the island of Montreal: Ann. Rept. Geol. Survey Can., Vol. 8, part J, 1896, p. 85 et seq.

have usually been made on the assumption that the gneiss was the result of secondary alteration of granite and without adequate consideration of the possibility that gneissose structure may be an original flow structure.

Many more schists than gneisses have been proved to be the result of mashing of igneous rocks, for instance, the chlorite schists so commonly developed from the mashing of basalt, illustrated by the schists in the Keewatin series of the Lake Superior country; the hornblende schists formed in these rocks by contact metamorphism of granites; micaceous schists formed in granites and porphyries along a shear zone. In fact, so commonly do the igneous rocks appear when mashed to take on schistose as contrasted with gneissic structure as to raise the question whether this is not the common result of mashing and whether gneisses are not exceptional results, most gneisses to be explained as igneous rocks with original flow structures.

This brings us back to a suggestion made on an earlier page, that when igneous rocks break down by mashing, there tend to develop the platy and columnar hydrous minerals characteristic of schists. These minerals are the same in kind as those derived from the anamorphism of a sediment. As compared with the igneous rock, the change to a schist amounts to katamorphism, and requires the introduction of water and carbon dioxide. To whatever extent gneiss may be formed by the mashing of igneous rocks, and, as noted, this extent is extremely problematic, conditions different from those forming schists are implied by the fact that the gneisses have relatively less amounts of platy and columnar minerals and the change has obviously been under conditions not those of hydration and carbonation, or katamorphism in general. We have suggested that gneisses may form only in places where the agents of hydration and carbonation are lacking, and that where these agents were present, the change is more toward the schist type.

The terms "schist" and "gneiss" have been used as representing two contrasting types of rocks. It is of course to be recognized that there are complete gradations between schist and gneiss; that it probably follows therefore that there are many conditions of origin of the schists and gneisses from igneous rocks intermediate between those described.

STRUCTURES COMMON TO BOTH FRACTURE AND FLOW

FOLDS

ELEMENTS OF FOLDS

The elements of a simple fold are indicated in the following diagram (Fig. 48) taken from Willis.

The attitude of a rock bed is described in terms of strike and dip. *Strike* is the direction of line of intersection of the bed with the horizontal; *dip* is the angle between the bed and the horizontal,

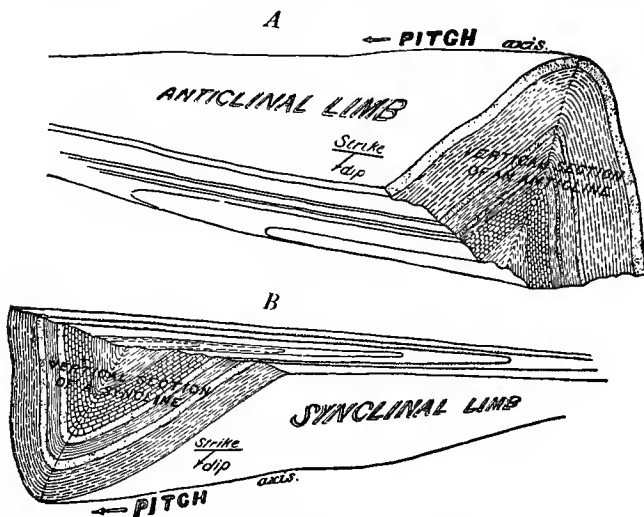

FIG. 48. Parts of folds. After Willis.

measured at right angles to the strike. Folds are usually determined by the correlation of strike and dip observations.

The *axial plane* of a fold intersects the crest of trough in such a manner that the limbs or sides of the fold are more or less symmetrically arranged with reference to it. The intersection of the axial plane with the crest or trough of a fold is the *axial line, axis*,

crest line, or *trough line*. The *pitch* of the fold is the inclination of the axial line to the horizontal. It is merely a special case of dip taken along the axis.

Strike and pitch are never strictly parallel, although if the pitch is slight, they may be nearly so.

A *simple* fold is a single bend or curve without minor crenulations. A *composite* fold is the simple fold with minor crenulations superposed on it. A *complex* fold is one which is cross folded, that is, one of which the axial line is folded. As defined by Van Hise, *composite* refers to two dimensions, or the cross section, and *complex* to three dimensions.¹

As practically all rock folds are complex, it appears that the terms "simple" and "composite" merely apply to descriptions of cross sections of complex folds. It is not always easy in discussing folds to discriminate clearly between a consideration of two dimensions and of three dimensions, and hence the use of the terms "composite" and "complex" is in practice frequently loose. The terms are useful, however, in keeping clearly before us the desirability of discrimination between two-dimension and three-dimension treatment of folds.

The axes of minor folds may have almost any angle with reference to the axis of the major fold, but there is a marked tendency to have a similar angle of pitch and a constant, though small, difference in strike.

Anticline and *syncline* refer respectively to the arch and trough of a simple fold. *Anticlinorium* and *synclinorium* refer to composite arches and troughs. Some of the great simple flexures of the earth have been called by Dana *geanticlines* and *geosynclines*.²

Each of these kinds of folds may be further classed as *upright*, *inclined*, *overturned*, or *recumbent*, depending upon whether its axial plane is vertical, inclined, overturned, or recumbent. No further definitions of these terms seem necessary. Where the limbs of a fold are parallel, it is called *isoclinal*. When the axial planes of the minor folds of an anticlinorium converge downward, the fold is called by Van Hise a *normal anticlinorium*; a fan fold is a special case of this (Fig. 49). If they converge upward it is

¹ Van Hise, C. R., Principles of North American pre-Cambrian geology: 16th Ann. Rept., U. S. G. S., part 1, 1896, p. 603 et seq.

² Dana, James D., Manual of geology, 4th ed., 1895, p. 106.

called an *abnormal anticlinorium*; *roof structure* is a special case of this (Fig. 50). A similar division applies to synclinoria.

Minor folds are commonly developed in weak beds by the shearing between two more competent masses of rock. These

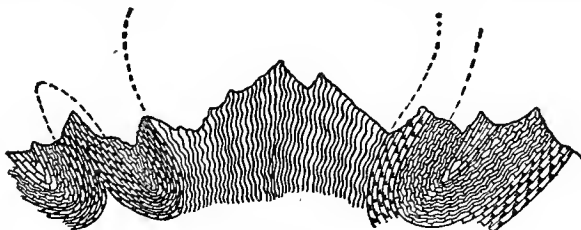

FIG. 49. Generalized fan fold or normal anticlinorium of central massif of the Alps. After Heim.

folds are conveniently designated *drag folds*. The position of their axial planes is controlled by the displacement of the more competent beds adjacent. The term "drag fold" is desirable as emphasizing the differential movement between the controlling beds.

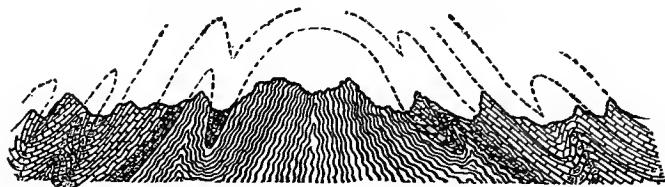
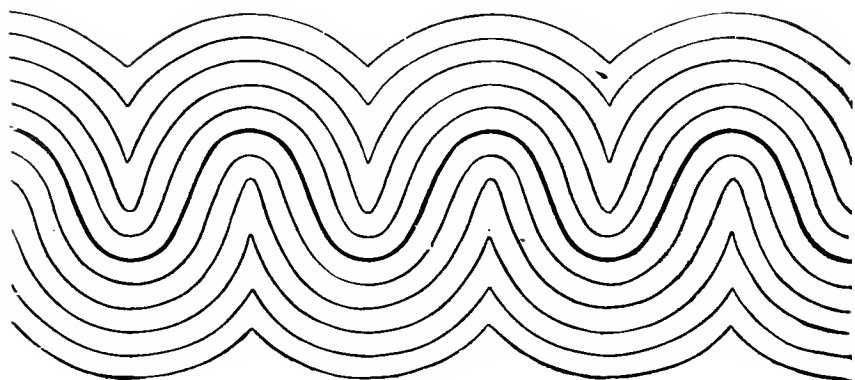

FIG. 50. Generalized section of roof structure or abnormal anticlinorium of the central massif of the Alps. After Heim.

A *parallel fold* (Fig. 51) is one in which there is no thickening or thinning of the beds; the bedding surfaces are mutually parallel. The curvature of no two beds is exactly the same. This difference in curvature implies the dying out of folds in one direction or another from a given bed, and the differential slipping between the layers to allow for the dying out and differing curvature.

In *similar folds* (Fig. 51) the beds are thickened and thinned, the bedding surfaces are not mutually parallel, but the curvature is the same for all beds. This does not require the dying out of folds or differential movement between beds



a

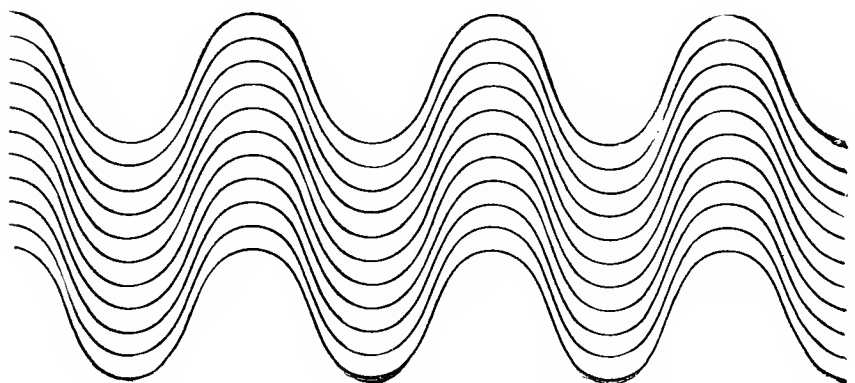

b

FIG. 51. Figures illustrating (a) ideal parallel and (b) ideal similar folds. After Van Hise.

FOLDS IN THE ZONE OF FRACTURE AND ZONE OF FLOW CONTRASTED

Rocks are folded by fracture or flow or by any combination of these two processes. Folds therefore appear in either the zone of fracture or the zone of flow or in the zone of combined fracture and flow. Folding by fracture differs in certain essential characteristics from that by flowage.

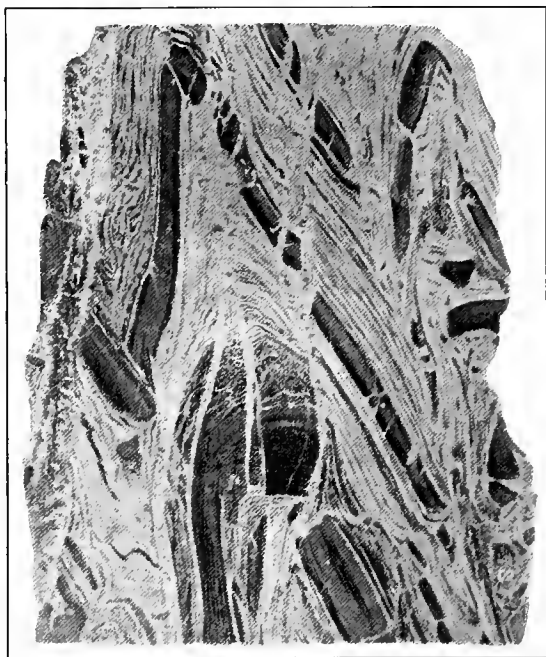

FIG. 52. Folding of brittle and soft layers contrasted in jasper. The broken dark layers are chert, the light layers are secondary iron oxide.

Folds may be formed by means of minute displacements along numerous joints and faults. Folds in brittle quartzite beds are commonly of this type.

There is no interior deformation of the fault and joint blocks, and there is no thickening or thinning of the beds as a whole. The top and bottom of a bed are parallel throughout. The fold is of the "parallel" type. The curvature of the beds so folded is not

the same through any considerable vertical distance. A much folded bed may be replaced above or below, usually below, by a much less folded bed or one which is deformed almost none at all; in other words, there is a dying out of the fold. Disappearance of folds with depth is discussed on pages 124-127. The difference in the shortening of the adjacent strata involves slipping between the beds. This slipping is really of the nature of faulting, although the

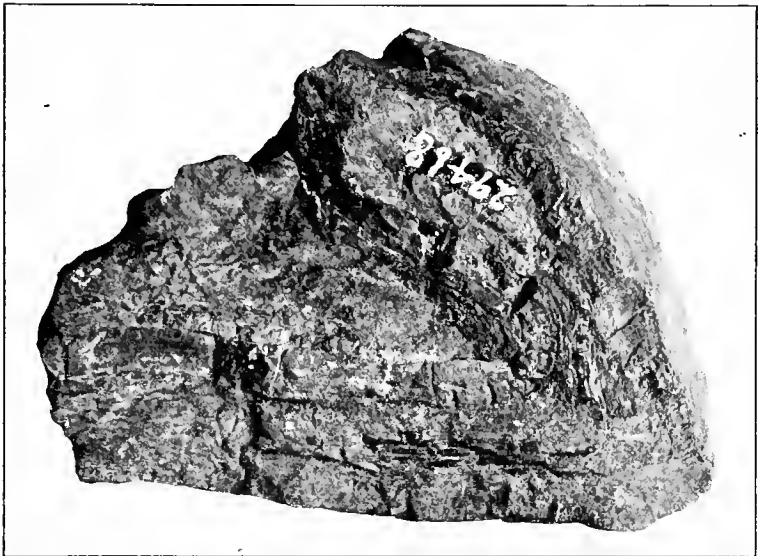

FIG. 53. Folding of brittle and soft layers contrasted in jasper. Note the tension cracks in the brittle layers.

movements are not ordinarily described as faults, on account of taking place parallel to the bedding.

In the zone of fracture rocks are relatively competent; they do not crumple by interior adjustment; the folds therefore tend to be simple and open.

In the zone of flowage rocks are folded by interior adjustment of all parts of the mass with development of cleavage. Beds are thickened and thinned. No part of the rock mass is competent to withstand the load without interior adjustment and crumpling. The result is a much more composite or complex folding. The bed thereby becomes thickened and strengthened, enabling it to

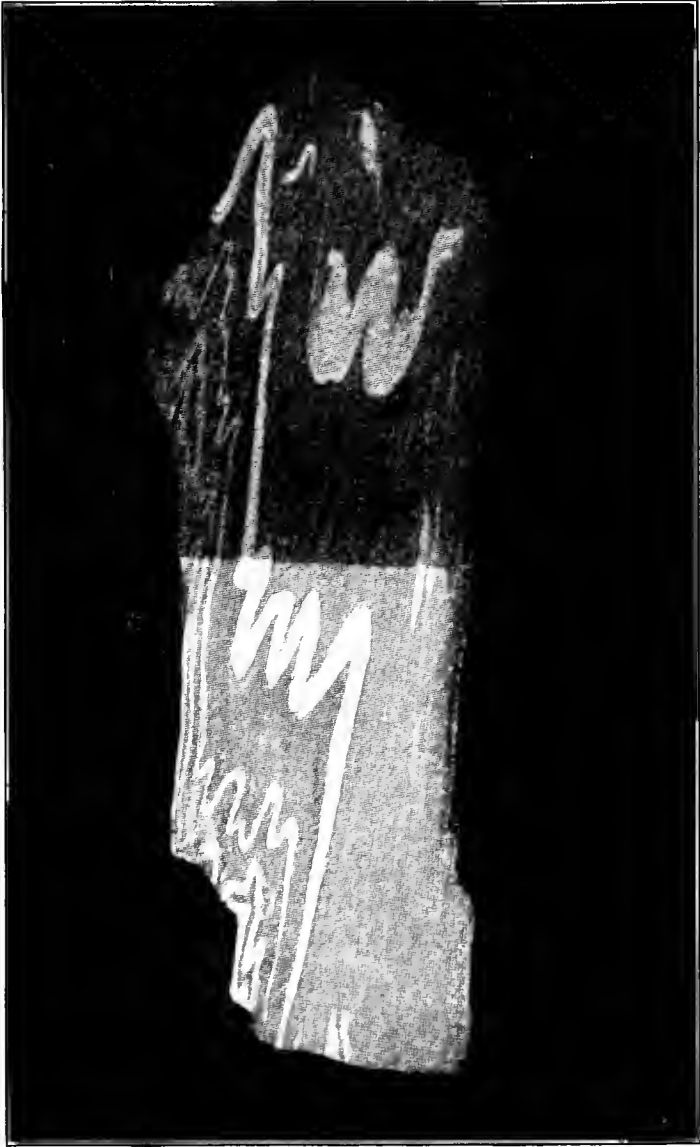

FIG. 34. Illustrating incompetent folds developed by flowage in gneiss. After Van Hise.

support the load. The folding of rocks in schistose areas, that is, areas which indicate that they have been in the zone of flowage, is intricate and close, and contrasts strongly with the more open and simple folding of rocks in the zone of fracture. For instance, the folding in the Piedmont area of Virginia, the rocks of which were deformed in the zone of flowage, is much more minute and complex than that of the Knox dolomite in the Appalachians to the west, which occurred partly in the zone of rock fracture. In the folds of the zone of flowage the readjustment takes place not only between the beds but in every part of the bed. The curvature in each bed tends to remain the same as in the strata above and below. This is called the "similar" type of folding. (See Figs. 51b and 54.) The distortion in the layers in ideal similar folds is greater in proportion as the bends are gentle on the anticlines and synclines. Hence, to avoid this distortion, there is a tendency for very sharp turns at these places. That this is a controlling tendency may be observed in any closely plicated area. The actual folds of a closely folded mass are often like those illustrated in Fig. 55.

The folds of the zones of fracture and flow therefore contrast in the following particulars:

<i>Zone of Fracture</i>	<i>Zone of Flow</i>
Beds of uniform thickness.	Beds thickened and thinned.
No interior deformation.	Interior deformation of all parts.
Relative competence.	Relative incompetence.
Simple outlines of competent structure.	Crenulated and complex outlines of incompetent structure.
Much slipping between beds; dying out of folds vertically.	Little slipping between beds; persistence of folds vertically.
Folds of above characteristics are "parallel."	Folds of above characteristics are "similar."

The use of the terms *competent* and *incompetent* respectively for the folds of the zones of fracture and flow require some further explanation. Willis' experiments on the mechanics of Appalachian structure¹ showed that the thicker, more competent wax layers rise in simple outline under given conditions of pressure and load until they are unable to lift the load farther. Then they

¹ Willis, Bailey, Mechanics of Appalachian structure: 13th Ann. Rept. U. S. Geol. Survey, Pt. 2, 1893, pp. 241-253.

crumple and, in crumpling, thicken, enabling them to lift the load higher. Thus composite folds are really indications of incompetence. Simple folds are more characteristic of the zone of fracture; the bed is able to lift itself without interior readjustment,



FIG. 55. Folded schist from Alaska. Folds are "similar" but the sharpness of the bends involves a minimum of distortion of the beds.

and without crumpling; it is competent. All folds represent a yielding to pressure. In that sense all are incompetent, and it might be better to speak of them all in terms of degrees of incompetency. There is likely, however, to be little confusion in following Willis in the use of the two terms competent and incompetent.¹

¹ *Op. cit.*, p. 250.

Our field of observation is practically confined to the zone of combined fracture and flowage, and hence to folds representing some combination of the characteristics of the two zones. The folds described as typical of these zones may be regarded as the limiting cases between which all folds may be classified. To illustrate, interlayered quartzite and slate beds exhibit folds characteristic of both zones. The quartzite folds may be of the zone of fracture, the shale folds may be of the zone of flow. The quartzite layers are in simple, broad, competent folds of the "parallel" type developed by fracture without thickening or thinning; the intervening slate layers are crenulated, thickened, and thinned, relatively incompetent, and of the "similar" type. There are many folds in homogeneous beds with characteristics intermediate between those described for fracture and flowage conditions.

The principal use of such a classification is not alone to afford a means of pigeon-holing various folds, but to call attention to the characteristics of folds which it is desirable to know for field study. The attempt to analyze a fold in the field and determine what combination of fracture and flowage conditions it represents will lead to a better understanding of the structure than will the mere naming of the fold according to form. For instance, explorations for iron ore have been going on extensively in a great slate area, completely covered by glacial drift, in central Minnesota. Drilling soon demonstrated the fact that the slate was folded in the zone of flowage. The observer was therefore justified in concluding that the folding was probably close and complex, that there was much thickening and thinning of the beds, that the folds were largely of a similar type, not dying out above or below. The application of these principles, therefore, has been of great aid in interpreting fragmentary records brought up from the drill holes, has made it possible, for instance, to correlate a thirty-foot bed of ore on the limb of a fold with a fifty-foot bed near the crest. In the Marquette district of Michigan, where there are beds of quartzite interbedded with softer slates and iron formation, it has been possible by the application of these principles to correlate some of the simpler and broader structures of the quartzites with the closer, much more complex, and quite different folds of the softer beds. In making any satisfactory estimate of the thickness of folded beds

the first question to be settled is the degree in which the folds are characteristically those of the zone of flowage and therefore to what extent they are likely to be thickened or thinned.

CONTROL OF STRUCTURES IN WEAK BEDS BY DIFFERENTIAL MOVEMENTS BETWEEN COMPETENT BEDS ON LIMBS OF FOLDS

Rocks within our field of observation are of varied competence. It follows then that in any folded area the structures of the weaker rocks are controlled by the folding of the stronger beds. The stronger beds tend to assume the "parallel" type of folds in which the principal readjustment is between the beds rather than within them. This readjustment or slipping is concentrated in the intervening weaker layers. The structures of the weaker layers indicate the direction of this readjustment and thus something of the structure of the competent beds. This fact is of great aid in the field study and interpretation of a folded area.

Differential movement between beds is uniformly toward convex surfaces in the manner indicated in the diagram (Fig. 56). In the following pages several criteria will be mentioned by which the direction of differential movement may be determined in the field. Knowing the direction of such movement, it is possible to relate the minor structures to the major folds.

(1) *Minor Folds as Evidence of Differential Movement Between Beds.*—When areas of heterogeneous rocks are folded the stronger, more competent layers are likely to show the characteristics of folds of the zone of fracture, and the softer, more incompetent layers to show the characteristic folds of the zone of flow, although the two kinds of folds may represent neither one extreme nor the other. The folds of the weaker layers are really "drag folds" due to differential movement between the controlling harder layers. The inclination of the axial planes of the minor folds with reference to the adjacent competent beds tells the direction of the differential movement. The axial planes are nearly parallel to cleavage (see pp. 119–120). When this movement is of great proportions the axial planes of the minor folds may become so rotated as to give the abnormal type of composite fold. Beds of shale may indicate a differential movement of quartzite beds above and below in the direction shown on diagram 56.

The position of the major fold is inferred from the differential movement indicated by the minor folds. The major fold may in turn be found to be one of a series of minor folds related to a still larger fold.

This is something more than the statement of an academic principle. The writer regards it as one of the most fundamental principles in the field study of structures. Adherence to the simple plan of watching for indications of differential movement leads to surprising results. In the Lake Superior pre-Cambrian

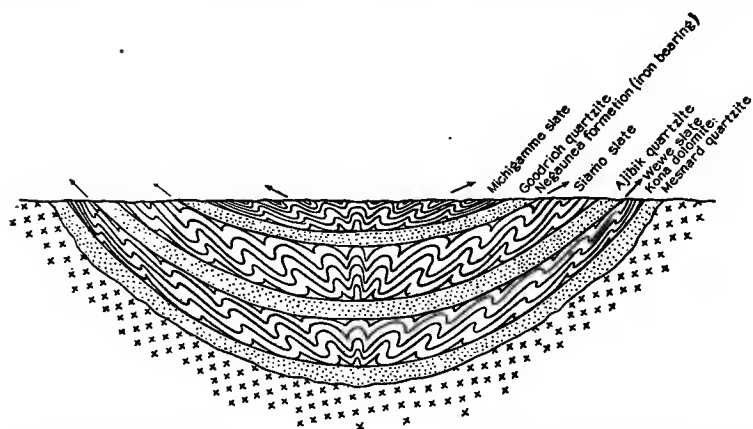

FIG. 56. Figure showing differential movement between competent beds on limbs of a fold with the development of minor drag folds between them.

districts it has been possible, by studying the minute crenulations of the softer beds, to determine the differential movement of the controlling strata on each side, and thereby to obtain a notion of the position of the next larger unit of structure. This has led to a study of still larger units, and so on. In the Marquette district of Michigan the slate beds are folded in the manner to be expected from the control of the harder quartzite layers of the Marquette synclinorium. Understanding this relation, the composite outlines of the slate folds may be satisfactorily correlated with the simple outlines of the quartzite folds. The Marquette synclinorium as a whole may be regarded as a minor fold showing differential movement upon the limb of the major Lake Superior synclinorium.



FIG. 57. Photograph of drag fold in sedimentary beds. After Hotchkiss.

The principle of the control of minor by major folds affords the most reasonable hope of working out successfully the complex structures of the old Archean or Basement Complex, which heretofore have been regarded as almost inexplicable. Although on casual inspection the folds in any ledge show an apparently great

complexity, when examined with reference to the differential movement the general structure becomes more manifest and it is possible to infer some of the relations of the major folding. By the use of this principle it has been possible recently to work out the structure of certain parts of the closely folded Archean of the Vermilion district of Minnesota, which have heretofore been designated simply as Basement Complex. The writer has observed, in traveling over hundreds of miles of Laurentian gneiss, that minor folds are accordant over considerable areas, indicating some major control and suggesting the possibility of working out larger units of structure.

The "decken" structure of the Alps, illustrated by Fig. 58, is a series of great overthrust folds with nearly parallel and horizontal axial planes, which are probably to be regarded on a large scale as minor "drag folds" resulting from the horizontal shearing of some formerly existing competent rocks over the Alpine area. The great Alpine fan folds of the type so well known through the writings and sections of Heim¹ and others are now being largely interpreted by Schardt, Lugeon,² and others as "decken" or overthrust folds and faults. The actually observed structures seem to permit of connections in cross sections drawn to correspond to either hypothesis, and it is probably uncertain in some cases which interpretation is the correct one.

As folds usually have a pitch, the axial lines of minor drag folds when projected to the surface uniformly vary a few degrees in strike from the strike of the beds at the surface, in all cases where the axial lines are not horizontal nor the dips vertical. This is well illustrated by folds in iron formation of the Menominee district of Michigan (Fig. 59). At one place the iron formation dips 70° N. and strikes N. 70° W. The pitch of the minor folds is 30° in a direction N. 65° W. As the pitch carries these folds down they are carried northward down the dip of the beds. Hence there is a divergence of 5° in this case between the surface projection of the axial line of the minor fold and the strike of the bedding, which is a fact of some commercial significance in the exploration for ore, in view of the fact that the ore follows the pitch rather than the strike.

¹ Heim, Alb., *Untersuchungen über den Mechanismus der Gebirgsbildung*, Basel, 1878.

² See: *Der Bau der Schweizeralpen*, by Alb. Heim: *Neujahrsblatt der Naturforschenden Gesellschaft in Zürich* auf das Jahr 1908, 110 Stück.

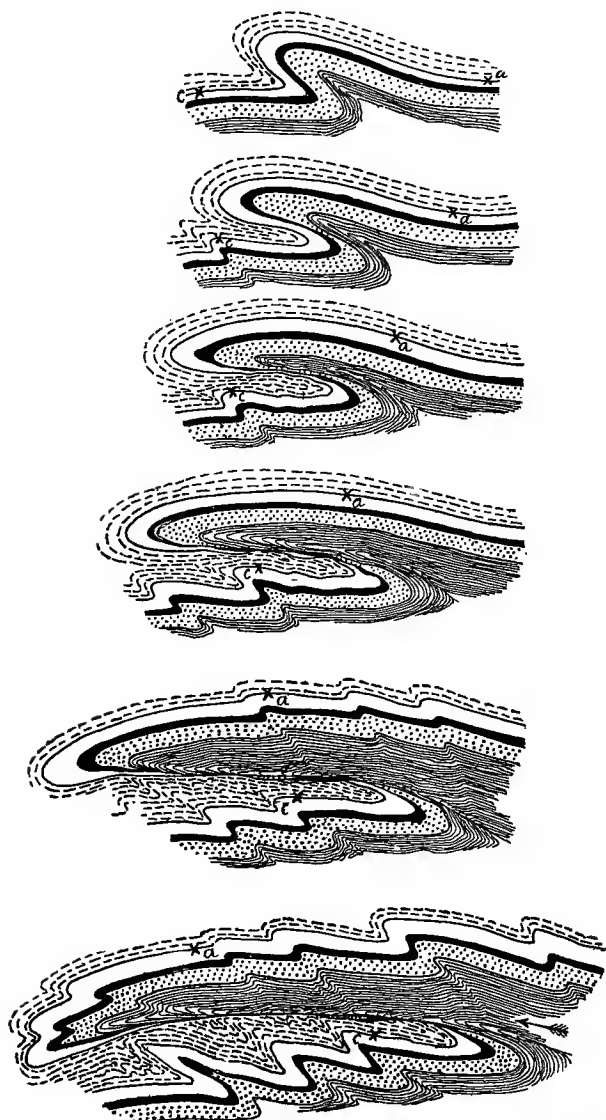

FIG. 58. To illustrate development of overthrust folding and faulting, accompanied by minor drag folds, as inferred from Alpine structure. After Heim.

The application of this principle of differential movement not only indicates the position of the minor fold with reference to the major fold but sometimes affords a means of determining which is the top and which the bottom of a bed on the limb of a fold. If in an isolated outcrop of vertical beds it is apparent that the left hand side has moved up with reference to the right hand side, the inference is that the ledge is a part of the left limb of an anticline. If so, the left hand beds of the outcrop constitute the top. This method has application in the study of isolated outcrops in which no other evidence of top or bottom appears.

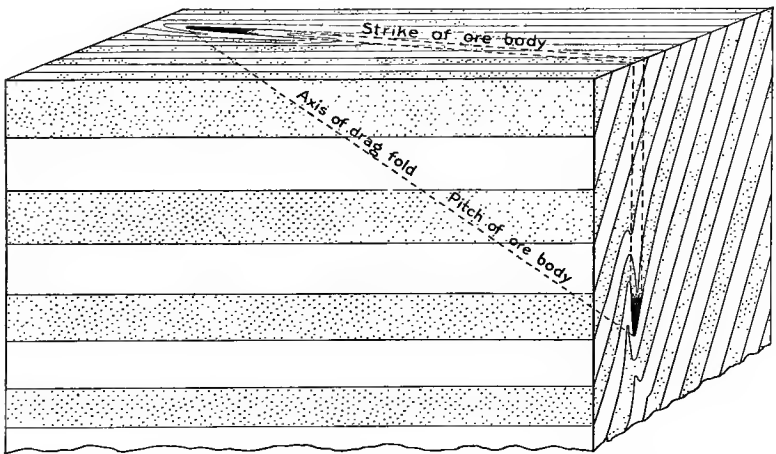

FIG. 59. To illustrate divergence in strike and pitch. After Mead.

(2) *Cleavage as Evidence of Differential Movement in Folding.*—Fracture cleavage or flow cleavage is usually associated with the weaker beds in folds. The attitude of cleavage with reference to the bedding indicates the direction of differential movement between the beds, and, like the drag fold, becomes an aid in interpreting structure (see Figs. 9–11, 37, 46, 47). When a slate or shale is folded between two competent layers, such as quartzite, the cleavage produced in the slate affords clear evidence of slipping or shearing between the quartzite beds. The cleavage is inclined to the bedding at angles determined by the amount of slipping, and tends to converge upward on an anticline of gentle curvature.

The cleavage is approximately parallel to the axial planes of minor drag folds which are likely to be present under such conditions (see p. 114).

Some beds are so closely compressed that both the cleavage and the bedding are so nearly vertical as to be about parallel. Here it may be impossible to apply the above simple principles of relationship; but the writer has found that when a detailed study has been made it has sometimes been possible even here to draw some reasonable inference as to the position of the axial planes of the closely compressed folds. In irregular anticlinoria or synclinoria the cleavage may apparently have such intricate relations to bedding that it is impossible to formulate any general statement of the relations of cleavage to the fold as a whole. Examination of any detail of the fold, however, will indicate the relations above described, and from these details much light may be thrown upon the general character of the fold.

When all parts of a homogeneous incompetent rock are folded in the zone of rock flowage, there is a less pronounced shearing between beds, and less control of cleavage directions by differential movements on the limbs. The cleavage may have a uniform dip regardless of folds, but in general is parallel to the axial planes. Both the cleavage and the folds may then be regarded as having been developed under some larger control, as, for instance, the shearing of a rigid mass horizontally over the entire area. This is illustrated by monoclinial cleavage crossing the complex folds in slate without any apparent relation to the minor folds; whereas when compared with major folds in adjacent competent strata the cleavage is found to be in positions which indicate its development under the control of a major fold. The same principle on a larger scale may be considered as explaining some of the regional cleavage.

Large areas like the Piedmont Plateau and parts of the pre-Cambrian shield of North America have a cleavage with remarkably uniform strike and dip, notwithstanding the heterogeneity of rocks and folds on these areas. There seems to have been some one factor controlling the development of cleavage for the area as a whole. There is no reason to believe that the development of such cleavage does not conform to the laws of stress and strain already described, but the units of structure involved may be much larger than those observable in the individual folds.

The fact that the cleavage is often inclined rather than vertical suggests horizontal shearing stresses rather than horizontal non-rotational compression (see pp. 16-21); and these might be developed by the shearing of a large portion of the zone of fracture over an underlying zone of flow. Chamberlin¹ has suggested that certain great thrust planes may be the surface expression of a deep zone of shearing. Shearing movement has been thought by Chamberlin² to be a possible result of creep, under gravity, of the elevated portions of the earth's crust, especially at continental margins. Van Hise³ has suggested that perhaps tidal friction, tending to retard the surface of the earth in its rotation, might give it a tendency to shear relatively westward over underlying portions, thereby giving eastward-dipping cleavage. Strikes and dips of cleavage have not been sufficiently well correlated over large areas to ascertain to what extent they might correspond with the requirements of any one of these hypotheses.

(3) *Jointing, Fracture-Cleavage, and Fissility as Evidences of Differential Movement Between Beds in Folding.*—Differential movement between beds develops one set of shearing planes parallel to the beds and another at an angle less than 90° to it (see Fig. 7). The latter set indicates the direction of the displacement between beds in folding. Joints or fracture cleavage form along these planes. They may be curved or S-shape. Also they are likely to be confined to certain beds and offset along the bedding plane in passing to different strata on either side. Given, then, joints thus obviously related to folding, it is possible to determine the differential movement and get a notion as to the part of the fold on which observation is taken. For instance, in the Baraboo district of Wisconsin, northward dipping beds of quartzite are cut by two sets of joints, one set parallel to the bedding, and another set of strike joints crossing the bedding and dipping northward (see Figs. 10 and 11). It is clear in this instance that the upper beds have moved southward with reference to the lower beds. This corresponds to the requirements of a position on the south limb of a syncline. The same kind of reasoning may be applied to the north limb of the Baraboo syncline (see Fig. 9).

¹ Chamberlin, T. C., The fault problem: Econ. Geol., Vol. 2, 1907, p. 598.

² Idem., p. 718.

³ Van Hise, C. R., A treatise on metamorphism: Mon. 47, U. S. Geol. Survey, 1904, p. 930.

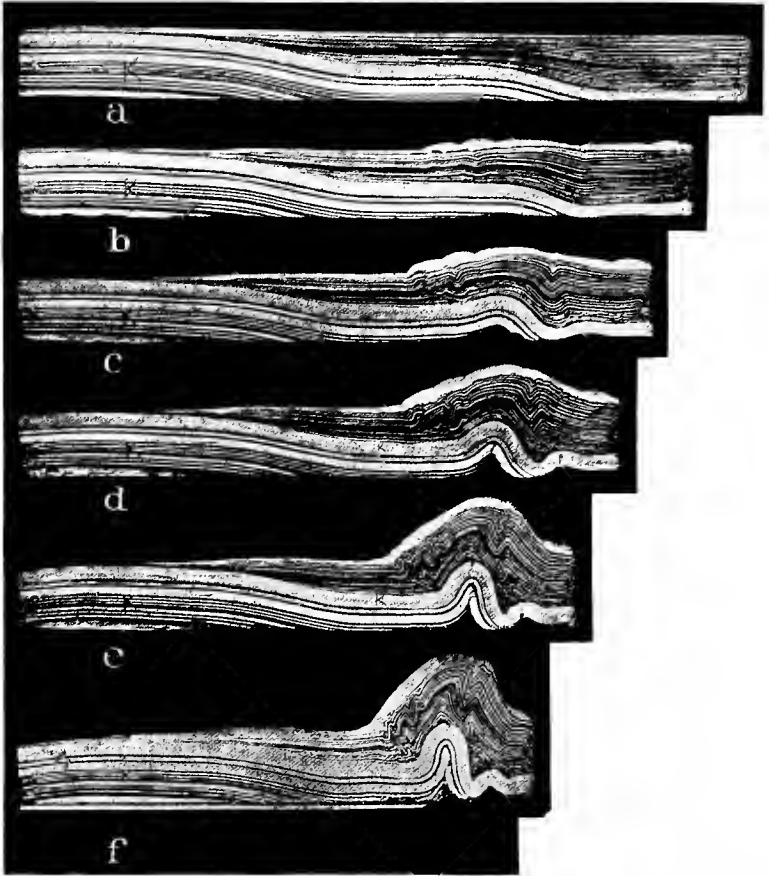

FIG. 60. Illustrating the artificial development of fold. After Willis. The fold begins to develop at points of initial irregularity in the beds (initial dip) near the point of application of force. The heavy layers rise in simple, competent, parallel folds, the soft layers in composite, incompetent, similar folds. When the stronger layers have risen to the limit of their competency they buckle, developing composite outlines and to that extent taking on characteristics of incompetent folds.

It is frequently necessary to interpret structure from a few widely separated exposures, and then relations of this type may furnish a clue to the structure, to be checked of course by other criteria.

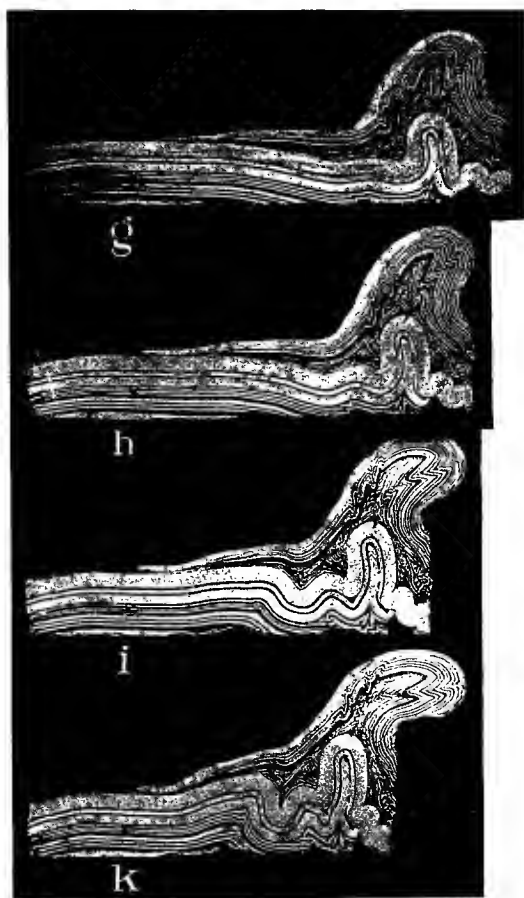

Fig. 60 (continued.)

Conclusion as to differential movements in deformation. Our field observation being confined to the zone of combined fracture and flowage where the beds are both competent and incompetent, it follows that the larger part of the rock structures and the rock deformation described in this book may be regarded as evidences and results of differential movement on a smaller or larger scale.

LOCALIZATION OF FOLDS

(a) It has been shown experimentally by Willis¹ that folds tend to form near the point of application of the deforming force, unless the rocks are sufficiently rigid to transmit the thrust forward to some weaker zone. (b) Willis has also shown that slight irregularity in the bedding, such as might be formed during sedimentation, and which he calls *initial dip*, will tend to localize a fold, even at some distance from the point of application of the stresses. (c) Still further, it appears that the uplift of the fold at any one place may tend to depress the beds immediately beyond it, creating an irregularity or "initial dip" which localizes another fold. The first fold rises to such a point that it becomes easier to develop a new fold than to lift the old fold higher. (d) Irregularities of structures other than bedding may localize the fold. Contact of rocks of unequal strength, for instance of granite and sediments, has been observed to localize folds, the massive granite serving as a buttress against which the weaker series is deformed. (e) Inherent weakness of rocks may localize a fold. A slate is likely to be more folded than an adjacent quartzite. Initial dip or other irregularity may determine at what points in the shale the folds shall be localized, but the weakness of the shale as a whole as compared with the adjacent beds will favor the development of folds in the shale rather than in the quartzite. This weakness is one of the common causes for the localization of folds.

DETERMINATION OF DEPTH AFFECTED BY FOLDS

It is sometimes possible to measure the linear shortening of an area by folding, and also the vertical uplift. These are necessary data for estimating the depth affected by the folding. In the following diagram, which may be supposed to illustrate roughly the Southern Appalachian folding, 100 miles of surface has been crowded into 75 miles. There has been an uplift of approximately a mile. Obviously the product of the linear uplift and the length of the shortened area, 1 mile x 75 miles, should equal the product of the shortening, 25 miles, and the depth affected. By solving the equation, this depth is found to be 3 miles. This method was

¹ Willis, Bailey, *Mechanics of Appalachian Structure*: 13th Ann. Rept. U. S. Geol. Survey, pt. 2, 1893, p. 247.

suggested by T. C. Chamberlin¹ and has been applied by R. T. Chamberlin² to the Appalachian folds of central Pennsylvania. A similar method was independently developed by Willis³ and applied to the Cascade Mountains. The same method has been suggested by T. C. Chamberlin⁴ to determine depth affected by faults.

With a given elevation, the less close the folding (or faulting) and therefore the less the shortening, the greater the vertical distance involved in the deformation. In the section made by

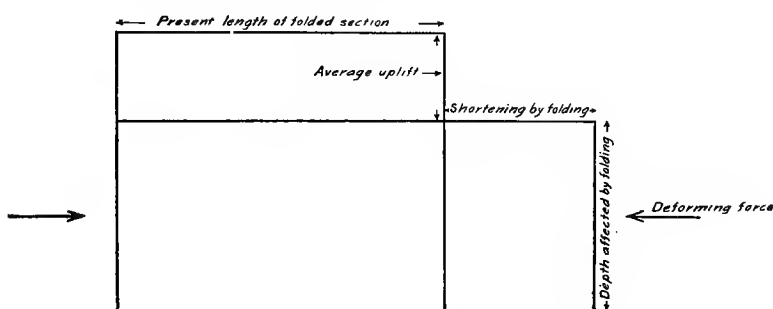

FIG. 61. Illustrating a method of determining depth affected by folds.

R. T. Chamberlin⁵ from Harrisburg to Tyrone in Pennsylvania he finds that shallower depths are affected on the two ends of the section and greater depths toward the center (see Fig. 62). The shallowest deformation found is 5.7 miles. Making calculations for five sub-sections, he finds a gradual increase in the depth affected toward the center of his section, which suggests that the deformed zone is bounded by planes dipping approximately 45° from the surface at either end of the section and intersecting about 32 miles below the surface near the center. The intersection of these hypothetical planes at 45° with each other and with the earth's surface suggests to Chamberlin that they are really shearing

¹ Chamberlin, T. C., and Salisbury, R. D., *Geology*, Vol. II, 1906, pp. 125-126.

² Chamberlin, R. T., *Appalachian folds of central Pennsylvania*; *Jour. Geol.*, Vol. 18, 1910, pp. 228-251.

³ Willis, Bailey, *Physiography and deformation of the Wenatchee-Chelan district, Cascade Range*; Prof. Paper No. 19, U. S. Geol. Survey, 1903, pp. 95-97.

⁴ Chamberlin, T. C., *The fault problem*; *Econ. Geol.*, Vol. II, 1907, p. 596.

⁵ *Op. cit.*, p. 245.

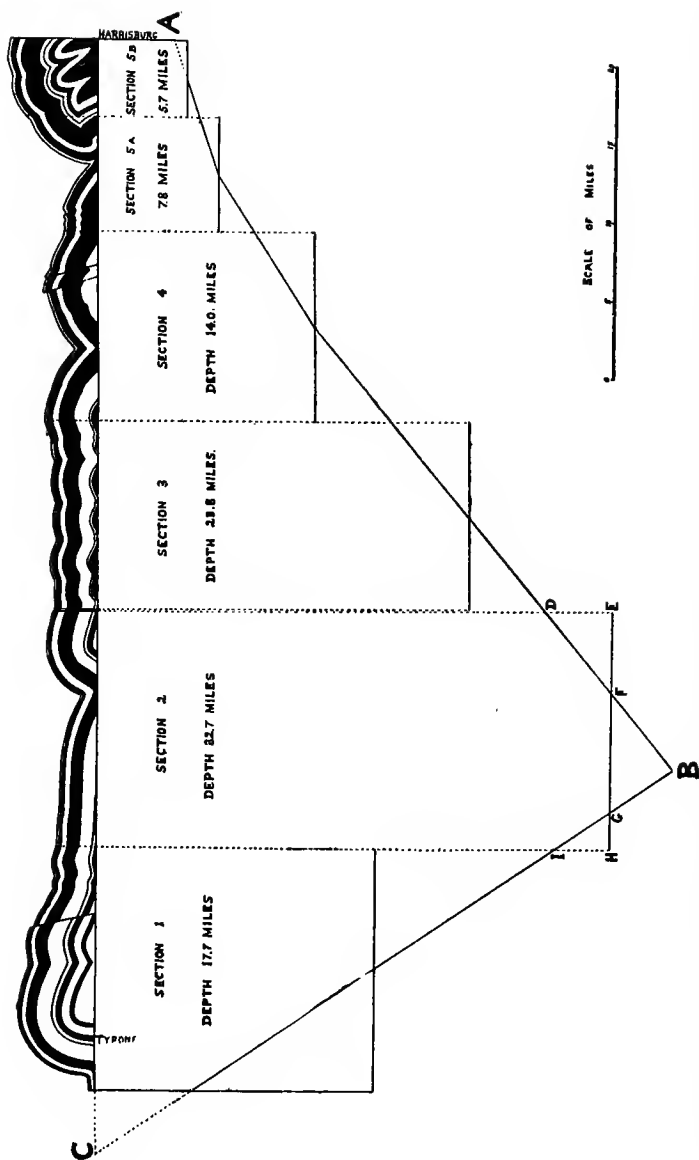

FIG. 62. Plot of the Tyrone-Harrisburg folded section representing the thickness of deformed shell beneath each of the six blocks as developed by the above methods of measurement. After R. T. Chamberlin. The lines AB and BC are drawn through the middle points of the bottom lines of each of these blocks, except Section 2, the apex block. The triangle GBF is drawn equal in area to the sum of the triangles GHI and DEF. The whole deformed mass appears, subject to the necessary limitations, to be the triangular block ABC.

planes developed by tangential shortening in the manner of fracture planes formed in a block under pressure.

The above inference implies that the pressure has been applied with equal intensity on all unit areas on the sides of the deformed block; it implies a non-rotational strain; it implies, further, that shearing planes find expression in the zone of rock flowage. While shearing stresses are undoubtedly present in this zone during deformation, it is not so clear that they would find expression in definite planes bounding the deformed region or that such planes would have the position assumed for them. They would not if the strain were rotational, developed by tangential stresses. The structure consonant with such deformation in the zone of flowage is a vertical cleavage, as is implied by Willis' conclusion concerning the Cascade folding.¹ The depth reached by the deforming movements of the Cascade uplift has been calculated by Willis to be from 375 to 1500 miles. The smaller of these estimates would lead so deep into the zone of flowage as to make it impossible to consider the deformation as being controlled by shear zones. Willis seems to have considered that the entire mass has been shortened by flowage down to these depths, resulting in vertical uplift.

The methods for the determination of depths of folding worked out by the Chamberlins are of fundamental significance, and are likely to yield unexpected results.

Another way of estimating the depth affected by folding is to compare the deformation in stratigraphically superposed rocks in a given locality. Daly² finds in south-central British Columbia that the pre-Cambrian massives are much less folded than the overlying Carboniferous and Triassic rocks, indicating that a small depth of the earth shell has suffered strong folding in post-Cambrian time.

FIELD OBSERVATIONS ON FOLDS

Strike and Dip:—Strike and dip records are ordinarily of value because of the light they throw on the folding of strata. It is essential in taking the readings to keep this in mind in selecting points at which to take the observations. Especially it is desirable,

¹ Willis, Bailey, *Physiography and deformation of the Wenatchee-Chelan district, Cascade Range*: Prof. Paper No. 19, U. S. Geol. Survey, 1903, pp. 92-97.

² Daly, R. A., Abstract of paper presented at 24th annual meeting of Geol. Soc. Am. at Washington, D. C., December, 1911.

as soon as the existence of a fold is suspected, to search for the axis, in order to ascertain the pitch. In a closely folded area the deformation of the beds by shearing on the limbs is so much greater than on the axial lines that frequently much can be ascertained from a study of the axial zone which could not be suspected from a study of the limbs alone. An illustration may be cited from the folded Algonkian and Archean rocks in the Vermilion district of Minnesota. The Archean is exposed in the cores of closely folded anticlines. Along the sides of these anticlines the shearing is so close that cleavage has been developed both in Archean and Algonkian, and the evidence of their relations practically destroyed. On the axis of the fold, however, where it pitches under the surface, it is frequently possible to find the beds so little deformed that conglomerates may be recognized and the relations worked out.

The determination of the pitch of the axis gives the dip of the limb of the cross fold.

The taking of strike and dip observations at random without a definite attempt to correlate them on to the general structure of the district at the time they are taken leads frequently to unsatisfactory results. Daily field study of strike and dip observations, conscientiously platted to date, should be the basis for planning field work on succeeding days. Too frequently, definite field determinations of pitch are not made, but are left to be inferred from a study of the records when later platted. Thus one of the most important and decisive elements of structure is loosely determined, and this neglect may often lead to serious error.

Emphasis on Relations of Major and Minor Structures:—The constant attempt to correlate minor and major structures under the principles outlined in the preceding sections cannot be too strongly urged. It is indeed surprising what a variety of applications these principles have. It is seldom that a study of any element of the structure does not give a clue as to what to expect in the larger or smaller elements of the deformation.

Field Observations on Relations of Cleavage to Folds:—Keeping in mind the simple relationships of cleavage to folds, discussed on pages 119–121, the following are some of the field inferences that may be drawn from cleavage. The student will find it to his advantage to reason out each of these inferences for himself.

(a) Cleavage converging upward suggests an anticline. It is seldom, however, that this ideal condition may be recognized in the field on any large scale. The slight overturning of cleavage or folding makes it difficult to determine this relation. (b) More useful are the inferences to be drawn perhaps from local observations of the relation of cleavage to bedding. Cleavage normal to bedding probably indicates the axial plane of the fold. (c) Cleavage inclined to the bedding probably indicates the limb of a fold. (d) The inclination of the cleavage with reference to the bedding tells on which limb of the fold the observation is taken. (e) If bedding is vertical and inclined cleavage is present in the softer

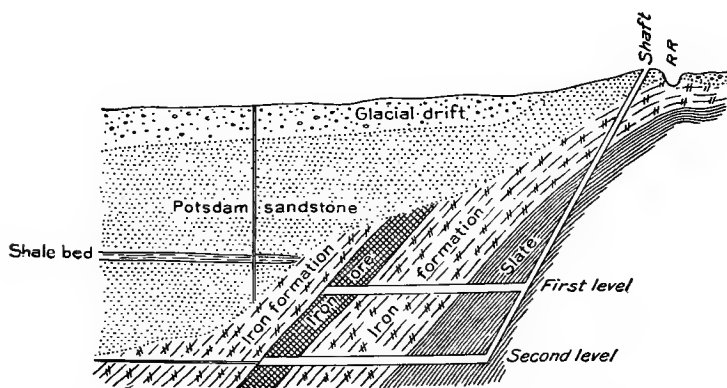

FIG. 63. Vertical section of Illinois mine, Baraboo district, Wisconsin. After Weidman.

layers between harder ones, thereby indicating direction of displacement, it is possible to infer on what part of the fold this relation was doubtless developed and from this in turn it may be inferred which is the top and which the bottom of the bed.

In the Baraboo district of Wisconsin, slate overlain by iron formation has been folded between a competent quartzite layer below and a dolomite bed above. The slate thus forms the foot-wall for the iron formation. A shaft sunk largely in the slate followed the cleavage, the bedding being very obscure. As a result, the shaft penetrated the ground more steeply than the bedding, as would be expected, and where at considerable depth

drifting was begun to cross cut the ore, it was found that the bottom of the shaft was a long distance away from the ore body.

The greater part of the Lake Superior iron ore is found in the upper Huronian group of rocks, of which slate is an important member. Much of the exploration has to be done by drilling, and a study of the relations of cleavage to bedding in the slate brought up in the drill cores frequently gives important clues to the folding. For instance (a) a vertical drill hole discloses a vertical cleavage with a horizontal bedding. The inference is that the hole is parallel to the axial plane of the fold. (b) It discloses cleavage inclined to the bedding. The inference is that the limb of the fold has been penetrated. (c) A hole drilled at an angle of 45° to the horizon brings up a core, the longer direction of which bisects the acute angle between the cleavage and bedding. The general trend of the principal elements of structure of the district is known. It is not known, when the core is brought up, how much it has been rotated in the hole, and thus from the core two hypotheses are possible—that the bedding is nearly horizontal and the cleavage nearly vertical, or that the bedding is vertical and the cleavage horizontal. The fact that cleavage in these slates is usually vertical or nearly so makes it necessary in the majority of cases to conclude that the bedding is horizontal, and that it has been cut near the axis of a fold.

Many other specific illustrations might be given to show the value of this principle in field work. If the observer of drag folds or cleavage will in every case ask himself what is the displacement shown by these structures taken in detail or as a whole, he will be able to determine his probable position with reference to the next larger order of fold, and hence to direct his work more intelligently in working out the features of this larger element of structure.

If cleavage alone is observed, with unknown relations to bedding, some valuable inferences are still possible. The very existence of cleavage implies failure or incompetence on the part of the rock and this in most cases involves folding. The writer has yet to find a true slate which does not have some folding of the beds. It may be inferred also that the folds are characteristic of flowage conditions, that is, similar folds with composite outlines, and that their axial planes are nearly parallel to the cleavage. This incom-

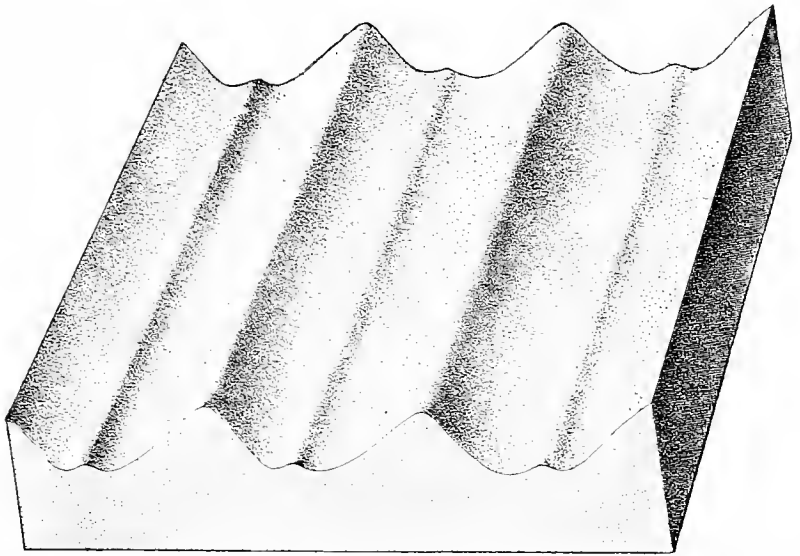

a

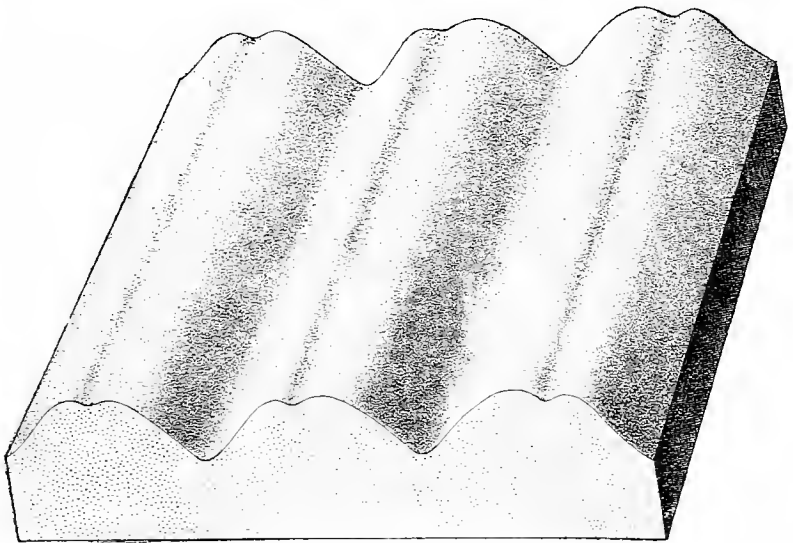

b

FIG. 64. Photograph of (a) ripple marks and (b) casts of ripple marks.
After Van Hise.

petent structure is almost certainly controlled by competent structures in stronger adjacent rocks wherever they may be. The prevailing strike and dip of cleavage may suggest where and what the larger competent structure is. Cleavage in a slate area may strike east and west and dip south at an angle of 45° . The inference is that here are similar composite folds with east-west trend and axial planes dipping to south; further, that the structure was developed by the relatively northward movement of some overlying competent rocks which have been removed; finally this inferred major control suggests a major anticline to the north.

Determination of Top and Bottom of Sedimentary Beds in a Folded Area:—It is only in folded beds that criteria other than superposition are necessary to determine top or bottom of the beds. When the folding is worked out the problem is solved. Any methods used for determining folds therefore apply to this problem. The relations of cleavage, joints and minor drag folds to major structure discussed above therefore help to determine which is top and which is bottom of beds. There are primary structures of beds which may also be used to advantage, particularly (a) ripple marks, (b) false bedding and (c) variations in coarseness of grain.

(a) In Fig. 64 the normal ripple marks and their casts are indicated. It will be noted that in the normal ripple marks the crests are much sharper than the troughs, and that the troughs may have minor crests in them. When the beds are on edge or overturned, these facts enable one to tell which is top and which is bottom.

(b) In Fig. 65 it will be noted that the false bedding is abruptly cut off by overlying beds while it comes in contact with the lower beds by a tangential curve. If the outcrop shown in the photograph were turned on edge or overturned, there would still be no difficulty in determining which were the original top and bottom of the beds.

(c) It is very common to find a diminution in coarseness of beds from the bottom toward the top. Even in microscopic sections this is apparent. The beds may start in abruptly with coarse sediments, these gradually become finer-grained above, and the next bed start in again abruptly with coarser sediments. There is little difficulty in these cases, no matter what the folding, in determining the original top and bottom of the beds. This has



FIG. 65. False bedding or cross bedding in sandstone. Dalles of the Wisconsin.
After Salisbury and Atwood.

been found especially useful in interpreting drill samples from folded rocks.

SUGGESTIONS FOR LABORATORY STUDY OF FOLDS

The following questions merely suggest a desirable line of laboratory study. Teachers will multiply illustrations.

On the Cloud Peak-Fort McKinney, Wyoming, or Oelrichs, South Dakota-Nebraska, folios (Nos. 142 and 85, U. S. Geol. Survey), how can the strike of the beds be determined from the geologic map? Show also how the direction and approximate angle of the dip can be found from the map. On the Monterey, Virginia-West Virginia, or Ringgold, Georgia-Tennessee, folios (Nos. 61 and 2, U. S. Geol. Survey), determine the direction and degree of pitch of axial lines of both anticlines and synclines. Are the strike and pitch parallel? What are the various possible relations between them? What do these relations signify? Study the valleys and outcrops on the Sundance, Wyoming-South Dakota, folio (No. 127, U. S. Geol. Survey) using the geologic map. How do the shapes of outcrops vary with different relationships between the dip of the beds and the direction and gradient of the valleys?

On the Monterey, Virginia-West Virginia, or Three Forks, Montana, folios (Nos. 61 and 24, U. S. Geol. Survey) show how anticlines may be distinguished from synclines by the study of outcrops on the geologic map; the same with reference to anticlinoria and synclinoria on the Mt. Mitchell, North Carolina, and Menominee, Michigan, maps (folios Nos. 124 and 62, U. S. Geol. Survey).

On the geologic maps of the Mt. Mitchell, North Carolina, folio (No. 124, U. S. Geol. Survey) show how the outcrops themselves indicate that certain folds are overturned; that some of the folds are isoclinal.

On the Maynardville, Tennessee, Bristol, Virginia-Tennessee, and Morristown, Tennessee, folios (Nos. 75, 59, and 27, U. S. Geol. Survey) study the relation of the little drag folds to the major folds of the region. Is there any relation between the drag folds and certain rock formations? Why? What is the relation between the pitch of the drag folds and that of the major folds? What differential movements do the drag folds indicate and where and of what type are the major folds?

Examine cross sections on the Maynardville, Tennessee, and Morristown, Tennessee, and Mt. Mitchell, North Carolina, folios (Nos. 75, 27, and 124, U. S. Geol. Survey) and the Marquette, Michigan, monograph of the U. S. Geological Survey (Vol. 28). Are the synclinoria normal or abnormal? What caused the one type to be developed rather than the other?

Are the folds on these cross sections similar or parallel or are both types present?

Which of the folds studied on foregoing maps were formed in the zone of rock flow and which in the zone of fracture? Why?

Given an outcrop of steeply inclined beds, what are the various phenomena to be looked for indicating differential movement between the beds? (See Figs. 9, 10, 11, 37, 46 and 47.)

Having determined the direction of the differential movement, what inference do you draw as to type of folding, as to location and pitch of the axes of the major folds, as to the top and bottom of the beds?

Study the charts accompanying Willis' "Mechanics of Appalachian Structure,"¹ with a view to answering the following questions: What has determined the location of the folds? How are folds repeated? What determines whether the fold shall be simple or composite in outline? Which of the folds are of the abnormal type and why have these developed? Are the folds similar or parallel? Are they characteristic of the zone of rock fracture or the zone of rock flow?

¹ Willis, Bailey, *Mechanics of Appalachian Structure*: 13th Ann. Rept. U. S. Geol. Survey, pt. 2, 1893, pp. 211-281.

MOUNTAINS

TYPES OF MOUNTAINS

Mountains may be carved by erosion from undeformed sediments or undeformed igneous rocks. They may be formed entirely by volcanic extrusion without the aid of erosion or secondary deformation. The larger mountain ranges are sculptured in rocks which have undergone secondary deformation and uplift. They are commonly dated from the time of deformation and uplift, rather than from the period of erosion. Depending on the nature of the deformation, they are called block fault mountains, monoclinical fold mountains, fan fold mountains, etc., though it has been recognized that erosion has been an important factor in causing the present topography. Uplift relative to sea level must precede erosion and in that sense is primary and essential to mountain building. The uplift, however, may produce a plateau or other forms quite different from mountains. Differential erosion therefore is necessary to produce the forms of mountains. In time erosion completely base-levels mountains, as it has so largely in pre-Cambrian areas. In the highest existing mountains the uplift and deformation have been of recent date and erosion has not had time to reduce them.

The structure of the greater number of mountains is clearly the result of tangential shortening of the earth's crust expressed in folding and overthrust faulting. They exist in chains of elongated ridges, lying end to end, or overlapping. They afford marked evidence of greater shortening normal to the general trend of the chain than parallel to it. Certain of the folds show an irregular dome-shape and seem to have been shortened more or less equally from all sides.

Attention is here especially directed to mountains developed by differential erosion of rocks which have undergone secondary deformation. They are conspicuous surface expressions of the structures described in the earlier pages of this book and this discussion will therefore be brief.

MOUNTAINS AND NORMAL FAULTS

Several mountain ranges are the result dominantly of nearly vertical movements along faults. Examples of these are found among the Great Basin ranges of the West where there are faults with a displacement of over a mile and in the Wasatch and Sierra Nevada mountains. The present topography of the Great Basin ranges is due partly to fault scarps, more or less modified by erosion. There is a difference of opinion among geologists as to the relative importance of the two factors of faulting and erosion. The published discussion of the subject is of general interest, as illustrating the trend from an earlier emphasis on structural features, such as faults, toward a wider recognition of the importance of erosion. (See pp. 57-59.)

MOUNTAINS AND THRUST FAULTS

While thrust faulting has played an important part in the deformation of many mountain ranges and the faults influence the present topography, erosion has so modified the fault topography that it is difficult to state in simple terms the influence of faulting in producing this topography. In general fault slices piled one on top of another tend to form the present elevations. This is conspicuously illustrated in the Highlands of Scotland, in the Scandinavian Highlands, in parts of the Alps, and in the southern Appalachians. Erosion, working on the tilted fault slices, leaves linear ridges generally, but not closely, parallel to the fault traces, but the varying hardness of the rocks and the physiographic conditions play such an important part that there is usually no close relation between the mountain range and the fault traces. Such ridges tend to be steeper on the side toward which the overthrust is moving and gentler on the other side. The fault traces naturally are exposed on the steep faces.

MOUNTAINS AND FOLDS

Where the folds are somewhat simple and open there is a distinct tendency for erosion to cut down the anticlines, leaving the synclines as ridges between. Synclinal mountains thus formed are well illustrated in the Appalachian region. The stumps of mountains throughout the pre-Cambrian are largely of this type. The

iron "ranges" of Lake Superior, which are really stumps of mountains, are prevailingly synclinal. Less frequently the anticline stands as a topographic elevation. Illustrations of this may be seen in the Appalachian mountains. This structure is more common where the anticline has a core of igneous rock, as in the Front Range of Colorado.

As the folding becomes closer and more complicated, the relations to topography likewise are more complicated. The great overthrust folds or "decken" structure of the Alps and to a less extent some of those of the southeastern Appalachians bordering the Piedmont, illustrate this complexity of relations. The general effect is to pile up strata in the same manner as in overthrust faults, forming ridges, which in general mark the present elevations, but the varying resistance of the rocks to erosion from various causes results in wide variations in topography. As in the case of thrust faults, the steep slopes tend to be on the side away from the thrust; in gentle slopes, toward the thrust.

In an area of monoclinal folding the softer beds are eroded and the more resistant beds stand out as linear ridges with steep sides generally in the direction opposite to the dip and with gentler slopes in the direction of the dip. Somewhat regular step mountains or step topography may be produced in this fashion.

MORE COMPLEX RELATIONS OF MOUNTAINS TO STRUCTURE

The above statements express but crudely some of the simpler relations between structure and mountain ranges. In most mountain ranges there have been repeated deformations and uplifts and repeated cycles of erosion which leave the present topography in relations to structure which cannot be as simply stated as above. It has often been possible to work out the complex history of the relations between structure and erosion in the development of the present topography, but this has been primarily the field of the physiographer and will not be entered into here.

LOCALIZATION OF MOUNTAINS

Mountains due to deformation are located where folding and faulting accompanied by uplift result from failure of the earth's

shell. The part of differential erosion is in one sense secondary and modifying. The highest mountain chains are those of recent age, which erosion has not yet had time to cut down. The older rocks, principally the pre-Cambrian, show deeply eroded, folded, and faulted stumps of mountains. Suess has emphasized the extreme deformation of the pre-Cambrian rocks and implies that the Archean was a greater mountain-building era than any era since. It is apparent, however, that the Archean has suffered deformation not only during Archean time but during all successive periods. Consequently it shows in general more folding than the rocks of later periods, but it does not follow that this excessive amount of deformation was accomplished during the pre-Cambrian, rather than during later periods. While it is entirely conceivable that the Archean may have been a time of mountain building on a far greater scale than any succeeding period, the writer doubts whether this has been established on an inductive basis.

Mountain areas of earlier periods have commonly been the locus of mountain building in later periods. Some zones of weakness seem to have been permanent through much of geologic history. Many of the principal mountain chains are the result of repeated foldings and uplifts along the same general zone. There has been a tendency also for successive deformations to widen the mountainous zone.

Many, in fact most, of the great mountain chains are near the margin of continents. Some mountain chains which do not now border continents did so at the time of their deformations. It has long been recognized that mountains have developed at various periods in geologic history along geosynclinal shores of heavy deposition. Thus the Appalachian mountains developed along the shore area of heaviest deposition of the Paleozoic sediments against the old pre-Cambrian Appalachia, now represented in part by the Piedmont plateau.

The distribution of mountain chains along continental margins suggests crowding between oceanic and continental segments of the globe. Chamberlin¹ considers such crowding to be due to the settling of the larger and more dense oceanic segments as a whole, crowding smaller and less dense continental segments laterally and possibly upward, and localizing deformation near

¹ Chamberlin, T. C., and Salisbury, R. D., *Geology*, Vol. 1, 1904, p. 521.

continental margins. According to the advocates of the theory of isostasy, this crowding is due to the readjustments necessary to restore equilibrium between regions of different density when this equilibrium has been disturbed by transfers of material by erosion, or by any other agency. By others the localization of mountains in these zones has been referred more or less vaguely to a rise of the isogeotherms into the base of the thick mass of sediments deposited in a geosyncline, softening and weakening them, and thereby localizing deformation by general earth stresses, whatever their origin. The causes of earth movements are discussed in a subsequent section. The foregoing is merely to notice the localization of mountains by crowding near continental margins.

SUGGESTIONS FOR LABORATORY STUDY OF MOUNTAINS

To what extent may the topography be said to be dominantly influenced by folding or faulting or other secondary rock structures in the following areas:

In the southern Appalachians: See U. S. Geological Survey folios, especially Monterey, Va. (folio No. 61), Cranberry, N. C. (folio No. 90), and Rome, Ga. (folio No. 78).

In the Alps: See Mechanismus der Gebirgsbildung, by Albert Heim, 1878, and Geologische Probleme des Alpengebirges, by G. Steinmann: Zeitschrift des Deutschen und Österreichischen Alpenvereins, Vol. 37, 1906.

In the Highlands of Scotland: See The geological structure of the north-west Highlands of Scotland, Mem. Geol. Survey, Great Britain, 1907.

In the Great Basin region: See origin and structure of the Basin Ranges, by J. E. Spurr: Bull. Geol. Soc. Am., Vol. 12, 1901, pp. 217-270; also U. S. Geological Survey folios on this region.

In the Rocky Mountains: See stratigraphy and structure, Lewis and Livingston Ranges, Montana, by Bailey Willis: Bull. Geol. Soc. Am., Vol. 13, 1902, pp. 305-352, and the following U. S. Geological Survey folios: Spanish Peaks, Colo. (folio No. 71), Sundance, Wyo. (folio No. 127), Three Forks, Montana (folio No. 24), Livingston, Montana (folio No. 1), Little Belt Mountains, Montana (folio No. 56).

In the Ozarks: Tahlequah, Ind. Terr., geologic folio (No. 122).

MAJOR UNITS OF STRUCTURE

Geanticlines, Geosynclines, Ocean Basins, Continents, Plateaus, Positive and Negative Elements

In addition to the secondary rock structures and their expressions in mountains, discussed in previous pages, we have to consider certain larger secondary earth structures not ordinarily within the range of our detailed observation or mapping. These are continents, plateaus, ocean basins, geanticlines, geosynclines, positive and negative elements.

The major units of structure of the kind indicated in the above heading require no definition, with the possible exception of geanticlines and geosynclines, and positive and negative elements. Geanticlines are merely anticlines affecting a large area. They differ only in size from anticlines, and the delimiting size is indefinite. Willis¹ has used the name "positive element" for portions of the earth's crust which have tended during geological time to rise and thereby remain uncovered by marine sediments, as contrasted with "negative elements" which have been submerged again and again during geologic history. The pre-Cambrian shield of North America is a positive unit; the Paleozoic area of the Mississippi Valley is a negative element. These divisions are necessarily vague and their boundaries have shifted widely during geologic time.

SHAPES OF MAJOR ELEMENTS OF STRUCTURE

A notable expression of the common tendency toward generalizations from complex facts is the frequent attempt of geologists to read into the lineaments of the earth's surface patterns corresponding to hypotheses of the origin of the earth or earth deformation. One of the best known early attempts at this was the so-called

¹ Willis, B., A theory of continental structure applied to North America: Bull. Geol. Soc. Am., Vol. 18, 1907, p. 390.

tetrahedral theory of the earth. A tetrahedron is a solid body which possesses the greatest possible surface for a given volume. On the hypothesis that the earth's interior is molten and is cooling more rapidly than its shell, it was assumed that the shell would tend to maintain the largest possible area of surface and therefore might take on tetrahedral lineaments. Continental areas and mountain chains would then correspond roughly to the angles and corners of the tetrahedron. By standing a tetrahedron on one of its corners and calling this point the south pole, the three upper corners and angles are supposed to correspond to the land areas surrounding the north pole. The three angles extending down toward the south polar point would correspond to the continental ridges of South America, Africa, and Australasia. The dominance of the land area in the northern half of the continent would accord with the dominance of projections in the upper half of the tetrahedron. It is needless to say that this comparison requires some imagination. It is cited merely as illustrative of the several hypotheses offered. Equally good comparisons have been made with other geometric forms.

A more recent generalization is that of Chamberlin,¹ who suggests that the great negative elements of the earth, represented largely by sea areas—the master segments—should be expected to have polygonal outlines corresponding to the primary place assigned them; that the smaller positive segments or continental areas left between these major segments might be expected to have triangular outlines, or at least, fewer angles than the major controlling segments. This hypothesis allows of a greater variety of shapes and it is easier to conceive that continents and sea areas conform roughly to these outlines.

When smaller features, such as mountain chains, are considered, the linear distribution, more or less near and parallel to contacts of positive and negative elements, is obvious. As one notes the great extent and persistence of these linear elements and notes the synchronism of like deformation over large areas, he cannot but suspect that the major earth deformation as a whole may ultimately be reduced to simpler terms than a casual inspection of the irregularities of the surface might suggest.

¹ Chamberlin, T. C., and Salisbury, R. D., *Geology*, Vol. 1, pp. 521-522.

ACTUAL AND APPARENT UPLIFTS

Actual uplift of the earth's crust may come about through the rigidity of the crust, allowing tangential thrust to be transformed into uplift, or through increase in volume. It seems to be demonstrated that the crust is rigid only on a small scale (see p. 145), and that actual uplift, due to rigidity, can affect only a small area. Uplift due to increase in volume may be shown also to have very narrow limits. The larger uplifts are probably apparent, not actual, and may be caused by the lowering of sea levels brought by sinking of earth segments. In other words, the earth movements are dominantly centripetal, and of varying intensity, with the result that certain areas appear to rise.

ULTIMATE FORCES OF SECONDARY DEFORMATION

OUTLINE OF PRINCIPAL THEORIES

Secondary structures, both on a large and small scale, are essentially the result of failure of the earth's crust, and are indeed evidence of this failure. Depending somewhat on one's point of view with reference to the origin of the earth, the stresses causing this failure have been ascribed to the cooling of a thin shell around a liquid core; to the redistribution of temperatures in a solid earth, heat from the center moving to the outer portion faster than radiated from the outer portion into space; to erosion causing a disturbance of equilibrium between different segments, thereby releasing the potential energy available in differences of density in adjacent masses; and to other causes. A consideration of these forces involves a discussion of hypotheses of the origin of the earth, which it is not the purpose here to attempt. We are concerned primarily with the manner in which these forces are localized and directed, not with the ultimate sources of the stresses.

Stripped of detail and modifying considerations there appear to be two main hypotheses to account for deformation of the earth's shell.

First: The cooling and shrinking of the nucleus faster than the shell causes the shell to collapse. In collapsing, strong tangential thrusts are set up; the rocks become deformed primarily by these thrusts, and subordinately by local tensional stresses near the surface. Notwithstanding this failure as a whole, it is conceived that the rocks are sufficiently rigid to transmit thrusts for long distances, developing and maintaining by their rigidity not only mountain ranges, but geanticlines and geosynclines, plateaus, continents, oceanic basins, and other large units of structure. This is the old, and present popular, conception of earth deformation.

Second: Deformation based on quite a different principle is that which results from the disturbance of isostatic equilibrium between the segments of the earth which are of different density. So far

as the different parts of the earth are in isostatic equilibrium, the transfer of loads by erosion from light to heavy segments may so disturb this balance between heavy and light segments as to cause a compensating flow of rock material beneath the surface, resulting in rock deformation. This principle of deformation is independent of that postulated in the preceding paragraph, but the two may be combined in any ratio; one does not necessarily exclude the other.

The first hypothesis emphasizes the strength of rocks, the second, weakness of rocks. The first hypothesis in its simpler features is sufficiently well known not to require further elucidation here. The second is discussed below.

ISOSTASY

SUPPORT OF HYPOTHESIS BY RECOGNITION OF WEAKNESS OF ROCKS

In the past the strength and rigidity of rock masses was supposed to be sufficient to develop and maintain major elevations and depressions of the earth's surface. It was supposed that the shortening of the earth's crust necessarily accounted for the lifting of great areas, possibly even of continental areas, on the arch principle. Gradually it came to be realized that this was demanding too much of the strength of rocks—that rocks in large masses on the scale of the earth are weak. Chamberlin¹ cites calculations to show that a dome, with the curvature of the earth, would support only $\frac{1}{525}$ of its own weight.

The recognition of the weakness of rocks favored the wider acceptance of the hypothesis of isostasy to explain the major inequalities in the earth's surface, namely that the inequalities are due to differences in density of the rock masses—low density of certain rocks, and hence greater specific volume, making them stand higher above the surface than rocks in adjacent areas with greater density and hence smaller specific volume. Continental areas as a whole, then, would be areas with rocks of low density compensated by higher elevations. The sea bottoms would be areas of high densities of rocks compensated by the depressions.

The causes of the differences in density required by the isostatic

¹ Chamberlin, T. C., and Salisbury, R. D., *Geology*, Vol. 1, 1904, pp. 555-556.

theory are not material to the discussion. We are concerned with proof of the *existence* of the differences in density. Parenthetically it may be remarked that Chamberlin believes that according to the planetesimal theory of the formation of the earth the effect of differential weathering and of vulcanism would tend continuously to arrange the densities in the growing earth in their present distribution.¹

DUTTON'S AND GILBERT'S OBSERVATIONS ON ISOSTASY

Dutton² proposed this theory in connection with his study of western mountains. Gilbert,³ analyzing and discussing the gravity determinations of Putnam of the Coast and Geodetic Survey, concluded "the measurements of gravity appear far more harmonious when the method of reduction postulates isostasy than when it postulates high rigidity. Nearly all the local peculiarities of gravity admit of simple and rational explanation on the theory that the continent as a whole is approximately isostatic, and that the interior plain is almost perfectly isostatic."

HAYFORD'S OBSERVATIONS ON ISOSTASY

Many more observations of the Coast and Geodetic Survey⁴ under the immediate charge of Mr. John F. Hayford, have made it possible to state more definitely to what extent any large portion of the United States meets the requirements of isostasy. At some hundreds of stations in the United States the deflection of the plumb bob from the astronomic vertical was determined. With the aid of topographic maps, the lateral pull upon the plumb bob by topographic elevations was calculated, without, of course, assigning any deficiency of density to the elevated areas. The calculated deflection from the vertical, under the influence of the topography, was in each case found to be much larger than the actually observed deflection, though usually in the same direction. The obvious

¹ Chamberlin, T. C., and Salisbury, R. D., *Geology*, Vol. 2, 1906, pp. 106-110.

² Dutton, C. E., On some of the greater problems of physical geology: *Bull. Phil. Soc. of Wash.*, Vol. 11, 1889, pp. 51-64.

³ Gilbert, G. K., Notes on the gravity determinations reported by Mr. G. R. Putnam: *Bull. Phil. Soc. of Wash.*, Vol. 13, 1895, p. 73.

⁴ Hayford, John F., *The figure of the earth and isostasy from measurements in the United States*. Washington, 1909. Also *Supplementary investigation in 1909 of the figure of the earth and isostasy*. Washington, 1910, and *The effect of topography and isostatic compensation upon the intensity of gravity*. Washington, 1912.

inference was that there is a counteracting pull downward due to excess of density at that point; in other words, that there is excess of density in the topographic depressions corresponding to deficiencies in the elevations. The following quotation is from Hayford:

“The logical conclusion from the study of the geoid contours for the United States, taken in connection with the fact already noted that the computed topographic deflections are much larger than the observed deflections of the vertical, is that some influence must be in operation which produces an incomplete counterbalancing of the deflections produced by the topography, leaving much smaller deflections in the same direction. . . .”

“Both the general approximate studies for the whole world of the necessary effects of the known topography in producing deflections of the vertical, and the detailed exact study made for the United States alone, by means of computed topographic deflections and geoid contours, indicate that one must look to the distribution of the subsurface densities for an explanation of the discrepancies between observed deflections of the vertical and the deflections which must inevitably be produced by the topography. Moreover, from the general considerations set forth in the preceding paragraphs, it seems that there must be some general law of distribution of subsurface densities which fixes a relation between subsurface densities and the surface elevations such as to bring about an incomplete balancing of deflections produced by topography on the one hand against deflections produced by variation in subsurface densities on the other hand.

The theory of isostasy postulates precisely such a relation between subsurface densities and surface elevations. . . .”

“Keeping this contrast in mind, the writer believes that the stress-differences in and about the United States have been so reduced by the isostatic compensation that they are less than one-twentieth as great as they would be if the continent were maintained in its elevated position and the ocean floor maintained in its depressed position by the rigidity of the earth. . . .”

“It is certain, from the results of this investigation, that the continent as a whole is closely compensated, and that areas as large as States are also closely compensated. It is the writer’s belief that each area as large as one degree square is generally

largely compensated. The writer predicts that future investigations will show that the maximum horizontal extent which a topographic feature may have and still escape compensation is between 1 square mile and 1 square degree. This prediction is based, in part, upon a consideration of the mechanics of the problem.”¹

EARTH MOVEMENTS IN RELATION TO ISOSTASY

When one keeps in mind the fact that erosion is continuously shifting the load, and that there is local evidence of the erosion of thousands of feet of sediments, it must be inferred, if there is the present high degree of isostatic adjustment postulated above, that the process of isostatic adjustment is a continuous one, accomplished by deep-seated rock flow keeping pace with the transportation of surface material. Movements thus initiated should cause other movements, principally near the contacts of the positive elements of low density with the negative elements of high density (see p. 141). Initial dip of sediments in these areas would still further localize deformation.

ISOSTASY IN RELATION TO RIGIDITY OF ROCKS

If the United States, as well as certain other parts of the world, is in a state of isostatic equilibrium to such a remarkable degree, it would follow that the major irregularities of the surface are not due to the rigidity of the rocks, but rather to their weakness. If their rigidity were sufficient to account for the irregularities, there would be no need of the theory of isostatic adjustment to explain them, and there would be great variations from such a state of equilibrium. Isostasy and rigidity are mutually exclusive on any large scale. If the rocks were adequately rigid, it would be impossible for them to yield sufficiently to accomplish a delicate isostatic adjustment. But rigidity is effective to some extent, notwithstanding this tendency toward adjustment, for small units—to what extent is still an open question.

Rigidity is sufficient to account for periodicity in major earth movements. During long periods of quiet the rocks seem to have

¹ Hayford, John F., *The figure of the earth and isostasy from measurements in the United States: Coast & Geodetic Survey, Washington, 1909*, pp. 65, 66, 166, and 169.

been sufficiently rigid to have allowed the enormous stresses to accumulate which found expression in mountain-making periods.

DEPTH OF ISOSTATIC COMPENSATION

The differences in density postulated by isostasy cannot be expected to extend downward indefinitely; in fact, the theory was developed to accord with the then prevailing notion that beneath the solid shell was a liquid or a near-liquid substratum upon which the shell rested or floated. The depth through which the differences of density were supposed to extend has been called the depth of compensation. A plane at this depth would support equal weights of material above, regardless of their density; below this, the density is supposed to be uniform. Postulating the existence of such a plane of complete compensation, Hayford assumed various arbitrary depths in order to find out which one corresponded most closely to the facts of the gravity observations. For each of the arbitrary depths calculated, three alternative distributions of density were assumed—1st, uniform distribution of density to the depth of complete compensation; 2d, a gradually diminishing difference in density to this depth; 3d, a maximum difference in density at some intermediate point. Depending on distribution of density chosen, the depth of complete compensation was calculated to be between 60 and 150 miles. With a uniform distribution of density a depth of compensation of 76 miles was found best to correspond with the plumb bob observations. The discrepancies are so slight that Hayford concludes that the area of the United States falls one-tenth short of complete isostatic adjustment.

CRITICISM OF THEORY OF ISOSTASY

Unquestionably the plumb bob deflections show the existence of some sort of isostatic compensation, the higher areas having lower density and the lower areas having higher density; but it is questionable whether the compensation is as complete as indicated by Hayford. Lewis¹ has called attention to the fact that the conception of the existence of a plane of complete compensation by Hayford is an assumption, as in fact is so stated by Hayford; that having found the depth of such an hypothetical plane which would

¹ Lewis, Harmon, *The theory of isostasy*: Jour. Geol., Vol. 19, 1911, pp. 603-626.

most nearly satisfy the requirements of the inferences from observation, it is not permissible in turn to use this hypothetical depth as a standard against which to measure variations from the requirements of the assumption of isostatic compensation at this depth. It is, in effect, reasoning in a circle. Lewis showed that similar close accord with the observations could be secured by assuming partial compensation at less depths, or over-compensation at greater depths. In other words, while the facts clearly indicate some sort of compensation, they do not so clearly discriminate between complete compensation, under-compensation, and over-compensation. Rigidity of the rocks is known at the surface to play some part—it may be a considerable part—in preventing complete isostatic adjustment. In so far as it is important, it favors the assumption of under-compensation or over-compensation, rather than complete compensation.

Hayford's reply to this argument is that the actual detailed observations and computations yield results more nearly accordant with his assumption of complete compensation than with assumptions of over-compensation or under-compensation.¹

From the geological standpoint there are difficulties in the way of the complete acceptance of the theory of isostasy because of the fact that areas of uplift and depression or areas of erosion and deposition have not been continuously such during geological history; a given area is likely to be one of alternate uplift and depression and of alternate erosion and deposition. If uplift and depression are related to density, as assumed by the isostatic theory, these alternations of uplift and depression require alternations of states of density, which is not satisfactorily explained under the isostatic theory.

There seems also to be objection on the ground that differences in density could not be maintained, especially in the zone of rock flowage, and therefore would not for long be a source of deformation. If, on the other hand, the rocks are rigid enough to maintain these differences in density, and the loading of the denser segments by sedimentation is sufficient to start movement toward the lighter segments, the question naturally arises as to the reason for the absence of movement in the opposite direction before the erosion

¹ Hayford, John F., *Isostasy, a rejoinder to the article by Harmon Lewis*: Jour. Geol., Vol. 20, 1912, pp. 562-578.

and deposition took place. If there was isostatic equilibrium in the first instance, then at some point *above* the plane of compensation, whether it was complete or partial, stresses must have been acting from the lighter and higher segments toward the heavier and lower. According to the theory of isostasy rocks are rigid enough to prevent this actual movement; and yet it is argued that movement should occur when the situation is reversed and stresses of equal (or less?) magnitude are set up in an opposite direction by erosion of the lighter segments and deposition on the heavier ones.

The fact of high areas being light and low areas being dense does not necessarily imply that the difference in density is the *cause* of the differences in elevation or deformation. This latter may be an incidental accompaniment or may be the result of deformation by thrust or gravity. Deformation of rocks under thrust or gravity stresses is localized in the weakest places. It may be, then, that the light areas are weaker than the heavy ones. They would tend, therefore, to be folded and crowded up. In one sense, then, the high areas may be high because they are light and weak; but this is quite a different conception of the nature and causes of deformation from that postulated by isostasy. The facts cited to support isostasy are fully as well in accord with such an alternative hypothesis of deformation.

Again, it is possible that light areas are light because they are high, and not high because they are light. The processes of katamorphism, which increase the volume and decrease the density of rocks, affect higher areas to a greater extent than lower water-covered areas. This is undoubtedly a real factor, but whether sufficiently important to explain any considerable part of the observed differences in density is not yet known.

The inference from gravity observations that high areas are generally light, applies principally to broad areas of uplift and not to the minor units of structure. The highest peaks are determined essentially by their resistance to erosion and not alone by their density. In certain parts of central Brazil the highest peaks are hard hematite, with a specific gravity of 5, which happens to be the most resistant material in this region. These particular peaks would not be explained on the isostatic principle, but when taken in connection with the broad area of uplift of which they are a part, the principle might still hold.

It may be concluded that a condition of isostasy exists, but to what degree is still a matter of doubt. The disturbance of this condition is a probable factor in the deformation of rocks, but there are other important and perhaps more important factors.

CAUSES OF TENSION

In the above discussion of major causes of the earth's deformation nothing has been said about tension, for in fact the major deformation of the earth has been by tangential compression, resulting in mountain chains and overthrust faults, whereas tension structures have been usually regarded as local and subsidiary. In connection with the discussion of tension joints and tension faults on previous pages (see pp. 22, 39) local conditions causing tension have been cited. That tension is present on any large scale is not certain.

Neither the so-called contractional theory of earth deformation or the theory of isostasy discussed above imply the existence of tension in our zone of observation as anything but subsidiary and consequent upon thrusts. Under the contractional theory tension is produced in the earth's shell when the circumferential shortening by cooling predominates over compression and thrust in the shell due to radial shortening. At the surface and to a depth of a few miles, the circumferential contraction by cooling is at a minimum, whereas thrust due to collapse of the shell is at a maximum. Deeper below the surface cooling is going on more rapidly and it is supposed that the circumferential shortening, involving tension, may predominate over a thrust, though at this depth rock flowage might prevent actual tensional openings. At some intermediate depth, called the level of "no strain," it has been presumed that the circumferential shortening just equalized the thrust due to collapse and there would be no lateral tension or compression. This theory therefore implies no general state of tension within our zone of observation.

The deformation involved in the disturbance of isostasy likewise does not imply tension except locally.

CONCLUSION AS TO MAJOR CAUSES OF DEFORMATION

We conclude that earth deformation is principally due to gravity, locally transformed into thrust, and causing a collapse

and buckling of the earth's shell; that the known differences in density between higher and lower areas indicate some sort of an isostatic adjustment; that this isostatic adjustment may be an accompaniment or result of mechanical thrust, or that it may be an initial condition, the disturbance of which by erosion would cause deformation, independent of any major thrust due to the collapse of the earth's shell; that tension is local and subsidiary to thrust.

This conclusion throws some emphasis on the competence of the earth to transmit thrusts and to cause and sustain large uplifts. It is believed that this is possible: (1st) because of the competence of the beds of the zone of rock fracture, and (2d) because of the actual squeezing up of the rock material from below in the zone of flow, this squeezing possibly affecting the lighter rather than the heavier material. There seems to be no reason why the crowding together of material by rock flowage in a deep-seated zone should not account for major uplifts in which the surface buckling seems small, as in the Cascade Range. The great pressures in the zone of rock flowage may impart a high degree of rigidity to the mass capable of transmitting thrusts—in spite of the fact that the rock flows.

Whatever the cause of deformation, it is apparent that the earth's shell is, as a whole, a weak or failing structure. The secondary structures which have been described are evidences of failure. Rigidity has not prevented failure except for the smallest units—it has postponed failure, and favored a certain periodicity to earth movements.

LOCAL AND MINOR CAUSES OF DEFORMATION

Weathering involves increase in volume of some rocks. This increase in volume sets up compressive strains sufficient for minor local deformation. Some minor folding has been attributed to this cause.¹

The purely mechanical effects of heating and cooling at the surface are known to produce local deformation. (See pp. 22, 25.)

Removal of a load by erosion from a rock under compressive strain (for whatever cause) may give sufficient relief to allow def-

¹ Campbell, D. F., Rock folds due to weathering: *Jour. Geol.*, Vol. 14, 1906, pp. 718-721.

ormation of the rock. It is not uncommon in quarry and other underground excavations for rocks to swell and buckle when the superimposed pressure is removed.

Unconsolidated sediments in a drift may be deformed when crowded or overridden by a glacier. Overthrust folds may be thus developed.

RELATION BETWEEN DEFORMATION AND VULCANISM

In regions of igneous rocks evidences of rock deformation are likely to be unusually numerous and conspicuous. For instance, cleavage is sometimes well developed in rocks which have been intruded by a great batholith, as in the Black Hills area of South Dakota. Joints and faults are abundant in areas of volcanic activity as is shown in the maps of some of the western mining districts (see p. 43). It is frequently possible to infer that the faulting closely followed and perhaps accompanied the intrusion of the igneous rocks. Shattering of wall rocks near contacts with intrusives is a commonly observed phenomenon. Presumably mechanical pressures and temperature changes combine to produce this result.

Not less obvious is the tendency for igneous rocks when intruded to follow pre-existing joint and fault planes or to be deflected in their course by folds. The association of vulcanism with mountains is well known.

Earthquakes are both the cause and result of rock deformation. Some earthquakes are related to vulcanism both in time and place (see page 70).

These various relations indicate a genetic relationship between secondary structures and igneous activity. A broader view of the situation is that both vulcanism and the development of secondary structures are closely related effects of great earth movements. It has been shown to be probable that deep in the zone of flowage rocks are at such temperatures that they would liquefy if the pressure upon them were not so great. A change of conditions resulting from any great earth movement, whatever its cause, may tend to disturb the equilibrium between pressure and temperature and allow the rock to liquefy. Having then less density than the unliquefied rocks, it moves upward.

From this point of view both vulcanism and secondary deformation are the results of great readjustment in major segments of the earth's shell. Looked at on a smaller scale, vulcanism and deformation are found to have mutually reacted, with the result that either may be in a causal relation to the other, as in the illustrations given above.

UNCONFORMITY

Contiguous formations are said to be unconformable when there is evidence of an erosion interval of some magnitude between their periods of formation or evidence of cessation of deposition between them. In either case there is loss of part of the geological record. The term unconformity is sometimes used to indicate primarily

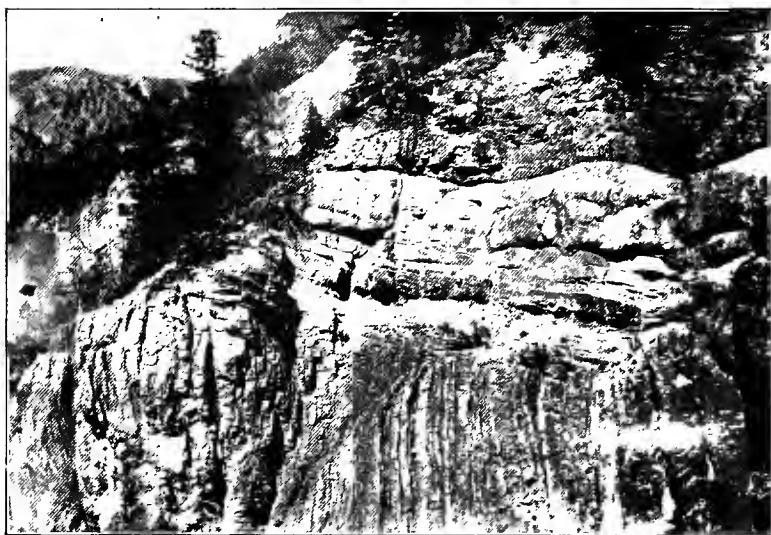

FIG. 66. Horizontally bedded limestone, resting unconformably on vertical beds of Proterozoic quartzite. Box Canyon, near Ouray, Colo. After R. T. Chamberlin.

the physical discordance; sometimes it is applied principally to the time interval implied by the discordance; it usually implies both. The evidences of unconformity cited below are both physical and organic. The secondary deformation of rocks with which this book is mainly concerned is only one of the factors to be considered in unconformity. Stratigraphy, physiography and paleontology are others,—in fact adequate understanding of the significance of

unconformity involves the widest range of geological knowledge. The subject is treated here principally in its relation to structural geology, and not in the broader sense that it is required for a philosophical understanding of its significance. Involving, as it does, considerations other than structural, it has been left to the last chapter.

IDENTIFICATION OF UNCONFORMITY

Physical evidences of unconformity are:

(1) *Evidence of erosion*, even without intervening deformation between formations.

(2) *Difference in Metamorphism*:—Stratigraphically lower rocks may have suffered so much more metamorphism than overlying

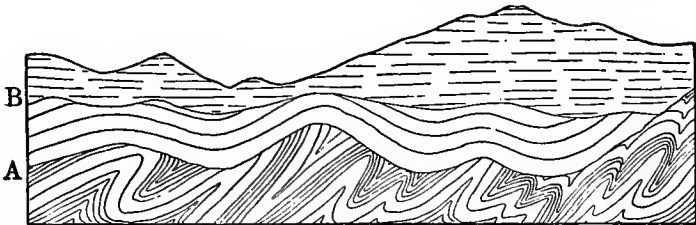

FIG. 67. Ideal sketch to illustrate unconformities. After Spurr. A. Earlier line of conformity; B. Later line.

beds of similar lithology as to indicate the probability of a time interval between them. Original differences in lithology also influence the nature and extent of metamorphism. This fact should not be overlooked.

(3) *Difference in Deformation*:—Stratigraphically underlying rocks may be folded or cracked or may be schistose as result of flowage, while these features may be less conspicuous or lacking in upper beds of similar kinds, indicating a time interval between their periods of formation. This criterion must be carefully used, for the differences in deformation may be due simply to varying competence of the different beds.

(4) *Difference in Number of Igneous Intrusions*:—Stratigraphically underlying beds may be intruded by igneous rocks, which have not intruded the upper beds. This may not in itself be evidence of unconformity, but may confirm other evidences of the

existence of an erosion interval between lower and upper beds. If the igneous rock in the lower bed is a plutonic rock and appears on the contact erosion plane, it is evidence that the erosion interval has been of sufficient duration to allow of the removal of a great thickness of rock.

(5) *Basal conglomerate* in the upper beds, carrying fragments from the rocks beneath the contact plane. If this conglomerate contains a variety of fragments derived from a considerable area, it is more significant of a time interval perhaps than a conglomerate made up of fragments entirely like the immediately underlying rock. However, if the underlying rocks are homogeneous over great areas, the overlying basal conglomerates may show a marked homogeneity of fragments. Intraformational conglomerates are sometimes formed by exceptional storms or other causes, in the course of a continuous deposition of sediments. Such conglomerates mark no erosion interval of magnitude and have little significance with reference to unconformity.

While a basal conglomerate indicates unconformity, the absence of such a conglomerate does not disprove unconformity, for students of sedimentation now find many conditions under which sediments may be deposited unconformably on an older surface without intervening conglomerates. The base of the Paleozoic in the Mississippi Valley as a whole is remarkably free from basal conglomerates except near monadnocks on the old pre-Cambrian peneplain. The Niagara limestone resting on the pre-Cambrian rocks of the Cobalt district of Ontario furnishes a fine example of unconformable contact without basal conglomerate.

(6) *Field relations* and areal distribution of rocks may indicate an unconformity even where actual contacts or other evidences are lacking. For instance, a continuous bed of quartzite lying alongside of a heterogeneous group of rocks with irregular distribution would in itself suggest unconformity between these rocks and the quartzite. This criterion of field relations is of the utmost practical importance. It is frequently possible from a preliminary study of maps showing areal distribution of lithologic types to infer possible unconformities, and if so, to direct further field work with much greater effectiveness than would otherwise be possible.

(7) *Difference in lithology*; as, for instance, where a sedimentary rock rests upon an igneous rock without intrusive relations.

(8) There may be an *irregular erosion surface* separating parallel strata. Differences in lithology on the two sides of the contact or fossil evidence may aid in determining this surface.

(9) *Hiatus in the fossil record* between successive beds.

(10) *Absence of rocks* between successive beds known elsewhere to have been deposited in this relation.

Commonly the greater number of these criteria can be used in working out unconformity. One line of evidence can usually be substantiated by others.

INTERPRETATION OF UNCONFORMITY

Unconformity represents a lost interval not otherwise recorded at that place. This lost interval may involve (a) a cessation of deposition, usually involving emergence, and often accompanied by deformation of the rocks; (b) denudation, usually by subaërial processes; (c) resumption of deposition, usually following submergence, but often by terrestrial processes.¹

The appraisalment of the value of an unconformity requires much care. The terms "great" and "slight" frequently applied to unconformity, express the value very crudely. By great unconformity may be meant one in which there is a prominent discordance of structure, or one indicating the absence of great thicknesses of strata, or a long lapse of time, or any combination of these features. Usually it is intended to imply that the discordance is pronounced and that there is a great loss of record. It is desirable, wherever possible, that these factors be discriminated, even though their quantitative value cannot be determined.

The study of unconformities broadly as continental features is of significance to structural geology as indicating the major warpings and oscillations of the continent with reference to the sea. If oceanic basins have been permanent during geological time, it may be supposed that there are no unconformities indicated by strata there deposited. However meager, the record may be one of continuous deposition. The continents, however, from the beginning of the geological record have always in some part stood above water, have in some part been undergoing erosion, and therefore

¹ Blackwelder, Eliot, The valuation of unconformities: Jour. Geol., Vol. 17, 1909, p. 290.

fall short of a complete record of deposition. By migrating from place to place during continental movements, animals might conceivably have lived continuously on the erosion surfaces which marked unconformities in the geologic record. Thus it appears

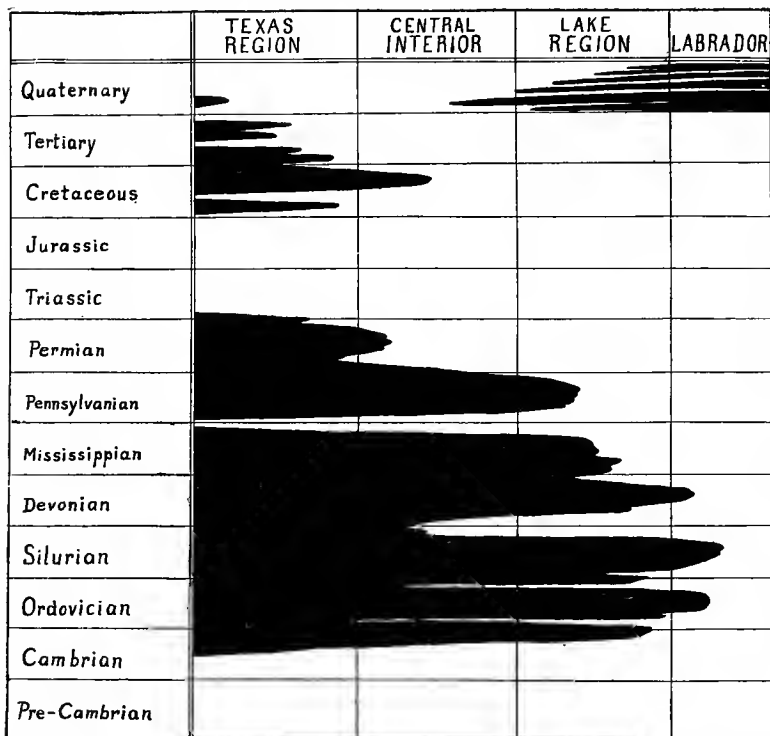

FIG. 68. Diagram of an unconformity with lateral extensions and restrictions. After Blackwelder. The extent and duration of the principal periods and areas of sedimentation, with their corresponding rock systems, are shown in solid black. The white, on the other hand, denotes the time and extent of erosional conditions and corresponding unconformities.

that in one sense unconformities are continuous physically and chronologically; but they shift back and forth across the continents with successive oscillations and inundations. It is equally true that any localized unconformity is represented somewhere else by a continuous record of deposition. As Blackwelder states it: "The entire geologic record, then, is not to be conceived of as a pile of

strata, but as a dovetailed column of wedges, the unconformities and rock systems being combined in varying proportions. The former predominate in some places and periods, while the latter prevail in others.”¹

SUGGESTIONS FOR LABORATORY STUDY OF UNCONFORMITY

1. What different kinds of contacts, and, therefore, different relations between rock masses, can be found on the Three Forks and Livingston, Montana, geologic maps? (geologic folios U. S. Geol. Survey, Nos. 24 and 1).

2. What different kinds of field evidence for unconformity can be found on the following geologic maps: Three Forks, Montana (geologic folio No. 24, U. S. Geol. Survey), Holyoke, Mass. (geologic folio No. 50, U. S. Geol. Survey), Milwaukee, Wis. (geologic folio No. 140, U. S. Geol. Survey), Mount Stuart, Wash. (geologic folio No. 106, U. S. Geol. Survey), Hartville, Wyo. (geologic folio No. 91, U. S. Geol. Survey), maps of the Mesabi, Gogebic and Marquette districts of Lake Superior (Mon. 52, U. S. Geol. Survey).

3. The historical significance of various unconformities:

- a. On the Hartville, Wyo., geologic map (geologic folio No. 91, U. S. Geol. Survey) determine the stratigraphic hiatus in terms of formations, at several different points in the district.
- b. The same for relative degree of discordance between the beds.
- c. By studying the geologic maps in the following U. S. Geological Survey folios determine as closely as possible the time value of the unconformity at the base of the coastal plain in eastern United States: Trenton, N. J. (folio No. 167), Washington, D. C. (folio No. 70), Mercersburg-Chambersburg, Pa. (folio No. 170), Rome, Ga. (folio No. 78), and Knoxville, Tenn. (folio No. 16).

¹ Op. Cit., p. 299.

INDEX

- Adams, F. D., 4, 5, 6, 7, 9, 10, 11, 88, 89, 90, 92, 100, 102
- Adams, L. H., 76
- Adirondack graphite deposits, sedimentary origin of, 99
- Alabama. *See* Gadsden
- Alaska, earthquakes at Yakutat Bay, 70; fault scarp, 58; folded schist, 112; fracture cleavage, jointing and flow cleavage in graywacke and slate, 65
- Alps, "decken" structure and folding, 106, 117, 138; faults, 60, 137; topography influenced by folding or faulting, 140
- Anthracite - Crested Butte folio, faults, 60
- Anorthosite, Morin, granulation, 88, 90
- Appalachians, northern, depth of folds, 125
- Appalachians, southern, absence of fault scarps, 59; compression joints, 23; contrast between fracture and flow, 13; determination of fault displacements, 38; distributive and thrust faults, 46, 48, 137; folded thrust fault planes, 51, 54; folding, 111, 124, 137, 138; intimate relation of thrust faults and overthrust folds, 51; sliced feldspars in micaceous and chloritic schist, 83; topography influenced by folding or faulting, 140. *See also* Piedmont Plateau
- Arizona, faults, 44, 57. *See also* Clifton, Globe, Grand Canyon
- Atwood, W. W., 60, 133
- Autoclastics, 64
- Baltimore gneisses of Piedmont Plateau, 98
- Bannock overthrust in southeastern Idaho, 51, 60
- Baraboo district, Wisconsin, folding of slate, 129; fracture cleavage and jointing in quartzite, 23, 24, 26, 31, 64, 121; vertical section of Illinois Mine, 129
- Barlow, A. E., 100
- Bascom, F., 98
- Basin Ranges, faults in, 43, 44, 56, 57, 58, 137; laboratory study of mountains, 140; tension joints in, 22. *See also* Utah, Nevada, Arizona
- Basins, ocean, 141
- Bastin, E. S., 99, 100, 101
- Becker, G. F., 15, 29, 30, 44, 45, 77, 85
- Bisbee district, Arizona, faults, 53, 60
- Black Hills, South Dakota, chloritoid crystal in micaceous and quartzose schist, 91; cleavage, 63, 154; photomicrograph of slate, 63
- Blackwelder, Eliot, iii, 159, 160
- Box Canyon, Colorado, unconformity, 156
- Brazil, determination of rocks by washing, 99; peaks of hematite, 151
- Breccias, 64
- Bristol folio, Virginia, folding, 134
- British Columbia, folding, 127
- Buckley, E. R., 17

- Buffalo Mountain, Tennessee, theoretical section, 52
- Bullfrog district, Nevada, fault displacements, 39; extension by faulting, 56; hinge faults, 42
- Butte district, Montana, determination of fault displacements, 39
- Cadell, H. M., 49, 51
- California. *See* Mother Lode, Santa Cruz, Yosemite Valley
- California earthquake, faults, 44, 50, 57, 59
- Campbell, D. F., 153
- Carolina gneiss of Piedmont Plateau, 98
- Cascade Mountains, Washington, method of determining depth affected by folds, 125, 127; cause of uplift, 153
- Chamberlin, R. T., 125, 126, 127, 156
- Chamberlin, T. C., 36, 40, 44, 53, 54, 121, 125, 127, 139, 142, 145, 146
- Cleavage crossing bedding, 94, 95. *See* Flow Cleavage, Fracture Cleavage
- Clifton district, Arizona, faults, 42, 53
- Cloud Peak-Fort McKinney folio, folding, 134
- Clough, C. T., 49
- Cobalt district, Ontario, fractures in gabbro, 22; identification of conglomerate, 66; unconformity, 158
- Coker, E. G., 92
- Colorado. *See* Anthracite-Crested Butte, Box Canyon, Georgetown, Silverton, Spanish Peaks
- Compression fractures, 16, 21
- Compression joints, 23
- Conglomerate, identification of, 66
- Connecticut. *See* Pomperaug Valley
- Continents, 141
- Cranberry folio, North Carolina, laboratory study of mountains, 140
- Crosby, W. O., 67
- Crystalloblastic structure, 77
- Cushing, H. P., 36
- Cuyuna district, Minnesota, observations on folding, 113
- Dale, T. Nelson, 26, 27, 31, 64
- Dalles of Wisconsin, drainage controlled by joints, 30; false bedding in sandstone, 133
- Daly, R. A., 127
- Dana, James D., 105
- Daubree, A., 15, 29
- Day, Arthur L., 29, 77, 85
- Decken structure, 117
- Deformation, ultimate forces of, 145
- Deformation and vulcanism, 154
- Derby, O. A., 99
- Distributive fault, 48
- Ducktown, Tennessee, sedimentary origin of gneisses, 98
- Dutton, C. E., 146
- Earthquakes, 67; and glaciers, 67; and magnetic disturbances, 70; and rock density, 70; and vulcanism, 70; as cause and effect of rock fractures, 67; location of, 73; prediction of, 74; seismograph, 71; waves, 72; waves in relation to earth's interior, 72; zones, 71
- Emmons, W. H., 39, 42, 56, 98
- Evans, John W., 36
- Faults, 31; correlation of, 53; displacements, apparent and real, 36, 50; distributive thrust, 48; evidence of, 56; folded, 51; grading into folds or flowage, 51; hinge, 50; laboratory study, 60; nomenclature of, 32; normal, 39; normal, associated with folds, 43; normal, associated with igneous rocks, 42; normal, in intersecting systems, 44; normal, in unfolded sediments, 43; number of reverse and normal, 54; pivotal, 50; relative shortening

- and elongation of the earth's crust by, 55; reverse or thrust, 46; surface expression of, 57. *See also* Fractures
- Fissility. *See* Fracture Cleavage
- Flow and fracture, conditions, 4; distribution, 2; kinds, 2; surface expression of zones, 3, 12; volume changes, 11
- Flow cleavage, 76; and folds, 119, 129; and pressure, 83
- Flowage. *See* Rock Flowage
- Folds, 104; definitions, 104; depth, 124; differential movement on limbs, 114; elements, 104; field observations, 127; fracture and flow contrasted, 108; laboratory study, 134; minor drag, 114, 128; relation to cleavage, 119, 128; relation to joints, 121; relation to faults, 43, 51; strike and dip observations, 127
- Forces of secondary deformation, 144
- Fractures, 14, 19; tension, 14, 20. *See also* Joints, Faults
- Fracture cleavage, 61; compression, 16, 21; in relation to earthquakes, 67
- Fracture and flow. *See* Flow and Fracture
- Front Range, Colorado, folding, 138
- Front Range, Montana, thrust faults, 53
- Futterer, Karl, 82
- Gadsden folio, Alabama, evidences of fracture and flow, 13
- Garrey, G. H., 39, 42, 56, 98
- Geanticlines, 141
- Geikie, Archibald, 49
- Georgetown area, Colorado, sedimentary origin of gneiss, 98
- Georgia. *See* Rome
- Geosynclines, 141
- Gilbert, G. K., 3, 44, 50, 57, 58, 59, 65, 75, 146
- Glaciers and earthquakes, 67
- Globe district, Arizona, correlation of faults in, 53
- Gneiss, criteria for origin, 87, 97
- Gneissic structure, 87
- Gogebic district, Michigan, evidences of fracture and flow, 13; unconformity, 161
- Goldfield district, Nevada, hinge faults in, 42
- Grand Canyon, drainage controlled by joints, 30, 31
- Granulation in rock flowage, 82
- Grubenmann, U., 77
- Gunn, W., 49
- Hallock, William, 7, 9
- Harder, E. C., 31
- Harrisburg, Pennsylvania, section from, to Tyrone, 125, 126
- Hartville folio, Wyoming, unconformity, 161
- Hayford, John F., 146, 147, 148, 149, 150
- Heim, Albert, 3, 106, 117, 118, 140
- Henry Mountains, existence of zones of fracture and flow, 3
- Highlands of Scotland, faults, 39, 49, 51, 60, 137, 140
- Hinge fault, 50
- Hinxman, L. W., 49
- Hobbs, W. H., 44
- Holyoke folio, Massachusetts, unconformity, 161
- Hoosac, Massachusetts, micaceous and quartzose schist, 80, 81
- Horne, John, 49
- Hoskins, L. M., 9, 10, 16, 86
- Hotchkiss, W. O., 116
- Hurricane fault scarp, 56, 57, 58
- Idaho, Bannock overthrust in southeastern, 51, 60
- Idiomorphic texture in rock flowage, 90
- Illinois Mine, Baraboo district, Wisconsin, vertical section of, 129
- Imbricate structure, 49

- Indian Territory. *See* Tablequah
- Iron Springs district, Utah, hinge faults in, 50; tension joints in, 23
- Isostasy, 145; criticism of, 149; Dutton's and Gilbert's observations on, 146; Hayford's observations on, 146; in relation to earth movements, 148; in relation to rigidity of rocks, 148
- Isostatic compensation, depth of, 149
- Jaggard, T. A., 36
- Johnston, John, 76
- Joints, 21, 25; and folds, 121; compression, 23, 28; in intersecting systems, 44; laboratory work on, 31; of unknown origin, 28; surface expression of, 30; tension, 22, 26; widened by growing crystals, 29. *See also* Fractures
- Kaibab fault, Utah, 51
- Keith, Arthur, 51, 52, 96, 98
- Kick, Friedrich, 4
- Kingston earthquake, 72
- Knoxville folio, Tennessee, unconformity, 161
- Laboratory study of faults, 60; folds, 134; joints, 31; mountains, 140; unconformity, 161
- Lake Superior Region, fracture and flow contrasted, 13; gneisses of, 102; identification of tuffs, 66; identification of schists, 103
- Laney, F. B., 98
- Laurentian area north of Montreal, leaf gneiss from, 89
- Lawson, A. C., 60
- Leaf gneiss north of Montreal, 89
- Lehmann, Johann, 102
- Leith, C. K., 66, 76
- Lewis and Livingston Ranges, laboratory study of mountains, 140; thrust faults, 53
- Lewis, Harmon, 149, 150
- Limestone Cove, Tennessee, theoretical section, 52
- Lindgren, Waldemar, 42
- Little Belt Mountains folio, Montana, laboratory study of mountains, 140
- Little Falls, Minnesota, slaty cleavage crossing bedding, 94
- Livingston folio, Montana, laboratory study of mountains, 140; unconformity, 161
- Livingston Range. *See* Lewis
- Lugeon, M., 117
- Magnetic disturbances and earthquakes, 70
- Maine, granites, 31
- Mansfield, G. R., 51, 60
- Marquette district, Michigan, correlation of structures, 113, 115; evidences of fracture and flow, 13; unconformity, 161
- Martin, Lawrence, 58, 70
- Massachusetts, granites, 31. *See also* Holyoke, Hoosac
- Mathews, E. B., 98
- Maynardville, folio, Tennessee, folding, 134
- Mead, W. J., iii, 119
- Mediterranean earthquake zone, 71
- Menominee district, Michigan, folding, 117, 134; origin of green schists, 101
- Mercersburg-Chambersburg folio, Pennsylvania, unconformity, 161
- Mesabi district, unconformity, 161
- Messina earthquake, 71
- Michigan. *See* Gogebic, Lake Superior, Marquette, Menominee
- Milch, L., 77
- Milne, John, 69, 72, 73
- Milwaukee folio, Wisconsin, unconformity, 161
- Minnesota. *See* Cuyuna, Lake Superior, Little Falls, Mesabi, St. Louis, Vermilion

- Mississippi Valley, basal conglomerate, 158
- Montana. *See* Front Range, Lewis and Livingston Ranges, Little Belt Mountains, Three Forks
- Monterey folio, Virginia, folding, 134; laboratory study of mountains, 140
- Montessus de Ballore, F. de, 71
- Montreal, leaf gneiss, 89
- Morin anorthosite, granulation of, 88
- Morristown folio, Tennessee, faults, 60; folds, 134
- Mother Lode district, California, widening of joints, 29
- Mount Mitchell folio, North Carolina, folding, 134
- Mount Stuart folio, Washington, unconformity, 161
- Mountains, 136; laboratory study, 140; localization of, 138; types of, 136
- Negative elements, 141
- Nevada, faults in, 44, 57. *See also* Bullfrog, Goldfield, Great Basin, Tonopah
- New Hampshire, granites, 31
- New Jersey. *See* Trenton
- New Mexico. *See* Watrous
- Nicolson, J. T., 92
- Normal faults, 39. *See also* Faults, normal
- North Carolina. *See* Cranberry, Mt. Mitchell, Pisgah, Roan Mountain
- Ocean basins, 141
- Oelrichs folio, South Dakota, folding, 134
- Ontario. *See* Cobalt
- Oregon. *See* Cascade
- Ozarks, topography influenced by folding or faulting, 140. *See also* Tahlequah
- Pacific earthquake zone, 71
- Peach, B. N., 49
- Pennsylvania, method of determining depth affected by folds, 125. *See also* Mercersburg, Piedmont Plateau, Tyrone
- Pfaff, F., 7, 9
- Piedmont Plateau, cleavage, 120; folding, 111; fracture and flow contrasted, 13; sedimentary origin of gneisses, 98. *See also* Appalachians, southern
- Pisgah folio, North Carolina, evidences of fracture and flow, 13
- Pivotal fault, 50
- Plateaus, 141
- Pomperaug Valley, normal faults in intersecting systems, 44
- Porphyritic texture in rock flowage, 90
- Positive elements, 141
- Protoclastic structure, 87
- Putnam, G. R., 146
- Ransome, F. L., 39, 41, 42, 56
- Reverse faults. *See* Faults
- Rhode Island, granites, 31
- Richards, R. W., 51, 60
- Ringgold, folio, Georgia, folding, 134
- Ripple marks, 131
- Roan Mountain folio, North Carolina, evidences of fracture and flow, 13; faults, 48, 52, 60; folded thrust fault planes, 51
- Rock density and earthquakes, 70
- Rock flowage, 76; evidence for the existence of zone, 3; grading into faulting, 51; obliteration of textures, 93; without cleavage, 92
- Rome folio, Georgia, laboratory study of mountains, 140; unconformity, 161
- Rotation in rock flowage, 82
- Salisbury, R. D., 54, 60, 133, 139, 142, 145, 146
- Santa Cruz folio, California, relations of valleys and lakes to fault displacements, 60

- Saxony area, development of gneisses from granites, 102
- Scandinavian Highlands, faulting, 137
- Schardt, Hans, 117
- Schists, identification, 97
- Schuppen structure, 48, 49
- Scotland. *See* Highlands
- Sierra Nevada Mountains, faults, 44, 137
- Silverton folio, Colorado, faults, 60
- Simplon Tunnel, rock flowage, 1
- Slicing in rock flowage, 83
- South Dakota. *See* Black Hills, Oelrichs
- Southern Appalachians. *See* Appalachians
- Spanish Peaks folio, Colorado, laboratory study of mountains, 140
- Spurr, J. E., 36, 42, 43, 58, 98, 140, 157
- Steidtmann, E., 26, 31
- Steinmann, G., 140
- St. Louis slates, cleavage crossing bedding, 95
- Suess, Edward, 139
- Sundance folio, Wyoming, laboratory study of mountains, 140; folding shown, 134
- Tablequah folio, Indian Territory, laboratory study of mountains, 140
- Tarr, R. S., 70
- Teall, J. J. H., 49
- Tennessee. *See* Bristol, Buffalo Mountain, Knoxville, Limestone Cove, Maynardville, Morristown, Ringgold, Walland
- Tension, causes of, 152; fractures, 14, 20; joints, 22. *See also* Joints
- Terlingua, Texas, topographic map, faulting, 59
- Three Forks folio, Montana, folding, 134; laboratory study of mountains, 140; unconformity, 161
- Thrust faults. *See* Faults
- Tolman, C. F., 36
- Tonopah district, Nevada, faults, 22, 42, 43, 53
- Trenton folio, New Jersey, unconformity, 161
- Trueman, J. D., 78, 89, 100
- Tyrone, Pennsylvania, section, 125, 126
- Unconformity, 156; identification, 157; interpretation, 159; laboratory study, 161
- Uplifts, actual and apparent, 143
- Utah, faults, 44, 57. *See also* Hurricane, Iron Springs, Kaibab
- Van Hise, C. R., iii, 3, 9, 10, 22, 28, 53, 61, 66, 105, 107, 110, 121, 131
- Vermilion district, Minnesota, folding, 117, 128; pseudo-conglomerates, 66
- Vermont, granites of, 26, 31
- Virginia. *See* Monterey
- Vulcanism and deformation, 154; and earthquakes, 70
- Walland, Tennessee, cleavage and bedding, 96
- Wasatch Mountains, Hurricane fault scarp, 56, 57, 58; normal faults, 44, 137
- Washington, D. C., identification of gneiss, 98; unconformity, 161
- Washington State. *See* Cascade Range, Mt. Stuart
- Watrous, New Mexico, joints, 31
- Weed, W. H., 39
- Weidman, Samuel, 129
- Wenatchee-Chelan district. *See* Cascade Range
- Williams, G. H., 99, 101
- Willis, Bailey, 33, 36, 46, 47, 53, 60, 104, 111, 112, 122, 123, 124, 125, 127, 135, 141

- Wisconsin, southwestern joint system, 31. *See also* Baraboo, Dalles, Milwaukee
- Wright, F. E., 84
- Wyoming. *See* Cloud Peak, Hartville, Sundance
- Yakutat Bay, Alaska, earthquakes at, 70
- Yosemite Valley, drainage controlled by joints, 30, 31
- Zone of flow contrasted with zone of fracture, 108

