



# Cornell University Library

THE GIFT OF

*The Author*

A. 175415

16/2/09

arV144 Cornell University Library

An introduction to physiology.



3 1924 031 190 147  
olin,anx

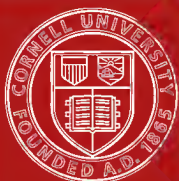

Cornell University  
Library

The original of this book is in  
the Cornell University Library.

There are no known copyright restrictions in  
the United States on the use of the text.

<http://www.archive.org/details/cu31924031190147>

**AN INTRODUCTION TO PHYSIOLOGY**



# THE INTRODUCTION TO PHYSIOLOGY.

---

## CORRECTIONS.

---

- Page 23, line 5. Instead of "open the key" read "close the electrometer key."
- " 23, " 8. Instead of "Close the key" read "Open the electrometer key."
- " 25, Fig. 8. The pole-changer should be connected with posts 1 and 0 of the rheocord.
- " 86, line 28. After "current" insert: "Stimulate with the make induction current during the passage of the polarizing current."
- " 98, " 21. For "an open key" substitute "a pole-changer."
- " 99, " 7. For "open the key" read "reverse the current."
- " 204, " 20. Omit "transfer the muscle to the rigid lever."
- " 215, " 25. After "the" insert "counterpoised."
- " 218, " 20. After "scale-pan" insert "The weight of the rigid lever and its scale-pan is 110 grams."
- " 218, " 24. Instead of "100" read "90."
- " 218, " 27. " " "100" " "200."
- " 219, " 1. " " "200" " "300."
- " 225, " 28. Before "50" read "approximately."
- " 226, " 10. After "is" read "approximately."
- " 283, " 21. After "brain" read "and cord."
- " 294, " 15. For "293" read "296."





AN INTRODUCTION  
TO  
P H Y S I O L O G Y

BY  
WILLIAM TOWNSEND PORTER, M.D.  
ASSOCIATE PROFESSOR OF PHYSIOLOGY IN THE  
HARVARD MEDICAL SCHOOL

---

THE UNIVERSITY PRESS  
Cambridge, Mass.  
1901

*Copyright, 1900, 1901*

**BY W. T. PORTER**

## PREFACE

THE system of teaching in which the Introduction to Physiology has a place I have already described in the Boston Medical and Surgical Journal, December 29, 1898, and, more fully, in the Philadelphia Medical Journal, September 1, 1900. Its leading principle is that the student shall perform for himself the classical experiments which are the essence of the science. Personal observation of nature is the dominant note. It is the function of the instructor to discuss these fundamental observations with the student and to add such related facts as shall widen the student's view.

It is obvious that all the valuable experiments in physiology cannot be performed in the time that is ordinarily given to this subject. A choice must be made. The student should be trained rather than informed. The trained observer can and must be trusted to inform himself.

Training in science means first of all the mastery of one field. In physiology the study of nerve and muscle is at present that best adapted to form the mind in habits of exact observation and clear reasoning. Schooled in this important part of physiology, the student can pass more rapidly and with greater understanding over the remaining parts. It is with nerve and muscle, therefore, that the Introduction to Physiology begins, and the treatment of this subject is made as thorough as is practicable.

There are in every chapter in physiology important experiments which for various reasons cannot well be done by students. Thus in Part II. of this work, treating of the circulation of the blood, no mention is made of the researches of Chauveau and Marey upon the intracardiac pressure. It is expected that the protocols of such experiments shall be provided as nearly as possible in their original form. Trained by his own observations, the student will then find profit in dealing at first hand with the work of others.

The apparatus here described is trustworthy and relatively inexpensive. It was constructed under my direction for the students who perform these experiments in the Harvard Medical

School. Some of the pieces, for example the capillary electrometer and the artificial scheme for the study of the circulation, are wholly of my own design. Others were devised with the aid of past and present instructors and mechanics in the Department of Physiology. My associates, also, have given me valuable criticism, and I gratefully acknowledge their many kindnesses.

W. T. PORTER.



# CONTENTS



## I

	Page
INTRODUCTION . . . . .	3
Preparation of gastrocnemius muscle — Nerve-muscle preparation.	

## II

### METHODS OF ELECTRICAL STIMULATION

GALVANI'S EXPERIMENT . . . . .	12
THE ELECTROMETER, THE RHEOCORD, AND THE CELL . . . . .	14
Surface tension — Electrometer — Rheocord — Cell — Polarization current — Dry cell — Graduation of electrometer.	
INDUCTION CURRENTS . . . . .	30
Magnetic induction — Magnetic field; lines of force — To produce electric induction, lines of magnetic force must be cut by circuit — Electromagnetic induction — Inductarium — Empirical graduation of inductarium — Make and break induction currents as stimuli — Extra currents at opening and closing of primary current — Tetanizing currents — Induction in nerves — Exclusion of make or break current.	
UNIPOLAR INDUCTION . . . . .	44

## III

THE GRAPHIC METHOD . . . . .	51
------------------------------	----

## IV

## THE ELECTRICAL STIMULATION OF MUSCLE AND NERVE

	Page
THE GALVANIC CURRENT . . . . .	59
Non-polarizable electrodes — Opening and closing contraction — Changes in intensity of stimulus.	
POLAR STIMULATION OF MUSCLE . . . . .	65
Ureter — Intestine — Tonic contraction — Physiological anode and cathode — Polar stimulation in heart.	
POLAR STIMULATION OF NERVE . . . . .	75
Law of contraction — Changes in irritability — Changes in conductivity.	
STIMULATION OF HUMAN NERVES . . . . .	89
Stimulation of motor points — Polar stimulation of human nerves — Reaction of degeneration.	
GALVANOTROPISM . . . . .	98
Paramecium.	
INFLUENCE OF DURATION OF STIMULUS . . . . .	100
Tonic contraction — Rhythmic contraction — Continuous galvanic stimulation of nerve may cause periodic discharge of nerve impulses — Polarization current — Polar fatigue — Opening and closing tetanus — Polar excitation in injured muscle.	
POLAR INHIBITION BY THE GALVANIC CURRENT . . . . .	114
Heart — Polar inhibition in veratrinized muscle.	
STIMULATION AFFECTED BY THE FORM OF THE MUSCLE	117
EFFECT OF THE ANGLE AT WHICH THE CURRENT LINES CUT THE MUSCLE FIBRES . . . . .	118
THE INDUCED CURRENT . . . . .	119

## V

## CHEMICAL AND MECHANICAL STIMULATION

CHEMICAL STIMULATION . . . . .	124
Effect of distilled water — Strong saline solutions — Drying — "Normal saline" — Importance of calcium — Constant chemical stimulation may cause periodic contraction.	
MECHANICAL STIMULATION . . . . .	127
Idio-muscular contraction.	



## VI

## IRRITABILITY AND CONDUCTIVITY

	Page
Independent irritability of muscle — Irritability and conductivity are separate properties of nerve — Minimal and maximal stimuli ; threshold value — Summation of inadequate single stimuli — Relative excitability of flexor and extensor nerve fibres; Ritter-Rollett phenomenon — Specific irritability of nerve greater than that of muscle — Irritability at different points of same nerve — Excitation wave remains in muscle or nerve fibre in which it starts — Same nerve fibre may conduct impulses both centripetally and centrifugally — Speed of nerve impulse.	129

## VII

## THE ELECTROMOTIVE PHENOMENA OF MUSCLE AND NERVE

THE DEMARCATION CURRENT OF MUSCLE . . . . .	150
Demarcation current of muscle — Stimulation by demarcation current — Interference between demarcation current and stimulating current; polar refusal — Measurement of electromotive force of demarcation current.	
DEMARCATION CURRENT OF NERVE . . . . .	159
Nerve may be stimulated by its own demarcation current.	
HYPOTHESES REGARDING THE CAUSATION OF THE DEMARCATION CURRENT . . . . .	161
ACTION CURRENT OF MUSCLE . . . . .	166
Rheoscopic frog — Action current in tetanus; stroboscopic method — Action current of human muscle — Action current of heart.	
ACTION CURRENT OF NERVE . . . . .	178
Negative variation — Positive variation — Positive after-current — Contraction secured with a weaker stimulus than negative variation — Current of action in optic nerve — Errors from unipolar stimulation.	
SECRETION CURRENT . . . . .	183
Secretion current from mucous membrane — Negative variation of secretion current.	

	Page
ELECTROTONIC CURRENTS . . . . .	186
Negative variation of electrotonic currents ; positive variation (polarization increment) of polarizing current.	
Electrotonic current as stimulus.	
ELECTRIC FISH . . . . .	192

## VIII

## THE CHANGE IN FORM

VOLUME OF CONTRACTING MUSCLE . . . . .	194
THE SINGLE CONTRACTION OR TWITCH . . . . .	195
Muscle curve — Duration of the several periods — Excitation wave — Contraction wave — Relation of strength of stimulus to form of contraction wave — Influence of load on height of contraction — Influence of temperature on form of contraction — Influence of veratrine on form of contraction.	
TETANUS . . . . .	209
Superposition of two contractions — Superposition in tetanus — Muscle sound — Relation of shortening in a single contraction to shortening in tetanus.	
THE ISOMETRIC METHOD . . . . .	217
Graduation of isometric spring — Isometric contraction.	
CONTRACTION OF HUMAN MUSCLE . . . . .	220
Simple contraction or twitch — Isometric contraction — Artificial tetanus — Natural tetanus.	
SMOOTH MUSCLE . . . . .	221
Spontaneous contraction — Simple contraction — Tetanus.	
THE WORK DONE . . . . .	223
Influence of load on work done — Absolute force of muscle — Total work done ; the work added — Total work done estimated by muscle curve — Time relations of developing energy.	
ELASTICITY AND EXTENSIBILITY . . . . .	229
Elasticity and extensibility of a metal spring — Of a rubber band — Of skeletal muscle — Extensibility increased in tetanus.	

	Page
FATIGUE . . . . .	232
Skeletal muscle of frog — Human skeletal muscle.	

## IX

## THE MECHANICS OF THE CIRCULATION

THE ARTIFICIAL SCHEME . . . . .	242
THE CONVERSION OF THE INTERMITTENT INTO A CONTINUOUS FLOW . . . . .	244
THE RELATION BETWEEN RATE OF FLOW AND WIDTH OF BED . . . . .	248
THE BLOOD-PRESSURE . . . . .	250
Relation of peripheral resistance to blood-pressure — Curve of arterial pressure in the frog — Effect on blood-pressure of increasing the peripheral resistance in the frog — Changes in the stroke of the pump; inhibition of the ventricle — Effect of inhibition of the heart on the blood-pressure in the frog.	
THE HEART AS A PUMP . . . . .	255
Opening and closing of the valves — Period of outflow from the ventricle — Visible change in form — Graphic record of ventricular contraction.	
THE HEART MUSCLE . . . . .	258
All contractions maximal — Staircase contractions — Isolated apex; Bernstein's experiment — Rhythmic contractility of heart muscle — Constant stimulus may cause periodic contraction — Inactive heart muscle still irritable — Refractory period; extra contraction; compensatory pause — Transmission of the contraction wave in the ventricle; Engelmann's incisions — Transmission of the cardiac excitation from auricle to ventricle; Gaskell's block — Tonus — Influence of load on ventricular contraction — Influence of temperature on frequency of contraction — Action of inorganic salts (sodium, calcium, potassium) on heart muscle.	
THE HEART SOUNDS . . . . .	269
THE PRESSURE-PULSE . . . . .	271
Frequency — Hardness — Form — Volume — Pressure-pulse curve in the artificial scheme — Human pressure-pulse curve — Low tension pressure-pulse — Pressure-	

	Page
pulse in aortic regurgitation — Stenosis of the aortic valve — Incompetence of the mitral valve.	
<b>THE VOLUME PULSE . . . . .</b>	<b>280</b>

## X

### THE INNERVATION OF THE HEART AND BLOOD VESSELS

<b>THE AUGMENTOR NERVES OF THE HEART . . . . .</b>	<b>283</b>
Preparation of the sympathetic — Action of sympathetic on heart.	
<b>THE INHIBITORY NERVES OF THE HEART . . . . .</b>	<b>286</b>
Intracardiac inhibitory mechanism — Preparation of the vagus nerve — Stimulation of cardiac inhibitory fibres in vagus trunk — Effect of vagus stimulation on the auriculo-ventricular contraction interval — Irritability of the inhibited heart — Intracardiac inhibitory mechanism — Inhibition by Stannius ligature — Action of nicotine — Atropine — Muscarine — Antagonistic action of muscarine and atropine.	
<b>THE CENTRES OF THE HEART NERVES . . . . .</b>	<b>292</b>
Inhibitory centre — Augmentor centre — Reflex inhibition of the heart; Goltz's experiment — Reflex augmentation.	
<b>THE INNERVATION OF THE BLOOD VESSELS . . . . .</b>	<b>296</b>
Bulbar centre — Vasomotor functions of the spinal cord — Effect of destruction of the spinal cord on the distribution of the blood — Vasomotor fibres leave the cord in the anterior roots of spinal nerves — Vasoconstrictor fibres in the sciatic nerve — Vasodilator nerves — Reflex vasomotor actions.	

## ILLUSTRATIONS

Diagrams which merely illustrate the grouping of apparatus for a particular experiment are omitted from this list.

Fig.	Page
1. Muscles of left hind limb of frog, dorsal view . . . . .	7
2. Nerve-muscle preparation . . . . .	8
3. Muscle clamp, stand, and nerve-holder . . . . .	9
4. Capillary electrometer . . . . .	18
5. Rheocord . . . . .	20
7. Pole-changer . . . . .	25
9. Inductorium, simple key, and platinum electrodes	31
11. Kymograph . . . . .	51
12. Tuning-fork . . . . .	55
13. Moist chamber, with non-polarizable electrodes, and muscle lever . . . . .	60
14. Hind limb of frog, anterior view . . . . .	62
17. Cork clamp . . . . .	65
18. Electromagnetic signal . . . . .	68
25. Motor points on the anterior surface of the forearm and hand . . . . .	90
26. Motor points on the posterior surface of the forearm and hand . . . . .	91
31. Frog-board . . . . .	115
32. Gas chamber, with bottle for generating carbon dioxide . . . . .	135

Fig.		Page
33.	Sartorius . . . . .	144
34.	Gracilis . . . . .	145
38.	Scheme of myomeres in a parallel-fibred muscle . .	162
39.	Scheme of myomeres in an oblique section . . .	163
40.	Wheel interrupter . . . . .	167
42.	Heart-holder . . . . .	174
43.	Scheme of differential rheotome . . . . .	176
47.	Volume tube . . . . .	195
48.	Rigid muscle lever . . . . .	205
49.	"Muscle warmer" . . . . .	206
50.	Ergograph . . . . .	220
51.	Work adder . . . . .	225
52.	Artificial scheme of circulation . . . . .	243
53.	Mercury manometer . . . . .	252
54.	Sphygmograph . . . . .	256
55.	Scheme of sympathetic nerve in frog . . . . .	284
56.	Scheme of cervical nerves in frog . . . . .	286
57.	View of brain of frog from above . . . . .	293

PART I  
THE PHYSIOLOGY OF MUSCLE AND  
NERVE





# PART I

## THE PHYSIOLOGY OF MUSCLE AND NERVE

### I

#### INTRODUCTION

UNTIL recent times it was believed that many of the compounds found in the tissues of animals and plants could be made only by the action of organized, *i. e.* living matter. Such compounds were called organic to distinguish them from those found in inorganic or inanimate nature. The forces producing organic compounds were thought to be partly the ordinary chemical and physical processes known to science, and partly certain mystical agencies termed vital forces. The great discovery of Wöhler in 1828 that urea ( $\text{CO}_2\text{NH}_2$ ), a typical organic compound, could be made synthetically in the laboratory, overthrew this conception and was the beginning of a long and fruitful struggle to

#### 4 THE PHYSIOLOGY OF MUSCLE AND NERVE

bring the phenomena of living matter within the operation of chemical and physical laws without recourse to the supernatural and occult. According to this new, unified view of nature, which is the foundation of modern physiology, all phenomena, whether animate or inanimate, are alike the expression of chemical and physical processes, some known, some unknown, none of which is fundamentally different from the rest.

The physiologist, therefore, now looks upon the reactions of living matter with the eye of the physicist, and it is of the first importance to beginners in physiology to acquire this point of view. To get the physical point of view it is necessary to master, as thoroughly as may be, some part of physiology, the physics and chemistry of which are well advanced. It is necessary, too, that the field selected for investigation should be one in which material is both abundant and easy of access. No part of physiological science fulfils these conditions so well as that which deals with the phenomena of muscle and nerve.

Let us begin by examining one of the skeletal muscles of the frog.

**The Preparation of the Gastrocnemius Muscle.**  
— Wrap the frog in the cloth, the head out.

Pass one blade of the stout scissors between the jaws. Bring this blade to the angle of the jaw, the other blade over the junction of the head and trunk. Cut off the skull with a single closure of the scissors. Thrust the pithing wire into the cranial cavity and then into the vertebral canal, destroying the brain and spinal cord. The frog ceases to move; the muscles are relaxed. Sever the skin of the foot by a circular incision at the distal end of the tendo Achillis. Reflect the skin upon itself until the whole of the gastrocnemius muscle is exposed. Do not lay the bared leg on the table or permit it to touch the skin of the other leg. The skin of the frog, like that of the salamander and some other batrachians, is provided with a protective secretion injurious to sensitive tissues. Place the frog on the table, back uppermost, with the bared leg resting across the corner of a glass plate at the edge of the table in such a way that the foot is flexed, *i. e.* hangs down over the edge of the table. Pinch the muscle sharply with the forceps.

The muscle passes into the active state; it shortens and thickens. The foot, which is relatively less fixed than the leg, is extended. The contraction is followed by a slower relaxation or return to the original form.

Observe that the mechanical act of pinching caused the resting muscle to become active. Its stored energy was transformed into external, mechanical work, *i. e.* the moving of the foot. Not all of the energy set free takes this easily visible form. It will be shown later that much of it is made active as molecular motion, in the form of heat, chemical action, and electricity. Agents which occasion a transformation of energy within the living body are termed *stimuli*, and tissues which convert energy of one form into energy of another in consequence of stimulation are said to be *irritable*. All living tissues are alike irritable, but the form in which their kinetic or active energy appears differs with the nature of the tissue. The contrast between muscle and nerve in this respect is very instructive.

**The Nerve-Muscle Preparation.** — Divide the body transversely behind the fore limbs. Remove the viscera. Seize the spinal column with the finger and thumb of one hand, and the skin of the back with the other hand, covered with a cloth to prevent slipping. Draw the hind limbs out of the skin. Lay the frog down, back uppermost. Note on the outside of the thigh the triceps femoris muscle; on the median side, the semi-membranosus; between these, the nar-

row biceps femoris. (Fig. 1.) Cautiously divide the connective tissue between the semi-membranosus and the biceps femoris. On drawing these muscles apart, the sciatic nerve and the femoral vessels will be seen. Clear the nerve with scissors and forceps from the knee to the vertebral column. The nerve itself should not be touched with the instruments. Near the pelvis it will be necessary to divide the piriform and the ilio-coccygeal muscles: carefully avoid the nerve while doing this.

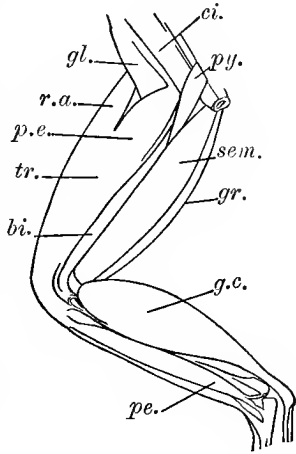

Fig. 1. Muscles of left hind limb of frog, dorsal view (Ecker and Wiedersheim).

Lift the tip of the urostyle (the tenth vertebra, a long, slender bone which forms the caudal end of the vertebral column) with the forceps, and remove the bone as far as the last lumbar vertebra. Divide the spinal column transversely between the 6th and 7th lumbar vertebræ. Turn the frog back down. With the stout scissors

bisect lengthwise the 7th, 8th, and 9th vertebræ. Grasp the half from which the prepared nerve springs and lift it gently, freeing the nerve with the scissors down to the knee.

Pass now to the leg. Cut through the Achilles tendon of the gastrocnemius muscle below the thickening at the heel. Free the muscle up to its origin from the femur, taking care not to harm the branch of the nerve which enters the muscle on its posterior surface near the knee. Cut through the tibia about one centimetre from the knee-joint. Clear away the muscles of the thigh from the lower end of the femur, avoiding the sciatic nerve. Cut through the femur about its middle. (Fig. 2.) Lay the sciatic nerve for safety along the gastrocnemius muscle. Fasten the lower fragment of the femur in the jaws of the muscle clamp. Let the whole nerve rest without stretching on the nerve-holder, the filter paper covering which should be moistened with normal saline solution (0.6 per cent NaCl). Take care that the nerve does not dry between the nerve-

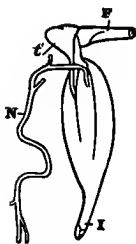

Fig. 2. Nerve-muscle preparation; gastrocnemius muscle and sciatic nerve. F, end of femur; N, sciatic nerve; I, tendo Achillis; t, attachment of smaller tendon of gastrocnemius to femur (Handbook for the Physiological Laboratory).

muscle. Fasten the lower fragment of the femur in the jaws of the muscle clamp. Let the whole nerve rest without stretching on the nerve-holder, the filter paper covering which should be moistened with normal saline solution (0.6 per cent NaCl). Take care that the nerve does not dry between the nerve-

holder and the muscle. (Fig. 3.) Pinch the end of the nerve.

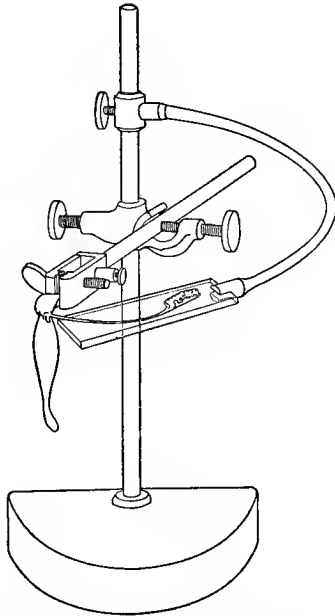

Fig. 3. The muscle clamp, stand, and nerve-holder. The nerve-holder supports the sciatic nerve, together with the portion of the spinal column from which it springs. The handle of the nerve-holder is of thick lead wire which may be bent as desired. The binding post on the muscle clamp provides electrical connection with the upper end of the muscle.

No change will be seen in the nerve, but the muscle will contract.

Thus, while the most conspicuous form which

the energy of muscle takes, when set free, is mechanical, the active nerve does not alter its form, but spends its energy in a molecular change, the nerve impulse, which passes from point to point along the nerve to the muscle, or gland, or other structure connected functionally to the nerve. The effect produced by the nerve impulse depends on the nature of the tissue in which the nerve ends; for example, the energy set free in secreting glands is especially chemical; that set free in the electrical organ of *Torpedo* is especially electrical. In considering these illustrations of the ways in which the energy of living tissue may be set free, however, two facts should always be kept in mind; first, that by far the greater part of the stored energy of the body is set free as heat; and secondly, that while the several tissues are characterized by the especial prominence of some one form of energy, as contractility in the case of muscle, and the production and conveyance of a nerve impulse in the case of nerve, yet the transformation of energy in each tissue is a complex process, many steps of which, for example, heat and chemical action, are common to all living substance.

We have made, then, the fundamental observation that an adequate stimulus will occasion in muscle a conversion of latent energy into



mechanical change in form, and in the nerve a molecular change that passes along the nerve as a nerve impulse. We must now examine systematically the usual methods of exciting the transformation of energy and inquire concerning their effect on muscle and nerve.

#### APPARATUS

Normal saline. Bowl. Cloth. Pithing wire. Scissors. Forceps. Pipette. Glass plate. Cement. Foil. Nerveholder (filter paper). Muscle clamp. Stand. Frog.

## II

## METHODS OF ELECTRICAL STIMULATION

THE stimulus most usually employed in the laboratory is electricity, because electricity will stimulate when used in quantities which do not destroy the tissues, as do many mechanical, chemical, and thermal stimuli, and because the intensity and duration of the electrical stimulus can be graduated with accuracy. It will be necessary, therefore, to study with especial care the methods of electrical stimulation.

## GALVANI'S EXPERIMENT

Rest a copper wire on the gastrocnemius muscle and a zinc wire on the sciatic nerve of a nerve-muscle preparation. Bring the other ends of the wires into contact.

The muscle will twitch.

Galvani supposed that the muscle itself produces the electricity that stimulates it in this experiment. Volta pointed out that when two

dissimilar metals are brought into contact, one becomes positively, and the other negatively electrified. The chief source of electrical energy in this experiment, however, is derived not from the contact of two dissimilar metals with each other, but from their contact with a decomposable liquid, namely, the saline solution which forms the principal part of animal tissue. Such saline solutions are now supposed by physical chemists to contain dissociated atoms (or groups of atoms) called ions each of which carries a strong charge of electricity. When the metals in contact with the liquid are joined, the ions begin to move through the liquid. Those wandering from the point at which the electrical energy is greatest (termed the point of highest potential,<sup>1</sup> or anode) towards

<sup>1</sup> The difference of potential may be compared to the difference of water level between a reservoir and its distributing pipes. It produces an electromotive force, comparable to the force which moves the water from the higher to the lower level. The unit of electrical pressure is the volt. The flow through an hydraulic system is measured by the quantity of water passing any point in a given time; similarly the quantity of electricity is the amount that flows through a cross-section of the conductor in a given time. The unit of quantity is the ampere. Electricity passing through a conductor meets with a resistance which becomes greater as the cross-section of the conductor diminishes, just as water can be forced more easily through wide channels than through narrow ones. The unit of electri-

the point of lowest potential, or cathode, are termed "cations" (*κατά*, down); and those moving from the lowest to the highest potential are termed "anions" (*ἀνά*, up). Examples of anions are Cl<sup>-</sup>, Br<sup>-</sup>, I<sup>-</sup>, OH<sup>-</sup>, NO<sub>2</sub><sup>-</sup>, NO<sub>3</sub><sup>-</sup>, ClO<sub>3</sub><sup>-</sup>, SO<sub>4</sub><sup>-</sup>, etc.; of cations: most of the metals, H<sup>+</sup>, NH<sub>4</sub><sup>+</sup>, etc. Chemically equivalent ions carry equal quantities of positive or negative electricity. The more swiftly the ions move, the greater will be the quantity of electricity which they will transport in a unit of time.

#### THE ELECTROMETER, THE RHEOCORD, AND THE CELL

In order to study differences in electrical potential, a galvanometer or some other electrometer is necessary. In the galvanometer, the

cal resistance is the ohm. The precise definition of these units is as follows:—

A *volt* is the electromotive force that, steadily applied to a conductor whose resistance is one international ohm, will produce a current of one international ampere. The practical *ampere* is the unvarying current, which, when passed through a solution of nitrate of silver in water, deposits silver on the cathode, or negative pole, at the rate of 0.001118 gram per second. The *ohm* is the resistance offered to an unvarying electrical current by a column of mercury at the temperature of melting ice, 14.4521 grams in mass, of a constant cross-sectional area, and of the length of 106.3 centimetres.

points of different potential are connected by a coil of wire near which is suspended a magnet. When the circuit is completed, the electrical energy acts on the suspended magnet by induction, and deflects it to an extent proportionate to the difference of potential. In the capillary electrometer, which is the electrometer preferred here, a capillary tube filled with mercury and sulphuric acid dips in a wider tube which contains sulphuric acid. The points the potential of which is to be measured are connected with the mercury and the acid respectively. When the connection is made, the tension of the surface of mercury in contact with the acid changes, causing the mercury to move in the capillary. The change in surface tension is proportional to the difference in potential. The action of the instrument will be more clear from the following experiments.

**Surface Tension.** — In a small porcelain evaporating dish place a globule of mercury about one inch in diameter.

The cohesion of the mercury is stronger than the attraction between the mercury and porcelain, — the mercury does not “wet” the porcelain. The free surface of the mercury is curved and not plane, as it would be were the molecules acted upon by the force of gravity alone. Obvi-

ously the spreading of the mercury is resisted by some force that strives to make the drop spherical, *i. e.* to make the surface as small as possible.

This force is called the surface tension. It is the attraction which the molecules beneath the surface exert on the side of the surface layer next them. The form of the drop is the result of the equilibrium between these opposing forces (Thomas Young, 1804).

*Surface tension altered by electrical energy.* — Cover the mercury one centimetre deep with 5 per cent sulphuric acid. Note carefully the degree of convexity. Add a trace of potassium chromate. The drop will flatten slightly.

When a metal is placed in an electrolyte, a difference of potential is created at the surfaces in contact. If the metal is positive compared with the electrolyte, an immeasurably thin layer of positively electrified molecules may be said to coat its surface, and in the electrolyte a parallel layer of negatively electrified molecules will collect. On every side of the parallel layer electricity of the same sign will be repelled. In the case of a liquid metal, for example mercury, the form of the surface will be altered, for the repulsion of like electricities will tend to stretch the surface layer, and will thus oppose the sur-

face tension. The new form which the surface will take is the equilibrium between the electrical energy and the surface tension (Helmholtz). If this equilibrium is changed by the introduction of new electrical energy, the curvature of the surface will change (Henry).

Fasten an iron wire in the muscle clamp and clamp the latter to the stand. Bring the wire over the mercury and lower the muscle clamp until the wire just touches the edge of the mercury. Fix the clamp in this position.

The instant the two metals touch (iron and mercury in chromic acid solution) the mercury will become positive towards the iron. The existing difference of potential will be altered. The surface tension will thereby be increased and the globule will become more convex. This movement withdraws the margin of the globule from the iron and the globule flattens again, which brings it again into contact with the iron. This play is repeated until the chromic acid is all reduced to chromic sulphate.

**The Electrometer.** — The electrometer consists of a vertical tube drawn out at the lower end into a fine capillary and filled with mercury. (Fig. 4.) The upper end of the tube is joined to a rubber bulb, by the compression of which pressure can be made on the mercury column;

a side branch leads to a mercury manometer which records the amount of this pressure. The end of the capillary dips in a reservoir con-

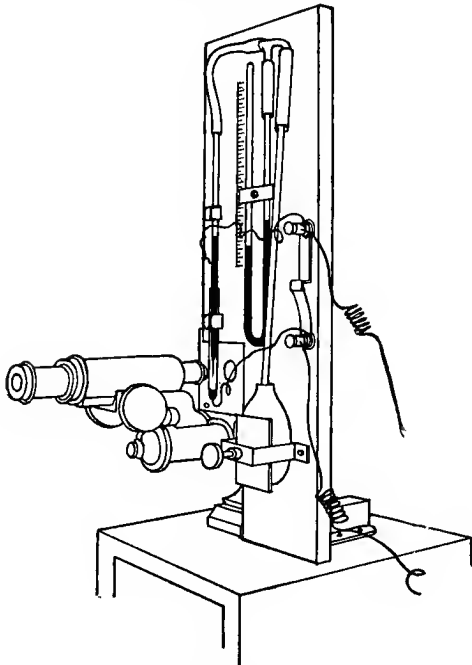

Fig. 4. The capillary electrometer.

taining 20 per cent sulphuric acid. A little mercury is placed in the reservoir. Platinum wires lead from this mercury and that in the



capillary to convenient binding posts. When mercury is placed in the vertical tube it enters the capillary until the weight of the column of mercury is balanced by the surface tension, which is inversely proportional to the diameter of the tube. If the capillary is now dipped in the reservoir containing the sulphuric acid and the rubber bulb compressed, mercury will be forced out of the capillary into the acid, and on lowering the pressure the mercury will retreat within the capillary, drawing the acid after it. As the mercury in the capillary is kept from falling by the surface tension, it is obvious that whatever increases or diminishes the surface tension will raise or lower in corresponding measure the mercury in the capillary. The alteration in surface tension is accompanied by the movement of ions between the meniscus and the remaining electrode of the electrometer (the mercury in the acid reservoir). In practice it is found that this movement can be neither very rapid nor long continued, without injuring the sensitiveness of the instrument. The potential difference from even a single element (Daniell or dry cell) is far too large to be used safely. It is advisable to employ a potential divider, or rheocord, which shall permit only a fraction of the original potential (not more than 0.1 volt) to reach the electrometer.

**The Rheocord.** — If two poles of a cell or other points of different potential be joined by a well-drawn wire, the potential through the wire will fall uniformly from the anode to the cathode. The greater the resistance in the wire, the more uniform will be the fall in potential. The rheocord (Fig. 5) consists of 10 metres of thin well-drawn German silver wire (No. 30). Binding posts are placed at the beginning of the continuous wire, one metre from the beginning, and at the end.



Fig. 5. The rheocord. A metre rule is screwed to the lid of a shallow box of oak. At each end is a binding post. To the post marked 0 is fastened one end of an unbroken German silver wire (No. 30) ten metres in length. This wire passes over the metre stick to post 1, and thence into the box, where the remaining nine metres go to and fro between two rows of pegs at the ends of the under side of the cover of the box. The end of the 10 metre wire is brought out of the box and fastened to post 10.

The resistance in the 10 metres of thin German silver wire is so great (about 64 ohms) that the internal resistance of the element furnishing the electromotive force, together with the resistance of the large copper connecting wires, practically disappears for such measurements as we shall need to make. As the fall of potential is uniform throughout the 10 metres, the difference of potential between post 0 and post 1 will be practically one-tenth the electromotive force of

the element. Thus when the sliding contact is at post 1, the capillary electrometer receives one-tenth the electromotive force of the element. By moving the slider from post 1 towards post 0, any desired fraction of this one-tenth may be measured by the electrometer.<sup>1</sup>

**The Cell.** — In Galvani's experiment, the contact of two dissimilar metals with the saline fluids of animal tissue caused a movement of ions and a difference of potential. The action may be studied more conveniently when the liquid is placed in a cell.

Connect a platinum and a zinc<sup>2</sup> plate through

<sup>1</sup> The electrometer should always be used in short circuit, so that the capillary and the mercury in the reservoir shall always be connected through a conductor. The short circuit may be provided through a key or through the rheocord (Fig. 6, page 22). Perhaps the most convenient arrangement is that shown in Fig. 4, in which a strip of spring brass connected with one of the binding posts of the electrometer rests against a second piece of brass connected with the other binding post except when depressed by the finger. The point of higher potential, when known, should always be connected with the capillary. The zinc is that point in the ordinary zinc-carbon or zinc-platinum element. The student is reminded that in the circuit outside the element, the potential falls from the carbon to the zinc.

<sup>2</sup> It will be observed that the zinc is amalgamated. Chemically pure zinc does not need amalgamation. Commercial zinc contains iron, arsenic, etc., as impurities. The contact of unamalgamated zinc and these dissimilar metals with an electrolyte creates a difference of potential, and parasitic currents run from

a simple key with posts 0 and 10 of the rheocord as shown in Fig. 6. Connect the zero post and the slider with the capillary electrometer through a short-circuiting key.

Bring the capillary into the field of the microscope (Leitz objective 3, micrometer ocular), parallel to the micrometer scale. The end of the

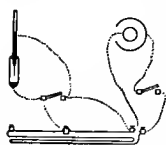

Fig. 6.

tube should be just visible at the upper margin of the field. If the meniscus is not visible, turn the pressure screw slowly to the right until the meniscus enters the field. Note the position of the meniscus on the scale. Close the battery key. Let an assistant place the metals in a beaker containing solution of sodium chloride. Open the short-circuiting key of the electrometer.

the zinc to the foreign metals. These currents are prevented by covering the impurities with zinc amalgam, the electromotive properties of which, toward sulphuric acid, are those of pure zinc. As the zinc in the amalgam dissolves out, the film of mercury unites with fresh zinc. Zinc is amalgamated best by adding 4 per cent of mercury to the molten zinc before casting; or the zinc may be dipped in 10 per cent sulphuric acid to clean it, and mercury rubbed over the surface with a brush or a stick padded with cloth; or the zinc may be dipped in a solution from which the mercury will deposit on the zinc. Formula for amalgamating fluid: warm gently 4 parts mercury in 5 parts concentrated nitric acid and 15 parts concentrated hydrochloric acid until dissolved, and then add 20 parts more of concentrated hydrochloric acid.

When the metals touch the electrolyte a difference in potential will be set up, and the meniscus will move in the capillary.

Note the number of divisions of the scale traversed by the meniscus. Open the key. Wait several minutes.

Now bring the meniscus back to its original position on the scale. Close the key.

The meniscus will move to a much slighter extent than when the circuit was first made.

As the displacement of the meniscus is proportional to the electromotive force of the cell, it is obvious that the latter has rapidly diminished. The solution contains the ions of water as well as those of the salt. When the circuit between the platinum and zinc is completed the cations  $H^+$  and  $Na^+$  move towards the cathode. There the more easily de-ionized  $H^+$  yields up its electricity and hydrogen appears on the cathode. The corresponding quantity of electricity is conveyed into the solution at the anode by ionization of the zinc. The deposition of hydrogen on the negative plate checks the electromotive force setting from the zinc to the platinum in two ways: first, because gas is a bad conductor, and the effective surface of the platinum is thereby diminished by the bubbles collecting on it; and secondly, because hydrogen is electro-positive, and creates an electromotive force in

the direction from platinum to zinc, and thus "polarizes" the cell. This new electromotive force opposes the original current from zinc to platinum.

*The Daniell Cell.* — Daniell discovered an electro-chemical method of avoiding polarization, and thus was able to construct a cell that would furnish a current of unvarying strength. In the Daniell cell the two metals employed are zinc and copper. The amalgamated zinc is placed in a porous cup filled with dilute sulphuric acid. The copper is placed in a solution of copper sulphate kept saturated by crystals of the salt. When the circuit is closed, the zinc "dissolves" in the sulphuric acid, carrying with it the electricity with which the zinc ions are charged. The electricity is carried through the solution by the migration first of hydrogen and then of copper ions. It leaves the solution at the cathode where the copper ions are converted into metallic copper and deposited on the cathode. The quantity of zinc dissolved and copper deposited is proportional to the quantity of the current. One ampere deposits per minute 19.75 milligrams copper, and dissolves 20.32 milligrams zinc.

It is to be observed that each metal is placed in a solution of its own salt. The ions carried to

the respective poles are of the same nature chemically as the poles themselves, and hence do

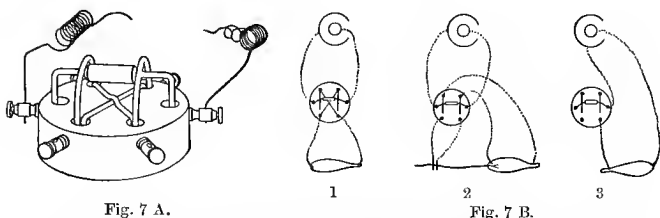

A, the pole-changer ; B, diagram of pole-changer arranged (1) to change the direction of the current, (2) as a double key, without cross-wires, (3) as a simple key.

not set up opposing electromotive forces when they are de-ionized.

The current produced by the Daniell cell is almost perfectly constant, so long as sulphuric acid still remains uncombined, and so long as the sulphate of copper solution is kept saturated.

It may be remarked that the function of the porous cup is to keep the copper from depositing on the zinc.

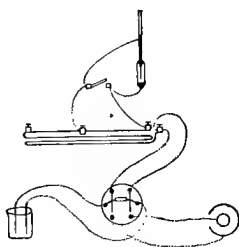

Fig. 8.

**Polarization Current.** — Place two pieces of platinum foil in a solution of copper sulphate, and connect them to a pole-changer (without

cross-wires). Connect the remaining pairs of posts with two dry cells in series (carbon of one cell connected with zinc of other), and with the 0 and 1 metre posts of the rheocord, respectively. Connect the zero post and the slider to the capillary electrometer (Fig. 8). Turn the pole-changer to pass the battery current through the copper sulphate solution or "electrolyte." The cation (copper) will be partially de-ionized at the negative pole, or cathode, on which copper will be deposited in a fine film. The anion (sulphion,  $\text{SO}_4$ ) will pass towards the positive pole, or anode. Since, however, the traces of oxygen ions present in the water are more easily de-ionized than the  $\text{SO}_4$  group, oxygen will appear at the anode and the  $\text{SO}_4$  ions will remain in the solution.

The elements copper and oxygen deposited respectively on the cathode and anode tend to fly back into the ionic state; and this tendency, taken in connection with the opposing osmotic force of the ions already in solution, sets up an electromotive force equal to that which caused the de-ionization, but in an opposite direction. Hence the polarization current. On cutting off the electrolyzing current, the polarization current may be measured.

Note the position of the meniscus of the capillary electrometer. Turn the pole-changer so that



the cell is cut off and the electrodes brought into the electrometer circuit.

The meniscus will indicate a current opposite in direction to the current from the cell.

*Electrolysis of Potassium Iodide* — An interesting example of electrolysis is seen in the decomposition of potassium iodide.

Dip a small piece of filter paper in starch paste to which a little potassium iodide has been added, and lay the paper over the platinum electrodes. Make the circuit.

A dark blue color appears at the anode. Iodine is set free at the anode and forms iodide of starch. This method may be used to determine which pole is the anode. The direction of the current in the secondary coil of the inductorium may be thus recognized.

**Dry Cell.** — A “dry” cell is very convenient for large classes. It usually consists of a zinc cup, lined with plaster of Paris, saturated with ammonium chloride, in the centre of which is a carbon plate surrounded with black oxide of manganese. When the cell is in action, the zinc forms a double chloride of zinc and ammonium, while ammonia gas and hydrogen are liberated at the carbon pole. These cells should never be used continuously for many minutes, for they are rapidly polarized by the accumulation of hydro-

gen on the carbon plate. The unused cell regains its difference of potential by the union of the hydrogen with the oxygen slowly given off by the manganese dioxide, which therefore acts as a depolarizer.

**Graduation of the Electrometer.** — It already has been stated that the pressure necessary to bring back the meniscus of the capillary electrometer to its original position is proportional to the electromotive force that displaced the meniscus. Thus if the electrometer is connected with a known difference of potential, for example, the poles of a Daniell cell, the potential of which is 1.1 volt, the meniscus will be so far displaced that a pressure of 30 mm. of mercury may be necessary to restore it to its original position on the micrometer scale. In that case, a displacement compensated by a pressure of 3 mm. Hg would indicate a difference of potential of  $\frac{3}{30}$  of 1.1 volts, or 0.11 volt; 1 mm. Hg pressure would compensate  $\frac{1}{30}$  of 1.1 volt, and so on, — the relation between pressure and difference of potential is a simple linear one. But this is true only when the capillary is of equal calibre throughout the region traversed by the meniscus. The shorter this region, the more likely is the calibre to be uniform. Uniformity is also greater near the end of the capillary than near the tube from which it is drawn. The

electromotive forces to be measured in physiological experimentation are usually very slight. It is of advantage therefore always to bring the meniscus near the end of the capillary, and to connect the positive element (zinc) with the capillary mercury. The meniscus will thus always traverse the same most uniform part of the capillary in the same direction. By limiting the graduation to this portion, the error incident to inequalities of bore will be much less. One-twentieth the voltage of a Daniell cell will cause a sufficient displacement of the meniscus.

To graduate the electrometer, the connections should be made as in Fig. 6. The short-circuiting key should be closed. The slider should be 50 cm. from the positive post. Take care that the zinc is connected with the capillary mercury. Bring the meniscus into the lower part of the field. Note its position on the micrometer scale. Note the level of the mercury in the manometer. Open the key. The meniscus will retreat in the capillary. Raise the pressure until the meniscus returns to its former position. Read the manometer again. Lower the pressure in the manometer. Close the key. The difference between the two manometer readings is the pressure in millimetres of mercury necessary to compensate an electromotive force of 0.055 volt. Divide 0.055 by the

number of millimetres. The quotient is the electromotive force for one millimetre pressure.<sup>1</sup>

*Advantages of the Electrometer.* — The mass of mercury displaced in the movement of the meniscus is very small, and the distance through which it is moved is short. Hence the inertia of position is easily overcome and the inertia of motion (which is proportionate to the mass times the square of the velocity) is practically wanting. The absence of inertia errors, the almost instantaneous quickness with which the meniscus takes its new position, the ease with which slight electromotive forces ( $\frac{1}{10000}$  volt) may be measured, and simplicity of construction, are the principal advantages of this admirable instrument.

### INDUCTION CURRENTS

A most useful method of electrical stimulation of living tissues is by the induced current, and a clear idea of the phenomena of induction must now be gained.

**Magnetic Induction.** — Faraday's experiment. Remove the secondary (larger) coil of the induc-

<sup>1</sup> In practice, the relation between the pressure and the potential must frequently be re-determined. For most purposes, it is better to measure differences of potential by compensation as explained on page 158. The electrometer then serves to show the point at which compensation is reached.

torium (Fig. 9) from its slideway and connect its terminals with the capillary electrometer. Raise the brass bridge between the binding posts. (If this bridge is down its thick metallic mass will offer such an easy path be-

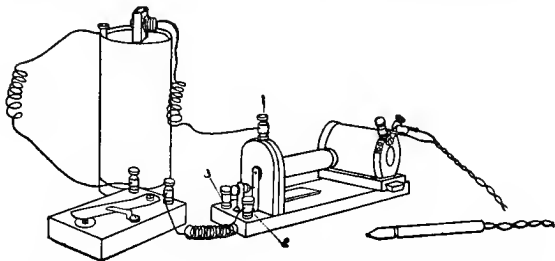

Fig. 9. The inductorium, simple key, and platinum electrodes. The inductorium is arranged for single induction currents; when the battery wires are placed in binding posts 2 and 3, the primary current will pass through the automatic interrupter and a continuous series of make and break induction currents will be secured. The secondary coil is turned upon its pivot. The ends of the secondary wire are fastened to two posts which may be connected by the brass bridge, in which case the induced currents are short-circuited.

One of the posts on the simple key is connected to a reservoir of mercury, the other to a spring brass strip. The latter bears at its free end an iron wire that makes contact with the mercury when the wire is pressed down through a short hard rubber tube (to prevent spilling the mercury) fastened about a small hole in the hard rubber cover of the reservoir. The wire may be held in this position, as in the figure, by pushing a pivoted brass fastener over the strip which bears the wire.

tween the ends of the secondary wire that nearly all — practically all — the electricity produced in this coil will pass over the bridge, instead of by the relatively long, thin wires leading to the electrometer.) Bring the meniscus into the field.

Thrust the north pole of a magnetized rod within the coil.

The meniscus will move, indicating that an electric current has been induced in the secondary coil. Note the direction of the current.

Let the magnet remain in the coil.

The meniscus will return to its former position. Evidently the induced current is of momentary duration.

Withdraw the magnet quickly.

The meniscus will move in the opposite direction.

Insert the south pole.

The induced current now has the direction opposite to that of the current induced by the insertion of the north pole.

Withdraw the magnet quickly.

The induced current has the direction opposite to that of the current induced by the withdrawal of the north pole.

These results may be thus expressed: the moving of a magnet in the neighborhood of a conductor, or of a conductor in the neighborhood of a magnet, produces in the conductor an electromotive force, which, on the circuit being completed, creates a current that would impart to the magnet or the conductor a movement in the opposite direction.

**Magnetic Field. Lines of Force.** — The space about a magnet in which the magnetic forces act is called the “field” of the magnet. If very fine iron filings are dusted through a muslin cloth onto a thin card perforated near the centre by a copper wire or other conductor, and a strong current is passed through the wire, the filings will arrange themselves in concentric circles around the wire, particularly if the card be gently tapped.

The position of these “lines of force” shows the direction of the magnetic force, and their number is an index of its intensity.

**To produce Electric Induction, the Lines of Magnetic Force must be cut by the Circuit.** — Hold the magnet at right angles to the axis of the coil, and, keeping it in this position, rapidly advance it towards the coil.

The electrometer will show no current, because the number of the lines of magnetic force which pass through the field of the conductor has not been altered.

**Electromagnetic Induction.** — An electromagnet may be used in place of the bar magnet to produce induction.

Connect a dry cell through a simple key with posts 1 and 2 of the primary coil. Close the key.

When the current passes through the primary coil, the core of iron wire in the coil will be

magnetized, as is shown by its attracting the head of the Wagner hammer.

Bring the meniscus into the field. Approach the primary coil to the secondary as in the experiment with the magnet. Withdraw the primary coil.

The electrometer shows the presence of induced currents, as before. These currents are momentary. The first induction current is inverse, *i. e.* it runs round the secondary coil in the direction opposite to that taken by the battery current in the primary coil. The second induced current is in the same direction as the primary current.

Place the coils at right angles to each other. Approach one towards the other.

No current will be induced.

*Make and break Induction.* — Close and open the key in the primary circuit, thus making and breaking the primary current.

The effect is the same as if the primary were suddenly brought up to the secondary coil from an infinite distance and removed again. The make induction current is in the opposite, the break in the same, direction as the primary current.

Turn the secondary coil on its pivot until the axis is at right angles to the axis of the primary coil. Make and break the primary current.

No induction will take place provided the angle between the coils is precisely  $90^\circ$ .



**The Inductorium.** — Examine the construction of the inductorium. The primary coil consists of a few turns of thick wire. More turns would increase resistance and self-induction, — the counter induction set up in each turn of the primary wire by the passage of the primary current through neighboring turns, — without increasing the induction effect in the secondary coil.

The iron core adds to the number of lines of magnetic induction which pass through the coils. It has been already shown (page 33) that the lines of magnetic induction produced by the passage of an electric current through a wire are closed circles. If the centre of the coil were filled with air, most of these circles would remain closed about their own wire, for air is not readily permeable to magnetism. But when the iron core is placed within the coil the greater part of the magnetic induction follows the iron (because it is more permeable) from end to end of the core, returning outside through the air. Thus the number of effective lines is increased. A bundle of iron wires is used instead of a solid core, because no induced current is then possible through the mass of the iron, as would be the case in a solid core. Such a current would slow the speed of magnetization and demagnetization.

The secondary coil is made of many turns of fine wire, because the object of the inductorium is to transform the low electromotive force of the cell into the high electromotive force of the induced current. In the induction coil, as in other transformers, the electromotive forces in the primary circuit are to those produced in the secondary circuit approximately as the number of turns of wire in the primary is to the number in the secondary circuit.

If the induced current is to be passed through conductors of low resistance, the high internal resistance of the secondary coil, due to its great length of fine wire, will be of importance.

Place a dry cell with simple key in the primary circuit of an inductorium (posts 1 and 2). Connect the secondary coil with a galvanometer. Note the excursion of the needle with a break induction current. Replace the secondary coil with one of fewer windings (the primary coil of a second inductorium will serve). Let the distance between primary and secondary coil be the same as before.

The excursion of the needle with a break induction current will be increased, or at least not proportionately diminished.

If, on the other hand, the induced current is to be passed through nerve, muscle, or skin, the

resistance of the secondary coil will practically be nothing in comparison with the enormous resistance of animal tissue.

Repeat the preceding experiment, introducing in the secondary circuit a high external resistance, *i. e.* a nerve.

The secondary coil with many turns of fine wire now causes a much greater deflection of the galvanometer needle than the coil with fewer turns.

*Interrupter.* — Instead of making and breaking the primary circuit by hand, an automatic interrupter is provided. The primary circuit passes through a screw, the point of which conveys the current through a flat spring upon which is mounted an iron disk opposite and near to the core of wire in the primary coil. When the current enters the primary coil, the core is magnetized and draws upon the iron disk. The spring, to which the disk is attached, is thereby drawn away from the screw-point through which the current is passing. Thus the current is broken, and ceases to flow through the primary coil; the core no longer is magnetized, and releases the iron disk; the spring again makes contact with the screw-point, the current is re-established, only to be at once again broken. Thus a rapid series of make and break induction currents is secured.

Draw a diagram of the primary circuit, indicating the connections of the inductorium.

**Empirical Graduation of Inductorium.** — Connect the secondary coil with the galvanometer. Join the primary coil to a dry cell, interposing a simple key. Turn the secondary coil on its pivot until it is at right angles with the primary coil. Close the circuit.

The galvanometer needle will not swing. There is no induced current.<sup>1</sup>

Turn the secondary coil on its pivot, closing the key from time to time to test the induction.

The strength of the induction increases approximately as the cosine of the angle between the coils increases. An empirical graduation is sometimes placed on a circular scale beneath the coil.

When the axes of the two coils lie in the same plane, slide the secondary towards the primary, making and breaking the primary current from time to time.

The potential of the primary upon the secondary coil, *i. e.* the sum of the inductions of each element of the primary upon all the elements of the secondary coil, increases as the secondary is brought nearer the primary coil. The increase is not linear. As the distance between the coils

<sup>1</sup> It is difficult to place the coil precisely at an angle of 90.°

diminishes, the increment of increase in the intensity of the induced current is not the same but greater for each centimetre of approach.

*Graduation.* — Fasten a strip of white gummed paper at the side of the base of the inductorium, beginning at the end block which holds the primary coil. Place the secondary coil at the end of the slideway. Make the primary current. Read the number of degrees of deviation for the break induction current only. Make a line on the paper band exactly opposite that end of the secondary coil which is nearer the primary. When the needle is again at rest, move the secondary nearer the primary coil, and find the distance at which the deviation of the needle in response to the break induction current is  $n$  degrees (for example, two) of the scale larger than at the former position of the coil. Mark on the white strip the new position of the coil. Continue in this way to find the positions of the secondary coil at which the needle shows successively a deviation two degrees greater at each new position, and mark them on the paper band.

The marks on this empirical scale will be nearer together as the secondary approaches the primary coil.<sup>1</sup>

<sup>1</sup> The rough method here employed serves merely to show that the increase in the intensity of the induction current as

**Make and Break Induction Currents as Stimuli.**

— Make a nerve-muscle preparation. Connect a dry cell with simple key to the primary coil (posts 1 and 2). Fasten in the posts of the secondary coil the stimulation electrodes, *i. e.* the prolongation of the ends of the secondary wire which convenience demands. Put the secondary coil at the end of the slideway. Place the electrode points against the nerve. Open and close the primary circuit.

The muscle does not contract.

Move the secondary towards the primary coil, opening and closing the primary circuit.

Presently the threshold value will be reached and the muscle will shorten. Observe that this contraction was the result of a break induction current, not a make.

Cautiously move the secondary coil still nearer the primary, making and breaking the current as before.

A point will be reached at which the make induction also causes contraction. Obviously, the break current is a stronger stimulus than the make induction current. The cause of the greater intensity of the break induction current lies in the primary coil. The current which en-

the coils approach is not linear. An exact method of graduation has been given by Kronecker.

ters the primary coil induces a current in this coil as well as in the secondary coil. The direction of this "self-induced" current is opposite to that of the primary current, and hence weakens it and delays its development. The stimulating power of electricity increases with both the intensity of the current and the quickness with which the intensity alters. Hence the stimulating power of the make induction current is lessened by the self-induction of the primary coil. When, on the other hand, the primary circuit is broken, the current stops, and although self-induction again takes place, it cannot affect the primary current, because the latter no longer exists. The self-induced current at the break of the primary current is in the same direction as the primary current.

**The Extra Currents at the Opening and Closing of the Primary Current.** — 1. Remove the secondary coil from the inductorium. Connect posts 1 and 2 of the primary coil with a dry cell, interposing a simple key. Fasten the ends of the electrode wires in these same posts. Close the primary circuit. Place the electrode points against the tongue. Open the key.

A shock from the self-induced current developed in the primary coil will be felt.

Draw a diagram of the circuits.

2. Connect a dry cell through a key to the metre posts of the rheocord (Fig. 10). Connect the positive post and the slider to the primary coil of an inductorium arranged for single induction currents. Bring wires from these posts of the primary coil through a simple key to the nerve of a nerve-muscle preparation. Close the key in the primary circuit. Open and close the key in the nerve circuit.

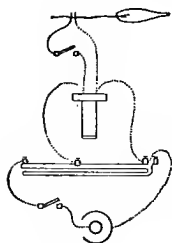

Fig. 10.

The muscle will contract at closure and possibly at opening. By means of the slider, weaken the current through the primary coil until opening and closing the key to the nerve no longer produces contraction. Now let this key remain closed and make and

break the primary circuit.

The muscle will contract both on opening and closure. The induction currents developed in the primary coil when the primary current is made and broken stimulate the nerve, although the galvanic current itself is powerless to do so.

**Tetanzing Currents.** — Connect a dry cell to posts 2 and 3 of the primary coil. The vibrating hammer will automatically make and break



the current. Place the electrodes against the nerve or muscle.

The muscle will contract once for each induction current, but the contractions are so rapid that they fuse into a prolonged shortening termed tetanus.

**Induction in Nerves.** — Faraday discovered that currents can be induced in electrolytes as well as metallic conductors. Induced currents may therefore appear in nerves lying sufficiently near a primary circuit.

Lay the well-moistened nerve of a nerve-muscle preparation around the primary coil protected by a piece of paraffin paper in such a way that the free end of the nerve touches the nerve near the muscle or touches the muscle itself, so as to form a closed circuit. Make and break the primary current.

Make and break currents will be induced in the nerve, and the muscle will contract.

**Exclusion of Make or Break Current.** — Connect the dry cell with posts 1 and 2, interposing a key. See that the short-circuiting key, *i. e.* the thick brass bridge between the posts on the secondary coil, is down. Connect the electrodes with the secondary coil, and place their points against the nerve of a nerve-muscle preparation. Close the primary key.

The muscle will not contract.

The resistance to the passage of the induced current through the portion of nerve between the ends of the electrodes is many thousand times greater than the resistance of the brass bridge or short-circuiting key. Practically none of the electricity will pass through the nerve when the short-circuiting key is closed.

Open the short-circuiting key and then open the primary key.

The muscle contracts.

Repeat the experiment, letting the make current pass and short-circuiting the break.

With the primary key and a short-circuiting key either break or make induced currents can be used as stimuli at will.

### UNIPOLAR INDUCTION

1. Arrange the inductorium for tetanizing currents (posts 2 and 3). Make a nerve-muscle preparation. Lay it on a clean dry glass plate. Let the nerve rest on a wire connected with one pole of the secondary coil. Set the inductorium in action. Connect the muscle with the earth by touching the muscle with the end of a wire, the other end of which rests on a gas or water pipe.

The muscle will show tetanic contractions,

provided the induced current is sufficiently strong. If no tetanus is seen, move the secondary coil completely over the primary.

2. Ligature the nerve between the electrode and the muscle, and repeat the experiment.

Stimulation will still be secured. The unipolar discharge passes through the entire length of nerve and muscle to or from the point at which the connection with the earth is made, and thus stimulates the entire preparation.

DuBois-Reymond, who was the first to make the preceding experiments, pointed out that whenever the secondary circuit was open (*i. e.* when the bridge between the ends of the secondary wire was up) the making and breaking of the primary circuit caused free electricity to gather on the ends of the secondary wire. When the electro-static induction becomes great enough the electromotive force overcomes the resistance in whatever connecting path may be offered, and the electricity passes from the coil to the earth. If a part of the path is formed by irritable tissues, they will of course be stimulated.

3. The quantity of electricity passing through the nerve may be increased by approximating the coils or by increasing the electrical capacity of the conductor, as follows:—

Remove the connecting wire of the prepara-

tion. Set the inductorium in action. Touch the muscle with the moistened finger.

Contraction follows.

Here the electrical capacity of the preparation is increased by connecting the preparation with the human body, a conductor of large surface (and through it with the earth). A similar result is obtained by unipolar stimulation of nerves and muscles while still in the body of the animal, as in many physiological experiments. It is not necessary that the surface of the conductor be enormously large. The following experiment shows that even very small surfaces will suffice.

4. On a carefully dried, clean glass plate lay four nerve-muscle preparations. Let the nerve of the first rest on a single wire the other end of which is fastened in one of the binding posts of the secondary coil. Place the end of the second nerve on the tendon of the muscle of the first preparation, the third on the second tendon, and the fourth nerve on the tendon of the third. Remove the secondary coil some distance (a few centimetres) from the primary, and set the inductorium in action. Gradually approximate the coils.

As the tension at the ends of the secondary wire increases by the approximation of the coils,

the first preparation will contract. On further approximation, the first and second; then the first, second, and third; and finally all four will contract.

This instructive experiment shows that when the conducting surface is small, as in the present instance, the unipolar action is greater on the parts nearer the secondary wire than on parts farther away. The danger of unipolar action on tissues lying near the electrodes in ordinary artificial stimulation of nerves and muscles *in situ* is obvious.

5. It is not even necessary that the conductor should be actually in contact with the preparation.

Connect a nerve-muscle preparation, insulated on a glass plate, with one pole of the secondary coil, and set the inductorium in action. The secondary coil should completely cover the primary. Bring a moistened finger as near the muscle as possible without touching it.

With the proper intensity of the primary current, contraction will take place, though absent when the finger is removed.

The sudden approach of a condenser charged with static electricity will stimulate an isolated nerve or muscle.

6. The danger of error from unipolar action is

particularly great in electrometer observations on the current of rest or action current of nerve and muscle, discussed in Chapter VII., and will there be demonstrated experimentally.

The errors due to unipolar action can usually be prevented by the following precautions: The secondary coil should always be connected with the tissue to be stimulated through a short-circuiting key, which should be kept closed except during the intentional stimulation of the tissue. With this good metallic connection between the ends of the secondary wire there will be no static electrification. Further, the appearance of positive and negative electricity during the period of stimulation must be provided against, especially if that period is at all protracted, for it must not be forgotten that the bridge of nerve, which completes the secondary circuit by uniting the two electrodes, possesses very high resistance, and thus affords but an imperfect closure of the ends of the secondary wire. This provision is made by connecting the positive electrode with the earth by a good conductor, for example, by a copper wire leading from the electrode to the gas or water pipe. In case of doubt, a control experiment should be made. The nerve should be severed between the stimulated point and the muscle, and one

end laid on the other. Excitation through the passage of a nerve impulse along the nerve is thereby made impossible. If the muscle still contracts when the nerve is stimulated above the section, it is because of unipolar stimulation.

An additional reason for care is that the insulation of the secondary spiral is injured by leaving the secondary circuit open while the hammer of the inductorium is in action.

It may be stated that the direction of the unipolar discharge is of importance. Excitation takes place only where the positive charge enters the nerve or the negative charge leaves the nerve.

The break induction current is more effective than the make, as the slower development of the latter causes the terminals of the secondary wire to be charged more slowly than by the rapidly developed break current.

#### APPARATUS

Normal saline. Bowl. Towel. Pipette. Glass plate. Zinc wire, 4 inches long. Copper wire, 4 inches long. Porcelain dish. Mercury. 5% sulphuric acid. 5% solution of potassium chromate. Iron wire, 4 inches long. Muscle clamp. Iron stand. Capillary electrometer. Rheocord. Microscope (micrometer ocular, objective 3). Daniell cell. Dry cell. Two platinum electrodes. Zinc electrode. Beaker. Sodium chloride. Simple key. 9 wires, 2 feet long. Saturated solution of copper sulphate.

## 50 THE PHYSIOLOGY OF MUSCLE AND NERVE

Pole-changer (in paper dish). Filter paper saturated with starch paste containing potassium iodide. Inductarium (with electrodes). Coil with few windings (primary coil of a second inductarium). Bar magnet. Iron filings. Galvanometer. Card, with thick copper wire. Ligatures. Frogs.



## III

## THE GRAPHIC METHOD

THE studies next to be undertaken make use of the change of form of the contracting muscle as a partial index to the transformation of energy in the tissue. A permanent record is desirable. Further, the changes in the dimensions of the muscle are so small that it is necessary to have the graphic record enlarged, rather than of actual size. To satisfy these conditions, the muscle is attached near the fulcrum of a lever furnished with a recording point. The surface for the writing is usually glazed paper which has been covered with a thin layer of soot by passing the paper through the luminous part of a broad gas flame. The paper is fastened (before smoking)

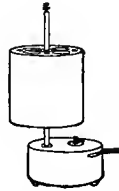

Fig. 11. The kymograph or record drum. The aluminium drum is driven by clockwork at speeds varying from one revolution per hour to eight per minute. The brass tube or sleeve on which it is held by a spring clip rests below on a disk fastened to a steel spindle which passes through the whole length of the sleeve. By turning the screw at the top the sleeve with the drum can be raised off the friction bearing. It can then be revolved rapidly by hand (spun) at a sufficiently uniform speed.

on a plate or on a drum which moves past the writing point and furnishes thus a continuously fresh surface.<sup>1</sup>

<sup>1</sup> The paper is cut wider and longer than the surface of the drum. The extra width is to protect the bearings of the drum from soot that might otherwise collect there in smoking the paper. The extra length allows the edge of the overlap to be gummed to the paper below, permits the paper to be removed from the drum by cutting through the overlap parallel to the mucilage, — the surface of the drum being protected from the knife by the underlying paper, — and provides an unsmoked surface by which the paper can be handled on its removal from the drum. The drum should be laid in the centre of the strip of paper, the gummed edge to the left, and the axis of the drum precisely at right angles to the long axis of the paper; the mucilage should be moistened, and the ends of the paper brought around and fastened. If the paper is awry, the surface will not lie uniformly against the drum and the record will be deformed. The drum should now be placed in the smoking apparatus, revolved uniformly and not too fast, brought over the gas flame, lowered just below the upper edge of the flame, and covered with a chocolate brown layer of soot, beginning at the operator's left hand and passing gradually to the right. The speed should be such that one passage from left to right shall suffice. To trim the edges, hold the drum in the left hand, inclined downwards, and pass a sharp knife-blade around the lower edge. The handle of the knife should be kept lower than the blade, to avoid tearing. In removing the paper from the drum, hold the drum in the air with the left thumb pressed on the edge of the paper near the overlap, and cut through the overlapping edge near the mucilage. The loosened paper will hang down and may then be seized by the unsmoked overlap. In recording, let all the curves begin near the overlap. Attention to these details is indispensable to the best technical results.

The writing point rubs off the soot in its path and leaves a white magnified tracing of the muscle's change in length or whatever dimension is the subject of record. The paper is then removed, drawn through a saturated solution of white shellac in 95 per cent alcohol,<sup>1</sup> and hung up until the alcohol is evaporated. The soot will be covered over thereby, and held in place by a thin layer of shellac, and the record will be secure.

The graphic record involves the use of apparatus. It never should be forgotten that the use of apparatus always introduces more or less error. In every experiment the apparatus should be criticised sharply. The numerous imperfections which such scrutiny will bring to light are of two sorts, — the errors that may be neglected, and the errors that may not be neglected without seriously impairing the value of the method for the purpose in hand. For example, a count of the pulse rate with an ordinary watch will usually be incorrect by one or two beats in the minute, but such a record is quite accurate enough for most purposes. The use of a stop-watch marking fifths of seconds would add nothing to the value of the count,

<sup>1</sup> To make this solution, the alcohol should be allowed to stand on the shellac a month or more before using.

for the error introduced by numberless causes that slightly modify the heart beat from minute to minute is greater than the error introduced by using an ordinary watch instead of a stop-watch. The correction of errors that are too small to alter essentially the value of the method for the purpose to which it is applied is usually wasteful.

With these points in mind, smoke a drum. Arrange the inductorium with simple key for maximal break induction currents. Prepare a gastrocnemius muscle, fasten it in the muscle clamp, tie a fine copper wire around the tendo Achillis, wrap the wire about the hook on the muscle lever, and fasten the end in the binding post on the handle of the lever (Fig. 13, page 60). Connect the secondary coil with the posts on the muscle clamp and muscle lever respectively. Weight the muscle with ten grams. Arrange the lever to write on the drum. Record single contractions with various speeds.

Note that the muscle writes its contraction in the form of a curve, the ordinates of which measure the height to which the load is lifted.

Start the drum at very rapid speed. Bring the writing point of the vibrating tuning fork (Fig. 12) against the paper below the point of the muscle lever, and stimulate the muscle to contract.

Observe that the tuning fork now gives the time intervals on the abscissa of the muscle curve, from which the duration of the periods of shortening and relaxation may be known. Note also the difference in appearance of the curves taken on a slow and a rapidly moving surface.

Measure the interval between the beginning of contraction and the point of maximum shortening.

Write a critical account of the muscle lever in your laboratory note-book.

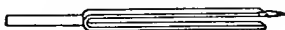

Fig. 12. The tuning-fork.

Compare this account with the remarks which follow:—

The object of the muscle lever is to write a magnified record of the change in form of the muscle. Usually the muscle is suspended in a muscle clamp and its lower end attached to the lever, which then records the shortening of the muscle. The same lever may be used to record the thickening of the muscle; in this case the muscle is of course horizontal and the lever rests upon it. For either purpose the weight of the lever is an objection, for it tends to prevent the muscle from beginning its movement (inertia of position). Once in motion, the weight tends to keep moving, and thus to continue the record of contraction

after the actual contraction has ceased (inertia of motion). As the inertia of motion increases with the mass and the square of the velocity, the lighter the lever the less the error. The disposition of the weight relative to the axis is also of importance. In a swinging system, the nearer the mass to the axis of rotation, the less are the after vibrations or pendulum-like oscillations which continue after the original impulse has ceased. For this reason, in experiments likely to be disturbed by after vibrations, the weight which the muscle lifts is attached to the small pulley, so as to be as near the axis as possible. In this case, the weight on the muscle is of course not the weight hung on the pulley; the pulley weight must be divided by the number of times the radius of the pulley is contained in the distance between the axis and the point of attachment of the muscle to the lever.

It will be observed that the writing point is a strip of tinsel bent slightly and placed parallel to the writing surface. It is very easily moved in a direction at right angles to the writing surface, but resists movement in a vertical direction. The bend makes the strip a weak spring, enabling the point to remain in contact with the drum throughout the excursion of the point on the paper. The writing point should be as nearly as possible parallel to the paper. Even in this

position, the distance of the end of the straw from the paper is necessarily less when the lever is horizontal than when raised by the contraction of the muscle, for the end of the lever describes a curved line in a plane tangent to the recording surface. Were it not for the spring of the writing point, the latter would leave the drum. To remain on the drum at the height of the contraction, the point must at the beginning of contraction press against the drum with much more friction than is necessary simply for scratching through the layer of soot. Thus the distance of the writing point from the axis is constantly varying, and the magnification of the lever is constantly changing. Within the limits ordinarily employed in physiology, the deformation of the curve thereby produced is proportional to the length of the arc through which the point moves; the curve should therefore be written no larger than is necessary for clearness.

When the smoked surface is at rest, and the contracting muscle lifts the lever, the writing point describes an arc; when the muscle relaxes, the writing point returns in the same line. When the drum revolves, the writing point describes a curve as the muscle contracts. The maximum shortening of the muscle, or height to which the load is lifted, is measured by a perpendicular drawn from the highest point of the curve to the

abscissa. The time required for the muscle to reach this height, however, is not the distance on the abscissa from the beginning of the curve to the perpendicular, but to the point at which the segment of a circle of a radius equal to the length of the lever would cut the abscissa when drawn from the highest point of the curve. Practically, this measurement is made by turning the drum back until the point of the raised lever rests at the summit of the curve, and then, while the drum is at rest, allowing the lever to write the ordinate by falling down to the abscissa.

Perpendicular ordinates may be secured by a long pin passed transversely through the end of the writing lever, and bent twice at right angles, first parallel to the paper and then towards it. The lever is perpendicular to the paper and very near it; the weight of the pin keeps the point against the paper as the lever rises. The perpendicular writing has many faults in common with arc writing.

#### APPARATUS

Normal saline. Bowl. Pipette. Towel. Glass plate. Kymograph. Glazed paper. Smoking apparatus. Shellacking trough. Shellac in alcohol. Muscle lever (weight pan). Muscle clamp. Stand. Inductorium. Electrodes. Simple key. Dry cell. 5 wires. Fine copper wire. Ten gram weight. Tuning fork. Tin foil. Cement. Frogs.



## IV

THE ELECTRICAL STIMULATION OF MUSCLE  
AND NERVE

## THE GALVANIC CURRENT

THE study of the changes occasioned in muscle and nerve by electrical stimulation may profitably begin with the action of the galvanic current.

**Non-Polarizable Electrodes.** — When metal electrodes come in contact with an electrolyte, polarization currents develop (see page 25). Electrodes of metal for this reason should be avoided in the study of the effect of the galvanic current on muscle and nerve. A “non-polarizable” electrode should be employed. Strictly speaking, no electrode is non-polarizable, but practically the polarization errors are excluded by the following device: A small brush of camel’s hair from which the quill and other wrappings have been removed is passed, point first, through the large end of a glass tube, about two inches long, the other end of which

has been drawn out to a diameter about that of the thick end of the brush. The latter is

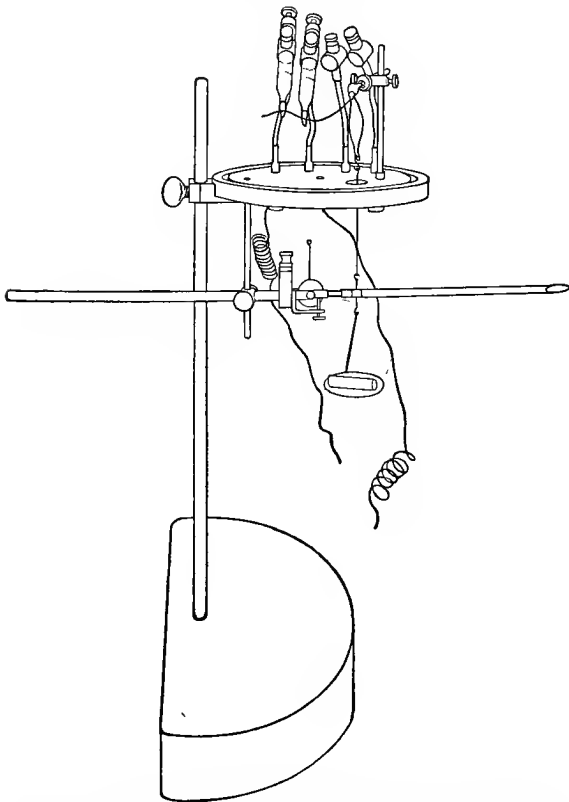

Fig. 13. The moist chamber with non-polarizable brush electrodes and muscle lever. The glass cover of the chamber has been omitted for the sake of clearness.

brought through the drawn-out end of the tube until it is held fast by the glass. The tube for a short distance above the brush is packed with potter's clay moistened with 0.6 per cent solution of sodium chloride. The tube is now partly filled with saturated solution of zinc sulphate and an amalgamated zinc wire provided with a binding post is inserted and held in place by a piece of rubber tubing, as drawn in Fig. 13. Finally, the brush is wet with the saline solution.

**Opening and Closing Contraction.** — Smoke a drum. Arrange the muscle lever to write on the smoked paper. Make two non-polarizable electrodes (the hands which touch the clay should be scrupulously clean; metal instruments should not be used). Fasten the electrodes by means of the spring clips to the glass plate of the nerve-holder. Connect them through an open simple key with the poles of a dry cell. Prepare a sartorius muscle (Fig. 14) the nerve-endings in which have been paralyzed with curare, preserving the pelvic and tibial attachments. Fasten the piece of pelvic bone in the muscle clamp. Let the ends of the electrodes rest on the muscle. To the tibial end tie a thread, and fasten the thread to the upright pin of the muscle lever, so that the horizontal

muscle may write its curve on the drum. Close

the key. Turn the drum by hand about 5 mm. Open the key.

The muscle will twitch when the current is made and probably when it is broken, but during the passage of the current there will be no contraction.

This would seem to indicate that the muscle is stimulated only by a sudden change in the intensity of the current (DuBois-Rey-

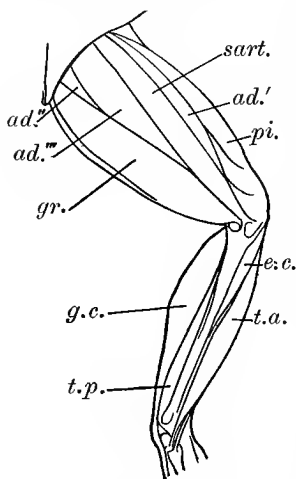

Fig. 14. Hind limb of frog, anterior view (Ecker-Wiedersheim).

mond). Into this important matter, we must inquire at some length.

**Changes in Intensity of Stimulus.** — 1. *Sudden change.* Connect the zinc of a dry cell through an open simple key (Fig. 15, A), with one of the electrodes of the preceding experiment and the carbon with one post of a closed short-circuiting key (Fig. 15, B). Connect this same post with the zinc of another cell. Connect the remaining post with the carbon of the second cell and with the remaining electrode.

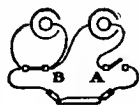

Fig. 15.

Close A.

The muscle will contract.

Open B, thus suddenly increasing the strength of the current.

The muscle will again contract.

2. *Gradual change.* Lead from the outer zinc and carbon of two cells coupled in series (zinc to carbon) to the 0 and 1 metre posts of the rheocord, through an open simple key (Fig. 16). Note that only one-tenth the wire in the rheocord is included in the circuit; the resistance of the entire length (10 metres) would be too great. Bring the slider close to the post 0, so that only a small fraction of the current can flow through the electrodes. Place the electrodes on the muscle. Close the key. The muscle contracts. Move the slider very gradually along the wire until all the current possible passes through the muscle.

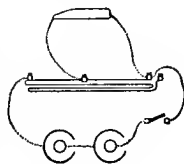

Fig. 16.

There will be no contraction.

*With Indirect Stimulation.* — 1. Smoke a drum. Make a nerve-muscle preparation (sciatic nerve and gastrocnemius muscle). Place the femur in the clamp in the moist chamber. Let the nerve rest on non-polarizable electrodes connected through an open key with a dry cell. Attach

the tendo Achillis to the muscle lever. Let the muscle lever write on a slowly moving drum. Close and open the key.

Both closing and opening contraction will be seen. (If the frog has been brought from a cold room into the warm laboratory, opening and closing tetanus will probably replace the usual twitch. See page 108.)

2. Repeat Experiment 2, page 63, using the nerve-muscle preparation instead of the curarized muscle.

It will again be found that the intensity of the current must be increased with a certain rapidity in order to stimulate.

The experiments just made support DuBois-Reymond's statement that the electrical current does not stimulate during the entire period of its flow through the irritable tissue, but only when the intensity is rapidly altered by making or breaking the circuit. These experiments, however, were made on the rapidly reacting skeletal muscle of the frog. The law does not hold good for sluggish contractile tissue. Indeed it can be disproved even for highly striated muscle by a very careful examination of the manner in which excitation takes place. Pflüger discovered that when the galvanic current is made, excitation takes place only at the points

through which the current leaves the muscle or nerve (cathodal stimulation), and that when the current is broken, excitation takes place only where the current enters the irritable tissue. This "polar excitation" we must now consider. We shall find, among many other facts, the refutation of the idea that stimulation does not occur throughout the passage of the current.

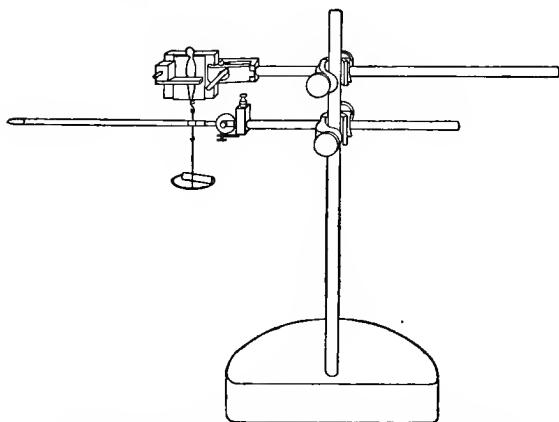

Fig. 17. The cork clamp, with muscle attached to muscle lever.

### POLAR STIMULATION OF MUSCLE

1. Slit the curarized sartorius muscle trouser-like from the lower end. Lay it on a glass plate. Bring one non-polarizable electrode against each leg. Make and break the current.

On making the current the cathodal side will contract; on breaking, the anodal side.

2. Lay the muscle on ice covered with a small piece of paraffin paper, to shield the muscle from water. When thoroughly cold, place the muscle in the cork clamp (Fig. 17), making very gentle pressure across the middle, and bring the non-polarizable electrodes against the ends. Make and, after a minute, break the current.

The excitation wave passes so slowly through cooled muscle that the contraction can be seen with the unaided eye to begin at the cathode on closing and at the anode on opening the circuit.

3. **Ureter.**<sup>1</sup>—Place the extirpated ureter of any mammal on a glass plate set as a cover on a beaker containing hot normal saline solution, so that the hot vapor of the water shall keep the ureter warm. Bring the non-polarizable electrodes against the ureter. Note which electrode is the cathode. Close the key.

After a distinct latent period the ureter in the cathodal region, and nowhere else, will contract, and the contraction wave will spread from the cathode in both directions along the ureter.

Open the key.

<sup>1</sup> The experiment succeeds also with extirpated pieces of intestine about four inches long, provided they are kept warm with normal saline solution.



The contraction takes place now only at the anode, and the contraction wave spreads from that point over the muscle (as making the current is a less effective stimulus than breaking, it may be necessary to increase the strength of the current, or to keep it closed a considerable time, in order to secure making contraction).

4. **Intestine.** — Place the non-polarizable anode on the intestine of a freshly killed rabbit, the cathode on some indifferent point, for example, the liver. Close the key.

The intestine will constrict in the anodal region and remain constricted during the passage of the current, provided it be not so long as to cause fatigue. A peristaltic contraction wave usually passes from the anode in both directions along the intestine.

Place the cathode on the intestine, and the anode on an indifferent point. Close the key.

A small, indistinct thickening will be seen in the cathodal region.

Thus the intestine, while it serves admirably to illustrate a polar action of the galvanic current, apparently differs from the tissues already considered in that closure causes contraction at the anode instead of the cathode. The exception is only apparent, and its explanation is that the point at which the electrode touches the peri-

toneal surface of the many-layered intestinal wall is not the physiological anode or cathode; *i. e.* not the point at which the current actually enters or leaves the muscular coat. This matter is discussed on page 71.

5. Smoke a drum. Raise the drum off the friction bearing by turning the screw at the top of the shaft to the right. Arrange two muscle

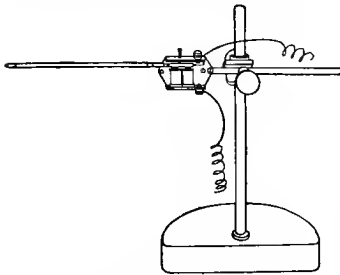

Fig. 18. The electromagnetic signal.

levers and the electromagnetic signal (Fig. 18) to write on the drum in the same vertical line. Place the signal in the circuit between one dry cell and the rheocord; otherwise let the

electrical connections be as in Fig. 16, page 63. Bring the slider near the positive post of the rheocord. Fasten a curarized sartorius muscle by the middle in the cork clamp; the pressure should be enough to prevent the contraction wave of one part reaching the other part, but not great enough to prevent the passage of the excitation. Secure the cork clamp in the jaws of the muscle clamp in such a way that the muscle

shall be vertical to the writing levers. Tie a thread around the pelvic and tibial fragments and fasten each thread to a muscle lever, so that each half of the muscle may record its contraction independently of the other. Let the brush of one of the non-polarizable electrodes rest on each end of the muscle. Note which lever is connected with the cathodal end. Make the current. If the muscle does not contract, move the slider along the wire a short distance towards the positive post (so as to bring a stronger current through the electrodes) and make the current again. When both make and break contractions are secured, see that the writing points record properly, and "spin" the drum, but not too fast. As soon as the drum moves steadily, make and then break the current.

The moment of making and breaking the current will be recorded by the electromagnetic signal. An instant later the muscle levers will begin their record of the contractions.

It will be found that the cathodal half of the muscle contracts first on closing, the anodal half on opening the current. Evidently the excitation began on closure at the cathode and passed thence to the anode, while on opening the circuit the excitation began at the anode and passed to the cathode.

In order to measure this interval accurately the drum should be turned back until the writing point of the signal lies precisely in the ordinate drawn by it during the experiment. The muscle should then be stimulated. The ordinate now drawn by the muscle with the drum thus at rest will be synchronous with that drawn by the signal during the experiment, and will mark upon the abscissa of the muscle curve the moment of stimulation.

**6. Tonic Contraction.** — Connect a dry cell through an open simple key with the metre posts of the rheocord. Connect non-polarizable electrodes with the positive post and the slider. Fasten one end of the curarized sartorius (prepared with fragments of pelvis and tibia attached) in the muscle clamp. Tie a thread to the other end and fasten the thread to the upright pin of the muscle lever. Let non-polarizable electrodes rest on the muscle near the respective ends. Use a strength of current that will just cause contraction on closure. Watch very closely the cathodal region near the junction of the muscle fibres with the tendon. Close the key.

After the closing contraction, the ends of the muscle fibres next the tendon in the cathodal region will show a faint but distinct thickening, which will remain until the current is broken.

These several experiments demonstrate that in galvanic stimulation of both skeletal and smooth muscle the excitation takes place at the points where the current leaves and enters the muscle. Before inquiring whether this law holds good for the heart, the muscle cells in which have a form intermediate between the smooth muscle cell and the cells of skeletal muscle, it will be necessary to consider whether the points of contact with the electrodes are always the real anode and cathode.

**Physiological Anode and Cathode.** — When the electrodes are placed directly on a nerve, or are applied to a muscle with straight parallel fibres in such a way that the current flows through each fibre from end to end, the anode and cathode obviously coincide with the points at which the electrodes touch the muscle. When, however, the fibres are of irregular shape, or are irregularly disposed, the current lines can no longer traverse the fibres from end to end, but will enter and leave fibres at points other than those in contact with the electrodes.

The difference between the operator's electrodes and the physiological anode and cathode is also obvious when the electrodes are applied to skin, connective tissue, mucous membrane, etc., covering the muscle or nerve,—the points at which the electrodes touch the covering tissue

cannot be the points at which the current actually leaves or enters the muscle.

The failure to keep this distinction in mind may lead to wholly erroneous interpretations. Thus when the ureter is extirpated, or is raised from the tissues on which it normally rests, its reaction to the galvanic current follows the law, — contraction begins at cathode on making, at anode on breaking the current; but when the ureter is stimulated *in situ*, exactly the opposite effect is seen, — contraction begins at anode on making the current. The explanation is that the current lines in the latter case are very widely diffused through the conducting tissues on which the ureter lies, so that the current passes into and out of the muscle fibres for some distance either side of the positive electrode. Each point at which the current leaves a fibre is a secondary cathode, and if the number of such points is large, cathodal stimulation will take place in what, superficially regarded, is the anodal region (compare page 93, and Fig. 27). The same explanation holds good for the intestine (see page 67). The formation of physiological anodes and cathodes is well shown in the next experiment.

*Physiological Anodes and Cathodes in Rectus Muscle.* — Remove the rectus abdominis muscle. Note the tendinous bands that cross the muscle

from side to side and divide it into parts. Lay the muscle smoothly on a glass slide. Connect the non-polarizable electrodes through a simple key with a dry cell. Place one electrode on each end of the muscle. Close the key.

On closure, the cathodal side of each division of the muscle will show a sharply defined continued contraction of the ends of the fibres at their insertion in the transverse tendinous bands. On opening, the cathodal contraction disappears, and a similar thickening of the fibres is seen at the anodal side of each division. The twitch of each segment on closure and opening of the current also starts respectively from the cathodal and anodal ends of each segment. These effects are best seen through a magnifying glass.

**Polar Stimulation in Heart.** — The muscle cells of the heart are not only of irregular shape, but they are so joined with each other as to make it impossible to pass a current through the heart muscle without the current lines cutting fibres in every direction. It would seem therefore that secondary anodes and cathodes would be formed to such a degree that the demonstration of polar excitation would be difficult or impossible. Experimentation shows however that this is not the case. The heart behaves like a single hollow fibre.

*Monopolar Method.*—The small size and conical form of the ventricle of the frog's heart make the ordinary method of stimulation, in which the electrodes would both be placed on the heart, less suitable than the monopolar method. This method was suggested by the fact that the stimulating effect of the galvanic current depends on its density. If one electrode has a large surface, and the other a very small surface, the current lines will

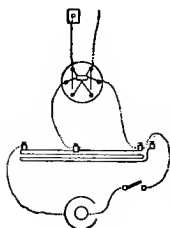

Fig. 19.

be distributed through a considerable cross-section in the first instance and converge to a small cone in the second. The threshold value of stimulation will not be reached at the large electrode, and stimulation will occur only at the small electrode. Thus the large "indifferent" electrode may be placed on any part of the frog's body, and the convenient small electrode be used to stimulate the heart.

Cover the indifferent electrode (consisting of a brass plate furnished with a binding post) with cotton wet with saline solution. Make one fine-pointed non-polarizable electrode. Connect a dry cell with the metre posts (0 and 1) of the rheocord through a simple key (Fig. 19). Connect post 0 and the slider through a pole-



changer (with cross-wires) with the electrodes. Expose the heart, according to the following method: Place the brainless frog, back down, in the holder. Cut through the skin across the middle of the body from side to side. Make a second cut in the middle line from the first cut to near the lower jaw. Turn back the flaps. Cut through the sternal cartilage near its lower end, thus avoiding the epigastric vein. Cautiously remove the breast bone, doing no harm to deeper parts. Open the delicate membrane (pericardium) which surrounds the heart. Tie a ligature about the auriculo-ventricular junction, to stop the ventricular contractions. Place the indifferent electrode over the larynx and the non-polarizable electrode on the ventricle. Turn the pole-changer so that the electrode on the heart becomes the anode. Close and then open the key.

Contraction will take place on opening only, if at all. Reverse the pole-changer so that the cardiac electrode becomes the cathode. Close and then open the key.

Contraction takes place at closure only.

#### POLAR STIMULATION OF NERVE

**Law of Contraction.** — 1. Whether contraction will follow the galvanic stimulation of a motor nerve depends on the irritability of the nerve

and the direction and intensity of the current. The current may pass through the intrapolar portion of the nerve towards the muscle (descending current) or away from it (ascending current). The intensity may be weak, medium, or strong; intensity in this case is evidently merely a relative term, depending on the irritability of the particular nerve in hand. We will test first the effect of the ascending current.

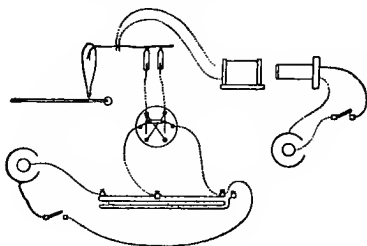
Fig. 20.<sup>1</sup>

Connect a dry cell through an open key with the metre posts of the rheocord (Fig. 20). Join the positive post and the slider through a pole-changer (cross-wires in place), with the non-polarizable electrodes placed in the moist chamber (Fig. 13, page 60), in the holders farthest from the opening for the muscle. Make a nerve-muscle preparation. Secure the femur in the femur clamp of the moist chamber. Let the

<sup>1</sup> The inductorium shown in Fig. 20 is not used in this experiment, but in the first experiment on page 79.

nerve lie on the non-polarizable electrodes. Attach the Achilles tendon to the muscle lever. Keep the air in the chamber moist by lining the glass shade with filter paper saturated with water. Arrange the pole-changer so that the anode shall be next the muscle. Move the slider near the positive post. Make and break the galvanic current. If no contraction is secured, move the slider to increase the current, and repeat the experiment.

The first contraction will take place on making the current. Continue to increase the current strength by moving the slider.

A point will be reached at which contraction will occur both on opening and closure.

Increase the intensity of the current by adding dry cells in series (zinc to carbon), testing the effect after each addition by closing and opening the current.

An intensity will be reached at which opening and not closure causes contraction.

In a similar manner, work out the law of contraction for descending currents. (It may be necessary to take a fresh nerve-muscle preparation.)

Set down the results in a table.

Intensity of current.	Ascending current.		Descending current.	
	Make.	Break.	Make.	Break.
Weak.	Contr.	Rest.	Contr.	Rest.
Medium.	Contr.	Contr.	Contr.	Contr.
Strong.	Rest.	Contr.	Contr.	Rest (Weak contr.).

2. The remarkable nature of these results is apparent on observing that contraction is easily secured on closing a weak ascending current and yet cannot be obtained with a strong one. The first step in the inquiry into the causes of the phenomena is to determine whether the stimulation is polar. That the nerve impulse really starts at the cathode on closure and at the anode on opening is shown (1) by the fact that the interval between stimulation and contraction, with the ascending current, in which the anode is next the muscle, is longer at closure than on opening, while the opposite is the case when the current is descending. (2) With descending currents, it sometimes happens that opening produces tetanus instead of a simple twitch. If this tetanus appears, the student should sever the nerve between the electrodes. Immediately the contractions will cease. They must therefore have arisen at the anode, for the cathode still remains in full connection with the muscle.

**Changes in Irritability.** — The second step in this inquiry is to determine the nature of the changes at the poles. For this purpose the nerve should be stimulated in the cathodal and anodal regions during the passage of the constant current.

1. Place ordinary metal electrodes in the pair of holders next the muscle in the moist chamber. Connect them with the secondary coil of an inductorium (Fig. 20). Arrange the primary for single induction shocks, which must not be maximal. Turn the pole-changer to bring the cathode next the metal electrodes. Using a break induction current as stimulus, record on a stationary drum three contractions, (1) before the passing of the galvanic current through the nerve, (2) during its passage, (3) after its passage.

The second contraction — that obtained by stimulating in the cathodal region during the passage of the galvanic current — will be greater than the other two.

Reverse the galvanic current and repeat the experiment, the stimulation now being in the anodal region.

The stimulation in the anodal region during the passage of the galvanic current causes less than the normal contraction.

2. The stimulating current may be superposed directly on the polarizing current by using the same electrodes.

Connect a dry cell through an open key with the 0 and 1 metre posts of the rheocord (Fig. 21). Connect the positive post of the rheocord with one of the non-polarizable elec-

trodes. Join the slider to one end of the secondary wire of an inductorium; to the other end join the remaining non-polarizable electrode. If the positive pole of the secondary coil is not known, determine it by the electrolytic method (pages 27 and 119). Arrange the primary coil of the inductorium for single submaximal induction currents. Make and break the induction current, and record the contractions on the drum. Now pass a weak

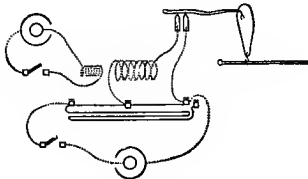

Fig. 21.

polarizing current through the nerve and stimulate again with the induction current.

It will be found that the stimulating effect of the induction current is increased when the direction of the induction current coincides with that of the polarizing current, *i. e.* when the cathode (which is the sole source of the induction stimulus, as pointed out on page 121) coincides with the cathode of the polarizing current. When the cathode of the induction circuit falls in the anodal region of the polarizing circuit, the stimulating effect is diminished. Very strong polarizing currents produce such alterations in irritability that the additional alteration caused by the brief in-

duction current is not great enough to be a stimulus.

The law revealed by this experiment may be thus expressed. The same stimulating current has a greater stimulating effect when it coincides in direction with a pre-existing current, and a lessened effect when it is opposed in direction to a pre-existing current. This law explains the interference observed between stimulating currents and demarcation or injury currents of nerve and muscle (see page 155).

3. Place a drop of saturated solution of sodium chloride on the nerve in the extrapolar region near one of the non-polarizable electrodes. Record the irregular tetanus (chemical stimulation) on a slowly moving drum. Make the polarizing current.

Note that the tetanus is increased when the cathode is nearer the stimulating solution, but diminished when the anode is nearer.

Hence the irritability of the nerve is altered during the passage of the electric current (electrotonus);<sup>1</sup> it is increased in the neighborhood

<sup>1</sup> The change in the excitability of the nerve produced by the electric current is so generally called electrotonus that the term cannot well be changed. It should not be confused with the electrotonus described on page 186, though it is possible that the two phenomena have a similar if not identical first cause.

of the cathode (catelectrotonus) and is diminished in the neighborhood of the anode (anelectrotonus). In the intrapolar region, the cathodal touches the anodal area at the so-called indifferent point. This point approaches the cathode when the intensity of the polarizing current is increased.

The greater the length of nerve between the electrodes, the greater the extrapolar electrotonus. Catelectrotonus rises rapidly to a maximum as soon as the circuit is closed, and then gradually wanes. Anelectrotonus develops more slowly and does not reach its maximum for some time after closure.

On the opening of the circuit, the conditions at the anode and cathode are reversed, the irritability falls at the cathode and rises at the anode. The fall in the cathodal region is of short duration, and the irritability soon returns again towards normal. In the anodal region, the rise on opening is unbroken.

**Changes in Conductivity.**— We have seen that the irritability is altered by the galvanic current. The conductivity also is altered.

Connect a dry cell through a pole-changer with cross-wires to a pair of non-polarizable electrodes placed in the holders of the moist chamber farthest from the muscle (Fig. 22). Leave one wire uncoupled until the current is wanted.



Connect another cell with the primary coil of the inductorium arranged for break induction shocks, placing in the circuit a simple key and the electromagnetic signal. Lead wires from the poles of the secondary coil to the side cups of a pole-changer (without cross-wires). In each of the remaining two holders of the moist chamber place a cork pierced

by two metal electrodes. One wire in each pair should be insulated from its fellow by rubber tubing drawn over the part between the cork and the end of the electrode to be applied to the nerve. Connect

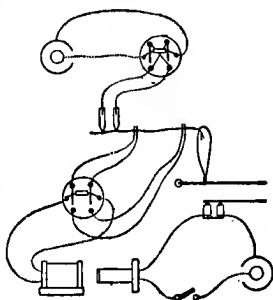

Fig. 22.

the wire soldered to the basal ends of these electrodes with the remaining cups of the pole-changer in the secondary circuit of the inductorium. Arrange the signal to write on the smoked drum beneath the writing point of the muscle lever.

Make a nerve-muscle preparation. Let the nerve rest on the non-polarizable electrodes near the cross-section. Place one pair of the metal electrodes beneath the nerve near the muscle, the

other pair near the non-polarizable electrodes. The clock-work of the drum should be fully wound (not over-wound), and the drum should revolve at its most rapid speed. Write two muscle curves. For the first stimulate through the metal electrodes nearer the muscle; for the second through the metal electrodes farther from the muscle.

While each curve is writing, let a tuning fork record its vibrations beneath the point of the muscle lever. To mark on the abscissa of the muscle curve the exact moment at which the muscle was stimulated, turn back the drum until the writing point of the signal lies precisely in the line described by it when the current was broken. Now stimulate the muscle with another induction shock. The curved ordinate of the muscle lever will be synchronous with the ordinate of the signal.

The interval between the moment of stimulation, as recorded by the signal, and the beginning of contraction, is greater when the nerve is stimulated far from the muscle. The difference is the time required for the nerve impulse to traverse the length of nerve between the electrodes, provided of course that the interval between the arrival of the nerve impulse in the muscle and the beginning of the contraction is the same in

both cases, an assumption considered reasonable by most physiologists.

Write now three other pairs of curves; one while a galvanic current passes through the non-polarizable electrodes in a descending direction (cathode nearer the muscle); a second while an ascending current passes (anode nearer the muscle); and a third, after the galvanic current has been some minutes broken, as a control. During the writing of these curves measure the velocity of the drum with the tuning fork as before.

The speed of the nerve impulse will be found to be greater than normal when the nerve impulse starting at the second pair of metal electrodes passes through an extrapolar cathodal area (*i. e.* stimulation during descending current), and less than normal when that region is made anodal by reversing the galvanic current. In other words, the conductivity of the nerve has been increased by cathodal and diminished by anodal stimulation.

2. *Conductivity is diminished by strong or protracted currents in the cathodal as well as in the anodal region.* — Place two non-polarizable electrodes upon the nerve about 3 cm. apart. Connect them through a pole-changer with two dry cells (Fig. 23). In the middle of the intrapolar region place two stimulating electrodes close

together. Connect one of the stimulating electrodes directly to the secondary coil of an inductorium arranged for single induction currents. Lead from the other stimulating electrode to a piece of nerve or muscle about 4 cm. long, and thence to the secondary coil. The introduction of this great resistance will keep most of the polarizing current in the short bridge of nerve between the polarizing electrodes. Without this

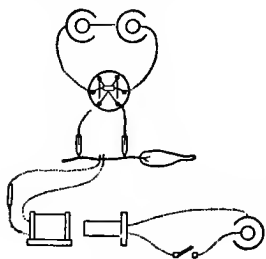

Fig. 23.

resistance, the polarizing current would pass through the stimulating circuit in preference to crossing the nerve between the stimulating electrodes. Observe that the nerve impulse created by the stimulus must pass through the

cathodal region, if the current be descending, or the anodal region, if the current be ascending, in order to reach the muscle.

Find the position of the secondary coil at which the muscle will barely contract on making the stimulating current. Turn the pole-changer to bring the anode between the stimulating electrodes and the muscle, and make the polarizing current. Open the polarizing current.

After a three-minute interval of rest, turn the pole-changer to bring the cathode next the muscle and make the polarizing current. It should be allowed to flow as long as before. Then stimulate again with a make induction current of the same intensity as before.

Contraction will be absent, or at most very weak. The impulse will be blocked in the cathodal region. In truth, during the passage of strong or protracted currents, the conductivity is more diminished in the cathodal than in the anodal region.

Grützner and Tigerstedt believe that the opening contraction is due to the stimulation of the nerve or muscle by the polarization current which appears when the galvanic current is broken. The polarization current may be said to be closed when the galvanic current is opened. These observers, therefore, hold that stimulation takes place only at closure.

We are now in a position to account for the phenomena described by the law of contraction. The irritability of the nerve is increased at the cathode on closure, and at the anode on opening the galvanic current. This rise of irritability stimulates the nerve. The rise at the cathode is a more effective stimulus than the rise at the anode; consequently with weak currents the first

stimulus to produce contraction is cathodal, *i. e.* at the closure of the circuit. As the current intensity is increased, the anodal rise becomes also effective, and contraction is secured by both making and breaking the current.

But we have to deal also with a decrease in irritability, and, still more important for the explanation of the effects of strong currents, with a decrease in conductivity. The irritability and conductivity are decreased on closure at the anode and on opening at the cathode. If the anode

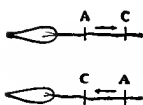

Fig. 24.

is next the muscle (Fig. 24), the decrease in conductivity on closure of a strong current will block the nerve impulse coming from the cathode; it will therefore never reach the muscle, and there

will be no contraction on closure. If the cathode is next the muscle, the conductivity may be so decreased on opening that the nerve impulse coming from the anode may be blocked. The decrease at cathode, when the current is broken, is, however, less marked than the decrease at anode when the current is made, so that the cathodal decrease, even with strong currents, sometimes fails to block the impulse entirely. In that case, a weak contraction may be obtained at the break of the descending current.

## STIMULATION OF HUMAN NERVES

Duchenne devised a method by which either the motor or the sensory human nerves can be stimulated at will, and the reaction of single muscles or groups of muscles to electricity determined. When electrodes are placed on the surface of the skin and the circuit is made, the current entering at the anode will spread in current lines through the entire body. At the cathode, all these lines will converge again. The density of the current depends on the concentration of the current lines. Thus the density is relatively great at the electrodes, and becomes rapidly weaker as the lines diverge between them. The smaller the electrode, the greater the density. The stimulating effect depends on the density. With small electrodes, a current not sufficient to cause stimulation may gradually be increased in strength until the density at the electrode becomes great enough to stimulate, while in all other regions it is not yet great enough. Thus a local stimulation is secured. But this local stimulus does not sufficiently distinguish between the sensory nerves and the motor nerves and muscles; for in order to reach the deeper lying motor nerves and muscles, the current must pass through the skin. The resistance of the epidermis is very great, and

currents of considerable intensity are necessary to overcome it. Once through the epidermis, the current spreads immediately in all directions through the cutis, where it stimulates the very

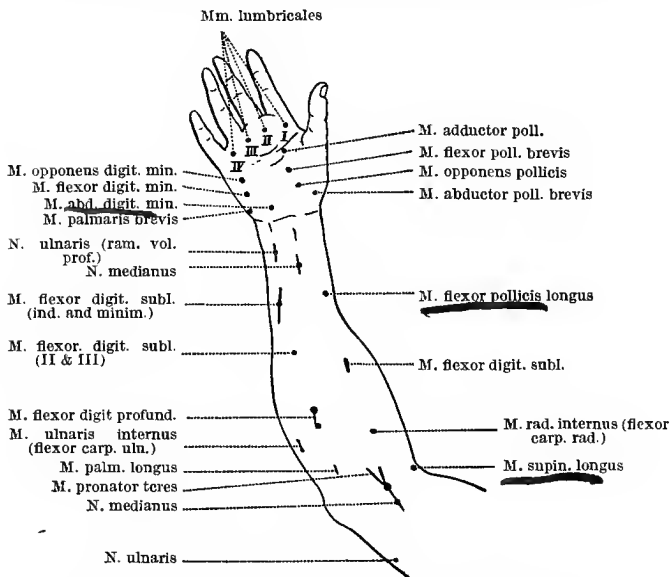

Fig. 25. The motor points on the anterior surface of the forearm and hand.

numerous sensory nerves. When the muscles or motor nerves are reached, the density is much reduced, and may not suffice for stimulation. Thus the result may be not motor stimulation, but simply pain from stimulation of the sensory



nerves. For painless motor stimulation it is, therefore, necessary to increase the strength of the current which reaches the muscle or motor nerve and to diminish the density of the current

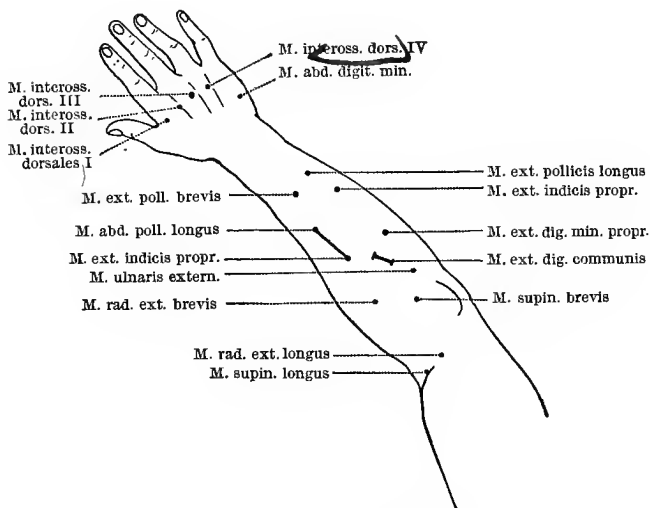

Fig. 26. The motor-points on the posterior surface of the forearm and hand.

at the electrodes. These ends are accomplished by using for electrodes large metal plates covered with sponge or cotton wet with saline solution. The liquid diminishes greatly the resistance of the epidermis, so that more current reaches

the deeper tissues; and the large surface offers a broad path for the current, so that the current lines are not so concentrated as to stimulate painfully the sensory nerves of the cutis. One sponge electrode may be made considerably smaller than the other without forfeiting this advantage, while the smaller size makes it easier to localize the stimulus.

Muscles are best stimulated through their nerves, for two reasons: the nerve responds to a weaker stimulus than the muscle; and, secondly, it is much easier to secure contraction of the whole muscle by stimulating the nerve than by attempting to pass a current through the muscle directly. The smaller electrode should be placed over the nerve, the larger on some indifferent region. The indifferent electrode may be placed over the muscle itself, if it is important that the resistance shall not be increased by the too great separation of the electrodes.

Duchenne found that certain points were especially favorable for the stimulation of individual muscles. Remak discovered that these "motor points" were simply the places at which the nerves entered the muscle. The motor points of the forearm are shown in Figs. 25 and 26.

**Stimulation of Motor Points.**—Arrange the inductorium for single induction shocks. Determine by the electrolytic method which pole

of the secondary coil is the cathode when the primary current is broken (pages 27 and 119). To this pole connect the small (stimulating) electrode; to the other pole connect the large (indifferent) electrode. Place the indifferent electrode on the arm or neck. With the small electrode make out the motor points indicated in Figs. 25 and 26.

**Polar Stimulation of Human Nerves.**— In the hands of the earlier observers the stimulation of nerves within the body gave results often contrary to the law of polar stimulation so easily demonstrated in extirpated nerves. The explanation of these inconstant results lay in the failure to comprehend the distinction between the stimulating positive and negative electrodes and the physiological anode and cathode (compare page 71). Even when the monopolar method is employed, and a small electrode is brought as near as possible to the nerve to be stimulated, while a large indifferent electrode is placed on some other part of the body, it is impossible to secure true monopolar stimulation. The current entering at the anode does not remain in the nerve, but very soon passes out into the surrounding tissues (Fig. 27). Hence there are physiological cath-

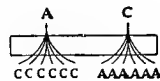

Fig. 27.

odes on both sides of the positive electrode, and for the like reason physiological anodes on both sides of the negative electrode. Thus both anodal and cathodal stimulation take place, whichever electrode rests over the nerve. It is therefore incorrect to speak of ascending and descending currents in the case of nerves stimulated *in situ*. It should be pointed out too, that the density of the current is greater on the side of the nerve nearer the electrode than on the more deeply placed side cut by current lines already rapidly diverging.

With these facts in mind, we may compare the polar stimulation of human nerve with the law already determined for the isolated nerves of the frog (page 77).

Connect 8 dry cells in series (the carbon of one cell to the zinc of the next, etc.). Coupling in this way enables the electromotive force of each cell to be added with slight loss to that of the others, provided the resistance in the circuit outside the cells is so great that the internal resistance of the battery disappears in comparison, as is the case where living tissues form part of the circuit. Connect the terminal zinc and carbon pole through a pole-changer (with cross-wires) to a small and a large electrode covered with cotton thoroughly wet with strong saline

solution. Place the small electrode over the ulnar nerve between the internal condyle and the olecranon, a little above the furrow. Make and break the current. If no contraction is secured, add cells to the battery until contraction occurs.

It will be found that the first contraction occurs on closure with the cathode over the nerve. With this strength of current the opening contraction will be absent.

Turn the pole-changer so as to bring the anode over the nerve and increase the intensity still further.

A strength will be reached at which closure with the anode over the nerve will cause contraction, but the opening of the current will still be without effect. A slightly greater intensity will now bring out the anodal opening contraction.<sup>1</sup>

In the mean time the cathodal closing contraction has increased in force with each addition to the intensity of the current. With about 18 cells, the muscle twitch on closure may give place to a continued contraction or tetanus, the cathodal closing tetanus. Further increase gives

<sup>1</sup> Sometimes anodal opening contraction precedes the closing contraction. This inconstancy results from variations in current strength due to differences in the tissues surrounding the nerve.

cathodal opening contraction, and finally very strong currents sometimes cause anodal closing tetanus. Thus we have

1. Cathodal closing contraction.
2. Anodal closing contraction.
3. Anodal opening contraction.
4. Cathodal closing tetanus.
5. Cathodal opening contraction.
6. Anodal closing tetanus (rare).

Sometimes the anodal opening precedes the anodal closing contraction.

The apparent deviation from the law of polar excitation (cathodal on closure, anodal on opening) is explained by the presence of a physiological anode and cathode at each electrode, as already mentioned. The appearance of cathodal closing contraction before anodal closing contraction is due to the fact that when the negative electrode lies over the nerve the physiological cathode will be found on the side of the nerve next the electrode. The nearer the electrode, the greater the current density, and hence the earlier the threshold value is reached. When, however, the positive electrode lies over the nerve, the physiological cathode will be found on the side of the nerve farther from the electrode, where the density is less, owing to the divergence of the current lines. The threshold

value will be reached first at the point of higher density, and consequently the first contraction will appear while the negative electrode rests over the nerve. The anodal opening contraction appears before the cathodal opening contraction for a similar reason.

**Reaction of Degeneration.** — Whenever a nerve is severed, the portion separated from the cell of origin of the nerve “degenerates.” The degeneration does not begin at the section and advance to the terminal branches, but takes place almost or quite simultaneously throughout the nerve. Ranvier states that it begins first in the end plates. Severed nerves in the brain and spinal cord degenerate in the same way, and this “Wallerian degeneration” (Waller, 1850) is a valuable aid in tracing the path of nerve fibres in the central nervous system. Degeneration is accompanied by changes in the reaction to the electric current which form a valuable aid in the diagnosis of the seat of the lesion in cases of paralysis. The muscle reacts imperfectly, or not at all, to the brief induction current, while its reaction to the long galvanic current may even be greater than usual.

Expose each gastrocnemius muscle in a frog, the left sciatic nerve of which has been severed ten days before this experiment. Stimulate each

muscle with weak induction currents and with the galvanic current.

The muscle, the nerves of which are degenerated, reacts more readily to the galvanic current than to the brief induction current. The normal muscle shows the opposite reaction.

In man, the reaction of degeneration in the case of muscle consists of a lessened or lost excitability to the induced current with increased excitability to the galvanic current. The duration of contraction may be greater than normal. In polar stimulation, anodal closing contraction may appear before cathodal closing contraction, — a reversal of the normal sequence.

In degenerated nerve there is of course a total loss of irritability, corresponding to the destruction of the axis cylinder.

#### GALVANOTROPISM

**Paramecium.** — Connect two non-polarizable electrodes through an open key with a dry cell. On a glass microscope-slide make with normal saline clay an enclosure about one centimetre square and a few millimetres high. Place in this a little hay infusion containing *Paramecia*. Bring non-polarizable electrodes against two opposite sides of the clay cell. Examine the infusion with a very low power. Close the key.



Upon closure each Paramecium turns the anterior end of the body towards the cathode and swims in that direction. In a very short time the anodal region is free, and the Paramecia are gathered at the cathode, where they remain so long as the current flows.

Open the key.

The Paramecia now turn to the anode and swim in that direction, but the anodal grouping is less complete than the cathodal, and lasts but a short time. Careful observation shows that in Paramecium the galvanic reaction consists in placing the long axis of the body in the current lines. The outermost individuals in the liquid will therefore describe a curve corresponding to the curved outer current lines.

All protozoa and many other animals (for example, the tadpole and the crayfish) show galvanotropism, but in some, movement on closure is toward the positive pole (positive galvanotropism).

These experiments on skeletal, smooth, and cardiac muscle, on nerve, and on infusoria, suggest that polar excitation occurs wherever a galvanic current passes through irritable tissue. Further experience would confirm this view. We have seen that the changes at the cathode when

the current is made are not momentary, as required by the hypothesis of DuBois-Reymond, but continue so long as the current flows. This fact appears still more clearly when the influence of the duration of the current is examined.

### INFLUENCE OF DURATION OF STIMULUS

1. Smoke a drum. Arrange a muscle lever to write on the smoked paper. Prepare non-polarizable electrodes and fasten them on the glass plate of the nerve holder.

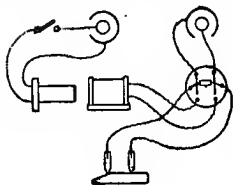

Fig. 28.

Arrange the inductorium for maximal induction currents. Lead from the secondary coil to a pair of the end cups of the pole-changer (without cross-wires), as in Fig. 28. To the opposite cups of the pole-changer bring wires from a dry cell. Connect the remaining cups with the non-polarizable electrodes. Turn the rocker towards the induction coil. Fasten the pelvic attachment of the curarized sartorius in the muscle clamp. Tie a thread to the fragment of tibia, and fasten the thread to the upright pin of the muscle lever, so that the horizontal muscle shall record its contraction on the drum. Start the drum at moderate speed. Record contrac-

tions (1) with maximal break shocks, (2) with closure of galvanic current. Compare the curves.

The curve from galvanic stimulation will be of greater height and duration, and the summit of the curve will be less pointed, indicating that the muscle remains longer in the stage of extreme shortening.

Other evidence that the duration of the stimulus modifies the character of the contraction is afforded by the following experiments: —

2. Make two cuts, 5 mm. apart, through the frog's stomach at right angles to the long axis. Hang the ring thus secured over a hook clamped in the muscle clamp. Pass a bent hook through the lower end of the ring, and attach it by means of a fine copper wire to the hook on the muscle lever. Carry the end of the copper wire to the binding post on the muscle lever.

Stimulate with single induction currents of a strength about the threshold value for skeletal muscle of frog.

There will be no contraction.

Stimulate with galvanic current (two dry cells), writing three curves, the duration of closure being approximately one-fifth second, one, and five seconds, respectively. Compare the curves.

The maximum shortening with currents of brief duration ( $\frac{1}{5}$  second) is very much less than

with currents of three or four seconds or over. The briefer the current also, the quicker will the maximum shortening be reached, and the quicker will be the relaxation.

3. If the galvanic current is very rapidly made and broken, the muscle will not contract.

The same is true of the ureter (Engelmann).

4. **Tonic Contraction.** — Examine the contraction curve already recorded by the smooth muscle of the frog's stomach. Note that the muscle remains contracted during the passage of the current. The curves secured from the curarized sartorius (page 100) also show this, but to a much less degree; the sartorius does not resume its former length after the twitch or closure of the galvanic current, but remains contracted to a slight extent. This tonic contraction appears much more plainly in fatigued muscles.

Fatigue a sartorius muscle by stimulating it with a galvanic current repeatedly made and broken. After a time, the twitch on closure will become very feeble, and finally will disappear, while the tonic shortening during the passage of the current is still very evident.

5. The influence of duration is shown also in the opening contraction.

Fasten the pelvic attachment of a sartorius

muscle in the muscle clamp and connect the other end with the upright pin of the muscle lever, so that the horizontal muscle shall record its contraction on a drum. Place the non-polarizable electrodes on the ends of the muscle. Allow the galvanic current from a dry cell to pass through the muscle until the closure tonic contraction has disappeared, then open the key. Neglect the opening twitch.

The muscle will not return to its original length, but will remain contracted for a time (opening tonic contraction).

Close the key again.

The tonic contraction will disappear.

The galvanic current in this case checks (inhibits) a contraction. This new action is discussed on page 114.

**6. Rhythmic Contraction.** — That the galvanic current acts as a stimulus so long as it continues to flow is shown also by the fact that its passage through contractile tissue may cause the muscle to fall into rhythmic contractions. These are easy to produce in muscles which normally contract in rhythms, for example, the heart; but they may under some circumstances be observed also in smooth muscle, and even in skeletal muscles.

Connect a dry cell through a simple key with

the metre posts of the rheocord. Join the non-polarizable electrodes to the positive post and the slider. Bring the slider against the positive post, so that no current shall flow through the electrodes when they are joined by the tissue.

Expose the heart. Divide the ventricle transversely near its base. Lay this "apex" preparation on a glass plate. Keep the tissue moistened with normal saline solution, but avoid excess. Bring the non-polarizable electrodes against the two sides of the preparation. Close the key. Move the slider along the wire.

When the current taken off reaches the threshold value, the apex will begin to beat rhythmically. Increasing the current strength will increase (within limits) the frequency of contraction.

*Skeletal Muscle.* — The curarized sartorius may sometimes be brought into rhythmic contraction by constant currents (Hering). If the irritability of the muscle at the point of stimulation be increased by applying to the cathodal region a two per cent solution of sodium carbonate, the constant current will produce strong rhythmic contractions.

Smoke a drum. Fasten the pelvic end of the sartorius in the muscle clamp, and attach the tibial end by a thread to the vertical pin on the

muscle lever so that the horizontally extended muscle may write its contraction on a drum. Lay on the tibial fifth of the muscle a piece of filter paper, wet with two per cent solution of sodium carbonate. Connect a dry cell through a simple key with the metre posts of the rheocord. Connect the non-polarizable electrodes with the positive post and the slider. Bring the slider near the positive post. When the sodium carbonate has acted for 15 minutes, bring the cathode against the tibial end, the anode against the pelvic end of the muscle. Close and open the circuit, moving the slider meanwhile to find the current which will give closing contraction. At this point keep the circuit closed.

Rhythmical contractions usually appear.

Periodic contractions are observed also in smooth muscle, stimulated with the constant current. Any form of constant stimulus will serve to produce them, pressure — as in the heart, bladder, and intestine — and chemical action, being especially noteworthy.

**Continuous Galvanic Stimulation of Nerve may cause the Periodic Discharge of Nerve Impulses.** — If two non-polarizable electrodes are allowed to rest on the muscle (horizontally suspended), and are connected to a capillary electrometer, the meniscus of which is projected through a slit

onto rapidly moving sensitized paper, the shadow of the meniscus will make a straight line on the photographic paper so long as the muscle is at rest. When, however, the nerve of the muscle is stimulated with the galvanic current and closing tetanus appears, the straight line will be broken by 10–15 oscillations per second. These oscillations are produced by the difference of potential created by each contraction wave as it passes over the muscle (contracting muscle is negative towards muscle at rest, see page 166), and demonstrate that the tetanus is a fusion of individual contractions produced by successive stimuli.

Hence, nerve, like muscle, responds to a continuous stimulus by a periodic discharge of energy.

*Ulnar Nerve.* — Connect 15 dry cells in series (zinc to carbon), and join the last zinc and carbon through a key to a small brass stimulating electrode one cm. in diameter, and a large “indifferent” electrode (brass plate  $6.5 \times 3.5$  cm. covered with cotton wet in solution of common salt). Hold the indifferent electrode in the left hand, and apply the stimulating electrode to the ulnar nerve at the elbow.

A peculiar tingling sensation will be felt so long as the current flows.

**Polarization Current.** — Let the sciatic nerve rest on a pair of non-polarizable electrodes in



the moist chamber. Connect the electrodes to the side cups of the pole-changer (without cross-wires). Connect one end pair of the pole-changer cups with a dry cell.

Turn the rocker to the opposite side, to prevent the battery current from reaching the electrodes until it is wanted. Connect the remaining pair

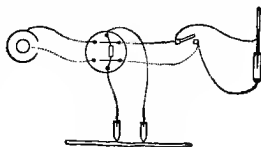

Fig. 29.

of cups through a closed short-circuiting key with the capillary electrometer. Let the galvanic current flow some minutes through the nerve, then turn the rocker towards the electrometer and open the short-circuiting key.

Note a movement of the meniscus in a direction indicating that the former cathode is now positive to the former anode. The nerve is polarized.

*Positive Variation.* — If the polarizing current is strong and brief, the negative polarization after-current will speedily give place to a positive current, *i. e.* one in the direction of the polarizing current. This positive current is really an action current. When the polarizing current is broken, the rise of irritability at the anode stimulates points nearer the anode more strongly than points farther away. Points nearer the anode become, therefore, negative to points farther away, and

a current flows through the electrometer circuit from the less negative to the more negative pole, and through the nerve in the direction from anode to cathode. This positive variation is seen only in living nerves.

**Polar Fatigue.** — Connect non-polarizable electrodes through a simple key with a dry cell. Arrange an inductorium for single induction currents (the pole-changer may be placed in the primary circuit as a simple key). Fatigue a sartorius muscle by opening and closing the galvanic circuit (leave a brief interval between opening and closure). Closure will at length be followed by no contraction. Test now the irritability of the muscle by stimulating it with induction currents.

The muscle will be irritable except in the cathodal region. The fatigue has been local (polar).

**Opening and Closing Tetanus** — 1. Arrange a moist chamber with a muscle lever to write on a smoked drum. Place two non-polarizable electrodes in the moist chamber and connect them through a pole-changer with a dry cell. Make a nerve-muscle preparation from a frog that has just been brought from a cold room into the warm laboratory. Secure the femur in the femur clamp of the moist chamber. Let the nerve rest on the non-polarizable electrodes. Attach the muscle

to the lever. Bring the writing point against the slowly moving drum. Close the key.

If the frog has been well cooled (below 10° C.), the muscle will fall into tetanus both on closing and on opening the circuit. Note that the curve is quite regular. If tetanus fails to appear, paint the cathodal region with one per cent solution of sodic carbonate, thus raising the irritability, and repeat the experiment. The curve secured in this way is likely to be irregular.

Produce opening tetanus, and while the muscle is contracting close the current again.

The tetanus will disappear; the irritability will be reduced in the anodal region, from the polarization of which the tetanus was produced.

Open the current again. When the tetanus reappears reverse the pole-changer and close the current.

The tetanus will be increased; the irritability in the former anodal region will suffer a catelectrotonic increase.

2. A beautiful demonstration of polar excitation may be made in this experiment. Connect the electrodes in such a way that the intrapolar current shall be descending (*i. e.* towards the muscle). When the opening tetanus appears, cut away the anode by severing the nerve between the electrodes.

The contraction ceases with the removal of the source of stimulation.

3. The stimulating effect of the salts of the alkalis has been explained by their attraction for water, the loss of which increases the effect of the galvanic current on nerve. When the irritability of the nerve is raised by drying, weak currents may give opening contractions, although they are absent in normal, uninjured nerves. The interval between the opening of the current and the resulting contraction is then markedly long. In nerves in the first stage of drying the intensity of the nerve impulse (height of contraction of attached muscle) is also more than usually dependent on the duration of the current.

4. The opening tetanus (so-called Ritter's tetanus) is probably caused by the rise of irritability, which takes place in the anodal region when the current is shut off, acting on a nerve already in latent excitation. A similar condition can be produced as follows:—

Smoke a drum. Connect a dry cell through an open key and an electromagnetic signal with the metre posts of the rheocord (Fig. 30). Connect the zero post and the slider of the rheocord with the pole-changer (with cross-wires), and the latter with two non-polarizable electrodes placed in the moist chamber. Make a nerve-muscle

preparation, and secure the femur in the femur clamp of the moist chamber. Attach the muscle to the muscle lever. Bring the writing points of the muscle lever and the electromagnetic signal against the smoked surface in the same vertical line. Let the nerve rest on the non-polarizable electrodes. In the remaining two posts in the moist chamber fasten stimulating electrodes. Connect the latter to the induc-

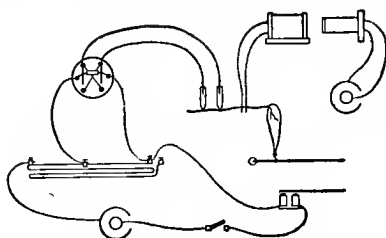

Fig. 30.

torium, arranged for tetanizing currents, short-circuiting key closed. Bring the stimulating electrodes against the nerve between the non-polarizable electrodes and the muscle. Let the secondary coil be at such a distance that the tetanizing current will be just below the threshold value. Turn the pole-changer so that the anode shall be next the tetanizing electrodes. Make and break the galvanic current, recording the contraction on a slowly moving drum. Now

open the short-circuiting key, and after half a minute, and while the sub-minimal tetanizing current is still passing through the nerve, make and break the galvanic current again.

A moderately strong galvanic current will now produce an opening tetanus (anodal stimulation of a region the irritability of which has been raised by the sub-minimal tetanizing current). Other effects are a lengthening of the latent period, and an increased dependence on the duration of the galvanic current (see page 100).

Reverse the pole-changer, so that the tetanizing electrodes fall in the cathodal region. Repeat the experiment, comparing the results of cathodal stimulation without and with the sub-minimal tetanizing current.

With sub-minimal tetanization, an increase in the height of the closing contraction, when the galvanic current is not too strong, will be seen; when the galvanic current is stronger, closing tetanus will also be observed.

**Polar Excitation in Injured Muscle.** — Smoke a drum. Make non-polarizable electrodes. Connect a dry cell through a simple key and pole-changer (with cross-wires) with the non-polarizable electrodes. Prepare a sartorius muscle with bony attachments. Fasten the pelvic end in the muscle clamp. Tie a thread to the tibial

end, and fasten the thread to the upright pin of the muscle lever, so that the muscle is extended horizontally. Bring the writing point against the drum. Light a Bunsen burner. Heat a wire, and kill the pelvic end of the muscle by laying the hot wire against it. Bring one non-polarizable electrode upon each end of the muscle. Arrange the pole-changer so that the cathode shall be at the pelvic end, and the current therefore "atterminal," *i. e.* directed toward the "thermal cross-section." Close the simple key.

No contraction, or a very slight contraction, will be seen.

Open the key. Reverse the pole-changer, so that the current shall be "abterminal." Close the simple key.

The ordinary closing contraction will be seen.

The great difference here shown between the polar excitability in the uninjured and injured region is probably due to chemical changes in the injured part. Similar results can be obtained by painting the end of the muscle with one per cent solution of acid potassium phosphate. The irritability is lessened by this salt but returns to normal if the altered end of the muscle is bathed in 0.6 per cent sodium chloride solution.

Sodium carbonate has an effect opposite to the potassium salts.

Wet the tibial end of the muscle with one per cent solution of sodic carbonate. After a short time, test the irritability to weak, ascending (*i. e.* cathode at pelvic end) currents.

The closure of ascending currents will give extraordinarily large contractions.

The cause of this change in irritability is not the presence of dead contractile tissue, for electrodes can be wrapped in dead muscle and used to stimulate normal muscle without loss of irritability being noticeable.

When the end of the fibre is killed, the pathological change passes gradually through the whole of the fibre.

#### POLAR INHIBITION BY THE GALVANIC CURRENT

It remains now to consider the inhibitory action of the galvanic current, to which attention was called on page 103.

**Heart.** — Connect a dry cell through a simple key and pole-changer (cross-wires) with the 0 and 1 metre posts of the rheocord. Connect non-polarizable electrodes with the slider and the positive post of the rheocord. Place the brainless frog, back down, in the holder (Fig. 31) and expose the heart, according to the method described on page 75. Open the delicate membrane (pericardium) which surrounds the heart. Let



one electrode rest on the larynx. Fasten the other in the muscle clamp, and bring it over the heart so that the tip of the brush rests on the ventricle and moves with it. Turn the pole-changer to make this electrode the anode. Make the current.

At each systole, the portion of the ventricle immediately about the anode will not contract with the rest, but will remain relaxed (local diastole). Thus while the greater part of the ventricle becomes pale as the blood is squeezed out of its wall by the contraction, the anodal region remains dark red.

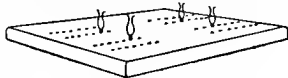

Fig. 31. The frog-board.

From this region the relaxation spreads over the rest of the ventricle. Reverse the pole-changer. Break the current.

The cardiac electrode is now the cathode. In the systole following the breaking of the current, the cathodal region will remain relaxed during contraction of the ventricle.

This experiment demonstrates that the galvanic current not only may stimulate, but may check or inhibit contraction. In the former case, the conversion of potential into active energy is set going; in the latter, it is prevented. Inhibition plays a large part in the physiology of the day.

**Polar Inhibition in Veratrinized Muscle.** — A similar inhibitory effect can be demonstrated in skeletal muscle previously placed in continued ("tonic") contraction by veratrine poisoning. Inject with a fine glass pipette seven drops of one per cent solution of veratrine acetate in the dorsal lymph sac of a frog.

Arrange two muscle levers to write on a drum. Between them place an electromagnetic signal. Let all three writing points be in the same vertical line. Connect a dry cell through a simple key with an inductorium arranged for single induction shocks. Connect non-polarizable electrodes through another simple key and the electromagnetic signal with a dry cell. Prepare a sartorius muscle with pelvic and tibial attachments. Fasten the muscle about the middle in the cork clamp. Fasten the cork clamp vertically in the jaws of the muscle clamp. Carry threads from each end of the muscle to one of the muscle levers. Place the non-polarizable electrodes near the respective ends of the muscle. Note which is the anode. Bring wires from the secondary coil of the inductorium to the ends of the muscle. Start the drum moving slowly. Stimulate the muscle with a single induction shock. There will be a prolonged contraction, characteristic of veratrine poisoning. So

soon as this contraction is well under way, make the constant current.

The anodal half of the muscle will show a distinct relaxation ; the cathodal half will not relax, but may even contract a little more.

#### STIMULATION AFFECTED BY THE FORM OF THE MUSCLE

Connect a dry cell through a simple key to the metre posts of the rheocord. Bring wires from the non-polarizable electrodes to the positive post and the slider, interposing the pole-changer with cross-wires so that the direction of the current can be changed. Place the slider against the positive post, so that all the current passes back to the cell.

Prepare a curarized sartorius muscle with its bony attachments. Fasten the pelvic fragment in the muscle clamp. Tie a thread about the tibia and fasten the thread to the upright pin of the muscle lever. Let the cathode rest on the tibial end of the muscle, the anode on the pelvic end ; the current will then be descending. Move the slider a few centimetres away from the positive post, and make the current. If no contraction follows, move the slider farther along, and make the current again.

With careful work, it will be shown that with

descending currents, the first contraction will be on closure only. With ascending currents, the first contraction will be on opening the current.

The explanation is that, with currents which pass through the sartorius from end to end the point of greatest density is the smaller, lower end. This is cathodal in descending currents, anodal in ascending currents.

#### EFFECT OF THE ANGLE AT WHICH THE CURRENT LINES CUT THE MUSCLE FIBRES

Connect non-polarizable electrodes through a key with a dry cell. Build on a glass plate with normal saline clay two parallel walls a little longer than the sartorius muscle and one centimetre apart. Join the ends with clay, to make a rectangular trough. Remove a sartorius muscle from a curarized frog, avoiding all injury to the muscle. Place the muscle in the trough, and cover it with normal saline solution. Bring a non-polarizable electrode against the centre of each long side, so that the current lines shall cut the muscle fibres at right angles. Close the key.

There will be no contraction. The muscle is inexcitable to currents that cross its fibres at right angles.

Alter the angle by moving one electrode to the right, the other to the left, and repeat the experiment.

The stimulating effect will increase as the angle between current lines and the long axis of muscular fibres diminishes.

Nerves also are inexcitable to transverse currents. Differences in resistance play a great part here. The resistance of nerves is said to be  $2\frac{1}{2}$  million times that of mercury, when the current passes along the nerve, and  $12\frac{1}{2}$  million times when it passes transversely.

### THE INDUCED CURRENT

The break induction current, owing to its rapid rise from zero to maximum intensity, is a more effective physiological stimulus than the make current, and may therefore be chosen for experimentation.

1. The direction of the induction current in the secondary coil is most easily determined electrolytically.

Arrange the inductorium for maximal currents. Bring wires from the posts on the secondary coil to a piece of filter paper wet with starch paste containing iodide of potassium. Exclude the make currents with the short-circuiting key ;

pass the maximal break currents through the electrolyte.

Iodine will be set free at the anode and will combine with the starch to form blue iodide of starch.

Mark the positive post on the secondary coil with a plus sign.

2. Connect the poles of the secondary coil through a pole-changer with non-polarizable electrodes. Make a nerve-muscle preparation. Tie a ligature about the nerve about two centimetres from the central end. Place one electrode on each side of the ligature. The passage of a nerve impulse from the central electrode to the muscle will be prevented by the ligature, although the electric current can still pass between the electrodes. Turn the pole-changer so that the electrode on the peripheral (muscle) side of the ligature shall be first the anode and then the cathode, and test the irritability to weak induction currents, beginning with the secondary coil some distance from the primary, and gradually increasing the intensity.

Only cathodal stimulation will produce contraction. The same result can be secured by separating the cathode and anode with ammonia. If the nerve is painted with ammonia in the intrapolar region, break currents cease to cause

contraction when the cathode is on the central side of the painted zone. Painting the cathodal region directly also prevents excitation.

The failure of the induction current to stimulate at the anode, on opening the current, is due to the exceedingly brief duration of the induced current; there is not time for a sufficient anelectrotonic alteration in excitability. If the current is shortened still more (if it be less than 0.0015 sec.), the cathodal excitation also disappears. With very strong currents, however, opening the current stimulates as well as closure.

3. Additional evidence of polar action is secured by connecting the electrodes with the capillary electrometer through a closed short-circuiting key. The meniscus is brought into the field, the nerve is stimulated repeatedly with maximal break currents, and then stimulation is stopped, and the short-circuiting key in the electrometer circuit opened. The meniscus will move in a direction indicating a higher potential at the anode (positive anodal polarization current).

4. Finally, it may be added that the galvanic current may increase the stimulating effect of the induced current as pointed out on page 80, but only when the cathode of the induced current falls in the cathodal region of the polarizing current.

The law of polar excitation holds good then for the induced as well as the galvanic current. In fact, there is no essential difference between the physiological effects of induced currents and very brief galvanic currents.

Increasing the intensity of the induced current increases at first the excitation (height of contraction). At length, however, with ascending currents, a point is reached beyond which further increase in strength is followed first by the diminution and at length by the disappearance of contraction. With still higher intensities, the contractions reappear. This *gap* in the contraction series is explained by the increasing depression of irritability at the anode blocking the cathodal impulse; when the intensity is still further increased, the opening of the current acts as a stimulus. A similar result may be secured with the galvanic current.

#### APPARATUS

Normal saline. Bowl. Pipette. Towel. Simple key. Non-polarizable electrodes. Nerve holder. Potter's clay mixed with 0.6 per cent solution of sodium chloride. Saturated solution of zinc sulphate. Muscle clamp. Stand. 13 wires. Kymograph. Glazed paper. Two muscle levers. Thread. Rheocord. Two dry cells. Moist chamber. Glass plate. Ice. Paraffin paper. Cork clamp. Pole-changer. Beaker. Tripod. Sodium chloride.



Inductorium. Electrodes. Bunsen burner. Intestine of a rabbit. Electromagnetic signal. Tuning fork. Brass electrodes. Fine copper wire. Frog board. 2 pairs of metal electrodes, each passed through cork. Electrometer. Paramecia. Microscope. Glass slide. Bent hooks. One per cent solution of veratrine acetate. Fine glass pipette. Filter paper saturated with starch paste containing potassium iodide. Frogs. Fine rubber tubing for insulating electrodes. Ammonia. One per cent solution of acid potassium phosphate. Two per cent solution of sodic carbonate. Ligatures. Filter paper.

## V

## CHEMICAL AND MECHANICAL STIMULATION

## CHEMICAL STIMULATION

THE contractility, heat production, and other phenomena of the life of muscle rest at base on chemical processes. Anything that sufficiently alters these processes may be a stimulus. A most important source of stimulation is the alteration of the chemical composition of muscle through osmosis.

**Effect of Distilled Water.** — Place a sartorius muscle in distilled water.

Irregular contractions usually occur. The muscle soon swells, and becomes white, turbid, cadaveric.

These striking changes depend on the withdrawal of certain bodies by osmosis. Muscle contains large quantities of proteid, particularly proteids of the globulin class; certain carbohydrates, such as glycogen; nitrogenous and other extractives; water; and a number of inorganic salts. Most of these bodies are largely or wholly insoluble in water, and require for their solution the presence of inorganic salts.

The globulins, for example, are insoluble in distilled water, but soluble in dilute solutions of sodium chloride. The osmosis of salts into the distilled water in the above experiment first stimulates and then destroys the contractility of the muscle.

An increase in the saline content of the muscle juice or "plasma" also acts as a stimulus, and, if excessive, may be fatal.

**Strong Saline Solutions.** — Place a sartorius muscle on a slightly inclined glass plate. Cover the lowest fourth of the muscle with crystals of sodium chloride.

Irregular contractions will appear.

**Drying.** — The effect of loss of water is best shown in nerve.

Let the nerve of a nerve-muscle preparation dry. Note the twitching of the muscle as the water content diminishes. Test the irritability of the nerve from time to time with induction currents. It will first increase, then disappear as the nerve dries.

Wet the nerve with 0.6 per cent sodium chloride solution.

The contractions will disappear.

To keep muscles and nerves in good condition for experimentation, it is necessary to moisten them with a solution containing the inorganic salts most abundant in the tissue-liquids in the

proportions in which they are present in those liquids. Practically, a 0.6 per cent solution of sodium chloride has commonly been employed, in the case of the frog. Such a solution is said to be isotonic, *i. e.* neither giving nor taking water from the tissue. That it is not perfectly indifferent appears from this experiment.

**“Normal Saline.”** — Allow a sartorius muscle to stand half an hour in normal saline solution (0.6 per cent NaCl). Record its contraction in response to a maximal break induction current. In place of a simple twitch a tetaniform contraction of abnormal height and duration will usually be secured.

**Importance of Calcium.** — Place the “normal saline” sartorius in 0.6 per cent sodium chloride solution containing 10 per cent of saturated solution of calcium sulphate. After 10 minutes record the maximal break contraction.

The abnormal tetaniform contraction will have disappeared.

**Constant Chemical Stimulation may cause Periodic Contraction.** — Place a sartorius muscle in a solution of 5 grams NaCl, 2 grams  $\text{Na}_2\text{HPO}_4$ , and 0.4 gram  $\text{Na}_2\text{CO}_3$  in one litre of distilled water.

Usually rhythmic contractions are seen. All contractile substance shows a tendency to periodic contractions in response to a constant stimu-

lus, whether chemical, mechanical, or electrical. There are reasons for believing that the rhythmical contractions of the heart are the consequence of a constant chemical stimulus.

### MECHANICAL STIMULATION

Stimulate a nerve mechanically by pinching the cut end with forceps.

No change will be seen in the nerve, but the muscle will shorten, and then relax.

Mechanical stimulation has the advantage that it can be localized accurately, and for this reason it has been used where electrical stimulation seemed inapplicable. Tetanomoters have been constructed by Heidenhain and others to give a rapid succession of slight blows upon the nerve.

Sudden pressure on a muscle or sudden extension may cause contraction. Sometimes the whole muscle contracts, sometimes only the portion directly stimulated.

**Idio-Muscular Contraction.** — With the point of the seeker stroke the diaphragm and other muscles of a recently killed rat, or other small warm-blooded animal, in a direction at right angles to the course of the fibres.

A wheal, *i. e.* a long-continued shortening and thickening of the fibre stimulated, will be seen. If the animal be not too long dead, a momentary

twitch of the whole of the fibre stimulated will precede the continued local contraction or wheel.

The same phenomenon is seen for a briefer time on sharp mechanical stimulation of muscles in living animals, for example, the wheals raised by the blow of a whip. In men long ill of wasting diseases, *e. g.* phthisis, the idio-muscular contractions appear on drawing a pencil point across the muscles. Direct total stimulation of frog's muscle, especially in the spring months, may be followed by long continued contraction. Fatigue, cold, and many poisons, such as veratrine, favor the prolongation of the phase of shortening. The idio-muscular contraction is not a "tetanus," *i. e.* not a prolonged shortening due to successive contractions, the interval between which is too short to permit of relaxation, but a prolonged single contraction, the cause of which lies in the muscle and not in the nerve.

#### APPARATUS

Normal saline. Bowl. Pipette. Towel. Glass plate. Distilled water. Sodium chloride. Solution of sodium chloride (0.6 per cent), containing 10 per cent of saturated solution of calcium sulphate. Solution containing 5 grams sodium chloride, 2 grams di-sodium hydrogen phosphate, and 0.4 gram sodium carbonate, in 1000 c.c. water. Small warm-blooded animal recently killed. Introduction coil. Dry cell. Key. Electrodes. 3 Wires. Frogs.

## VI

## IRRITABILITY AND CONDUCTIVITY

IRRITABILITY is the power of discharging energy on stimulation. The form in which the kinetic energy of muscle appears is partly mechanical work (the visible contraction) and partly molecular, — heat, chemical action, and electricity. In the nerve, the kinetic energy is wholly molecular; an electromotive force is generated, probably heat is set free (though this statement — which is based simply on analogy — is frequently disputed), and a molecular change — the nerve impulse — arises at the seat of stimulation. In both muscle and nerve, by virtue of their conductivity, the change induced by stimulation is as a rule not limited to the region stimulated, but passes in both directions along each stimulated fibre. In neither muscle nor nerve can the changes in energy spread transversely; they are limited to the muscle- or nerve-fibre in which they arise.

It will be shown that conductivity and irritability are essentially different functions.

**The Independent Irritability of Muscle.** — The stimulus that causes the contraction of a muscle may be applied either to the nerve or to the muscle itself. If to the nerve, the muscle will be thrown into the active state not by the original stimulus, but by a nerve impulse. If to the muscle, the nerve will still be stimulated, for examination shows terminal fibres distributed, in skeletal muscle at least, probably to every fibre, and with few exceptions to all parts of the muscle. The fact that muscles may contract when an electric current flows through them, or when otherwise stimulated, does not therefore of itself indicate that electricity is a stimulus to muscle protoplasm. Before this can be established, it will be necessary to demonstrate contraction in parts of muscle not provided with nerves; for example, the distal part of the sartorius, or in muscles in which the nerves have been destroyed by curare or by degeneration.

*Nerve-free Muscle.* — Remove the sartorius muscle, together with the portion of the pelvis and the tibia to which the muscle is attached, and lay it on a glass plate. Stimulate the distal (tibial) fifth, in which examination with the microscope would show the absence of nerve fibres, with a strong break induction current.

The nerve-free muscle will contract.



*Muscle with Nerves Degenerated.* — A nerve fibre severed from its cell of origin dies or “degenerates” down to its ultimate endings. Expose the sciatic nerve in the middle of the thigh of a frog in which the nerve has been severed near the pelvis ten days before, so that the whole of the nerve distal to the section shall have degenerated. Stimulate the degenerated trunk.

No contraction is seen in the muscles of the leg. Stimulate the muscles directly.

Contraction takes place.

*The Nerve-free Embryo Heart.* — Embryological studies show that the nerves of the heart are formed from epiblast in the walls of the neural canal, and do not grow into the heart until the close of the third day of incubation (chick). The heart, however, begins to beat during the second day of embryonic life, before even the blood which it shall pump is formed. Thus the heart muscle, in the embryo, is capable of contraction in the absence of nerves.

Cover an egg which has been incubated 60–70 hours with 0.75 per cent solution of sodium chloride warmed to 38° C. Remove the shell with the forceps over one third of the egg, beginning at the broad end, and leaving the shell membrane behind. Now remove the shell membrane. Note the beating heart.

*Paralysis of Nerve Endings with Curare.* — Destroy the brain with the seeker as follows, avoiding all unnecessary injury : Wrap the frog in the cloth, head out. Hold the frog with the fingers of the left hand, pressing down the tip of the frog's nose with the left thumb. Pass the right forefinger along the middle line of the head. A slight depression will be felt at the joining of the skull and trunk. Here the cerebro-spinal canal has no bony covering. Make at this point a cut about a centimetre ( $\frac{2}{5}$  inch) long through the skin in the middle line. Thrust the seeker vertically through the soft tissues until the point is stopped by the bony vertebræ. Turn the point of the seeker towards the head, and push it along the brain cavity, moving it slightly from side to side. Expose the sciatic nerve in the thigh of one side, *e. g.* the left, making a small slit through the skin in the upper part of the thigh over the course of the nerve, and taking the greatest care not to injure the femoral artery and vein. Pass a stout ligature beneath the nerve and around the thigh, as near the trunk as possible, and tie it firmly with a square knot. A piece of filter paper, wet with normal saline solution, should be kept on the nerve where it crosses the ligature. The left hind limb below the ligature is thus excluded from the circula-

tion. With a fine glass pipette inject a few drops of a one per cent solution of curare through a very small hole made in the skin of the back into the dorsal lymph sac. Test the reflexes at intervals of a few minutes by stimulating the skin of the feet with tetanizing currents.

At an early stage in the action of the poison, the right leg will no longer be drawn up when the feet are stimulated, although the left leg, from which the poison is excluded by the ligation of the blood-vessels, still responds by reflex contractions, not only to stimulation of its own foot, but also to strong stimulation of the other leg. The afferent (sensory) nerves, the spinal reflex mechanisms, and that part of the efferent nerves which lies above the level of the ligature are, therefore, still functional. The reflex power is lost on the right side, because either the trunk of the nerve, its eud-organ, or the muscle, has been paralyzed

When all reflexes have ceased, except in the ligatured limb, lay bare the sciatic nerves from the vertebral column to the knee. Stimulate the right nerve with the interrupted induction current.

There will be no contraction.

Stimulate the left nerve above the ligature, *i. e.* in the region supplied with poisoned blood.

Contraction follows. The trunk of this (left) nerve is still functional, although supplied with the poisoned blood. Consequently the failure to obtain contraction on stimulating the right nerve cannot be due to the poisoning of the trunk of that nerve. The curare must then have paralyzed either the muscle or the endings of the nerve in the muscle.

Stimulate the right gastrocnemius muscle.

It contracts. This muscle was supplied with curare blood.

The curare has therefore paralyzed the end-organ of the motor nerve, probably the end-plates, the muscle and the nerve-trunk remaining functional. It follows that muscles can be made to contract without the agency of nerves. The occurrence of idio-muscular contraction (see page 127) is an additional proof of the independent irritability of muscle.

**Irritability and Conductivity are Separate Properties of Nerve.** — 1. *Carbon-dioxide.* — Arrange the inductorium for tetanizing currents. Connect the secondary coil with the main posts of the pole-changer (cross-wires out). Connect the two other pairs of posts with the usual stimulation electrodes and the electrodes of the small gas chamber (Fig. 32). Join the inflow tube of the gas chamber with the outflow tube of the

carbon-dioxide bottle. The gas chamber should rest on a glass plate. Make a nerve-muscle preparation, preserving the full length of the sciatic nerve up to the vertebral column. Tie a silk thread to the extreme end of the nerve, and fasten the thread to the end of the seeker by a drop of wax cement. With the aid of the seeker, pass the thread through the holes, and

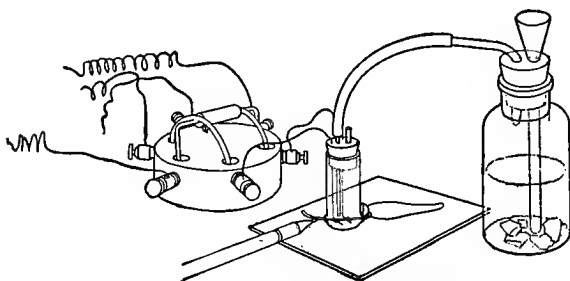

Fig. 32. The gas chamber, with bottle for generating carbon dioxide, and a pole-changer arranged to stimulate the nerve either within or without the chamber. The holes in the glass through which the nerve passes are plugged with normal saline clay.

draw the nerve after, so that the nerve lies on the electrodes. The nerve should be drawn through until the muscle is close to the gas chamber. Stop up the holes through which the nerve passes with normal saline clay. Bring the outer pair of electrodes against the central end of the nerve near its exit from the gas chamber. Determine which position of the pole-changer

corresponds to each pair of electrodes. Stimulate the nerve first within the chamber, and then on the central side of the chamber, using a current just sufficient to cause tetanus. In both cases tetanus will result. Now pour 20 per cent hydrochloric acid onto the marble in the generator. After the gas has passed through the chamber for some time, stimulate as before.

Stimulation of the portion of the nerve exposed to the carbon-dioxide is no longer effective, while stimulation of the part central to the gas chamber still produces tetanus.

But the nerve impulses created by stimulation of the nerve central to the gas chamber cannot reach the muscle except by passing along the nerve and through the carbon-dioxide. The conductivity of the nerve therefore is still sufficient, while the irritability has been suspended by the action of the gas. Hence, conductivity and irritability are by no means interchangeable terms.

Their essential difference is further shown by the effect of alcohol vapor, which impairs conductivity while irritability is little changed.

2. *Alcohol.* — Disconnect the rubber tube from the gas generator, and blow through the gas chamber until the carbon-dioxide is driven out. The nerve will recover its irritability. Determine this by stimulating from time to time.

When the nerve has recovered, drop a little alcohol through the long glass tube of the gas chamber, being careful that only the vapor of the alcohol comes into contact with the nerve. Stimulate both within and central to the chamber.

After a time, tetanus will no longer be produced by stimulating central to the chamber. Stimulation within the latter is still effective. Thus conductivity is impaired, while irritability remains intact, or at least is affected to a less extent. (The electrodes within the alcohol atmosphere should not be too far from the opening through which the nerve passes to the muscle, else the loss of conductivity in this part of the nerve may make difficult the demonstration of irritability.)

**Minimal and Maximal Stimuli ; Threshold Value.**

— Arrange the gastrocnemius muscle to write on a smoked drum. Connect one binding post of the secondary coil to the muscle clamp, the other binding post to the post on the muscle lever. Load the muscle with 10 grams. Describe an abscissa on the smoked paper, turning the drum by hand. Send a feeble break induction current through the muscle.

There will be no response.

Repeat the break currents, gradually moving the secondary closer to the primary coil.

At a certain point the muscle will just contract ("threshold value"). This is a minimal contraction produced by a minimal stimulation.

Turn the drum 5 mm., move the secondary coil 5 mm. nearer the primary, send in another break current, and record the contraction. Continue this.

The contraction in answer to each break current increases with the strength of the currents at first rapidly, then slowly, up to a certain point. Further increase in the strength of the stimulus produces no further increase of contraction. The stimulus and the resulting contraction have now become maximal.

There is a striking disproportion between the energy of the stimulus necessary to throw a nerve or muscle into the active state, and the energy that the stimulus sets free. It is as if a spark fell into powder; the active process is to be regarded, with some reservations, as an explosion. But only a part of the latent energy of muscle can be set free by any one stimulus.

*Threshold Value Independent of Load.* — Repeat the preceding experiment, and load the muscle with 50 grams instead of 10.

The threshold value will not be changed.

**Summation of Inadequate Single Stimuli.** — Place the secondary coil of the inductorium at



such a distance from the primary that a break current shall be nearly, but not quite sufficient to cause a contraction. Let the muscle rest without stimulation for about a minute. Repeat the inadequate single stimulation at intervals of five seconds. No curve need be written.

After a time, contraction will be secured.

The excitation outlasts the stimulus, and reinforces subsequent stimuli: finally, the summed excitations call forth a contraction. Summation is of frequent occurrence probably in all living tissues.

**Relative Excitability of Flexor and Extensor Nerve Fibres; Ritter-Rollett Phenomenon.** — Expose the sciatic nerve in a brainless frog in the pelvic region. Set the hammer of the inductorium in action (binding posts 2 and 3), and stimulate the nerve with weak induction currents.

The leg will be flexed.

Use stronger induction shocks.

As the intensity increases extension as well as flexion is seen. A still further increase causes extension only.

The gradations of intensity necessary to show these results are sometimes difficult to secure. The phenomenon of relative excitability is not limited to the case just cited. Weak stimulation of

the vagus causes adduction of the vocal bands ; stronger stimulation, abduction. Weak stimulation causes opening of the claw of the lobster, while stronger stimulation of the same nerve causes closure. Weak stimulation of the hypoglossal nerve in the dog and rabbit causes the tongue to be thrust from the mouth, while with strong stimulation the tongue is withdrawn into the mouth. It must not be forgotten that the anatomical nerves stimulated in these experiments are composed of many axis cylinders, each of which is a physiological nerve. That they should vary in excitability is to be expected.

A second and probably better explanation of the Ritter-Rollett phenomena is found in the difference in structure of the flexors and extensors. Muscle fibres consist of contractile substance imbedded in sarcoplasm. The relation between the contractile substance differs in the same muscle in different species and individuals, and differs further in the muscles of the same individual. In striated muscles of vertebrates, those rich in sarcoplasm have a turbid, opaque appearance, while those poor in sarcoplasm are translucent. Important differences in contractility, irritability, etc., depend on this difference of structure. Muscles which contain many "clear" fibres (poor in sarcoplasm) are more irritable

than those containing many of the fibres rich in sarcoplasm. In the flexors of the frog the "clear" fibres are relatively more numerous than in the extensors.

**Specific Irritability of Nerve Greater than that of Muscle.** — Arrange an inductorium for single induction currents. Make as rapidly as possible two nerve-muscle preparations, A and B. Bring a wire from the secondary coil to each end of muscle A. Let the nerve of B rest on muscle A. No stimulation can now reach B except through that part of the nerve of B which rests on muscle A. Place the secondary some distance from the primary coil. Stimulate muscle A with make induction shocks, the strength of which is gradually increased by approximating the coils.

Muscle B, which is stimulated only through its nerve, will contract before muscle A, which is stimulated directly. Hence, the specific irritability of nerve is greater than that of muscle, provided (1) that the intensity of the stimulating current is equal for both nerve and muscle, and (2) that the irritability of the two muscles does not differ, and (3) that the stimulation of the nerve of B is not by unipolar induction. The first source of error may be excluded, because the density of the current passing through the portion of nerve lying on muscle A is certainly not

greater than the density of the current passing through the muscle itself. The second possibility is tested as follows:—

Reverse the muscles and repeat the experiment.

The result will not be altered.

The third source of error is excluded as follows.

Tie a ligature about the nerve of B, between muscles A and B. The physiological conductivity of nerve B is thereby destroyed, and the nerve impulse cannot pass; but the physical continuity of the nerve, and hence its power to conduct electricity, is still present.

The strongest induction currents applied to muscle A will now fail to produce contraction of B.

**Irritability at Different Points of Same Nerve.** — Determine the threshold value for the sciatic nerve near the gastrocnemius muscle and about two centimetres from the cut end of the nerve.

The farther from the muscle the nerve is stimulated, the lower will be the threshold value. It has been suggested in explanation of this that the nerve impulse gathers force as it passes along the nerve, and is the more powerful the longer the nerve which it traverses (avalanche theory). It has also been suggested that the nearer to the nutrient cell of origin the stim-

ulus is applied, the greater the effect. The true explanation lies in the fact that the irritability of the nerve is raised in the neighborhood of the cross-section by the passage of the demarcation current through that portion, as explained on page 160. Tigerstedt has shown with mechanical stimuli that the uninjured nerve has equal irritability throughout.

**The Excitation Wave remains in the Muscle or Nerve Fibre in which it starts.** — In order to limit the stimulus to one or two fibres, the method of unipolar stimulation may be adopted.

Fasten in one post of the secondary coil of the inductorium arranged for tetanizing currents a wire soldered to a blunt needle. The needle, except near the free end, and the lower part of the connecting wire, should be inclosed in a glass tube for insulation.

Expose the sacral plexus in a brainless frog in which the skin has been removed from the hind limbs. Connect the preparation by means of a copper wire with the earth through the gas or water pipes.

Touch the sacral nerves here and there with the needle electrode, watching meanwhile the sartorius muscle.

Partial contractions will be seen in the sartorius, now of the inner, now the outer fibres,

according to the nerve fibres touched by the needle.

Stimulate the sartorius directly.

Only the fibres touched by the needle contract.

Evidently the excitation wave remains limited both in the muscle and the nerve to the fibres in which it starts.

**The Same Nerve Fibre may conduct Impulses both Centripetally and Centrifugally.** — 1. The



Fig. 33. The sartorius.

nerve of the sartorius divides at the muscle, part going to each half of the muscle (Fig. 33). Microscopical examination shows that the division is not simply a parting of individual nerve fibres, but that each axis cylinder forks, one limb going upwards, the other downwards. If the muscle be severed between the forks, no impulse started in one half of the muscle could reach the other half, except by going up one branch to the original axis cylinder and down the remaining branch; for it is known that the nerve impulse does not escape transversely from one axis cylinder to other neighboring ones.

Remove a sartorius muscle with great care. Split the muscle in the middle line for one third of its length, beginning at the broad end, as indicated in the diagram. Stimulate the muscle

fibres of the right segment mechanically, by snipping the preparation with scissors in the line *a*. Do not cut quite through the segment.

Only the right half twitches.

Repeat the stimulus by snipping in the line *a*<sub>1</sub>

Again only the right half twitches.

Stimulate in the line *b*.

Both segments twitch, or at least some fibres in each.

Repeat at *b*<sub>1</sub>.

Both segments twitch again.

2. The gracilis of the frog is divided into an upper, shorter part and a lower, longer part by a tendon (Fig. 34, *j*). Each axis cylinder in the nerve *N*, on approaching the muscle, divides into two branches, one of which goes to the upper and the other to the lower portion of the muscle.

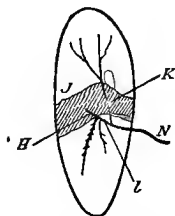

Fig. 34. The gracilis.

Remove the muscle together with a portion of its attached nerve, and examine the inner surface (Fig. 14). The nerve (*N*) divides into two branches, of which the upper (*K*) runs to the shorter portion of the muscle and is unbranched for some distance, while the other (*L*) has a very short stem and sinks almost at once into the substance of

the lower part. One of the branches (*H*) perforates the muscle and goes to the skin.

With a sharp pair of scissors cut out entirely the part shaded in the diagram, without injuring the nerves. The halves of the muscle are now united only by the forked nerve.

Stimulate the end branches of the nerve in one of the pieces of muscle by snipping with scissors; also chemically, with a lump of salt.

Both pieces will contract.

**Speed of Nerve Impulse.** — Smoke a drum, and adjust it for “spinning.” Place two pairs of non-

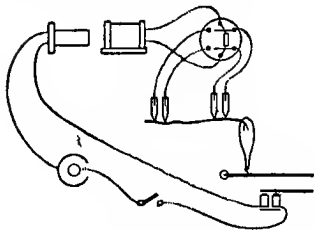

Fig. 35.

polarizable electrodes in the moist chamber. Arrange the inductorium for maximal make currents, placing a simple key and the electromagnetic signal in the primary

circuit (Fig. 35). Connect the secondary coil to the side cups of the pole-changer. Connect the end pairs of cups each with one pair of the electrodes in the moist chamber. Make a nerve-muscle preparation, preserving the full length of the sciatic nerve. Fasten the femur in the clamp in the moist chamber. Connect



the Achilles tendon to the muscle lever. Bring the point of the lever against the drum immediately over the writing point of the electromagnetic signal. Let the nerve rest on the electrodes, one pair near the end of the nerve, the other near the muscle. Spin the drum slowly. Hold the writing point of a vibrating tuning fork against the smoked paper beneath the line drawn by the signal. Send a maximal induction current through first one pair of electrodes and then the other. Determine the interval between the moment of stimulation and the beginning of contraction in each instance. [This is done by turning the drum back until the writing point of the signal lies precisely in the vertical line marked by it when the current was made, and then stimulating the muscle to contract. The ordinate drawn by the muscle lever (the drum being still at rest) will be synchronous with the ordinate drawn by the signal during the experiment.]

It will be found that the interval between stimulation and contraction is greater when the nerve is stimulated far from the muscle than it is on stimulation near the muscle. The difference is the time occupied by the passage of the excitation wave along the nerve between the electrodes.

Measure the length of nerve between the electrodes, and calculate the speed of the nerve impulse per second.

It is assumed in this method that the interval between the closure of the primary circuit and the beginning of the nerve impulse is the same in both instances, and that the interval between the arrival of the impulse in the muscle, and the visible change of form, is likewise the same in both. If the mean and the probable deviation of a series of measurements are taken, a fairly accurate result may be expected. A better method, however, is to record the passage of the negative variation over a measured length of nerve by photographing the meniscus of the capillary electrometer. Similar measurements can be made with a differential rheotome (page 176).

Helmholtz found in motor nerves of the frog an average speed of 27 metres per second, but the individual variation is considerable. The speed is very slow compared with that of light, or even sound. It is modified by changes in temperature, nutrition, anæsthetics (alcohol, ether, chloroform, carbon dioxide), the intensity of the stimulus, — above a certain value, the greater the stimulus, the more rapid the conduction, — and by many other factors. Specific differences are found depending on the structure of the

nerve. Thus the velocity has been found in mammalian nerve to smooth muscle to be about 9 metres per second, while in the bivalve Anodonta, it is said to be only 1 centimetre per second.

#### APPARATUS

Normal saline. Bowl. Towel. Pipette. Glass plate. Dry cell. Inductorium. Key. Wires. Frog with sciatic nerve degenerated. Hen's egg incubated 60-70 hours. NaCl solution (0.75%). Ligatures. Filter paper. One per cent solution of curare. Pole-changer. Gas chamber. Carbon dioxide generator. Twenty per cent hydrochloric acid. Broken marble. Alcohol. Muscle clamp. Stand. Muscle lever with scale pan. Millimetre rule. Five to ten gram weights. Needle electrodes (glass tube). Moist chamber. Two pairs of non-polarizable electrodes. Electromagnetic signal. Recording drum. Glazed paper. Tuning fork. Normal saline clay.

## VII

THE ELECTROMOTIVE PHENOMENA OF  
MUSCLE AND NERVE

THE stored energy of muscle is set free in molecular movement, — heat, chemical action, and electricity, — and in mechanical work, the change in form. It will be convenient to consider the electromotive phenomena first.

## THE DEMARCATION CURRENT OF MUSCLE

**Demarcation Current of Muscle.** — 1. Make two non-polarizable electrodes. Connect them to the capillary electrometer through a short-circuiting key. Remove a sartorius muscle. Cut off each end with a sharp knife by a clean cut at right angles to the fibres. Observe that the muscle is thereby converted into a "muscle prism." It possesses two artificial cross-sections, at each of which the muscle has been injured, and is, in fact, dying, and an uninjured natural longitudinal surface. Place one of the non-polarizable electrodes against a cross-section and the

other on the middle of the uninjured longitudinal surface. Bring the meniscus of the capillary into the field. Note its position on the micrometer scale. Open the key.

The meniscus will be displaced in the direction indicating a higher potential at the middle or "equator" of the longitudinal surface than at the cross-section. State the difference of potential in fractions of a volt. (The electrometer was calibrated in a previous experiment, page 28).

2. Move the electrode on the longitudinal surface a few millimetres towards the cross-section. Determine the difference of potential here. It will be less than before. Measure the potential in similar manner at intervals of 5 mm. between this point and the cross-section. On co-ordinate paper set down on the abscissa the number of millimetres from equator to cross-section. Set down as ordinates the number of divisions of the micrometer scale traversed by the meniscus when the electrode on the longitudinal surface is placed successively on the equator, and at intervals of 5 mm. between equator and cross-section. Draw the curve uniting the summits of the ordinates.

As the cross-section is approached, the curve of potential will fall more and more rapidly. The centre of the cross-section is negative towards the outer parts of the section. Points on the

equator, or equidistant from it, have the same potential. Points on the longitudinal surface at different distances from the equator, and on the cross-section at different distances from the centre of the section, show a slight difference of potential.

Prove these several statements.

*Oblique Section.* — When the artificial cross-section is oblique to the long axis of the muscle, the maximum difference of potential is no longer at the equator and the centre of the cross-section. The most positive point is on the longitudinal surface near the obtuse angle made by the oblique section, and the most negative point is on the cross-section near the acute angle. The structure of certain muscles, the frog's gastrocnemius, for example, is such as to make their natural cross-section oblique. In consequence, their differences of potential are not distributed as in a regular parallel-fibred muscle like the sartorius. In the gastrocnemius, owing to the peculiar insertion of the muscle fibres into the tendon, the upper end of the muscle is really the middle of the longitudinal section, while the lower end is the acute angle of an oblique cross-section. When the ends are connected with an electrometer, a strong current is observed flowing (outside the muscle) from the upper to the lower end.

*Uninjured Muscle.* — Prepare a sartorius muscle with extreme care to prevent injury. Connect the tendon (the natural “cross-section”) and the longitudinal surface with the electrometer through a short-circuiting key. Note the position of the meniscus on the micrometer scale. Open the short-circuiting key.

The meniscus will move but little. It will not move at all, provided the muscle has not been injured; but the difficulty of preparation is such that some difference of potential will probably appear.

Close the key. Injure the muscle by drawing a hot wire across one end. Open the key.

A strong demarcation current will appear.

**Stimulation by Demarcation Current.** — 1. Make a nerve-muscle preparation (sciatic nerve and gastrocnemius muscle). Let the nerve near the muscle touch a cross-section of the sartorius. Now let the end of the nerve fall on the longitudinal surface near the equator.

The gastrocnemius will contract; the nerve acts as a conductor between the positive longitudinal surface and the negative cross-section.

It should be pointed out that the conclusion here drawn is not entirely free from criticism. The muscle is a conductor as well as the nerve, and may close the demarcation current of the

nerve, as the nerve may close that of the muscle. Thus it is possible that the nerve is stimulated by its own demarcation current. The former explanation is the more probable.

2. Place non-polarizable electrodes on the longitudinal surface and cross-section of the sartorius. Fasten the wires of the stimulating electrodes in the binding posts of the non-polarizable electrodes. Drop the nerve of the nerve-muscle preparation across the electrode points.

The gastrocnemius will contract when the nerve bridges the space from one electrode to the other, and thus completes the circuit between the longitudinal surface and cross-section of the sartorius.

3. Place a little 0.6 per cent solution of sodium chloride in a porcelain dish. Fasten one end of the sartorius gently between two pieces of cork in the jaws of the muscle clamp. Bring the muscle over the saline solution. Make a fresh clean cross-section, and lower the clamp on its stand until the cross-section dips (not too far) into the solution.

The muscle will twitch. The twitch will pull the end of the muscle out of the solution. When the muscle relaxes, the contact between positive longitudinal surface and negative cross-section is once more made by the saline solution, the



current of rest flows from the point of higher to the point of lower potential, and again stimulates the muscular tissue through which it passes. Thus the muscle is stimulated by its own current. A long series of contractions may be secured. Other liquid conductors will serve. When the solution touches only the cross-section, there is no contraction.

4. Prepare a fresh sartorius muscle with bony attachments. Fasten the pelvic end in the muscle clamp. Make a fresh cross-section in the first sartorius. Hold the tibial end of the second muscle in such a way that the muscle lies horizontally with its upper surface somewhat concave. Against this surface bring the fresh cross-section of the first sartorius. The longitudinal surface will naturally also touch to some extent.

The second muscle will close the circuit between longitudinal surface and cross-section of the first, and, if very irritable, both muscles will contract.

**Interference between the Demarcation Current and a Stimulating Current ; Polar Refusal.** — Connect a dry cell through an open key with the 0 and 1 metre posts of the rheocord (Fig. 36). Make two non-polarizable electrodes, and connect them through a pole-changer (with cross-

wires) to the positive post and slider of the rheocord. Tie a thick cotton thread to the brush of the positive electrode in such a way that the thread shall hang down in a small loop. Let a sartorius muscle rest on a clean glass plate. Make an artificial cross-section by drawing a hot wire across the muscle near the pelvic end. Pass the loop of thread on the positive electrode over the muscle about 5 mm. from the

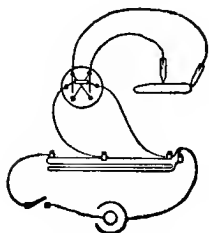

Fig. 36.

thermal cross-section. Let the negative electrode rest on the cross section. Arrange the rheocord for weak currents. Moisten the electrodes with normal saline solution. Close the key.

The usual closing contraction will be absent (polar refusal).

Note that the galvanic current is now passing through the muscle in an atterminal direction, *i. e.* towards the injured portion (admortal), while the demarcation current is passing through the muscle in the opposite direction. The two currents more or less compensate each other. Hence, the absence of the closing contraction. Observe, also, that opening the key will break the galvanic circuit, but that the circuit for the demarcation current will still be closed — through non-polarizable electrodes and rheocord.

Open the key.

An opening contraction will take place, obviously because the muscle current is no longer compensated.

Reverse the pole-changer, so that the anode lies at the cross-section. Open and close the galvanic current.

Contraction will take place at closure only. The electrode at the cross-section again refuses.

**Measurement of Electromotive Force of Demarcation Current.** — 1. Prepare a sartorius muscle, and make an artificial cross-section near the pelvic end. Lay one non-polarizable electrode on the cross-section, the other on the equator. Connect the electrodes to the capillary electrometer through a short-circuiting key in such a way that the capillary shall be joined to the electrode which rests on the cross-section of the muscle. Bring the meniscus into the field. Note the position of the meniscus on the micrometer scale. Note also the height of the mercury in the manometer. Open the key. When the meniscus has come to rest, restore it to its original position by turning the pressure screw. Read the manometer again, and note the pressure used in millimetres of mercury. Translate this into fractions of a volt by means of the graduation scale of the electrometer (page 29). It has already been pointed out

that in the capillary electrometer the relation between the pressure and the potential must frequently be re-determined. In striated frog muscle the electromotive force of the current of rest is from about 0.035 to 0.090 volt.

2. *Compensation Method.* — The electromotive force of a current of injury may be expressed in fractions of a Daniell cell, or any other constant element, by bringing into the same circuit with the

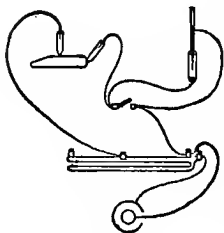

Fig. 37.

current of injury, but in an opposite direction, so much of the current from the cell as will exactly balance the current of injury, *i. e.* so much as will keep the meniscus of the electrometer from moving in either a positive or negative direction when connected with the circuit.

Prepare a sartorius muscle. Connect a Daniell cell with the 0 and 10 metre posts of the rheocord. Connect the capillary electrometer to a closed short-circuiting key. From the post joined to the capillary lead to the 0 post of the rheocord. Connect the remaining post of the key to a non-polarizable electrode placed on the cross-section of the muscle. Join the slider of the rheocord to another non-polarizable electrode placed on the

equator of the muscle (Fig. 37). Bring the slider to the zero post. Bring the meniscus into the field. Note its position on the micrometer scale. Open the short-circuiting key. When the meniscus comes to rest, move the slider along the rheocord until the meniscus returns to its original position. Read the number of millimetres between the positive post and the slider. This number divided by 10,000 is the fraction of the electromotive force of the Daniell cell (1.1 volt) necessary to balance the current of injury of the muscle.

#### DEMARCATION CURRENT OF NERVE

Place non-polarizable electrodes on the cross-section and longitudinal surface of a long piece of sciatic nerve. Connect the electrodes through a short-circuiting key with the electrometer. Bring the meniscus into the field and open the short-circuiting key.

The meniscus will move in a direction indicating a current in the nerve from cross-section to longitudinal surface, as in muscle.

Measure the electromotive force of this demarcation current (1) directly by means of the electrometer, (2) by the compensation method, as described above.

The demarcation current is much weaker in nerve than in muscle, being in the former about

0.025 volt, as against about 0.060 volt in muscle. The demarcation current of muscle is maintained in force for a long time, whereas that of nerve diminishes rapidly. The nerve current is restored on making a fresh cross-section.

The demarcation current from the cut branches of a nerve may reach electrodes placed on the main trunk, and thus confuse the electrometer measurements. To this same cause must be ascribed the increased irritability observed in the main trunk in the neighborhood of branches; the irritability is raised by the demarcation current of the severed branch.

**Nerve may be stimulated by its own Demarcation Current.** — On a glass plate make a U shaped wall of normal saline clay, each limb about 1 cm. long and 3 or 4 mm. wide. Carefully remove the moisture between the clay walls with filter paper. Lay the longitudinal surface of the nerve of a nerve-muscle preparation on one limb of the U, and with a glass rod let the cross-section fall on the other limb.

When the circuit between the cross-section and the longitudinal surface is completed by contact with the clay, the demarcation current will stimulate the nerve, and the resulting nerve impulse will cause the muscle to contract.

*Other Examples.* — The dropping of the central end of the severed vagus nerve into the wound from which it was lifted has caused the slowing

of respiration, presumably by the stimulation of the nerve through the closure of its own demarcation current by the lymph or blood, though the possible influence of demarcation currents from the wounded tissues cannot be forgotten. Definite results, such as inhibition of the heart, have not been observed to follow the closure of the current of the peripheral segment. To avoid any chance stimulation from the closure of the demarcation current, nerves are sometimes severed physiologically by freezing, — a process which not only does not stimulate, but which does not destroy permanently the conductivity; the latter returns upon the restoration of the nerve to normal temperature.

The olfactory nerve of the pike shows a strong demarcation current, as does the optic nerve.

#### HYPOTHESES REGARDING THE CAUSATION OF THE DEMARCATION CURRENT

Make artificial cross-sections in a sartorius muscle, and test the difference of potential between the longitudinal surface and a cross-section with the electrometer. Divide the muscle, longitudinally, and make fresh cross-sections; test the difference of potential again.

However small the muscle prism may be

made, the longitudinal surface will still be positive to the cross-section.

*Molecular Hypothesis.* — The fact that the smallest possible muscle prism is still positive on the longitudinal surface, and negative on the cross-section, suggested to DuBois-Reymond that muscle (and nerve) are composed of electrical particles or molecules something like the molecules of a magnet. A magnet has two poles, and, however it may be divided, the pieces still

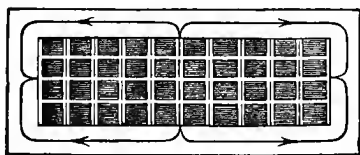

Fig. 33. Scheme of the myomeres in a parallel-fibred muscle (Rosenthal).

possess a north and a south pole. The magnet is therefore believed to be composed of molecules, each possessing a north and a south pole. These molecules lie with the north poles all pointing in one direction, the south poles in the other. The structure of muscle favors, in a measure, a similar hypothesis; for it is known that a striated muscle consists of fibrillæ, each of which is composed of a row of particles arranged in quite regular fashion. The electromotive molecules, or



myomeres, may be conceived to be positive on their longitudinal surfaces, and negative on their cross-sections (Fig. 38). They are assumed to have their negative surfaces turned towards the ends of the muscle or nerve, and the positive equatorial region turned towards the longitudinal surface. A non-electric conducting substance surrounds them. An electrode placed on the longitudinal surface would touch only the positive sides, while an electrode placed on the cross-

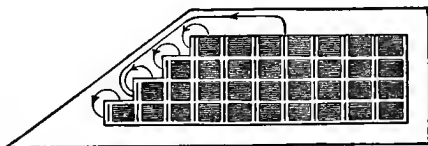

Fig. 39. Scheme of myomeres in an oblique section (Rosenthal).

section would touch only the negative poles. However small the muscle prism was made, the relation would still be the same. Thus the distribution of potentials would correspond with that actually observed.

When the cross-section is oblique, the myomeres at the cross-section are exposed as shown in Fig. 39, and the currents which pass from the longitudinal surface of each myomere to its cross-section are added to the main currents passing

from the longitudinal surface to the cross-section of the whole muscle. The region of maximum positive potential is thereby brought towards the obtuse angle of the oblique cross-section, and the region of maximum negative potential is displaced towards the acute angle, as actually observed.

When it was found by Bernstein, Hermann, and others, that uninjured muscle showed no difference of potential, DuBois-Reymond assumed that in the natural, uninjured state the end of the muscle in contact with the tendon (the "natural cross-section") is composed of a layer of molecules which have their positive instead of negative surface turned towards the tendon.

The highly artificial and complicated structure which DuBois was compelled to erect on this foundation in order to explain all the electrical phenomena of living tissue, cannot be discussed here. The chief argument against the molecular theory of muscle and nerve currents is that the phenomena can be explained in a simpler way.

*Alteration Theory.* — This hypothesis, in the making of which Hermann and Hering have been especially active, explains the electromotive forces of nerve and muscle by alterations in the chemical composition of the tissue at the

cross-section. When the cross-section is made, the tissue next the section passes through the series of catabolic changes which constitute muscle death; carbon dioxide is given off, lactic acid is developed, a soluble proteid is converted to a less soluble form, etc. The contact of this dying layer with the uninjured tissue is believed to create a difference of potential. The potential difference, therefore, appears at the demarcation between dying and uninjured tissue, —hence the term “demarcation current.” The action current finds its explanation in the chemical changes accompanying contraction. It would be interesting to consider here the parallel between the chemical transformations in contraction and those which usher in the death of the muscle, but we must be content with mentioning the apparently close relationship. In its most general form, the alteration hypothesis rests on the fact that living substance is everywhere the seat of constant constructive and destructive changes. Where these are nearly in equilibrium, as, for example, in the resting uninjured muscle, the tissue is equipotential; where, on the contrary, either form of chemical change has the upper hand, as in the explosion which we term contraction, and in dying muscle, it is assumed that a difference of potential is created.

For many years the weight of physiological opinion has been largely on the side of the alteration hypothesis; but it would be unsafe without further evidence to decide finally against the molecular theory.

### ACTION CURRENT OF MUSCLE

The demarcation current (current of injury, current of rest) just studied has been shown to be due to the injury of the tissue. We have now to examine the electromotive forces which appear when a nerve or muscle becomes active.

1. **Rheoscopic Frog.** — Make two nerve-muscle preparations, A and B. Let the nerve of B rest on muscle A. Stimulate the nerve of A with single induction shocks, and with the tetanizing current.

Muscle B will contract once for each contraction of A. The current of action of muscle A stimulates the nerve of B.

Secondary contraction can take place also from muscle to muscle, but only under circumstances that suggest increased irritability, as, for example, through partial drying. No secondary contraction has been secured from voluntary muscular contraction.

2. That the stimulus to the nerve of the rheoscopic muscle is really an electrical current, is

shown by the capillary electrometer. Place muscle A in the moist chamber. Make two non-polarizable electrodes, substituting for the brush a piece of well-washed candle-wick an inch long, thoroughly wet with soft normal saline clay. Let one electrode rest on the tendon and the other on the equator. Lead from the non-polarizable electrodes through a closed short-circuiting key to the capillary electrometer (the

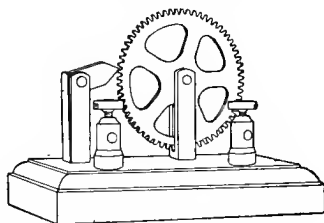

Fig. 40. The wheel interrupter.

tendon should be connected with the capillary). Lay the nerve on stimulating electrodes. Connect the latter with the secondary coil of an inductorium arranged for single induction currents. Place the wheel interrupter (Fig. 40) in the primary circuit. Bring the meniscus into the field. Open the short-circuiting key. The meniscus will be displaced by the demarcation current. When the meniscus has come to rest, stimulate the nerve with single and repeated induction currents.

With each stimulus there will be a negative variation (action current) of the demarcation current.

When the number of stimuli per second passes a certain point, which differs with different individuals, the hitherto separate excursions of the meniscus will be fused, and a gray blur will appear at the end of the vibrating column. Movements of this rapidity may of course be studied by photographing them on sensitive paper moving rapidly enough to draw the fused image out into a line in which its component oscillations are each distinct, or they may be observed directly by the stroboscopic method.

**The Action Current in Tetanus ; Stroboscopic Method.** — 1. If a piece of thin black paper about 1 cm. square is fastened vertically on the end of the electromagnetic signal lever, and the signal placed in the primary circuit of the inductorium arranged for tetanizing currents, the piece of paper will move each time the primary current is made or broken by the vibrating hammer of the inductorium. The movement is so rapid that the paper seems stationary and a gray haze appears on its upper and lower border.

Connect the electrometer with the secondary coil of the inductorium, and bring the vibrating meniscus into the field.

Bring the stroboscopic paper next the acid reservoir of the electrometer at such a height that the edge of the meniscus shall be seen through the gray blur. The meniscus will no longer appear blurred, but will be as sharp as if the mercury were stationary. This appearance is produced only when the stroboscopic paper and the object seen by its aid have the same periodicity of vibration. If the periodicity of the vibrations is unequal, interference results, and from this interference the rate of vibration of the observed body can be calculated. For example, if the observed body shows three vibrations per second, when observed through the stroboscope, its rate is three more per second than that of the stroboscope.

In the present instance, the meniscus remains apparently at rest. The number of action currents is therefore identical with the number of stimuli.

2. *Rheoscopic Muscle Tetanus.*—The same method may be applied to the analysis of the rheoscopic tetanus in the rheoscopic muscle.

Place two nerve-muscle preparations in the moist chamber. Lay the nerve of B on the muscle of A. Place the non-polarizable electrode threads on the tendon and the longitudinal surface of muscle B, and connect them through a

short-circuiting key with the electrometer. Place the nerve of A on electrodes connected with the secondary coil (the coil should be well over the primary). Bring the meniscus into the field, and open the short-circuiting key. Place the stroboscope, still in the primary circuit, near the meniscus. Tetanize the nerve of A.

For each stimulus received from nerve A, muscle A contracts; the contractions are so frequent that they fuse into tetanus. At each

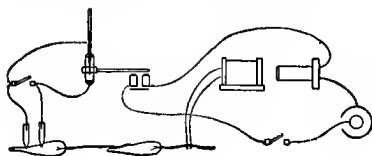

Fig. 41.

contraction of A, its current of action stimulates the nerve of B, and B also contracts. At each contraction of B, the action current displaces the meniscus, which falls therefore into very rapid oscillation. Observe the meniscus through the stroboscope. It will seem to be standing still.

Thus the apparent continuous contraction of muscle B is in reality a series of simple contractions, as stated, corresponding in number to the make and break currents of the inductorium.



For each contraction there is one action current in each muscle.<sup>1</sup>

When a muscle and its nerve are removed without injury to the muscle, electrodes placed on the latter will show no difference of potential, as already stated (page 153). Stimulation of such a muscle through its nerve causes a current of action to start at the point at which the nerve enters the muscle fibres. The contraction wave begins also at this point, as may be shown very beautifully by "fixing" the contraction in the muscles of certain insects by plunging the contracting muscle into a solution which arrests and "sets" the fibre instantly. In such cases fibres will be found in which the contraction wave is caught at its beginning in the neighborhood of the nerve end-plate.

The action current, beginning at the entrance of the nerve into the muscle fibre, passes in both directions along the fibre. As may be shown with the differential rheotome, or by photographing the meniscus of the capillary electrometer, the current is diphasic. In the first phase, the current is directed away from the nerve, in the second phase, towards it. In extirpated muscle, the second phase is much weaker than

<sup>1</sup> The experiment also demonstrates that the meniscus has no after vibrations, but follows unerringly the changes of potential.

the first. In normal muscle *in situ* (human muscle), this difference or *decrement* does not appear.

The direction of the current obtained with the electrometer from the *whole* muscle is determined by the position of the electrodes with reference to the nerve equator, namely, a transverse line drawn at the mean distance from the entrance of all the nerve fibres. Points nearer the equator are negative to points further away.

**Action Current of Human Muscle.** — Cover the brass electrodes with cotton saturated with saline solution, and connect them with an inductorium arranged for tetanizing currents. Close the short-circuiting key of the secondary coil. Replace the brush in the non-polarizable electrodes with a piece of well washed candle-wick a foot long. Saturate the wick with zinc sulphate solution. Place one of these electrodes around the forearm near the elbow, the other around the wrist. (The nerve equator lies about the upper third of the forearm.) Connect the electrodes through a short-circuiting key with the capillary electrometer. Place the brass electrodes over the brachial plexus in the axilla. Bring the meniscus into the field. Open the short-circuiting key leading to the electrometer. If the meniscus is displaced by a skin (secretion)

current bring it back by means of the pressure apparatus. Set the inductorium in action. Open the short-circuiting key of the secondary coil, thus stimulating the nerves.

The meniscus will be displaced by an action current.

**Action Current of Heart.** — 1. Expose the heart of a frog (page 75). Lay the nerve of an irritable nerve-muscle preparation on the beating ventricle.

During diastole, the rheoscopic muscle will be quiet; at each systole, it will contract.

2. Tie a cotton thread one inch long about the brush of each non-polarizable electrode, and let the ends, wet with normal saline solution, rest on the beating heart, one on the base, the other on the apex. These electrodes will follow the movements of the heart. Connect the electrodes through a short-circuiting key to the electrometer.

During the diastole, the meniscus will remain at rest. At each beat of the ventricle, the meniscus will move; first in a direction indicating that the base is negative to the apex, and then in the opposite direction. The action current passes over the heart from base to apex.

These experiments show not only that there is an action current at each systole of the heart,

but are evidence also that the resting heart muscle is iso-electric (*i. e.* of uniform potential).

*The Action Current precedes the Contraction.*— Remove the heart, including a portion of the great veins. Set the metal heart-holder (Fig. 42) on the base of the iron stand and place the heart, together with some normal saline solution, in the spoon of the holder. Rest the upright of the

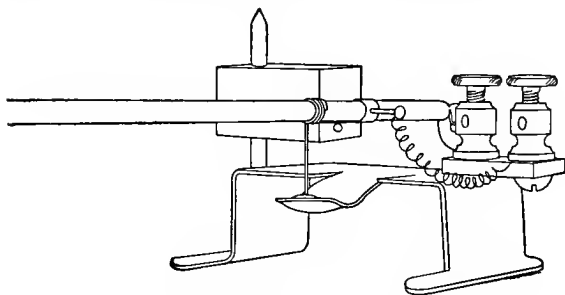

Fig. 42. The heart-holder.

straw heart-lever on the ventricle (the lever should be counterpoised with a “washer” or other weight). Make a nerve-muscle preparation. Fasten the femur in the upper side of the muscle clamp, at right angles to the long axis of the clamp. Bring the latter near the heart-holder, so that the nerve may rest on the ventricle. Fasten the tendon Achilles to the muscle lever by a thread which passes over the pulley on the

axis of the lever before being secured to the lever. Thus the muscle, though below the lever, will pull it upwards when contraction takes place. Let the two writing points be in the same vertical line. Start the drum at rapid speed. Two curves will be recorded: one by the contraction of the ventricle, the other by the rheoscopic muscle, stimulated to contract by the action current. The contraction of the rheoscopic muscle will slightly precede the contraction of the ventricle.

*Current of Action of Human Heart.*— Place normal saline solution in two beakers. In each let the brush of a non-polarizable electrode dip. Connect the electrodes through the usual short-circuiting key with the electrometer. Bring the meniscus into the field. Let an assistant place a finger of each hand in the saline solution.

When the short-circuiting key is opened the meniscus will be displaced by the skin (secretion) current. Careful observation will show also a periodic variation synchronous with the systole of the heart.

The diphasic character of the action current of the heart, shown so well by the capillary electrometer to the unaided eye, appears even more clearly when the movements of the meniscus are recorded by projecting them on a quickly moving photographic plate. By photography, too, the di-

phasic character of the action current in the more rapidly contracting skeletal muscle is made visible, and the form of the action current wave recorded. Before the capillary electrometer was used for

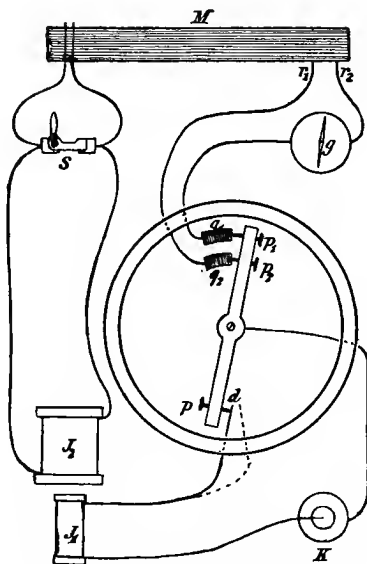

Fig. 43. Scheme of differential rheotome.

this purpose, the differential rheotome of Bernstein was employed. This celebrated invention consists of a wheel which revolves at uniform speed and carries contacts by which the primary circuit of an inductorium and a galvanometer

circuit may be made. By means of the inductorium, the muscle is stimulated at one end. The galvanometer records the current of action by means of electrodes placed at the other end of the muscle. The position of the galvanometer contact on the wheel can be shifted nearer to or farther from the stimulating contacts; thus the interval between stimulation and the making of the galvanometer circuit may be chosen at will, and the electromotive force at any point in the action wave registered. By repeatedly changing the interval, the several portions of the wave can be investigated successively, and the results plotted. With Hermann's rheotachygraph, the whole electrical change may be recorded at one time. In this instrument the stimulating contacts revolve rapidly, and the galvanometer contact less rapidly, so that the interval between stimulation and the closure of the galvanometer continually alters. The effect of the electrical change on the galvanometer is thus prolonged so that the galvanometer mirror is able to follow it.

The results from these different methods agree in showing that the electrical change sweeps over the muscle (and nerve), in the form of a wave at a rate, in frog's muscle, of about three metres per second. The duration of the wave is from 0.0033 to 0.0040 second. The ascent is

quicker than the descent. The latent period is probably absent; the process begins as soon as the stimulus reaches the muscle. The electromotive force of the action current for a single contraction of the frog's gastrocnemius is about 0.08 volt.

Direct stimulation of the whole of a normal uninjured muscle produces no action current whatever, because the whole muscle becomes active at the same moment.

#### ACTION CURRENT OF NERVE

1. **Negative Variation.** — Sever the nerve of a nerve-muscle preparation close to the muscle, and lay the nerve in the moist chamber on a glass plate. Place non-polarizable electrodes on the equator and on one cross-section, and lead them through a short-circuiting key to the capillary electrometer. Place a second pair of non-polarizable electrodes near the other cross-section of the nerve. Connect this second pair to the secondary coil of an inductorium. Connect the primary coil through a key and the wheel interrupter with a dry cell. Bring the meniscus into the field. Open the short-circuiting key. The meniscus will be displaced by the demarcation current. Stimulate the nerve with induction shocks at different rates.



A negative variation will be observed each time the nerve is stimulated.

2. The current of action is not dependent on the electrical stimulation, but is an expression of the changes in the nerve which constitute the nerve impulse. It follows mechanical as readily as electrical stimulation.

Lead to the capillary electrometer from non-polarizable electrodes placed on the longitudinal surface and cross-section. Note the position of the meniscus. Stimulate the nerve mechanically by snipping the end with the scissors.

There will be a negative variation as before.

**Positive Variation.** — The direction of the current of action is not always opposite to that of the demarcation current. Biedermann obtained a current in the positive direction on stimulating the nerve to the adductor muscle in the lobster. In the tortoise, the cardiac auricle may be cut away from the sinus, without injury to the coronary nerve, which in this animal carries to the auricle the cardiac fibres of the vagus. After this operation, the auricle and ventricle remain motionless for a time. In a heart thus prepared, Gaskell made a thermal cross-section by immersing the tip of the auricle in hot water, and led the demarcation current to a galvanometer. The stimulation of the vagus in the neck — the

heart still resting — caused a marked increase in the demarcation current, in other words, a positive variation. No visible change in the form of the heart was observed.

**Positive After Current.** — Compensate the demarcation current of nerve by the method described on page 158. When compensation is secured, note the position of the meniscus on the scale, and tetanize the nerve. The meniscus will be displaced by the current of action. Note the direction of the current. Break the stimulating current. The meniscus will return to and pass the position which it held when the demarcation current was compensated, showing thus a current opposed in direction to the action current.

The positive after current is absent in weakened or fatigued nerves.

**Contraction secured with a Weaker Stimulus than Negative Variation.** — Place the non-polarizable electrodes on the longitudinal surface of the nerve of a nerve-muscle preparation. Connect them through the usual short-circuiting key with the electrometer. Bring the meniscus into the field. Arrange the inductorium for break currents. Place the secondary coil some distance from the primary. Stimulate the nerve in the extrapolar region. Approach the coils

until the threshold value is reached and the muscle contracts.

At the threshold value of muscular contraction, the current of action in the nerve will not yet be demonstrable. The coils must be still nearer together before the action current becomes visible.

This experiment has a certain suggestive value. It would not, however, be safe to conclude from it that the action current is not an essential part in the passage from the resting to the active stage. The failure to recognize the action current probably lies in the method.

**Current of Action in Optic Nerve.** — Place two non-polarizable electrodes in the moist chamber, and connect them through a short-circuiting key with the capillary electrometer. Remove the eye of the frog, together with a portion of the optic nerve, and lay the preparation on a glass slide in the moist chamber. Bring one non-polarizable electrode against the edge of the cornea, and the other against the optic nerve. Cover the electrodes and the preparation with a black pasteboard box or other opaque screen to shut off the light. Note the position of the meniscus in the field of the microscope. Open the short-circuiting key. A demarcation current from the injured optic nerve to the cornea will

be indicated. Remove the box so that light shall fall on the retina.

The demarcation current will undergo a negative variation.

Shut off the light by replacing the box.

There will now be a positive variation.

Currents of action have also been demonstrated in the central nervous system. Gotch and Horsley find that when the spinal cord of the monkey is severed, and non-polarizable electrodes are applied to the longitudinal surface and the cross-section, a negative variation of the current of injury appears whenever the cortex of the cerebrum is stimulated in the neighborhood of the fissure of Rolando, — the “motor” region. A considerable degree of localization in the cord is possible. It may be shown that the negative variation from the motor region of the cortex descends the cord chiefly in the crossed pyramidal tract, — a collection of white fibres in the lateral column of the cord near the gray matter. It is known from pathological evidence that the nerve impulse from the motor cortical cells passes through these fibres, and the demonstration of their negative variation justifies the hope that this method may be useful in determining the course of other nerve fibres in the brain and cord.

**Errors from Unipolar Stimulation.** — Attention already has been called to the danger of unipolar induction currents entering the electrometer circuit in observations of the action current with the capillary electrometer or galvanometer (page 48).

Place a nerve in the moist chamber. Connect the capillary electrometer through a short-circuiting key with non-polarizable electrodes placed on the longitudinal surface and cross-section, about 5 mm. apart. Let a wire connected with one pole of the secondary coil rest on the nerve about 2 cm. from the non-polarizable electrodes. Open the short-circuiting key. When the meniscus has come to rest, set the inductorium in action.

If the meniscus remains at rest, bring the secondary coil nearer the primary, until unipolar effects appear.

#### SECRETION CURRENT

**Secretion Current from Mucous Membrane.** — Remove the skin from the lower jaw of a frog, the skull of which has been cut away. Be very careful not to touch the tongue with metal instruments or with fragments of skin. Make a normal saline clay electrode about 1 cm. square and 3 mm. thick on the glass of the cork clamp near the

cork. Lay the denuded jaw on the glass, and turn the tongue forward with a glass rod until the tip can be secured in the clamp. Avoid all roughness. The normally upper surface of the tongue will now rest on the clay. Bring one non-polarizable electrode into contact with the clay, and let the other touch the upper (normally lower) surface of the tongue. Connect the electrodes through an open key with the capillary electrometer. Bring the meniscus into the field, and note its position on the micrometer scale. Close the key.

A strong difference of potential will be shown. The normal under surface is usually positive towards the normal upper surface.

The difference of potential thus demonstrated is probably chiefly due to secreting glands in the mucous membrane. If the "secretion current" is compensated after the general compensation method described on page 158, and the glosso-pharyngeal nerve then stimulated, the electrometer will show an electromotive force, in a direction opposite to the original difference of potential,—in other words, a "negative variation."

**Negative Variation of Secretion Current.** — Place a frog curarized until voluntary motion is just paralyzed back uppermost on the frog board. Strip the skin from one thigh, and expose

the sciatic nerve of this side. Place non-polarizable electrodes on the bare muscle of the thigh and on the skin of the leg. Connect the electrodes to a rheocord arranged for compensation by the bridge method, as shown in Fig. 37. Place the capillary electrometer in a short circuit. Bring the meniscus into the field, and note its position. Open the short-circuiting key. Move the slider along the wire until the meniscus returns to its original position. Now stimulate the sciatic nerve with the tetanizing current.

A negative variation will be seen. If the skin current was slight, the variation may be positive.

The greater part of the skin current is doubtless a secretion current, but not all. Weak currents have been obtained from skin devoid of glands, for example, the eel's skin. Hermann attributes this current to the degeneration which accompanies the change of the nucleated cells of the corium to the dead scales of the outer epidermis.

A strong secretion current may be obtained from the skin of the foot (cat). On stimulation of the sciatic nerve, the current is increased (positive variation).

In the submaxillary gland, the hilus is positive to any point on the external surface of the gland. Stimulation of the chorda tympani nerve, secre-

tory fibres from which are supplied to the gland, causes the surface to become still more negative, *i. e.* the secretion current is increased (positive variation). Stimulation of the sympathetic, which also sends fibres to the gland, causes the secretion current to lessen (negative variation).

### ELECTROTONIC CURRENTS

It has already been shown that the irritability and conductivity of the nerve are altered by the

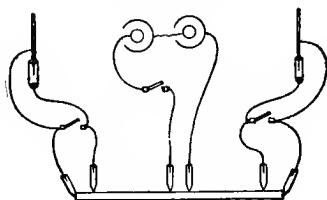

Fig. 44.

galvanic current. So also are the electromotive properties.

Place one pair of non-polarizable electrodes near the middle of a long piece of extirpated nerve, and one other pair at each end, on the cross-section and longitudinal surface as in Fig. 44. Connect the middle pair through a key with two dry cells. Connect each of the other pairs through a short-circuiting key with a



capillary electrometer. Let one observer watch each meniscus, while a third experimenter manages the polarizing current. Note the position of each meniscus. Open the short-circuiting keys. In each electrometer, the meniscus will be displaced by the demarcation current. It should be noted that the demarcation currents are of opposite direction, flowing in the nerve from the cross-section towards the longitudinal surface. Make the polarizing current.

When the polarizing current enters the nerve, there will be a twitch in each electrometer, caused by the negative variation of the demarcation current; this may be neglected. Each meniscus will be displaced; on the side of the anode of the polarizing current, the demarcation current will be reinforced, but on the side of the cathode it will be diminished.

Thus the passage of the galvanic current through a part of the nerve has polarized the nerve on both sides of that part. The extrapolar region on the side of the anode becomes positive; the extrapolar region on the side of the cathode becomes negative; similar changes probably occur in the intrapolar region. In short, an electrotonic current is set up, having the same direction as the polarizing current. This electrotonic current augments the demarcation current

on the side of the anode, but is opposed to that on the side of the cathode. It appears when any two points on the longitudinal surface are "led off" to the electrometer, and is entirely independent of the demarcation current.

The intensity of the electrotonic current depends on the intensity of the polarizing current. The greater the separation of the polarizing electrodes, the less the electrotonic effect, as might be expected from the great resistance of nerve. If this factor be excluded by placing in the circuit a much greater resistance than that of nerve, the electrotonic effect will be found to increase with the length of the intrapolar region. The electrotonic current is absent in dead nerves, in strongly cooled nerves, and in those ligated between the polarizing electrodes and the electrodes leading to the electrometer.

In muscle, the electrotonic currents are much stronger than in nerve.

**Negative Variation of Electrotonic Currents ; Positive Variation (Polarization Increment) of Polarizing Current.** — Place the polarization electrodes near one end of the nerve. Connect them through a short-circuiting key with a dry cell. From the short-circuiting key lead to a capillary electrometer (Fig. 45). From the middle of the nerve lead off the electrotonic current through a short-

circuiting key to a second capillary electrometer. Near the other end of the nerve place stimulating electrodes connected with the secondary coil of an inductorium arranged for tetanization. Make the polarizing current. Open the short-circuiting key leading to the electrotonic electrometer, and note the position taken by the meniscus under the influence of the electrotonic current. Make the tetanizing current.

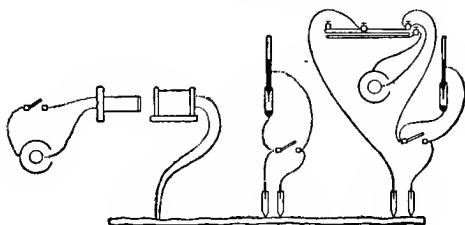

Fig. 45.

The strength of the electrotonic current will be diminished. At the same time the strength of the polarizing current will be increased (polarization increment).

These are in reality action currents.

The electrotonic currents are absent in nerves which lack a myelin sheath. This suggests that the myelin in some way divides the nerve into a core and a sheath. If a zinc wire connecting two electrodes is surrounded by a layer or sheath

of saturated solution of sulphate of zinc, there will be no polarization, and the current will not spread to any extent beyond the electrodes. If, however, the wire is platinum instead of zinc, polarization will take place where the current passes from the electrodes through the electrolyte into and out of the wire, and the polarization may be recognized by connecting the extrapolar region with the electrometer as in the foregoing experiment. The resistance to the spread of the electrotonic current in a longitudinal direction is relatively slight, so that it passes almost instantly along the core.

In nerve, also, the greater resistance in the transverse direction (five-fold greater than the resistance in the longitudinal direction) would favor the spread of electrotonic currents lengthwise along the nerve.

Certain observations of Biedermann make it difficult to accept without reservation the simple physical explanation just offered. For example, the narcotization of a nerve with ether or chloroform causes the electrotonus to disappear a short distance from the electrodes, although still strongly present in their immediate neighborhood. These experiments cannot be discussed here, but they indicate that to the purely physical must be added a physiological electrotonus.

**The Electrotonic Current as a Stimulus.** — As would naturally be expected, the electrotonic current may be an effective stimulus. Bring the end of an extirpated nerve A into contact with the distal portion of the nerve of a nerve-muscle preparation, B, as in Fig. 46, and place on the other end of A non-polarizable electrodes joined through a key to a battery of two cells. Make the galvanic current.

Muscle B will contract.

The galvanic current polarizes nerve A, and the electrotonic current thereby set up passes into the nerve of B through the contact, and occasions in nerve B an impulse which descends to the muscle and stimulates it to contract.

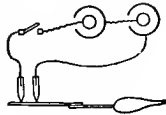

Fig. 46.

*Paradoxical Contraction.* — Expose the bifurcation of the sciatic nerve into tibial and peroneal branches. Polarize either of these branches. (The electrodes should not be placed too near the bifurcation.)

On making and breaking the polarizing current, the muscles supplied by each branch will contract.

In this instance, the extrapolar region of the branch polarized lies in part in the main trunk. The electrotonic current there spreads into the

contiguous axis cylinders, among them those of the other branch.

### ELECTRIC FISH

There are several species of fish which possess the power of discharging electrical currents when stimulated. The best known are *Torpedo*, a ray found on the coasts of Europe; *Gymnotus*, the electrical eel of South America; and *Malapterurus electricus*, a catfish found in the Nile and other African rivers. The electromotive force of these fishes is derived from a special organ placed beneath the skin. This electrical organ is bilateral and is formed of parallel plates. One side of each plate receives a branch of the electrical nerve, which in *Malapterurus* is a single great axis cylinder derived from a giant nerve cell. The side of the plate receiving the nerve becomes negative to the other side when the electrical organ is active; it behaves like the negative plate of the ordinary cell. When the nerve is at rest, there is no difference of potential in the electrical organ. The discharge in the active state is periodic, and may rise to 200 per second. The electromotive force is considerable: in *Torpedo*, 30–35 volts, 5 volts for each cubic centimetre of the organ, 0.08 volt for each plate. The fish itself

is not injured by the current; its tissues are not easily excitable by electricity, though they respond readily to mechanical stimulation.

#### APPARATUS

Normal saline. Bowl. Towel. Pipette. Glass plate. Sharp knife. Two dry cells. Four non-polarizable electrodes. Simple key. Capillary electrometer. Co-ordinate paper. Millimetre scale. Inductorium. Electrodes. Thirteen wires. Porcelain dish. Muscle clamp. Muscle lever. Stand. Cork. Rheocord. Normal saline clay. Filter paper. Wheel interrupter. Candle-wick. Electromagnetic signal. Pole-changer. Bent hooks. Black paper (stroboscope). Moist chamber. Large and small brass electrodes. Cotton. Common salt. Two beakers. Saturated solution of zinc sulphate. Cotton thread. Frog board. Heart-holder. Black box for covering retina. Bunsen burner. Glass slide. Cork clamp. Frogs.

## VIII

## THE CHANGE IN FORM

THE change in form or the contraction of muscle is the most conspicuous of the several ways in which its energy is set free. It has already been shown that this change consists of a shortening of the contractile mass followed by a return to the original length. It is necessary now to determine whether the muscle becomes smaller on entering the active state or whether the alteration in form is simply a shifting — a translocation — of the muscular units.

## VOLUME OF CONTRACTING MUSCLE

Strip the skin from the hind limb of a frog. Hang the limb from the hooked electrode in the stopper of the volume tube (Fig. 47) and place the stopper loosely in the tube. Hook the electrode at the other end of the tube into the limb near the foot. Fill the tube absolutely full of boiled normal saline solution, slightly withdrawing the stopper for the purpose. Replace the stopper in the tube in such a way that all air



bubbles shall be excluded. If the height of the water-column in the capillary tube does not permit the meniscus to be readily observed, move the glass rod in the stopper in or out until the meniscus is adjusted. Connect the electrodes with the secondary coil of an inductorium arranged for single induction currents. Note carefully the level of the water in the capillary tube. Stimulate the muscle with a maximal break current.

The level of the water in the capillary will not change. The change in the form of the contracting muscle is not accompanied by a change in volume.<sup>1</sup>

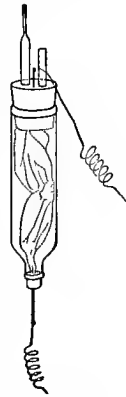

Fig. 47. The volume tube.

### THE SINGLE CONTRACTION OR TWITCH

The change in the form of the muscle on entering the active state is usually studied from the graphic record made on a smoked surface by a writing lever the shorter arm of which is attached to the end of the muscle. Such a record, it should be remarked, gives the extent

<sup>1</sup> This experiment must not be regarded as excluding a very slight change in volume, because of the difficulty of expelling, by boiling or otherwise, all the air in the saline solution.

and the time relations of the shortening, but not the thickening of the muscle. (See page 202.)

**The Muscle Curve.** Prepare a gastrocnemius muscle together with the distal third of the femur. Fasten the latter in the muscle clamp. Attach the tendo Achillis to the hook on the muscle lever by means of a fine copper wire which should be wrapped round the hook and the end then carried to the binding post on the muscle lever. Place a ten-gram weight in the scale-pan. Connect the posts on the clamp and the lever with the secondary coil of an inductarium arranged for maximal induction currents. In the primary circuit place an electromagnetic signal. Bring the writing points of the signal and the muscle lever against the smoked paper in the same vertical line. Start the drum at its most rapid speed. Stimulate the muscle with a maximal break current.

The muscle will shorten and then extend, marking a period of rising energy and a period of sinking energy. Note that the period of rising energy is shorter than the period of sinking energy. Close observation will show that the lever does not begin to move at the instant the muscle is stimulated, — there is here an interval or latent period.

**The Duration of the Several Periods.** — Turn to

the right the screw at the top of the sleeve bearing the recording drum until the sleeve is raised from the friction bearing. The drum can now be "spun." Start the tuning fork vibrating, spin the drum, lay the writing point of the tuning fork on the smoked paper near the line traced by the electromagnetic signal, and stimulate the muscle with a maximal induction current.

An interval will be found between the moment of stimulation (marked by the electromagnetic signal) and the beginning of contraction. This interval is the mechanical latent period. Measure its duration by means of the tuning fork curve. Measure also the duration of the period of rising energy and the period of sinking energy.

Helmholtz, who first measured the latent period of frog's muscle, found a mean duration of 0.01 sec., while the phase of rising energy measured 0.04 sec., and the phase of sinking energy 0.05 sec. More recent measurements by Tigerstedt and others have reduced the latent period given by Helmholtz to from 0.0025 to 0.005 sec. The interval observed grows less as the intensity of stimulation is increased from the threshold to the maximal value; further increase in intensity (supermaximal stimulation) causes no further diminution in the latent period.

The period is shorter at high temperatures than at low, with maximal break induction currents than with make induction currents, with break induction currents than with closure of the galvanic current. Changing the load of the muscle is without effect on the latent period.

When the muscle is stimulated through its nerve the latent period is longer by about 0.002 sec. than when the electrodes are placed on the muscle itself (Bernstein), due allowance being made for the time occupied by the passage of the nerve impulse along the trunk of the nerve from the point of stimulation to the muscle. The additional time is taken perhaps in the passage of the impulse through the end plate into the contractile substance.

Grützner has shown that the striated muscle fibres, particularly of vertebrates, differ in their histological elements. Some are rich in sarcoplasm, and when seen by transmitted light appear cloudy and granular; others have less sarcoplasm and are relatively translucent. This difference in structure is associated with a striking difference in the character of the contraction. The muscles composed chiefly of turbid fibres contract slowly, while "clear" muscles contract rapidly (compare page 140). Thus in the rabbit the duration of the contraction of the red soleus

muscle, which is rich in sarcoplasm, is about 1.0 sec., while in the white gastrocnemius—a “clear” muscle—it is 0.25 sec. In the frog, the contraction period of the hyoglossus is 0.205, the gastrocnemius 0.120, and the gracilis 0.108 sec. (Cash). The latent period is longer in the red muscles. The amplitude of contraction is less in the red than in the white.

The mixture of quickly and slowly contracting fibres in the same muscle is sometimes obviously an advantage. Thus in certain bivalves the quick fibres in the shell-closing muscle close the shell rapidly, and the slow fibres keep it closed after the contraction of the quick fibres has ceased.

The form of the contraction is influenced by the mixture of fibres. The clear fibres reach their maximum shortening sooner than those rich in sarcoplasm. In some instances, indeed, the contraction curve may show two summits. These differences may perhaps explain the characteristic differences in the form of the contraction wave of different muscles, observed by Cash and others. The white fibres are more easily fatigued than the red. Thus the triceps humeri of the rabbit contracts at the beginning of stimulation like an unmixed white muscle (quickly), but later like a red muscle (slowly).

**The Excitation Wave.**—Secure the cork clamp

(Fig. 17) in the muscle clamp. Smoke a drum. Raise the drum off the friction bearing by turning to the right the milled screw at the top of the shaft. Fasten a curarized sartorius muscle to the cork block on the upper margin of the cork clamp<sup>1</sup> by means of two needles to the ends of which conducting wires are soldered. Let the cork clamp compress the muscle sufficiently to prevent the passage of a contraction wave from one part of the muscle to the other, but not sufficiently to prevent the passage of the excitation. Let a second pair of needle electrodes rest on the muscle near the upper side of the cork clamp. Connect the two pairs of electrodes to the end cups of a pole-changer (without cross wires), the side cups of which are connected with the secondary coil of an inductorium arranged for single maximal induction currents. In the primary circuit of the inductorium place the electromagnetic signal. Fasten the tibial end of the muscle to a muscle lever. Bring the writing point against the smoked surface exactly underneath the point of the electromagnetic signal. "Spin" the drum slowly. Place the writing point of a vibrating tuning fork against the smoked paper below the recording levers. Stim-

<sup>1</sup> This cork block has been omitted from Fig. 17 for the sake of clearness.

ulate the muscle with a maximal break current first through one pair of electrodes and then through the other. In each of the resulting curves measure the interval between stimulation and contraction (for method see page 147).

This interval will be longer when the muscle is stimulated farther from the portion the contraction of which is recorded. The difference is the time taken by the excitation to traverse the part of the muscle lying between the two pairs of electrodes. Measure the distance and calculate the speed of the excitation.

The nature of the excitation process is unknown. The current of action has been shown to precede the visible change in form of muscle. It is usually assumed to be a manifestation of the excitation process, but the precise relation between the two has never been ascertained. The speed of the excitation is the same as that of the contraction wave.

**The Contraction Wave.** — Fasten a curarized gastrocnemius muscle upon the glass plate of the cork clamp by means of two needle electrodes at the end bearing the cork block, and by means of an ordinary pin at the other end. The cork clamp should be supported on the wooden stand. Attach a small piece of cork to the double hook on two counterpoised muscle levers, each sup-

ported on a separate stand. Let the cork pieces rest respectively on the muscle near the femur and the Achilles tendon. Bring the writing points of the two levers against a smoked drum in the same vertical line. Let a tuning fork write its curve near that of the muscle levers. Set the tuning fork vibrating. Let the drum revolve rapidly. Stimulate the muscle at one end with a maximal make induction current.

The lever near the point of stimulation will begin to rise before that farther away. Evidently the contraction starts at the point stimulated and spreads along the muscle in the form of a wave (compare pages 171 *et seq.*).

Determine the speed per second of the wave of contraction by measuring with the tuning fork curve the time occupied by the wave in passing along the muscle from one lever to the other.

It is evident that a lever resting on a horizontal muscle will register the change in form of the cross-section on which the lever lies, while a lever attached to the end of a muscle suspended vertically will be moved by the change in form of all the cross-sections of which the muscle is composed. The curves secured by the two procedures are similar in form, but different in duration. The curve of thickening is shorter by the difference between the time taken by the contraction



wave to pass over the single cross-section, on the one hand, and the whole length of the muscle on the other.

An extirpated muscle is apt to remain shortened after contraction. To bring muscles back to their original length it is usually necessary to weight them, or — as in the body — to submit them to the pull of antagonists. Even the weighted muscles may return very slowly and imperfectly to their normal length. This *contracture*, as it is termed, is seen especially in strong direct stimulation, in poisoning with veratrine, and as death comes on. Contracture is not the result of fatigue, for when the muscle is repeatedly stimulated contracture diminishes, instead of increasing. During contracture, the irritability of the muscle for stimulation through the nerve is diminished.

**Relation of Strength of Stimulus to Form of Contraction Wave.** — Fasten the femur of a gastrocnemius preparation in the muscle clamp and attach the Achilles tendon to the muscle lever with a fine copper wire the end of which should be carried to the binding post on the handle of the lever. Connect this post and that on the muscle clamp with the secondary coil of the inductorium. Bring the writing point against the smoked drum. Stimulate the muscle with break

induction currents of varying intensity and record the contraction curves.

It will be found that the contraction is longer with weak stimuli than with strong.

**Influence of Load on Height of Contraction.**— Attach a curarized gastrocnemius preparation to the muscle lever and bring the writing point against a smoked drum. Connect the binding posts on the lever and the muscle clamp with the secondary coil of the inductorium. Load the muscle with the lever and scale-pan only. With the drum at rest record the contraction on stimulation with a maximal induction current. Turn the drum by hand one millimetre. Place a one-gram weight in the scale-pan, and record the contraction produced by a make induction current of the same intensity as before. Continue to add gram weights and to record the contractions until ten one-gram weights have been placed in the scale-pan. Transfer the muscle to the rigid lever (Fig. 48). Now increase the load each time by ten grams, recording the contraction after each increase, until the muscle is weighted with one hundred grams. (Care should be taken not to fatigue the muscle by stimulating it oftener than is necessary to obtain the record.)

Within certain narrow limits the height of the

contraction will be increased by the increase in the load. With increasing loads the height of contraction diminishes at first quickly, and then more slowly.

**Influence of Temperature on the Form of the Contraction.** — Prepare a gastrocnemius muscle together with its attachment to the femur. Fasten the femur in the clamp on the under side of the cover of the "muscle warmer" (Fig. 49). Tie the end of a fine copper wire about ten centimetres long around the Achilles tendon. Fasten the other end of the wire to a split lead shot. Bring the shot through the opening in the bottom of the muscle warmer and wrap the wire around the hook of the muscle lever. Remove the shot and fasten the end to

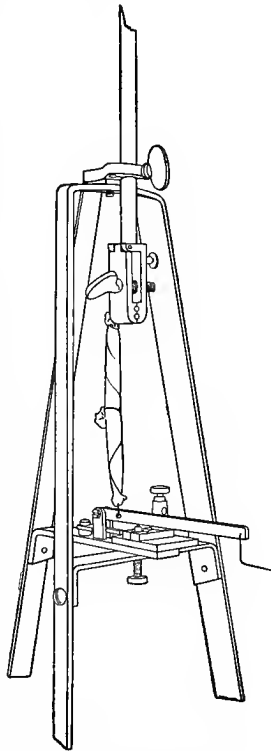

Fig. 48. The rigid muscle lever, with removable isometric spring.

which it was attached in the binding post on the muscle lever. Make sure that the wire connecting

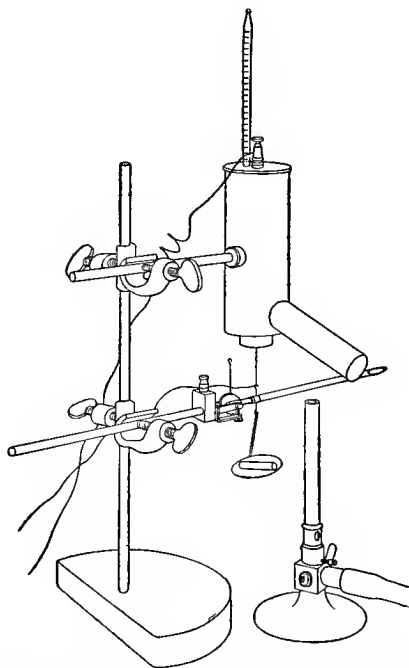

Fig. 49. The "muscle warmer"; an apparatus for studying the influence of temperature on muscular contraction.

the tendon with the muscle lever is vertical. Connect the binding posts of the muscle warmer and the muscle lever with the secondary coil of an in-

ductorium arranged for single induction currents. Fill the chamber of the muscle warmer with cracked ice. Bring the writing point of the muscle lever against a smoked drum. Let the drum revolve at fairly rapid speed. Stimulate the cooling muscle at intervals of  $5^{\circ}$  with a maximal break current.

Note that as the temperature falls the contraction curve becomes longer. The phase of rising energy is lengthened more than the relaxation. The earlier portion of the relaxation is lengthened less than the later; the muscle shows a tendency to contracture (see page 203).

Place fresh paper on the drum. Let the drum revolve very slowly. Place a lighted Bunsen burner under the arm of the muscle warmer. At intervals of  $5^{\circ}$  stimulate the muscle with a maximal break current. Note the changes in the contraction.

The height of contraction is least at the freezing point of the muscle ( $-5^{\circ}$ ). It rises from the freezing point to  $0^{\circ}$ ; falls from  $0^{\circ}$  to  $19^{\circ}$ ; increases to  $30^{\circ}$ , which is the maximum; from  $30^{\circ}$  to  $45^{\circ}$  diminishes again; and at  $45^{\circ}$  the frog's muscle usually enters into a state called *rigor caloris*; the muscle becomes opaque, inelastic, resistant to the touch, shortens very considerably, and undergoes chemical changes of great impor-

tance. The duration of contraction lessens with the rising temperature, being least at 30°. Above 30° the duration remains approximately unchanged. The latent period is increased at low temperatures, diminished at high. Above 30° the excitability to electrical stimuli diminishes steadily; it disappears almost entirely before rigor is reached.

**Influence of Veratrine on the Form of the Contraction.** — With a capillary pipette inject in the dorsal lymph sac 5 drops of a 1 per cent solution of veratrine sulphate or acetate. After a few minutes test for symptoms of veratrine poisoning by pinching the foot from time to time.

Soon the mechanical stimulation will be followed by prolonged contraction of the extensor muscles and still more prolonged relaxation.

Make a gastrocnemius muscle preparation. Fasten the muscle to a muscle lever and bring the writing point against a smoked drum. Record a single contraction.

Note the increased height of the phase of shortening, and the prodigious increase in the duration of the phase of relaxation. This contracture (page 203) is lessened by repeated stimulation, but reappears if the muscle be allowed to rest. Cooling or warming usually causes the veratrine effect to disappear temporarily.

A quick initial contraction may precede the characteristic veratrine contraction, possibly because the veratrine affects differently the red and the clear fibres.

#### TETANUS

**Superposition of Two Contractions.** — Arrange a gastrocnemius muscle to write on a smoked drum. Connect the binding posts on the muscle lever and muscle clamp with the secondary coil of an inductorium. In the primary circuit (posts 1 and 2) place the electromagnetic signal and the wheel interrupter. Let the drum revolve at a rapid rate. Send two maximal induction currents through the muscle at varying intervals, beginning with the shortest interval possible. The secondary should be at such a distance from the primary coil that both make and break currents shall cause contraction.

If the second stimulus fall in the latent period of the first contraction, the stimulus will be without effect. If the second stimulus fall between the beginning of shortening and the end of relaxation caused by the first stimulus, the contraction following the second stimulus will not begin from the base line, but will be superposed on the first, as if the state of shortening from which the second contraction begins were the resting stage of the muscle. The height reached by the

second contraction will be greater than that reached by the first. The summed height is usually greatest when the second contraction starts from the summit of the first, but this rule is not invariable. The summit of the summed contraction does not necessarily coincide with the summit of the second contraction; the higher the summed contraction, the quicker the summit is reached.

**Superposition in Tetanus.** — Repeat the preceding experiment, but use a series of stimuli instead of only two. It will be observed that a third contraction may be superposed on the second, a fourth on the third, and so on. The shortening of muscle, however, has a limit; and when this is reached, further stimulation merely maintains this maximum degree of shortening until fatigue sets in. Observe, too, that when the interval between successive stimuli is so brief that the period of shortening of each successive contraction begins before the shortening of the preceding contraction has ceased, the respective periods of shortening fuse together and the contraction curve becomes a continuous line. In addition to the proof just furnished that this apparently continuous single contraction is really a fusion of many individual contractions, the reader is reminded of the proof furnished by



the action currents in tetanus (page 168). The more rapid the contraction, the shorter must be the interval between successive stimuli in order to cause the phase of shortening of each contraction to fall in the shortening of the preceding contraction. Thus a more rapid rate of stimulation is necessary to produce complete fusion in fresh, highly irritable muscles than in those the irritability of which has been diminished by cold or fatigue. For this reason contractions which at the beginning of the stimulation period are marked by notches in the curve fuse completely as longer stimulation brings on fatigue. Here also the differences in the structure of muscles already mentioned play an important part. Thus the red muscles of the rabbit are thrown into tetanus by a much smaller number of stimuli per second than are the more quickly contracting white muscles.

**Muscle Sound.** — The discontinuous nature of tetanic contraction is further borne out by the sound given forth by contracting muscle.

1. Stop each ear with the finger and contract the muscles of the jaws.

A very low-pitched musical sound will be perceived. It apparently corresponds to the C of 32 vibrations or the D of 36. The experiment is best performed during the quiet of the night.

2. Stop the ears and contract the biceps of each arm.

The sound will again be heard. It is transmitted to the internal ear by sympathetic vibrations set up in the bones of the arm, shoulder, neck, and head.

3. Listen with a stethoscope to the sound of the masseter or the forearm muscles.

The mechanism of this sound was revealed by the observations of Helmholtz. Within limits, the sound obtained from a muscle in tetanus rises in pitch as the rate of stimulation increases. It may be assumed, therefore, that the muscle sound is the result of the periodic contractions of the muscle; in other words, that the voluntary contraction, since it gives rise to a sound, is a series of single contractions following each other at fairly regular intervals.

As the sound observed lies very near the lowest rate of vibration perceptible to the human ear, it may be suspected that it is not really the fundamental note, but an overtone, and this idea is confirmed by the following experiment.

4. Place a very thin easily vibrating reed in the jaws of a clamp. Fasten on the end a tinsel writing point. Bring the point against a smoked drum. Let a tuning fork write its curve beneath

the point. Set the reed vibrating and "spin" the drum. Count the vibrations. If they are not 18 per second, shorten or lengthen the reed until this rate is attained. Make a gastrocnemius preparation. Fasten the femur in the muscle clamp and pass a thread attached to the tendo Achillis around the base of the vibrator. Connect the two ends of the muscle with the secondary coil of an inductorium. To the armature of the electromagnetic signal turned upside down fasten a straw 36 centimetres long. About 22 centimetres from the magnet, pass vertically through the straw a platinum wire connected by a very thin wire with one of the binding posts of the magnet. Connect the other binding post with post 1 of the inductorium. Place the magnet so that the platinum wire shall touch the surface of the mercury in the mercury cup when the straw vibrates. Connect this cup through a simple key and a dry cell to post 2 of the primary coil. On closing the key, the straw will be kept in continued vibration. The rate should be brought to 18 per second by varying the length of the straw. Now start the interrupter and open the short-circuiting key of the secondary coil.

The muscle will fall into tetanus. The discontinuous nature of the tetanus will be shown

by the vibration of the reed at the rate of 18 per second, corresponding to the number of stimuli per second.

It also appears from this experiment that the note of about 36 vibrations per second heard on auscultating a contracting muscle is not the fundamental tone itself, but the first overtone of the muscle sound.

5. The pitch of the sound heard when a muscle is thrown into tetanus by stimulating the spinal cord is to a considerable extent independent of the rate of stimulation.

Lengthen the vibrating reed used in Experiment 4 by moving it out from the jaws of the clamp, so that the reed shall vibrate about 10 times per second.

Expose the vertebral column in a frog the brain of which has been destroyed (page 132). Strip the skin from one leg. Free the lower end of the gastrocnemius muscle by severing the tendon. Raise the muscle so that it may be attached to the under side of the vibrating reed mentioned in Experiment 4, but be careful not to injure the nerve. Insert needle electrodes between the vertebræ and connect them with the secondary coil of an inductorium arranged for tetanizing currents (posts 2 and 3). Stimulate the muscle.

The reed will again be thrown into sympathetic vibration, although the number of stimuli is about 100 per second.

With the aid of the interrupter described in Experiment 4 stimulate the spinal cord at the rate of 18 per second.

The vibrations during tetanus will be stronger. Helmholtz found that they were strongest at 18 stimulations per second, from which he concluded that voluntary tetanus was occasioned in the frog by the discharge of 18 motor impulses per second from the motor cells in the cord. Later observers have found a lower rate. The exact frequency is relatively unimportant in comparison with the main fact that the motor cells have a certain optimum rate of discharge.

Neither direct nor indirect stimulation with currents of very high frequency (about 2500 or more per second) causes tetanus; at the most, these currents cause only a twitch at the beginning of stimulation.

**Relation of Shortening in a Single Contraction to Shortening in Tetanus.** — 1. Record side by side the contractions of a muscle unloaded except by the muscle lever. Stimulate with a single maximal induction current; stimulate with a brief tetanizing current.

The shortening of the single twitch of the un-

loaded muscle is as great as the shortening in tetanus.

2. Load the muscle with ten grams and repeat Experiment 1.

The shortening in tetanus will now be considerably greater than that of the single twitch.

3. Load the muscle with ten grams but support the weight by the after-loading screw, so that the weight cannot pull on the muscle until the contraction begins. Record one contraction on a stationary drum in response to a maximal make induction current. Turn the drum one millimetre. Raise the writing point of the lever one millimetre by means of the after-loading screw. Stimulate the muscle with a make induction current of the same intensity as before. Again turn the drum and raise the point of the lever one millimetre, and stimulate the muscle as before. Continue this until the after-loading screw is raised so high that the muscle no longer shortens sufficiently to raise the lever.

Obviously in this experiment the weight is artificially supported during a progressively greater portion of the contraction. It will be found that the total shortening of the muscle loaded only during the latter portion of the contraction is as great as the shortening of a loaded muscle in tetanus. These experiments suggested to von

Frey an explanation of the greater shortening of tetanized muscle as compared with the shortening of the single contraction. The early contractions in tetanus may support the load and thus favor the succeeding contractions just as the artificial support through the earlier stages of the single contraction increases the height to which the load is lifted in the later stages.

It is possible, in muscles made up of both quickly and slowly contracting fibres, that the continued shortening of tetanus may be due to the contraction of different sets of fibres. As the contraction of each new group is added to the rest, the muscle shortens more and more. Grützner points out that the long-continued contraction of the fibres rich in sarcoplasm may be supposed to furnish the "support" required by the hypothesis of von Frey. It is difficult, however, to explain in this way the tetanus observed in muscles composed almost wholly of quickly contracting fibres.

#### THE ISOMETRIC METHOD

Thus far we have observed the development of energy in a muscle stretched by a small unvarying load. The principal part of the energy set free in this *isotonic* process appears as the mechanical energy of a visible change in form ;

a small part of the energy of the muscle is converted into tension. Fick has pointed out that if the muscle be made to pull against a strong spring, the change in the length of the muscle will be very slight and the greater portion of the energy will be converted into tension and stored in the spring. If the excursion of the spring be recorded by a writing lever, the curve will be practically a record of the course of transformation of energy into tension, and will be only to a slight extent the record of a change in form.

In order to determine the amount of energy converted into tension in the isometric contraction, it is necessary to graduate the spring against which the muscle pulls.

**Graduation of Isometric Spring.** — To the strong spring of the apparatus shown in Fig. 48, is attached a vertical bar on which rests the writing lever. To the lower end of this bar attach the large scale-pan. Place a long straw on the lever. Bring the writing point against the smoked paper of a kymograph. Turn the drum once round to record an abscissa. Return the drum to its former position, and place 100 grams in the scale-pan attached to the spring. When the spring is stretched turn the drum once round to record the bending under 100 grams' weight. Restore the drum to its former position, add 100



grams, and make record of the extension at 200 grams. Continue the record up to 1000 grams. Preserve the curve for reference (page 229).

**Isometric Contraction.** — Fasten the femur of a gastrocnemius preparation in the muscle clamp, and the Achilles tendon to the bar connecting the lever with the spring. Connect the binding posts on the lever and the clamp with the secondary coil of the inductorium, arranged for single maximal induction currents. Remove the straw from the lever and bring the usual writing point of the lever (which is arranged for vertical writing), against a freshly smoked surface. Let the drum revolve at a rapid speed. Stimulate the muscle with a maximal break current.

An isometric contraction will be recorded.

Remove the bar between the spring and the writing lever, and attach the tendon to the lever itself. Stimulate the muscle with a break induction current of the strength used before.

The usual isotonic curve will be written. Comparison of the isometric and isotonic curves reveals as a rule in the isometric curve a longer phase of rising energy and a flattened summit or plateau. The muscle reaches its maximum tension sooner than its maximum shortening and maintains the maximum tension longer than the maximum shortening.

## CONTRACTION OF HUMAN MUSCLE

**Simple Contraction or Twitch.** — Place the middle, ring, and little fingers in the support of the ergograph (Fig. 50). Let the adjustable rod rest on the index finger near the distal end of the middle phalanx. Place the point of the rod in the hole nearest the free end of the spring.

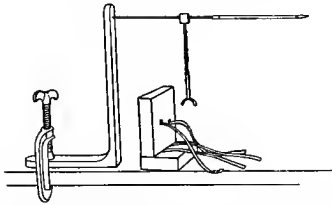

Fig. 50. The ergograph; also employed for recording the isometric and isotonic contractions of human muscle.

Adjust the writing point to write on a smoked drum revolving at moderate speed. With the brass electrodes covered with wet cotton (page 91), stimulate the abductor indicis with a single maximal break induction current. Compare the form of the curve thus obtained with the contraction curve of the skeletal muscle of the frog.

**Isometric Contraction.** — Place the point of the adjustable rod in the hole nearest the cast-iron support of the spring. The movement of the spring is so much less at this point that almost none of the energy of the muscle will be converted into mechanical motion. Stimulate the muscle as before with a maximal break induc-

tion current. Compare the isometric curve thus recorded with the largely isotonic curve previously obtained.

**Artificial Tetanus.** — Replace the adjustable rod in its former position (isotonic arrangement). Stimulate the abductor with the tetanizing current of the inductorium. Compare the curve with the tetanus of frog muscle.

**Natural Tetanus.** — 1. Contract the abductor by voluntary impulse. This also gives a tetanus curve (page 212). When the natural tetanus is prolonged, it frequently is marked by oscillations having a periodicity of about ten per minute.

2. Place the adjustable rod in the hole nearest the iron support (isometric arrangement). Stimulate the muscle (1) with the tetanizing current of the inductorium; (2) by voluntary impulse.

It will be seen that the energy set free by the natural stimulus is much greater than when the muscle is stimulated artificially.

### SMOOTH MUSCLE

**Spontaneous Contractions.** — Make two cuts, 5 mm. apart, through the frog's stomach at right angles to the long axis. Pass a bent hook through the ring (*i. e.* through the cavity of the stomach), and fasten the hook in the muscle

clamp. Pass a second hook around the lower margin of the ring and attach it by means of a fine copper wire to the straw of the heart lever (Fig. 42). Contraction of the circular fibres can thus be made visible. Bring the writing point against a drum revolving about once an hour. Wrap filter paper saturated with normal saline solution about the muscle ring. Keep this thoroughly moist. Proceed to the remaining experiments, observing the stomach preparation from time to time.

Spontaneous rhythmic contractions will appear. Note the changes in tonus.

**Simple Contraction.** — Prepare a second ring of frog's stomach in the manner described in the preceding experiment. Attach the lower margin of the ring to the muscle lever by means of a fine copper wire. Carry the end of the copper wire to the binding post on the muscle lever. Connect this post and the post on the muscle clamp with a dry cell, interposing a simple key. Place the electromagnetic signal in the primary circuit. Bring the writing points of the muscle lever and the signal against a smoked drum in the same vertical line. Arrange a tuning fork with its writing point in this line also. Let the drum move at rapid speed. Set the tuning fork vibrating. Stimulate the muscle by

making and breaking the galvanic current once, not oftener.

Compare the duration of the latent period with that of skeletal muscle. Compare the form of the contraction curve with that of skeletal muscle.

**Tetanus.** Determine how frequent the stimuli must be in order that the separate contractions may be fused into a smooth curve.

Usually the muscle after contracting loses its irritability for several minutes. If this occur, the ring may be laid aside, covered with filter paper saturated with normal saline solution. Excellent curves are often obtained from muscle preserved in this way for half an hour or more.

### THE WORK DONE

**Influence of Load on Work done.**— In the tracings obtained in the experiments on page 205 with loads of 10 grams and upwards measure the distance from the summit of each curve to the abscissa. Calculate the gram-millimetres of work done at 10, 30, 50, 70, and 90 grams, using the formula  $W = \frac{wh}{m}$  in which  $W$  is work done, in gram-millimetres;  $w$ , the weight lifted in grams, — *i. e.* the weight of the scale-pan and lever (about 12 grams) plus the weight put into

the scale-pan (the weight of the muscle itself may be neglected);  $h$ , the height, in millimetres, to which the load is lifted;  $m$ , the magnification of the lever.

Write the results on the smoked paper.

Note that within wide limits an increase in the load increases the work done by the muscle.

**Absolute Force of Muscle.** — Secure the femur of a gastrocnemius muscle preparation in a muscle clamp and fasten the tendon to the rigid muscle lever. After-load the muscle until it just fails to lift the load when stimulated with tetanizing induction currents.

The load which neither extends a contracting muscle nor allows it to shorten is a measure of the “absolute force” of the muscle.

**Total Work done; the Work Adder.** — Attach a scale-pan to the cord that passes over the pulley on the axle of the work adder (Fig. 51). Clamp the work adder to the wooden stand in such a way that the scale-pan hangs free of the table. Fasten the tendon of the gastrocnemius muscle preparation to the lever at a distance from the axis of the pulley equal to the radius of the pulley. Connect the binding post on the work adder and that on the muscle clamp with the secondary coil of an inductorium arranged for single maximal induction currents. Move the

sliding weight on the lever to such a point that this weight and that of the lever itself will together suffice to extend the muscle to its original length after the contraction of the muscle in response to a single induction current. Bring

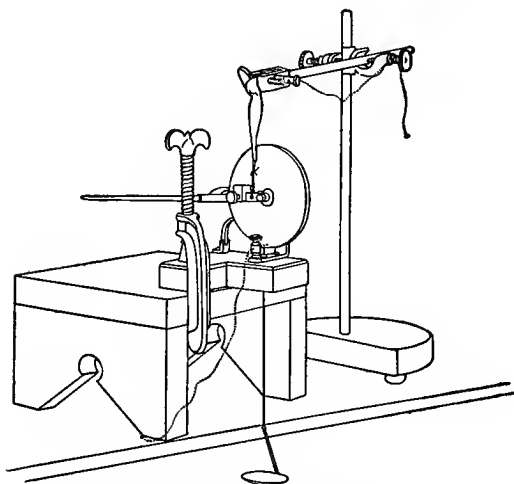

Fig. 51. The work adder; (the wheel is of hard wood).

the writing point of the lever against a drum arranged to revolve very slowly. Measure the distance of the pulley weight from the level of the axis of the pulley. The muscle now is loaded with the lever (approximately 20 grams) and after-loaded with the pulley weight (50

grams), 70 grams in all. Stimulate the muscle with induction currents at intervals of one second until the fatigued muscle ceases to contract. (Stimulation may be made by opening and closing a simple key in the primary circuit in unison with the beat of a metronome.)

Measure the height in millimetres to which the pulley weight has been lifted. Multiply this height by the sum of the pulley weight plus the weight of the lever. The product is the total work done in gram-millimetres.

**Total Work done estimated by Muscle Curve.** — The total work done by the muscle may also be estimated by measuring in millimetres the height of each successive contraction recorded on the smoked paper, adding the several heights together, dividing the sum by the number of times the distance from the fulcrum of the recording lever to the point of attachment of the muscle is contained in the distance from the fulcrum to the writing point, and multiplying this quotient by the sum of the pulley weight plus the weight of the lever.

In tetanus no weight is raised and no visible mechanical work is performed. That internal work is performed is shown by the rise in temperature.

**Time Relations of Developing Energy.** — The



simple muscle curve is a graphic record of the mechanical energy set free by the muscle in lifting a certain load. It is desirable to measure the maximum energy that the muscle can set free at each moment from the beginning of contraction to the point at which the greatest shortening is reached.

Place the electromagnetic signal in the primary circuit of an inductorium arranged for maximal make induction currents. Arrange a tuning fork to write on a smoked drum beneath the line drawn by the writing point of the signal. Fasten the femur of a gastrocnemius muscle in the muscle clamp and attach the tendon to the rigid muscle lever. Place the three writing points in the same vertical line. Connect the binding posts on the muscle clamp and the lever with the posts of the secondary coil of the inductorium. "After-load" the muscle with 50 grams. Set the tuning fork vibrating. Spin the drum. Stimulate the muscle with a single maximal make induction current.

The muscle will not shorten until the energy set free is sufficient to lift a load of 50 grams. Turn the drum until the writing point of the signal rests in the line made by the signal when the muscle was stimulated. Let the drum be stationary. Set the tuning fork vibrating. Its

writing point will mark a line synchronous with that drawn by the signal during the experiment. Revolve the drum a little farther, until the writing point of the muscle lever reaches the point at which contraction began. Set the tuning fork vibrating again. Its writing point will mark a line synchronous with the beginning of contraction. The number of vibrations in the tuning fork curve between the two points just recorded is the interval between the stimulation of the muscle and the point at which the energy set free was sufficient to move a load of 50 grams. Note this interval.

After-load the muscle with 100, 150, 200, 250, and 300 grams, and repeat the above experiment after each addition of 50 grams.

On coordinate paper set down as ordinates the several loads employed and along the abscissa the time intervals in hundredths of a second. Place a dot at the junction of the 50-gram line with the perpendicular cutting the abscissa at the figure indicating the interval observed between stimulation and the moment when the energy developed sufficed to raise the load. Repeat this with other loads. Join the dots. The resulting line is a curve showing the absolute force of the muscle at successive intervals from the beginning to the end of the phase of rising energy.

Record with this same muscle an isometric contraction (page 219). With the aid of the graduation scale of the isometric spring ascertain the maximum tension developed in the isometric contraction. Compare this result with that secured in the experiment just concluded on the time relations of developing energy.

### ELASTICITY AND EXTENSIBILITY

**Elasticity and Extensibility of a Metal Spring.** — Clamp the ergograph (Fig. 50) to the table in such a way that the writing point of the ergograph spring shall rest against a smoked drum. Attach a scale-pan to the spring near the free end. Turn the drum once round by hand, thus describing an abscissa on the smoked paper. With the forceps place 2 ten-gram weights very carefully on the scale-pan.

The spring extends. Turn the drum 2 mm. and add another 20 grams to the scale-pan.

A further extension of the spring will be recorded.

Turn the drum 2 mm. again. Continue to record the extension of the spring after each addition of 20 grams until a load of 200 grams has been reached.

It will be found that the extension curve is a

straight line. The extension is directly proportional to the weights employed.

Remove the weights 20 grams at a time, turning the drum 2 mm. after each lightening.

The spring will return to its former length. Its elasticity (within the limits of extension here used) is perfect.

**Of a Rubber Band.** — Place the muscle clamp in the stand of the rigid muscle lever (Fig. 48). Secure a rubber band in the jaws of the clamp and fasten the other end of the band to the muscle lever. Repeat the preceding experiment, using 10-gram loads instead of 20-gram loads.

The extension curve will again be a straight line. The return to the original length will not be complete. The elasticity of the rubber band is not perfect. An "extension remainder" is present. After a considerable time the extension remainder will disappear and the band will return to its former length, provided the extension was not too violent nor too long-continued.

**Of Skeletal Muscle.** — Isolate in both limbs the mass of long, parallel-fibred muscles extending along the inner side of the thigh from the pelvis to the tibia. Separate from the remainder of the pelvis the portion to which the muscles of both sides are attached. Remove the muscles of both

sides together with the part of the tibia and the pelvis in which they are inserted. The muscles of the two sides thus form practically one long muscle held together in the middle by the small piece of bone into which they both are inserted (Fick's preparation, Fig. 48).

Repeat the preceding experiment, using this preparation in place of the rubber band.

The extension curve is no longer a straight line, but approximately a parabola. In organic bodies, the increase in length is not proportional to the extending weights, but grows smaller as the weight increases.

A perfectly fresh muscle weighted lightly (*e. g.* 10 grams) usually returns to its original length when the extending weight is removed. With larger weights, the return is not at first complete: an extension remainder is observed, and the original length is reached only after a considerable time.

**Extensibility increased in Tetanus.** — With the gastrocnemius muscle (unloaded except by the writing lever and scale-pan) draw an abscissa (1) with the muscle at rest; (2) with the muscle tetanized. These abscissæ record the length of the practically unloaded muscle in the resting and the active states. Place 10 grams in the scale-pan and again record the length of the

muscle (1) at rest; (2) tetanized. Make similar records for each 10 grams up to 100.

It will be found that the extension curve falls more rapidly in the active than in the resting muscle; the extensibility is increased in tetanus.

### FATIGUE

**Skeletal Muscle of Frog.**—1. Let a gastrocnemius muscle loaded with 50 grams write its contractions on a very slowly moving drum. Connect the secondary coil with the binding posts on the muscle clamp and the muscle lever. Stimulate the muscle once in two seconds with a maximal induction current, using make and break currents alternately. The correct interval may be obtained by listening to the beat of a metronome. Continue to record the contractions until the muscle will no longer shorten when stimulated (exhaustion).

State the characteristic features of the fatigue curve.

2. With a fresh muscle repeat the stimulation every two seconds until the height of contraction has diminished about one half. Now record the duration of the latent period, phase of rising energy, and phase of sinking energy (page 197) on a rapidly moving drum.

Note the absolute and relative duration of these periods as compared with those of muscle not fatigued.

3. Stimulate a sartorius from the same frog continuously with tetanizing currents and record the tetanus curve.

State the differences between the fatigue curve thus secured and the curve obtained by less frequent stimulation.

Attention has already been called to the differences which depend on the relative proportion of red and clear fibres (page 199). The latter are more easily fatigued.

**Human Skeletal Muscle.** — 1. Arrange the ergograph to record the contractions of the abductor indicis, as directed on page 220. Place the point of the adjustable rod in the hole nearest the free end of the spring.

Prepare also the large and small brass electrodes for artificial stimulation of the muscle and place them in position.

Bring the writing point against a very slowly moving drum. Contract the muscle voluntarily every two seconds, keeping time with the beat of a metronome, until two hundred contractions have been made.

Now stimulate artificially every two seconds, using maximal make and break currents

alternately, until two hundred contractions have been made.

State the characteristics of the two fatigue curves, and compare the curves with those obtained from frog's skeletal muscle.

2. From a fresh subject obtain a fatigue curve by artificial stimulation of the abductor indicis, using maximal make and break induction currents alternately every two seconds, as directed in the preceding experiment. When the muscle has been stimulated two hundred times, contract it voluntarily every two seconds until two hundred contractions have been made.

Compare the curves with those obtained in Experiment 1.

Explain these paradoxes.

It has been pointed out on page 223 that smooth muscle loses its irritability much more rapidly than striated muscle.

#### APPARATUS

Normal saline. Bowl. Towel. Pipette. Glass plate. Volume tube. Bunsen burner. Inductorium. Two dry cells. Wires. Muscle clamp. Fine copper wire. One hundred ten-gram weights. Muscle lever. Electromagnetic signal. Kymograph. Tuning fork. Cork clamp. Four needle electrodes. Pole-changer. Pin. Cork. Two stands with clamps. Ten one-gram weights. Muscle-warmer. Split shot. Ice. One per cent solution of



veratrine acetate. Wheel-interrupter. Vibrating reed. Straw 36 cm. long with platinum contact. Mercury cup. Rigid muscle lever. Spring ergograph with rod. Hand clamp. Ergograph clamp. Large weight pan. Cotton. Two bent hooks. Heart-holder. Filter paper. Simple key. Work adder. Co-ordinate paper. Rubber band. Metronome.



## PART II

### THE CIRCULATION OF THE BLOOD



## PART II

### THE CIRCULATION OF THE BLOOD

#### IX

##### THE MECHANICS OF THE CIRCULATION

THE spaces between the cells of which the body is composed are filled with a liquid called the lymph, from which the cells take their food and into which they pour their waste. The materials and the products of metabolism diffuse from lymph to cell and from cell to lymph. In animals in which the division of labor has produced separate organs for digestion, excretion, and the like, the lymph serves as a medium of exchange. For this purpose the relatively slow processes of diffusion are not sufficient. Food must be more rapidly brought and waste more rapidly removed. A circulation must be provided. There are many ways in which the necessary circulation is secured. In Cyclops a flow is caused by movements of the alimentary

canal. In *Daphnia*, the lymph enters a hollow muscle and is then expelled. In the higher animals the provision for rapid exchange is two-fold. The intercellular spaces are traversed by a countless number of tubes of capillary size, the walls of which are so thin that substances in solution pass through them with great ease. These capillaries are the ultimate branches of a single tube, and, after fulfilling their function, the capillaries unite into a single tube again. A closed system is thus formed. This system is filled with a modified lymph called the blood, which is kept in constant circulation. Thus the lymph in the intervascular spaces is in intimate contact with a continually changing liquid. Further provision for rapid exchange is found in the circulation of the lymph itself. The spaces between the cells are drained by channels which gradually become definite tubes, the lymphatics, and these finally join to form two ducts which empty into the blood vessels.

The unbranched portion of the vascular tube is dilated into a cavity with thickened muscular walls termed the ventricle of the heart. The ventricle contracts rhythmically. Each contraction raises the pressure in the ventricle until it is higher than the pressure in the remaining blood vessels. The blood in the ventricle is thereby

forced into the blood vessels against the resistance of friction. The high pressure in the ventricle during contraction is transmitted into the blood vessels and through them. At each cross-section of the vascular system some of the pressure is lost in overcoming resistance; hence the pressure gradually falls. The blood flows from the area of higher pressure, near the ventricle, to the area of lower pressure. Thus the contractions of the ventricle establish a difference of pressure in the blood vessels, which causes a movement of the contained liquid.

At the two points at which the vascular tube joins the ventricle membranous valves are placed. One of these valves opens into the ventricle. It is an inflow valve. The inflow valve closes when the ventricle contracts. Consequently the contractions cannot drive the blood through this orifice. The ventricle can drive the blood only through the remaining orifice. Thus the ventricle becomes a pump and its contractions move the blood always in one direction. The vessels by which the blood is carried from the ventricle to the capillaries are called arteries; those which bring the blood from the capillaries back to the ventricle are called veins. Adjoining the ventricle the great veins meet in a common enlarge-

ment called the auricle. It is at the junction of the auricle with the ventricle that the inflow valve is placed.

The outflow valve is placed at that orifice of the ventricle which opens into the arteries. When the ventricle, having by its contraction raised the pressure in the arteries, begins to relax, the pressure within its cavity becomes less than that in the arteries. The outflow valve then shuts. Otherwise the arteries would be placed in direct communication with an area of low pressure and the relaxation of the ventricle would undo in part the work of the contraction, the purpose of which was the creation of a pressure in the arteries great enough to force the blood through all the blood vessels.

It is obvious from these general considerations that the problems of the circulation are in the first instance those presented by any system of closed tubes through which liquid is driven by a pump.

#### THE ARTIFICIAL SCHEME

The artificial scheme (Fig. 52) to illustrate the mechanics of the circulation in the highest vertebrates consists of a pump, a system of elastic tubes, and a peripheral resistance. The inlet and the outlet tubes of the pump are provided with



valves that permit a flow in one direction only. Between the pump and the outlet valve is a side branch leading to a membrane manometer which records the changes in the pressure within the pump (the loss in conveying the pressure through short wide tubes filled with water may be neg-

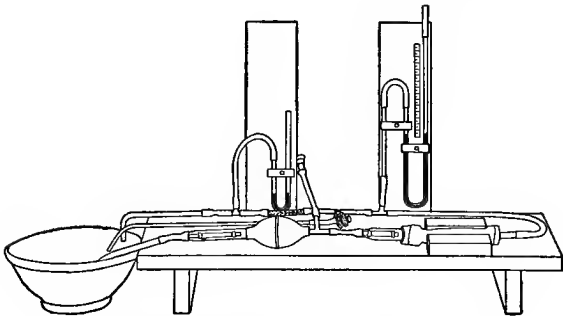

Fig. 52. The artificial scheme of the circulation.<sup>1</sup>

lected). The peripheral resistance consists chiefly in a great number of minute channels formed by the interstices between shot in a glass tube. To this must be added the slighter resistance due to friction in the tubes. A mercury manometer is placed between the pump and the capillary resistance, and a second manometer on the distal

<sup>1</sup> The rubber tube on the distal limb of the arterial manometer is filled loosely with cotton to prevent the mercury being driven out by the undue compression of the bulb.

side of the capillary resistance. A side branch which opens between the capillary resistance and the pump permits the discharge from the pump to flow out of the system without passing through the capillary resistance.

In this system the pump represents the left ventricle; the valves in the inlet and outlet tubes the mitral and aortic valves, respectively; the resistance of the shot the resistance of the small arteries and capillaries. The tubes between the pump and the resistance are the arteries; those on the distal side of the resistance are the veins. The side branch substitutes a wide channel for the narrow ones and thus is equivalent to a dilatation of the vessels. The mercury manometer on the proximal side of the resistance measures the arterial pressure; that on the distal side the venous pressure. The membrane manometer, inserted on the ventricular side of the aortic valve, records the time-relations of the intraventricular pressure curve.

#### THE CONVERSION OF THE INTERMITTENT INTO A CONTINUOUS FLOW

When a pump forces water or any other incompressible fluid through tubes with rigid walls, the inflow and outflow are equal and in the

same time. The outflow ceases the instant the inflow ceases. The same is true in a system of elastic tubes so short and wide that friction between the liquid and the walls causes practically no resistance to the flow. Here the quantity received from the pump can still escape from the distal end of the system during the stroke of the pump. When the resistance is increased by narrowing the tubes, or by increasing their length, or in both these ways, not all the liquid received from the pump can pass by the resistance during the stroke of the pump, — the remainder must pass during the interval between one stroke and the next. The portion which cannot pass during the stroke finds room between the pump and the resistance in the dilatation of the containing vessels. To effect the dilatation the force or pressure transmitted from the pump presses out the vessel walls until this pressure is held in equilibrium by the elastic reaction of the walls. As the pressure from the pump wanes, the energy stored by it in the tension of the vessel walls is reconverted into mechanical motion, and the walls return towards their original position, driving the liquid out of the tube past the resistance.

1. Open the side branch by unscrewing the pressure-clip. See that the tubes are well filled

with water. Make a single brief gentle pressure on the bulb.

Note (1) that practically all the liquid driven out by the stroke escapes through the side branch, in which the resistance is low, rather than through the high capillary resistance. (2) Only a portion of the liquid escapes during the stroke. (3) The portion which cannot escape by the resistance during the stroke finds space in a very evident dilatation of the tubes nearer the pump, *i.e.* between the pump and the principal resistance. (4) The membrane manometer shows a sudden rise and fall indicating a sudden rise and fall in the intraventricular pressure. (5) Close observation shows that on the stroke of the pump the tubing just distal to the aortic valve begins to expand sooner than that farther away. Evidently the change of pressure produced by the stroke of the pump is transmitted from point to point through the liquid in the tubes. (6) The arterial manometer shows a sudden rise and fall. Observe that the rise is not synchronous with the stroke of the pump, but begins an instant later. This interval is occupied by the transmission of the pressure change from the pump to the mercury column, and in part by the time required to overcome the inertia of position of the mercury. The oscilla-

tions of the mercury following the primary rise and fall are due to inertia. (7) Observe the action of the valves (they consist of a glass tube, closed at one end, and pierced with a hole which is covered with a rubber flap tied on both sides of the hole). (8) Place a finger on the "aorta" near the valve and note the pressure wave (pulse) as it passes along the vessel.

2. With the side branch open as in Experiment 1, compress the bulb rhythmically and gradually increase the frequency of stroke.

It will be found that at about twenty strokes to the minute the stream will be intermittent. As the interval between the strokes is shortened the liquid received from the pump in any one stroke cannot all escape by the resistance during the stroke and the succeeding interval. The next stroke comes before the outflow from the preceding stroke is finished, and the stream becomes remittent.

Still further increase the frequency of the stroke. A rate will be reached at which one-half the quantity received from the pump will pass by the resistance during the stroke of the pump and the remaining half will pass in the interval between that stroke and the next; the intermittent will be converted into a continuous flow.

Observe that the duration of the intervals is greater than the duration of the strokes of the pump. Thus the time during which the circulation is carried on by the energy stored by the pump in the elastic walls of the vessel is greater than the time during which it is carried on by the direct stroke of the pump.

Note that the arterial pressure remains low even after the stream becomes continuous. An increase in the frequency of the beat has little influence on the blood pressure where the peripheral resistance is very slight.

3. Close the side branch, so that the liquid must pass through a high peripheral resistance. Compress the bulb at such a rate that the outflow shall be continuous.

The frequency required to make the flow continuous is now much less than when the peripheral resistance was low.

#### THE RELATION BETWEEN RATE OF FLOW AND WIDTH OF BED

In a frog slightly paralyzed with curare destroy the brain by pithing, with the least possible loss of blood. Lay the frog back down on the mesentery board. Open the abdomen in the median line. Draw the intestine over the cover glass

upon the cork ring so that the mesentery may lie upon the glass evenly and without stretching. The mesentery must be kept constantly moist with normal saline solution. Examine the blood vessels in the mesentery with No. 3 Leitz objective.

Note the swift flow in the larger vessels and the slow movement of the blood through the capillaries.

The combined cross-sections of the capillaries in the body are vastly greater than the cross-section of the arteries or the veins. The total quantity of blood passing in a unit of time through the arteries or veins and the capillaries is the same. If less passed through the capillaries than through the arteries, the capillaries would soon be gorged to bursting. If more, the arteries would soon be empty. As the quantity passing through the capillaries and the arteries and veins in a unit of time must thus be the same, it follows that where the combined cross-section of the channel or "bed" is small, the blood must flow faster than where the cross-section is large. A river rushes rapidly through a gorge, but moves sluggishly where meadow-lands afford a wider channel. Thus the blood flows with great velocity in the great arteries, less rapidly in their branches, and very slowly indeed in the capillaries, the com-

bined width of which is so great compared to that of the arteries. And as the capillaries unite into the smaller veins, and these into the larger veins, the combined cross-section or bed becomes ever smaller and the blood moves ever more swiftly. Were the slow passage of the blood in the capillaries due simply to friction, the blood would move still more slowly in the veins because the retarding influence of the friction in the veins would be added to that of the capillaries. There is an inverse relation between the rate of flow and the area of bed.

### THE BLOOD-PRESSURE

**The Relation of Peripheral Resistance to Blood-Pressure.** — Compress the bulb at a rate that will produce a continuous outflow.

With each successive stroke the portion of liquid unable to pass the resistance during the stroke and the succeeding interval is added to that left behind from preceding strokes. The arteries become more and more full. The arterial manometer registers a higher and higher pressure. At length the pressure ceases to rise. The mercury remains at a mean level broken by a slight accession at each stroke. The pump now merely maintains the constant high arterial pressure. This pressure suffices to drive through



the resistance during each stroke and the succeeding interval all the liquid received from the pump during the stroke.

The *venous pressure* remains very low. The capillary resistance (to which must especially be added the resistance of the smallest arteries) almost entirely exhausts the pressure in the arteries. Hence the sudden and profound difference observed between the arterial and the venous pressure. A second arterial manometer placed near the aorta would show that the loss of pressure between the ventricle and the smallest arteries is relatively slight.

The pulse is absent on the venous side of the resistance.

**The Curve of Arterial Pressure in the Frog.**—Expose the heart of a lightly curarized frog by the method given on page 75. Provide a fine cannula with a short piece of rubber tubing. Fill cannula and tube with one per cent sodic carbonate solution, and close the end of the tube with a small glass rod. Tie a ligature about one aorta as far as possible from the junction of the two aortæ. Knot the ends of the ligature together. Pass a second ligature beneath the same aorta, but do not tie it. Lift the vessel by the second ligature so that the vessel is constricted by lying across the thread. Between the two ligatures

open the aorta with sharp scissors and introduce the cannula. Fasten the cannula in place by means of the ligature. Place the frog-board on the wooden stand to bring the heart on a level slightly higher than the level of the mercury in the mercury manometer (Fig. 53). See that the proximal limb of the manometer is filled with one per cent sodic carbonate solution to the exclusion of air. Bring the

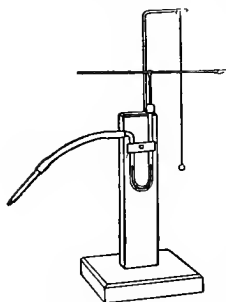

Fig. 53. The mercury manometer.

writing point of the manometer against a smoked drum and revolve the drum once by hand to record a line of atmospheric pressure. Close the aorta containing the cannula by gentle pressure with a forceps the blades of which are covered with rubber tubing. Join the cannula-

tube to the manometer, excluding air bubbles. Remove the forceps.

The mercury will fall in the proximal and rise in the distal limb until the blood-pressure in the aorta is balanced by the column of mercury. With each ventricular beat, the column rises a short distance above the mean level and sinks again.

Record the blood-pressure curve on a very

slowly moving drum. To get the actual pressure in millimetres of mercury multiply by two the mean height of the curve above the atmospheric pressure line.

**The Effect on Blood-Pressure of Increasing the Peripheral Resistance in the Frog.**—The peripheral resistance may be increased by the narrowing of the small arteries which follows the stimulation of special vaso-constrictor nerve fibres. The vaso-constrictor nerves may be stimulated directly or reflexly. The latter method is chosen here.

Expose the sciatic nerve. Tie a ligature about the nerve near the distal end of the wound, and sever the nerve on the distal side of the ligature. Stimulate the central end with a tetanizing current of moderate strength.

The afferent impulses set up by the stimulation proceed to the spinal cord and thence to the bulb, where they excite nerve cells which discharge impulses that cause the smaller arteries (and probably the veins) to constrict. This narrowing causes the arterial pressure to rise.

**Changes in the Stroke of the Pump; Inhibition of the Ventricle.**—While the arterial pressure in the artificial scheme is at a good height (120 mm. Hg) arrest the ventricular stroke (the ventricle in animals may be thus inhibited by stimulation of the vagus nerve, page 287).

So soon as the ventricle ceases to beat, the less distended arteries will empty themselves through the peripheral resistance, and the arterial manometer will show a continuous fall in blood-pressure.

Resume the ventricular beats.

The mercury in the arterial manometer will rise in large leaps, corresponding to the ease with which the early strokes of the pump distend the lax arteries (the inertia of the mercury somewhat exaggerates the rise at each stroke). As the blood-pressure rises, however, the excursion of the mercury for each ventricular stroke becomes less and less, corresponding to the smaller and smaller difference between the pressure in the arteries and the maximum pressure within the ventricle, until at length equilibrium is restored between the peripheral resistance and the force and frequency of the ventricular beat.

**The Effect of Inhibition of the Heart on the Blood-Pressure in the Frog.**— Arrange an inductorium for strong tetanizing currents. Insert the electromagnetic signal in the primary circuit and bring its writing point beneath that of the manometer. Raise the heart gently. Note the white "crescent" between the sinus venosus and the right auricle. Put the points of the electrodes on the crescent, and open the short-

circuiting key for a moment. After one or two beats the heart will stop.

Observe the great fall in blood-pressure. Cease the stimulation.

The mercury returns in leaps to its former level.

### THE HEART AS A PUMP

**The Opening and Closing of the Valves.** — Secure a high arterial pressure (120 mm. Hg) in the artificial scheme. Now greatly slow each ventricular beat and at once observe closely the action of the valves.

It will be seen that the mitral valve closes as soon as the ventricle begins to contract, but the aortic valve does not open until the intraventricular pressure has risen above that in the aorta. Time is required for this rise in the pressure in the ventricle. During this period both mitral and aortic valves are closed. When the ventricle begins to relax, the intraventricular pressure speedily falls below that in the aorta, and the aortic valve shuts, but the intraventricular pressure normally must fall at least 100 mm. Hg farther before it shall be lower than that in the auricle. During this fall all the heart valves are again closed; the aortic valves are already shut, and the mitral not yet open.

**The Period of Outflow from the Ventricle.**—Tie a rubber membrane over the smaller thistle-tube of the sphygmograph (Fig. 54) and cement a bone button in the centre. Prepare a second receiving tambour in the same way. Bring the writing points of the recording tambours into the same vertical line against a smoked drum. Let the

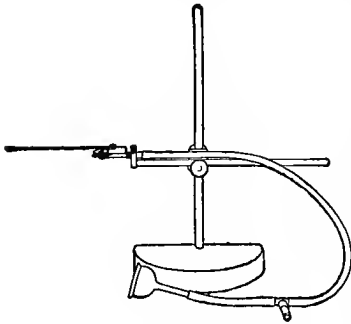

Fig. 54. The sphygmograph.

drum revolve at its fastest speed.

Place the button of one receiving tambour on the aorta, the other on the membrane of the tube which records the intraventricular pressure. Let

the ventricle pump with the usual force and frequency. When the two curves have been written, stop the clock-work and turn back the drum until the point of the lever recording the ventricular pressure lies at the exact beginning of the upstroke in the aortic pulse curve. Cause each lever to write an ordinate on the stationary drum. These ordinates will indicate synchronous points and will mark the beginning of the "outflow" period.

Now turn the drum until the point of the aortic lever lies beneath the notch seen in the down stroke of the pulse curve (the dicrotic notch, see page 274). Describe synchronous ordinates. It is known that the dicrotic notch in the aortic pulse curve corresponds closely to the moment of closure of the aortic valves. It marks, therefore, the end of the outflow period. Note that this point is reached soon after the ventricle begins to relax. Thus the period during which the intraventricular pressure is higher than the pressure in the aorta embraces part of the relaxation as well as part of the contraction of the ventricle. It includes approximately the highest third of the intraventricular pressure curve.

Observe also the considerable interval between the beginning of ventricular contraction and the opening of the aortic valve, as shown by the upstroke in the pulse curve consequent upon the entrance of liquid into the aorta.

**The Visible Change in Form.** — Expose the heart of a frog. Observe the great veins, the auricles, the single ventricle, the two aortæ, and the dilatation, or bulbus, by which the aortæ are connected with the ventricle. All these parts except the two aortæ are contracting. The veins contract first; the auricles next; then the ventricle;

last the bulbus. Note the pallor of the contracted, empty ventricle.

**Graphic Record of Ventricular Contraction.** — Set the heart-holder (Fig. 42) across the frog-board. Raise the heart gently with a seeker, and pass the spoonlike tongue of the holder beneath the heart. Fill the spoon with normal saline solution. Rest the upright of the straw heart-lever on the ventricle, but do not allow the weight of the lever to remain on the heart when it is not recording. Adjust the preparation so that the lever writes on a slow-moving drum.

Note the characteristics of the curve.

### THE HEART MUSCLE

**All Contractions Maximal.** — Find the least strength of stimulus that will cause the ventricle to contract. Increase the strength of the stimulus, but do not stimulate oftener than once in ten seconds (to avoid the staircase contractions described below).

The force of ventricular contraction will remain the same, notwithstanding the increased stimulus.

If the heart responds at all to a stimulus, it responds by a maximum contraction. There is no interval between the minimal and maximal value (compare page 138).



**Staircase Contractions.** — Find the least stimulus that will cause the ventricle to contract. Repeat this minimal stimulus every 5 seconds, recording the contractions on a drum turned about 5 mm. by hand after each contraction.

The contractions of the ventricle will be successively stronger, so that the apices of the curves will form an ascending line ("staircase"). The form of the staircase is always an hyperbola. Successively stronger responses to repeated stimuli of uniform strength can also be obtained from the curarized gastrocnemius of the frog, perfused with blood, and from mammalian and invertebrate muscles. The contraction appears to increase the irritability. Thus the same stimulus causes a greater contraction after a brief tetanus than before. Rossbach and Bohr have observed this after-effect continuing more than thirty minutes.

**The Isolated Apex; Bernstein's Experiment.** — Draw a ligature about the ventricle halfway between base and apex tightly enough to crush the tissues without wholly separating them. The anatomical continuity between the two halves of the ventricle will thereby be maintained, but the physiological continuity will be lost. Release the ligature.

The isolated "apex" as a rule does not con-

tract. The exceptions can probably be explained as the effect of a constant stimulus (see page 261).

The apical half of the normal ventricle contains no nerve cells. Consequently its failure to contract after its separation from the remainder of the heart would indicate that the adult heart muscle is incapable of spontaneous rhythmical contraction. It has been shown, however, that the "apex" of the mammalian heart will beat after its complete removal from the remainder of the heart, provided the circulation in the extirpated piece is maintained by supplying it with blood.

**Rhythmic Contractility of Heart Muscle.**—Further evidence of the rhythmic contractility of the heart muscle is found in the bulbus arteriosus.

Place very small pieces of the bulbus arteriosus in normal saline solution under the microscope.

They will contract rhythmically.

Histological examination shows that nerve cells seldom occur in the bulbus. It is scarcely credible that they are present in each of the small pieces seen contracting under the microscope.

**Constant Stimulus may cause Periodic Contraction.**—In a frog with ventricular apex isolated by Bernstein's ligature, compress one or both aortæ, thus raising the pressure in the ventricle.

The increased intracardiac pressure acts as a constant stimulus to the cardiac muscle and the hitherto inactive apex begins to contract again.

Thus a constant stimulus may discharge periodic contractions in a muscle habituated to periodic contractions (compare page 105); the galvanic current and chemical stimuli, such as delphinin, are further examples of constant stimuli which call forth rhythmic contractions of the heart muscle.

**The Inactive Heart Muscle still Irritable.** — Stimulate the inactive "apex" mechanically and with single induction shocks.

The apex, though incapable of spontaneous rhythmic contractions, is still irritable, and will respond by a single contraction to each stimulus.

**Refractory Period; Extra-Contraction; Compensatory Pause.** — Put the electromagnetic signal in the primary circuit. Connect the binding posts on the heart-holder to the secondary coil of the inductorium. Arrange the latter for single induction currents. Place the ventricle on the heart-holder. Send maximal make and break induction currents through the ventricle from time to time in each phase of the cardiac cycle.

Note that (1) the stimulus sometimes calls forth an *extra-contraction*; (2) at other times the stimulus causes no contraction, having fallen

into the ventricle during the period in which it is *refractory* towards stimuli; (3) the extra-contraction is followed by a pause, called the *compensatory pause* because it usually restores the rate of beat to that existing before the extra-contraction took place.

Using induction currents of equal intensity, find the limits of the refractory period and note them on the drum. Note also the point in the cardiac cycle at which the maximum extra-contraction can be obtained.

**The Transmission of the Contraction Wave in the Ventricle; Engelmann's Incisions.** — The action current of the heart is taken to be an expression of the excitation process, although the nature of the latter is not yet understood. It has already been shown (page 173) that the action current sweeps rapidly over the ventricle preceding the contraction. The excitation might be propagated by nerves or by muscle fibres. The following experiment affords some evidence that the transmission is by means of muscular tissue.

Leaving the heart *in situ*, cut the ventricle into a zigzag strip by obliquely transverse incisions beginning near the apex. The nerve fibres in the ventricle will thereby be severed at some part or other of their course, but muscular continuity will be preserved.

The contraction wave will pass over the entire zigzag strip. Normally the wave starts at the base and proceeds to the apex, but by artificial stimulation it can be made to pass from the apex towards the base. A similar result can be secured with the auricle.

**The Transmission of the Cardiac Excitation from Auricle to Ventricle; Gaskell's Block.** — The contraction wave can be seen to begin normally in the sinus and thence to pass rapidly over the auricle; on reaching the auriculo-ventricular junction there is a distinct pause termed the auriculo-ventricular interval; finally, the excitation reaches the ventricle, and the contraction wave is seen to traverse the ventricular muscle as noted above. The auriculo-ventricular interval may be lengthened by any natural or artificial hindrance to the passage of the excitation wave.

1. Place the screw-clamp about the auriculo-ventricular junction. Very cautiously turn the screw until the cork edge makes a gentle pressure on the cardiac tissues at that point.

With careful work a degree of pressure will be reached that diminishes the conductivity of the muscle fibres joining the auricle and ventricle so far as to permit only every second or every third excitation to pass. The auricle will beat with-

out change of frequency, but the ventricle will contract only when the excitation succeeds in passing the block.

2. Divide the auricles in two pieces connected by a small bridge of auricular tissue. Stimulate one piece.

The stimulation of one piece will be followed immediately by the contraction of that piece, and, after an interval, by the contraction of the other. The smaller the bridge, the longer the interval.

Gaskell has pointed out that a natural block is furnished by the small number of the muscle fibres joining the auricle to the ventricle, and that this natural block explains the auriculo-ventricular interval, *i. e.* the delay which the excitation experiences in passing from the auricle to the ventricle.

3. Repeat Experiment 1, but place the screw-clamp across the middle of the ventricle.

The passage of the excitation from one part of the ventricle to another will be delayed or interrupted by the lowering of the conductivity in the compressed portion.

Many irregularities in the frequency and force of the heart can be explained by variation in the conductivity of its several parts. They can be explained also by variations in the irritability of

the several parts. In the latter case, the excitation would pass as usual, but its action on any part, for example the ventricle, would be increased or diminished by changes in the irritability of the cardiac muscle in that region. Engelmann has found that ventricular systole lowers the conductivity of the ventricle for a time.

**Tonus.**—Counterpoise the muscle lever by placing weights in the weight pan suspended from the pulley. Pass the very fine copper wire through the wall of the auricle of the tortoise and attach the wire to the counterpoised muscle lever, so that the contractions of the auricle may be recorded. Let the drum move so slowly that the individual contractions will be nearly but not quite fused.

Two sorts of contractions can be distinguished, (1) the usual frequent contraction or beat of the auricle, (2) the tonus oscillations. The tonus oscillations include from twenty to forty beats. In the tortoise auricle, the beats usually become less extensive during the rise of tonus.

**The Influence of "Load" on Ventricular Contraction.**—Record the contractions of the frog's ventricle. Increase the intraventricular pressure (*i. e.* the load against which the ventricular muscle contracts) by clamping the aortæ with forceps

the blades of which are covered with rubber tubing.

The force of the individual contractions will be increased but their frequency will be diminished.

**The Influence of Temperature on Frequency of Contraction.** — Let the drum move at such a speed that the individual heart-beats in the curve shall be close together, but yet separate and distinct. By means of a pipette replace the normal saline solution in the spoon of the heart-holder with normal saline solution at 25° C.

The frequency of contraction will be increased.

Replace the warm solution with normal saline solution at 5 C.

The frequency of contraction will be diminished.

**The Action of Inorganic Salts on Heart Muscle.** — Sever the apical two-thirds of the ventricle of the tortoise heart from the remainder of the ventricle by a cut parallel with the auriculo-ventricular furrow. With a second parallel cut remove from the severed portion a ring two or three millimetres wide. Divide the ring to form a strip. Fasten one end of the strip to the short limb of a glass rod bent at a right angle. By means of a silk thread connect the other end of the strip to an inverted counterpoised muscle



lever arranged to record the contractions of the strip on a very slowly moving drum.

*Sodium.*—Immerse the strip of ventricular muscle in a beaker containing 0.7 per cent solution of sodium chloride.

After a latent period, which may be protracted, but usually is brief, a series of rhythmic contractions will be observed. The contractions soon reach a maximum and then gradually die away. Sodium, although an important stimulus to contraction, cannot maintain the ventricle in continued activity.

The tonus of the heart muscle is diminished by sodium chloride.

*Calcium.*—Surround a strip of contracting ventricular muscle with a solution of calcium chloride isotonic with 0.7 per cent sodium chloride solution (approximately 1.0 per cent).

Contractions will cease. Calcium added to solutions of sodium chloride, however, will lengthen the period during which the heart muscle contracts and will increase the strength of the individual contractions. Strong solutions of calcium chloride greatly increase the tonus.

*Potassium.*—Surround a non-beating strip of ventricular muscle with a solution of potassium chloride isotonic with 0.7 per cent sodium chloride solution (approximately 0.9 per cent).

Contractions will not be produced. If potassium be applied to a contracting strip, the contractions will cease.

*Combined Action of Sodium, Calcium, and Potassium.* — Surround the ventricular muscle with a solution containing sodium chloride (0.7 per cent), calcium chloride (0.0026 per cent), and potassium chloride (0.035 per cent). This is a modified "Ringer" solution.

Long-continued, rhythmic contractions will be secured.

Observers are not entirely agreed as to the action of potassium and calcium on heart muscle. The matter is of importance because there is much probability that the rhythmic contractions of the heart are the result of the constant chemical stimulus of inorganic salts present in the blood. Most observers are agreed that the interaction of salts of sodium, calcium, and potassium is essential.

The fact that the contraction of the heart begins normally in the sinus may be due to a greater sensitiveness of that part to chemical stimulation.

## THE HEART SOUNDS

With a binaural stethoscope auscultate the chest over its entire extent during normal respiration and while the subject holds his breath.

1. Note that two sounds are heard in the heart region.

2. Determine at what point each of the sounds is most distinct.

It will be found that one, termed the "first sound," will be most distinct where the ventricle comes nearest the surface, near the apex of the heart, in the space between the fifth and sixth ribs, about 2.5 cm. below and 2.5 cm. within the left nipple. Close inspection of this region in persons not too fat will show that the chest wall is raised at each contraction of the heart. The *cardiac impulse*, as it is called, may be felt distinctly by one or two fingers laid in the fifth intercostal space. It is caused by the rapid increase in the tension of the ventricle.

The "second sound" will be heard most distinctly immediately over the aortic arch, near the junction of the second right costal cartilage with the sternum.

3. Observe the two sounds with relation to their duration, pitch, intensity, and quality.

The first sound in comparison with the second is of longer duration, lower pitch, and greater intensity. The quality of the first sound is dull, booming; that of the second is sharp, valvular.

4. With one finger feeling the cardiac impulse observe the sounds with reference to systole and diastole.

The first sound will be found to be systolic, *i. e.* it occurs with the contraction of the ventricle, while the second sound is diastolic, being heard at the beginning of ventricular relaxation. The interval between the first and second sounds is therefore very brief. The pause after the second sound before the first is heard again, is considerably longer.

The first sound can be heard in the extirpated, bloodless heart (dog). The contraction of the ventricular muscle is therefore alone sufficient for its production. But the sound is modified or replaced by a murmur when the auriculo-ventricular valves are sufficiently injured. It is probable, therefore, that the sudden increase in the tension of the auriculo-ventricular valves contributes to its production. The second sound obviously is due to the sudden increase in the tension of the semilunar valves. It is replaced by a murmur when these valves are rendered incompetent.

Ordinarily the ratio between the blood-pressure in the pulmonary artery and right ventricle so nearly equals the ratio between the blood pressure in the aorta and left ventricle that the semilunar valves in the pulmonary artery and aorta close together, or nearly together, and their respective sounds are heard as one. Pathologically, for example in distention of the right heart from prolonged violent exercise, these relations may be so altered as to produce between the two sounds an interval perceptible to the ear. The sound is then said to be reduplicated.

#### THE PRESSURE-PULSE

**Frequency.** — Palpate the radial pulse by laying on the artery at the wrist the ball (not the tip) of the first, second, and third fingers of the right hand. The forearm of both subject and observer should be supported in a comfortable position. Count the pulse in four successive periods of fifteen seconds. The counting of the observer's instead of the subject's pulse may be avoided by noting whether the subject's supposed pulse is synchronous with the observer's heart-beat.

Note the frequency per minute when the subject is standing, sitting, lying, swallowing, holding the breath; and before and after exercise;

for example, before and after lifting the weight of the body ten times by rising on the toes.

Sex, eating, the time of day, the temperature, and many other factors also influence the frequency of the pulse.

**Hardness.** — When pressure is made upon an artery in any part of its course, the pressure is transmitted in all directions through the liquid contained in the peri-arterial tissues, and the artery becomes smaller. Part of the pressure is used upon the peri-arterial tissues themselves. When the remaining pressure equals the maximum blood-pressure in the artery at the point of compression, the blood-pressure on the distal side of this point will sink to the level of the blood-pressure in the nearest anastomosis. If the anastomosis is of capillary size, the pulse will disappear. A pulse which is obliterated by slight pressure is termed "soft;" if the pressure required is relatively considerable, the pulse is termed "hard." The hardness of the pulse is therefore a measure of the maximum blood-pressure at the point of compression, less the variable and unknown quantity required for the compression of the elastic tissues.

**Form.** — 1. The vibrations which follow the primary pulse wave cannot ordinarily be recognized by the palpating finger. When, however,

the usual amplitude of the principal secondary vibration is much increased and the interval between the primary and this secondary vibration is not too brief, the pulse may be felt to be double, or "dicrotic." For example, dicrotism can be felt in some cases of continued fever.

2. A pulse which is felt to reach its maximum slowly is called a "slow pulse" (*pulsus tardus*). One which reaches its maximum rapidly, giving the palpating finger the sensation of a quick push, is said to be a "quick pulse" (*pulsus celer*). Quick and slow pulses should be carefully distinguished from frequent and infrequent pulses.

**Volume.**—The extent to which the arterial wall is driven from its position of equilibrium (volume or size of pulse) is a function of the output of the ventricle, the outflow period, the peripheral resistance, and the elasticity of the arteries. It is measured very inexactly by the palpating finger and the sphygmograph, accurately by the plethysmograph (page 280).

**The Pressure-Pulse in the Artificial Scheme.**—Compress the pump of the artificial scheme until the arterial pressure is maintained at 50 mm. Hg. Close the tube leading to the arterial manometer, so that the oscillations of the mercury may not influence the curves to be taken. Attach the small thistle-tube (without

rubber membrane) to the sphygmograph (Fig. 54) and adjust the tube upon the aorta. Close the side branch of the sphygmograph tube. Bring the writing point of the sphygmograph lever against a slow-moving, lightly-smoked drum. Record a series of pulse curves.

Note the quick upstroke, corresponding to the quick distention of the artery by the emptying of the ventricle, and the gradual downstroke, corresponding to the gradual emptying of the artery through the resistance during the diastole or interval between two beats. Near the apex of the more delicately written curves may be seen a slight depression, the dicrotic notch.

It is obvious that the changes observed in the size of the artery are the expression of changes in the blood-pressure. The pulse is a function of the blood-pressure at the point observed. Hence the term pressure-pulse.

**The Human Pressure-Pulse Curve.** — 1. Adjust the lever of the recording tambour so that it shall write with the least friction possible on a thinly smoked drum. Let the drum revolve slowly (two revolutions a minute). Be sure that the side branch is open. Place the larger thistle-tube, which serves as a "receiving tambour," over the carotid artery, anterior to the sternocleidomastoideus muscle, about the level of the



thyroid cartilage. When the tambour (without rubber membrane) is pressed well down over the artery, let an assistant close the side branch. If the receiving tambour has been properly placed, the recording tambour will write a sharply marked pulse curve. If none such appears, open the side branch and move the receiving tambour into a better position.

Indicate the primary wave, the predicrotic elevation, and the dicrotic notch.

2. Cover the thistle-tube with a rubber membrane. Cement in the centre of the membrane a bone collar-button. Place the button upon the radial artery at the wrist and record the radial pulse.

It will be found that the degree of pressure must be carefully regulated in order to secure a satisfactory curve. The blood-pressure in the artery normally is held in equilibrium by the elastic tension of the wall of the artery and the surrounding tissues. The pressure of the sphygmograph increases the tension of the peri-arterial tissues and thus assists in holding the blood-pressure in equilibrium. The greater the pressure of the sphygmograph, the larger the part of the blood-pressure borne by it and the more completely will variations in the blood-pressure be made visible in the pulse curve. The record,

however, is not a measure of the absolute blood-pressure, because it is not possible to estimate accurately how much of the blood-pressure is still held in equilibrium by the elastic tension of the arterial wall and the surrounding tissues. The pulse curve does give with approximate correctness the variations in the blood-pressure. The correctness would be complete were it not that the part of the blood-pressure held in equilibrium by the elastic tension of the arterial wall varies with the size of the vessel, and the size of the vessel increases as the blood-pressure increases. Thus the portion of the blood-pressure which fails of record constantly varies. The error thus introduced is not important. The sphygmograph, therefore, gives a practically true record of the form of the pulse, *i.e.* the time-relations of the changes in blood-pressure. This knowledge cannot possibly be secured by the palpation of the pulse. The sphygmograph, it may be repeated, does not give a true record of the absolute blood-pressure (hardness) or of the amplitude (size) of the pulse. Both hardness and amplitude are better measured by the palpating finger.

In many sphygmographs, for example, Marey's and Dudgeon's, the pressure on the artery is made by a metal spring, the movements of which

are recorded by a lever. In the record just taken from the radial artery, the pressure was made by the elastic tension of the rubber membrane closing the thistle-tube. In the case of the carotid artery, this membrane is replaced by the skin of the neck.

In every instance, the sphygmograph records the changes of blood-pressure in a section of the artery so short in comparison with the length of the whole arterial tree as to be practically a cross-section.

**Low Tension Pressure-Pulse.** — 1. In the artificial scheme open slightly the side-branch that permits the liquid in the arterial tubes to flow out without passing through the resistance. The arterial pressure will fall in consequence of the diminished peripheral resistance. Normally this effect is produced by a dilatation of the smaller arteries. Let the arterial pressure fall to about 20 mm. Hg. Record a series of pulse curves.

Note that the oscillations of the mercury column with each ventricular beat are much higher than with normal pressure (120–150 mm.). Feel the pulse with the finger. With each beat the artery quickly expands and as quickly relaxes. The artery is “softer” than usual.

2. Feel the normal pulse in the radial artery. Note the normal “hardness.” Let the subject

inhale two drops (on no account more than two) of the nitrite of amyl (to be dropped on a handkerchief by one of the instructors). This powerful drug causes dilatation of the blood vessels, particularly the smaller arteries.

Observe that as the face flushes, indicating the vascular dilatation, the pulse will be softer.

Do not repeat the experiment.

**Pressure-Pulse in Aortic Regurgitation.** — Empty the principal tubes of the artificial scheme. Remove the rubber from about the aortic valve. Replace the valve tube. Fill the apparatus with water. Compress the bulb at the rate and with the force employed to imitate the normal circulation (page 273).

Feel the pulse with the finger.

After each systole the liquid streams back through the incompetent valve. The ventricle is thus fuller than normal at the beginning of the stroke, while the arteries are less than normally full. Consequently more than the usual quantity is discharged by the ventricle into relatively undistended arteries. The relatively lax artery is thereby quickly and largely expanded, as indicated by the quick thrust given the palpating finger and by the large excursion of the mercury in the arterial manometer.

Record pulse curves.

The upstroke is unusually high and quick. It is at once followed by a great and sudden fall. Obviously a relatively empty artery has been suddenly filled by an unusually large inflow and has been suddenly emptied again through the broken valve and the capillaries. The pulse-curve shows low arterial tension, but is of greater amplitude than the pulse in which low tension results from lowering the peripheral resistance. In the body, the amplitude of the pulse in aortic regurgitation is increased by the greater force with which the ventricle contracts, as well as by the larger quantity discharged at each beat, for the back-flow from the aorta dilates the ventricle and usually causes the walls of the ventricle to increase in thickness (dilatation with hypertrophy of the ventricle).

**Stenosis of the Aortic Valve.** — Replace the rubber flap upon the aortic valve-tube, and tie a string around the flap and tube just over the opening in the glass. Stenosis, *i. e.* narrowing, of the opening will thus be secured. Put the valve-tube in place, and compress the bulb at the usual rate. Record pulse curves.

The slow difficult emptying of the ventricle will be evident in the curve and to the hand. The movements of the arterial manometer are sluggish and of diminished amplitude. The

pulse wave is small and the upstroke slow, corresponding to the small slow inflow through the stenosed valve.

Restore the valve to its normal state.

**Incompetence of the Mitral Valve.** — Remove the rubber flap from the mitral valve. Record pulse curves as before.

The pulse will be small, because the pressure in the auricle (in this case the reservoir of water) is always low, while the pressure in the arteries is always high. Hence the ventricle will partly empty itself through the incompetent mitral valve, in the direction of low resistance, before the pressure in the ventricle rises high enough to open the aortic valve against the high aortic pressure. The quantity remaining in the ventricle when the intraventricular pressure rises high enough to open the aortic valve is not sufficient to distend the arteries to the normal degree.

In mitral stenosis the pulse is also small because the narrowing of the mitral orifice permits less than the usual quantity of liquid to enter the ventricle.

### THE VOLUME PULSE

Remove the receiving tambour of the sphygmograph from its tube, and insert the plethysmograph cylinder (this is the tube used in the

experiment on the volume of contracting muscle, Fig. 47). Place the middle finger in the cylinder, making sure that the rubber collar fits around the finger tightly, but without impeding the venous circulation. Close the side branch.

Periodical alterations in the volume of the finger will be recorded; they have the rhythm of the heart-beat. (The friction of the writing-lever must be very slight to insure success, and the curve at best will be small.)

Determine the effect of straining and forced respiration upon the curve.

#### APPARATUS

Normal saline. Bowl. Towel. Pipette. Artificial scheme. Microscope. Mesentery board. Mercury manometer. Aortic canuula. One per cent solution of sodic carbonate. Ligature. Glass rod one inch long. Frog-board. Wooden stand. Kymograph. Inductorium. Dry cell. Electrodes. Key. Electromagnetic signal. Sphygmograph with large and small thistle-tubes. Rubber membrane. Bone collar-button. Heart-holder. Screw-clamp. Muscle lever with scale-pan and weights. Stand. Fine copper wire. Tortoise with heart exposed. Ice. Solution of sodium chloride, 0.7 per cent. Solutions of calcium chloride, and potassium chloride, each isotonic with 0.7 per cent solution of sodium chloride. A solution containing sodium chloride, 0.7 per cent; calcium chloride, 0.026 per cent; and potassium chloride, 0.035 per cent. Binaural stethoscope. Nitrite of amyl. Plethysmograph.

## X

THE INNERVATION OF THE HEART AND  
BLOOD-VESSELS

THE quantity of blood required by the tissues varies from time to time. For example, the digestive organs require more blood when food is taken than at other times. Variations in the blood supply of the individual organs are accomplished chiefly by varying the size of their blood vessels. To this end the blood vessels are provided with muscular coats which are made to contract or relax, and thus to constrict or dilate the vessels. The impulse to contraction or relaxation is given by the vasomotor nerves. It is necessary, too, that the force and frequency of ventricular contraction should vary with the resistance to be overcome, the need for more rapid oxygenation of the blood, etc., and special nerves are provided for this purpose also. The control or innervation of the heart and blood vessels will now be considered.

The heart is provided with nerves that augment and nerves that inhibit its action.



## THE AUGMENTOR NERVES OF THE HEART

In the frog both the augmentor and the inhibitory nerves reach the heart through the splanchnic branch of the vagus. The augmentor fibres leave the spinal cord in the third spinal nerve, and pass through the ramus communicans of this nerve into the third sympathetic ganglion, where they probably end in contact with the body or processes of sympathetic cells. The axis-cylinders of these sympathetic cells pass up the cervical sympathetic chain to the ganglion of the vagus (Fig. 55), and thence down the vagus trunk to the heart. Thus in the greater part of its course the vagus cannot be stimulated without exciting both the augmentor and the inhibitory cardiac fibres. To excite either alone it is necessary to stimulate the respective nerves above their junction.

**Preparation of the Sympathetic.** — Cut away the lower jaw of a large frog, the brain of which has been destroyed by pithing, and continue the slit from the angle of the mouth downwards for a short distance. Avoid cutting the vagus nerve (Fig. 56). Turn the parts well aside, and expose the vertebral column where it joins the skull. Remove the mucous membrane covering the roof of the mouth. The sympathetic is situated

immediately under the levator anguli scapulæ muscle, which must be carefully removed. The nerve will then be visible. It is commonly pigmented and usually lies under an artery. Carefully isolate the nerve. Put a ligature around it

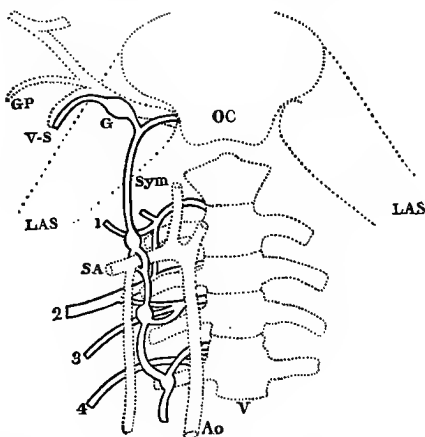

Fig. 55. Scheme of the sympathetic nerve in the frog. OC. Occiput. LAS. Levator anguli scapulæ. Sym. Sympathetic. GP. Glosso-pharyngeus. V-S. Vago-sympathetic. G. Ganglion of the vagus. Ao. Aorta. SA. Subclavian artery. (After Stirling's reproduction of Gaskell and Gadow's plate.)

as far away from the skull as practicable, and cut the nerve caudal to the ligature.

**Action of the Sympathetic on the Heart.**— Arrange the inductorium for weak tetanizing currents. In the primary circuit place the electro-

magnetic signal. Prepare the sympathetic as directed above. Expose the heart (page 75). Place it in the heart-holder. Should the heart beat rapidly, slow it with ice. Let the writing point record above the point of the electromagnetic signal on a drum revolving so slowly that the individual beats shall appear in the curve very close together, yet far enough apart to be readily counted. Divide the observation into nine periods of twenty seconds each. Place the electrodes beneath the sympathetic, with the short-circuiting key closed. Adjust the heart lever to write its curve. Let the assistant call the beginning of each period as he marks it on the drum. At the beginning of the second period, open the short-circuiting key; at the beginning of the third period, close the short-circuiting key. Lower the drum when one circuit is completed.

Count the number of beats in each period. The frequency will be increased. The force of contraction will also be increased.<sup>1</sup> The latent period of excitation is long and there is a prolonged after-effect. The former frequency is regained more rapidly after short than after long stimulations. The speed of the cardiac excitation wave

<sup>1</sup> The stimulation of the augmentor fibres is difficult and often fails in winter frogs.

(compare page 199) is increased and the time of its passage across the auriculo-ventricular groove is shortened, though this cannot be observed by the method used in the present experiment.

### THE INHIBITORY NERVES OF THE HEART

**The Preparation of the Vagus Nerve.** — Fasten a large frog on the board, back down. Pass the

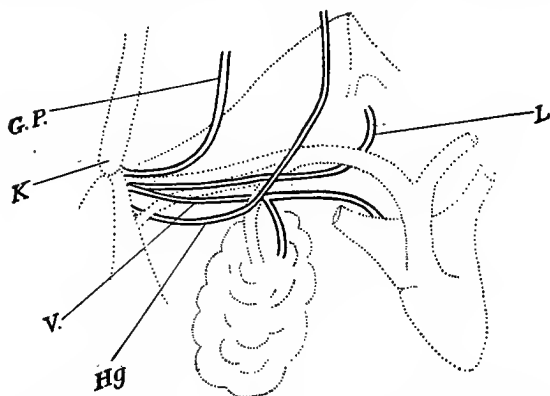

Fig. 56. Scheme of the cervical nerves in the frog (after Schenck). G. P. Glosso-pharyngeus. Hg. Hypoglossus. V. Vagus. L. Laryngeus. K. Posterior end of lower jaw. The glosso-pharyngeus has been drawn to one side of the hypoglossus for the sake of clearness.

glass tube through the œsophagus into the stomach. Remove the muscles lying over the petrohyoid muscle, which passes from the base of the skull to the horn of the hyoid bone. Lying

near the line between the angle of the jaw and the auricle are four nerves (Fig. 56): (1) The hypoglossus. This nerve is superficial. Near their emergence from the skull it is the lowest of the nerves, but later, the uppermost. It crosses the remaining nerves and the blood-vessels, and passes forwards and inwards towards the tongue. (2) The glosso-pharyngeus, which soon turns forwards beneath the hypoglossus parallel to the ramus of the jaw. (3) The vagus, and (4) the laryngeus, the two lying almost parallel in the line between the angle of the jaw and the auricle. The laryngeus rests on the petrohyoid muscle, and passes upwards and inwards beneath the arteries towards the larynx. The vagus runs at first along the superior vena cava to the auricle; a branch is given off to the lungs. Clear the vagus, and tie a silk thread around the nerve on the central (cranial) side of the ligature, so that the peripheral stump can be placed on the electrodes for stimulation. Divide the laryngeal branch. Keep the preparation moist with normal saline solution.

**Stimulation of Cardiac Inhibitory Fibres in Vagus Trunk.**—Arrange the inductorium for weak tetanizing currents. In the primary circuit place the electromagnetic signal. Expose the heart. Place it in the heart-holder. Let the

writing point record exactly above the point of the electromagnetic signal on a drum revolving so slowly that the individual beats shall appear in the curve very close together and yet far enough apart to be readily counted.

Lay the vagus nerve on the electrodes. Start the drum. As soon as good curves are writing, start the inductorium, and open the short-circuiting key for about twenty seconds. The heart will be inhibited. Note that the arrested heart is always relaxed, *i. e.* in diastole. The latent period is short (one or two heart-beats). A brief after-effect is present. If the stimulus is continued, the heart will begin to beat even during the stimulation, showing that the inhibitory mechanism can be exhausted. The heart beats more rapidly, and usually more strongly, immediately after inhibition than before; this probably is due to the after-effect of the stimulation of augmentor fibres in the vagus trunk, as explained below.

Repeat the stimulation, but weaken the stimulating current by moving the secondary farther from the primary coil.

With a suitable strength of current, the heart will be slowed but not arrested. The duration of diastole will be markedly less, while the duration of systole will be changed but little if at all. A stronger excitation would lengthen both

systole and diastole. The diminution in force often appears before the diminution in frequency.

**Effect of Vagus Stimulation on the Auriculo-Ventricular Contraction Interval.** — Counterpoise two inverted muscle levers. Place their writing points exactly above the writing point of the electromagnetic signal. Pass fine bent pins through the auricle and ventricle, respectively, and connect them by silk threads with the muscle levers (“Suspension method”). Let the drum revolve at its fastest speed. When good auricular and ventricular contractions are obtained, stimulate the vagus trunk with a current not quite sufficient to cause arrest.

Note that the inhibition affects both the auricle and the ventricle. Weak stimuli affect primarily the auricles. The auriculo-ventricular contraction interval is lengthened.

**Irritability of the Inhibited Heart.** — Arrest the heart by stimulating the vagus trunk. When complete inhibition is secured, touch the ventricle smartly with the point of the seeker.

The ventricle will respond by a single contraction.

When the inhibition is profound, the irritability may be so far reduced that the heart will not contract on direct stimulation.

In addition to the effects already enumerated,

appropriate methods of observation would show that vagus excitation increases the intraventricular pressure during diastole, lessens the intake and the output of the ventricle, and diminishes the tonus of the heart muscle. The action of the vagus is accompanied by a positive electrical variation. The action on the sinus and on the bulbus does not differ essentially from that upon the ventricle.

It has already been pointed out that the vagus of the frog contains both inhibitory and augmenting fibres. The stimulation of the mixed nerve usually causes inhibition, as described above, but sometimes augmentation. The augmentation observed after cessation of the inhibitory effect is probably explained by the longer after-effect of the augmentor excitation.

**Intracardiac Inhibitory Mechanism.** — Arrange an inductorium for tetanizing currents. Close the short-circuiting key. Expose a frog's heart. Raise the heart with a glass rod. Note the white "crescent" between the sinus venosus and the right auricle. Set the inductorium in action. Put the points of the electrodes on the crescent, and open the short-circuiting key for a moment. After one or two beats the heart will stop.

**Inhibition by Stannius Ligature.** — Turn up the heart to expose its posterior surface, and note the



line of junction of the sinus venosus and right auricle. Tie a ligature around the heart exactly at this line, passing the thread beneath the aortæ, so that they shall not be included in the ligature.

The auricles and ventricle cease to beat, for a time at least, while the sinus venosus continues with unaltered rhythm. (The result is usually ascribed to inhibition, from the mechanical stimulation of the intracardiac inhibitory mechanism. If the ventricle begins spontaneously to beat, as may happen if the ligature is not accurately placed, tie a second ligature around the junction of sinus and auricle.)

**Action of Nicotine.** — Apply nicotine solution (0.2 per cent) to the ventricle. After a few minutes, stimulate the trunk of the vagus nerve. No curve need be written.

The heart is not inhibited.

Now lift the heart with a glass rod, and stimulate the intracardiac inhibitory nerves.

The heart is inhibited. Nicotine paralyzes some inhibitory mechanism between the vagus and the intracardiac inhibitory nerves. But it is known that nicotine does not paralyze nerve trunks. Hence it is probable that the cardiac inhibitory fibres do not pass to the cardiac muscle directly, but end in contact with nerve cells, which take up the impulse and transmit it

through their processes to the muscular fibres of the heart.

**Atropine.** — With a clean pipette apply a few drops of a solution of atropine (0.5 per cent) to the heart. After a few moments lift the ventricle and stimulate the crescent.

The heart is not inhibited. Atropine paralyzes the intracardiac inhibitory nerves.

**Muscarine.** — With a fine pipette put upon the ventricle a few drops of normal salt solution containing a trace of muscarine (a poisonous alkaloid extracted from certain mushrooms).

The ventricle will gradually be arrested in diastole, much distended with blood.

**Antagonistic Action of Muscarine and Atropine.** — With a fresh pipette apply a little normal salt solution of atropine (0.5 per cent).

The heart will commence to beat again.

### THE CENTRES OF THE HEART NERVES

It has been shown that the heart receives inhibitory and augmenting nerve fibres. The situation of the inhibitory and augmenting "centres," *i. e.*, the nerve cells from which the inhibitory and augmenting fibres spring, should now be considered.

**Inhibitory Centre.** — Place a frog and a small sponge wet with ether under a glass jar. Be very

careful not to kill the frog by an overdose of ether. When insensibility is complete, place the animal, back uppermost, on a frog-board. Cut through the skin in the median line from the nose about half way to the urostyle. Carefully uncover the roof of the skull. Remove the longitudinal muscles on either side of the 1st, 2d, and 3d vertebræ. Strip off the parietal bones with forceps, beginning at the anterior end, opposite the anterior margin of the orbit. Clear away the occipital bones. Saw through the laminæ of the first three vertebræ, and remove the laminæ to expose the spinal cord. Expose the heart by cutting away the chest wall over the pericardium. Hold the frog in such a way that the heart can be observed while the brain and cord are stimulated. With needle electrodes, the points of which should be

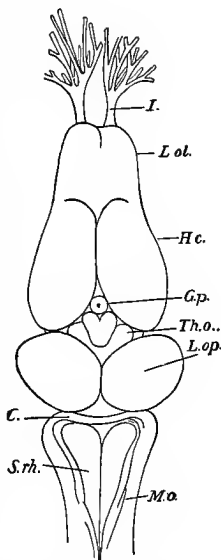

Fig. 57. View of the brain of a frog from above, enlarged. L.ol. Olfactory lobes. H.c. Cerebral hemispheres. G.p. Pineal body. Th.o. Optic thalami. L.op. Optic lobes. C. Cerebellum. M.o. Medulla oblongata. S.rh. Sinus rhomboidalis. (After Foster's plate in Burdon-Sanderson's Handbook.)

of which should be

one millimetre apart, stimulate the spinal cord with a tetanizing current of a strength easily borne on the tongue.

Stimulation of the spinal cord will not inhibit the heart. Stimulation of the cerebral hemispheres will be also ineffectual. Now stimulate the medulla oblongata. (Fig. 57.)

The heart will be inhibited.

This method of locating the cardio-inhibitory centre is unsatisfactory, because the inhibition produced may possibly be the result of the stimulation of nerve paths to or from the centre. Its results can be controlled by the method of successive sections, to be explained in connection with the vasomotor centre, page 293.

The cardio-inhibitory centre is always in action, for section of the vagi causes the heart to beat more frequently.

**Augmentor Centre.**—It is probable that this centre, like the inhibitory centre, is situated in the bulb, but the location is not definitely known. The constant activity of the augmentor centre is shown by the fall in frequency of beat after section of the vagi followed by bilateral extirpation of the inferior cervical and first thoracic ganglia in mammals.

The neuraxons, or axis-cylinder processes, of the augmentor cells lying in the central nervous

system pass out of the spinal cord in the white rami and terminate in the sympathetic ganglia (for example, the inferior cervical and stellate ganglia of the dog) in contact with sympathetic cells, the neuraxons of which convey the impulse to the heart.

The cardiac centres are readily affected by afferent impulses from many sources.

**Reflex Inhibition of the Heart; Goltz's Experiment.**—In a very lightly etherized frog, expose the pericardium by cutting away the chest wall over the heart. Count the number of beats in periods of twenty seconds. Continue the count while an assistant strikes gentle blows with the handle of a scalpel upon the abdomen at the rate of about 140 per minute.

The frequency will usually diminish and, in favorable cases, the heart will at length be arrested.

Cut both vagus nerves and repeat the experiment.

The reflex inhibition of the heart cannot be obtained after section of the vagi.

It has been shown by Bernstein that the afferent nerves in this experiment are abdominal branches of the sympathetic nerve. The stimulation of the central end of the abdominal sympathetic in the rabbit also produces reflex inhibition of the heart.

**Reflex Augmentation.** — Count the human radial pulse during four consecutive periods of fifteen seconds. Let the subject sip cold water slowly. Repeat the count while the subject swallows.

The frequency will be increased.

Variations in the force and frequency of the heart-beat follow the stimulation of most afferent nerves, for example the central end of the divided vagus, the sciatic, and other mixed nerves, the nerves of special sense, and the afferent nerves which arise in the heart and pass to the bulb.

The most conspicuous of the nerves which bear impulses from the heart to the central nervous system in mammals is the depressor. This nerve occurs as an isolated trunk in the rabbit, and is found mixed with other fibres, for example in the vagus, in many other animals. The stimulation of the end of the severed depressor nerve in connection with the heart is without effect. The stimulation of the end in connection with the bulb slows the heart and dilates the blood-vessels, thus causing a great fall in the blood-pressure.

#### THE INNERVATION OF THE BLOOD-VESSELS

**The Bulbar Centre.** — 1. Lightly etherize a large frog. Expose and cut both vagus nerves (in order to exclude inhibition of the heart). It is of the first importance to avoid excessive hemor-

rhage. Expose the brain and the anterior half of the spinal cord (page 293). Place the frog on the web-board. Note carefully the speed with which the corpuscles pass through the smaller vessels of the web. The rate of flow in the capillaries is the best practical index of the diameter of the small arteries. When the arteries constrict, the flow in the capillaries will be less rapid. Remove the cerebral hemispheres and the optic lobes. After five minutes or more (to allow the frog to recover from the shock of the operation), note the condition of the web vessels.

There will be no significant change.

The removal of the brain anterior to the bulb has not destroyed the tonus of the blood-vessels.

Note the slow rhythmic changes in the diameter of the vessels. The changes are not uniform throughout the length of the blood-vessel.

2. Curarize the frog sufficiently to paralyze the motor nerves. Stimulate the bulb with very weak tetanizing currents.

The flow in the capillaries will be less rapid. Obviously the bulb contains nerve cells, the excitation of which causes the narrowing of the blood-vessels. These cells are termed the bulbar vasoconstrictor centre. Repeated sections show that the vasoconstrictor cells are placed (in the rabbit) on both sides of the median line from

about one millimetre posterior to the corpora quadrigemina to a point about four millimetres posterior to those bodies.

**The Vasomotor Functions of the Spinal Cord. —**

1. Divide the cord just posterior to the bulb. (A fresh frog may be required. In that case, remember to curarize.)

The division of the fibres connecting the vasoconstrictor centre with the cord will be followed by the dilatation of the vessels in the web (*i. e.* the flow will be more rapid).

2. Stimulate the peripheral segment of the divided cord.

The blood-vessels will constrict.

Thus the neuraxons (axis-cylinder processes) of the bulbar vasomotor cells pass through the spinal cord on the way to their respective blood-vessels.

It should now be determined whether these fibres pass to the blood-vessels without interruption, or whether they end in contact with spinal vasomotor cells through which the connection with the blood-vessels is made.

3. Wait five minutes and then note the flow through the capillaries.

The dilatation observed immediately after the separation of the cord from the medulla has given place to moderate constriction. The tonus of the



blood-vessels has returned. The spinal cord has taken up the vasomotor function of the bulb. Evidently the spinal cord contains vasomotor cells, which ordinarily are subsidiary to those of the bulb, but which, when separated from their master cells, acquire the power of independent action.

**Effect of Destruction of the Spinal Cord on the Distribution of the Blood.** — Further evidence of the vasomotor function of the spinal cord is afforded by the following experiment.

Expose the heart, avoiding unnecessary loss of blood. Lay bare the upper part of the intestine by an incision on the left side of the umbilical vein, which lies in the median line. Suspend the frog vertically. Note that the heart and the great vessels are filled with blood. Note also the size and number of the vessels in the walls of the stomach and intestines.

Bend the frog's head. Put the seeker into the vertebral canal and pass it gently downwards to destroy the spinal cord. The seeker will move easily, if really in the canal. Look at the heart and great arteries.

The heart will soon be bloodless, though beating regularly. Examine the vessels of the stomach and intestine. They are distended. Evidently, the contents of the heart and the great arteries

have passed into dilated smaller arteries and veins. It would be found, on waiting, that this effect is not a passing consequence of inhibition. The destruction of the spinal cord has changed the distribution of the blood.

**The Vasomotor Fibres leave the Cord in the Anterior Roots of Spinal Nerves.**—1. Remove the arches of the 5th, 6th, 7th, 8th, and 9th vertebræ and lay bare the cord in a large frog in which the motor nerves have been paralyzed with curare. Note the capillary flow in the web. On the side on which the web-vessels are examined, tie a silk thread around each of the anterior roots near their origin from the cord, and sever the roots between the ligature and the cord.

The vessels will dilate.

2. Stimulate the peripheral ends of several of the divided roots.

Constriction will follow.

The vascular dilatation which follows the destruction of the spinal cord is not permanent. After a time the vessels regain their tonus. It is probable, therefore, that vasomotor nerve cells exist outside the spinal cord, and this conclusion is confirmed by the results gained on warm-blooded animals with the nicotine method. Langley has found that the injection of about ten milligrams of nicotine into a vein of a cat will prevent, for a

time, the passage of nerve impulses through sympathetic cells. Painting the ganglia with nicotine has the same effect. In animals the sympathetic cells of which have thus been paralyzed, the stimulation of the lumbar nerves in the spinal canal produces no change in the vessels of the generative organs, though in animals not poisoned with nicotine this stimulation causes marked constriction. The lumbar vasomotor fibres must therefore end in connection with sympathetic nerve cells which transmit the constrictor impulse to the blood-vessel. Similar observations in other regions warrant the belief that all the vasomotor fibres emerging from the spinal cord end in like manner.

Thus the vasoconstrictor system probably consists of three neurons. The first is a sympathetic cell, lying apart from the central nervous system. Its neuraxon (axis-cylinder process) passes directly to the blood-vessel. The second is a spinal cell, the neuraxon of which leaves the cord and terminates in contact with the sympathetic cell or its branches. The third has its cell body in the bulb and its neuraxon terminates in contact with the second neuron.

Commonly, as for example in the nerves of the extremities, the sympathetic neuraxon passes from the ganglion along the gray ramus into the

corresponding spinal nerve, in which it continues to its distribution.

**Vasoconstrictor Fibres in the Sciatic Nerve.** — Curarize a frog sufficiently to paralyze the voluntary muscles (any excess of curare will paralyze the vasomotor fibres also). Carefully destroy the brain with the seeker, avoiding loss of blood. Expose the right sciatic nerve for a short distance on one side, using the greatest care not to injure the blood-vessels. Tie a thread tightly around the nerve near the upper end of the exposed portion. Lay the frog, back upward, on the web-board, placing the web of the right foot over the notch, and securing it with fine pins. Examine the web under a low power, to make sure that the circulation has not been interrupted by stretching the web. Place the secondary at such a distance from the primary coil that the induced current shall be barely perceptible to the tongue. Set the hammer vibrating, and close the short-circuiting key. Put the electrodes under the sciatic nerve on the peripheral side of the ligature. Let a second observer watch a small vessel of the web through the microscope. Open the short-circuiting key for a moment only.

The blood-stream slows from constriction of the supplying vessels, the contraction increasing during a few seconds and then subsiding.

This experiment requires much care and close observation. The curare effect must be very slight; a small quantity of the drug should be given an hour before the observation is made. Great pains must be taken to use feeble currents and not to prolong the excitation, for the vasomotor nerves are rapidly exhausted. The narrowing of the arteries of the web is usually evident only in the slowing of the blood-stream during excitation.

**Vasodilator Nerves.**—1. Repeat the preceding experiment in a frog in which the sciatic nerve has been four days severed (without injury to the femoral vessels). On stimulation of the peripheral segment of the divided sciatic nerve, the vessels of the web will dilate instead of constricting.

Evidently the sciatic nerve contains vasodilator as well as vasoconstrictor fibres. When the sciatic fibres are separated from their cells of origin by the section of the nerve, the fibres distal to the section degenerate. But the degeneration does not proceed at the same rate in all the fibres. The vasoconstrictors die before the vasodilators. In ordinary stimulation of the normal nerve, the action of the constrictors overpowers that of the dilators. In the partially degenerated nerve, the same stimulation causes dilatation because the constrictor fibres are dead or dying.

2. Note the rate of flow in the web-vessels in the uninjured limb. Stimulate the sciatic nerve with the single induction current repeated at intervals of five seconds.

The vessels of the web will dilate.

The vasoconstrictor and vasodilator fibres also react differently to cold. If the hind limb (cat) be cooled, the stimulation that normally causes vasoconstriction will cause vasodilatation.

Vasoconstrictor and vasodilator fibres are not always found in the same nerve-trunks; in the chorda tympani nerve, for example, there are only dilator fibres.

The central relations of the dilator nerves have not been sufficiently studied to warrant their discussion here.

**Reflex Vasomotor Actions.**—1. Note the rate of flow in the vessels of the web in a lightly curarized frog. Stimulate the skin (not too near the bulb or cord) with tetanizing currents. The stimulus must not be repeated often, or fatigue will obscure the result.

Reflex constriction of the vessels will take place. The sensory impulse is carried by afferent fibres to the vasomotor centres.

Repeat the experiment, using in place of the electrical a mechanical stimulus, such as pinching the skin with forceps.

## APPARATUS

Normal saline. Bowl. Towel. Pipette. Glass plate. Inductorium. Key. Wires. Dry cell. Electrodes. Needle electrodes. Frog-board. Electromagnetic signal. Heart-holder. Kymograph. Glass tube for oesophagus. Two muscle levers. Solutions of nicotine (0.2 per cent), atropine (0.5 per cent), muscarine (a trace in normal salt solution). Curare. Ether. Sponge. Glass jar. Vertebral saw. Web-board. Fine pins. Microscope. Frog, the sciatic nerve of which has been severed four days. Millimetre rule. Silk thread.





## INDEX

- Absolute force of muscle, 224.
- Action current, heart, 173, 175; human muscle, 172; in brain and cord, 182; muscle, 166; nerve, 178; optic nerve, 181; precedes contraction, 174; speed of, 177; tetanus, 168.
- Alcohol, action on nerve, 136.
- Alteration theory, 164.
- Amalgamation, 21.
- Anode and cathode, 13, 71, 93.
- Aortic regurgitation, 278.
- Aortic valve, stenosis of, 279.
- Apparatus, criticism of, 53; lists of, 11, 49, 58, 122, 128, 149, 193, 234, 281, 305.
- Artificial scheme of circulation, 243.
- Atropine, action on cardiac inhibition, 292.
- Augmentor centre, 294.
- Augmentor nerves of heart, 283.
- Auriculo-ventricular contraction interval, 263; effect of vagus stimulation, 289.
- Bernstein's apex experiments, 259; rheotome, 176.
- Blood pressure, curve, 251; peripheral resistance, 253.
- Brain of frog, dorsal view, 293.
- Bulbar vasomotor centre, 296.
- Calcium, action on contraction, 126; on heart muscle, 267.
- Capillary electrometer (*see* Electrometer), 14.
- Carbon dioxide, action on nerve, 134; apparatus, 135.
- Cathode, 13.

- Cell, electrical, 21, 24, 27.  
Cells, in series, 94.  
Centres of heart nerves, 292.  
Cervical nerves in frog, 286.  
Circulation, artificial scheme of, 243; capillary, 297; in frog's mesentery, 248; mechanics of, 239; rate of flow, 248.  
Compensation method of measuring electromotive force, 158.  
Compensatory pause, 261.  
Conductivity, 129; changed by galvanic current, 82.  
Contraction, affected by direction of current, 118; idiomuscular, 127; isometric, 219; law of, 75, 95; of human muscle, twitch, 220; opening and closing, 61; tonic, 70, 102.  
Contraction time of clear and turbid fibres, 198.  
Contraction wave, 201; form influenced by strength of stimulus, 203.  
Contracture, 203.  
Cork clamp, 65.  
Curare, poisons motor end-plates, 132.  
Daniell cell, 24.  
Degeneration, reaction of, 97.  
Demarcation current, 150, 159, 161; as stimulus, 153; causation, 161; electromotive force of, 157; interference with stimulating current, 155; muscle, 150; negative variation, 178; nerve, 159; positive variation, 179.  
Depressor nerve, 296.  
Dicrotic notch, 273.  
Differential rheotome, 176.  
Distilled water, as stimulus, 124.  
Dry cell, 27.  
Drying, as a stimulus, 110, 125.  
Du Bois-Reymond, molecular hypothesis, 162.  
Duchenne's points, 89.  
Elasticity and extensibility of a metal spring, 229; of a rubber band, 230; of skeletal muscle, 230.  
Electrical stimulation, 12.  
Electrical units, 14.  
Electric fish, 192.

- Electrodes, for human nerves, 91 ; indifferent, 74 ; non-polarizable, 59, 60 ; platinum, 31.
- Electrolyte, 26.
- Electrolysis, 27.
- Electromagnetic induction, 33.
- Electromagnetic signal, 68.
- Electrometer, 14, 17, 21, 28, 29, 30.
- Electrotonic current, 186 ; as stimulus, 191 ; negative and positive variation, 188 ; polarization increment, 188.
- Electrotonus, 81.
- Engelmann's incisions, 262.
- Ergograph, 220.
- Excitation wave, 199 ; remains in original fibre, 143.
- Exclusion of make or break current, 43.
- Extensibility, 229, 231.
- Extra contraction of heart, 261.
- Extra currents in inductorium, 41.
- Fatigue, human skeletal muscle, 233 ; polar, 108 ; skeletal muscle of frog, 232.
- Flexors and extensors, relative excitability, 139.
- Frog-board, 115.
- Frog, brain, 293 ; muscles of hind limb, 7, 62.
- Galvanic current, 59.
- Galvani's experiment, 12.
- Galvanotropism, 98.
- Gas chamber, 135.
- Gaskell's block, 263 ; clamp, 263.
- Goltz's experiment, 295.
- Gracilis, 145.
- Graphic method, 51.
- Heart, action current, 173, 175 ; action of inorganic salts on, 266 ; action of sympathetic on, 284 ; augmentor nerves, 283 ; auriculo-ventricular interval, 263 ; change in form, 257 ; chemical theory, 268 ; compensatory pause, 261 ; constant stimulus, 261 ; contraction curve, 258 ; extra contraction, 261 ; Gaskell's block, 263 ; holder, 174 ; impulse, 269 ; influence of load, 265 ; influence of temperature, 266 ; inhibi-

Heart — (*continued*)

- tion, 253; inhibition by Stannius ligature, 290; inhibition by vagus stimulation, 287; inhibitory nerves, 286; intra-cardiac inhibitory mechanism, 290; irregularities explained, 262, 264; irritability, 261; irritability during inhibition, 289; isolated apex, 259; maximal contractions, 258; method of exposure, 75; muscle, spontaneous contraction, 260; nerve free, 131; outflow period, 256; polar inhibition, 114; polar stimulation, 73; reflex augmentation, 296; reflex inhibition, 295; refractory period, 261; sounds, 269; tonus, 265; transmission of contraction wave, 262; transmission of excitation, 263; valves, 241, 244, 255, 278, 279, 280; various effects of vagus stimulation, 290.
- Human muscle, artificial tetanus, 221; natural tetanus, 221; isometric contraction, 220.
- Human nerves, stimulation of, 89.
- Idio-muscular contraction, 127.
- Induction, unipolar, 44.
- Induction currents, 30, 40, 119; in nerves, 43.
- Inductarium, 31, 35; graduation, 38, 39.
- Inhibition by galvanic current, 114; of heart, 253.
- Inhibitory centre, 292.
- Inhibitory nerves of heart, 286.
- Innervation of blood-vessels, 296.
- Inorganic salts, influence on contraction, 266.
- Intestine, polar stimulation of, 67.
- Ious, 13, 26.
- Irritability, 6, 129; separable from conductivity, 134; polar changes, 78.
- Isometric method, 217.
- Isometric spring, graduation of, 218.
- Key, short-circuiting, 31; simple, 31.
- Kymograph, 51.
- Latent period of muscle, 197.
- Lines of force, 33.
- Load, influence on contraction, 265; on height of contraction, 204.

- Magnetic field, 33.  
Magnetic induction, 30.  
Make and break currents, exclusion, 43; as stimuli, 40.  
Manometer, mercury, 252.  
Mitral incompetence, 278, 280.  
Moist chamber, 60.  
Molecular hypothesis, 162.  
Monopolar stimulation, 74, 93.  
Motor-points of forearm, 90, 91; stimulation, 92.  
Muscarine, action on heart, 292; antagonistic to atropine, 292.  
Muscle, action current, 166; clamp, 9; clear and turbid, 140; curve, 196; curve, for estimating total work done, 226; demarcation current, 150; electromotive phenomena, 150; independent irritability, 130; influence of structure, 140; lever, 55, 60; preparation of gastrocnemius, 4; sound, 211.  
Muscle warmer, 206.  
Myomeres, Rosenthal's scheme of, 162.  
Negative variation, 178; of secretion current, 184.  
Nerve, action current, 178; conducts in both directions, 144; demarcation current, 159; electrical resistance, 190; electromotive phenomena, 150; fibres, relative excitability, 139; holder, 9; induction in, 43; irritability, 142; polarization, 187; polar stimulation, 75; specific irritability, 141; stimulated by own demarcation current, 160.  
Nerve impulse, 11; periodic discharge, 105; speed of, 146.  
Nerve-muscle preparation, 4, 6, 8, 9.  
Nicotine, action on cardiac inhibition, 291.  
Nitrite of amyl, 277.  
Normal saline, 126.  
Opening and closing contraction, 61.  
Optic nerve, action current, 181.  
Paper, smoked, method of using, 52.  
Paradoxical contraction, 191.  
Paramecium, galvanotropism, 98.  
Peripheral resistance, 250.  
Plethysmograph, 280.  
Point of view, 4.

- Polar fatigue, 108.  
Polar inhibition, heart, 114; veratrinized muscle, 116.  
Polarization, 23, 25, 59; current, 25, 87, 106; increment, 188.  
Polar refusal, 155.  
Polar stimulation, 109, 112; by induced current, 120; of muscle, 65, 73; of nerve, 75, 93.  
Pole-changer, 25.  
Positive after current, 180.  
Positive variation, 107, 179.  
Potassium, influence on contraction, 267.  
Potassium iodide method for determining direction of current, 27, 119.  
Potential, electrical, 13.  
Pulse, dicrotic, 273; form of, 272; frequency, 271; hardness, 272; in regurgitation and stenosis, 278, 279; pressure curve, 274; volume, 273.  
Refractory period, 261.  
Rheocord, 20.  
Rheoscopic frog, 166.  
Rheotachygraph, 177.  
Rhythmic contraction, heart, 103; skeletal muscle, 104, 126.  
Rhythmic discharge of nerve impulses, 105.  
Rigid muscle lever, 205.  
Ringer solution, 268.  
Ritter-Rollett phenomenon, 139.  
Ritter's opening tetanus, 110.  
Saline solutions as stimuli, 125.  
Sartorius, 144.  
Secretion current, negative variation, 183, 184.  
Self-induction, 41.  
Shortening in single contraction, and in tetanus, 215.  
Single contraction, 195; duration of periods, 196.  
Smooth muscle, simple contraction, 222; spontaneous contractions, 221; tetanus, 223.  
Sodium, influence on contraction, 267.  
Sphygmograph, 256.  
Spinal cord, destruction changes distribution of blood, 299.

- Staircase contraction, heart, 259.
- Stand, 9.
- Stannius ligature inhibits heart, 290.
- Stimulation affected by current angle, 118; by form of muscle, 117.
- Stimulation, chemical, 81, 110, 124; constant, may cause periodic contraction, 126; drying, 110, 125; electrical, 12, 59; human nerves, 89; mechanical, 5, 9, 127; monopolar, 74, 93; motor points, 92.
- Stimuli, 6; summation, 138.
- Stimulus, changes in intensity, 62; influence of duration, 100; minimal and maximal, 137; threshold value, 137.
- Strength of stimulus, related to form of contraction wave, 203.
- Stroboscopic method, 168.
- Superposition in tetanus, 210; of two contractions, 209.
- Surface tension, 15.
- Sympathetic, action on heart, 284; in frog, 284; preparation of, 283.
- Synchronous points, method of obtaining, 84.
- Temperature, influence on contraction, 205, 266.
- Tetanzing currents, 42.
- Tetanus, 43, 128, 168, 209; opening and closing, 108.
- Time relations of developing energy, 226.
- Tonic contraction, 70, 102.
- Tonus, 265.
- Total work done, 224; estimated by muscle curve, 226.
- Tuning fork, 55.
- Unipolar induction, 44; stimulation, 48, 183.
- Ureter, polar stimulation of, 66.
- Vagus, preparation of, 286; stimulation inhibits heart-beat, 287; stimulation lengthens auriculo-ventricular contraction interval, 289.
- Vasoconstrictor fibres in sciatic nerve, 302; system, 301.
- Vasodilator nerves, 303.
- Vasomotor centre in bulb, 296; functions of cord, 298; fibres in anterior roots of spinal nerves, 300; reflexes, 304.
- Veratrine, influence on form of contraction, 208.

- Volume of contracting muscle, 194.
- Volume pulse, 280.
- Volume tube, 195.
- Wallerian degeneration, 97, 131.
- Wheel interrupter, 167.
- Work adder, 225.
- Work done, influenced by load, 223.
- Writing point, 56.













