

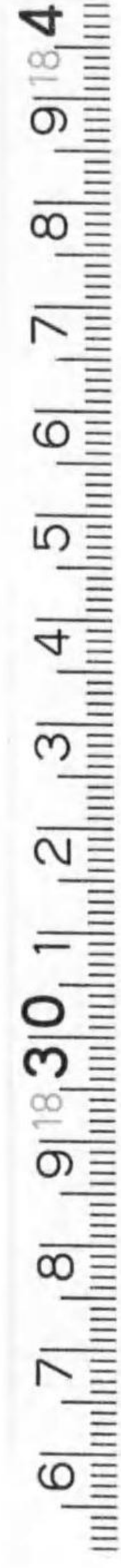

始



船用
往復動汽機學
附圖
(上卷)

臨時公立商船學校
教科書編纂委員會

393
252

特 205
516



往復動汽機學

附圖

(上卷)

臨時公立商船學校
教科書編纂委員會



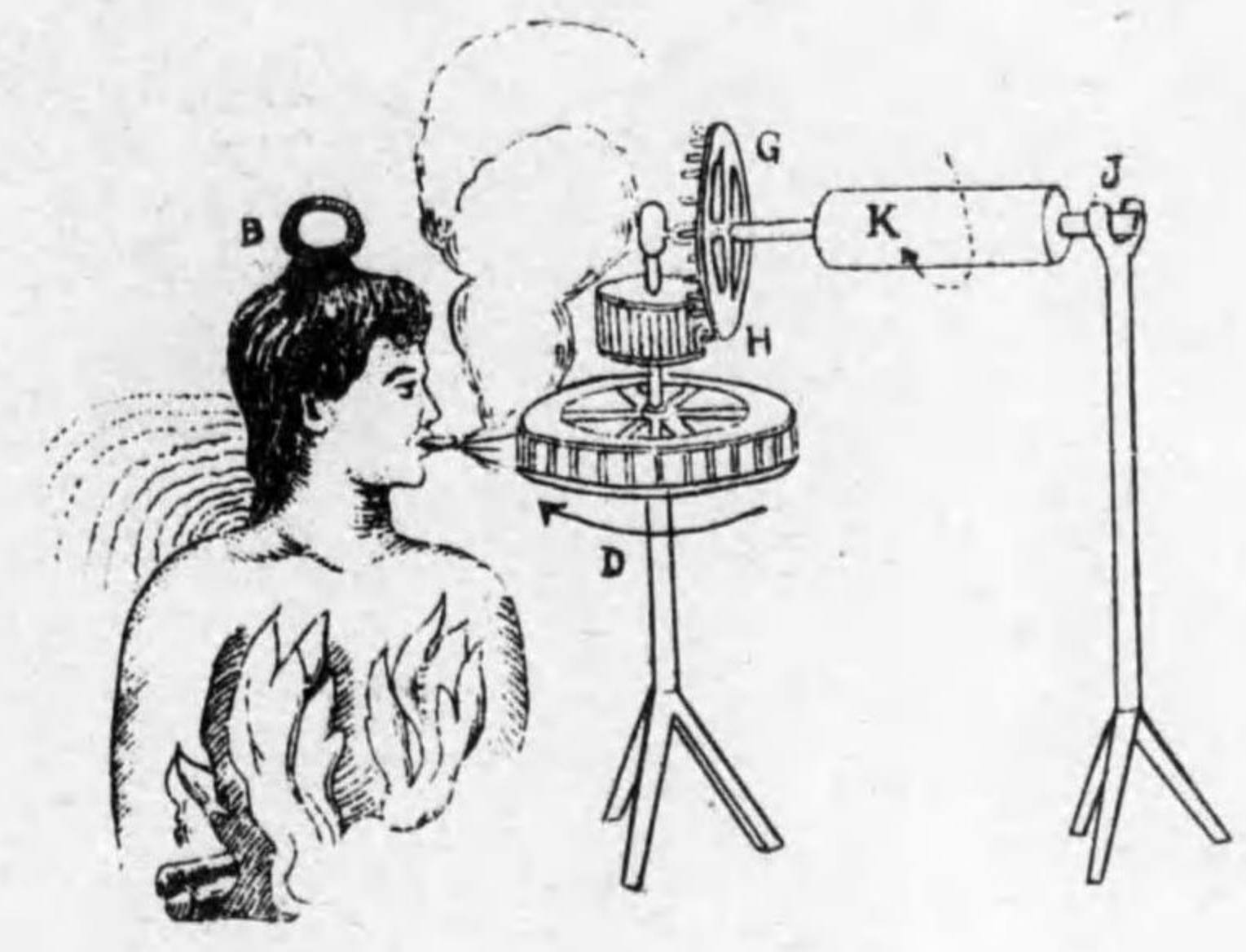

BRANCA'S ENGINE

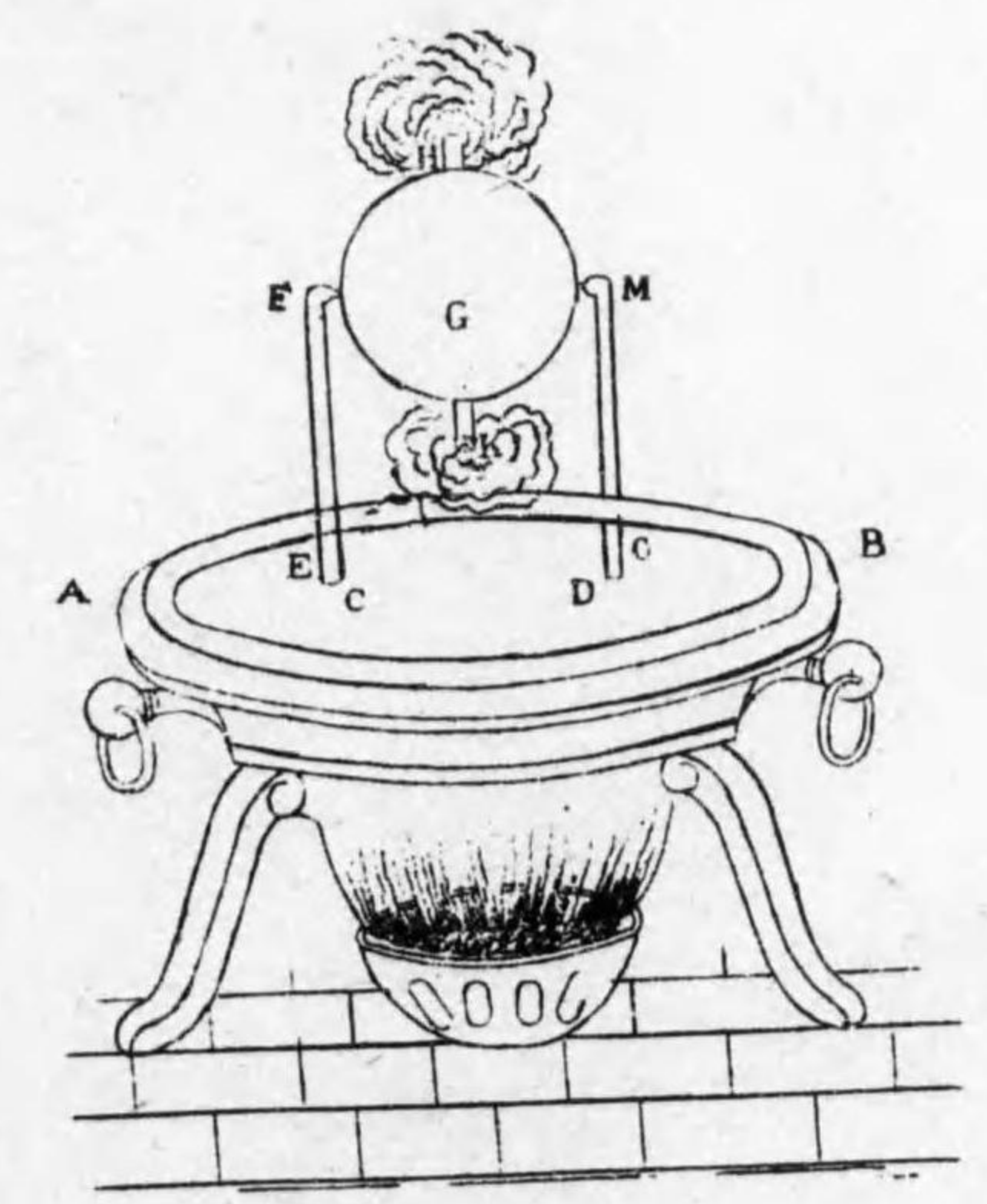

HERO'S ENGINE

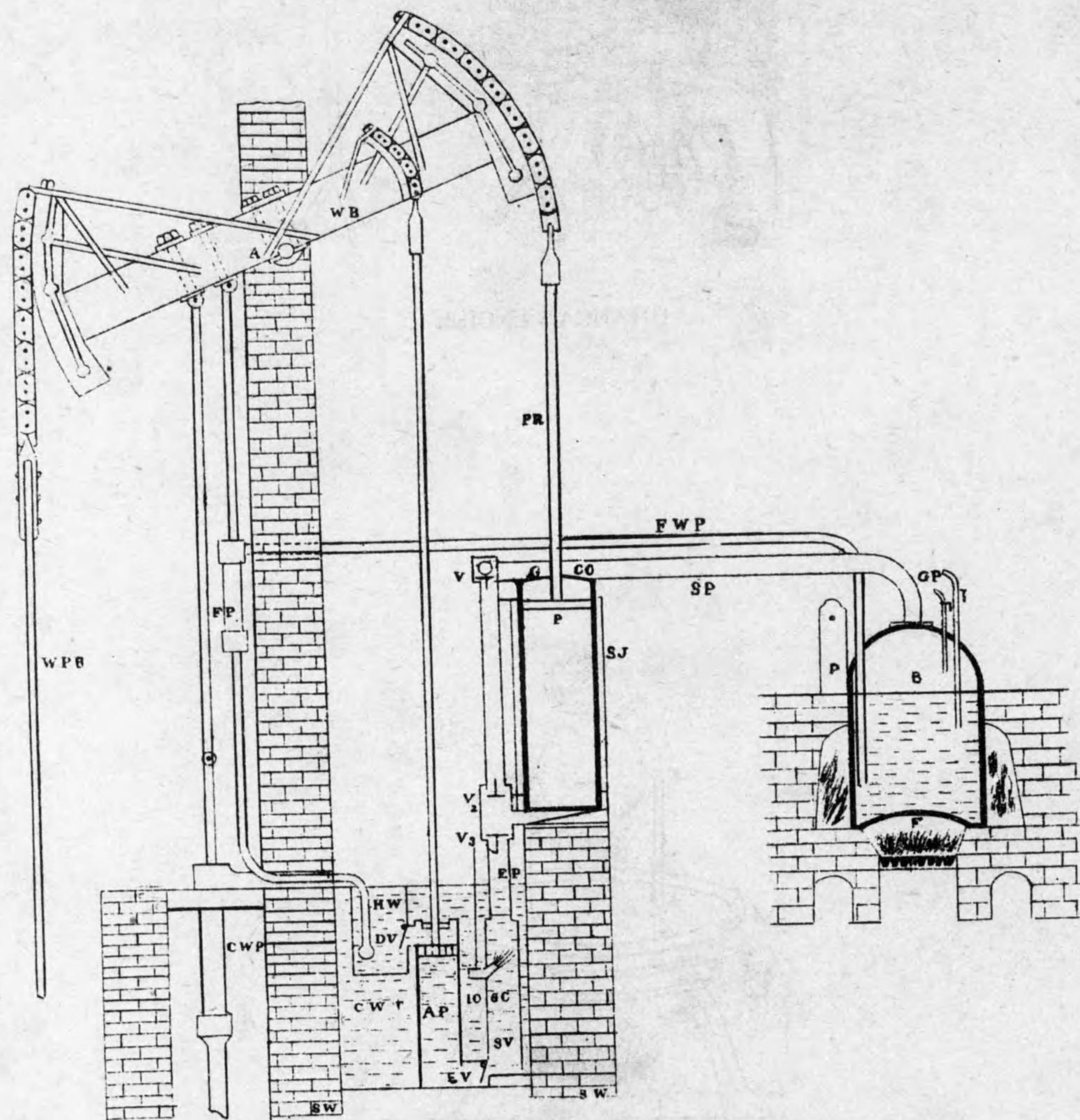

第 1 圖

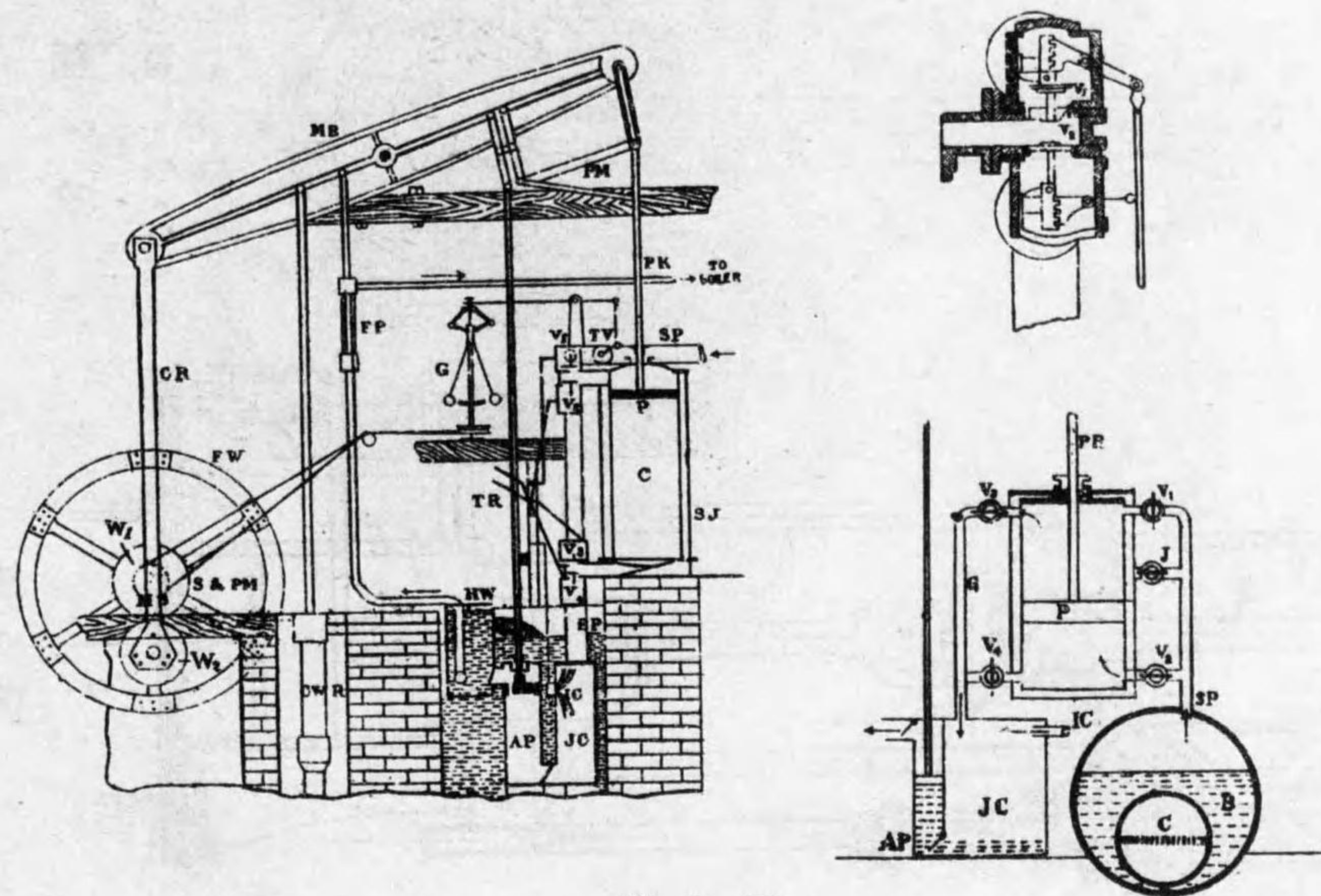

第 2 圖

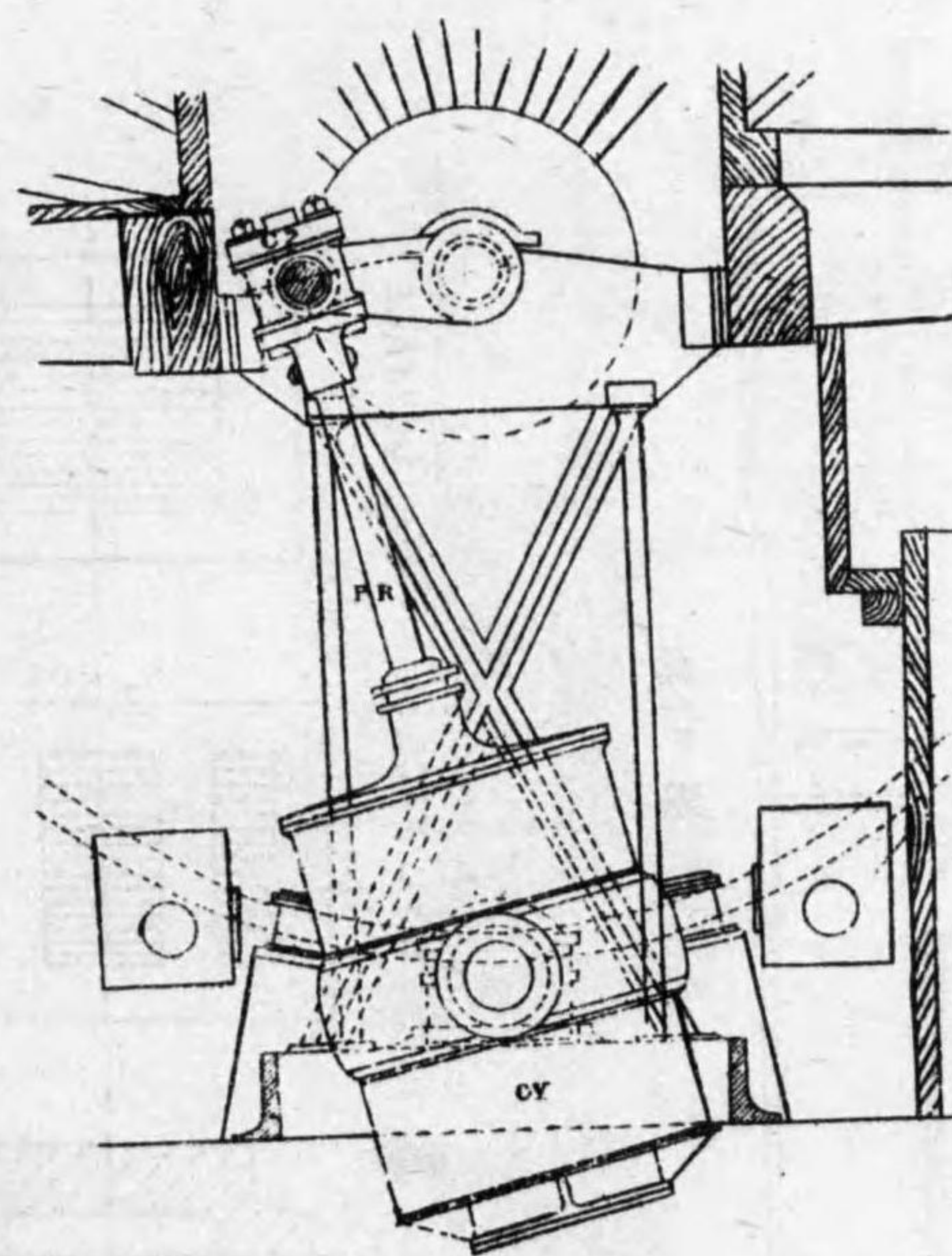

第 3 圖

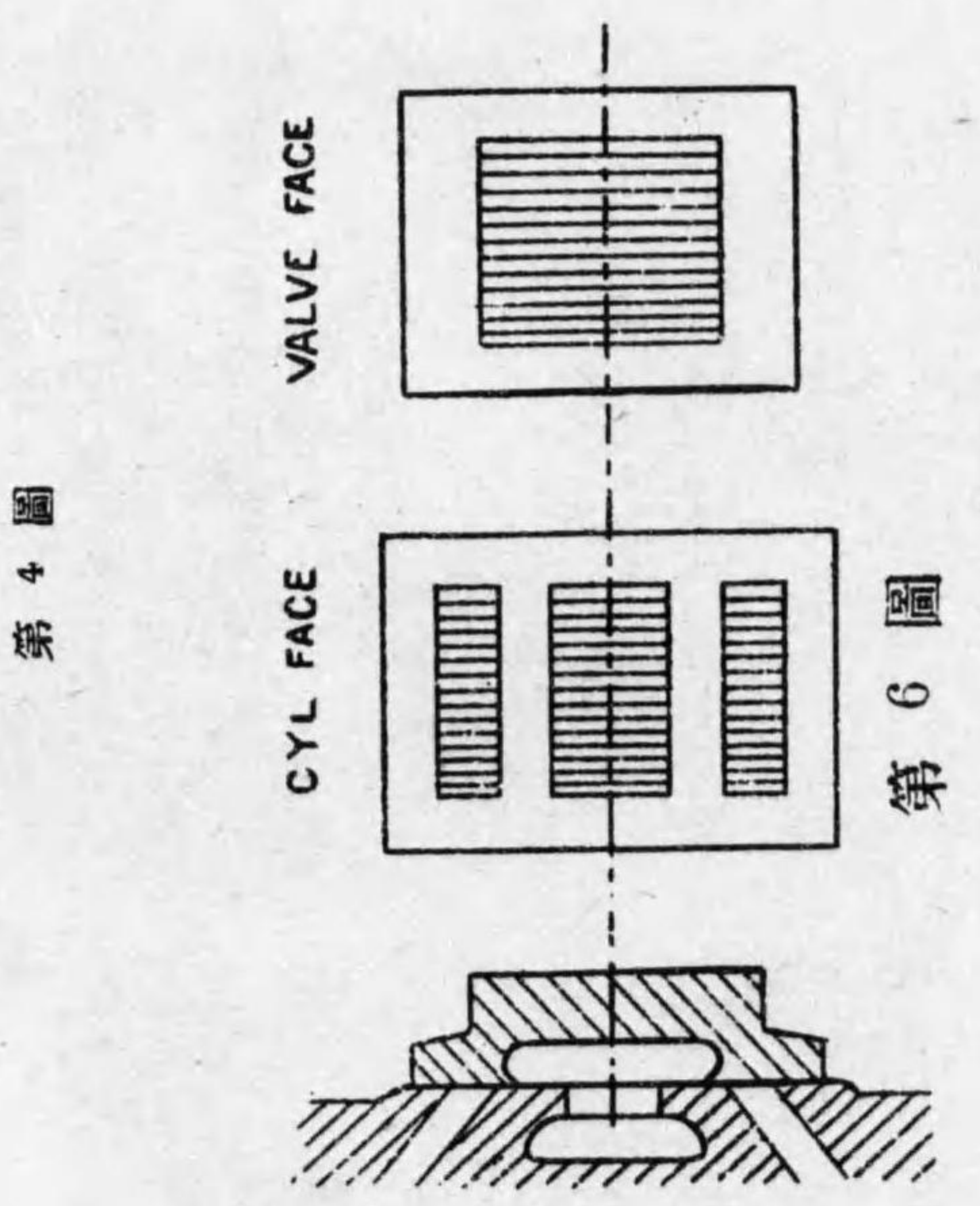
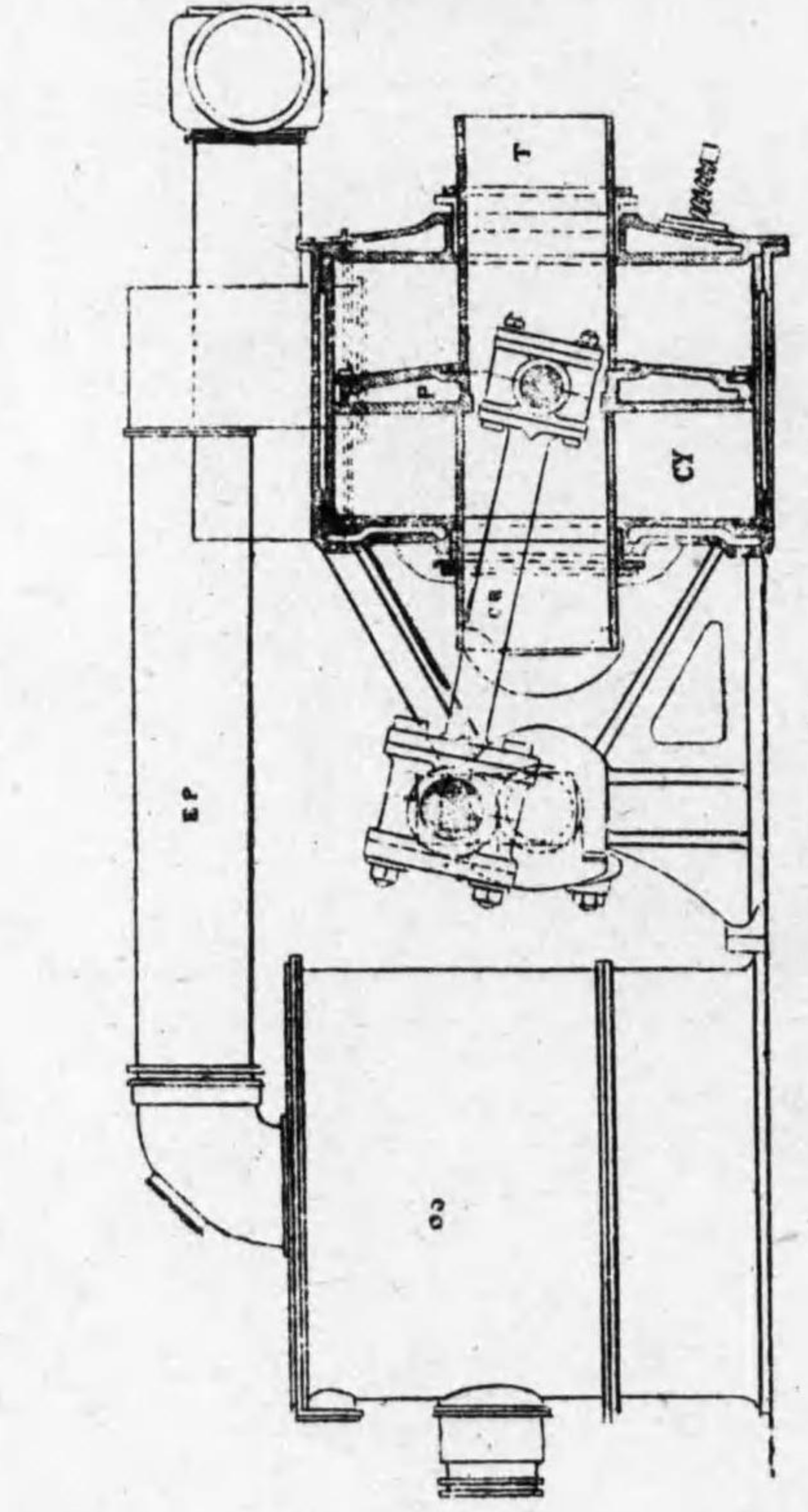
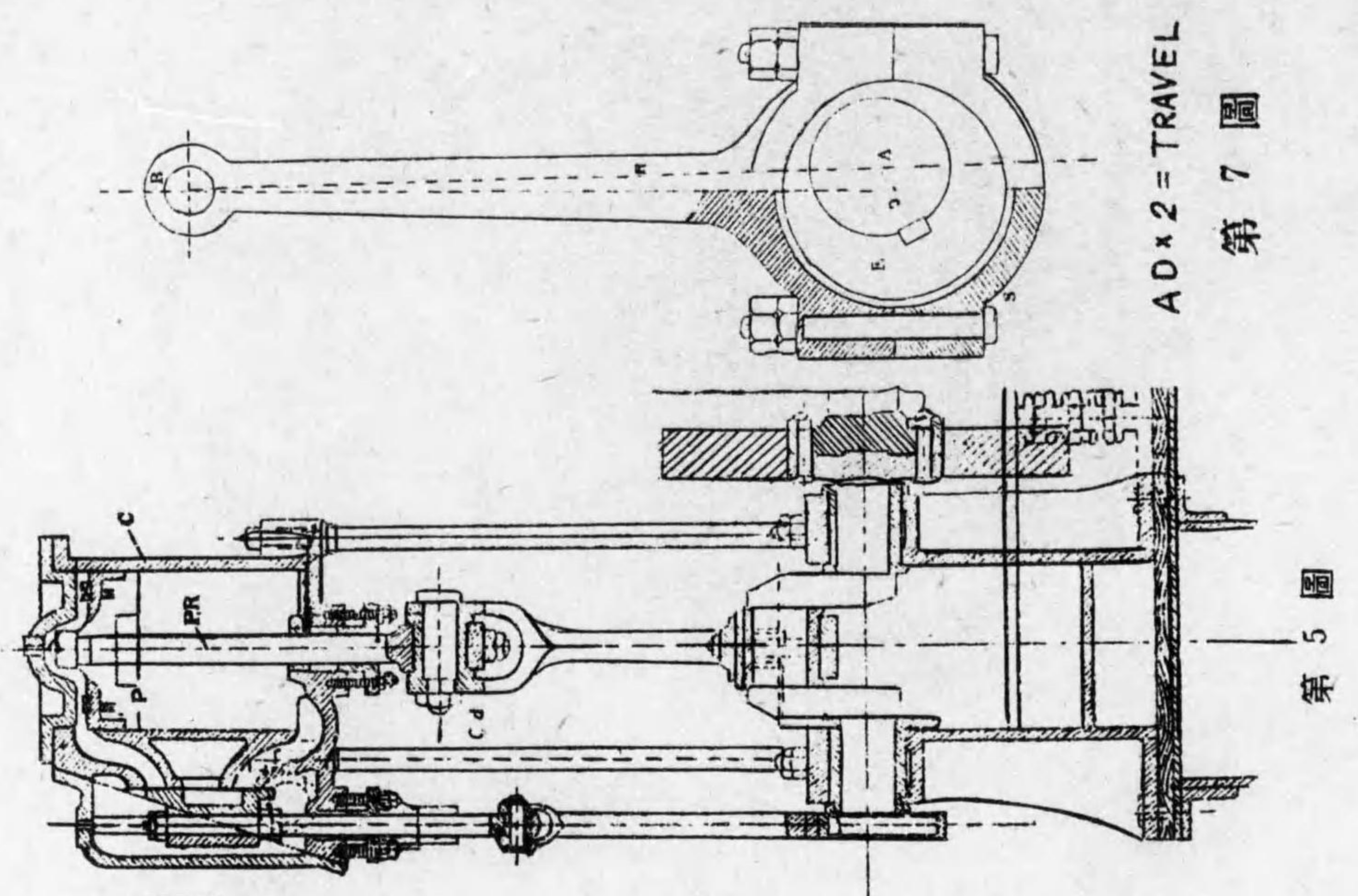

第 7 圖

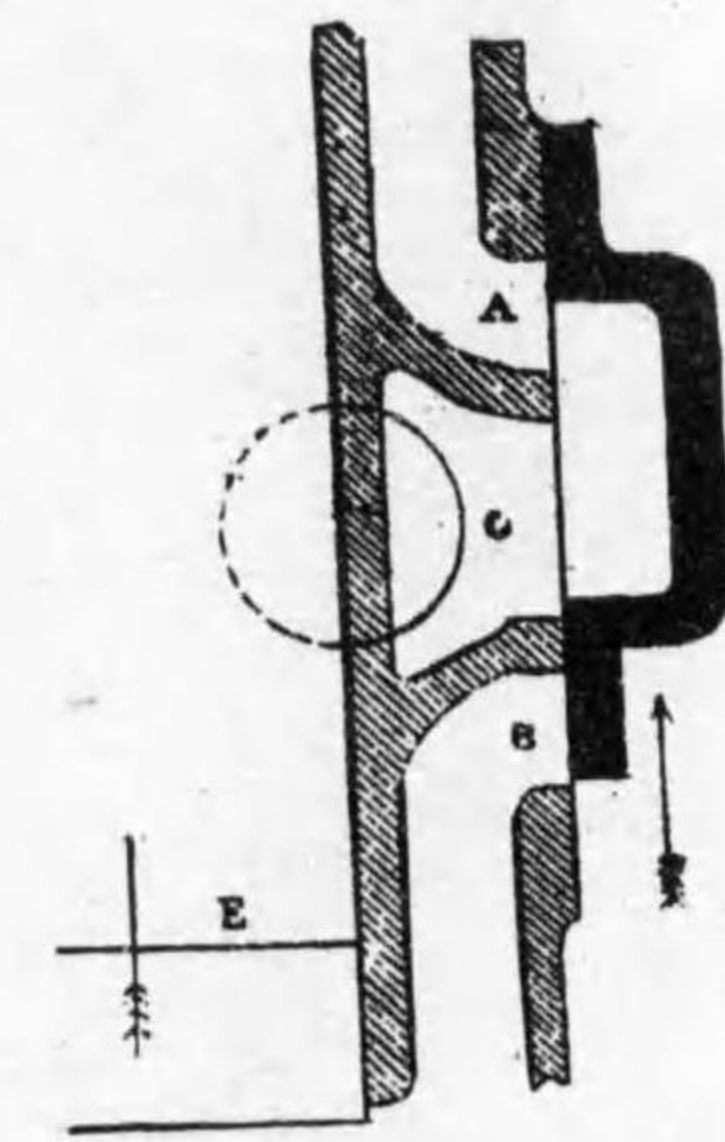
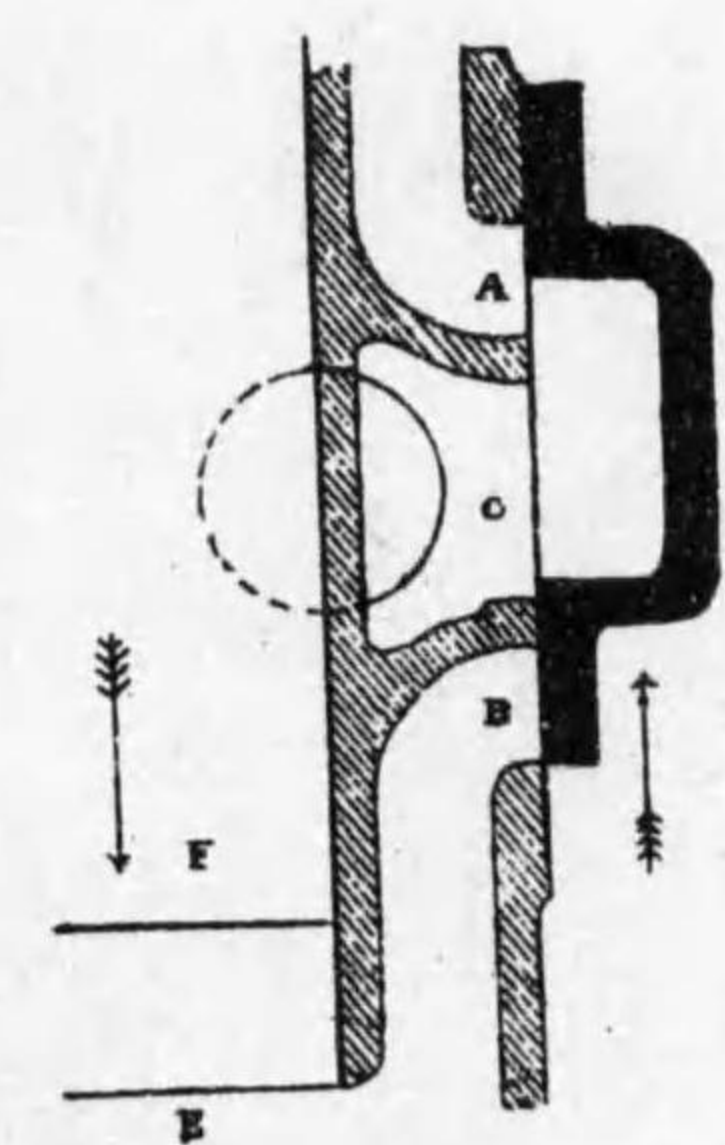
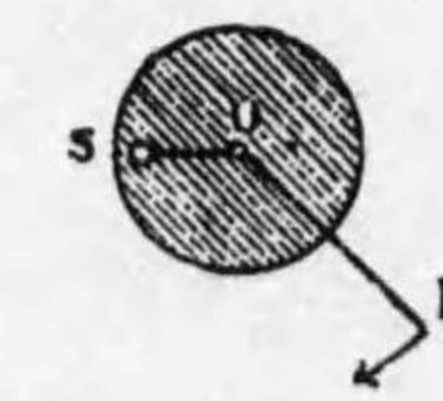
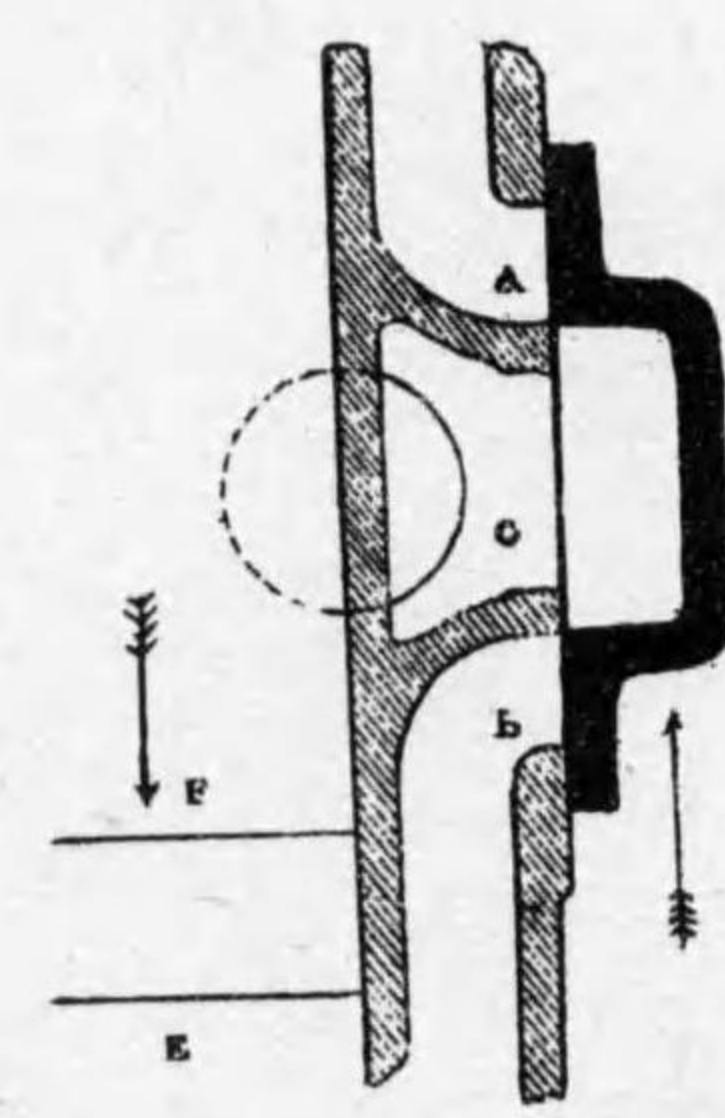
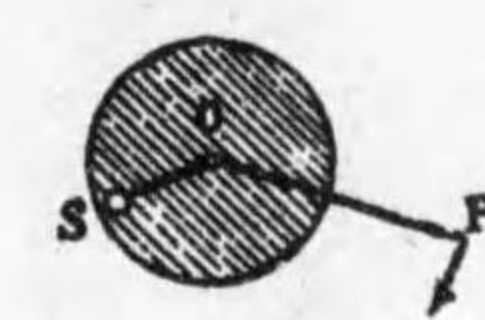
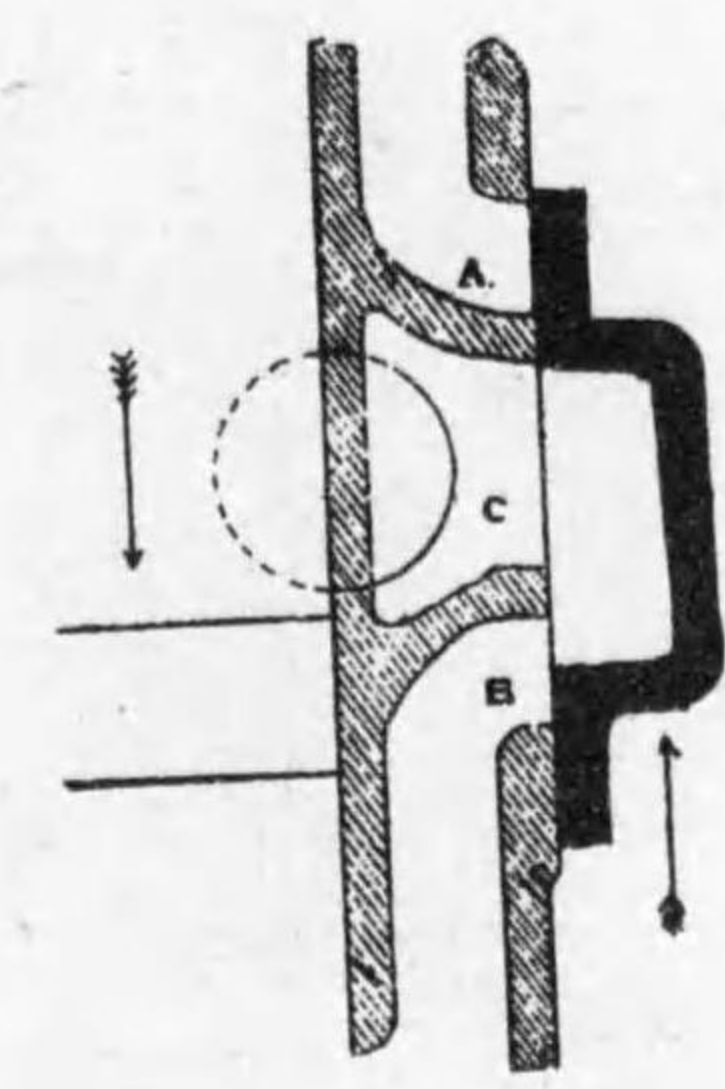
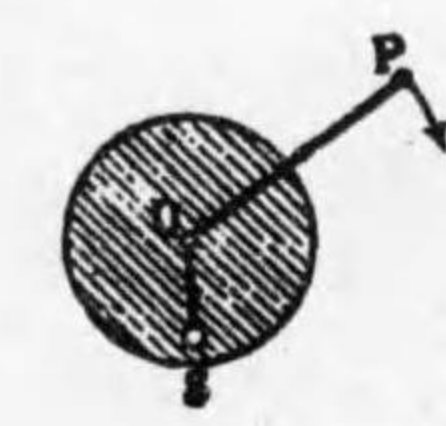
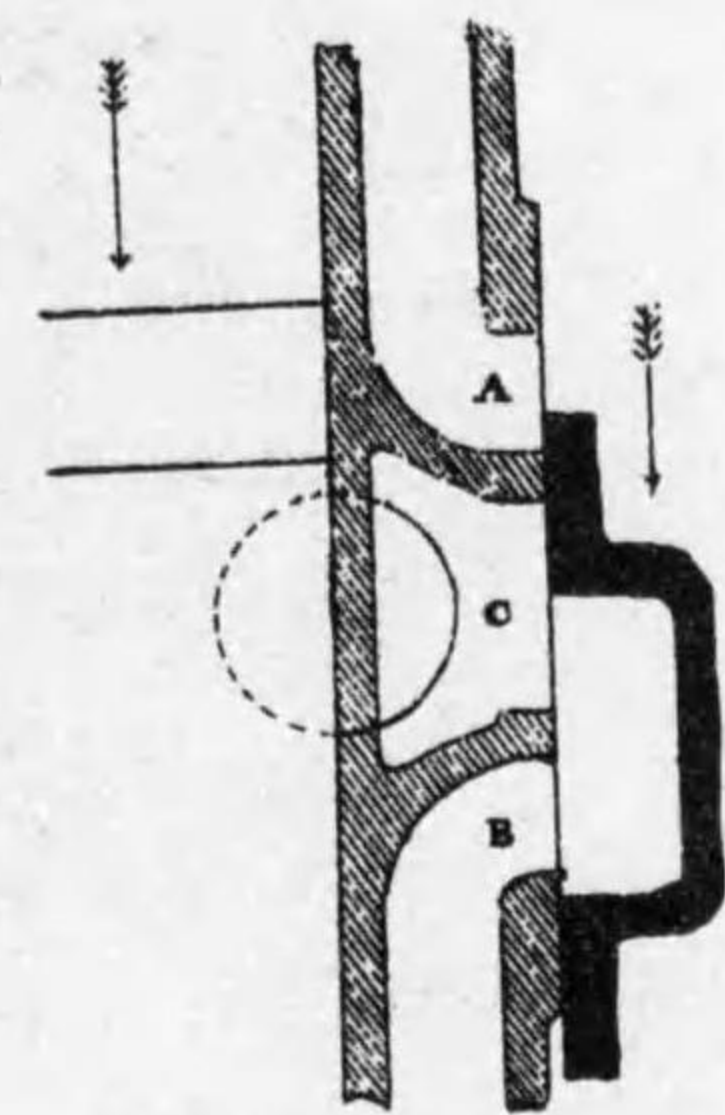
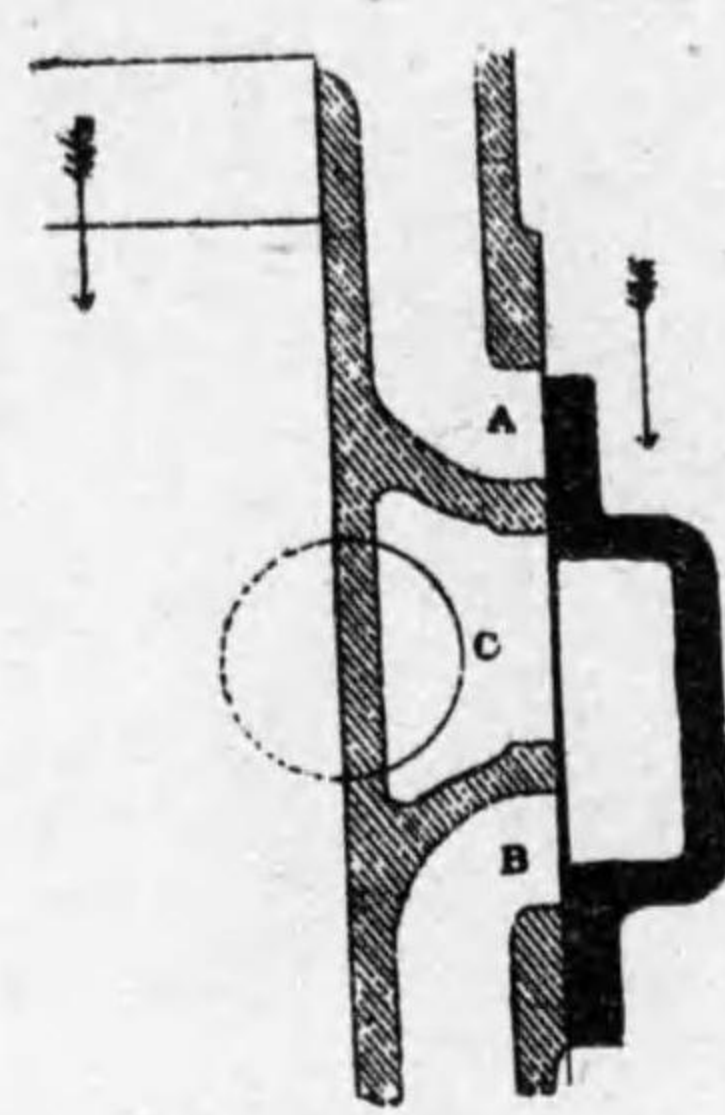
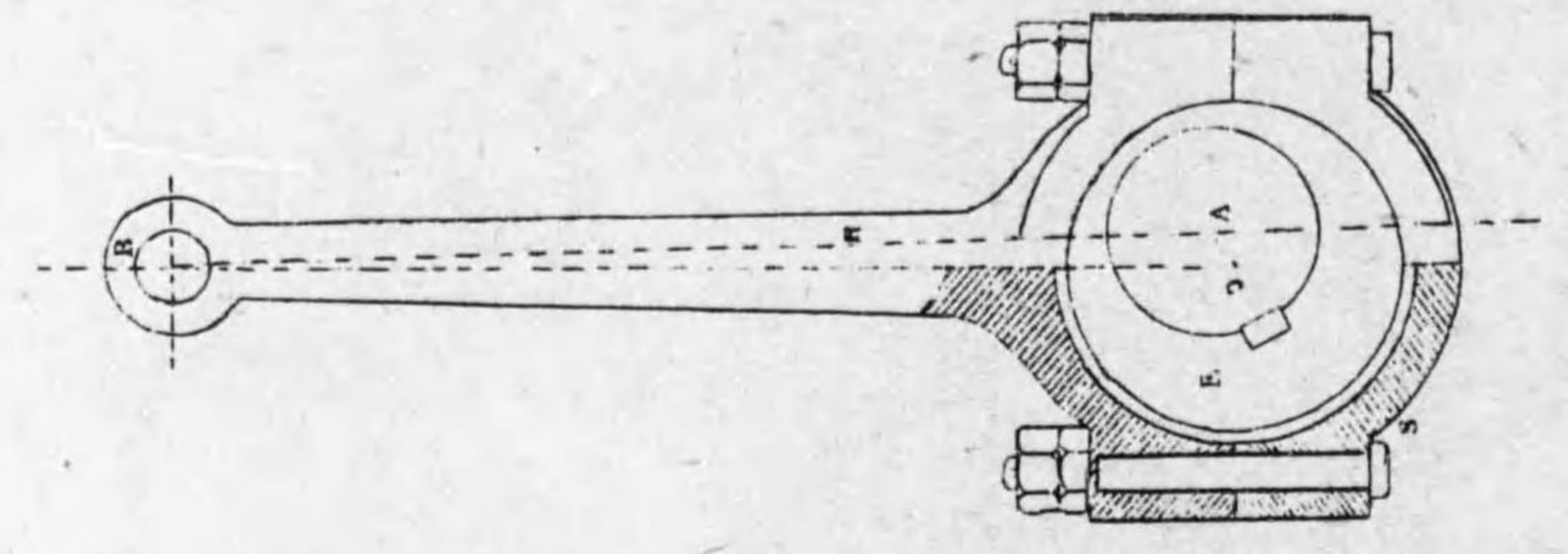

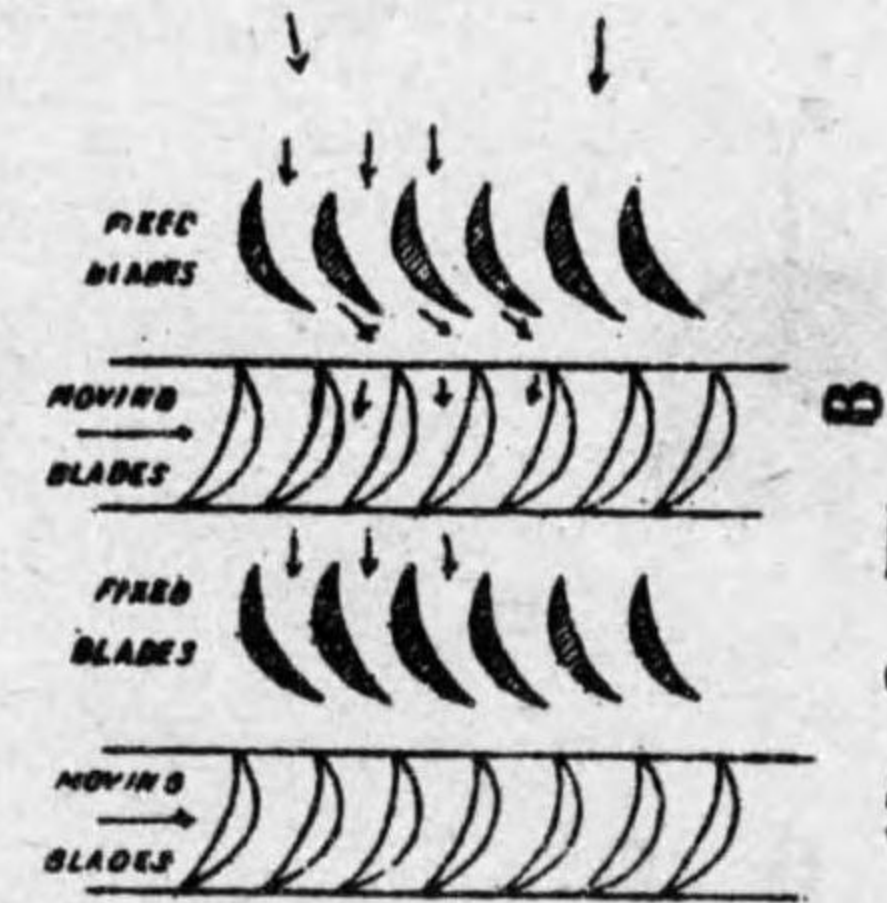
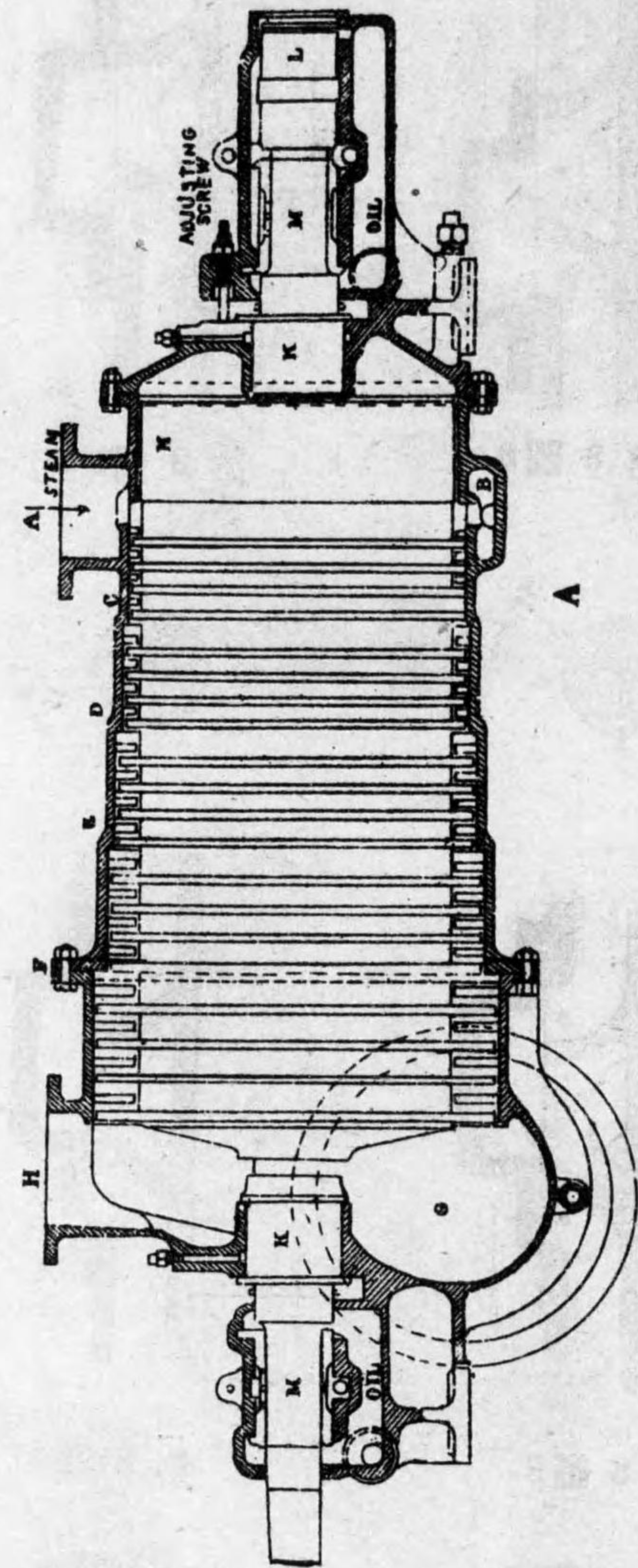

第 9 圖

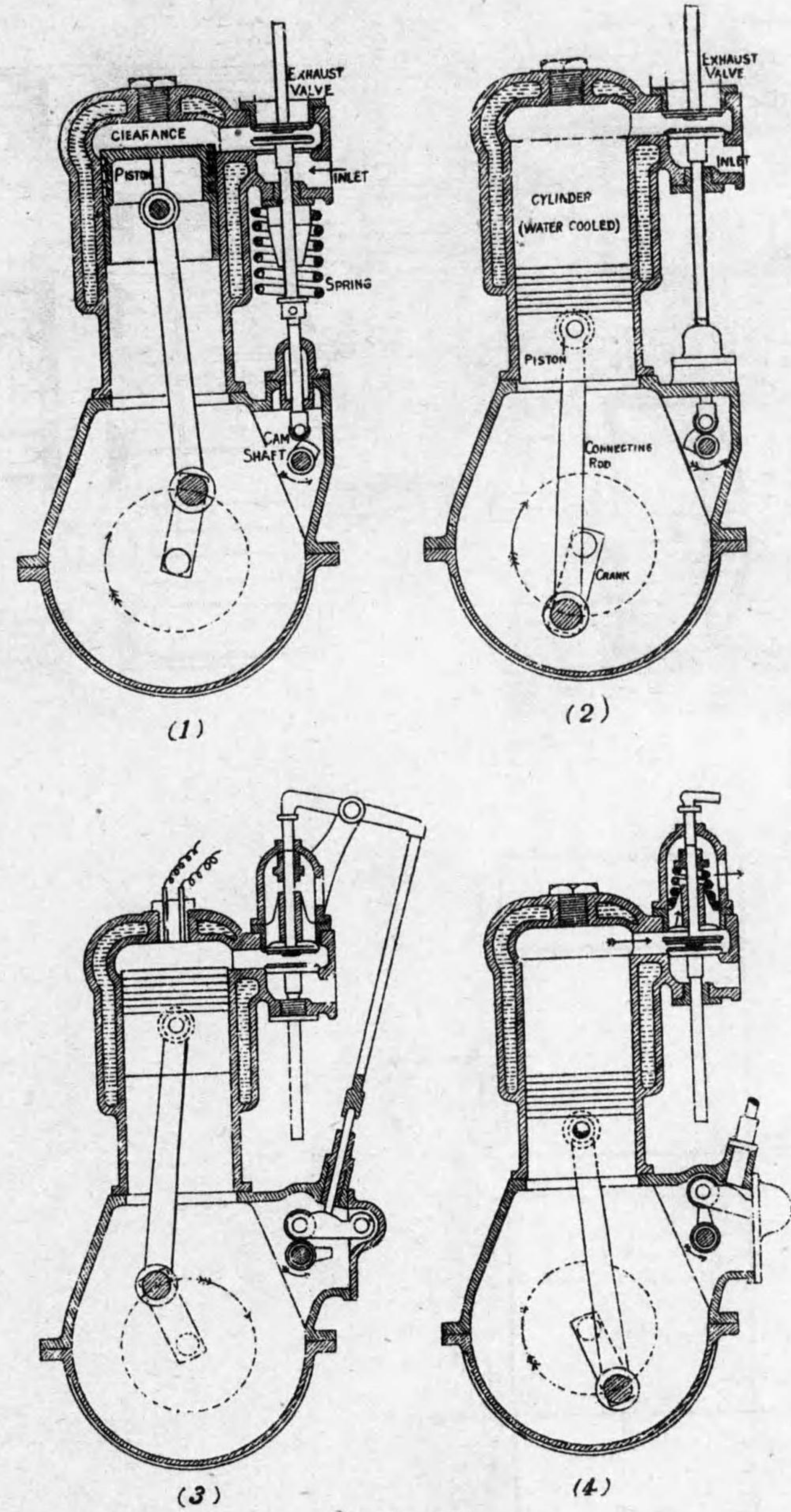

第 10 圖

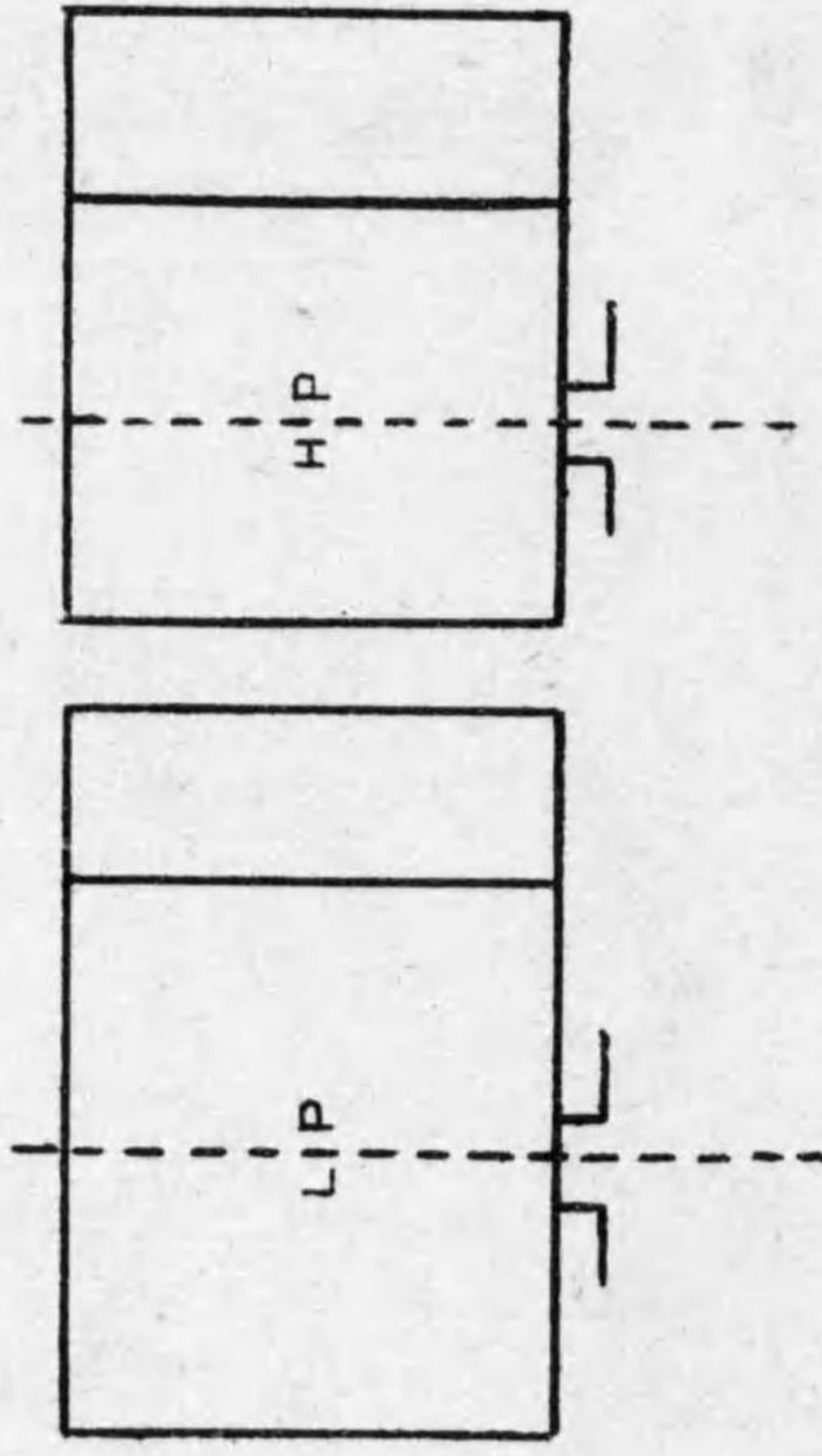

第 11 圖

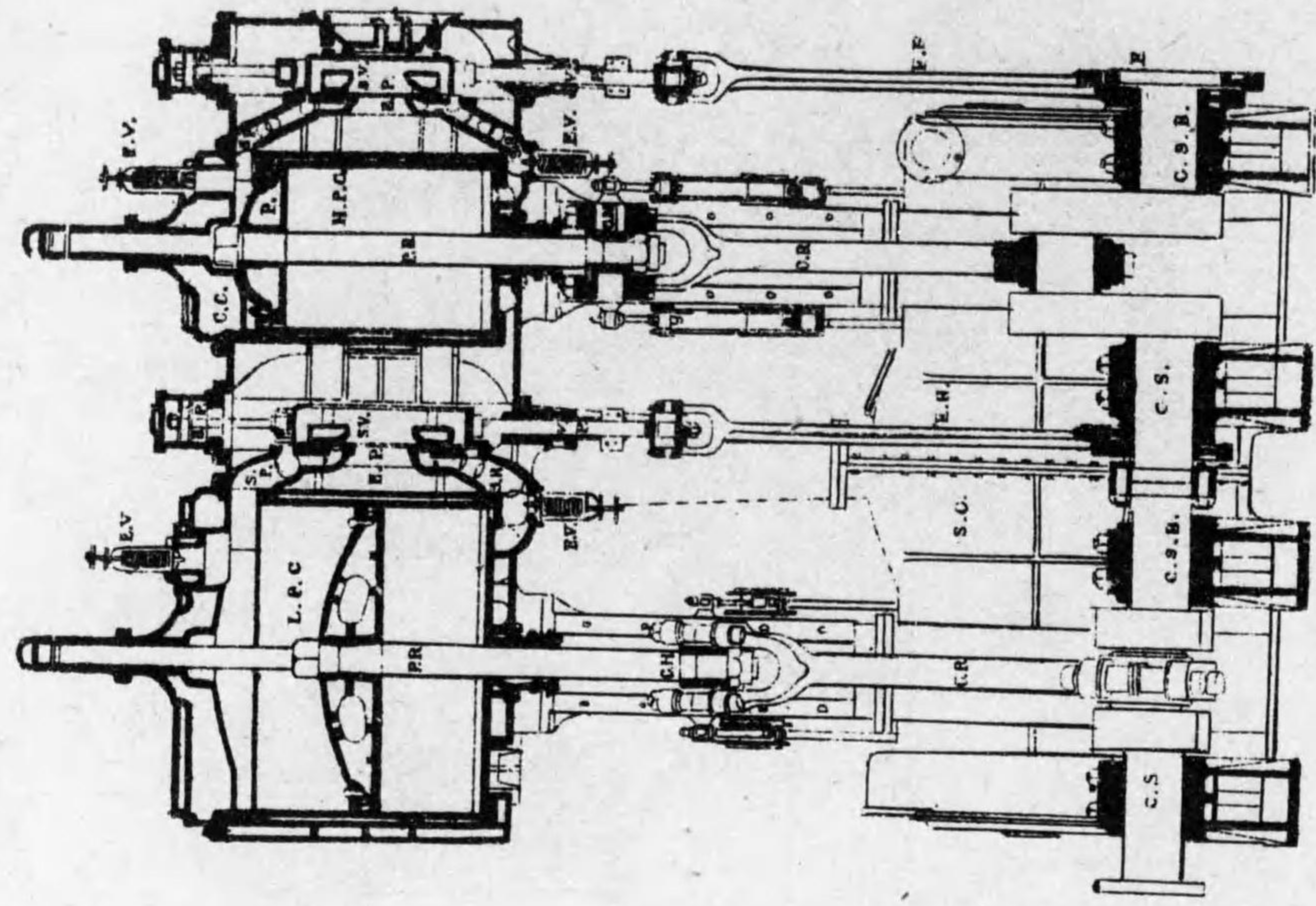

第 12 圖



第 13 圖 A

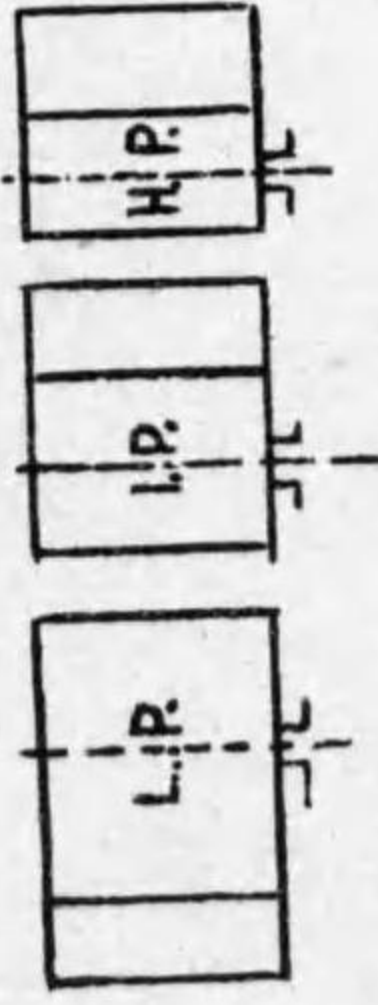

第 13 圖 B

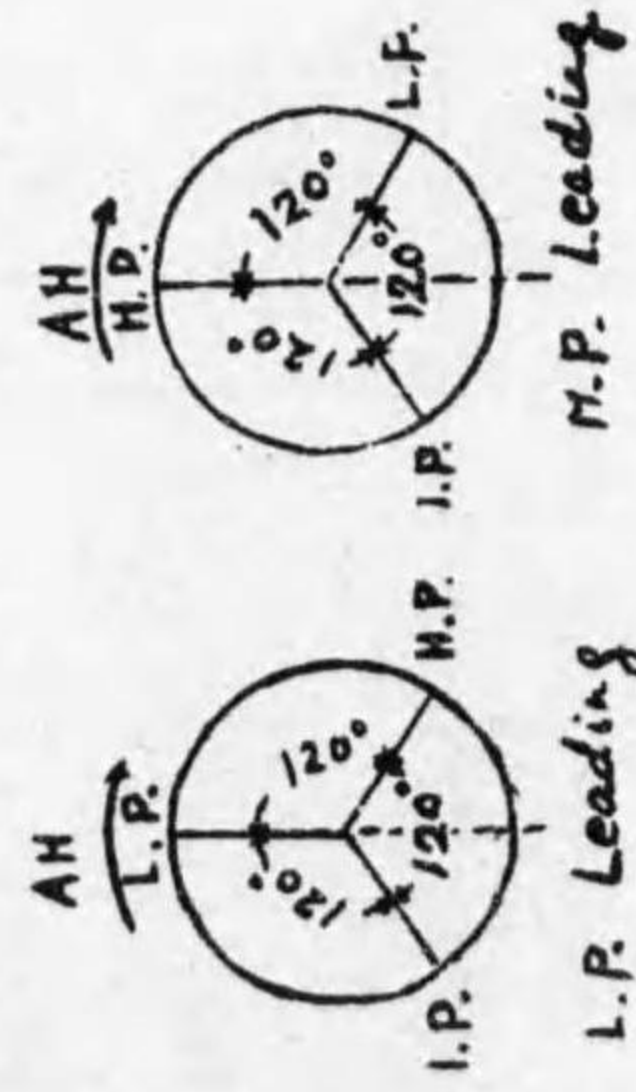

L.P. Leading M.P. Leading
第 14 圖

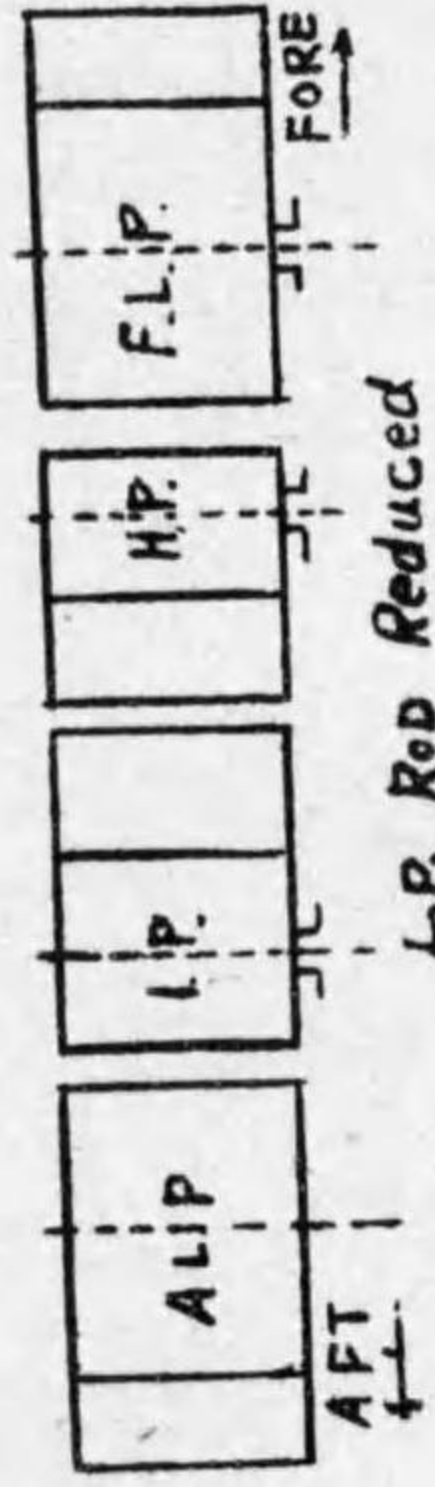

L.P. Rod Reduced
第 15 圖 A



第 15 圖 B

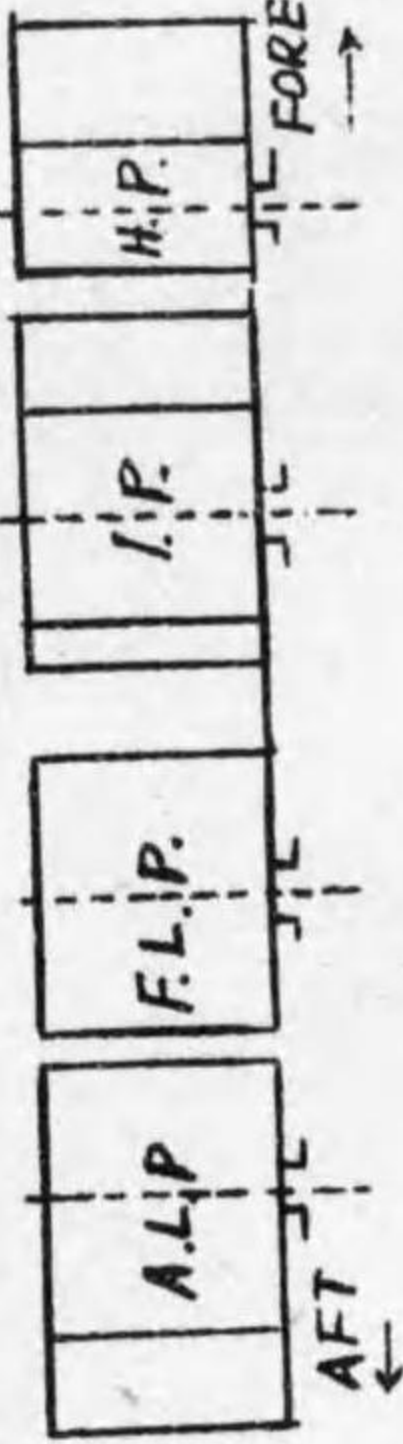

第 15 圖 C



第 16 圖 A

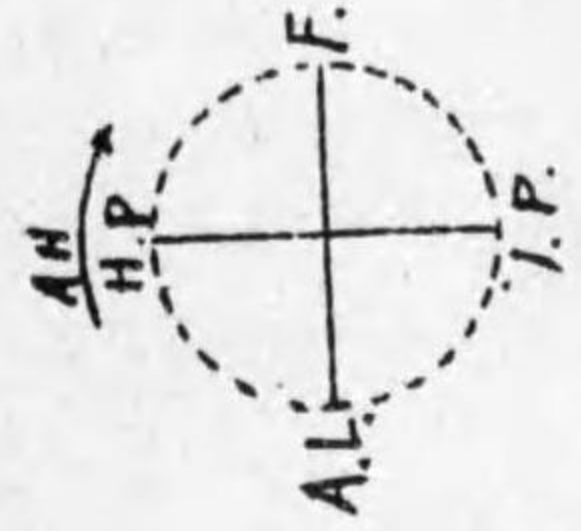

第 16 圖 B

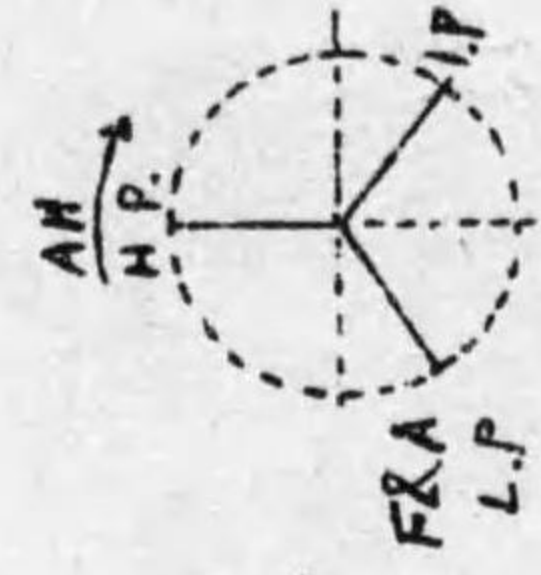

第 16 圖 C

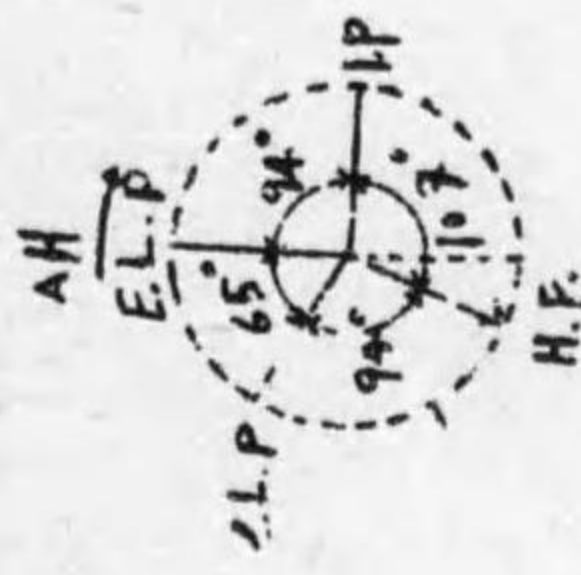

第 17 圖

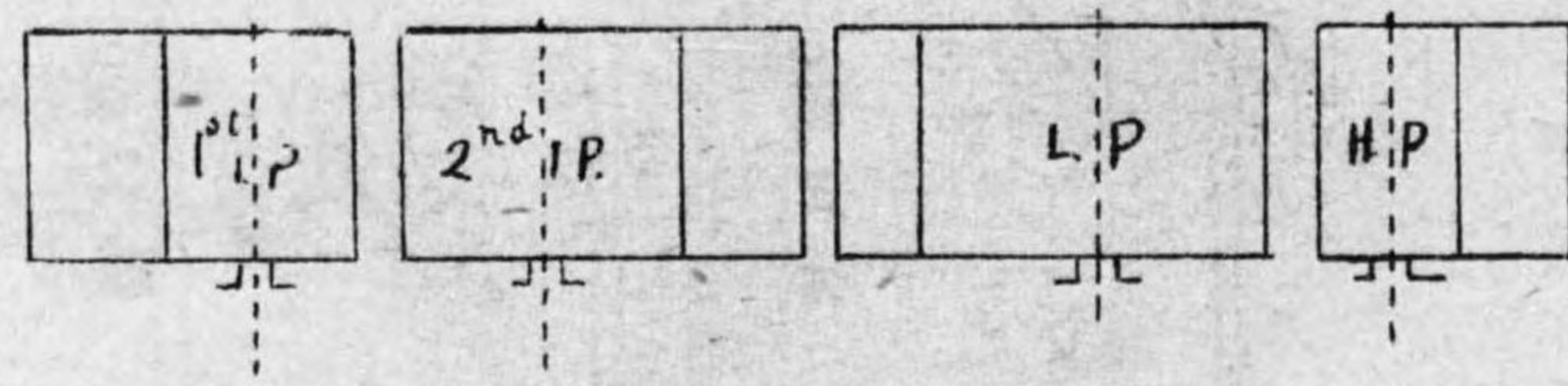

第 18 圖 A

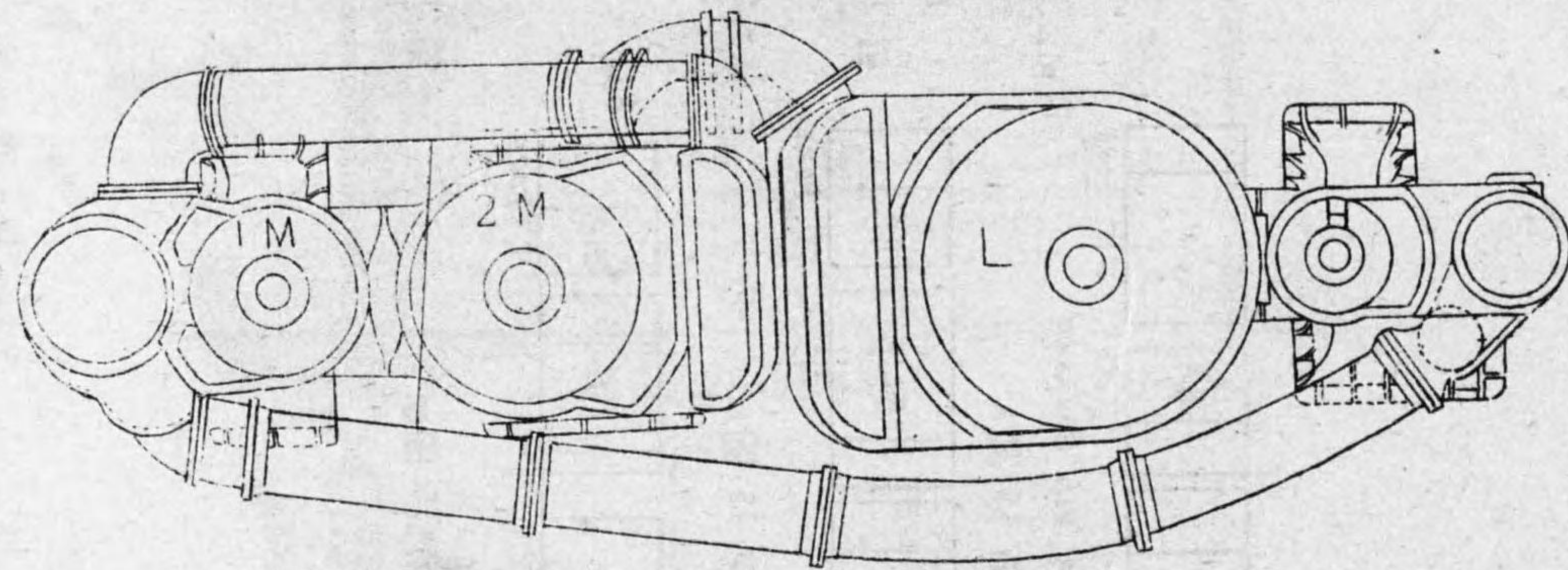

第 18 圖 B

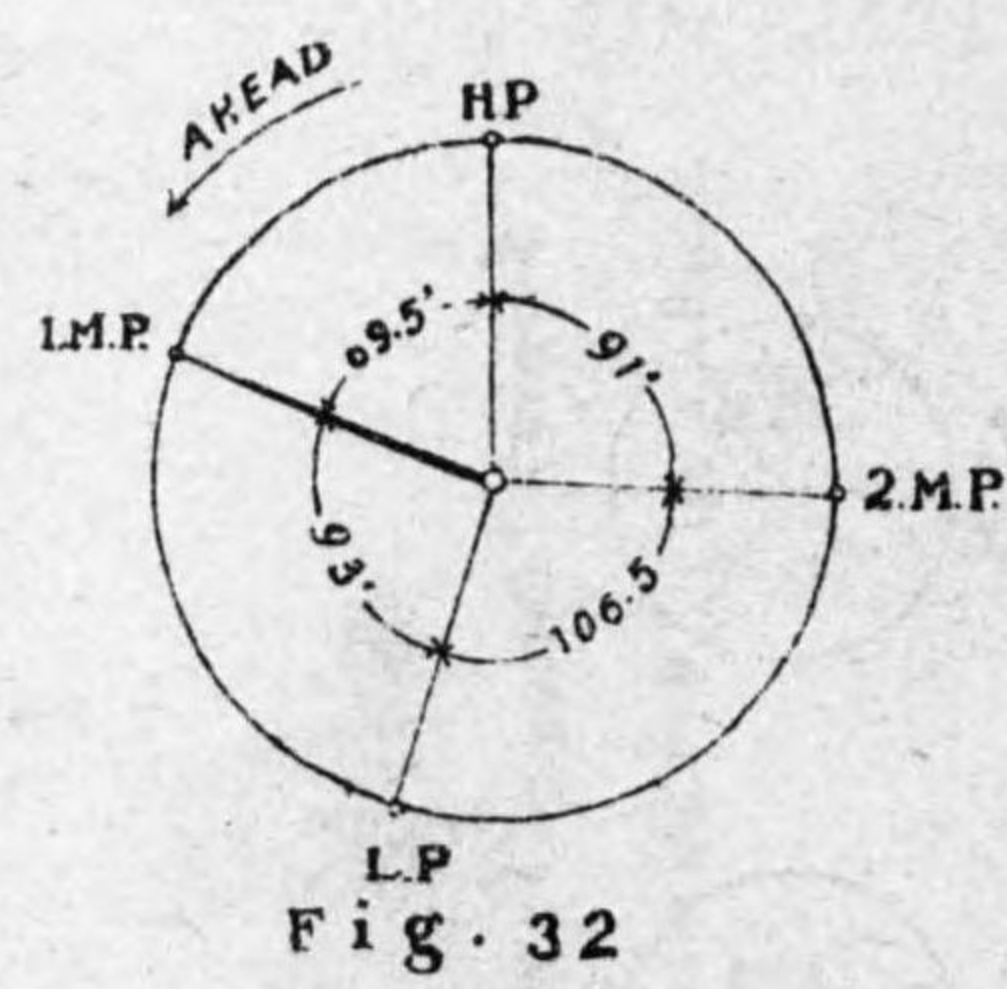
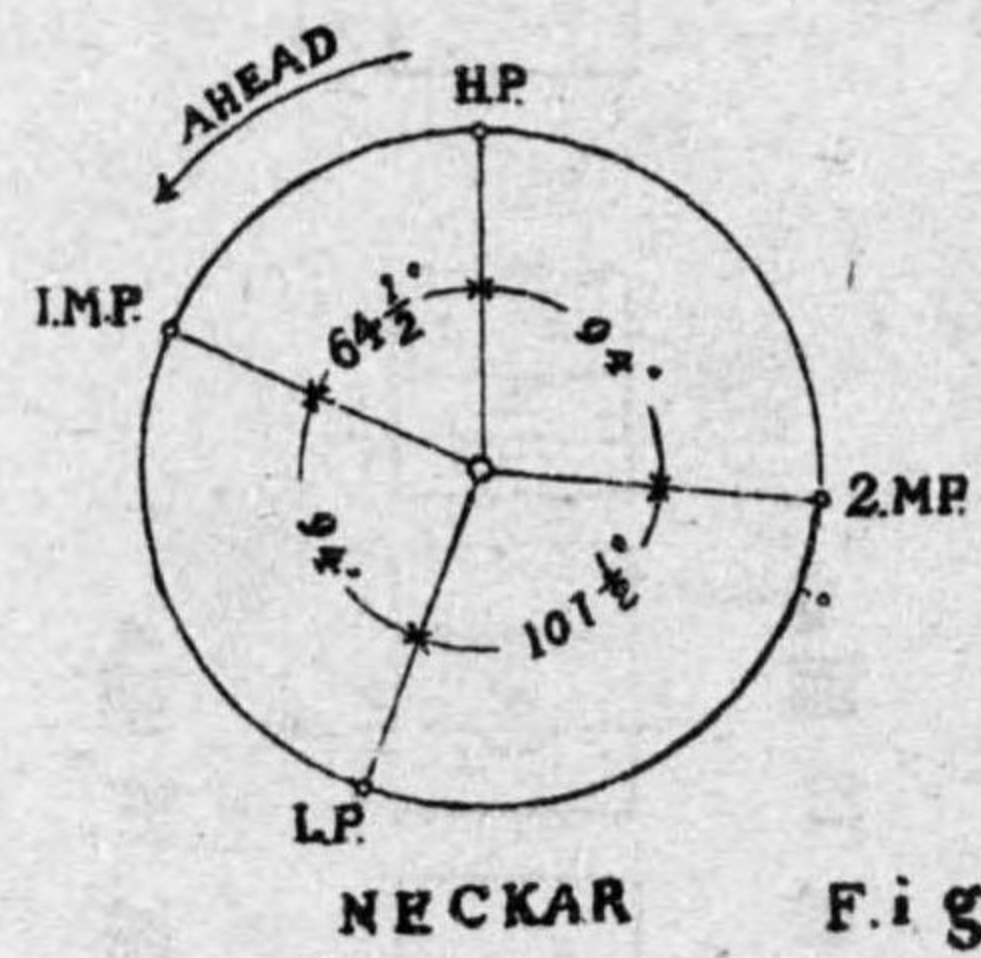
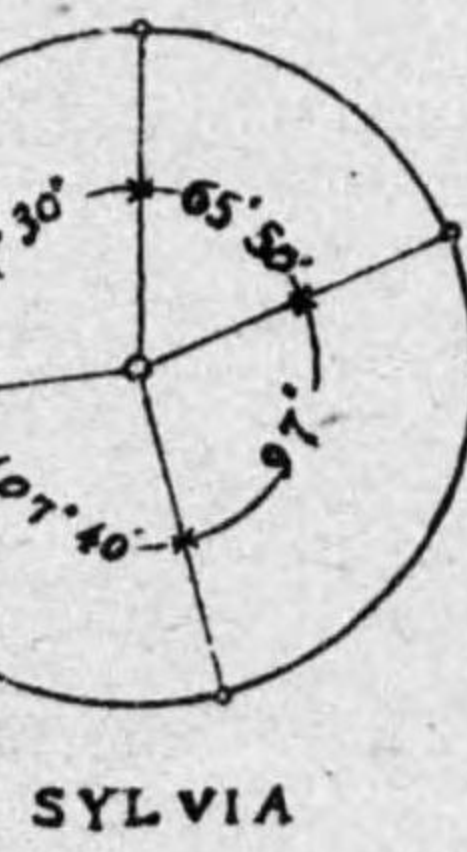

Fig. 32



NECKAR

Fig. 33.



SYLVIA

第 18 圖 C

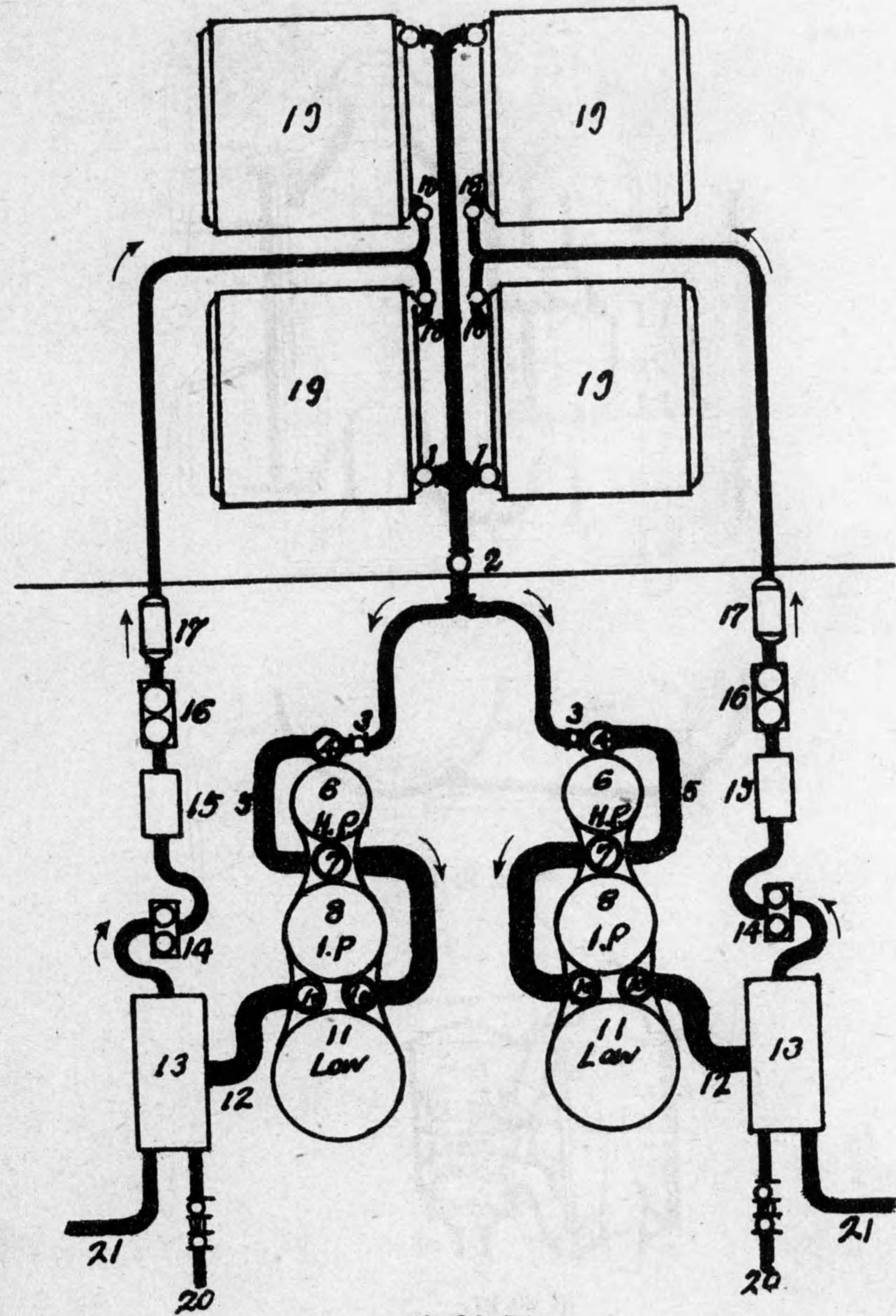

第 19 圖

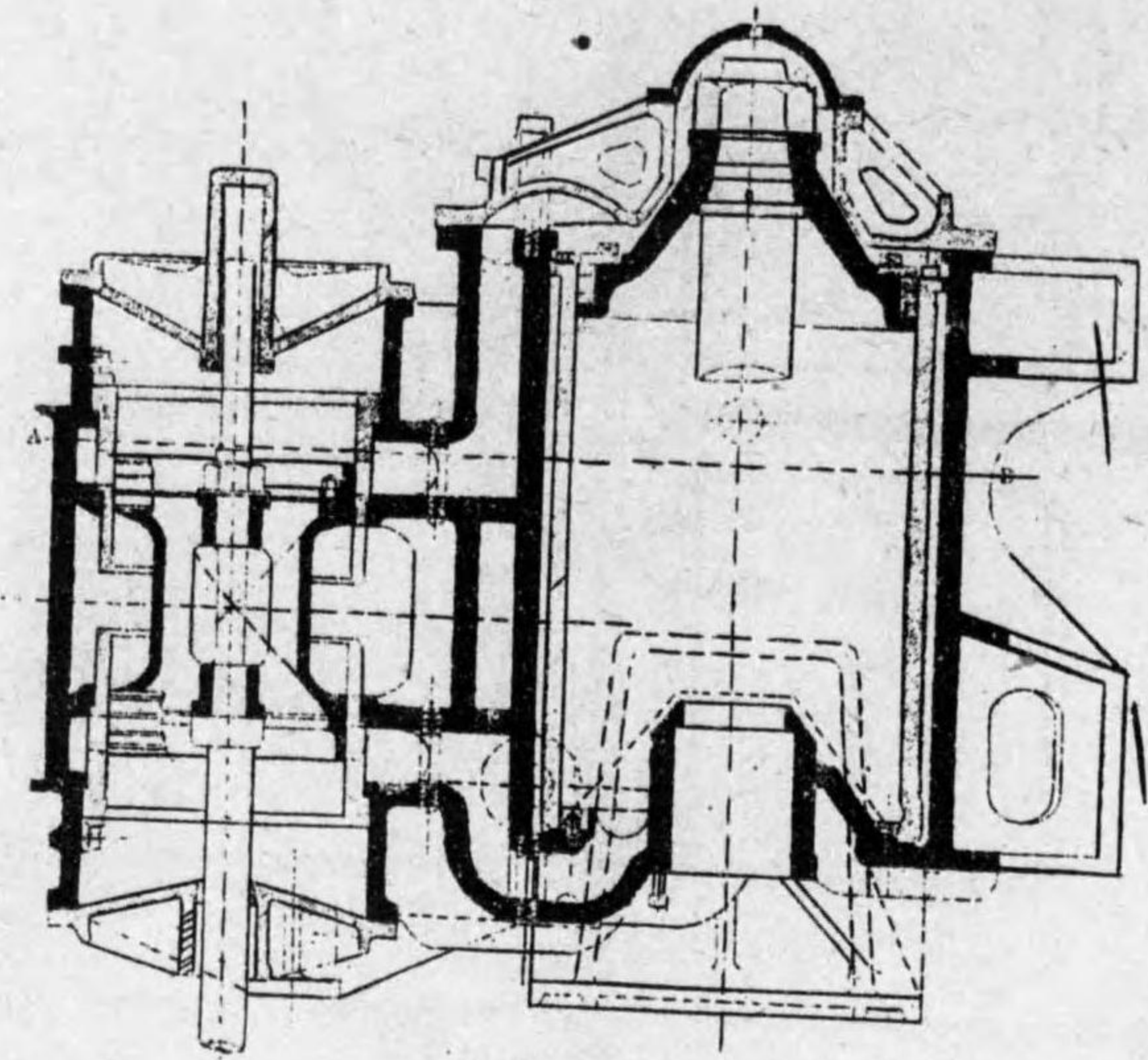

第 20 圖 A

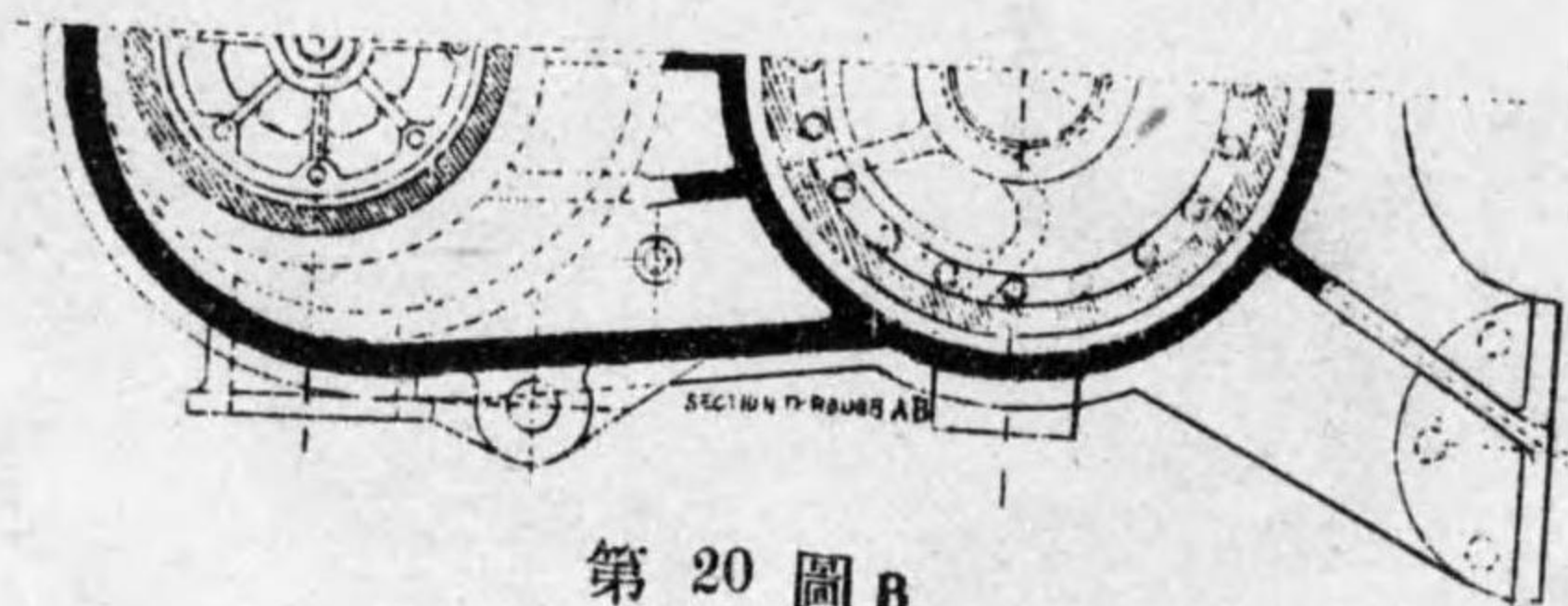

第 20 圖 B

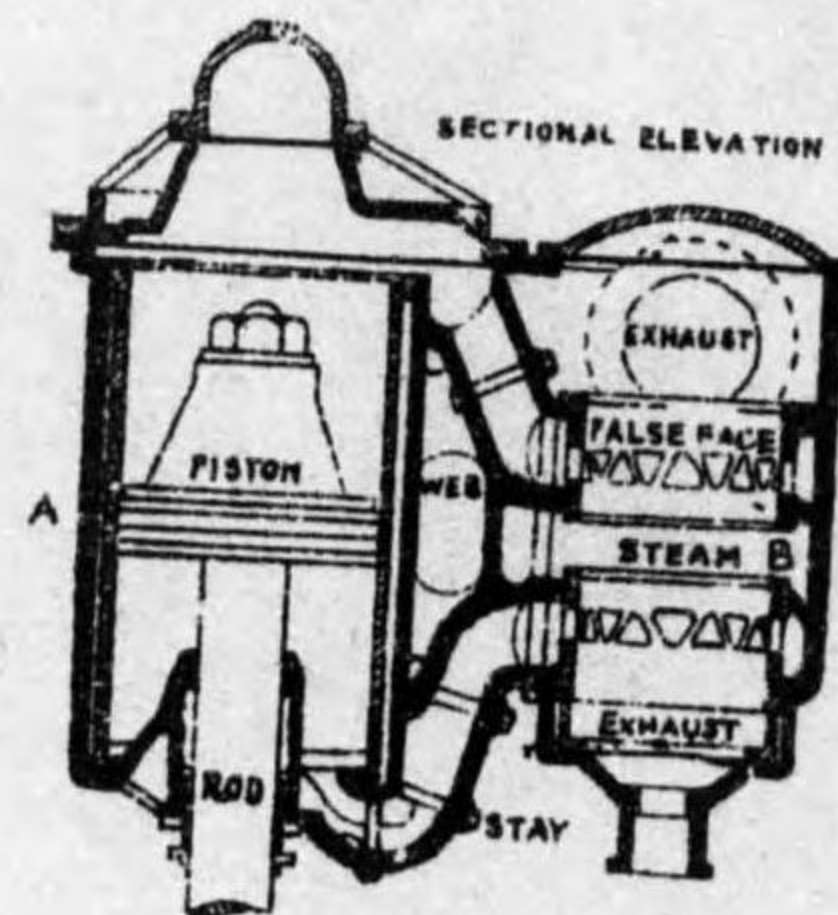

第 20 圖 C

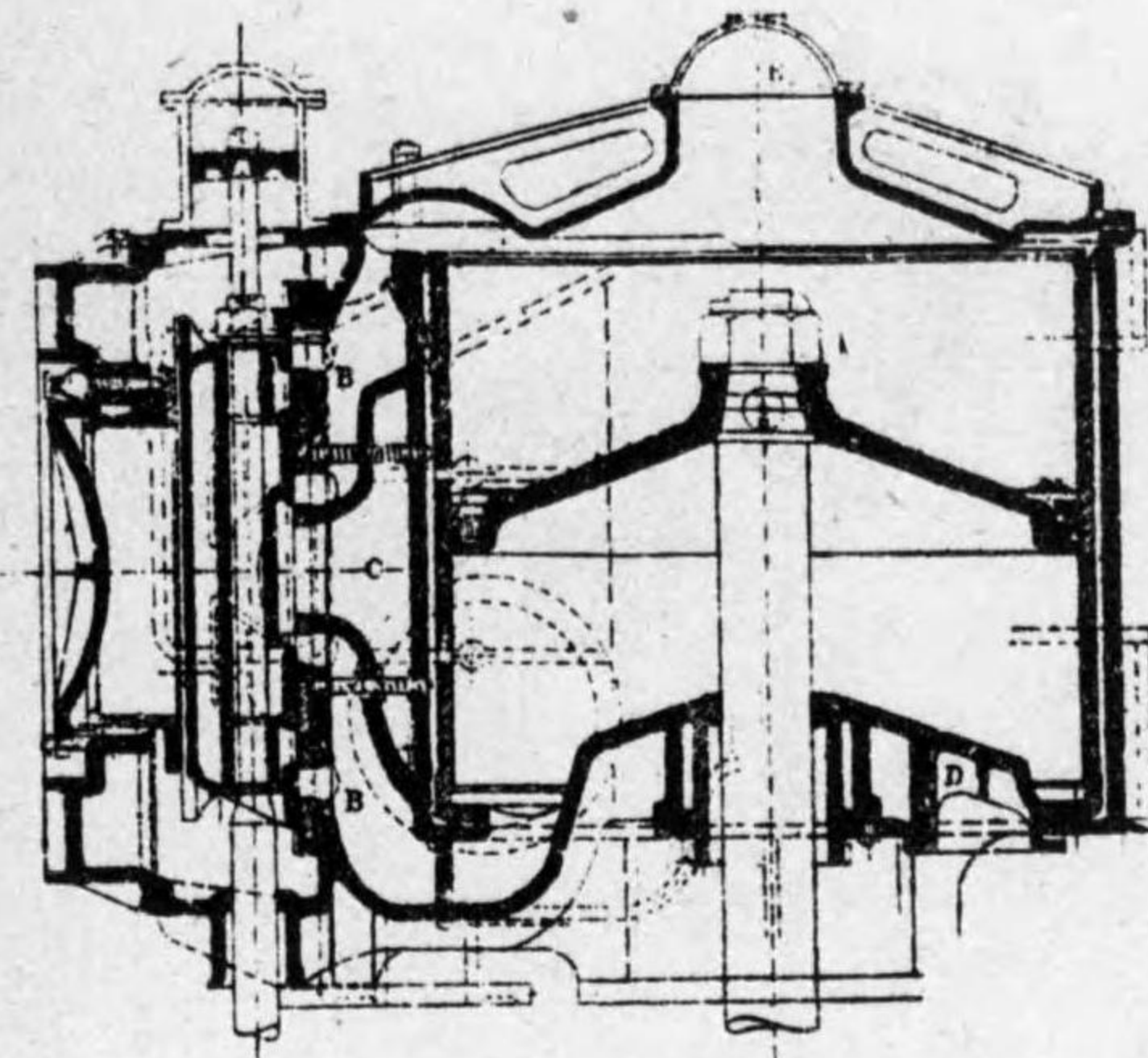

第 21 圖 A

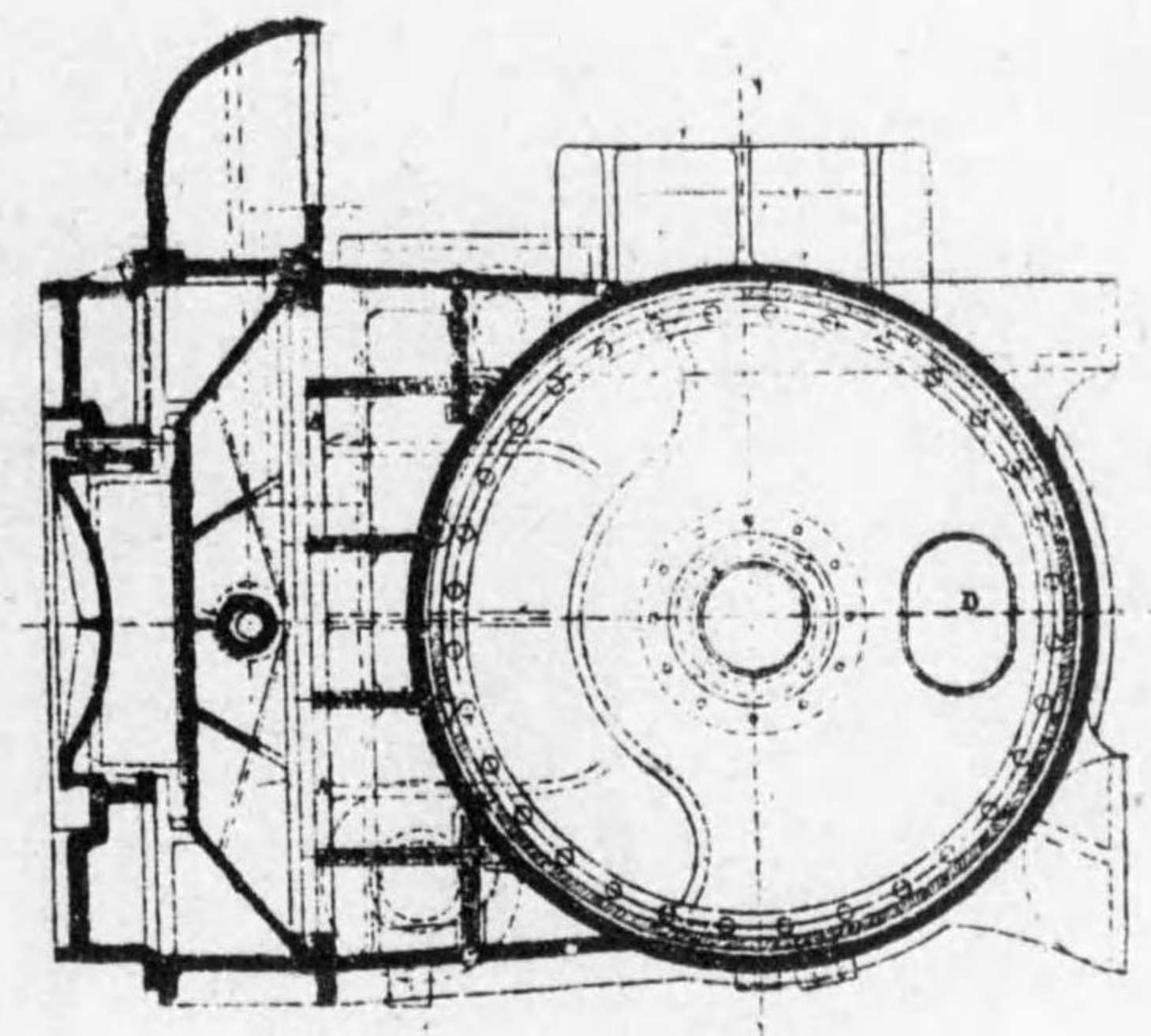

第 21 圖 B

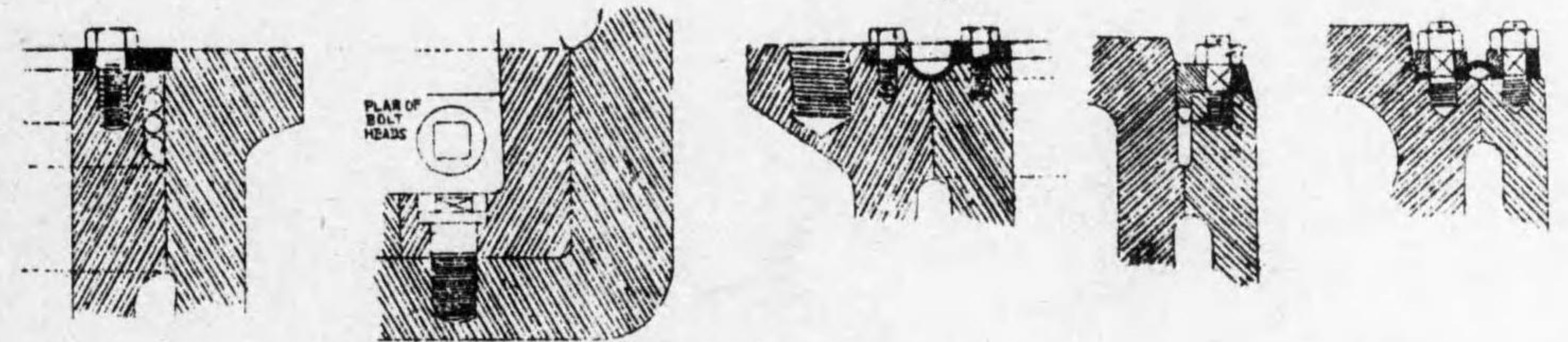

第 22 圖 A

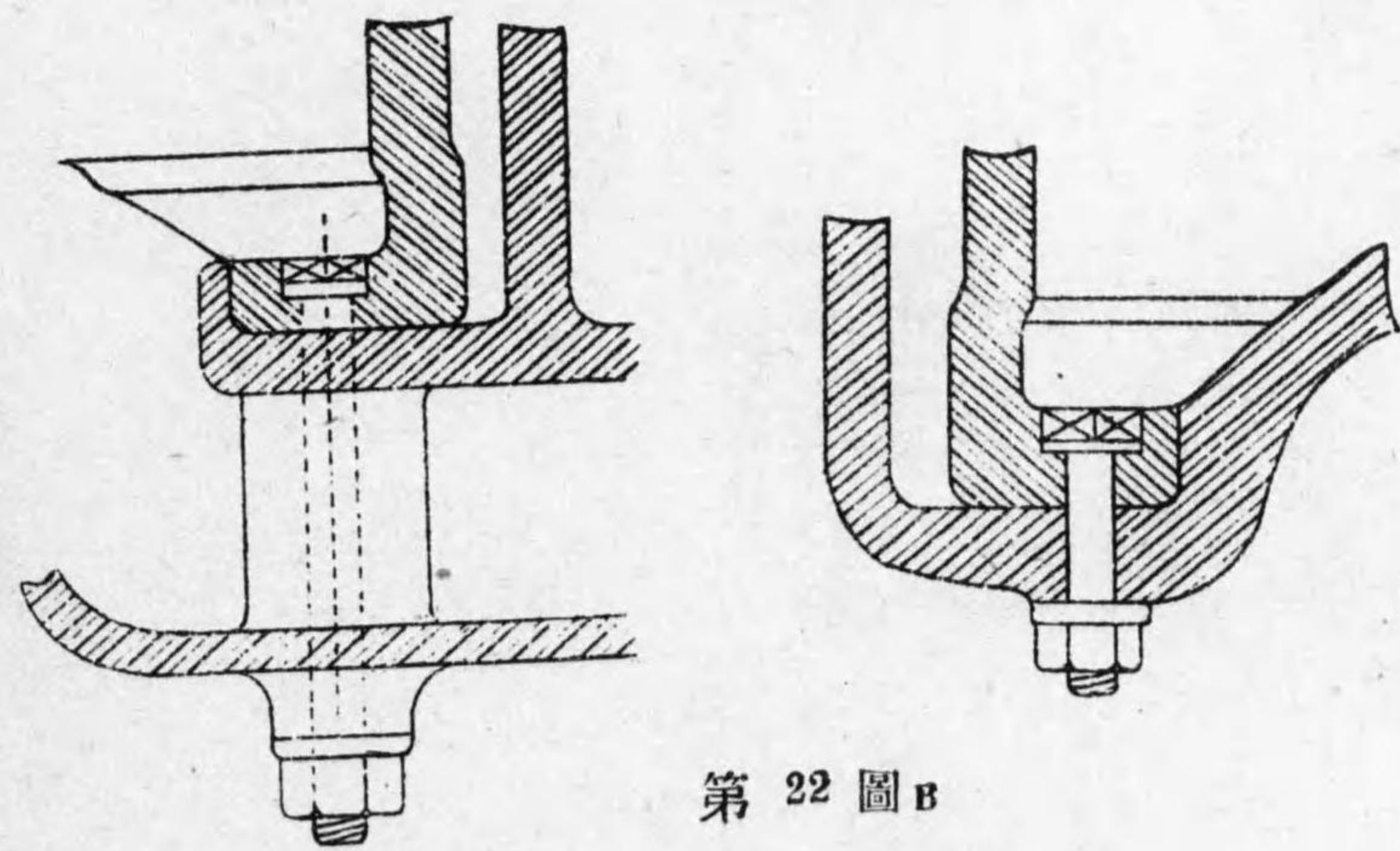

第 22 圖 B

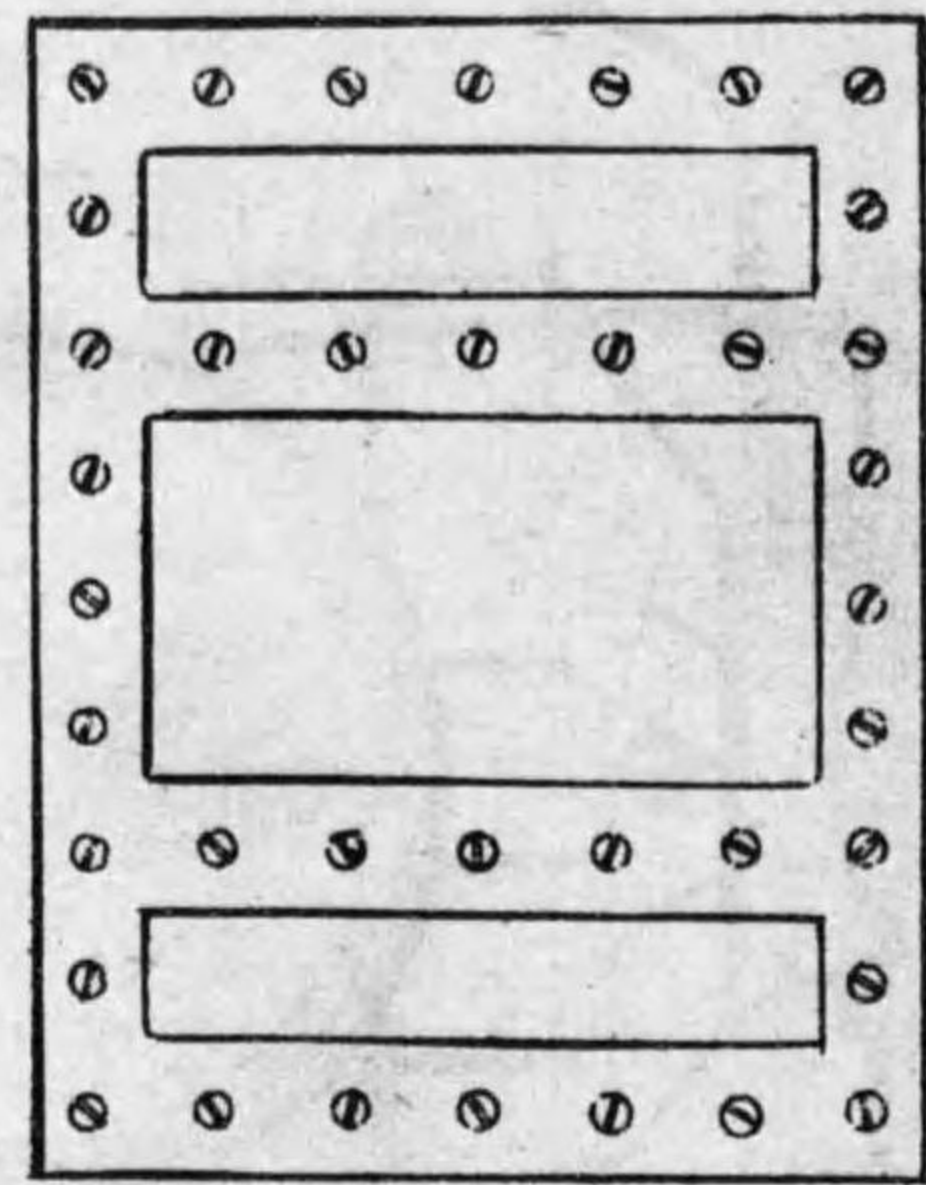

第 23 圖

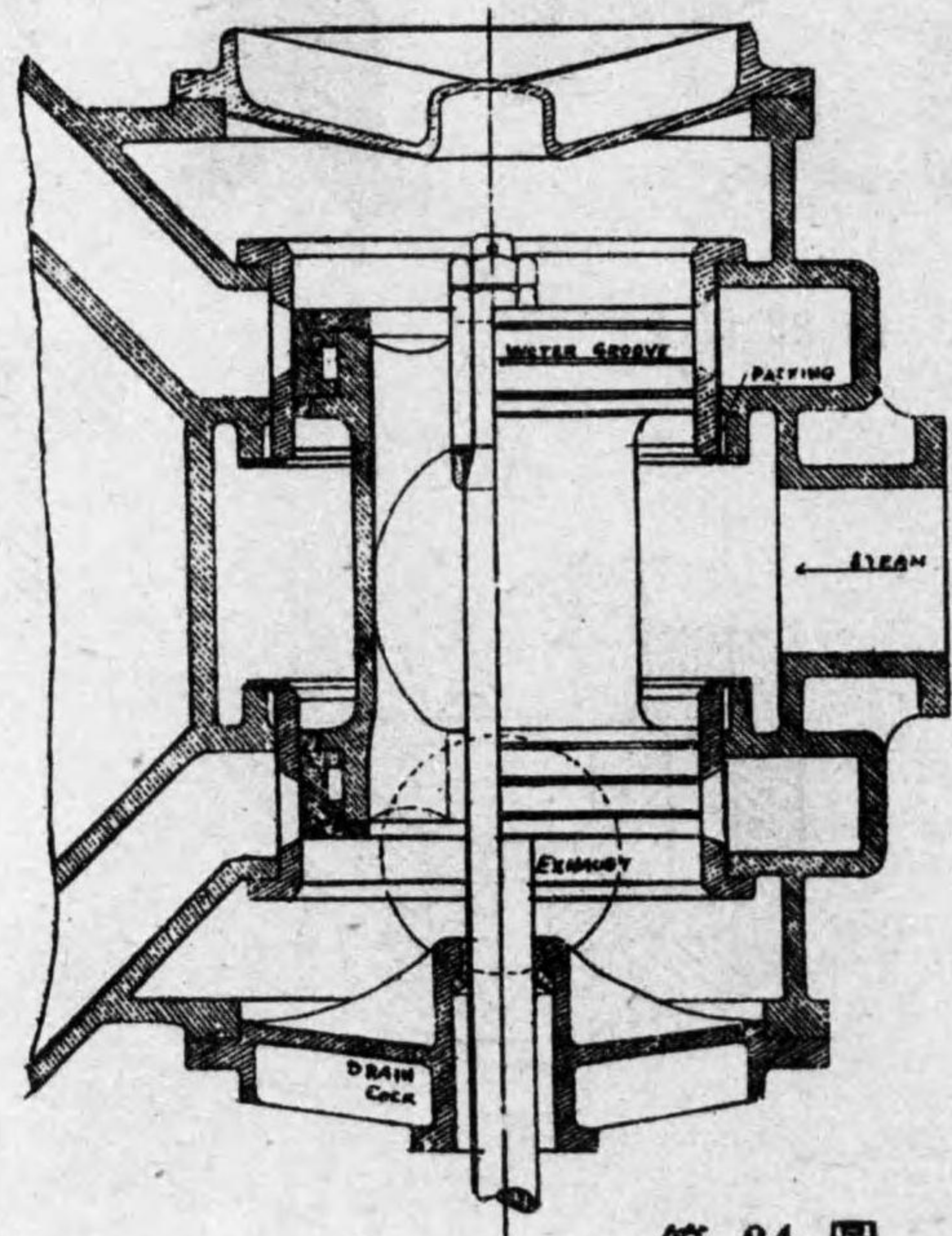
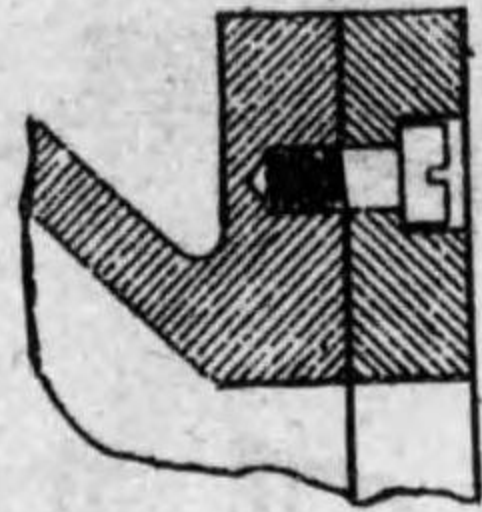

第 24 圖

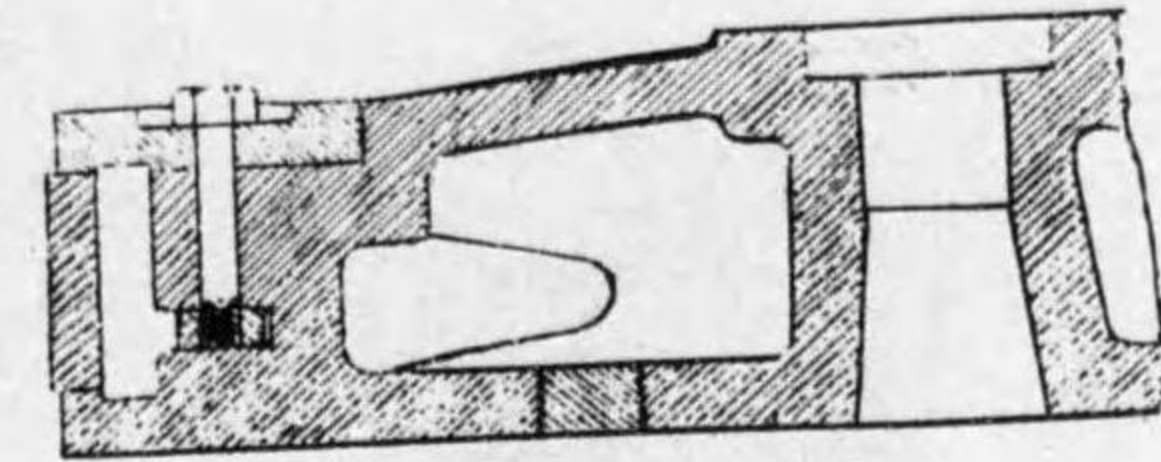
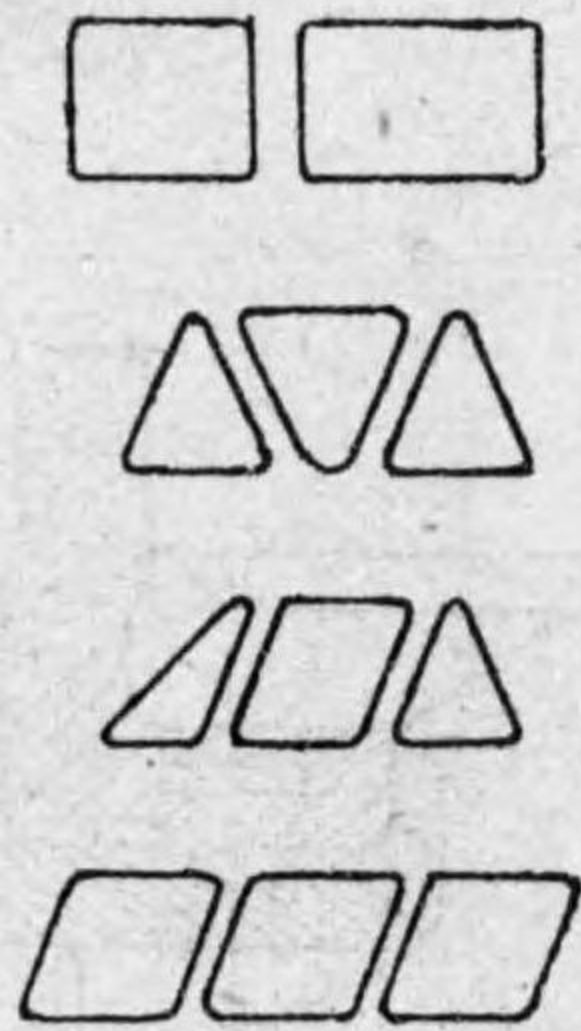

第 25 圖

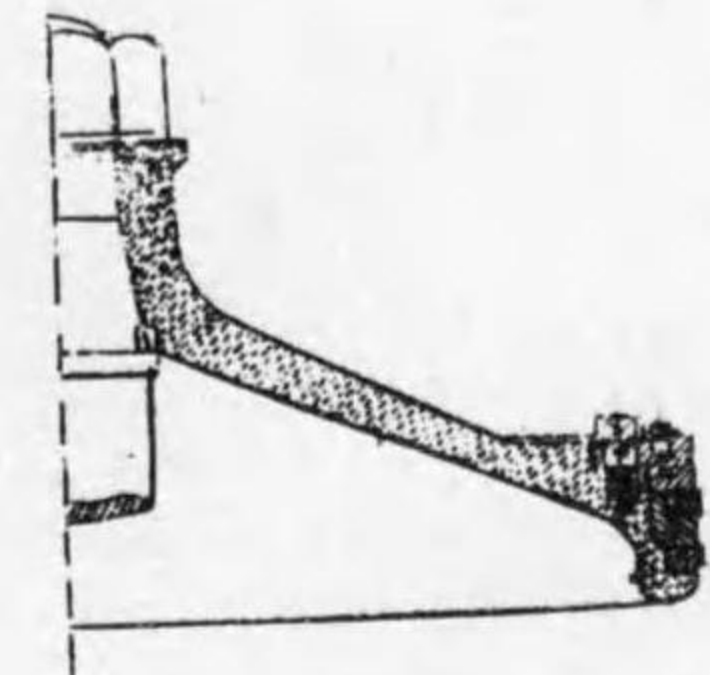

第 27 圖 A

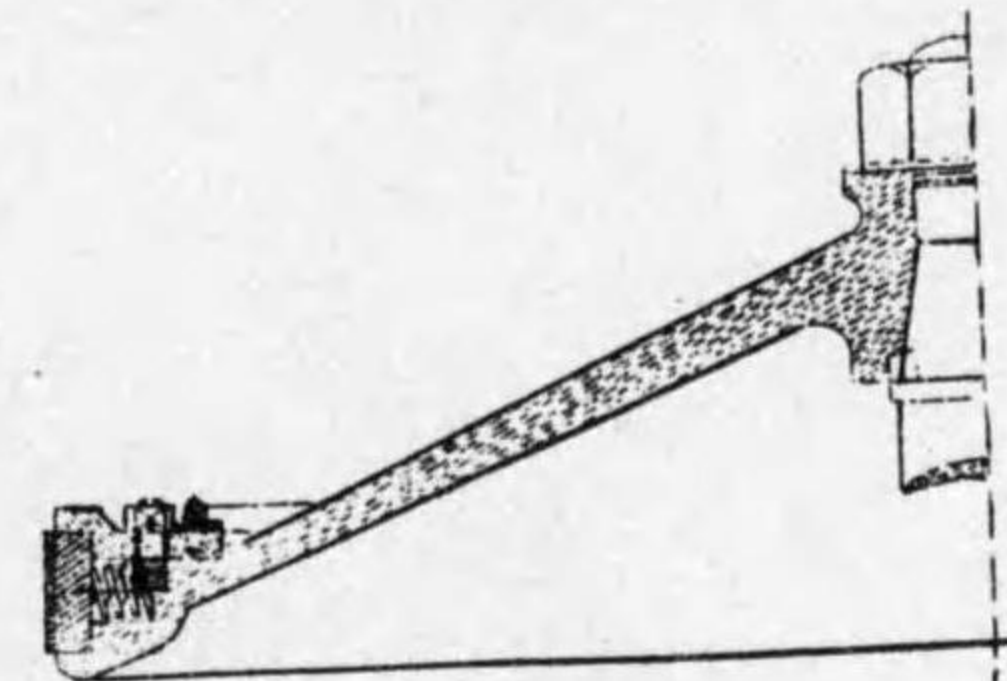

第 26 圖 A

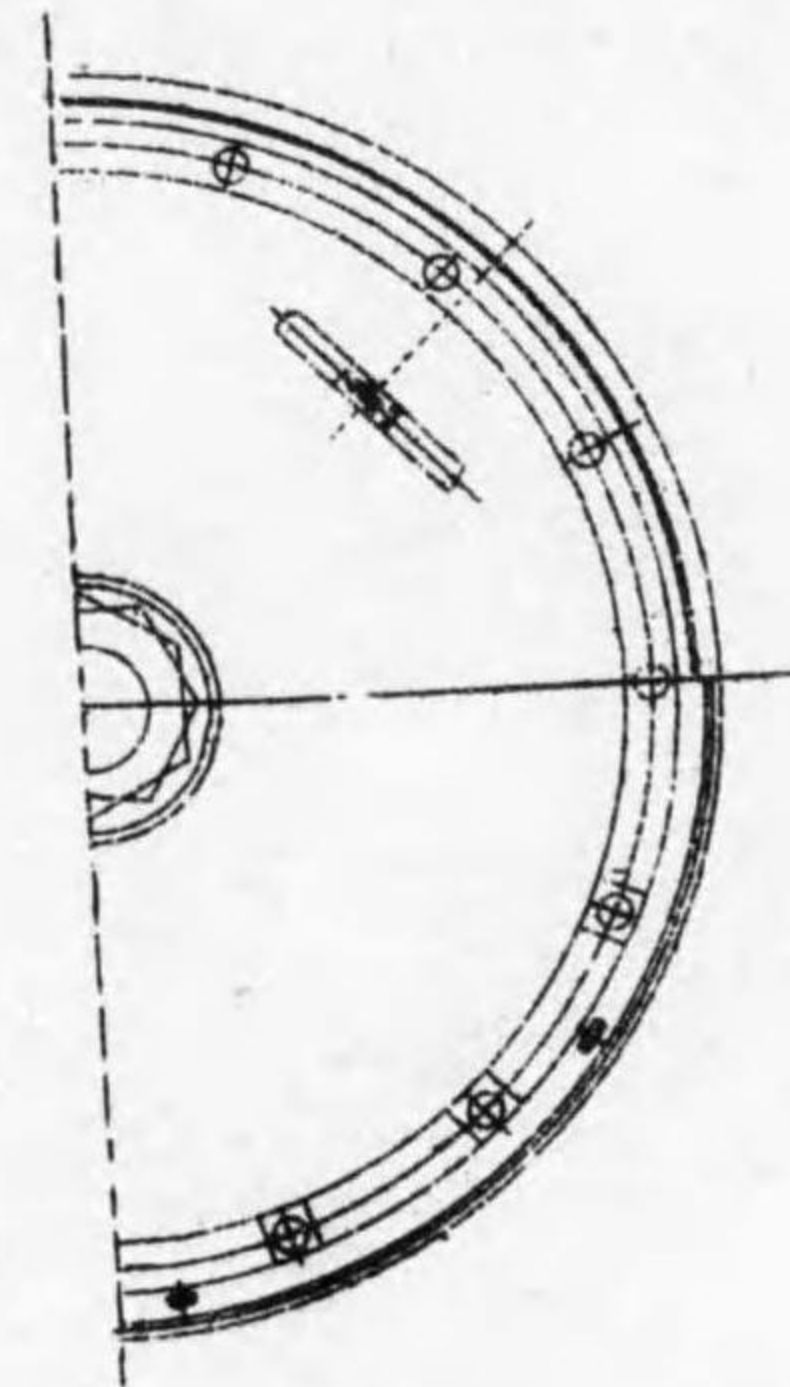

第 27 圖 B

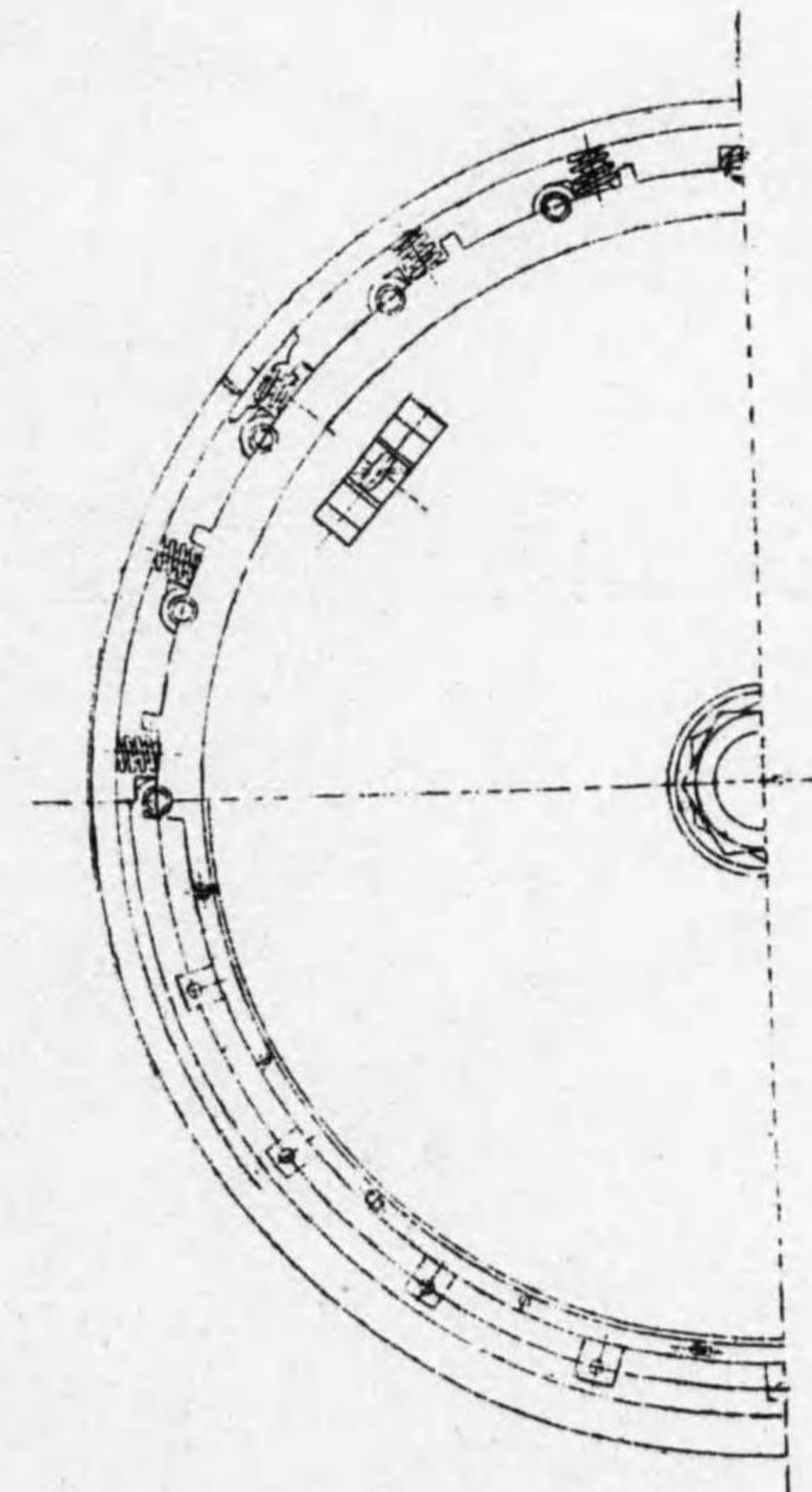

第 26 圖 B

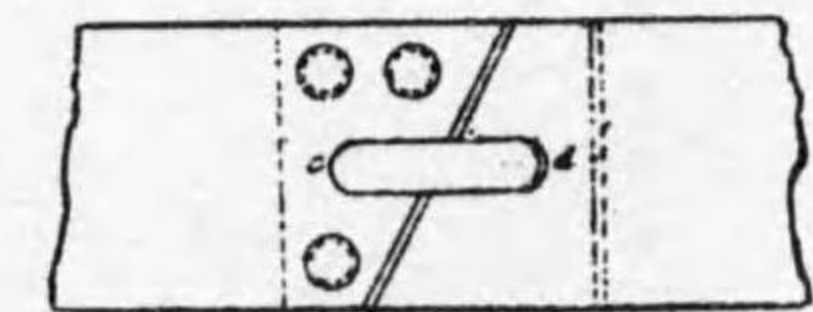

第 28 圖

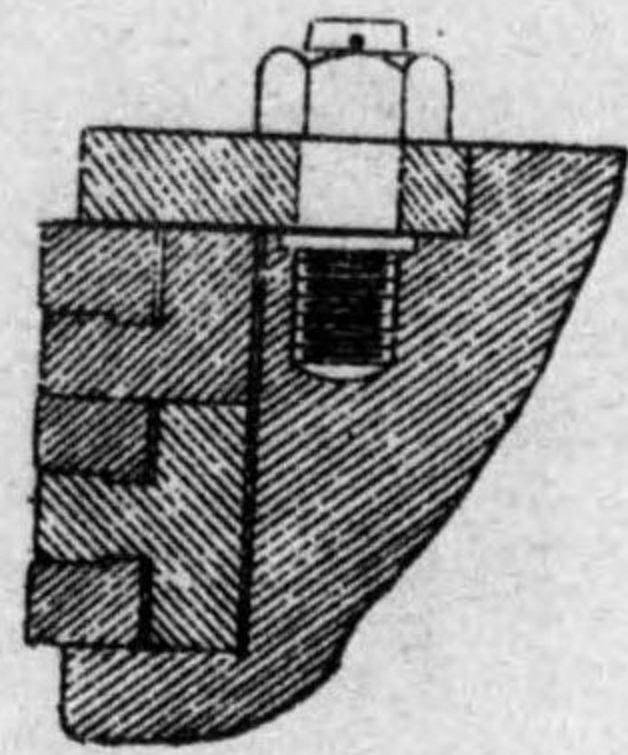
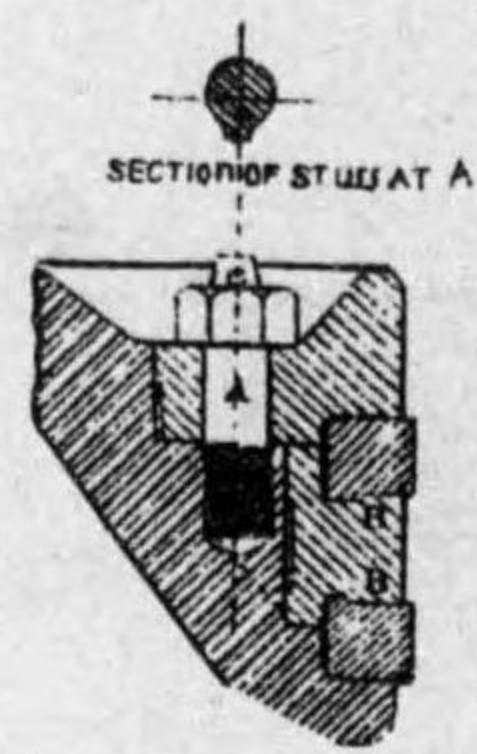

第 29 圖

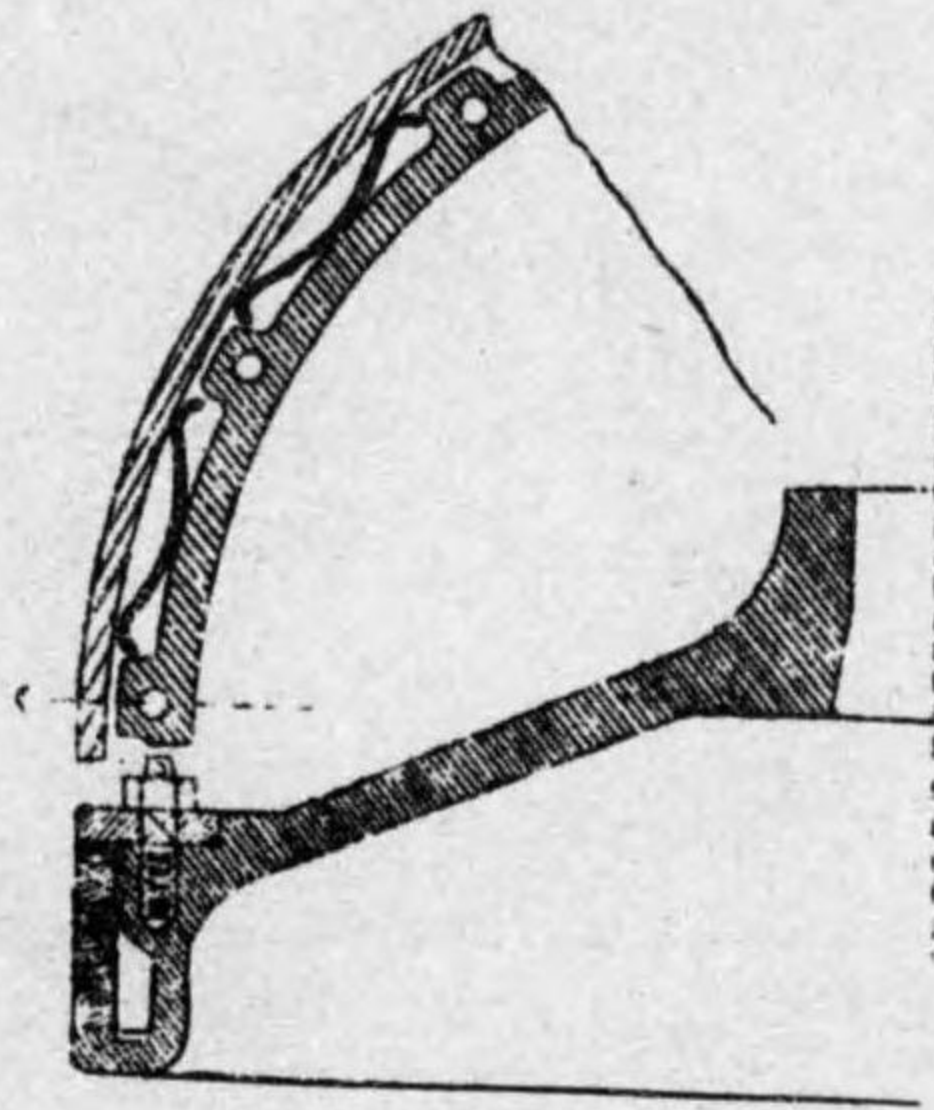
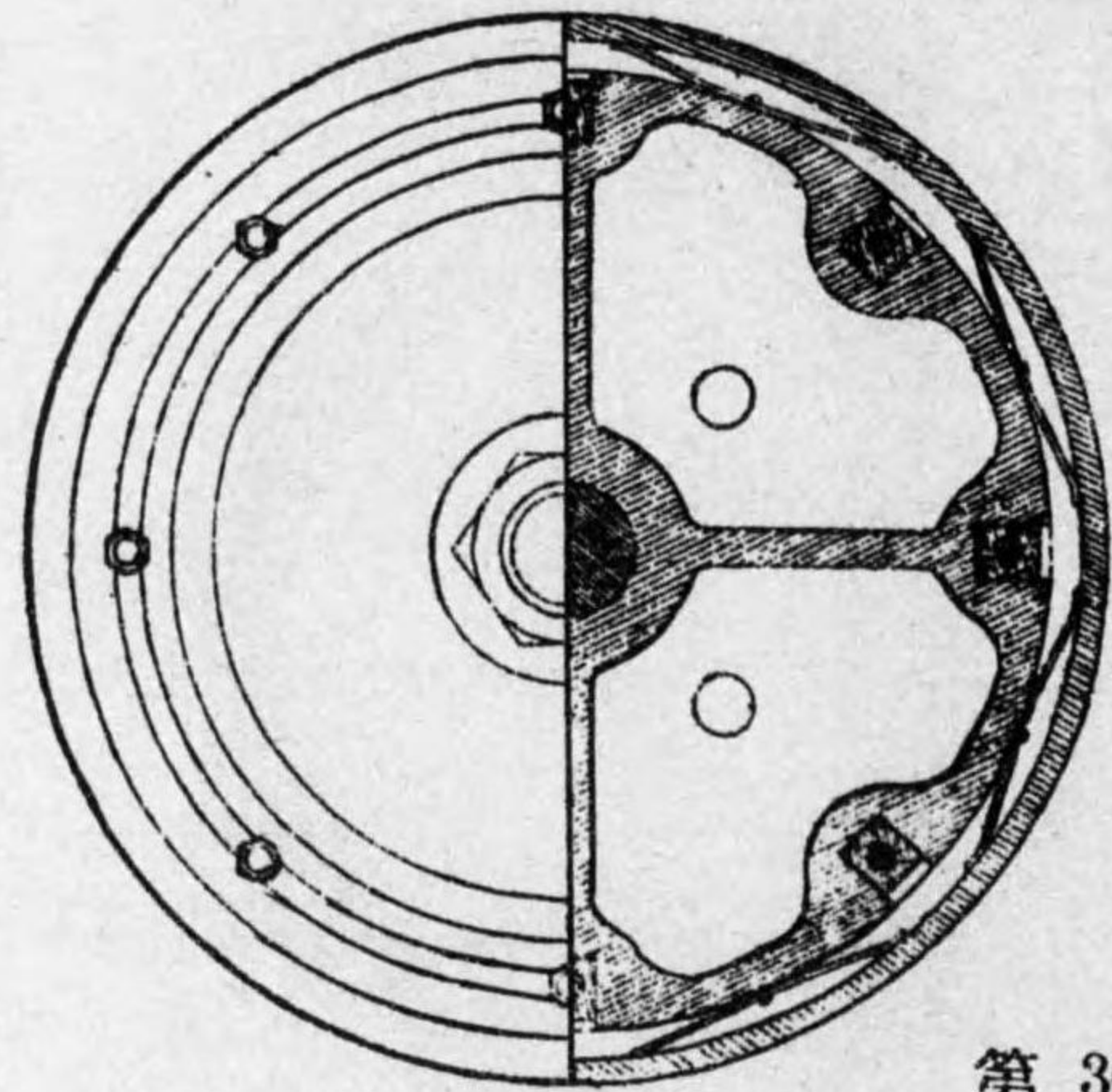

第 30 圖



第 31 圖 A

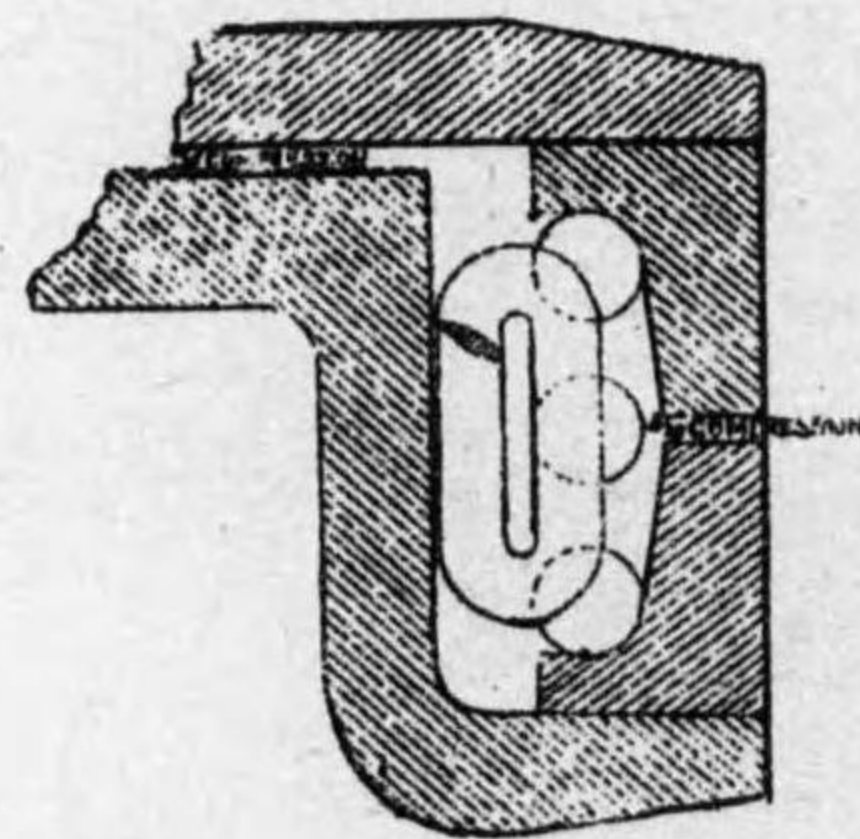

第 31 圖 C

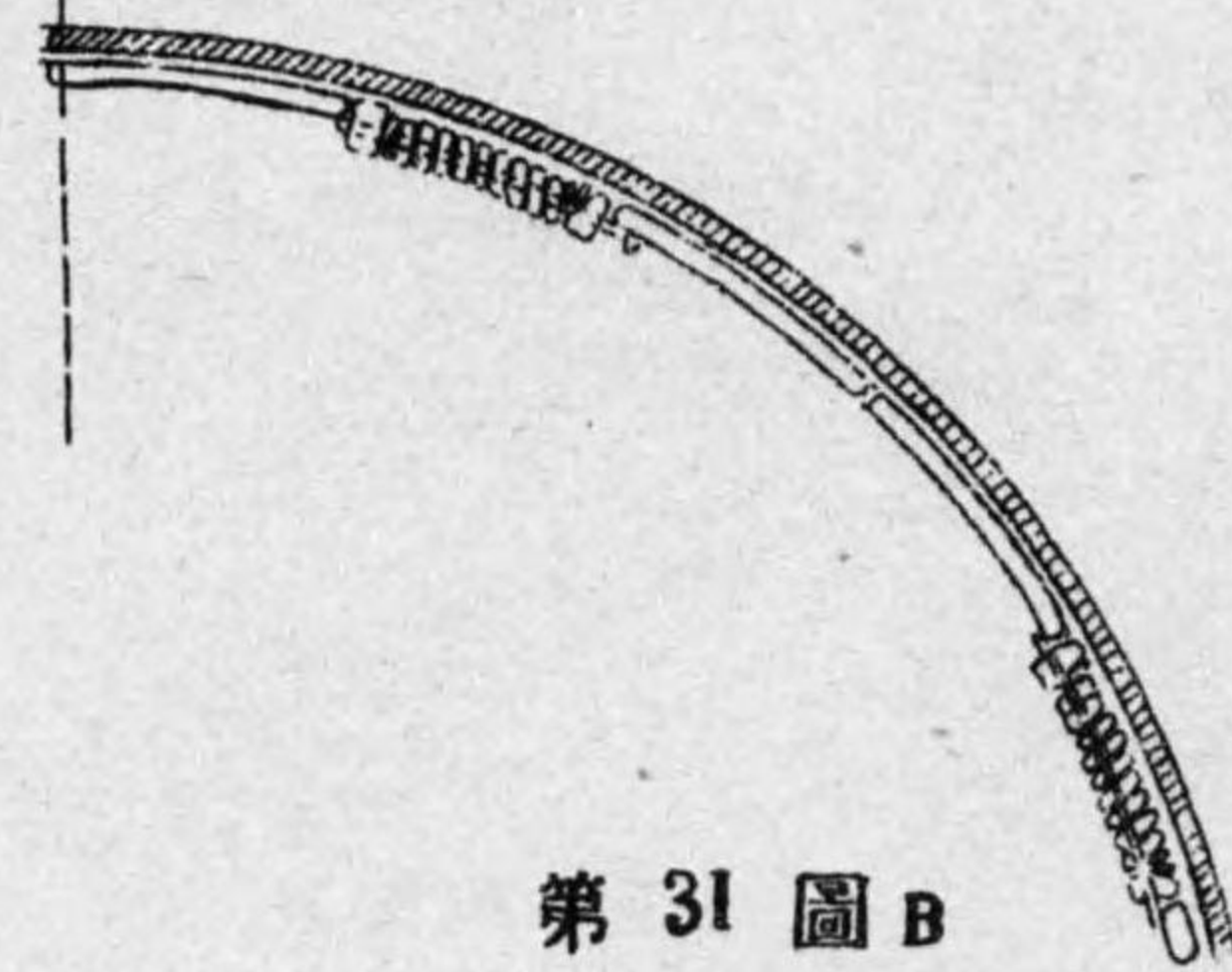

第 31 圖 B

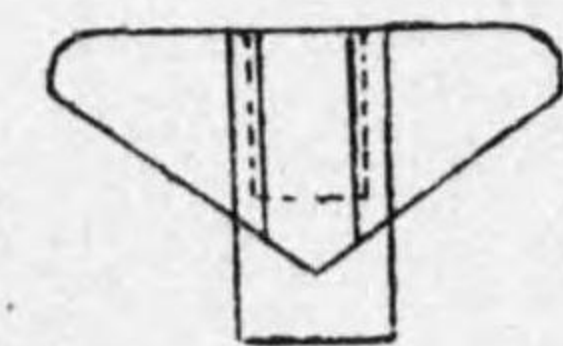
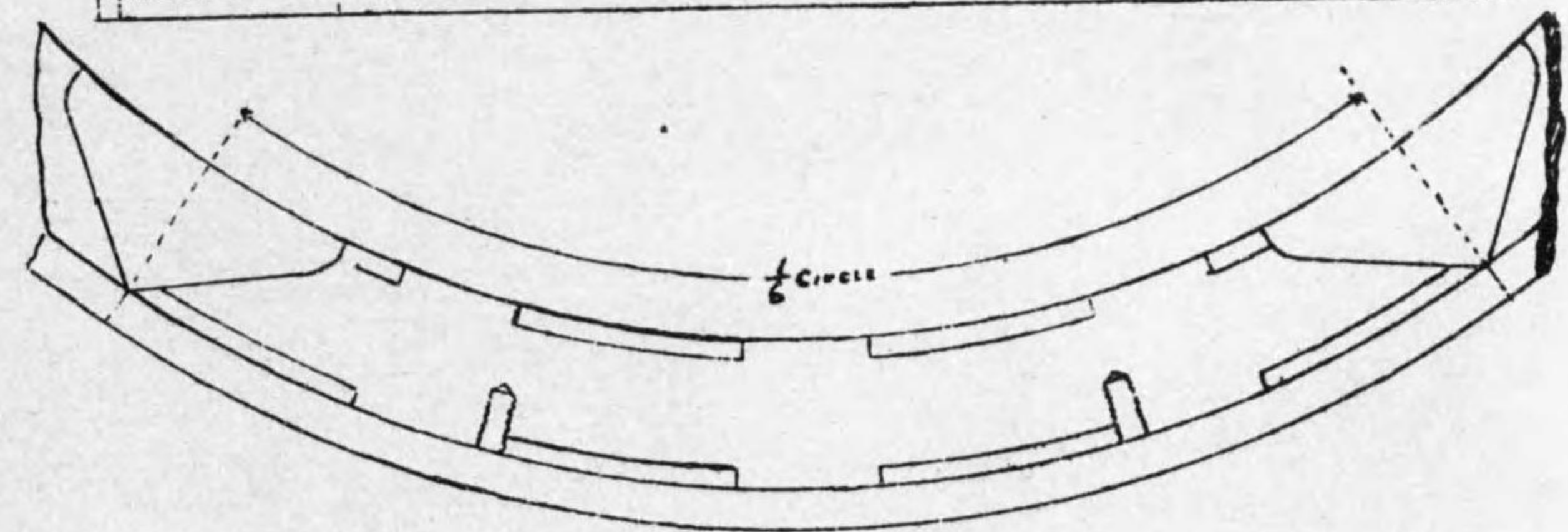
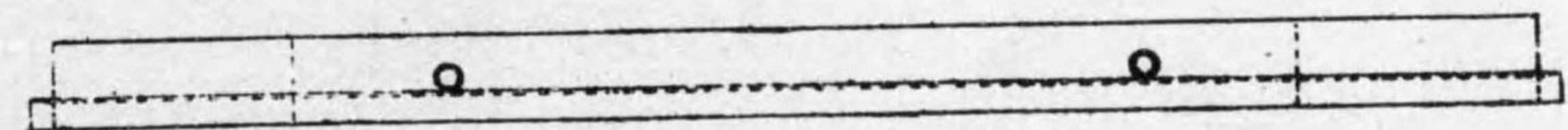
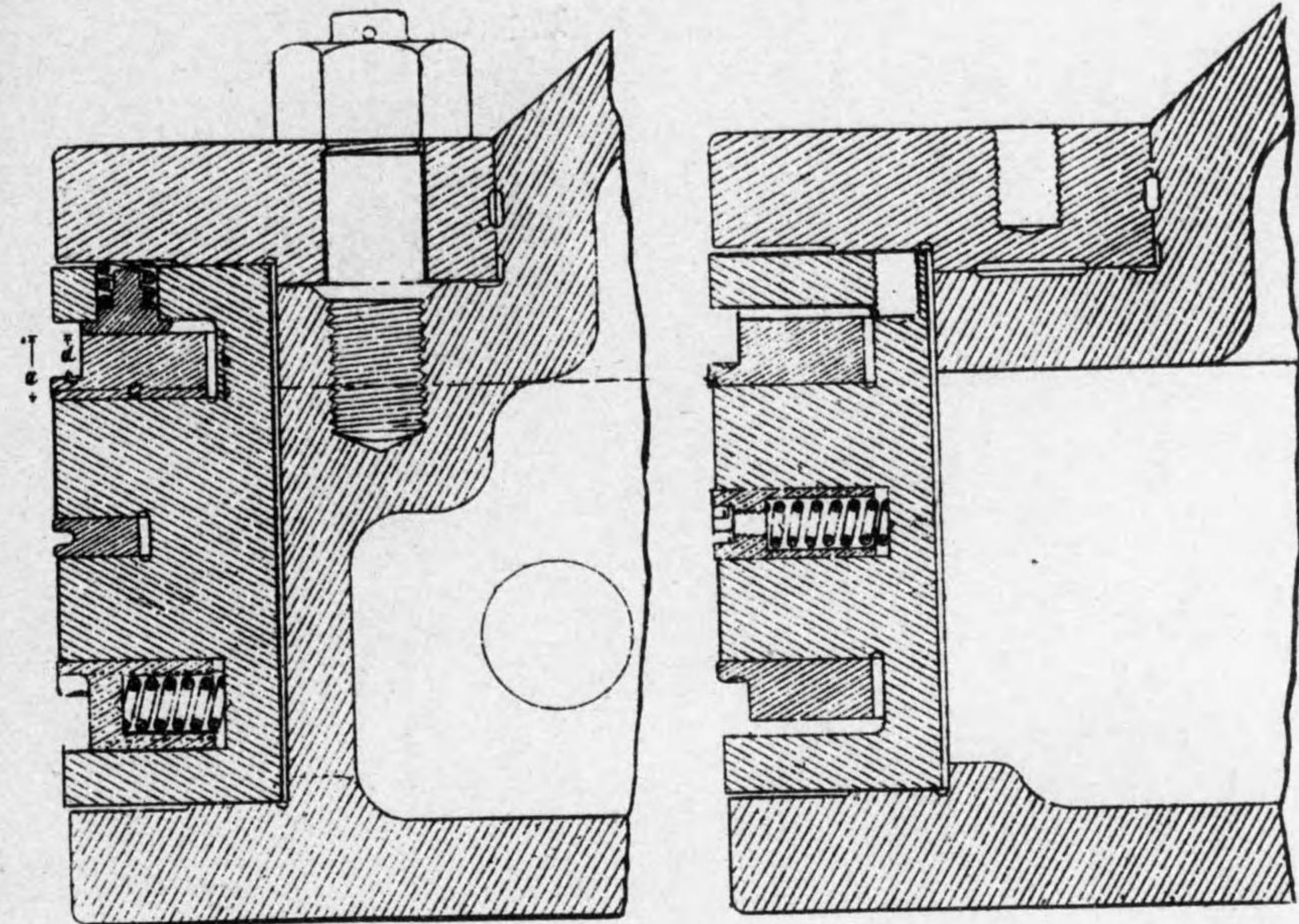

第 32 圖

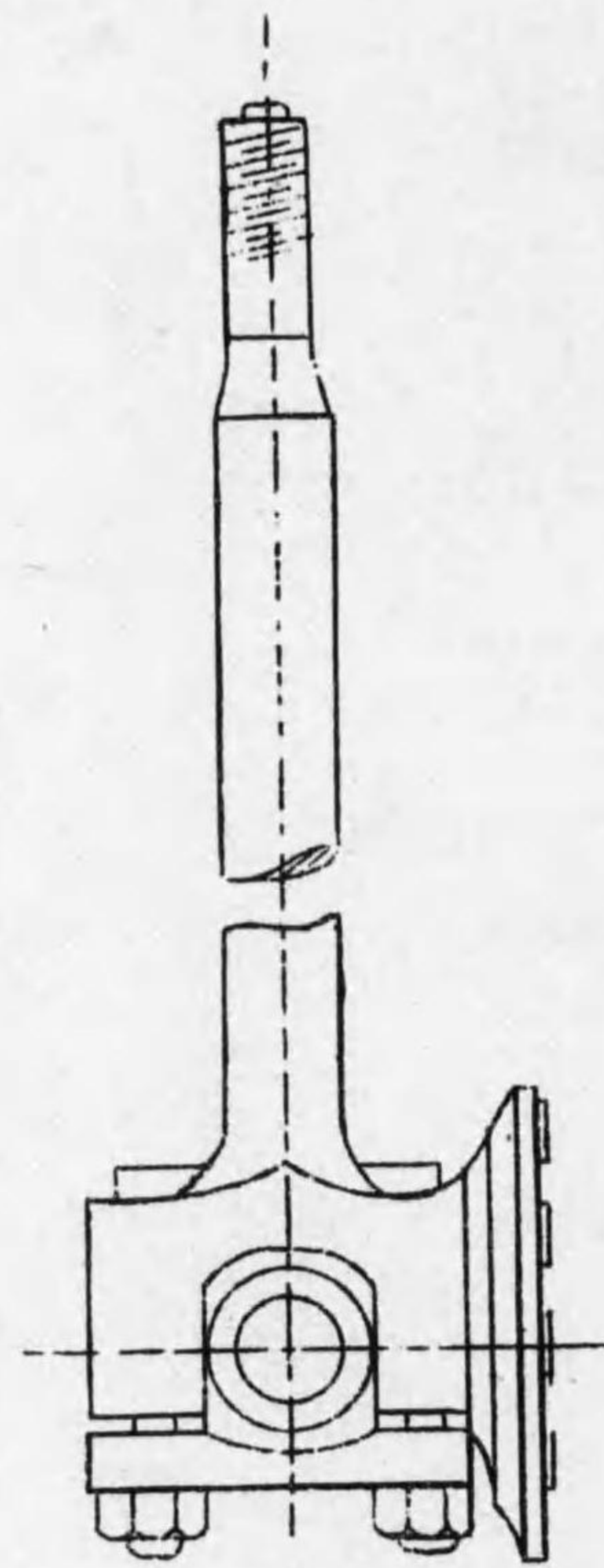

第 33 圖

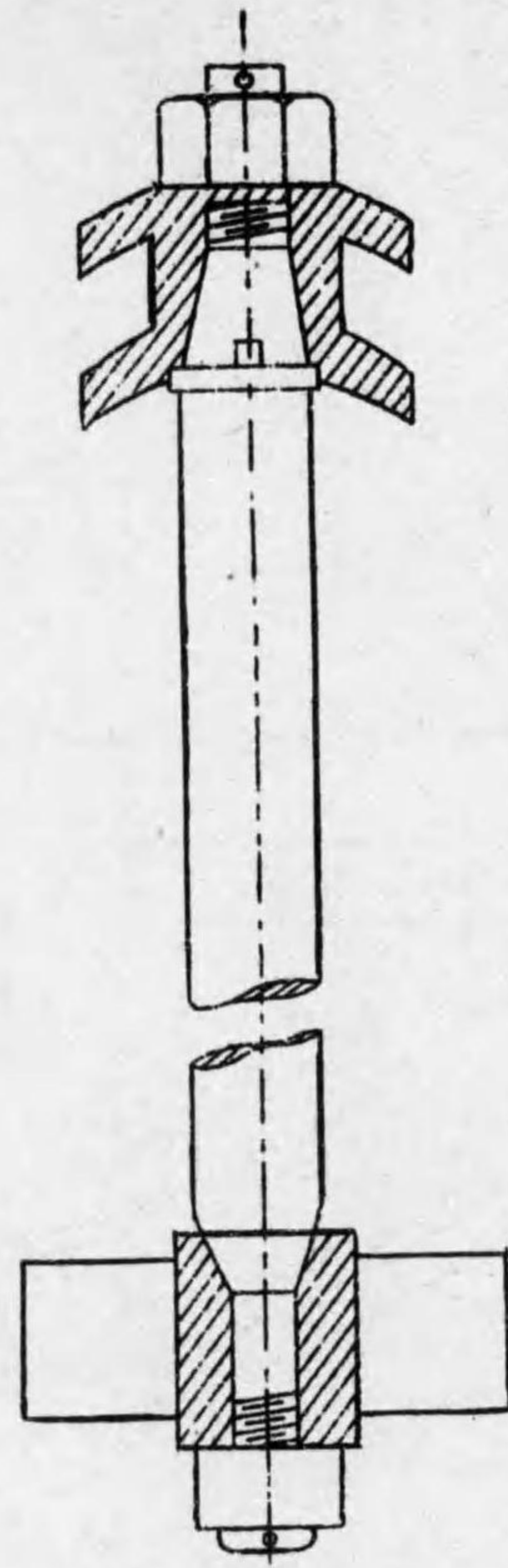

第 34 圖

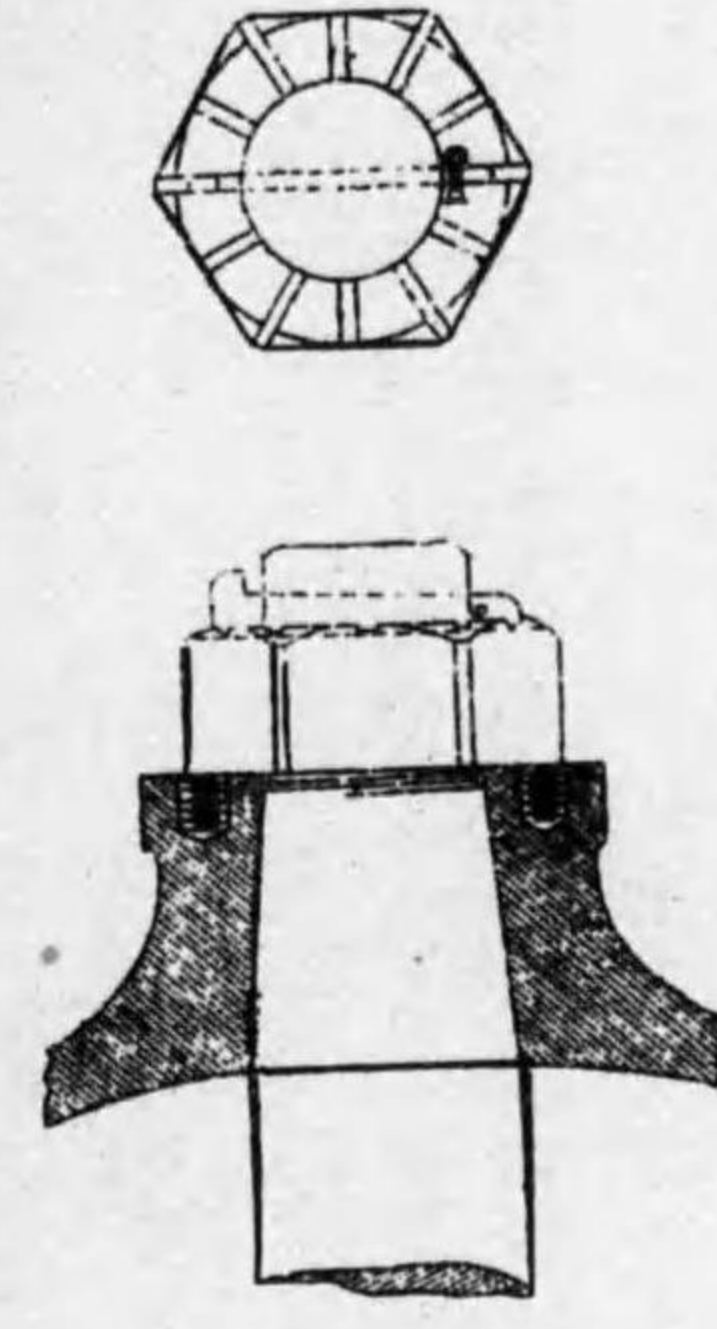

第 35 圖 A

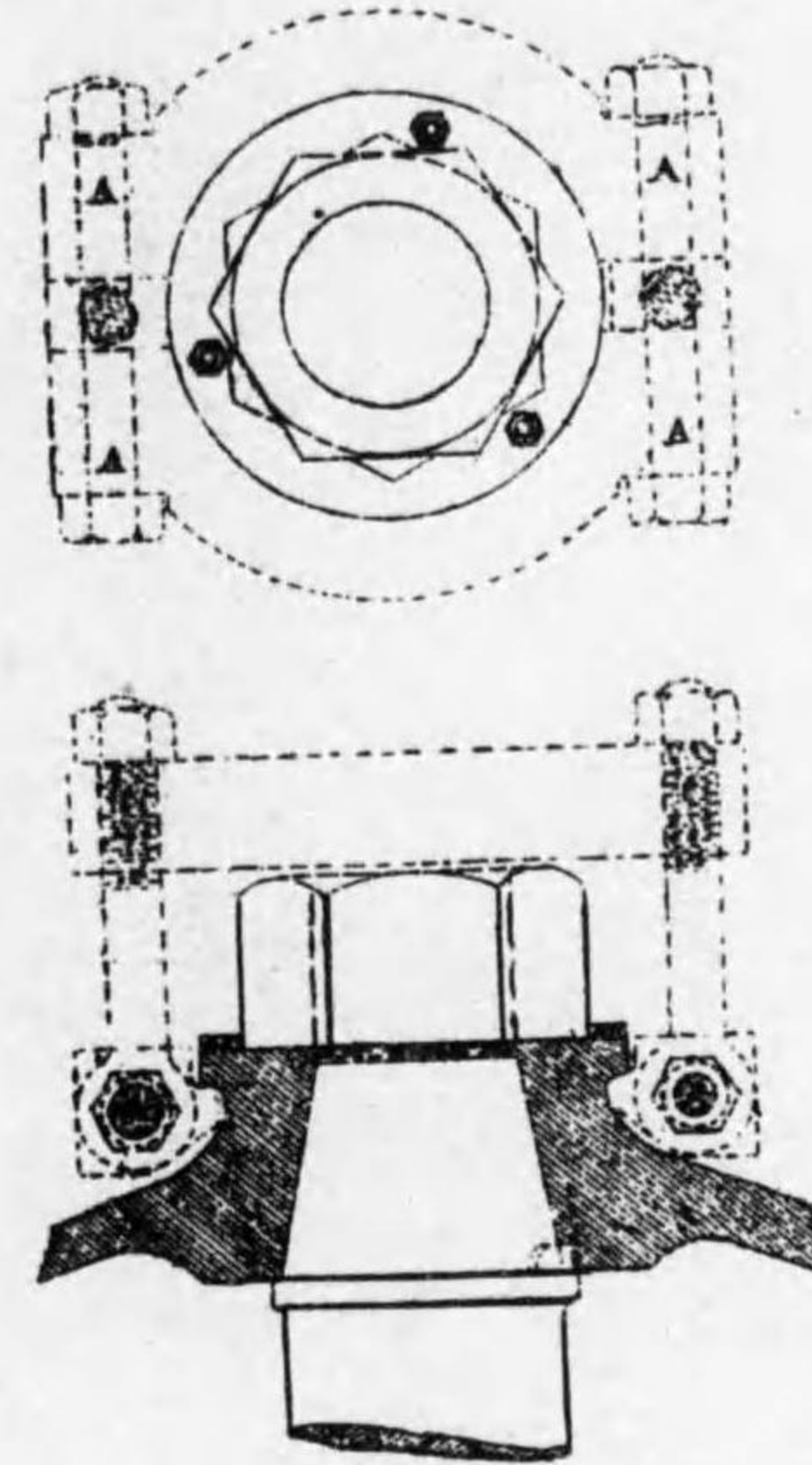

第 35 圖 B

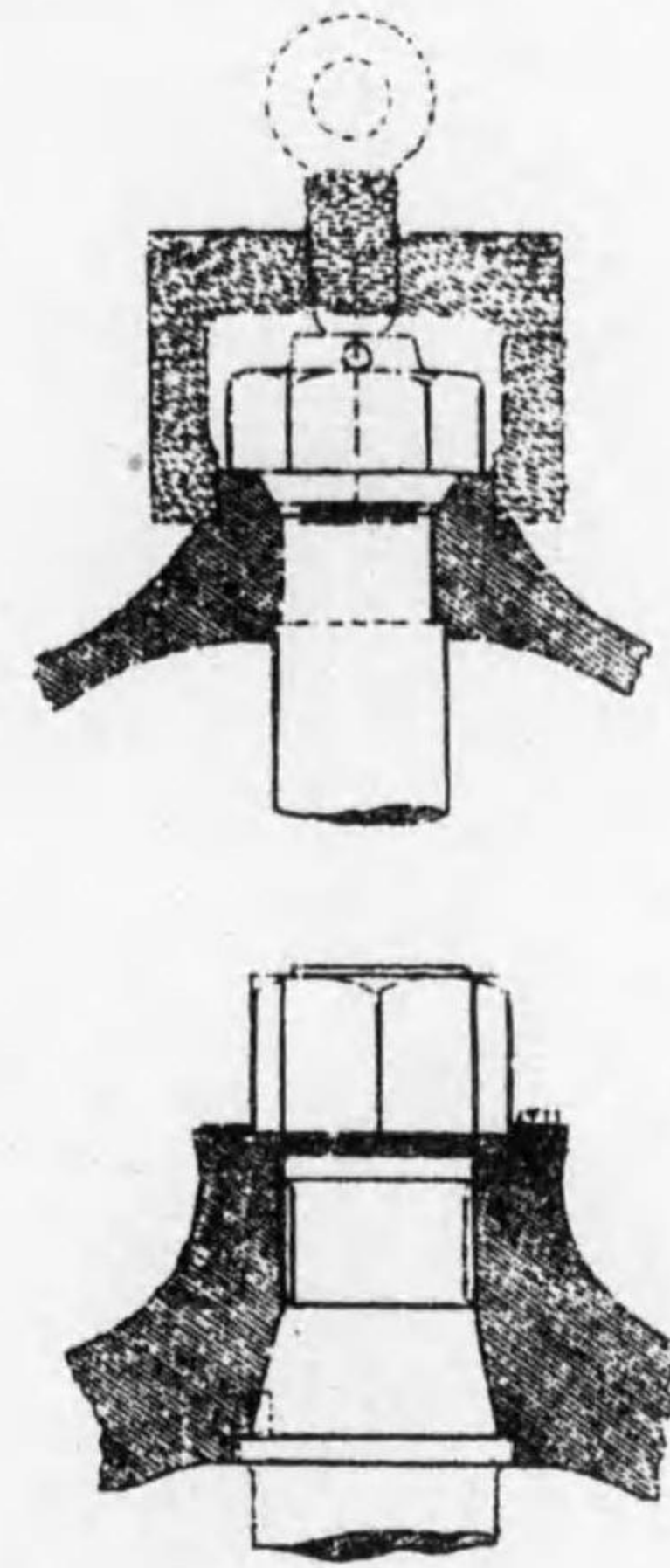

第 35 圖 c

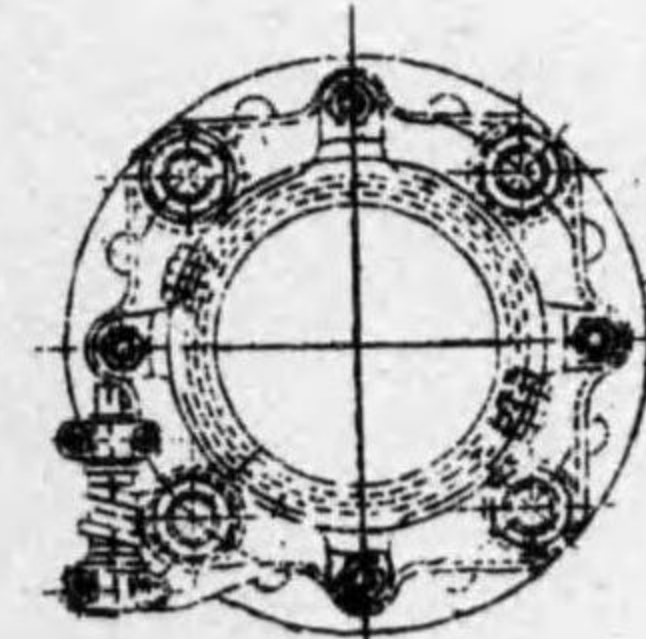
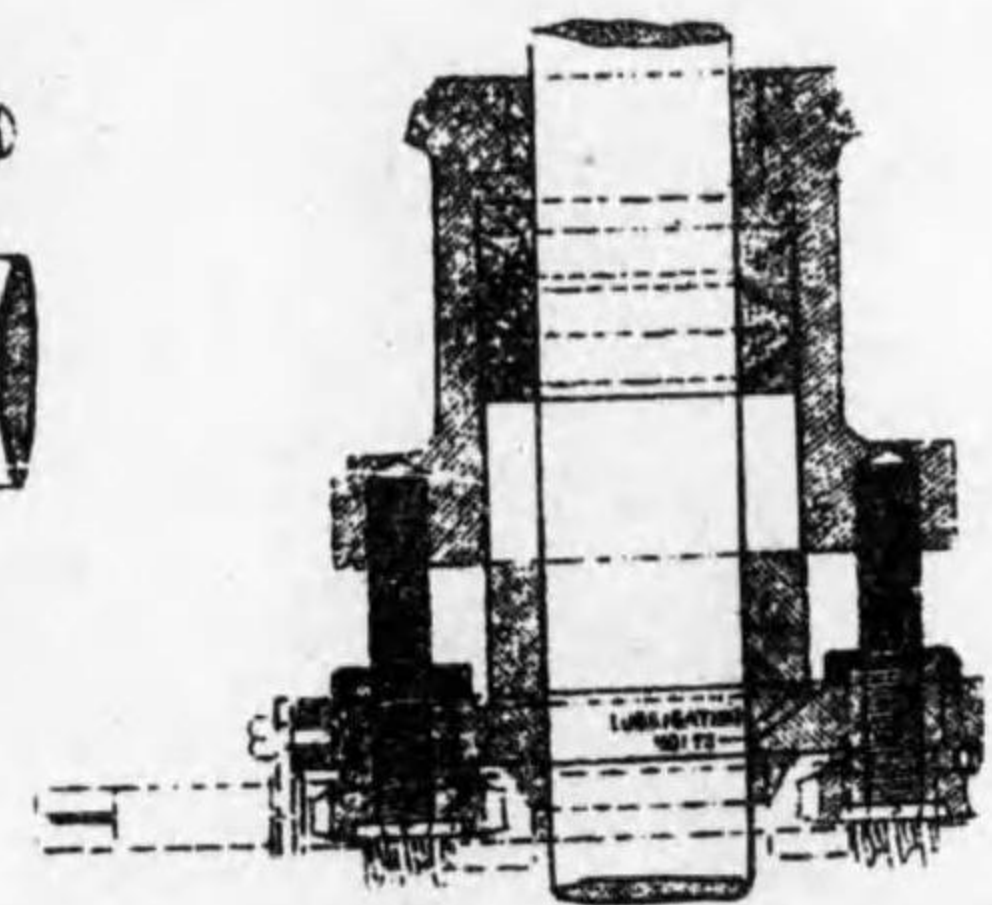
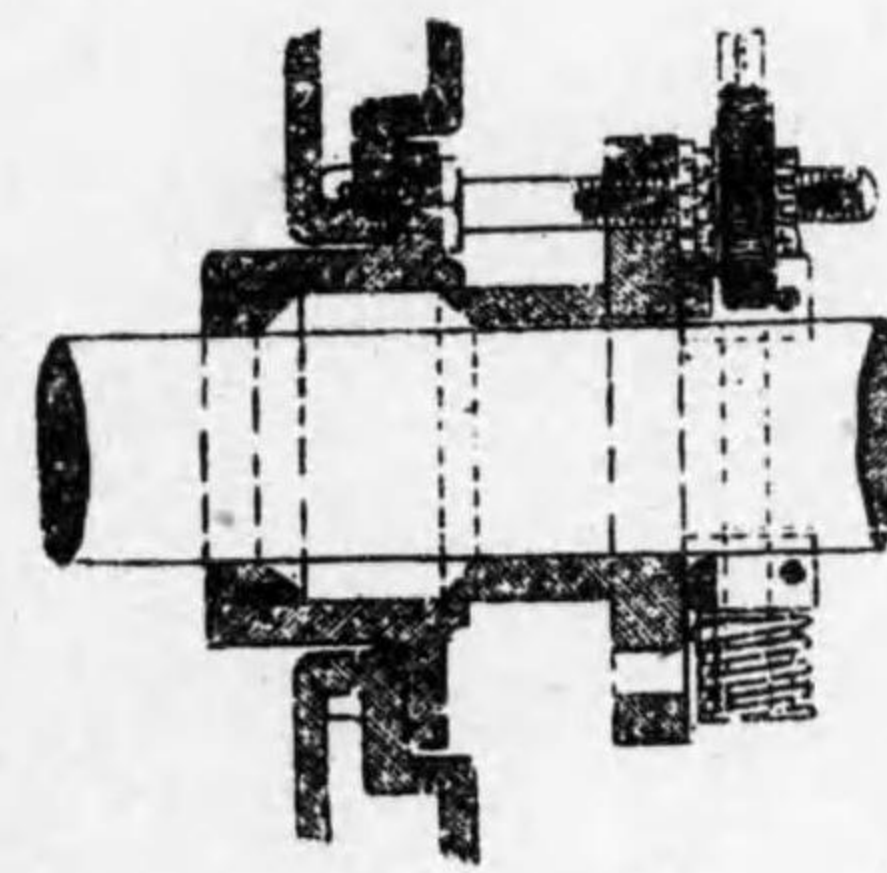
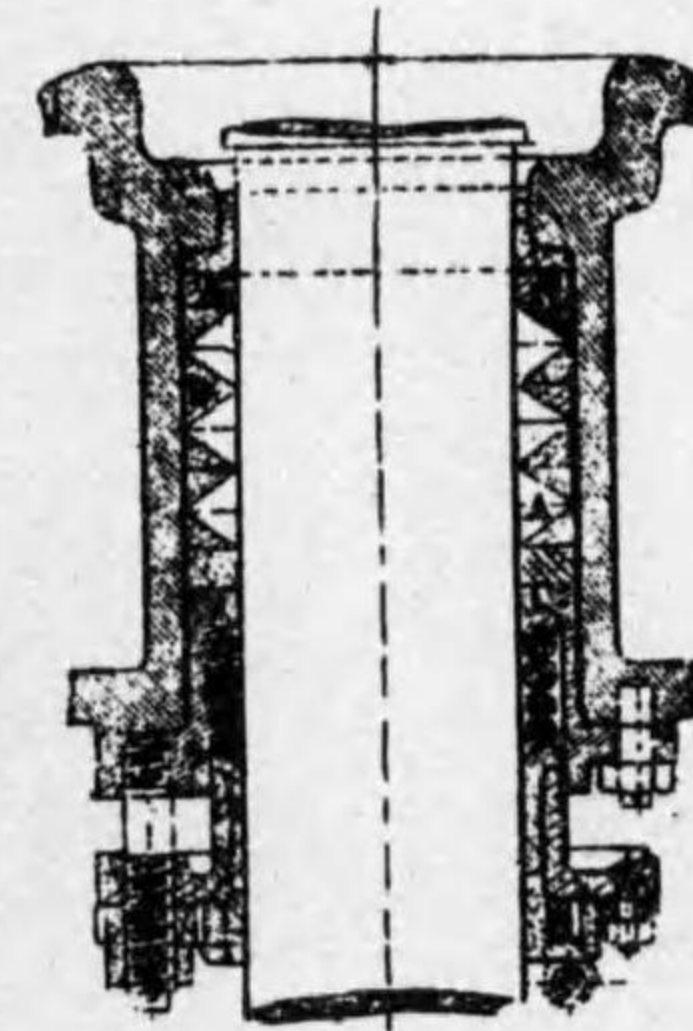

第 36 圖 A

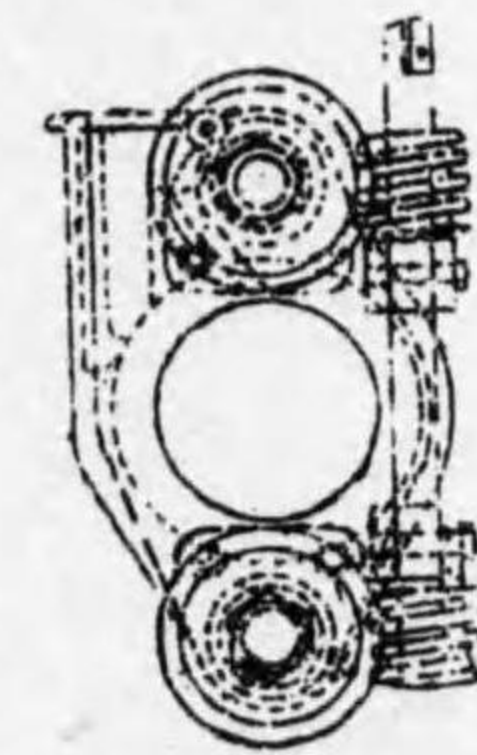

第 36 圖 B

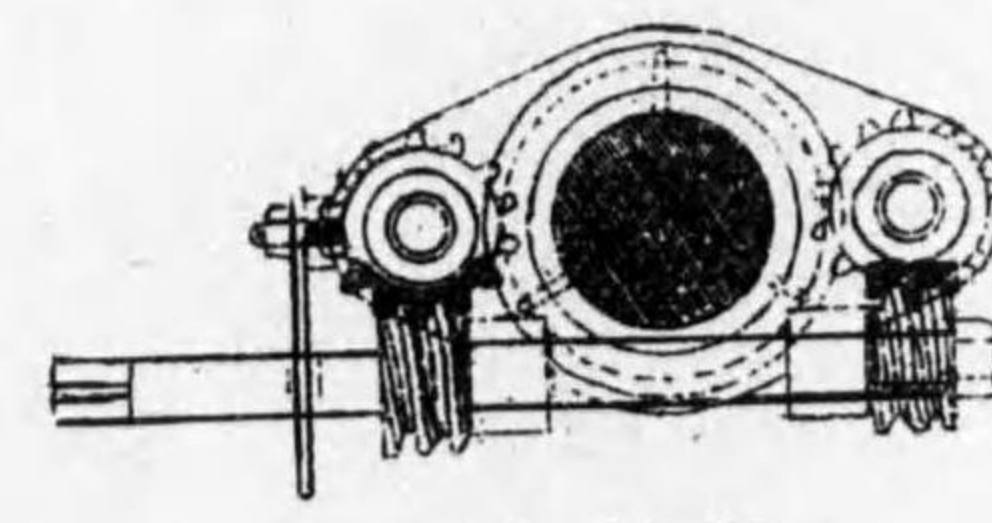

第 36 圖 c

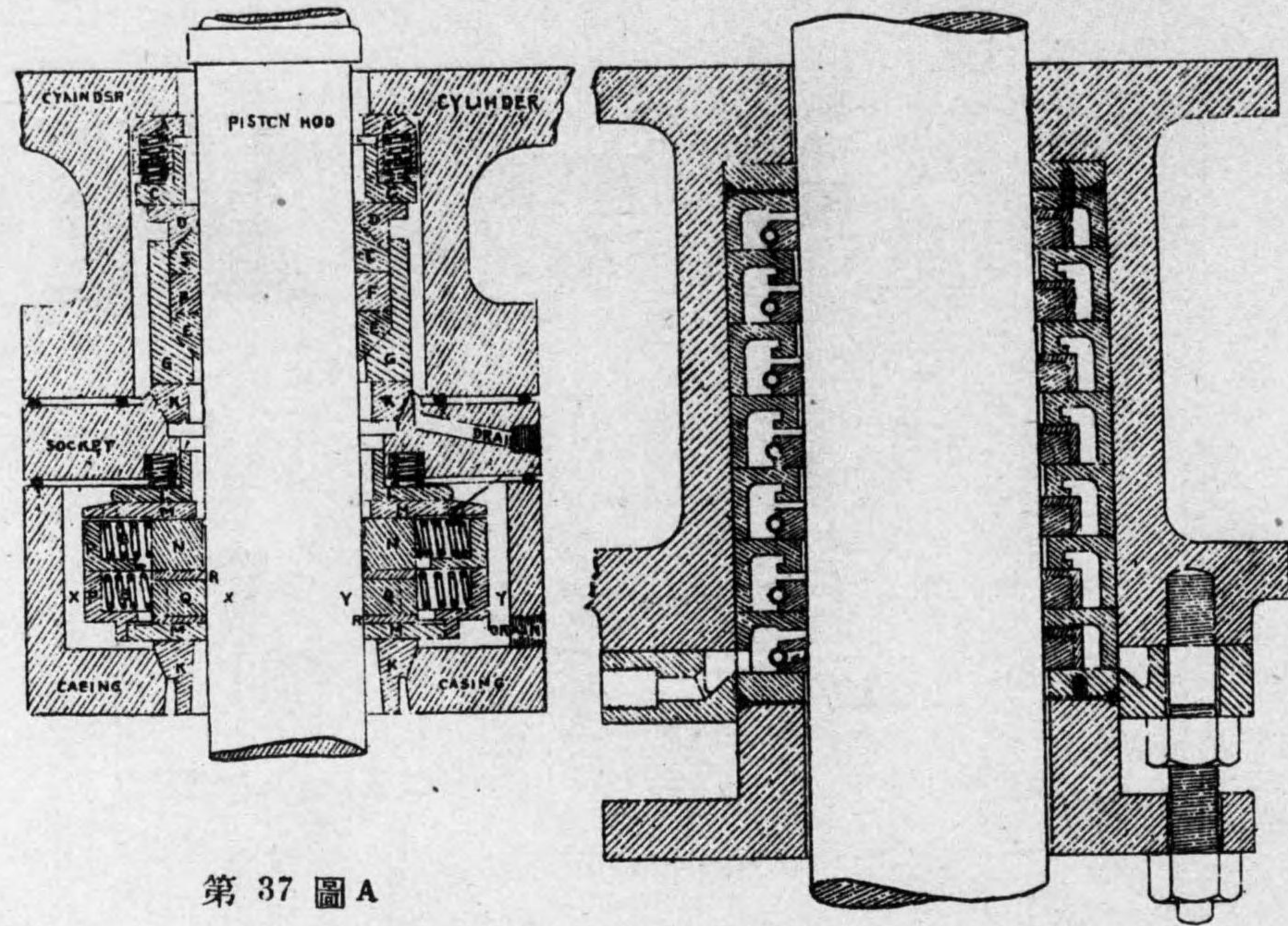

第 37 圖 A

第 38 圖 A

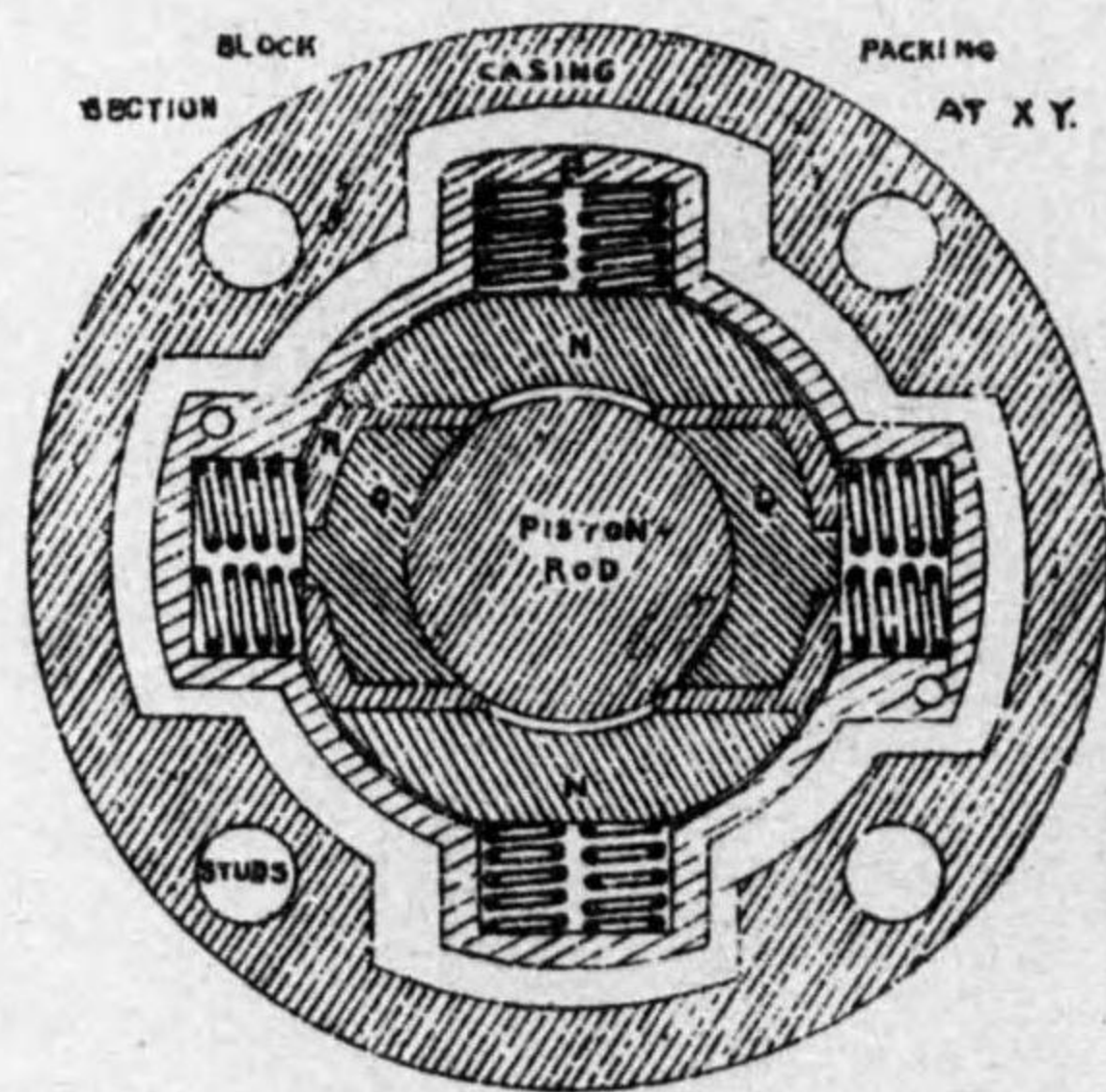

第 37 圖 B

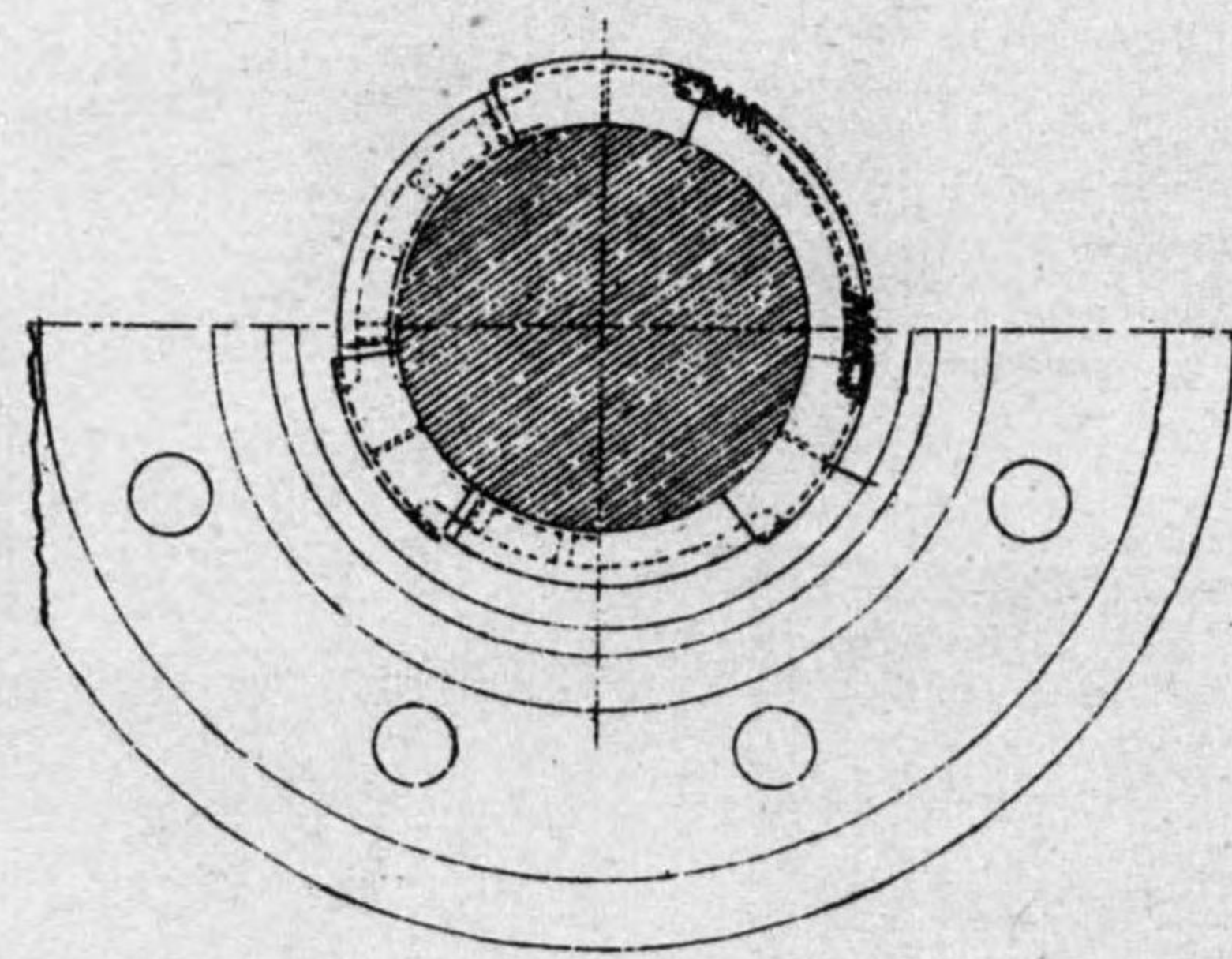

第 38 圖 B

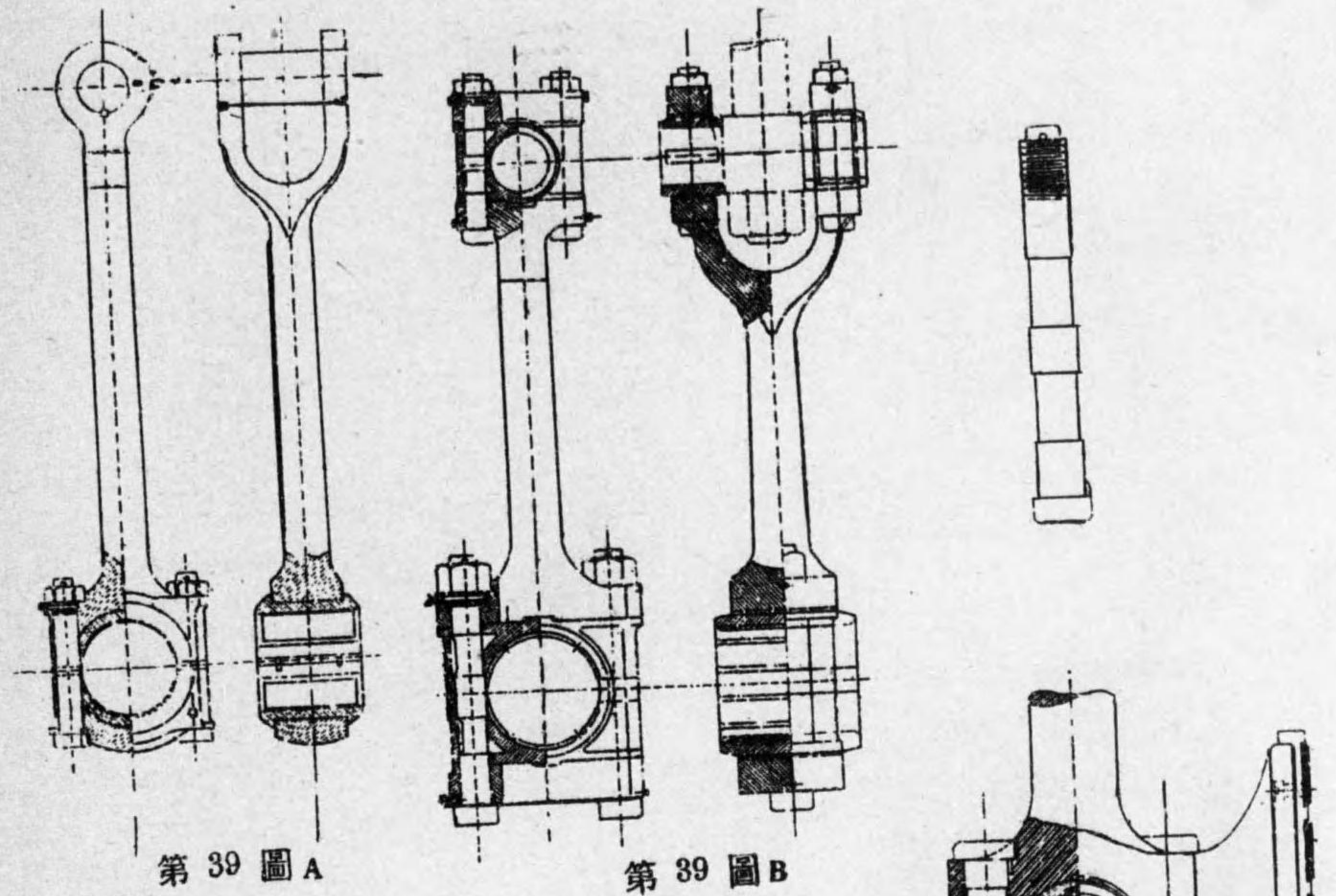

第 39 圖 A

第 39 圖 B

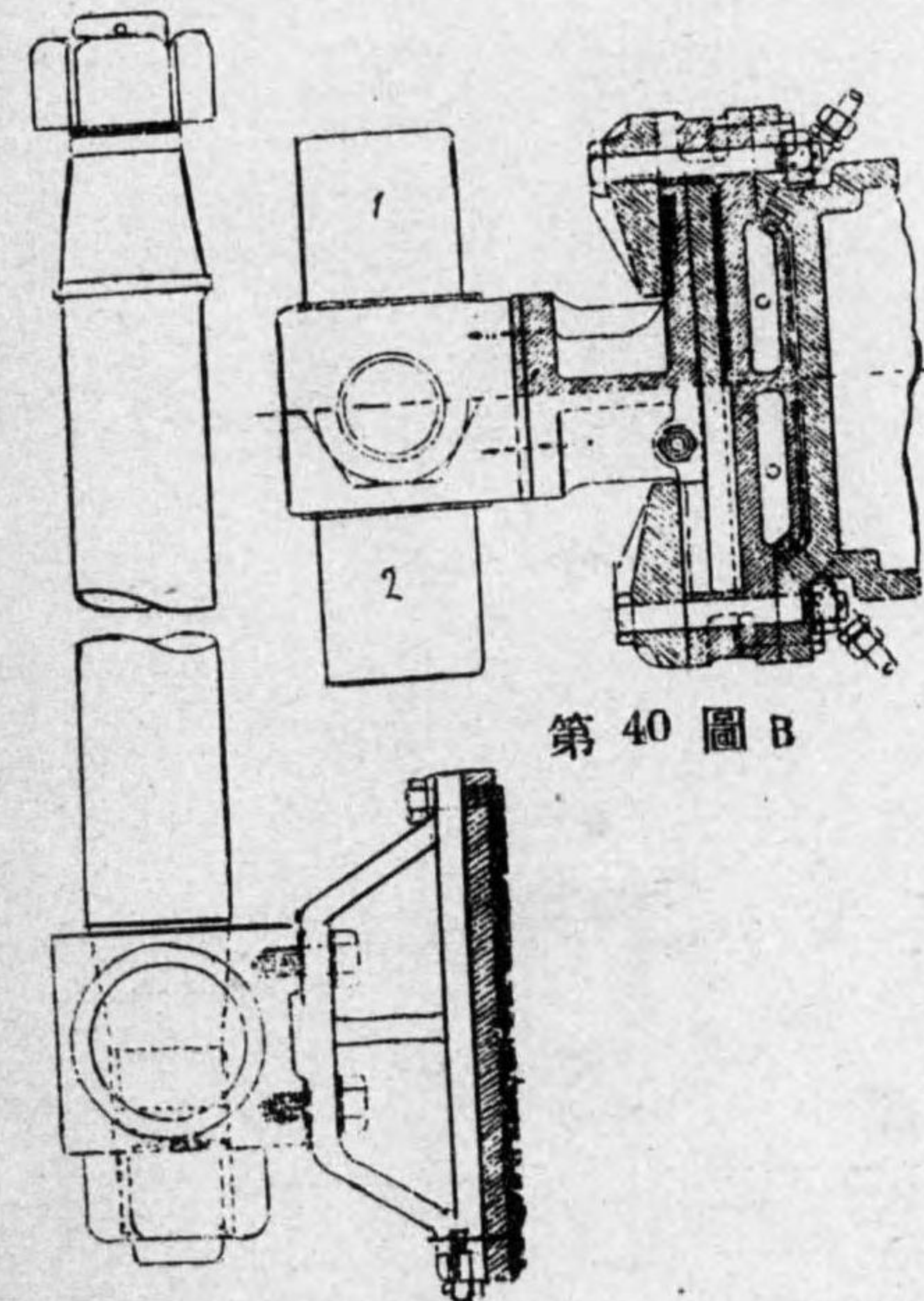

第 40 圖 B

第 40 圖 A

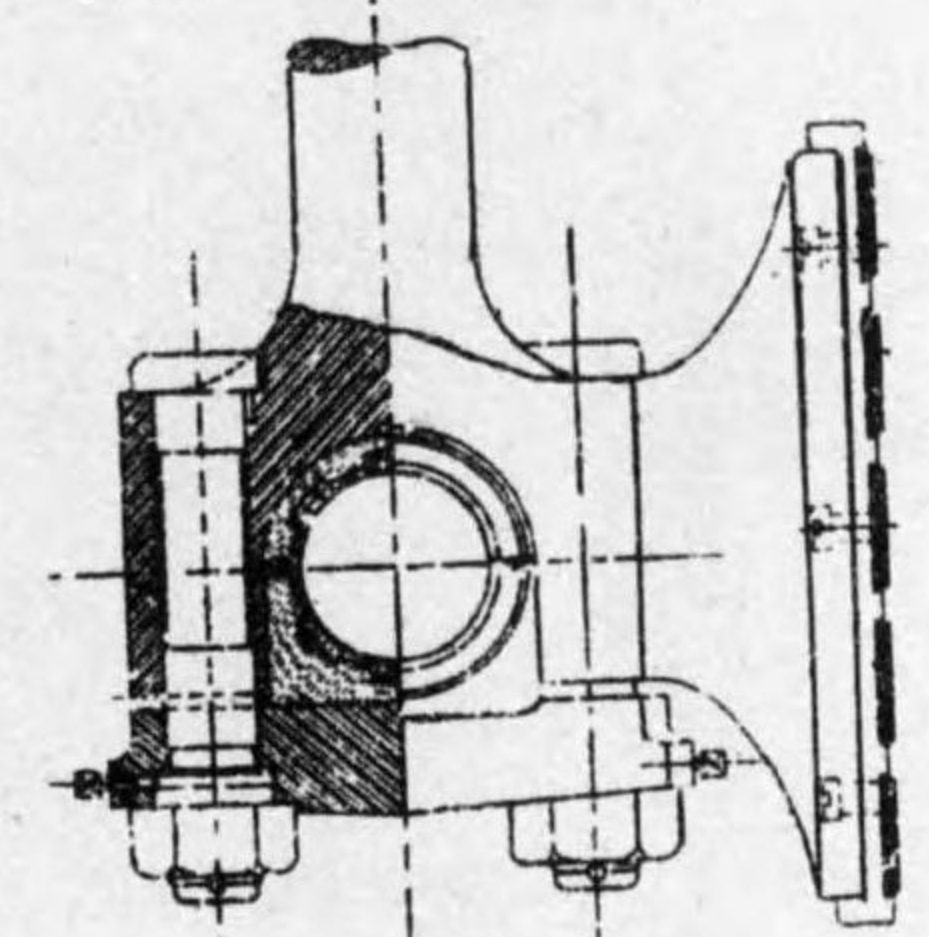

第 40 圖 C

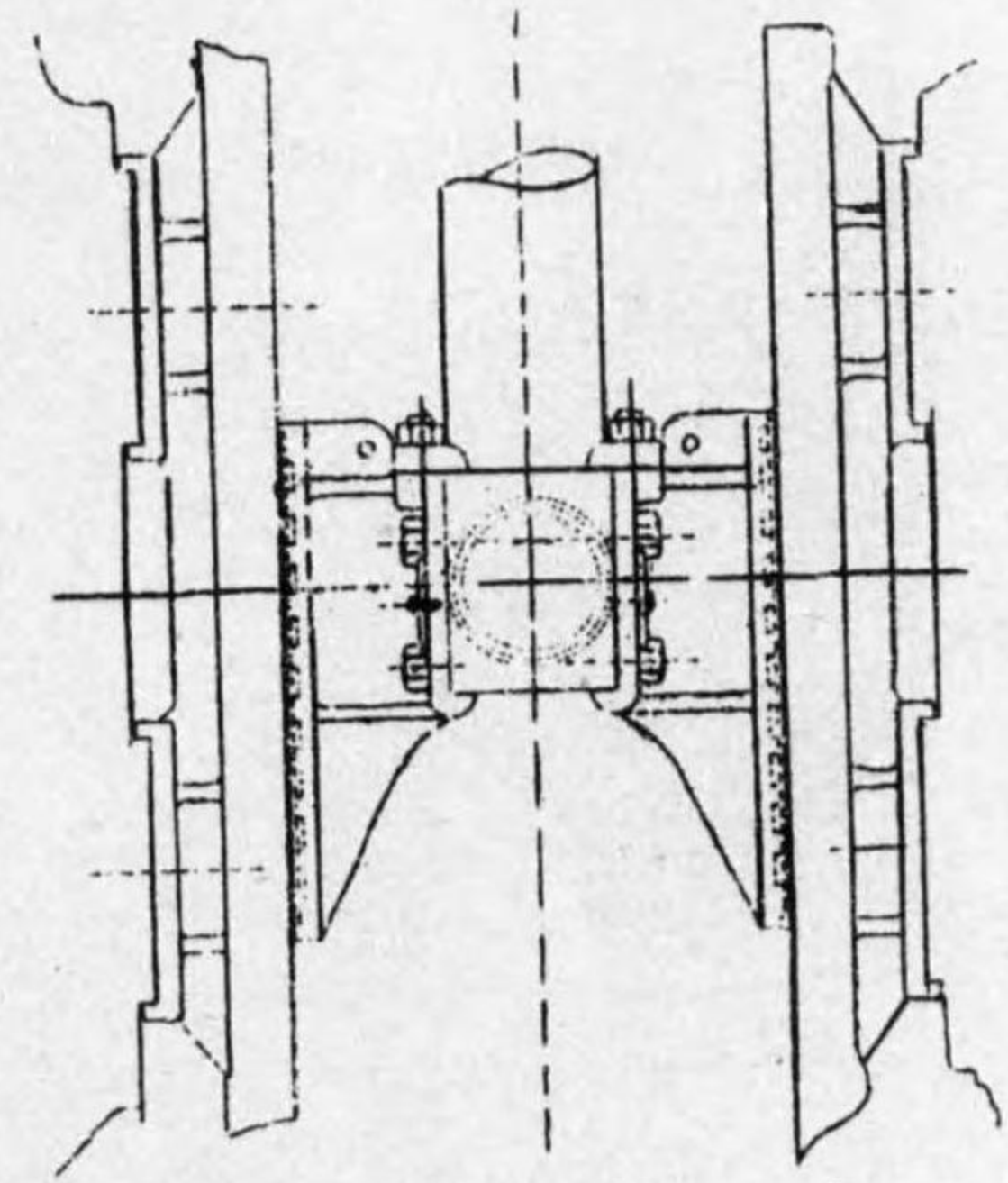

第 41 圖

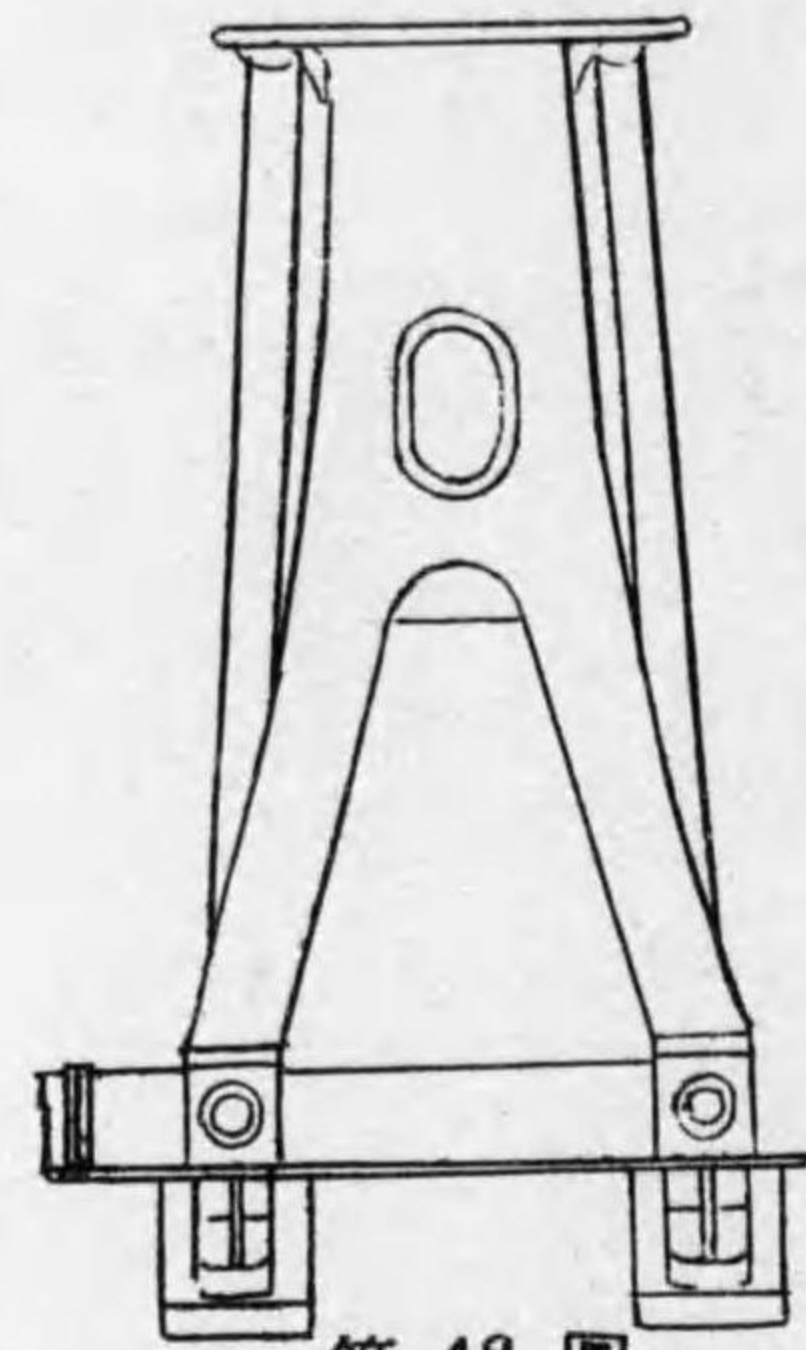

第 42 圖 A

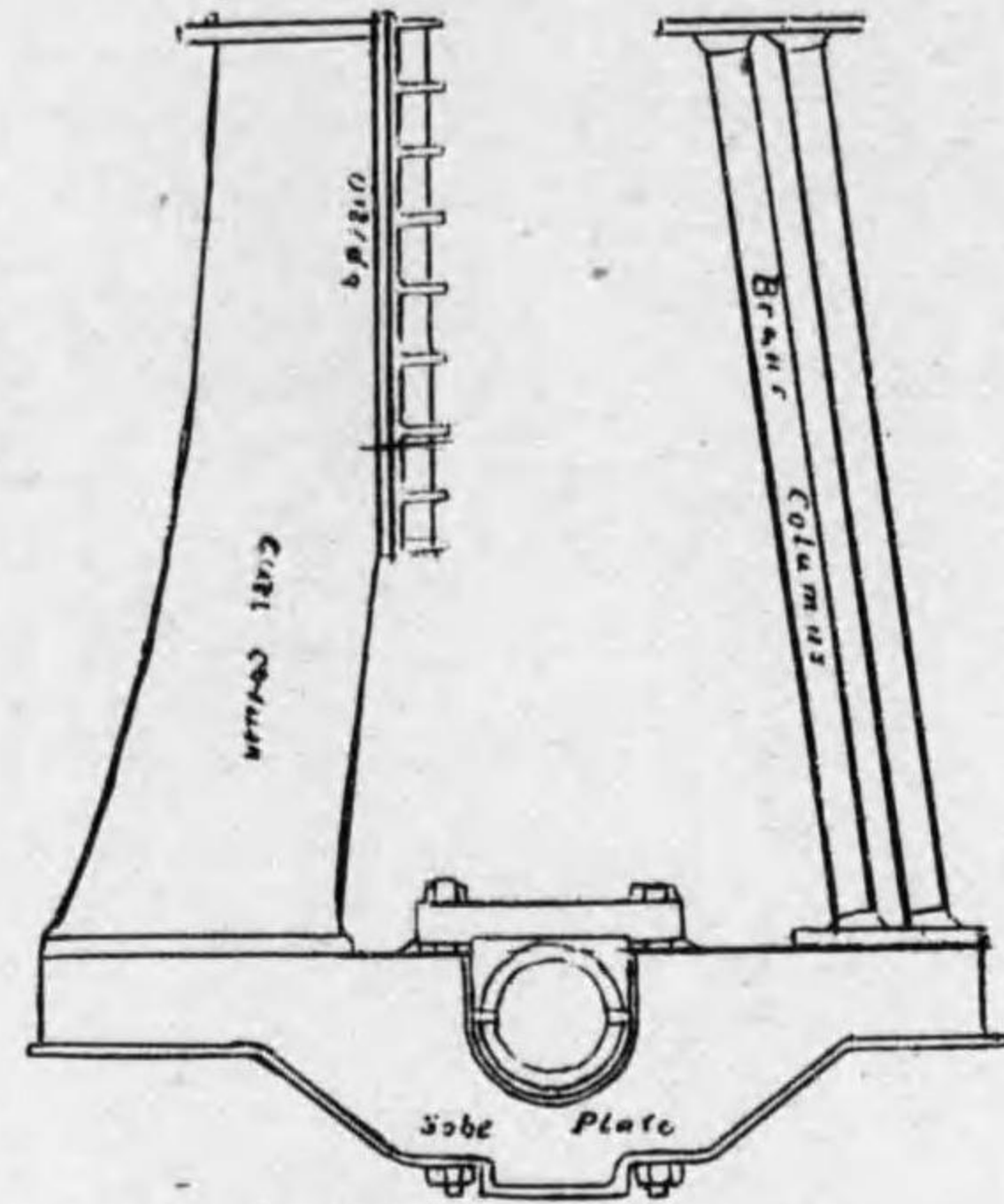

第 42 圖 B

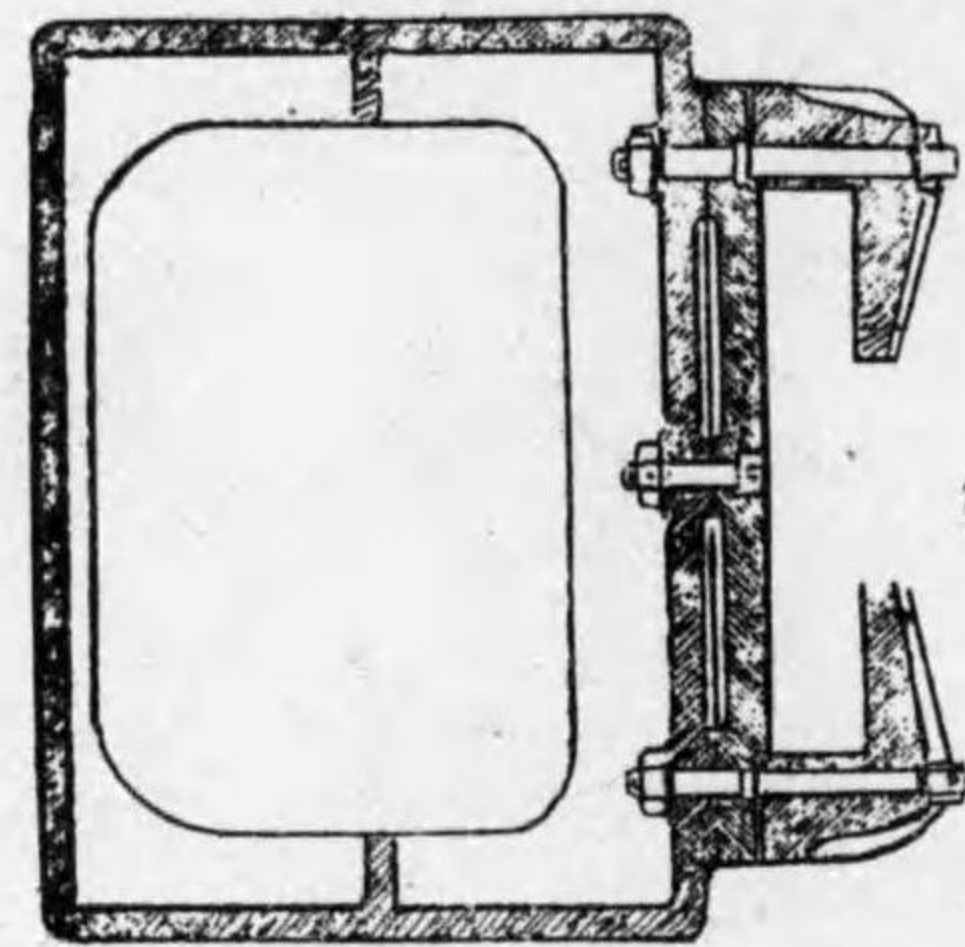

第 43 圖

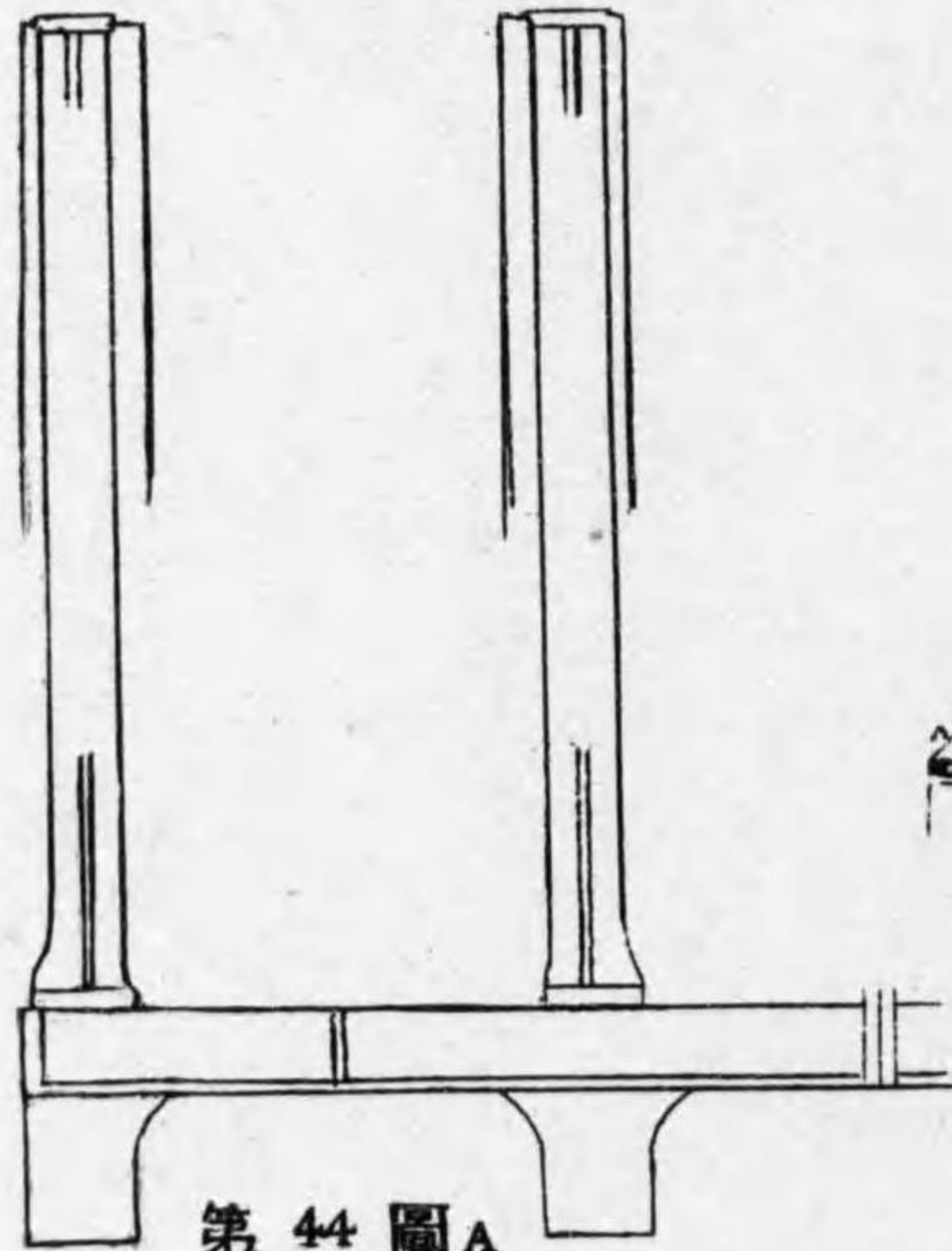

第 44 圖 A

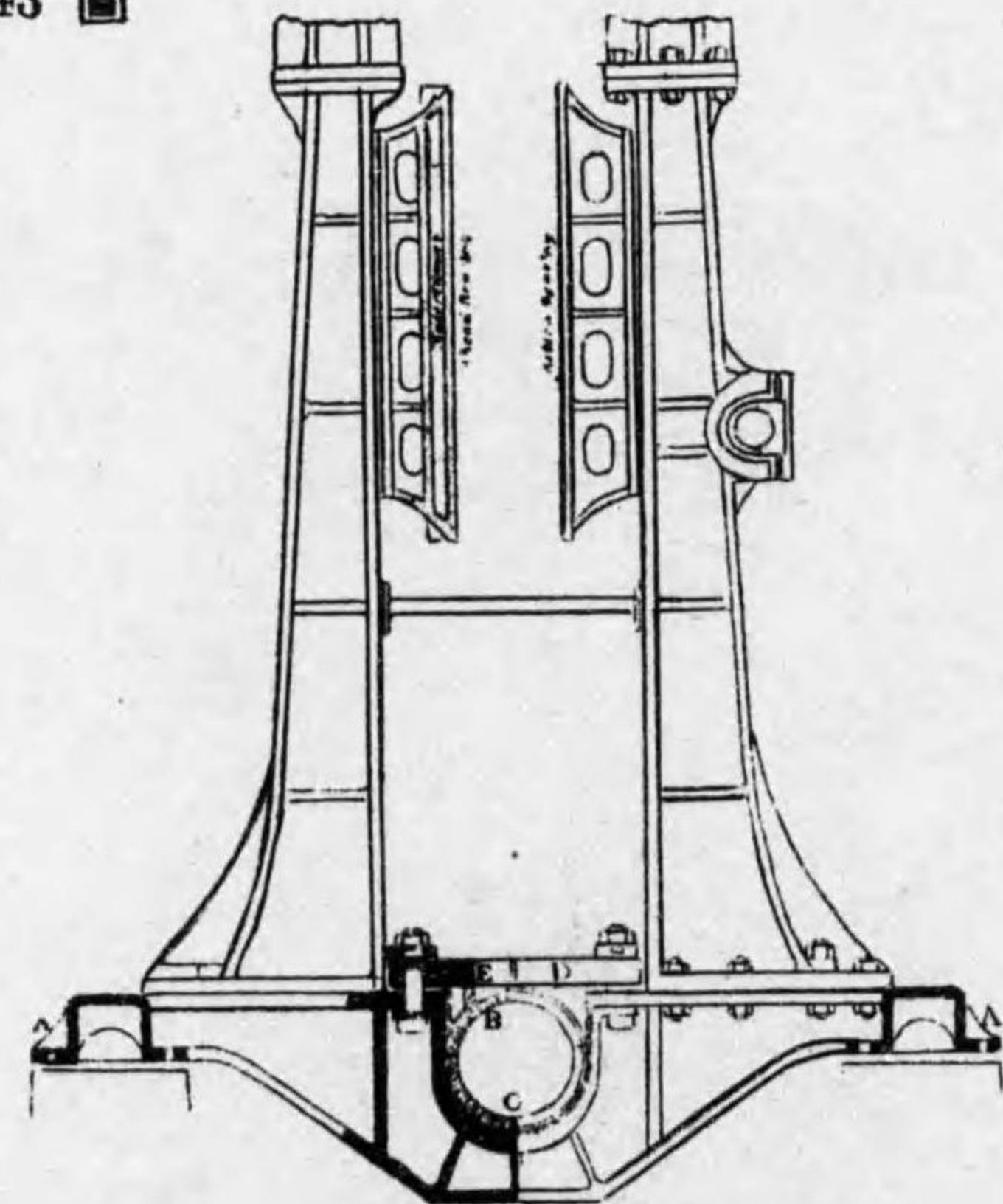

第 44 圖 B

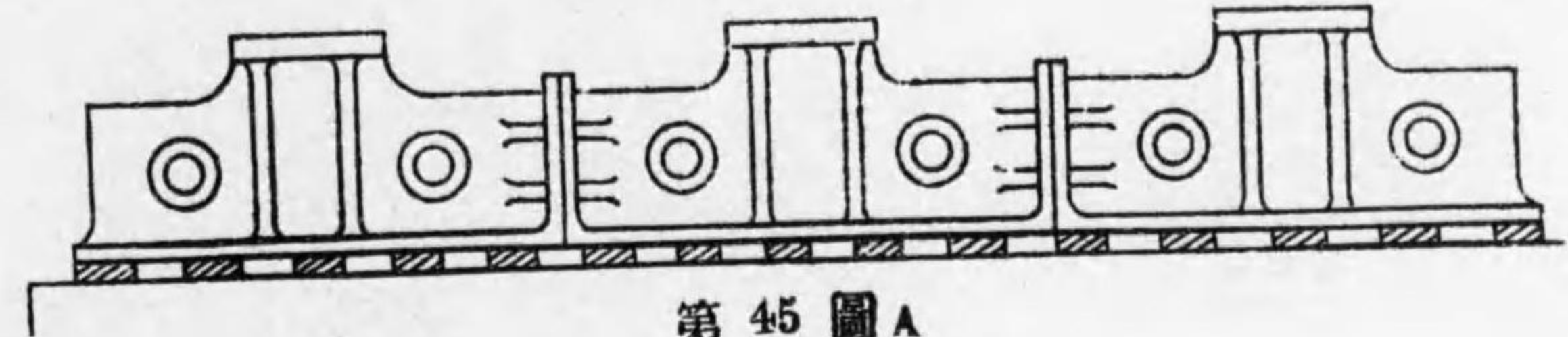

第 45 圖 A

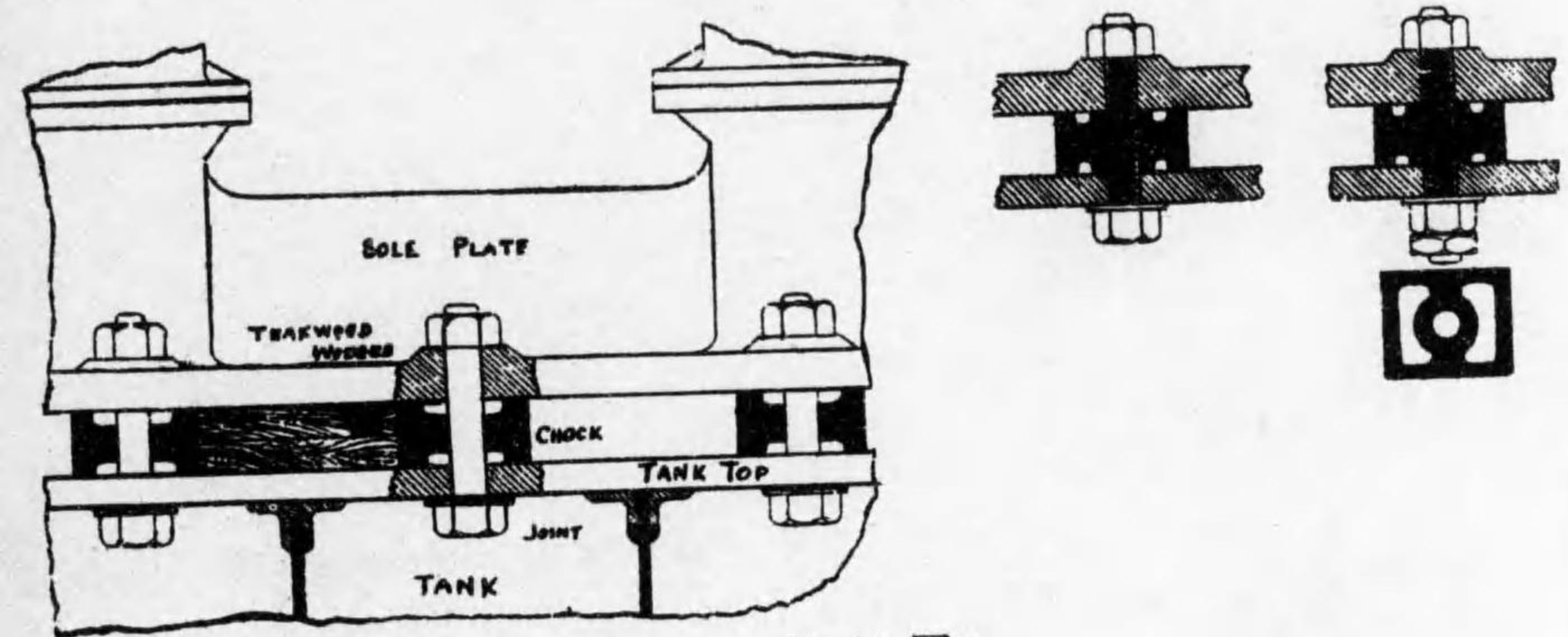

第 45 圖 B

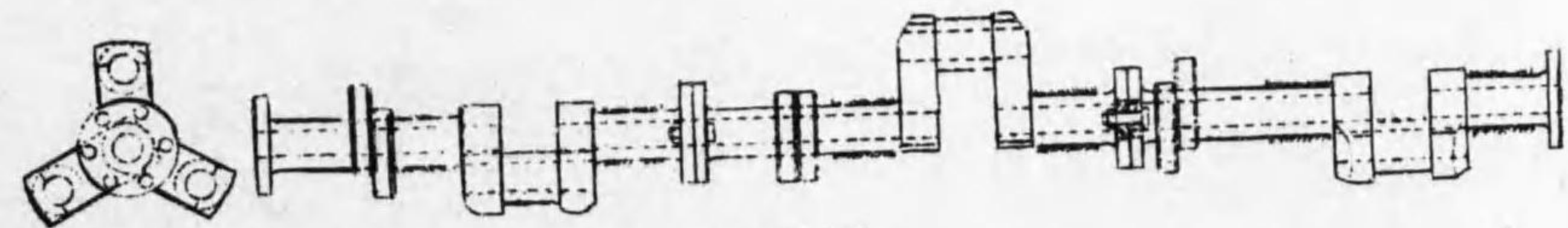

第 46 圖

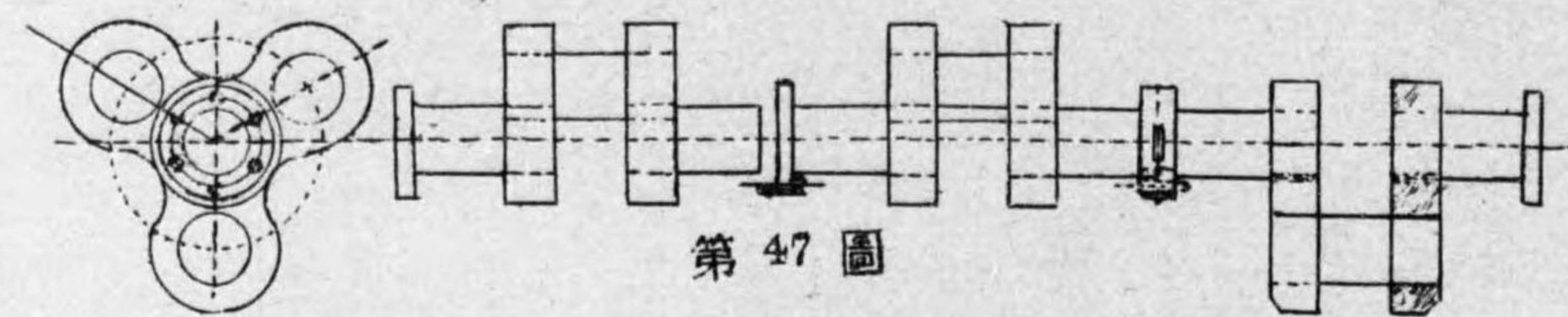

第 47 圖

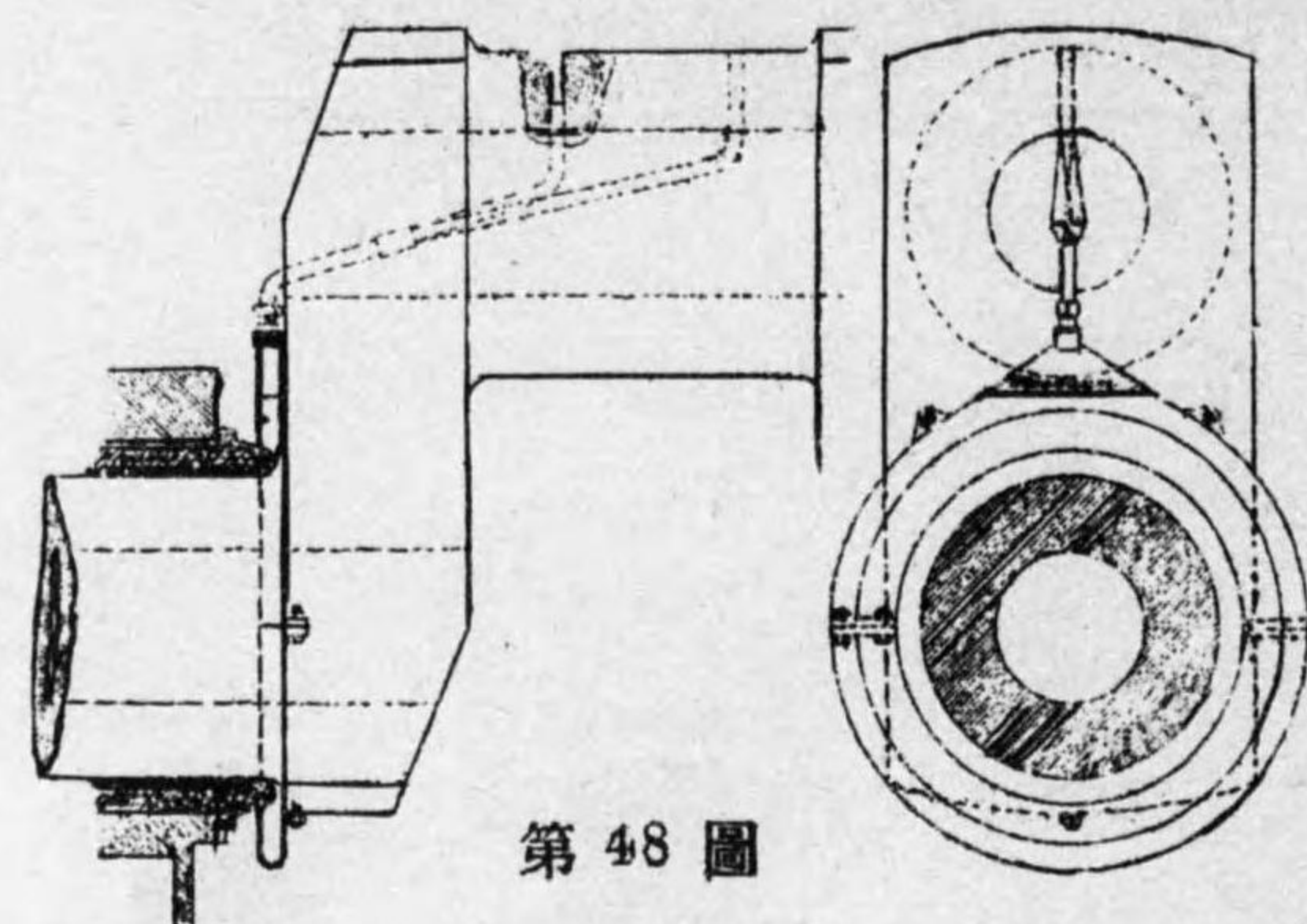

第 48 圖

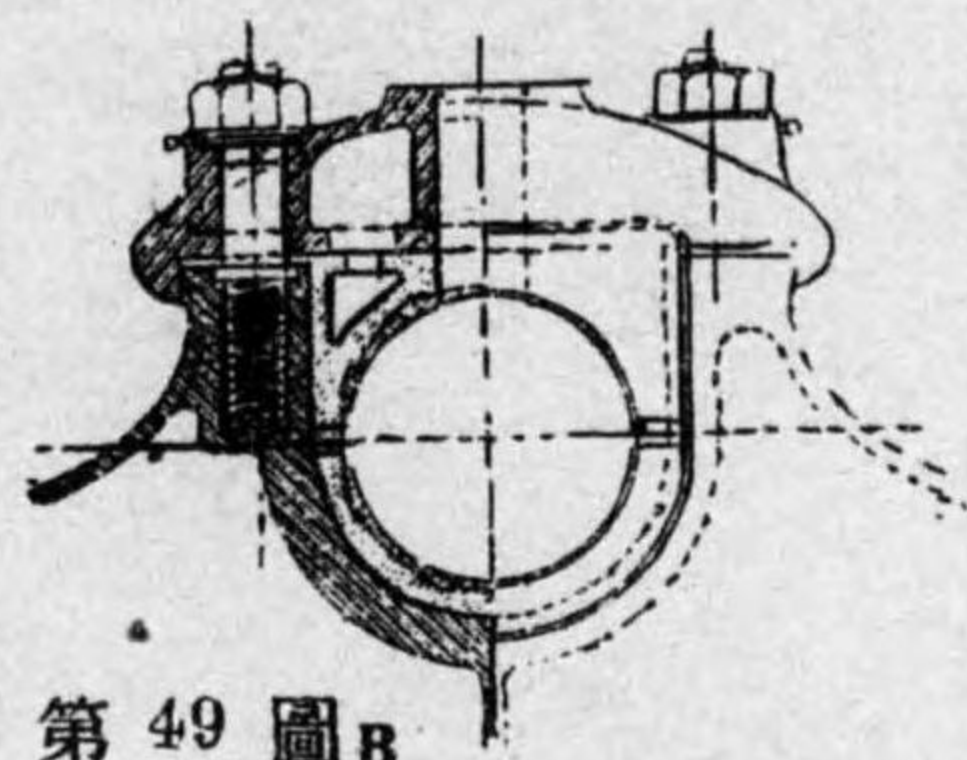

第 49 圖 B

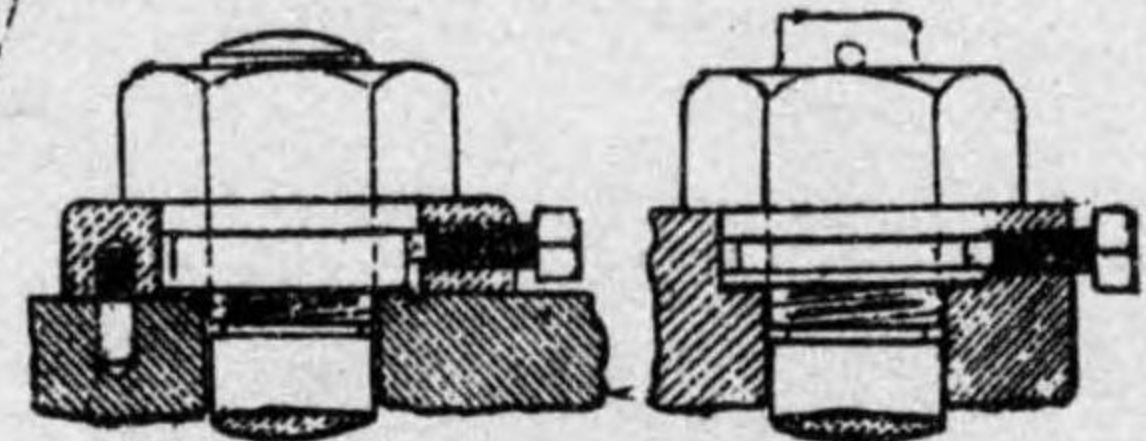

第 49 圖 C

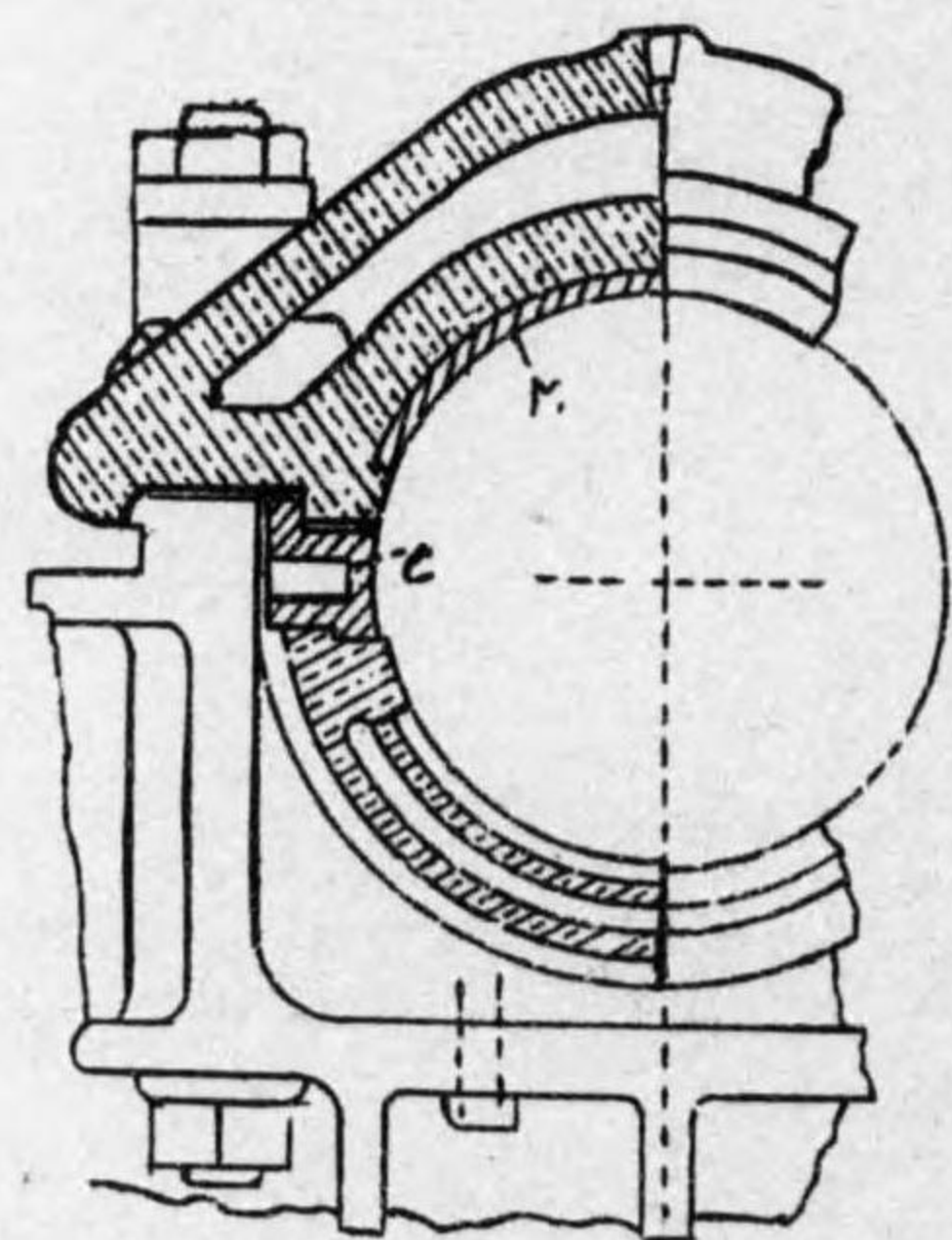

第 49 圖 A

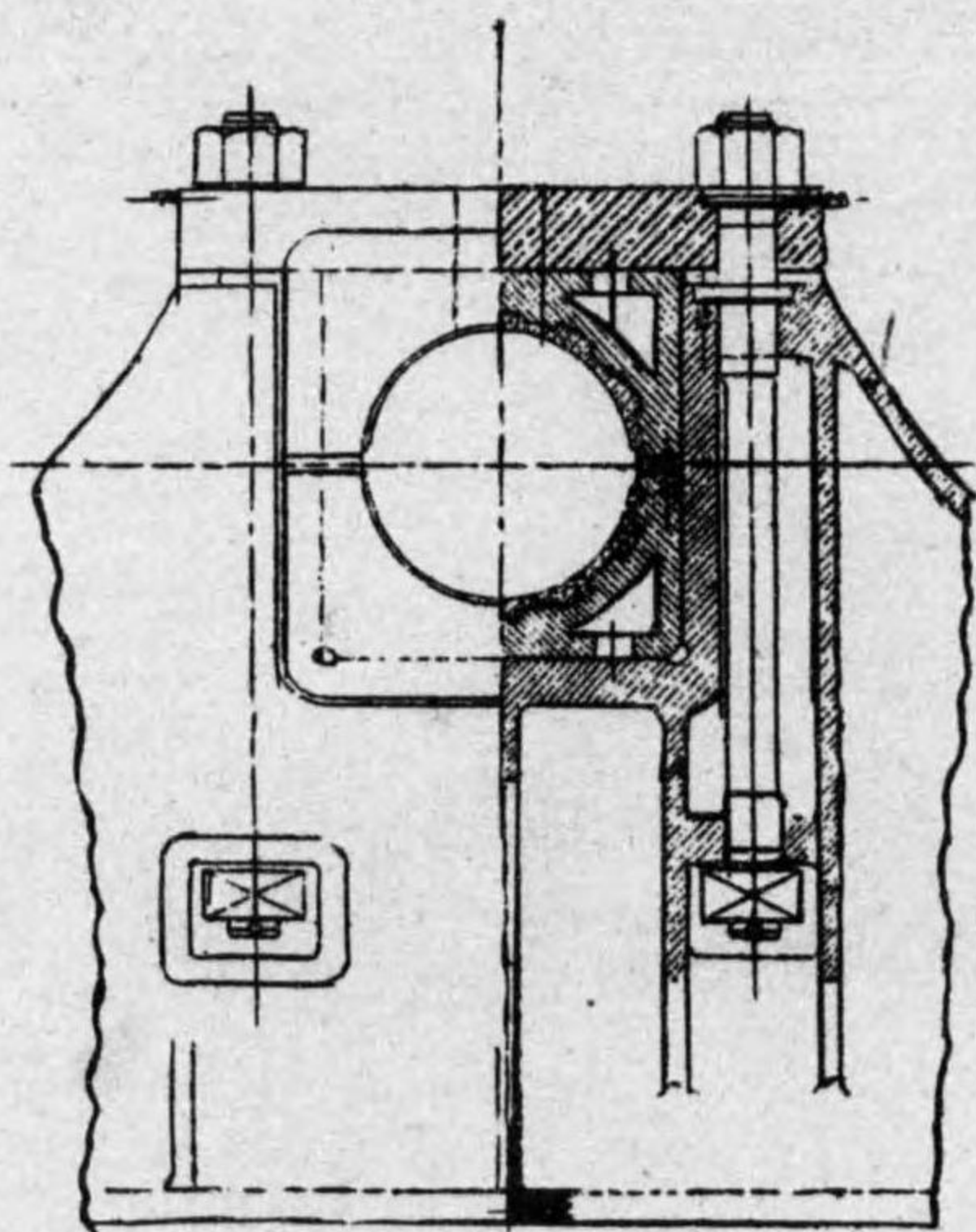

第 50 圖

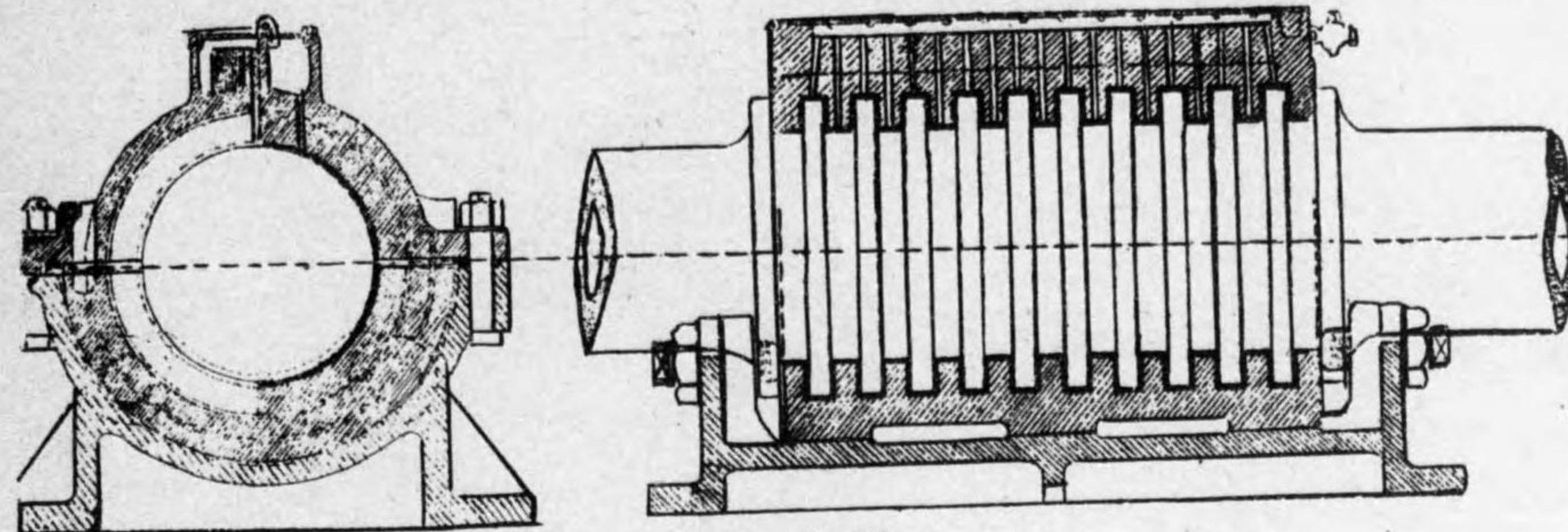

第 51 圖

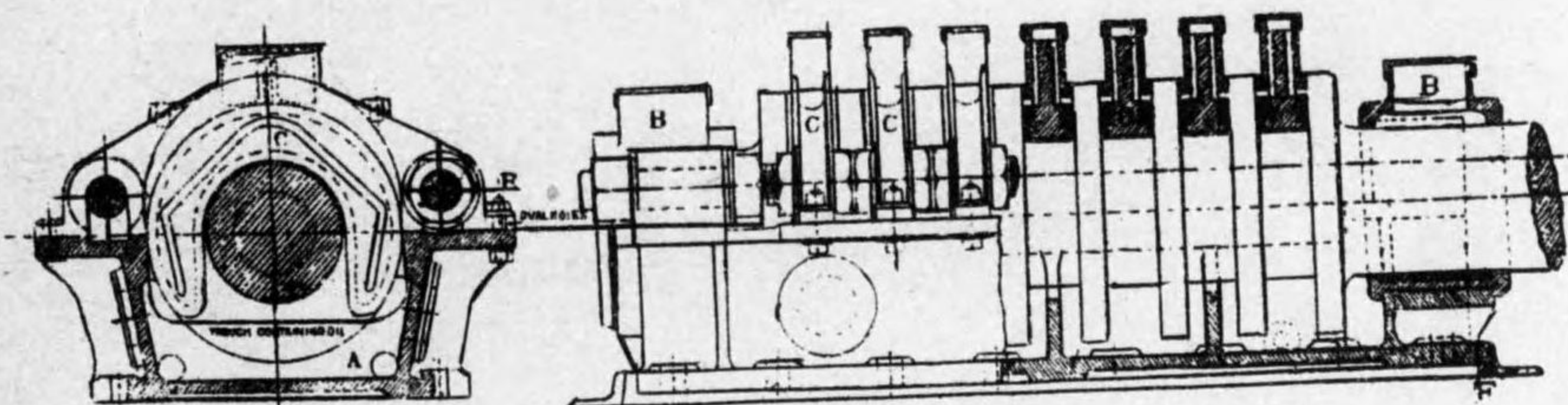

第 52 圖 A

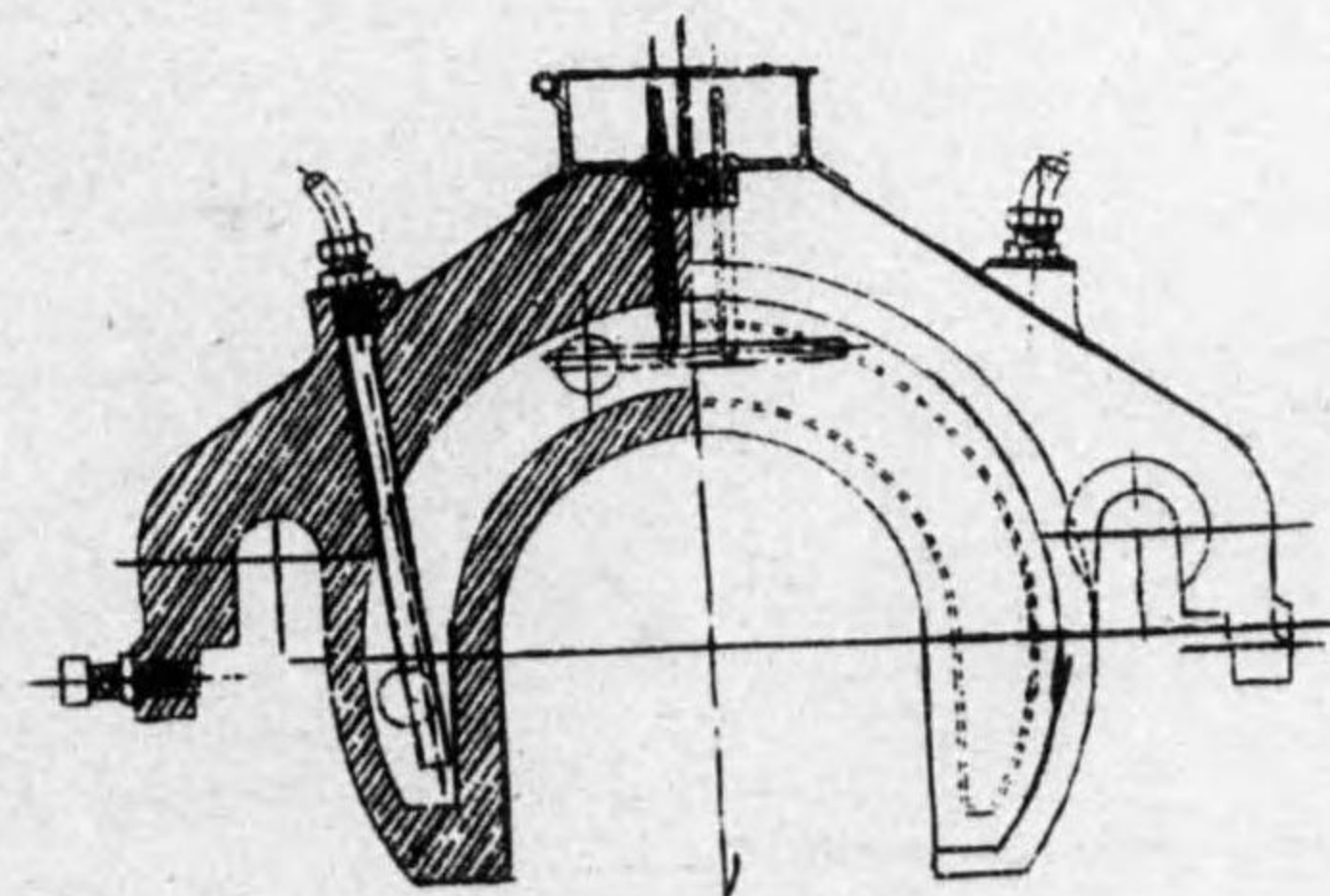

第 52 圖 B

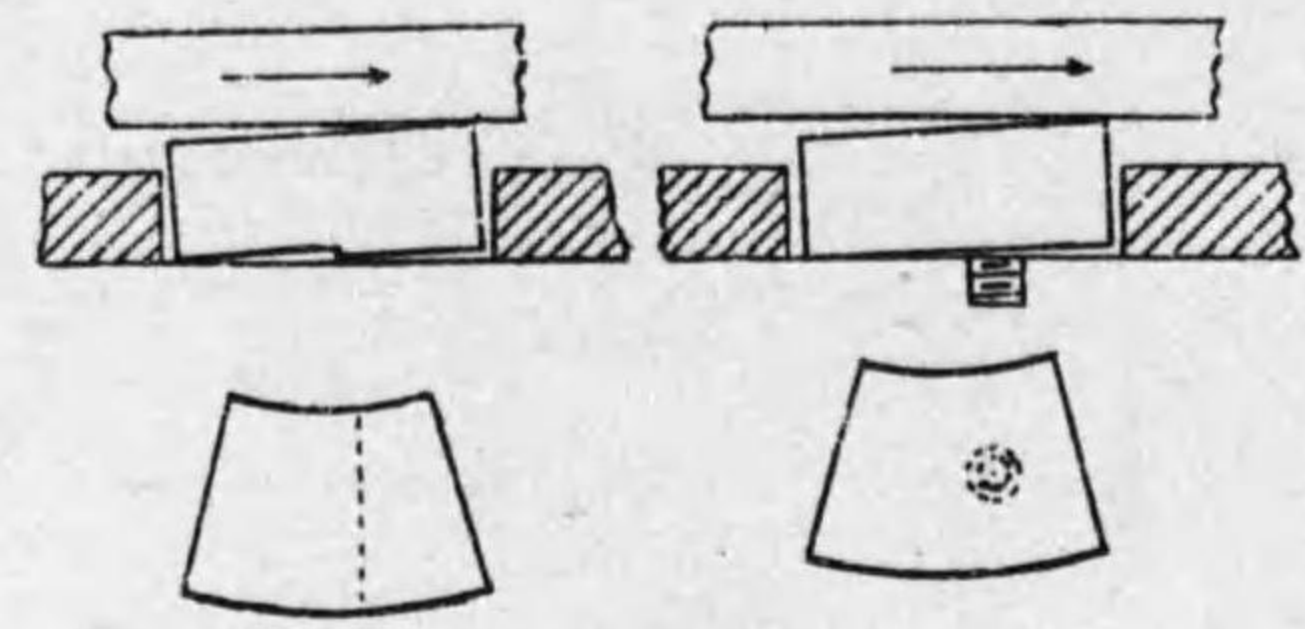

第 53 圖

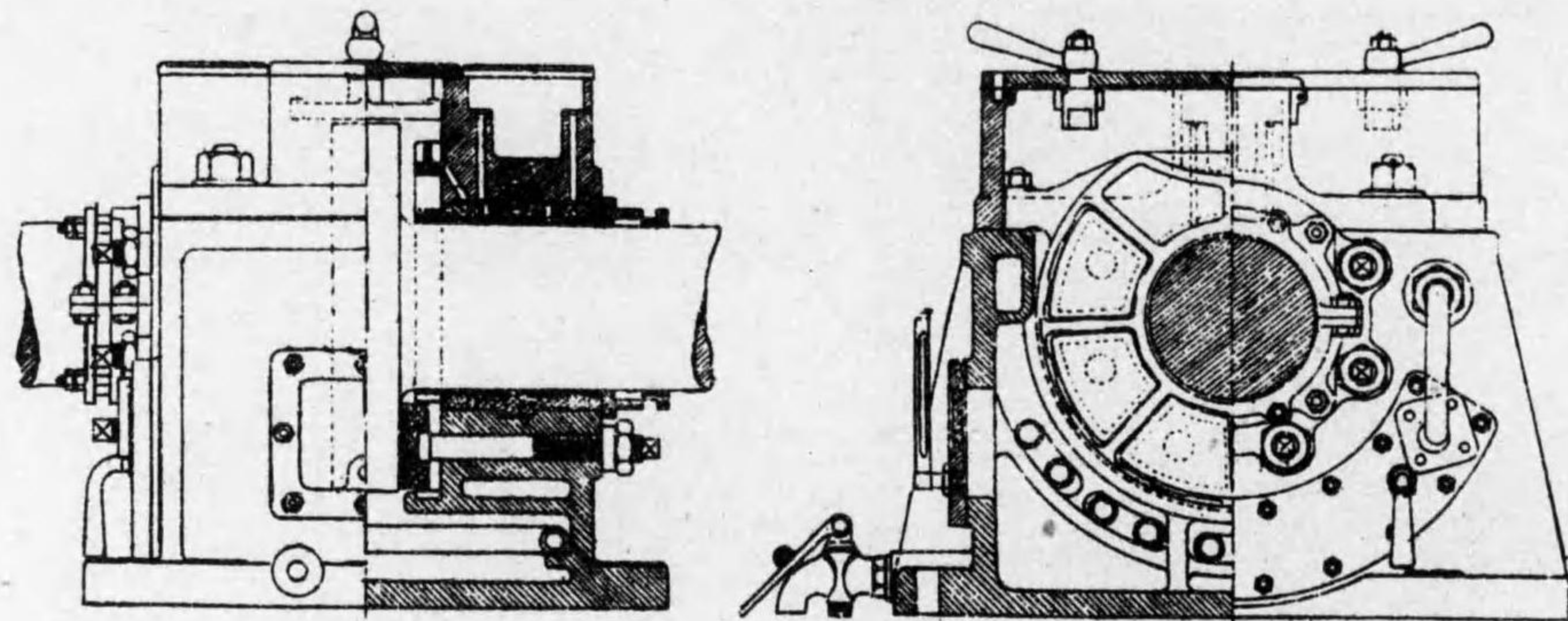

第 54 圖 A

第 54 圖 B

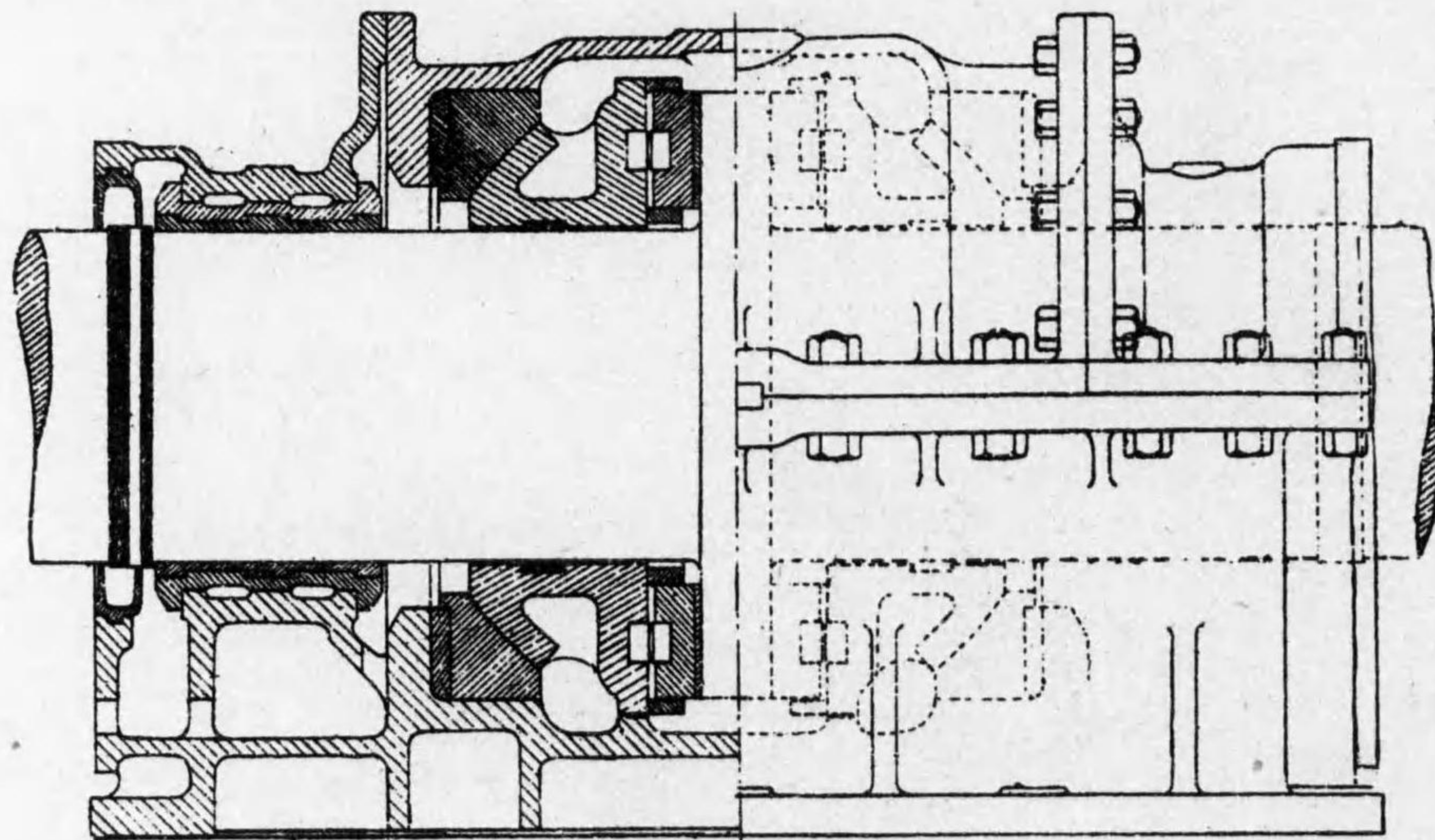

第 55 圖

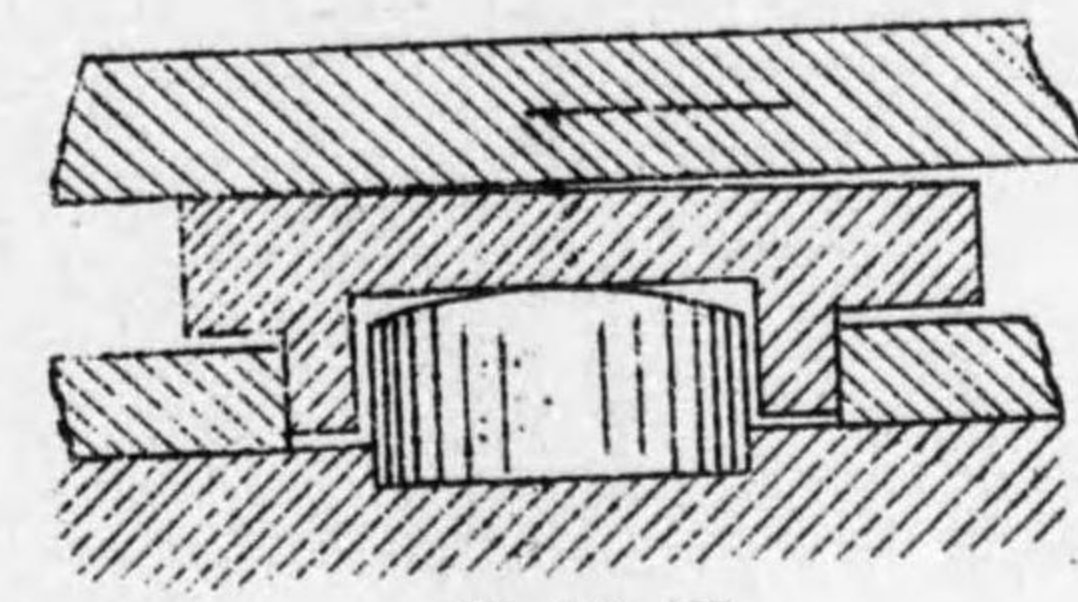

第 56 圖

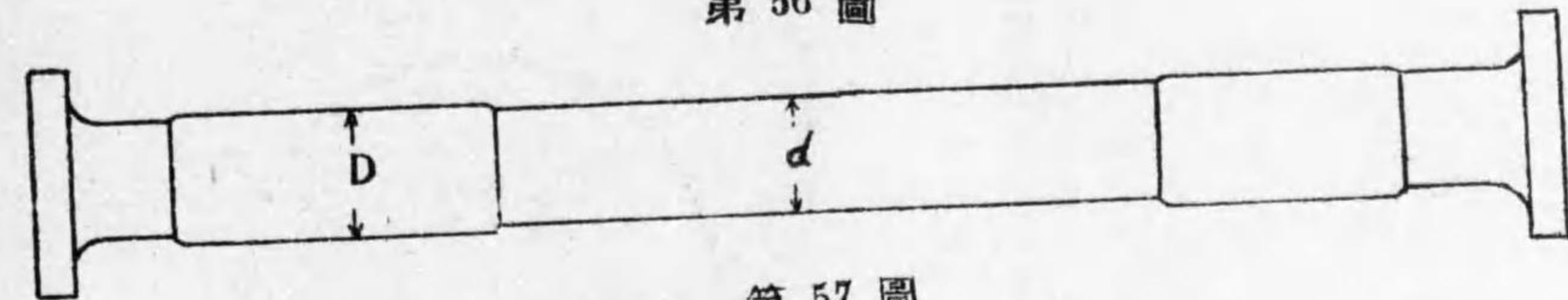

第 57 圖

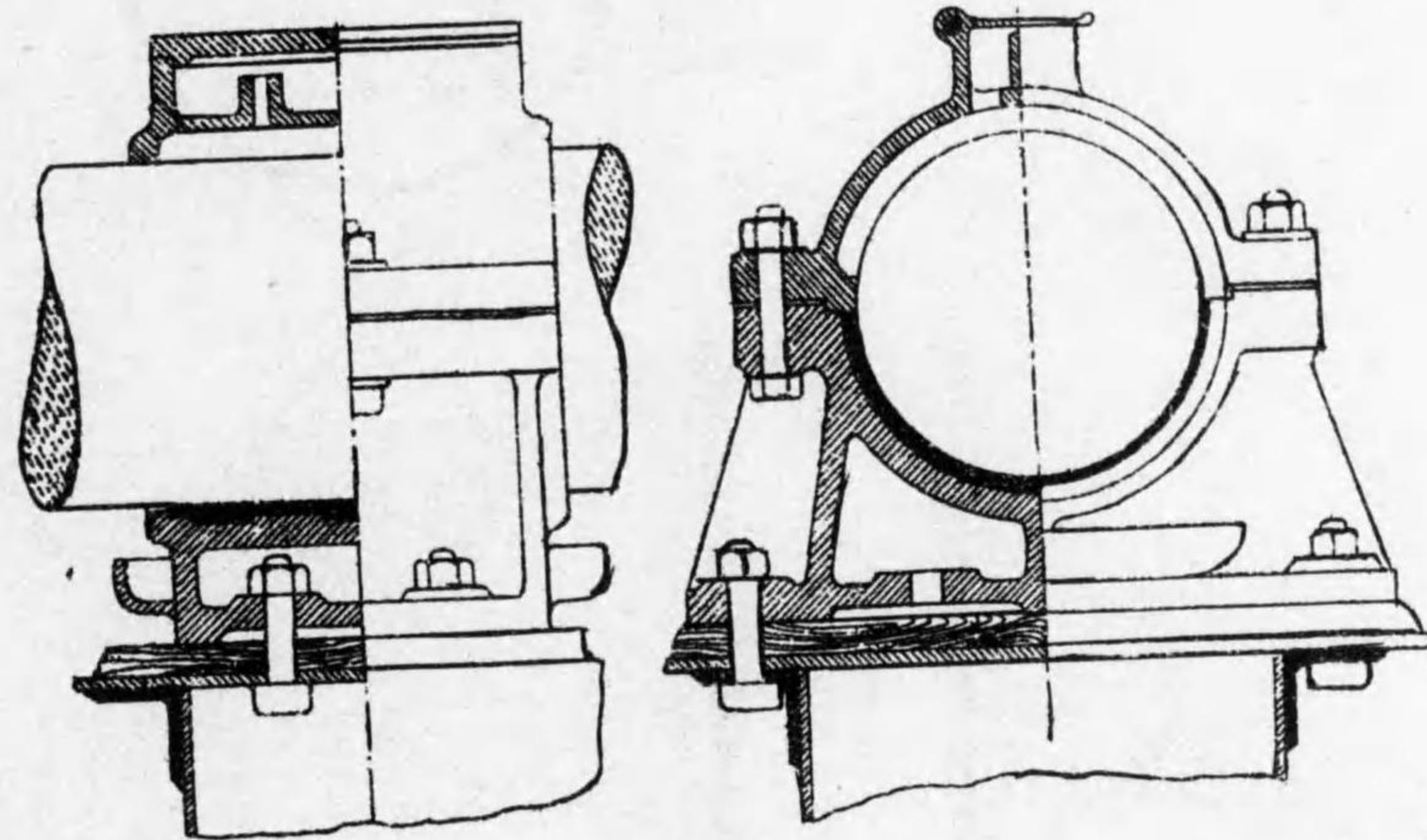

第 58 圖

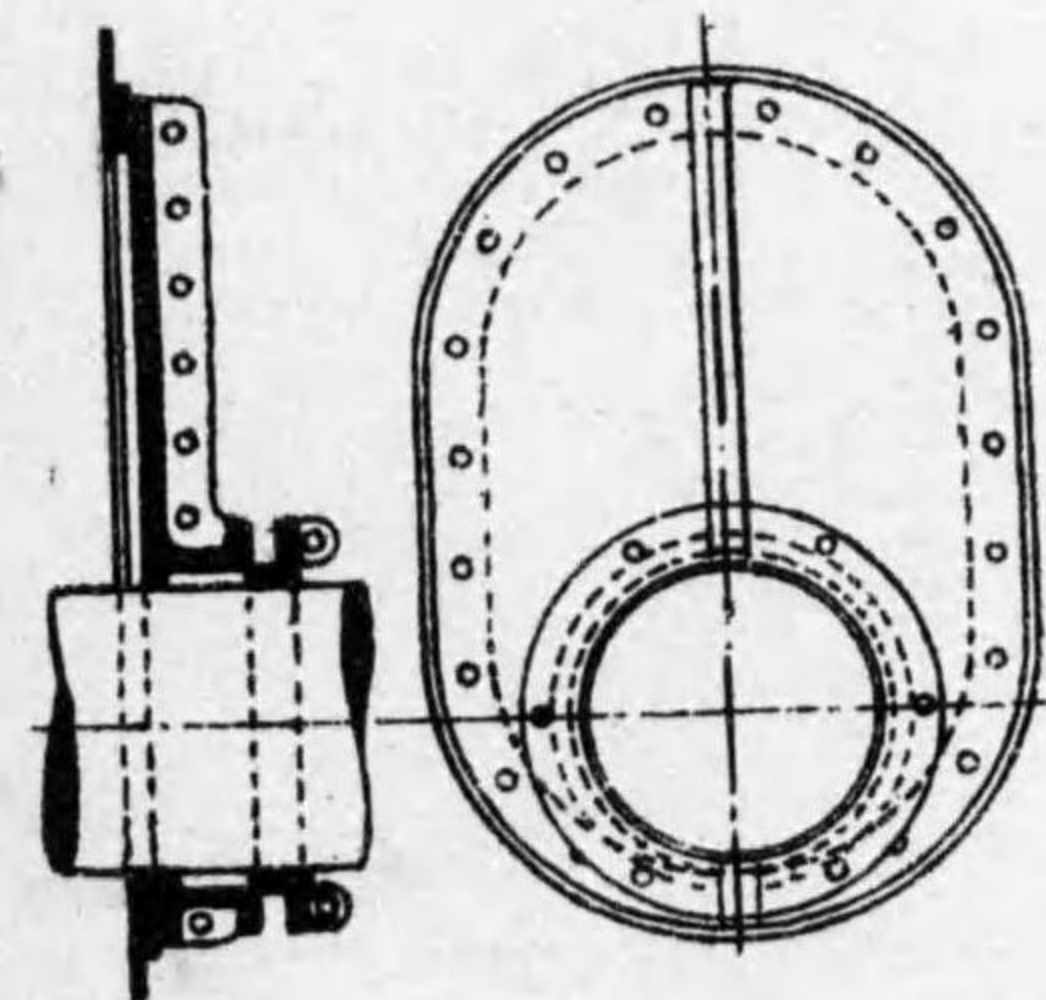

第 59 圖

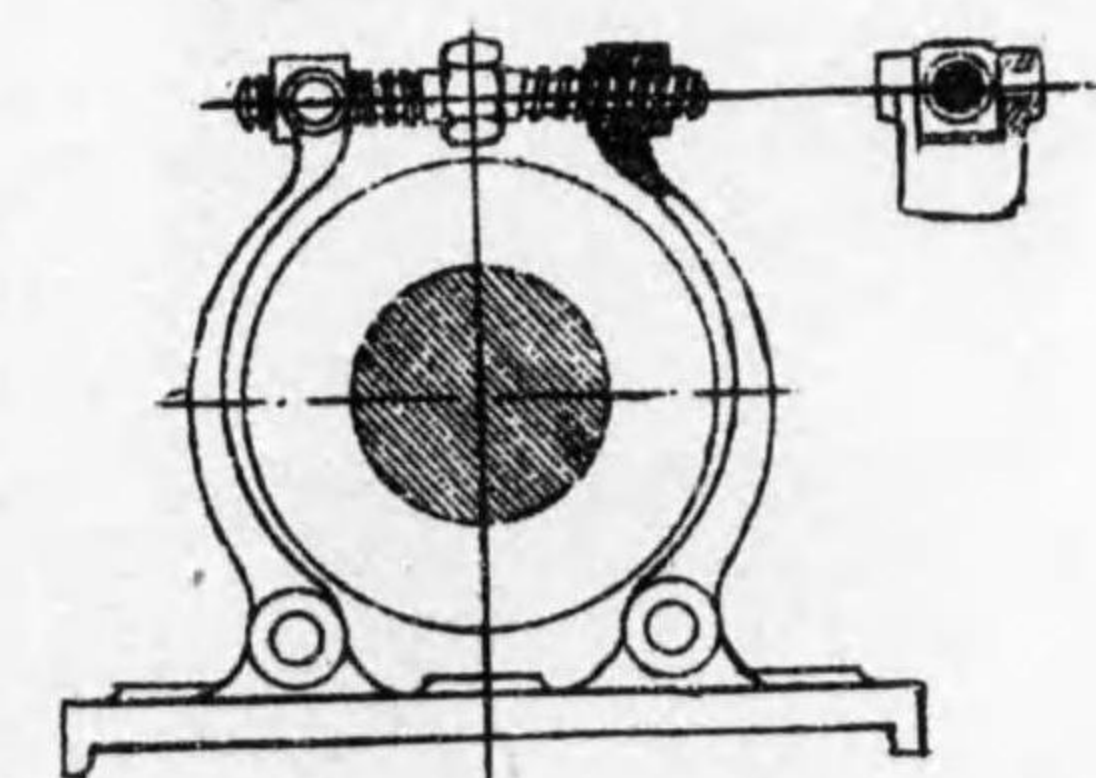

第 60 圖

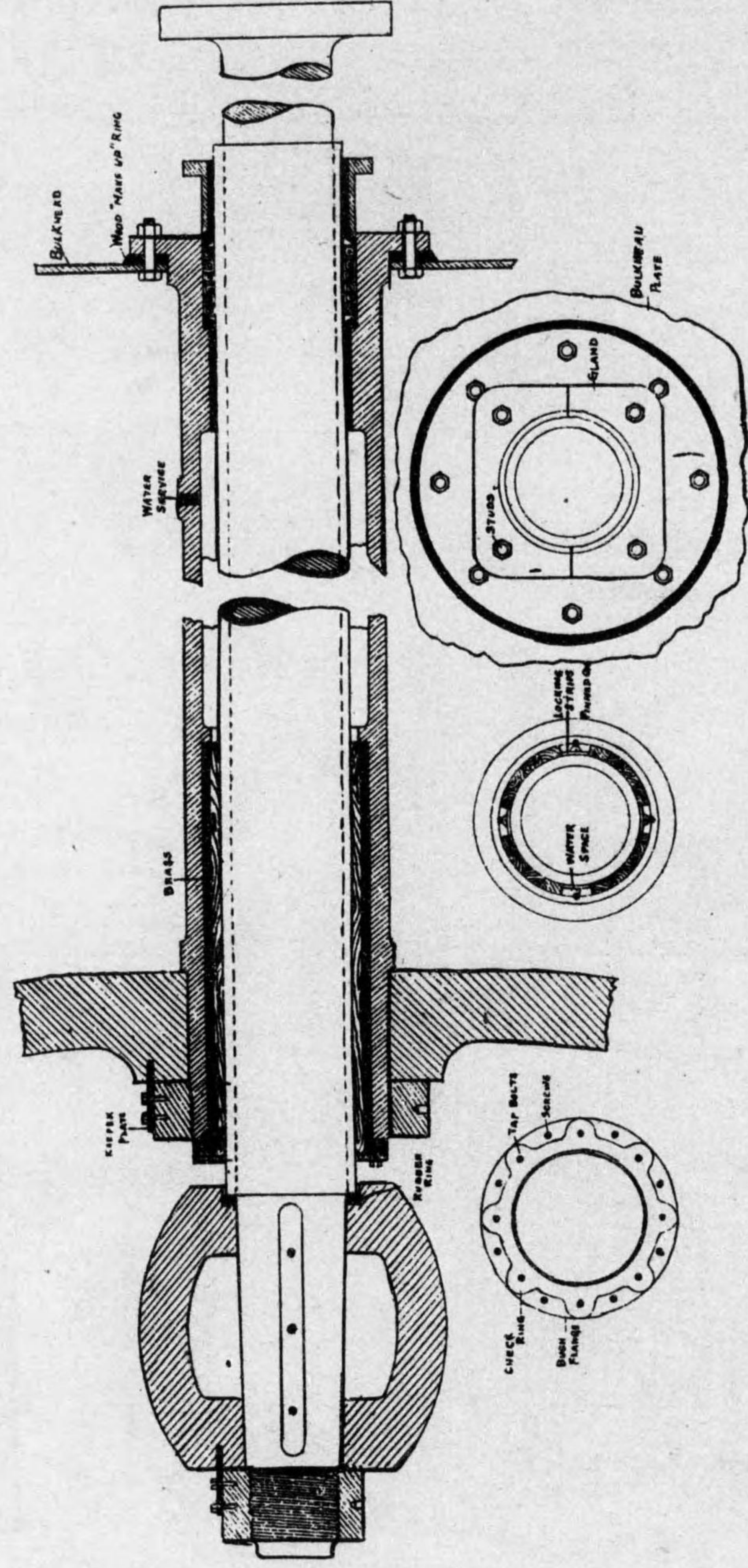

第 61 圖

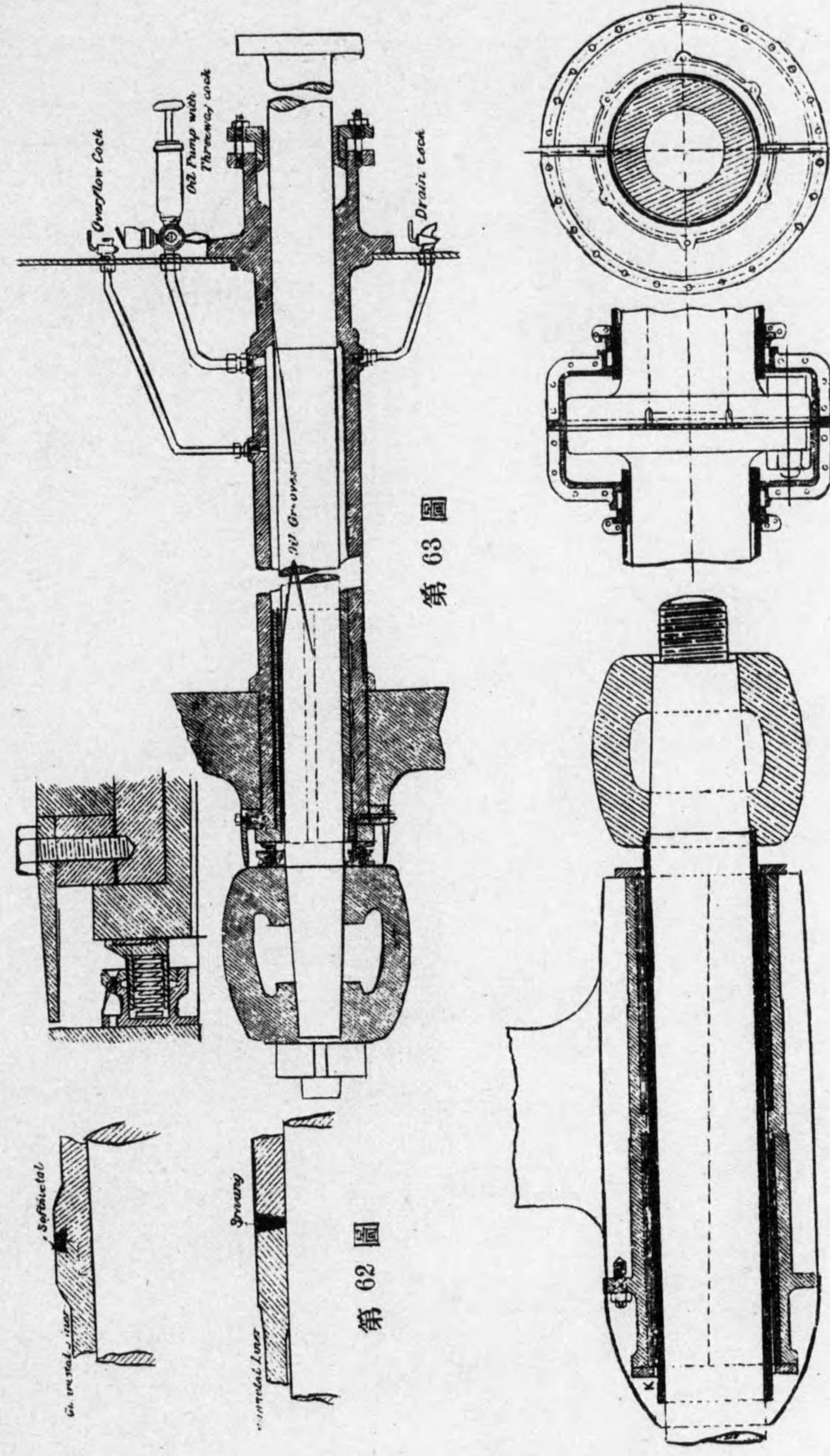

第 62 圖

第 63 圖

第 64 圖

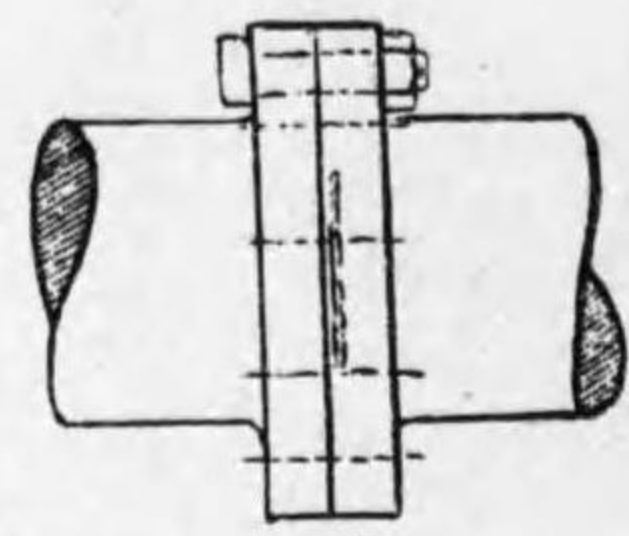

第 65 圖 A

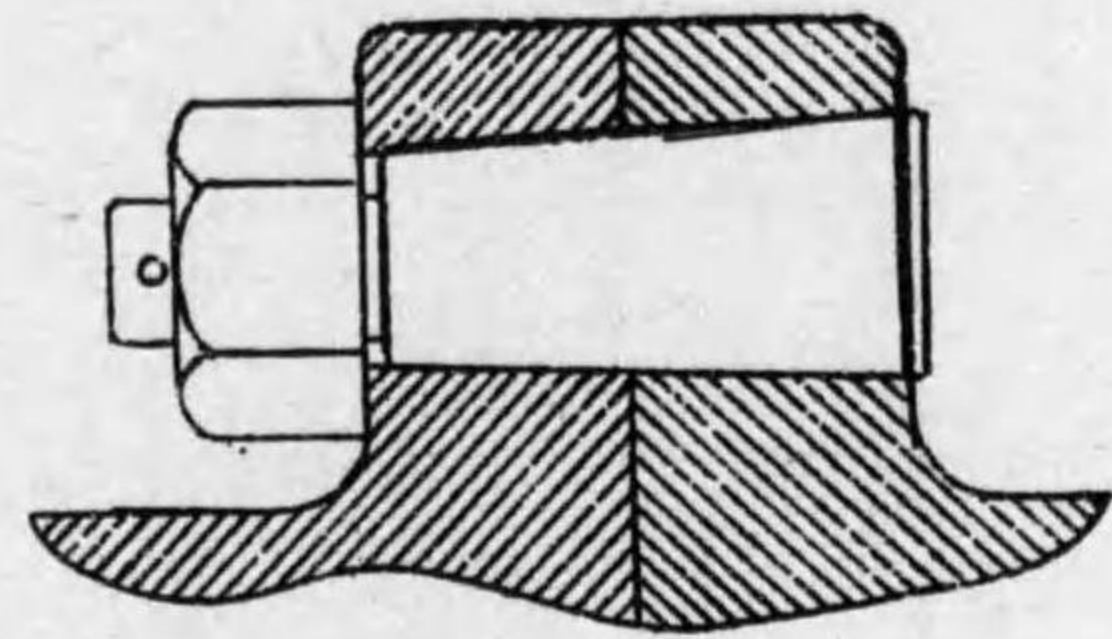
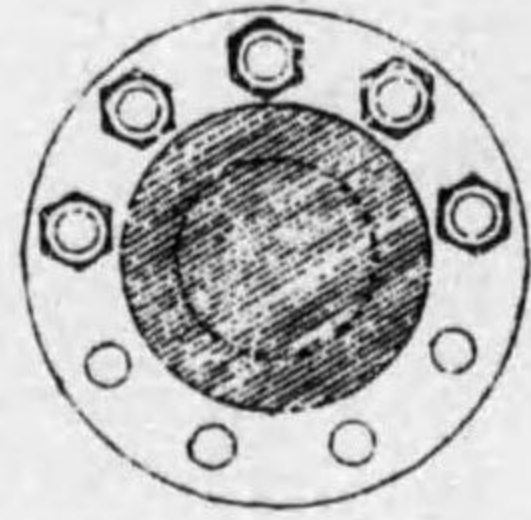

第 65 圖 B

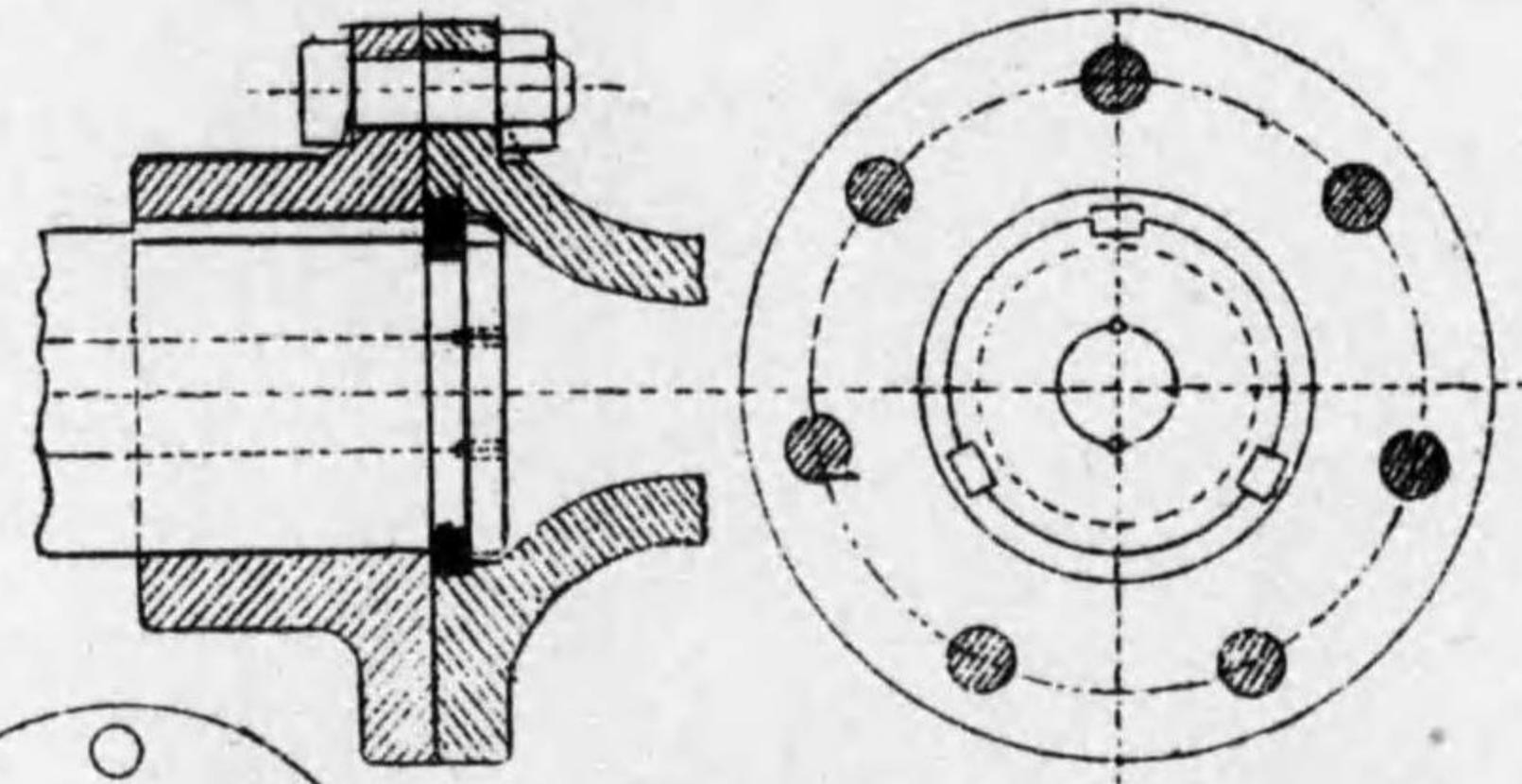

第 66 圖 A

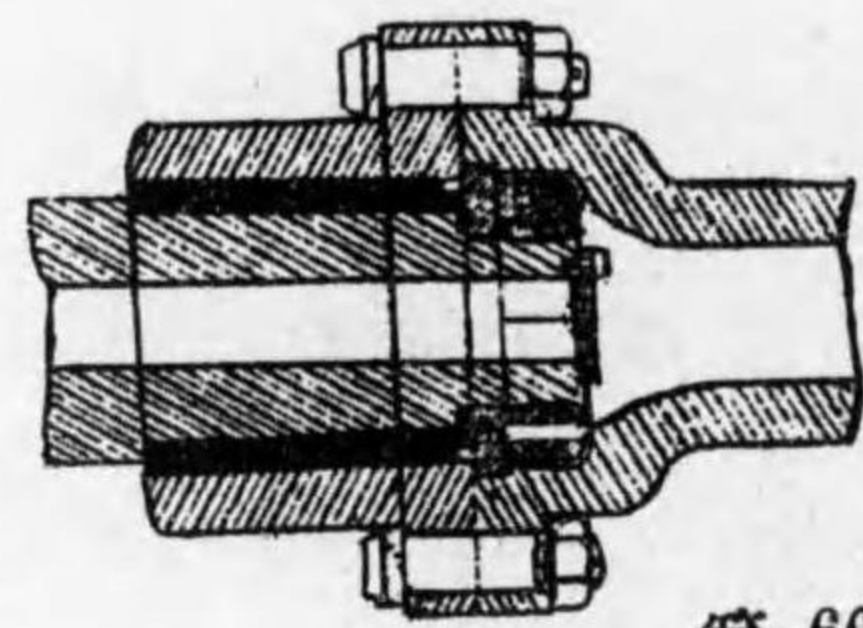

第 66 圖 B

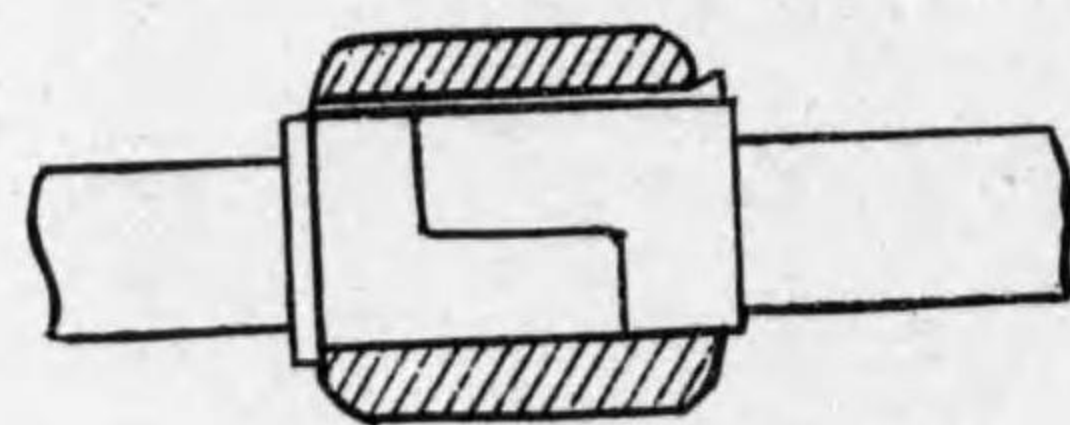
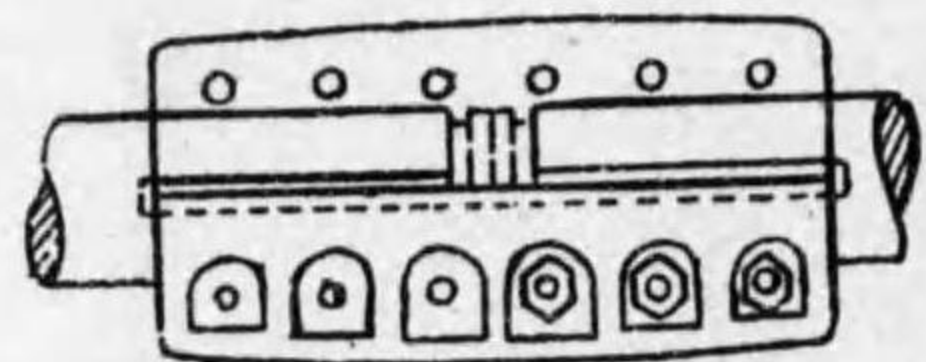
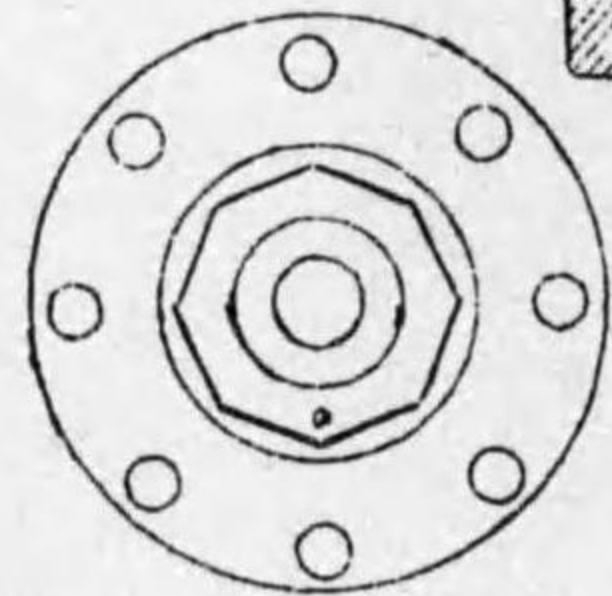

第 67 圖

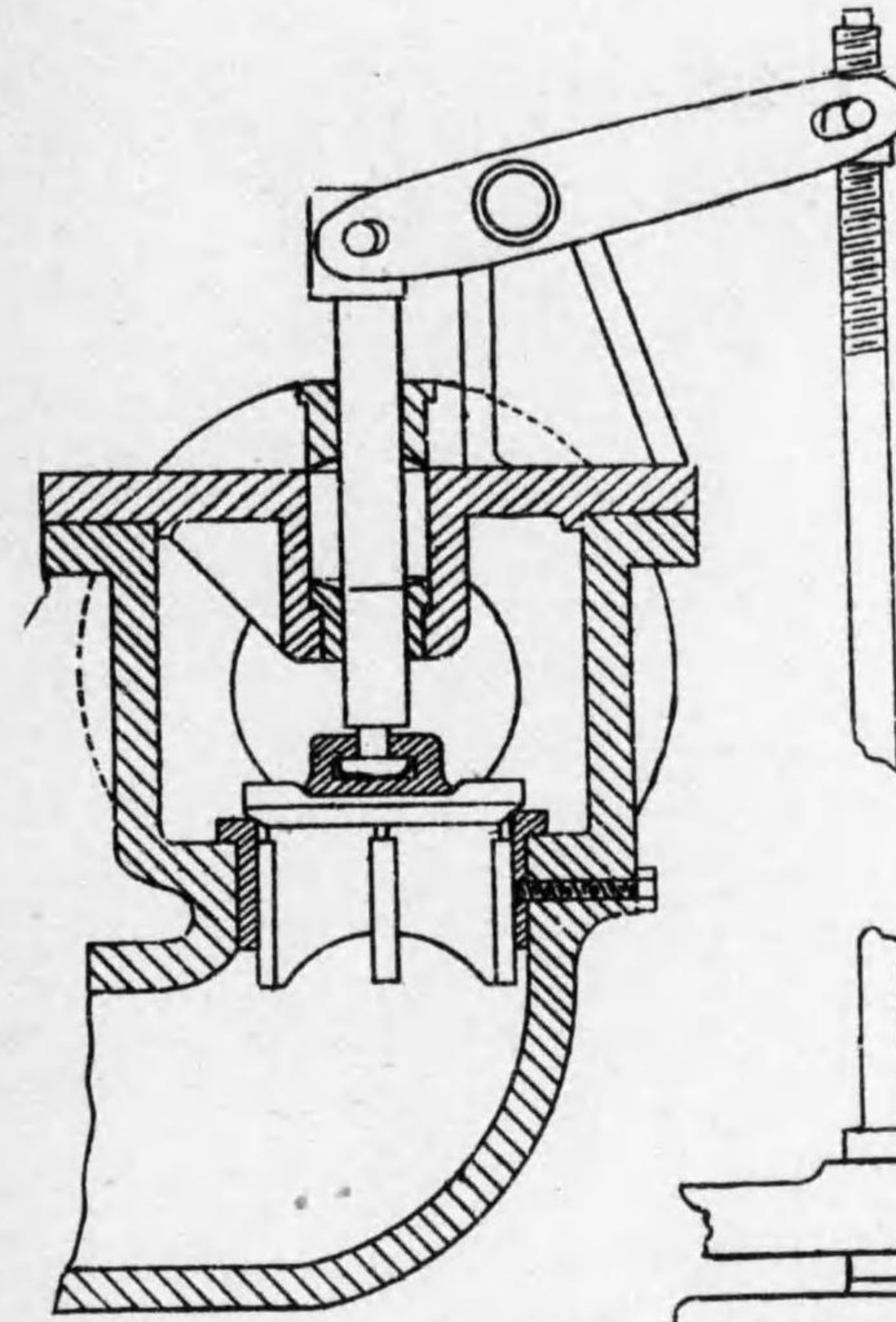

第 68 圖 A

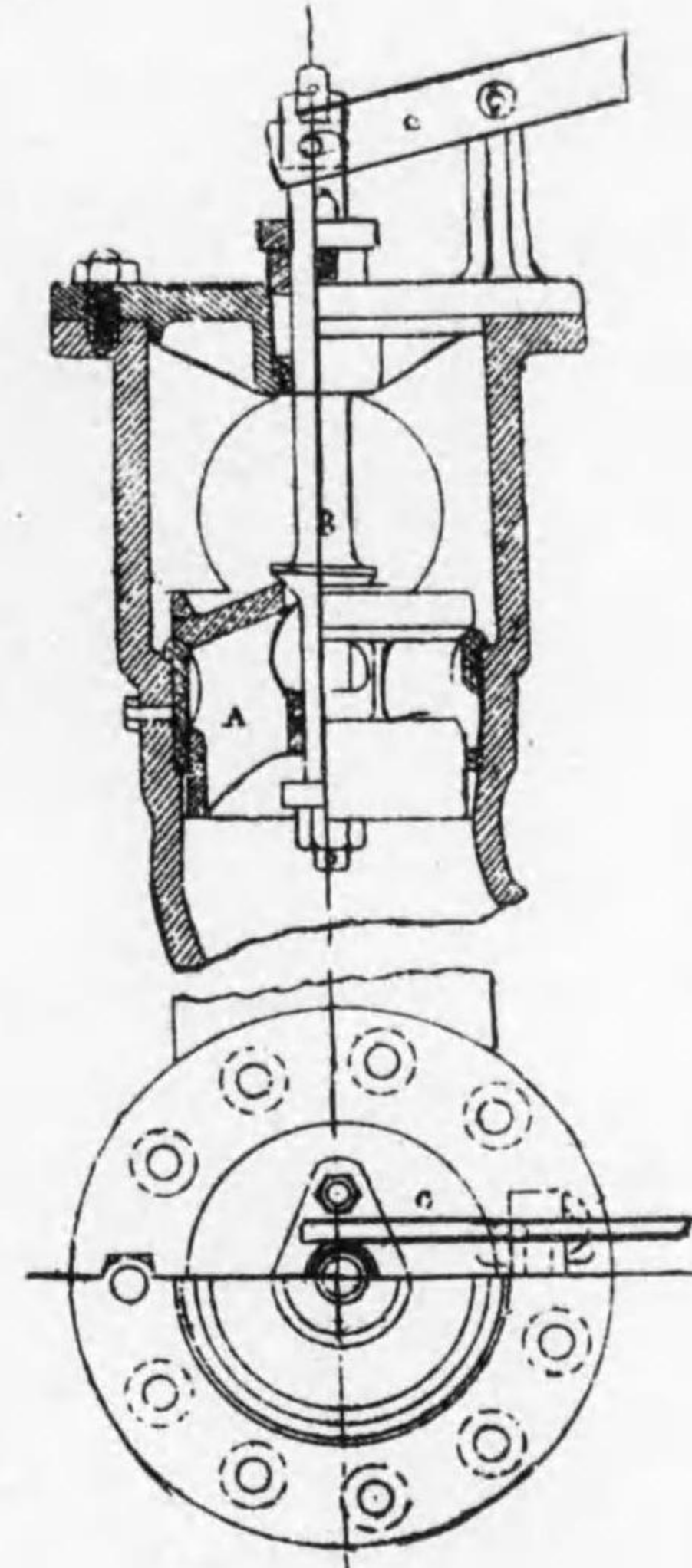
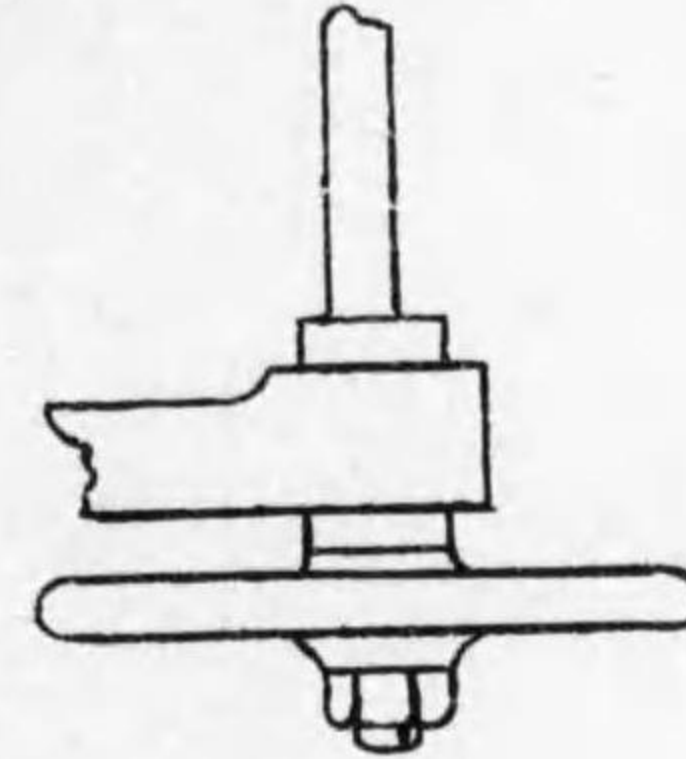

第 68 圖 B

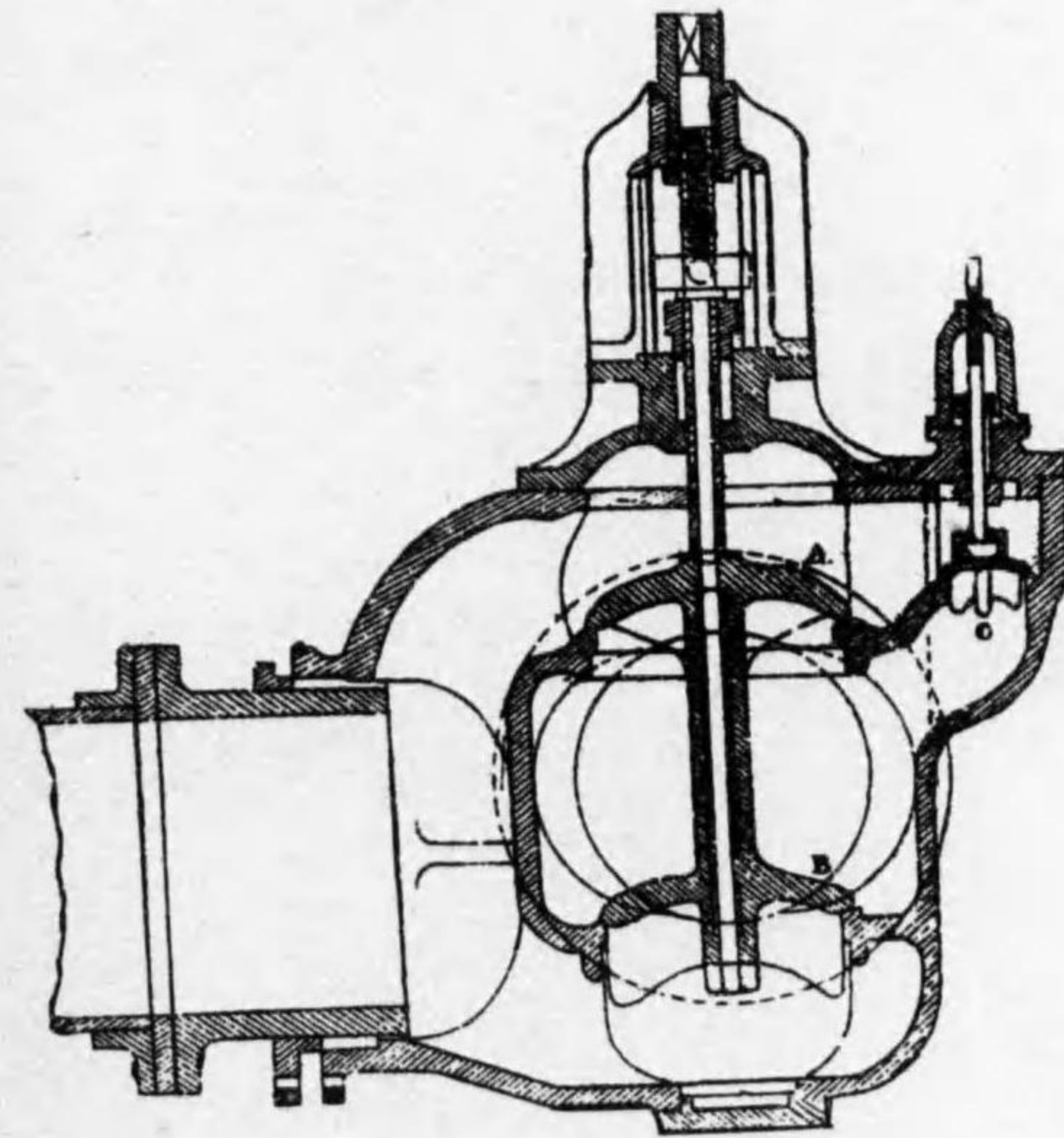

第 69 圖

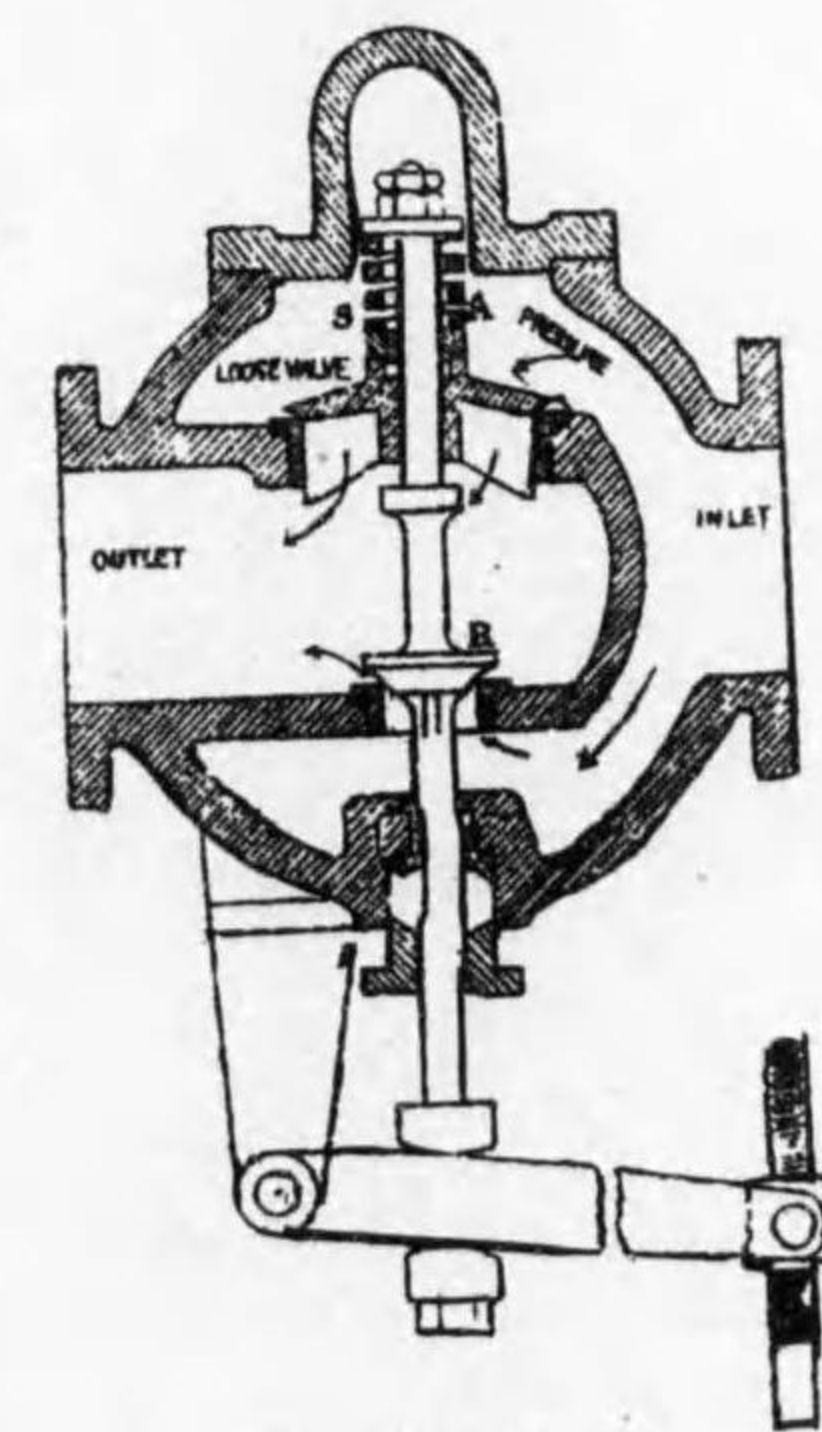

第 70 圖

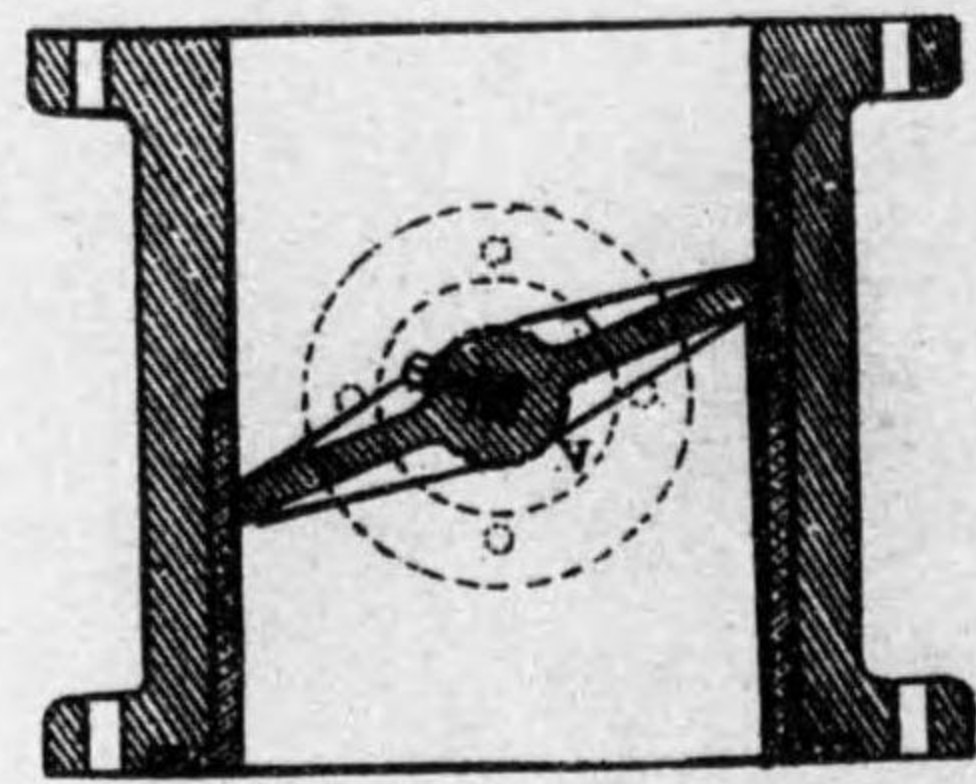

第 71 圖 c

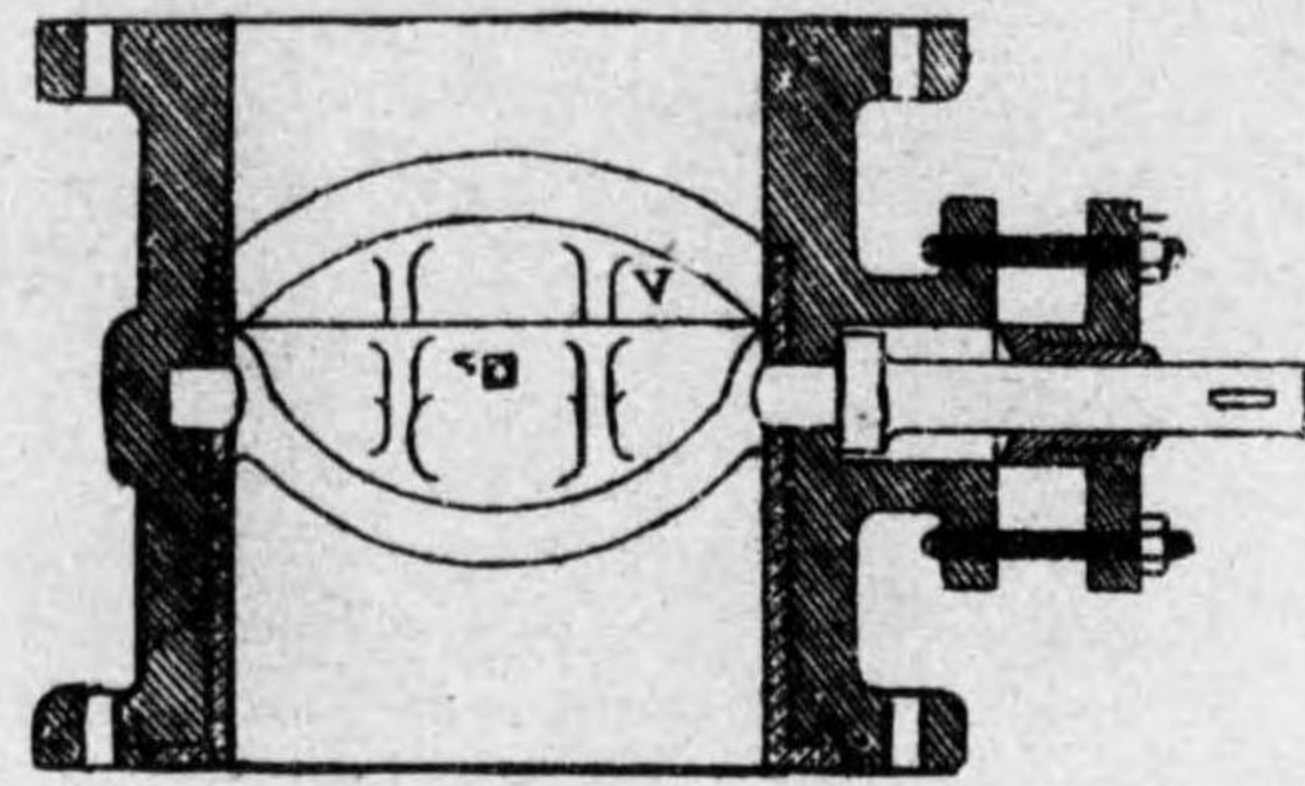

第 71 圖 A

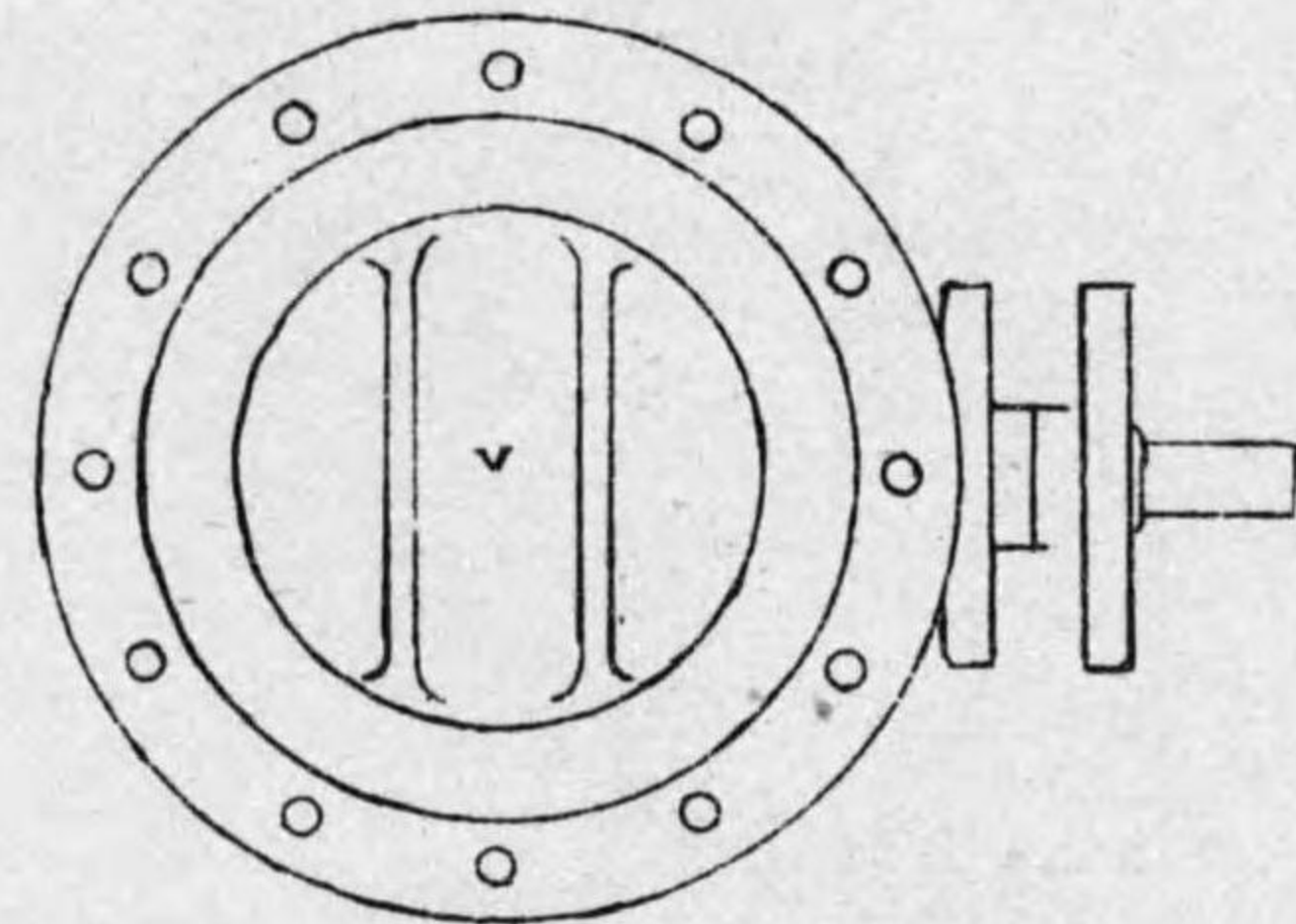

第 71 圖 B

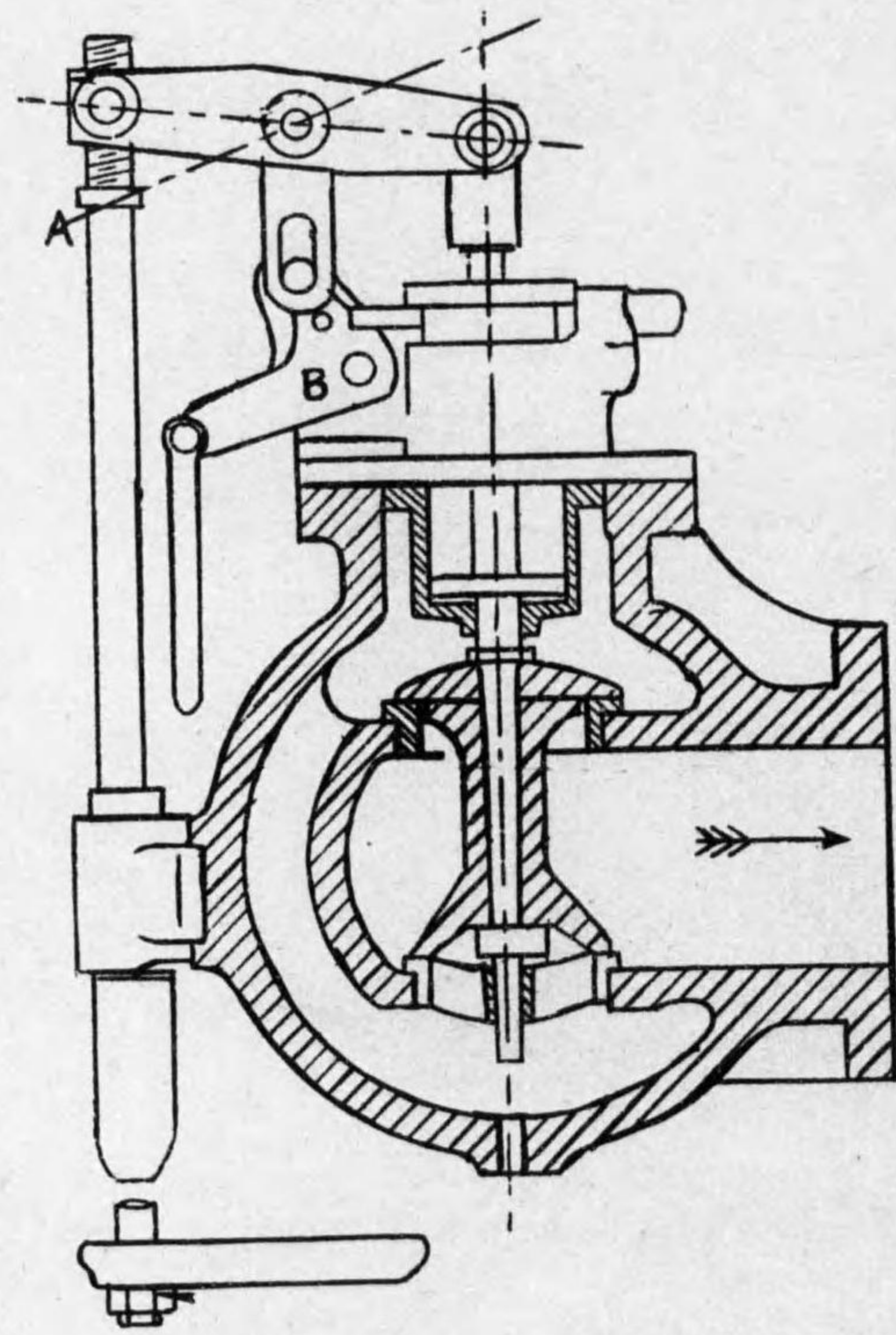

第 72 圖

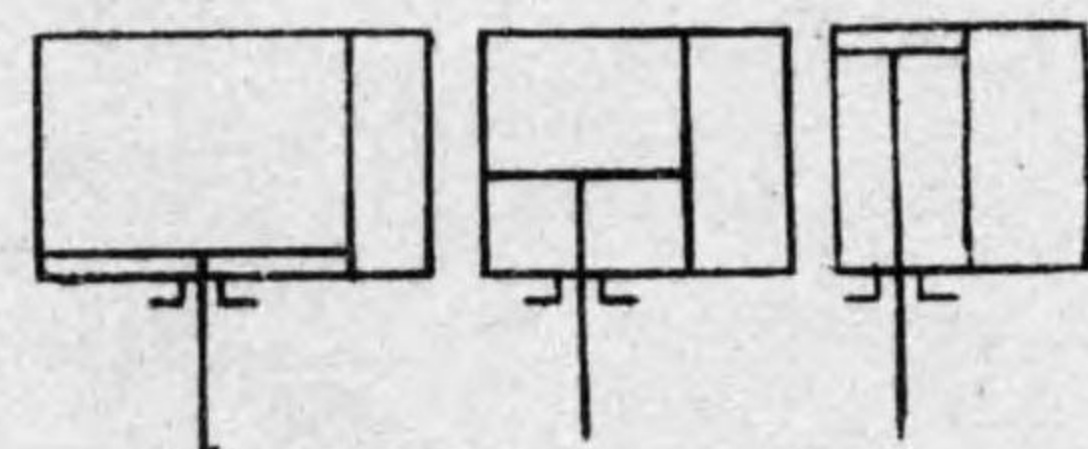

第 73 圖

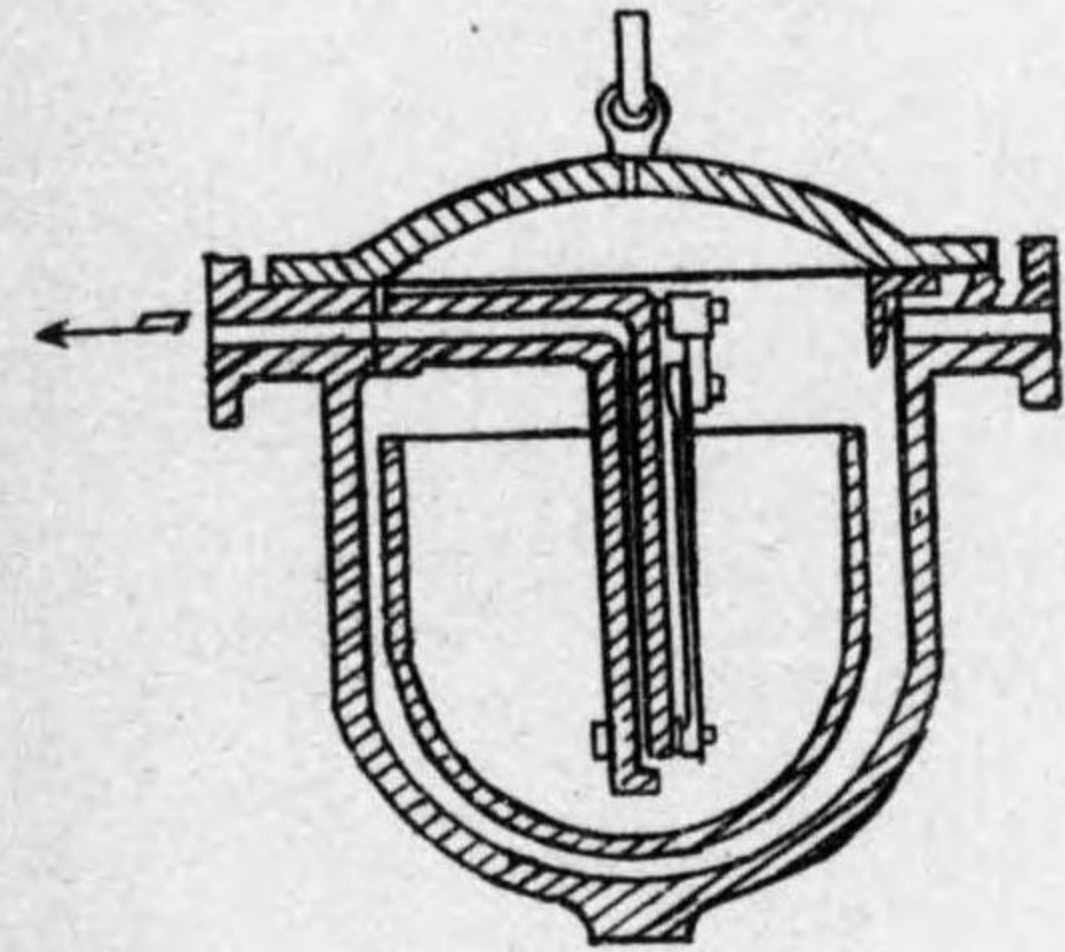
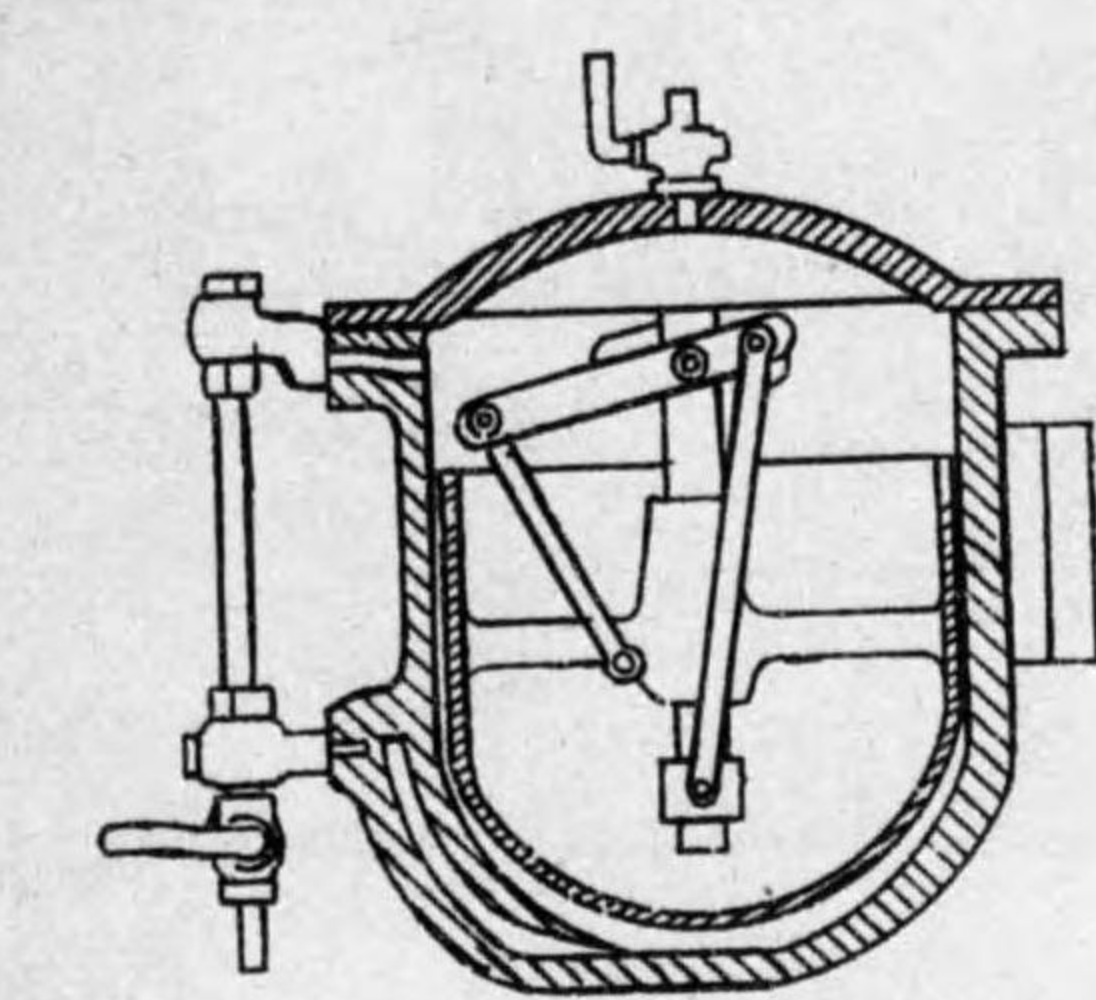

第 74 圖 A

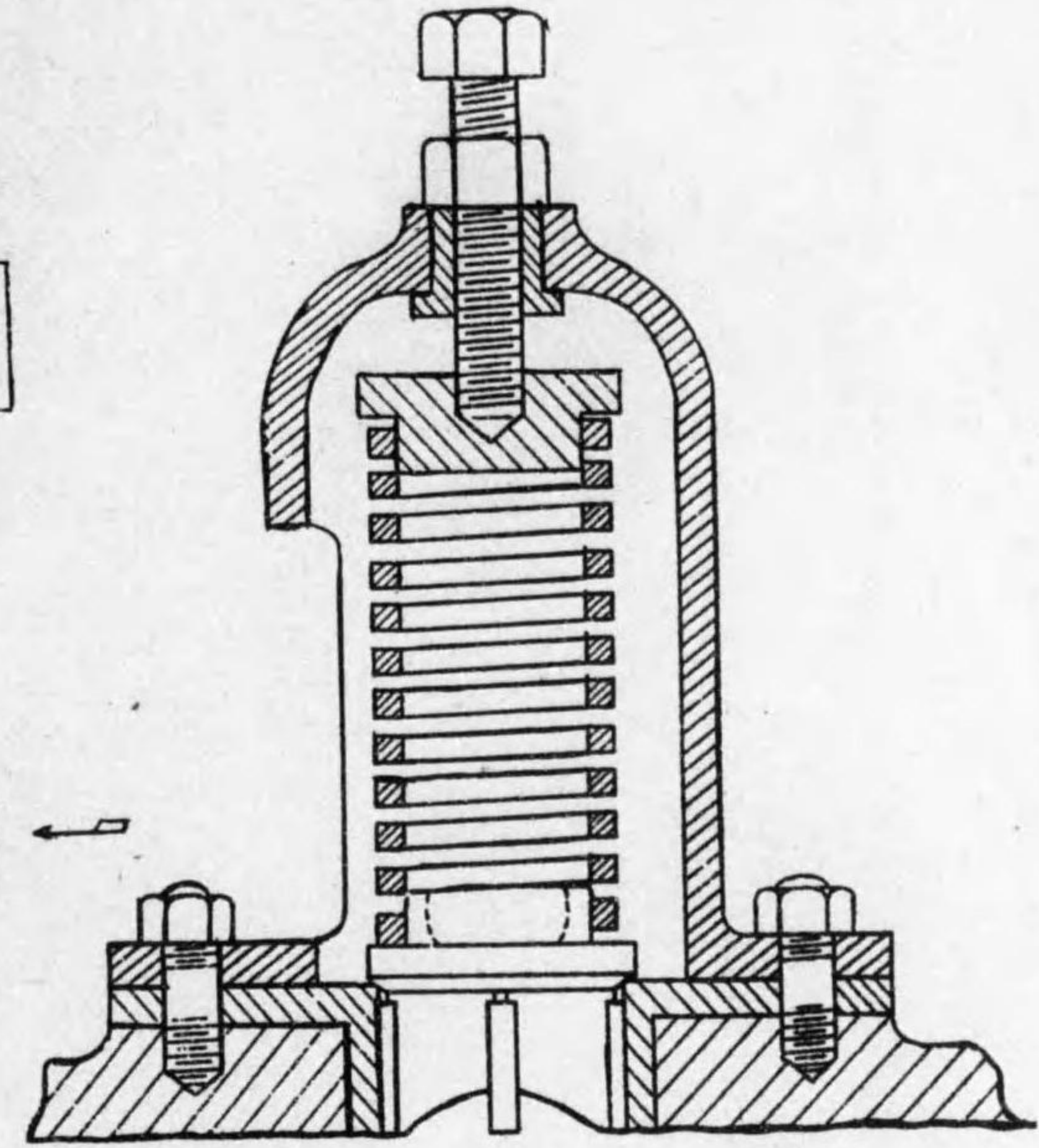

第 75 圖

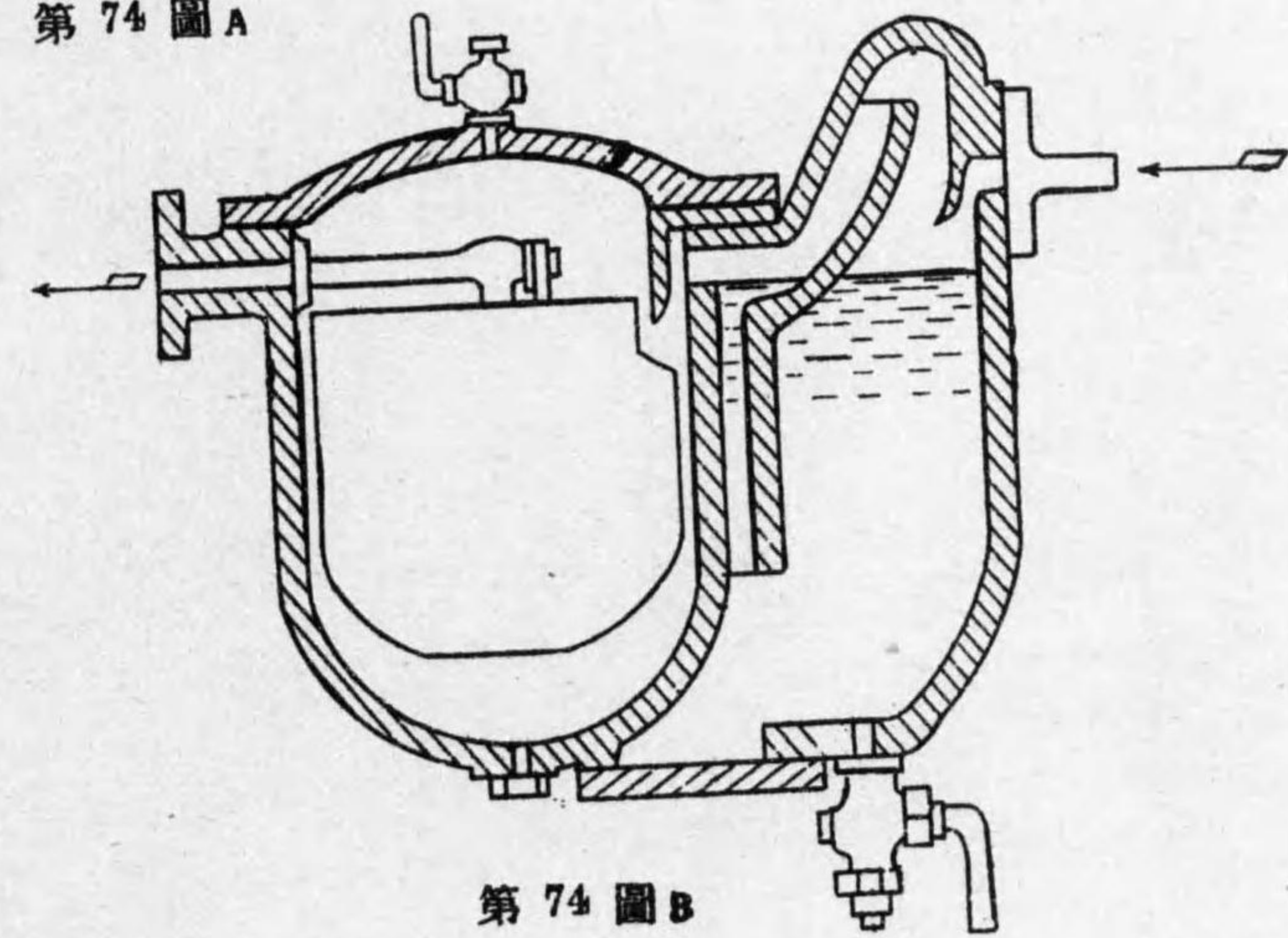

第 74 圖 B

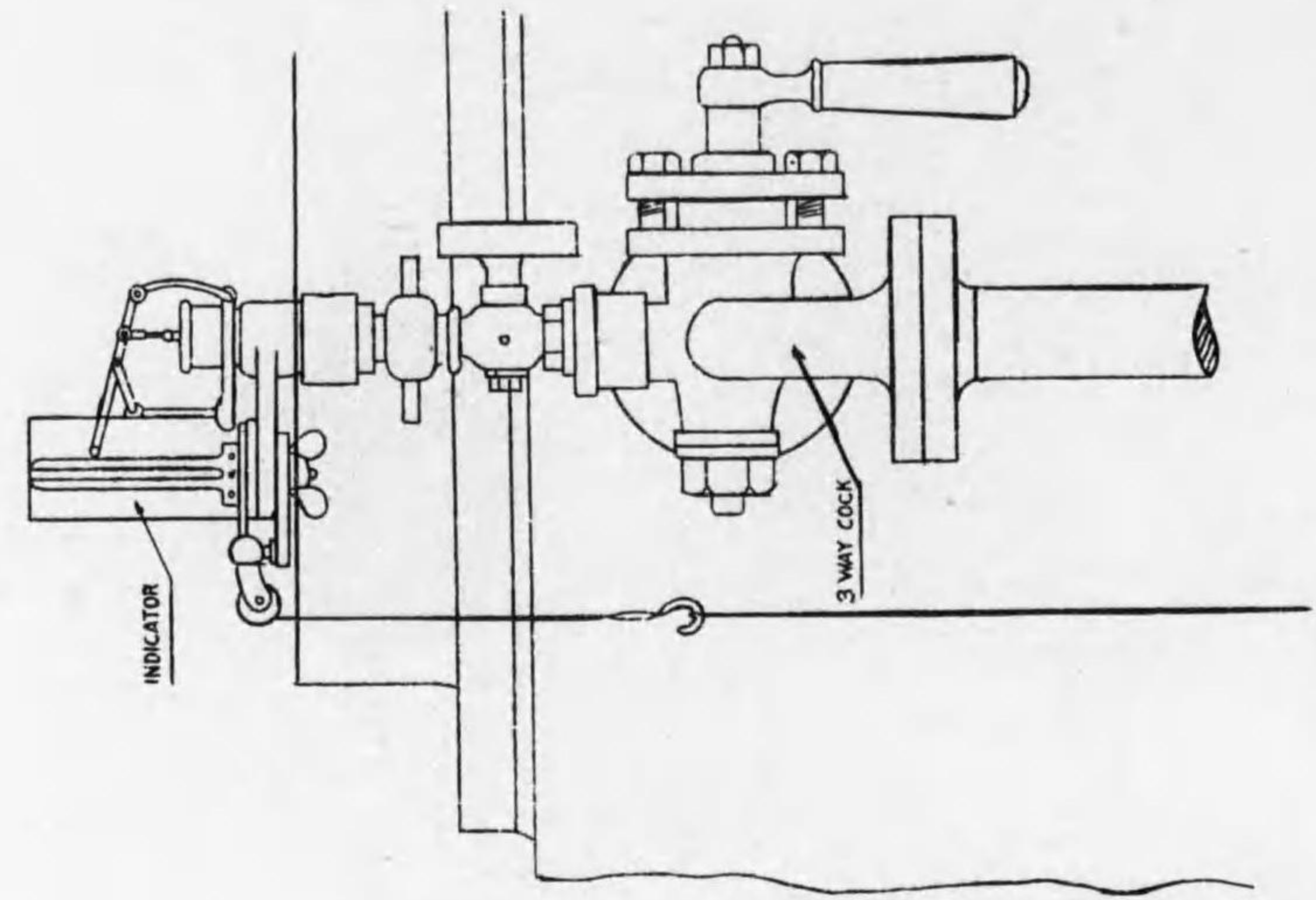

第 76 圖

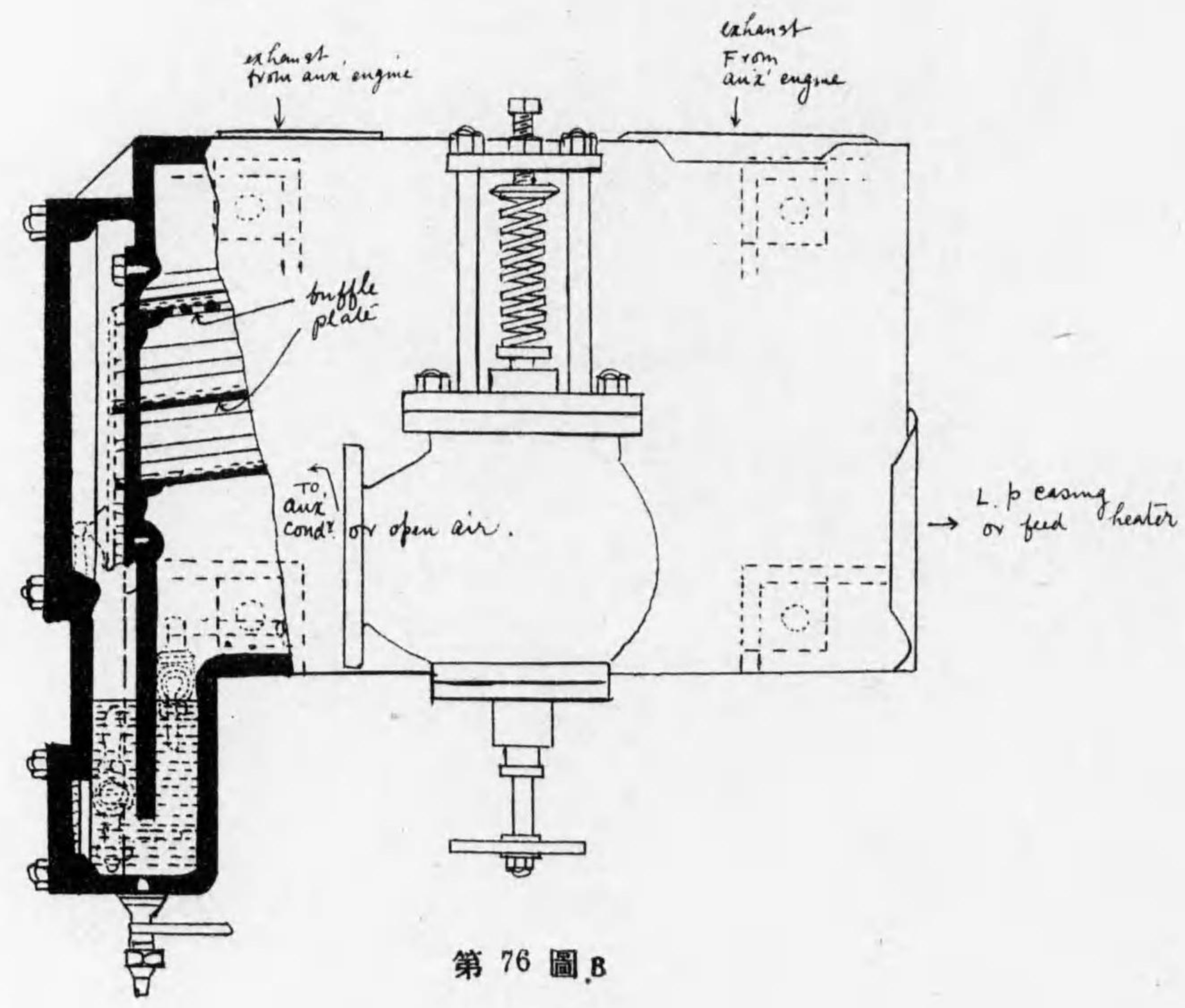

第 76 圖 B

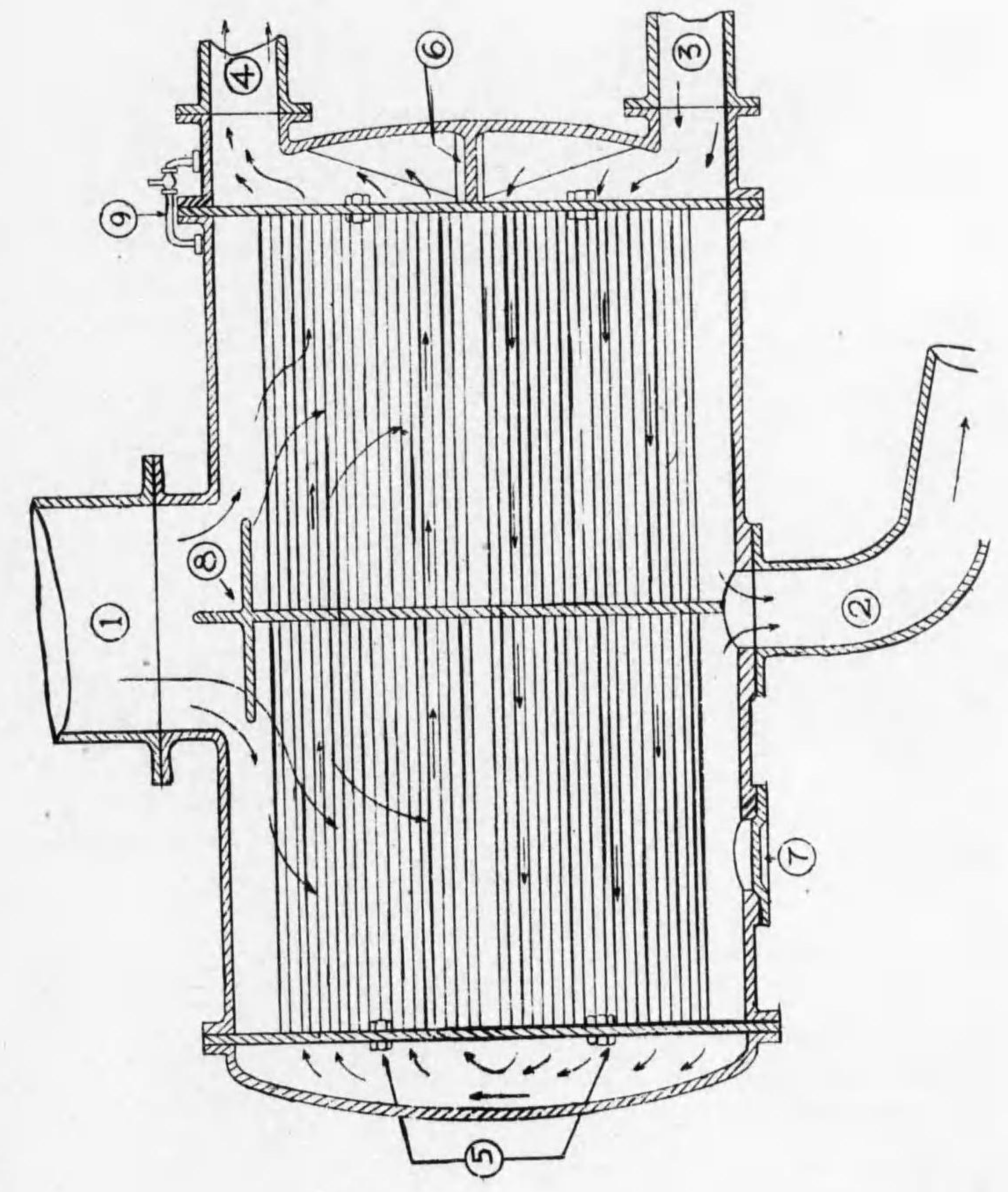

第 77 圖

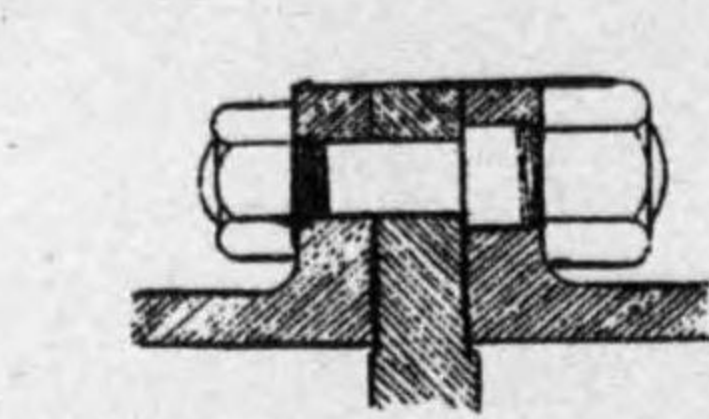

ENLARGED VIEW OF TUBE PLATE JOINT

第 78 圖

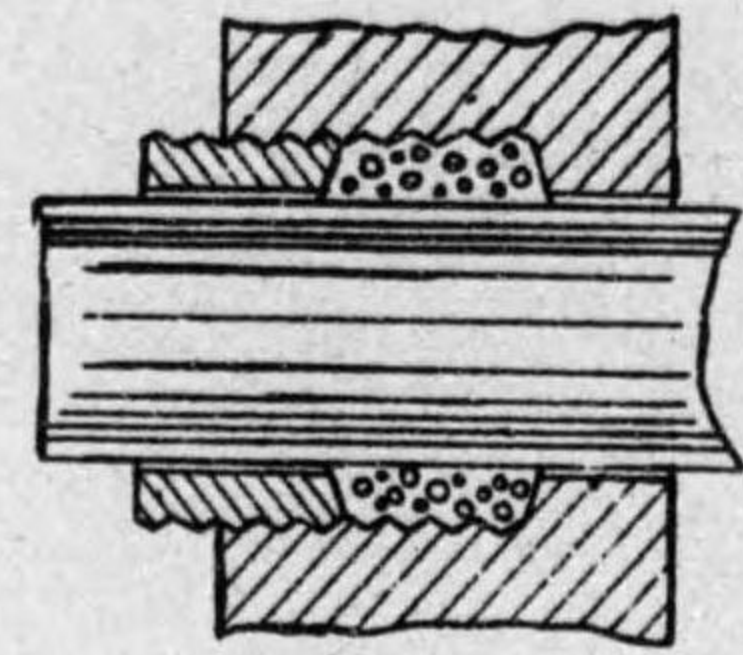

第 79 圖 B

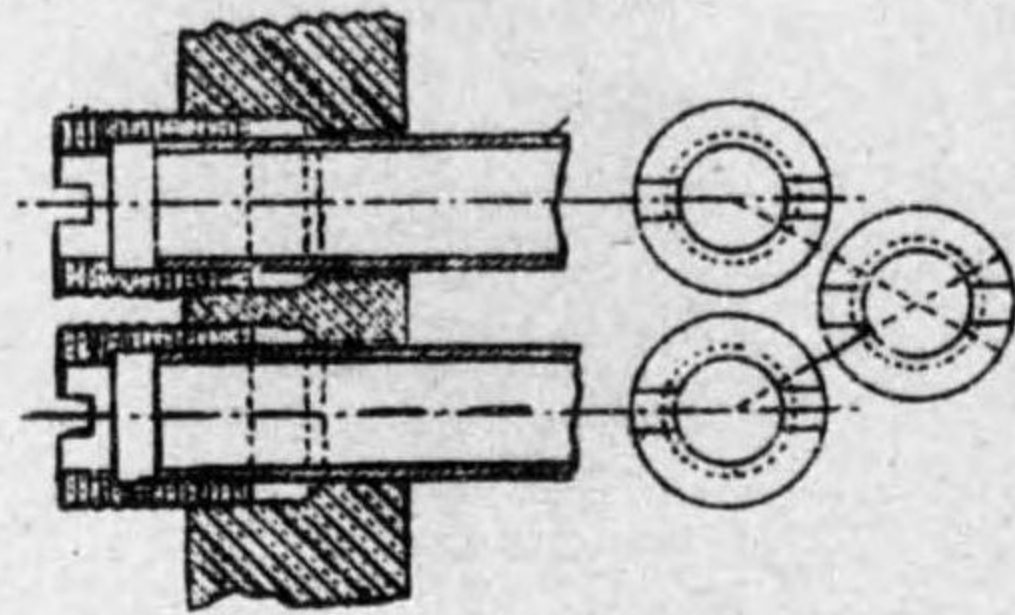

第 79 圖 A

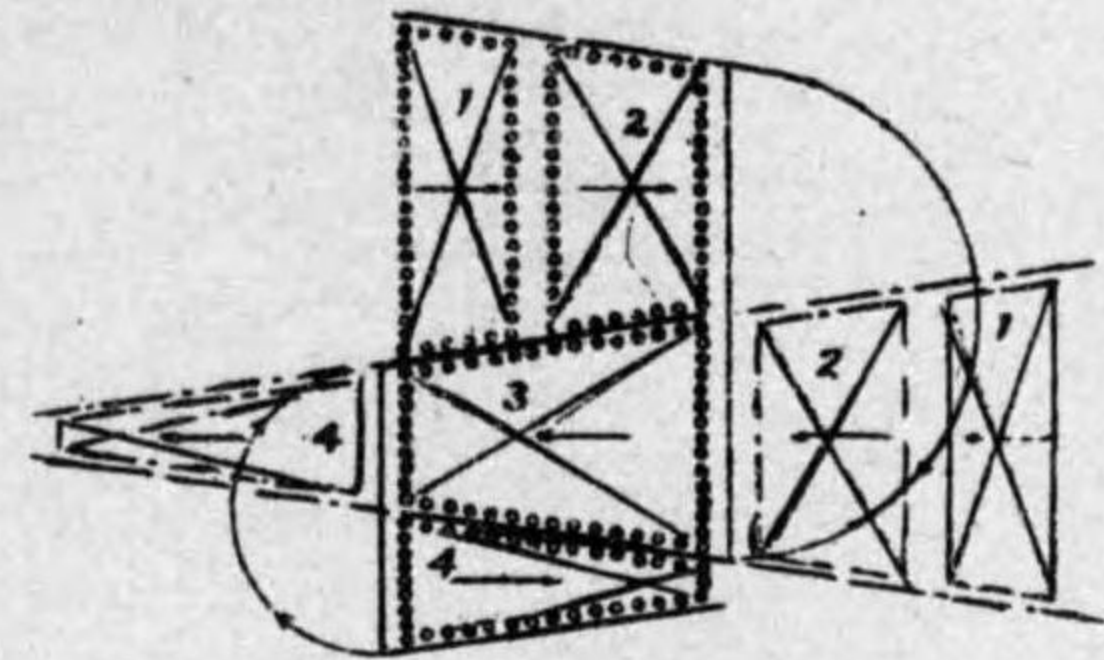

第 80 圖

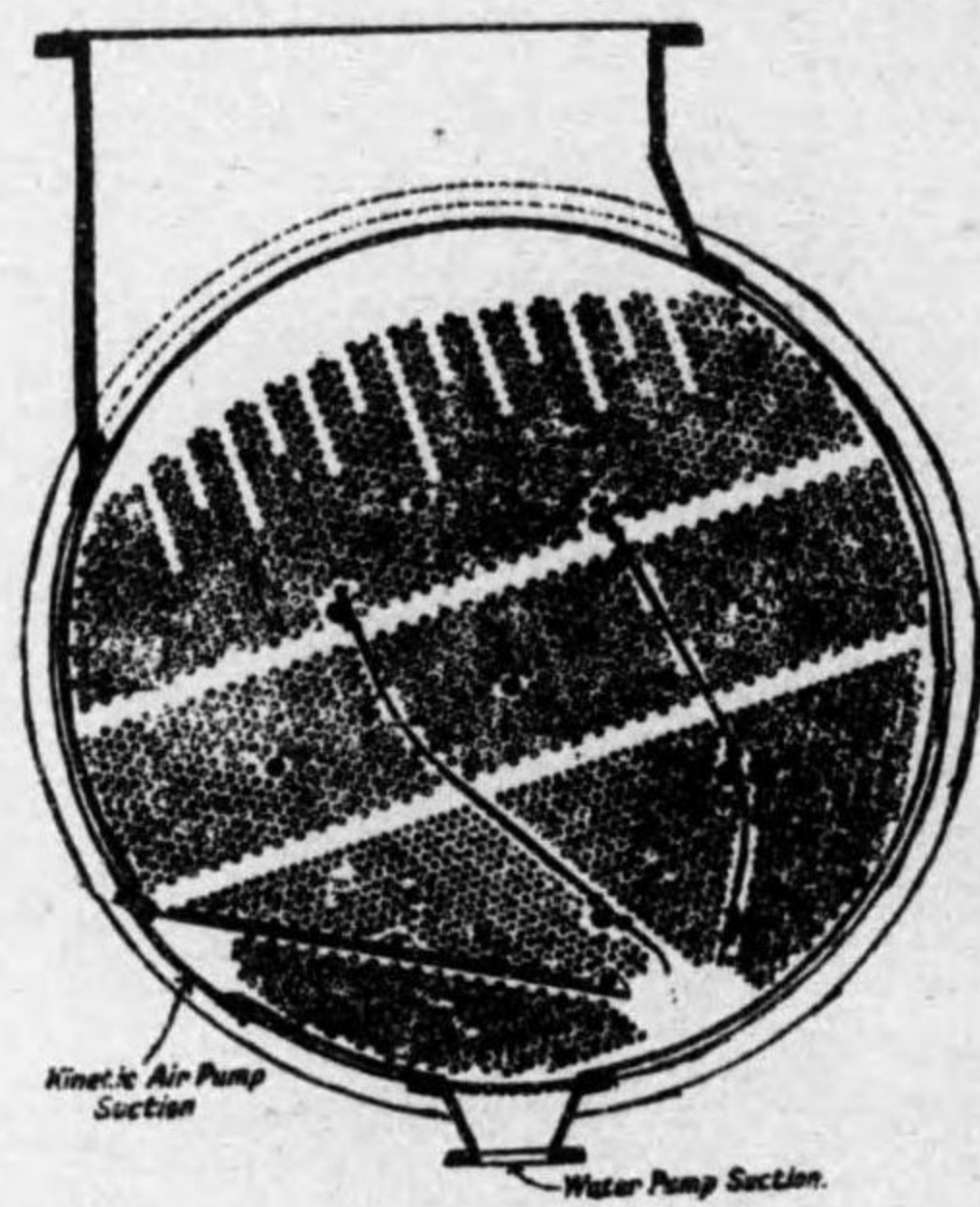

第 81 圖

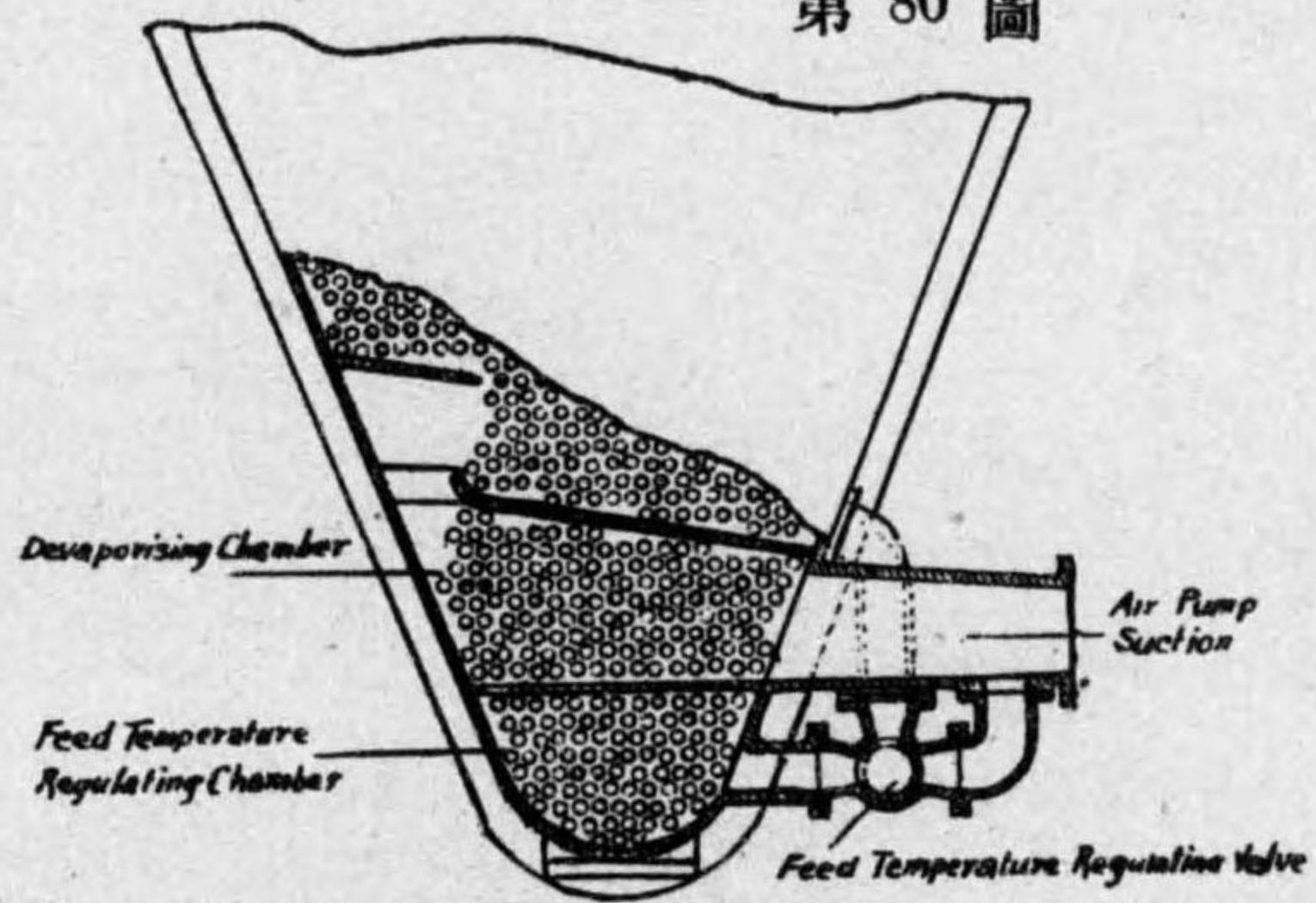

第 82 圖

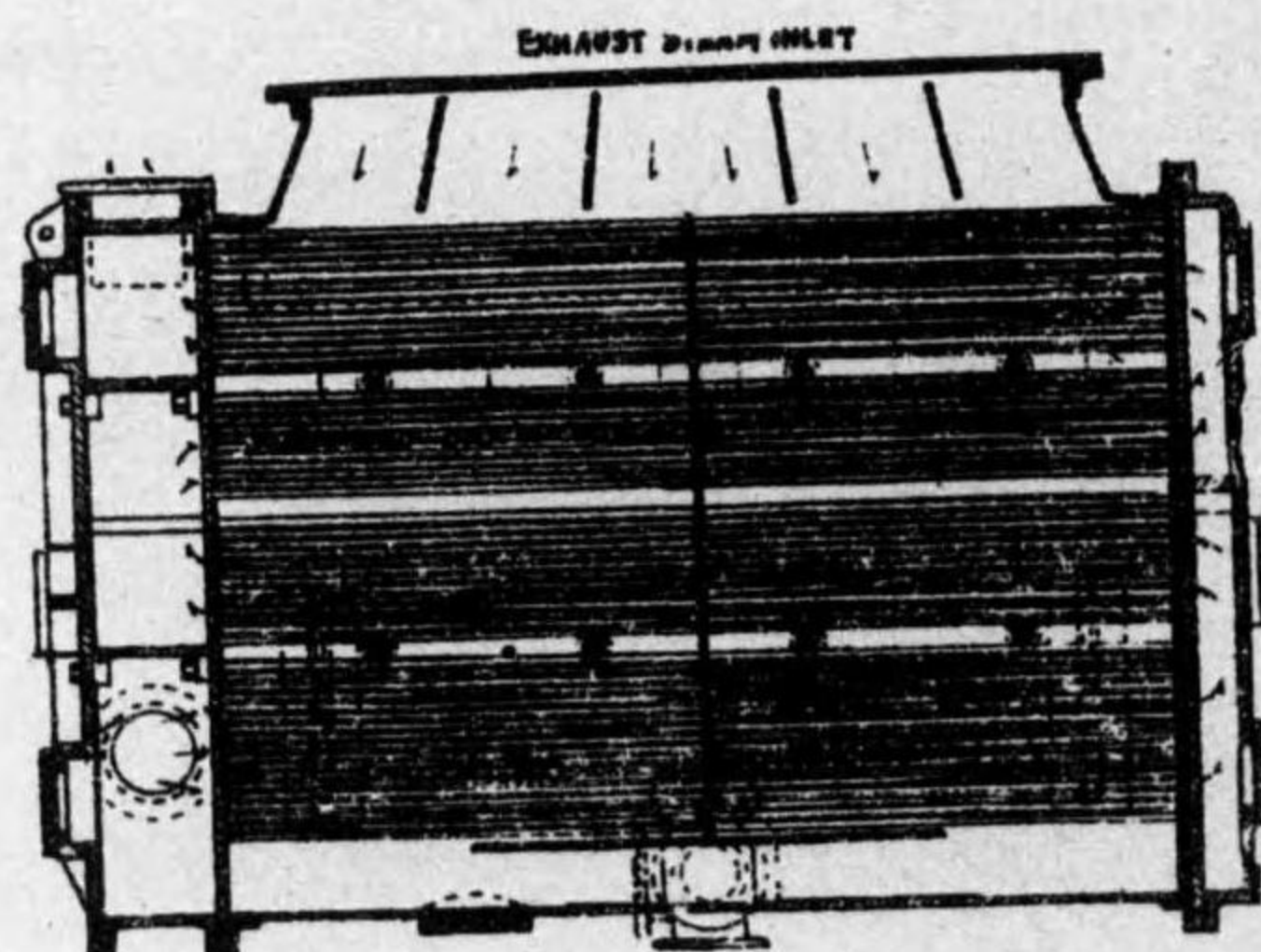

第 83 圖

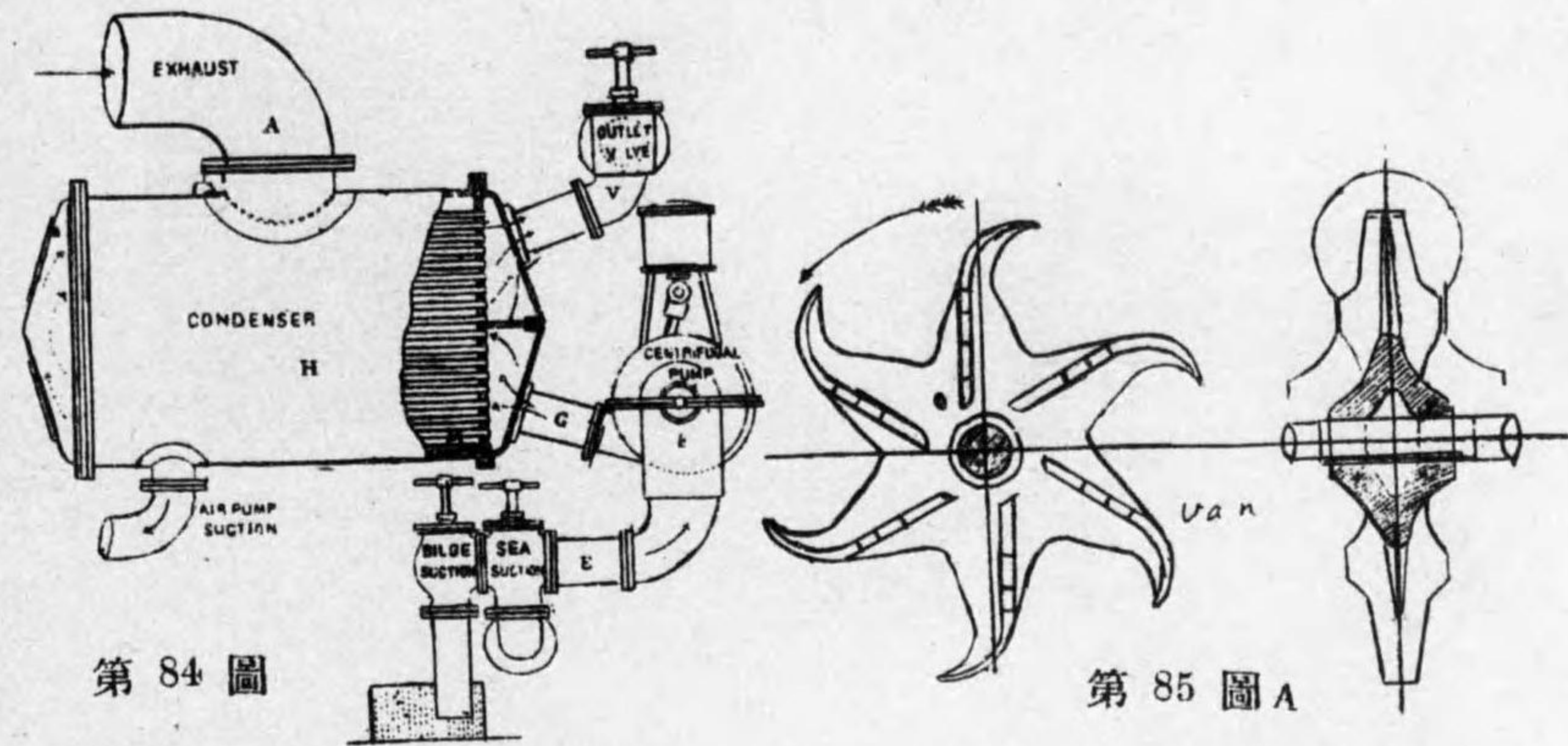
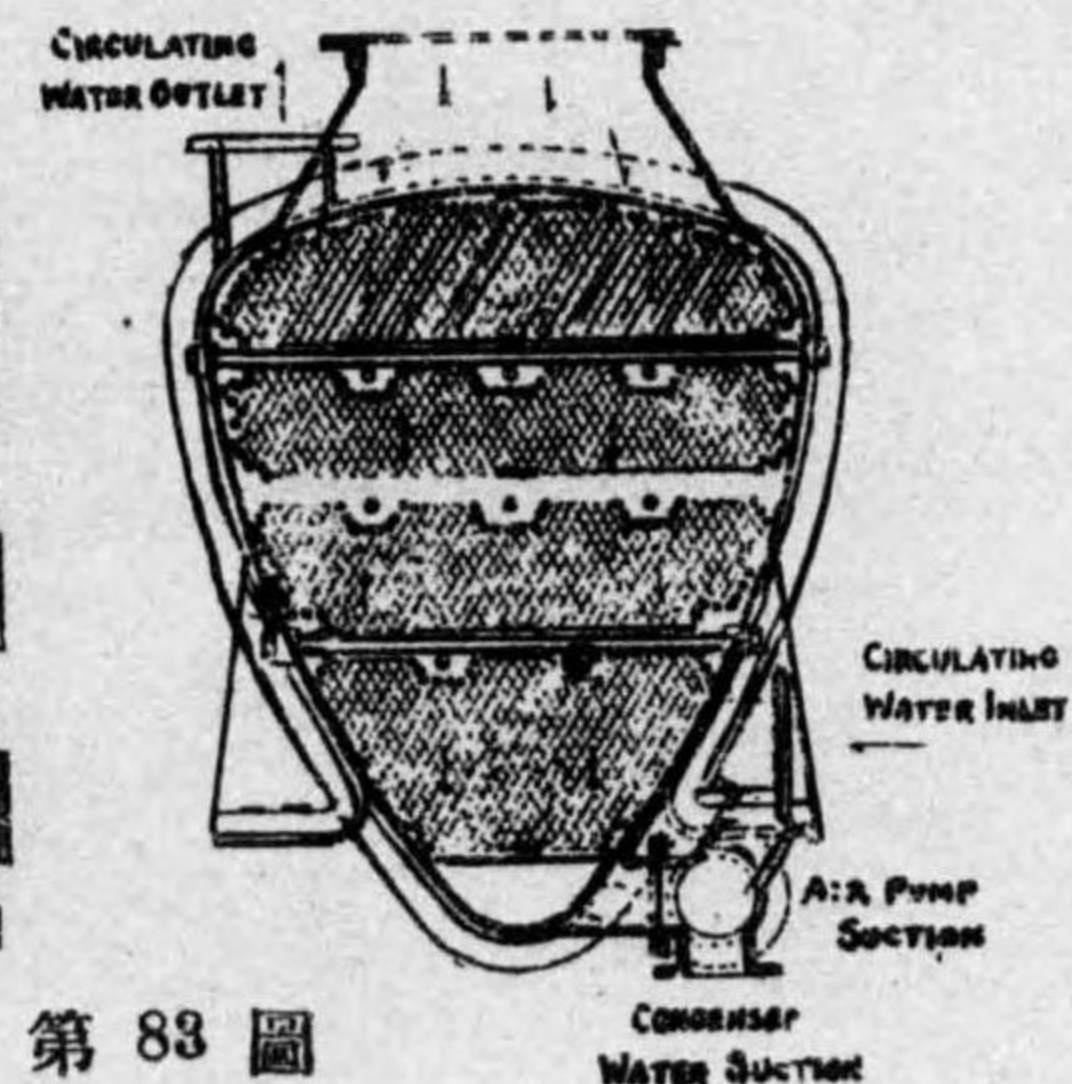

第 84 圖

第 85 圖 A

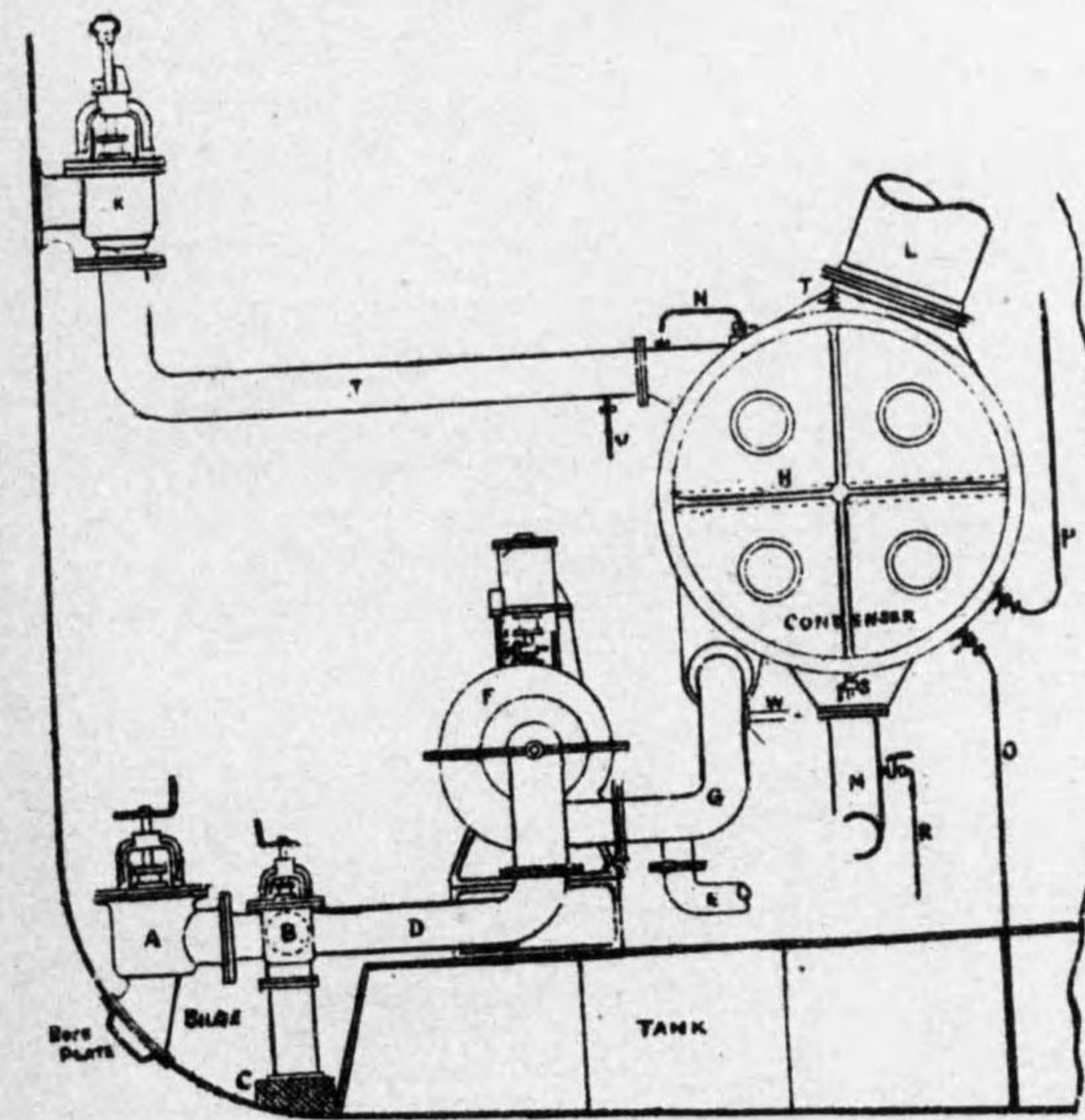

第 86 圖

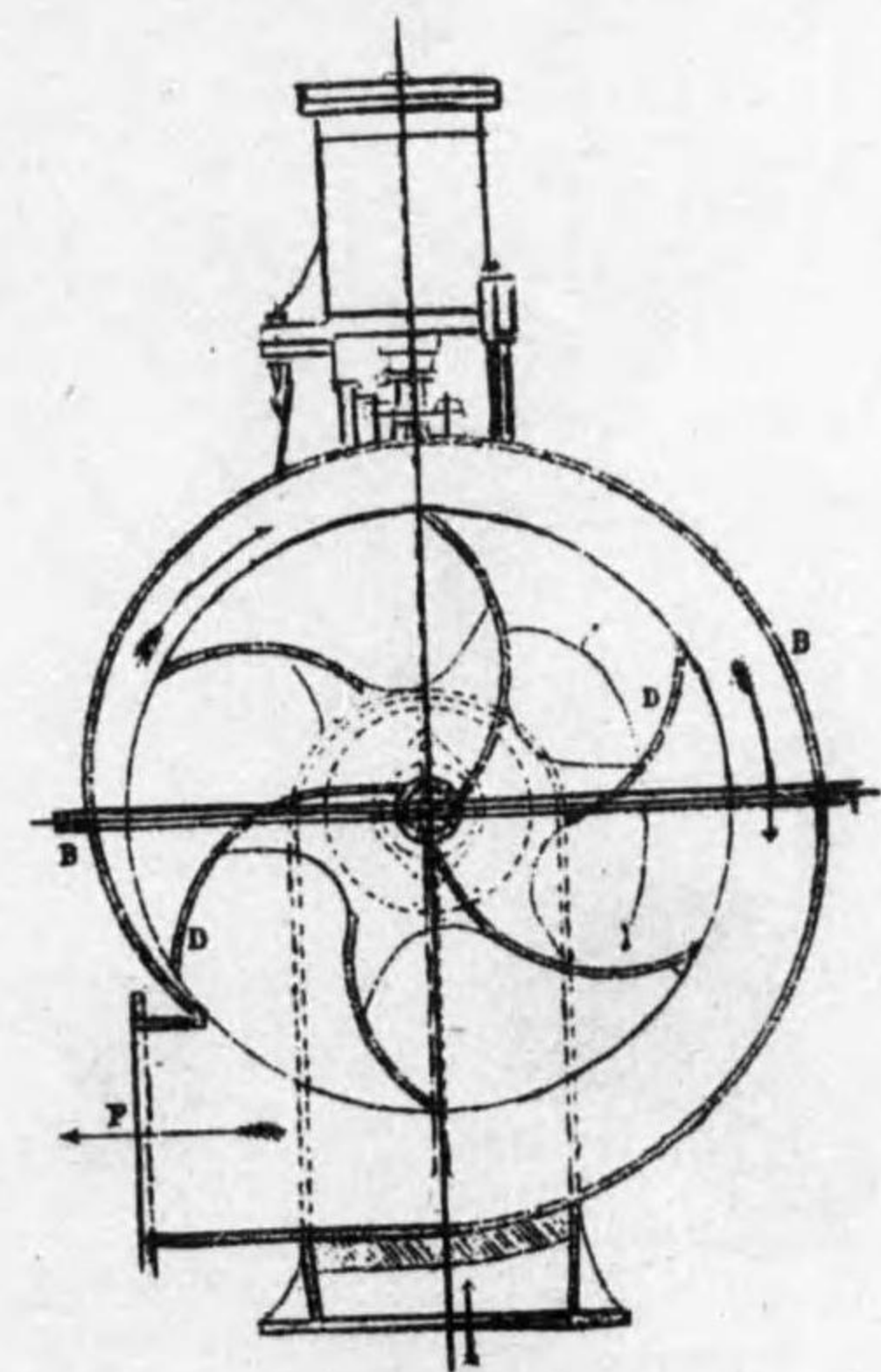

第 85 圖 B

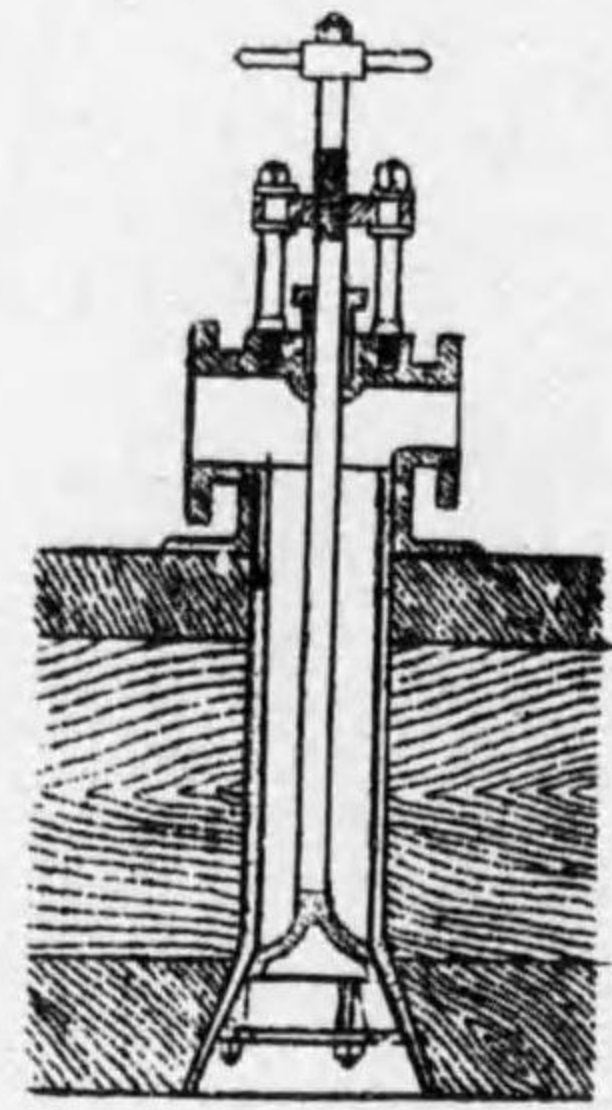

第 87 圖

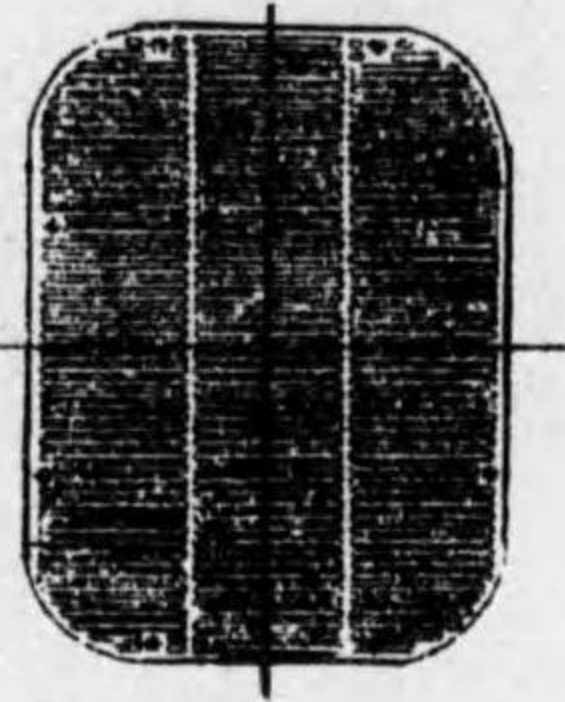
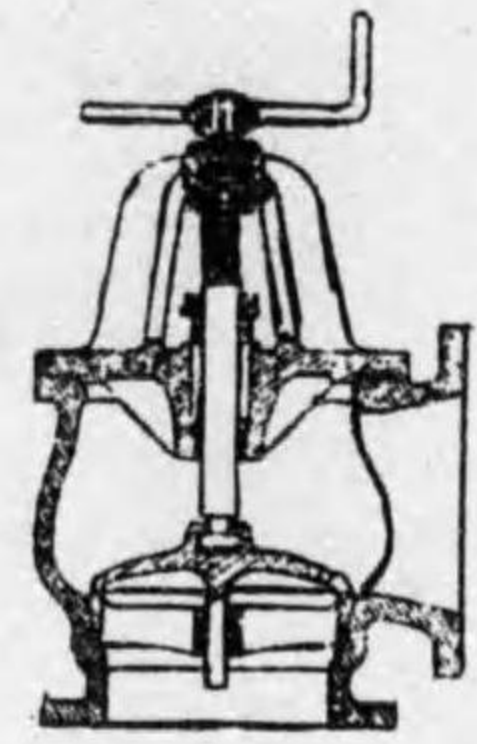

第 88 圖

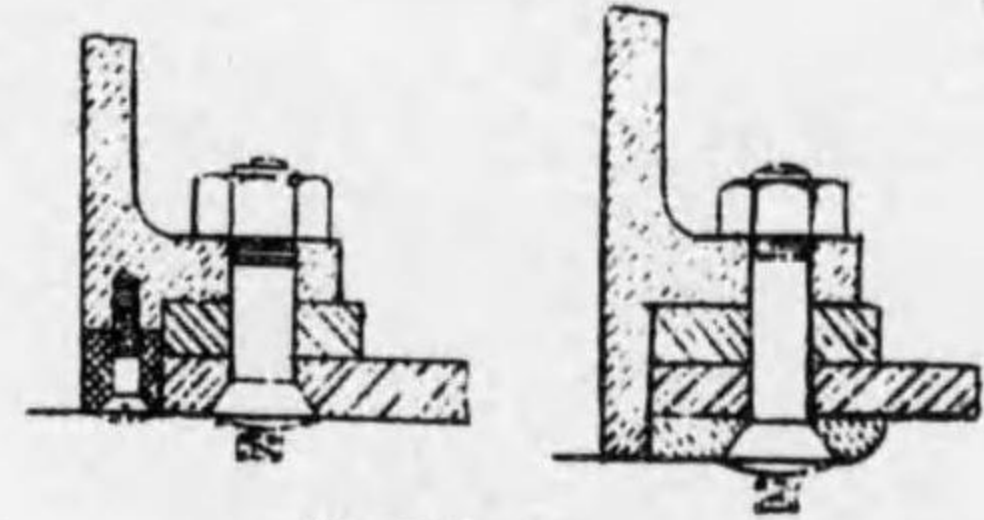

第 89 圖

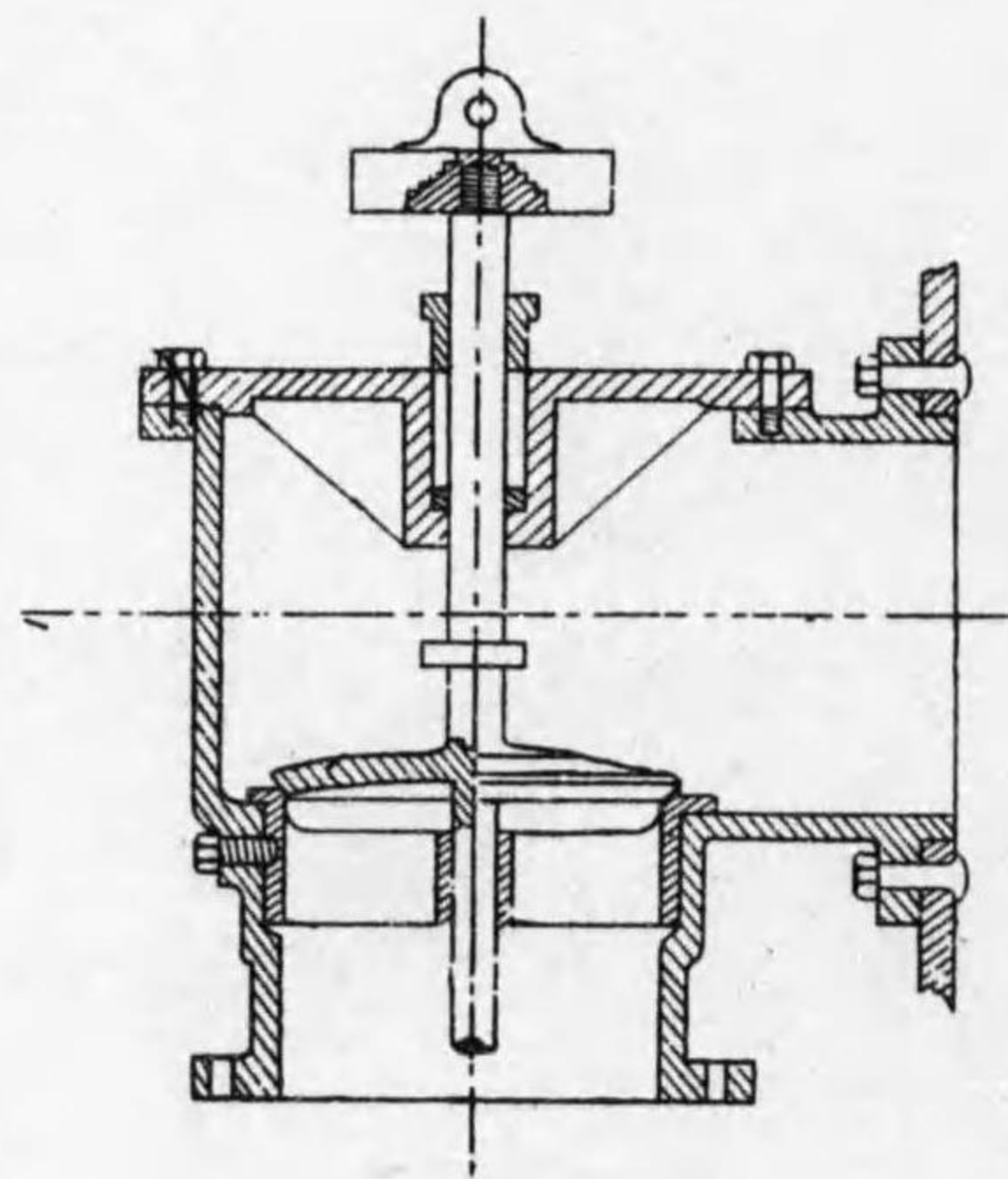

第 90 圖 A

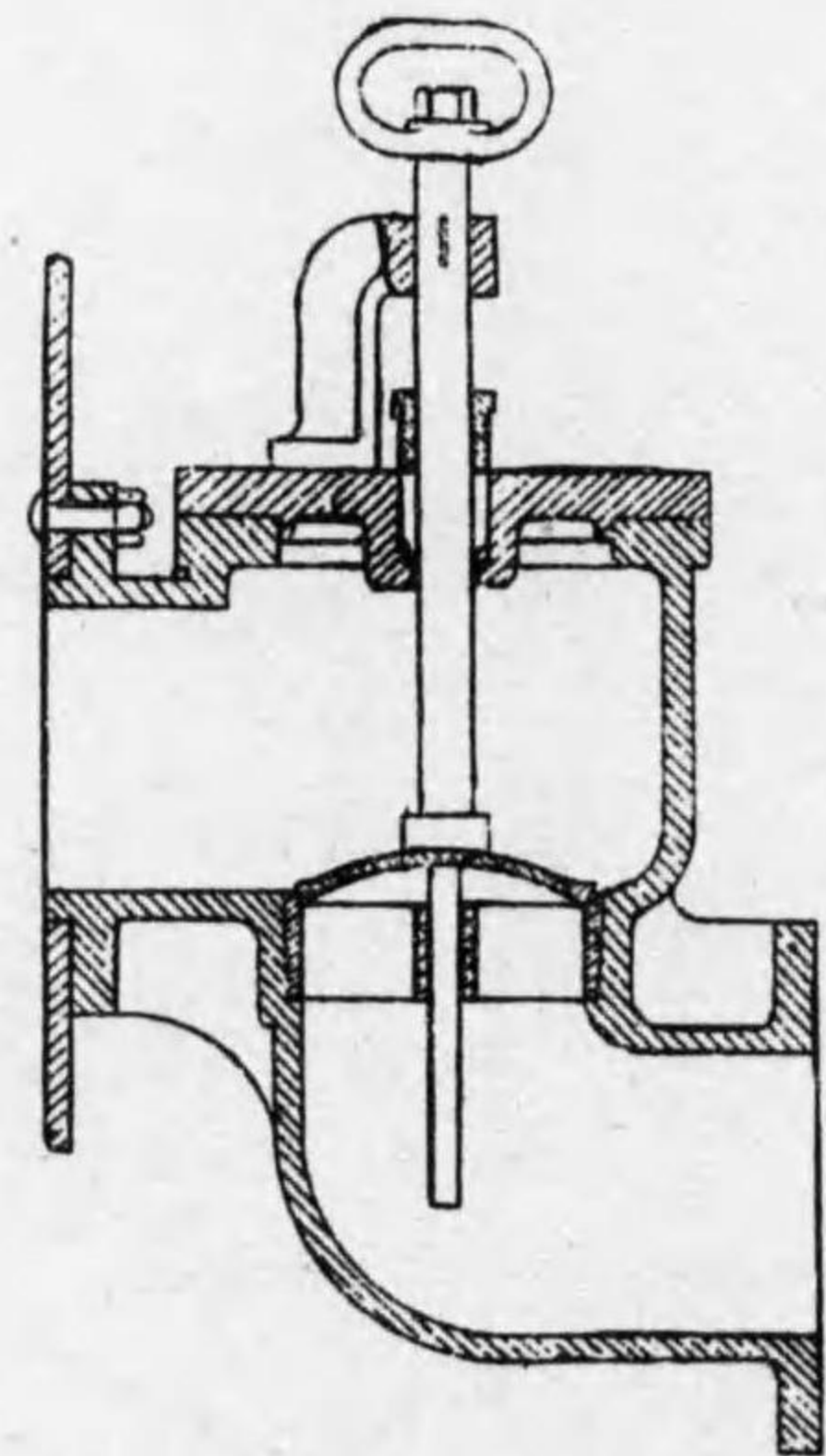

第 90 圖 B

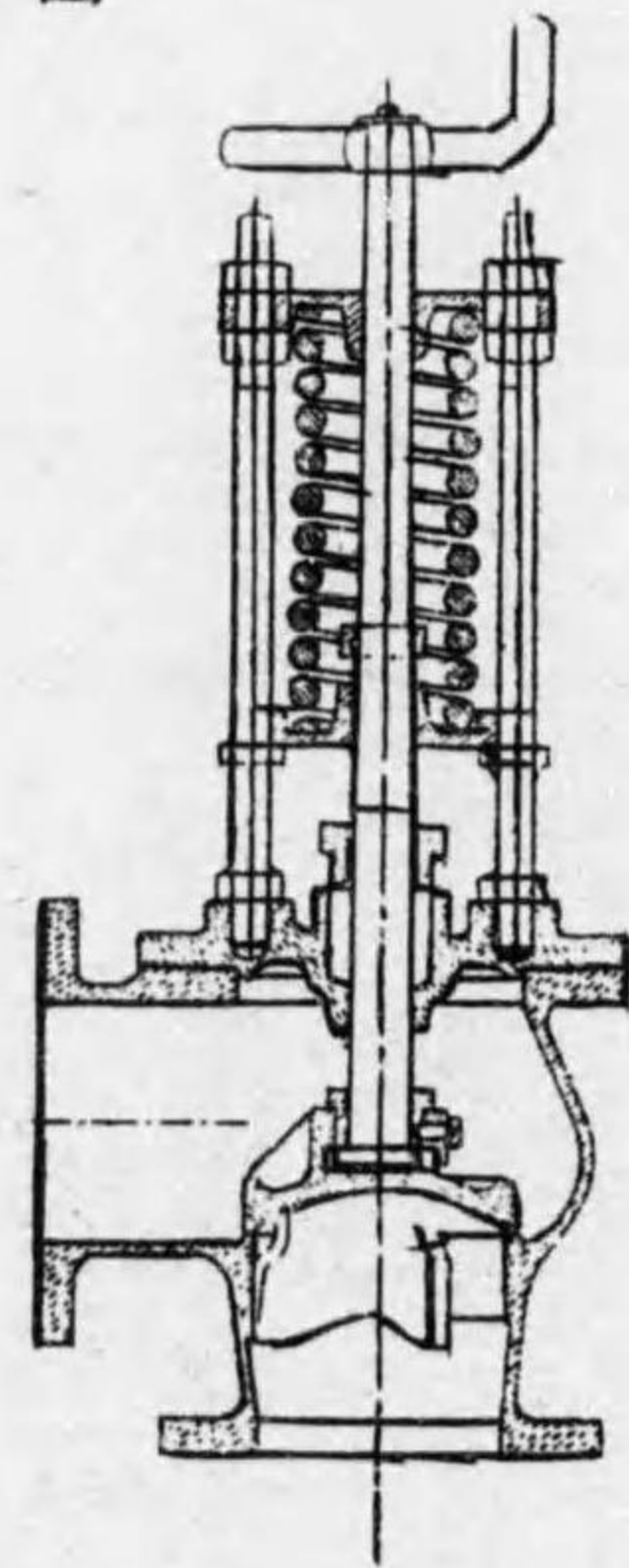

第 90 圖 C

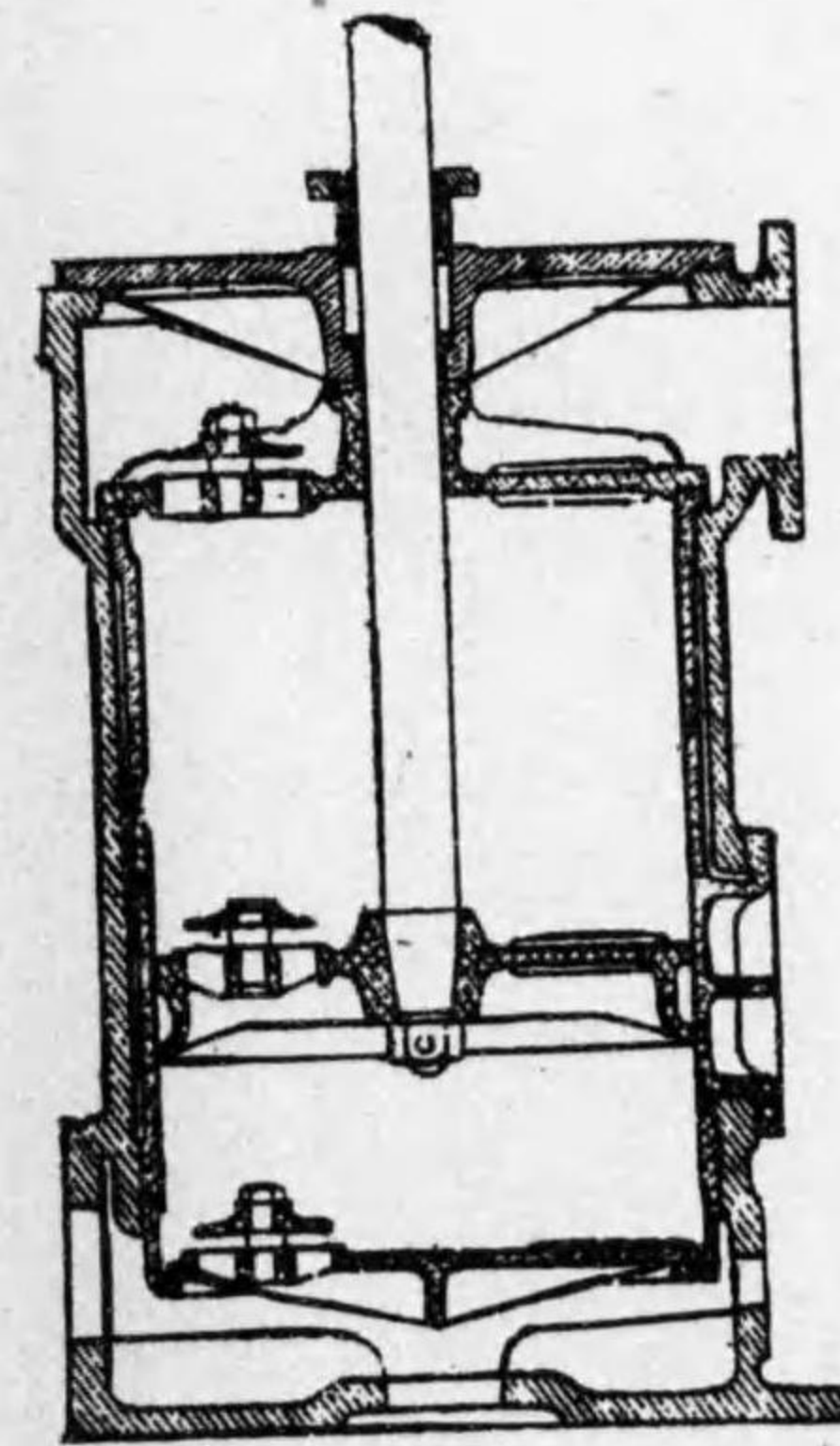

第 91 圖 A

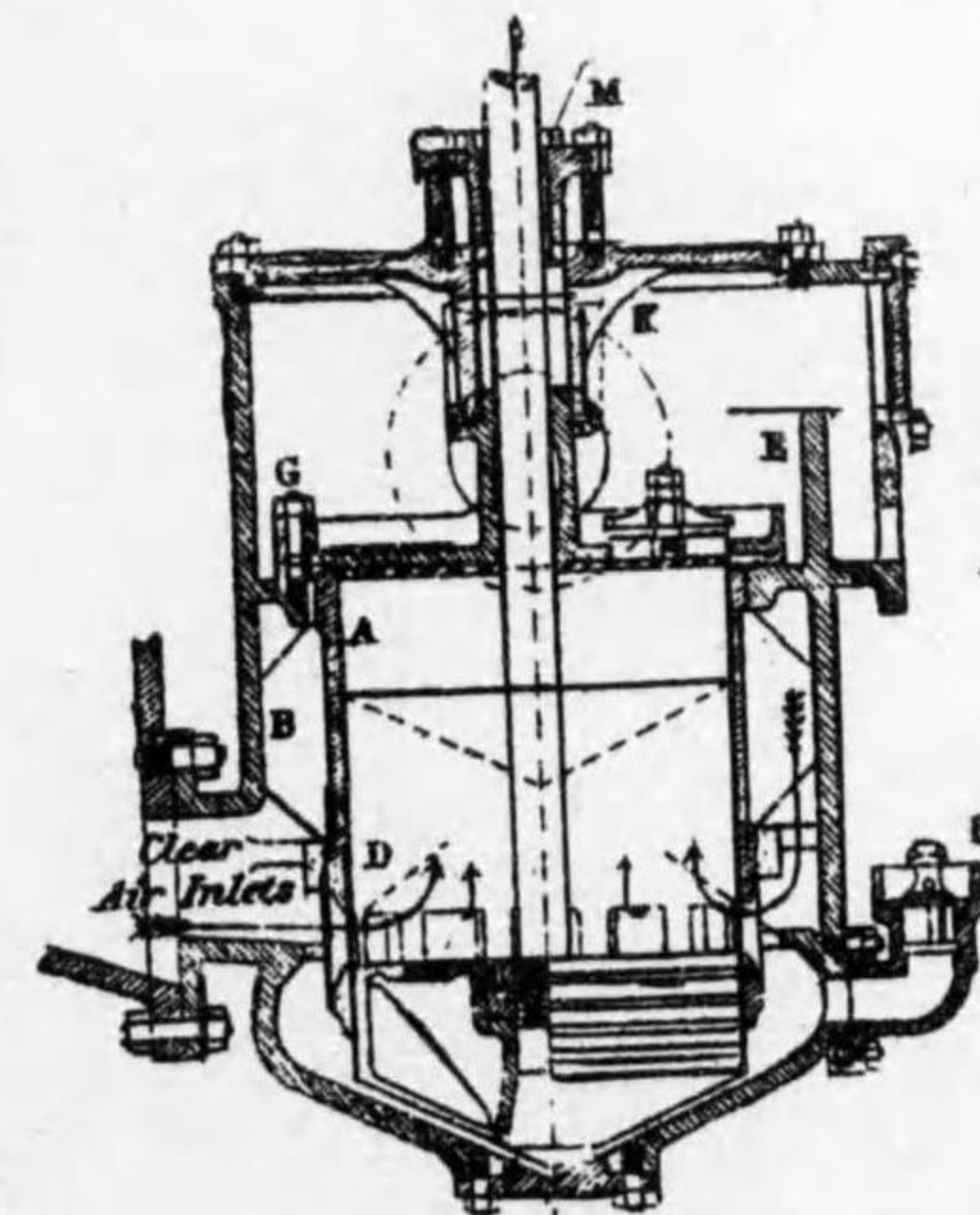

第 92 圖 A

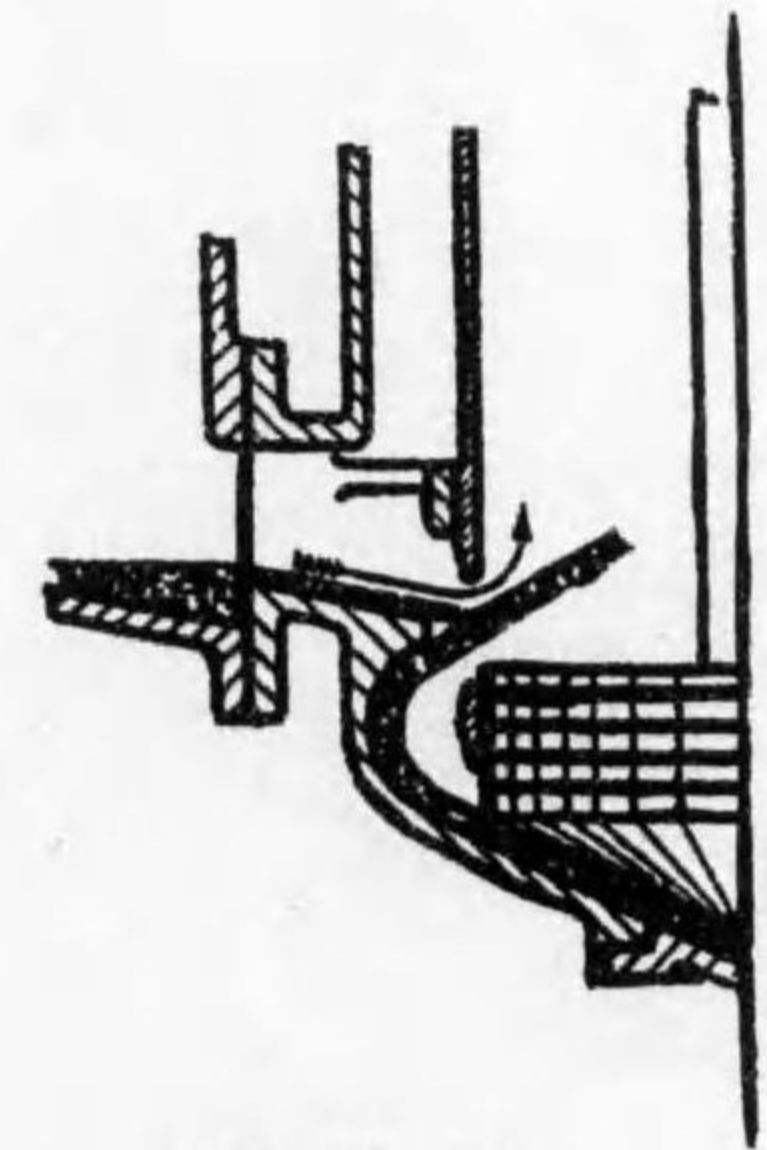

第 92 圖 B

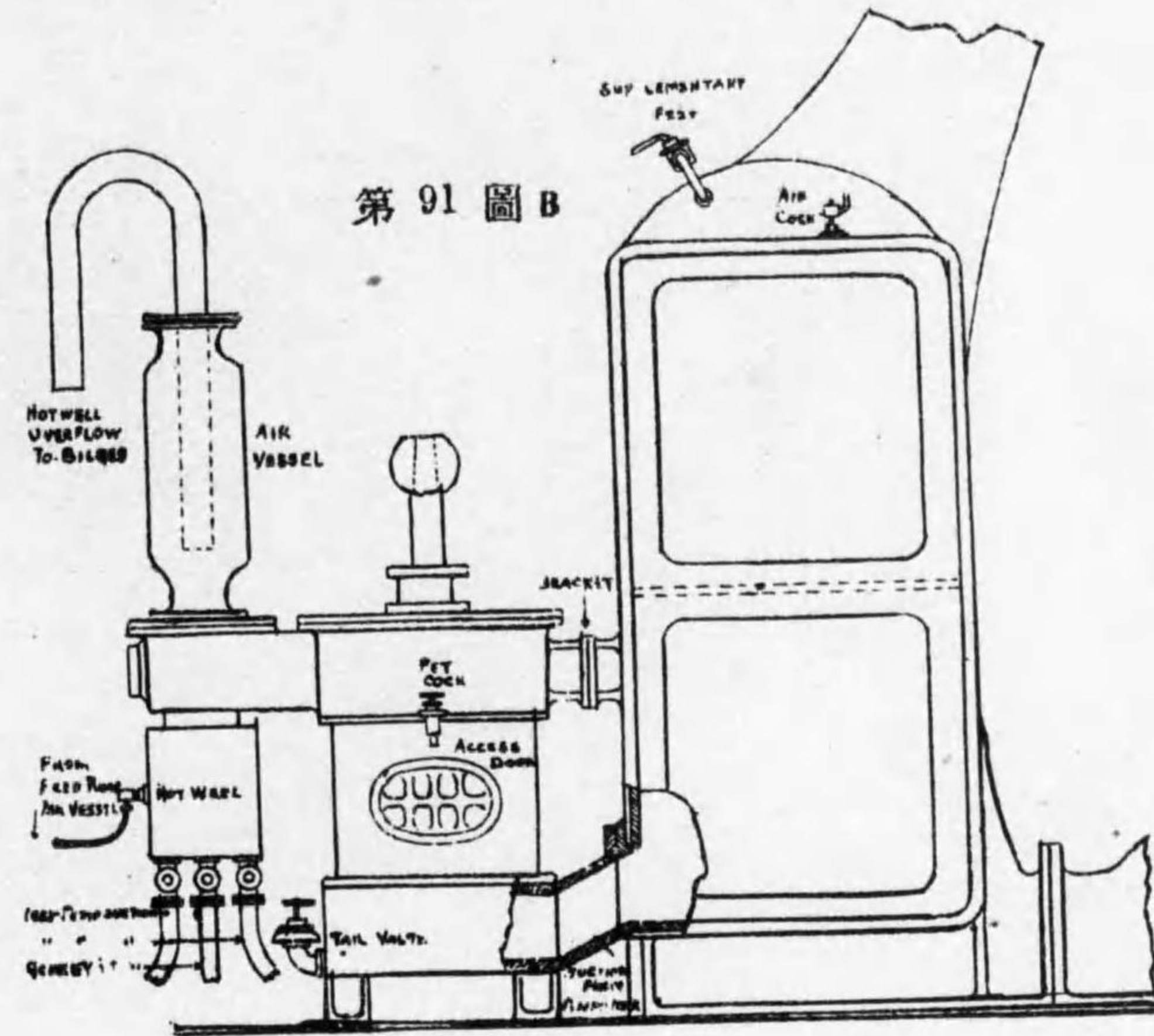

第 91 圖 B

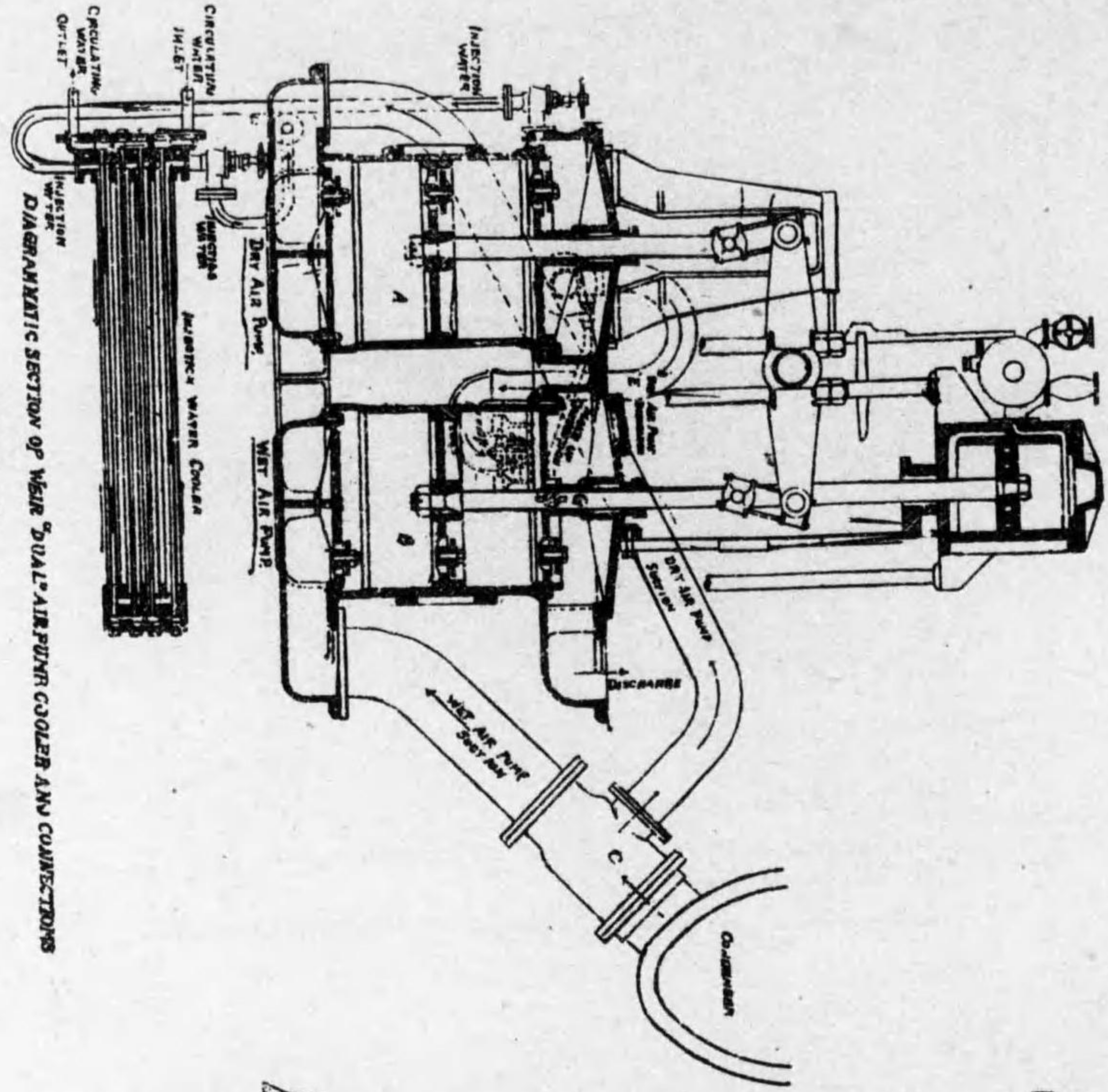

第 93 圖

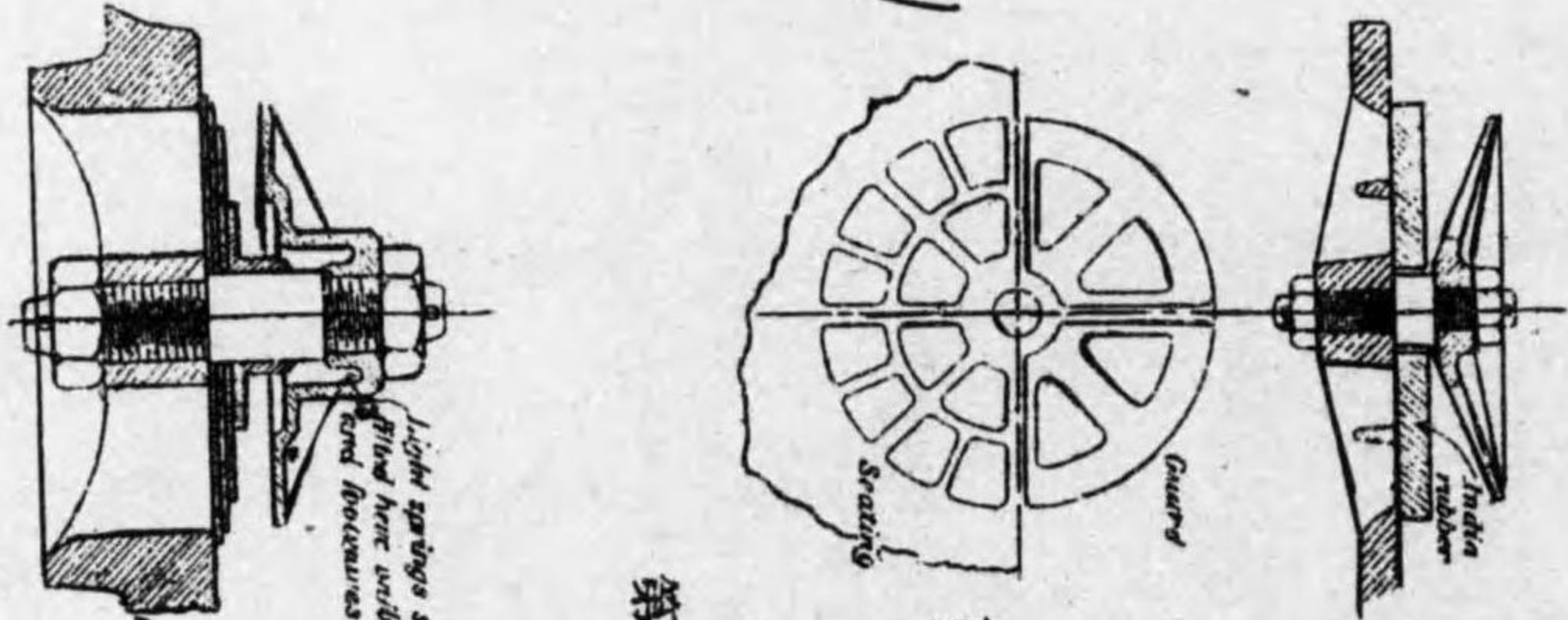

第 94 圖 A

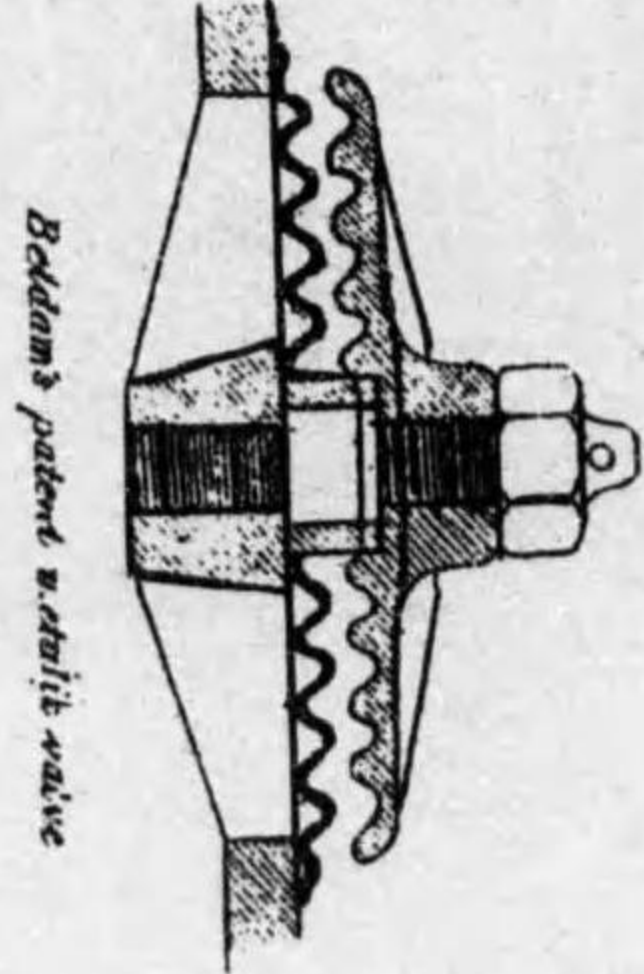

第 94 圖 B

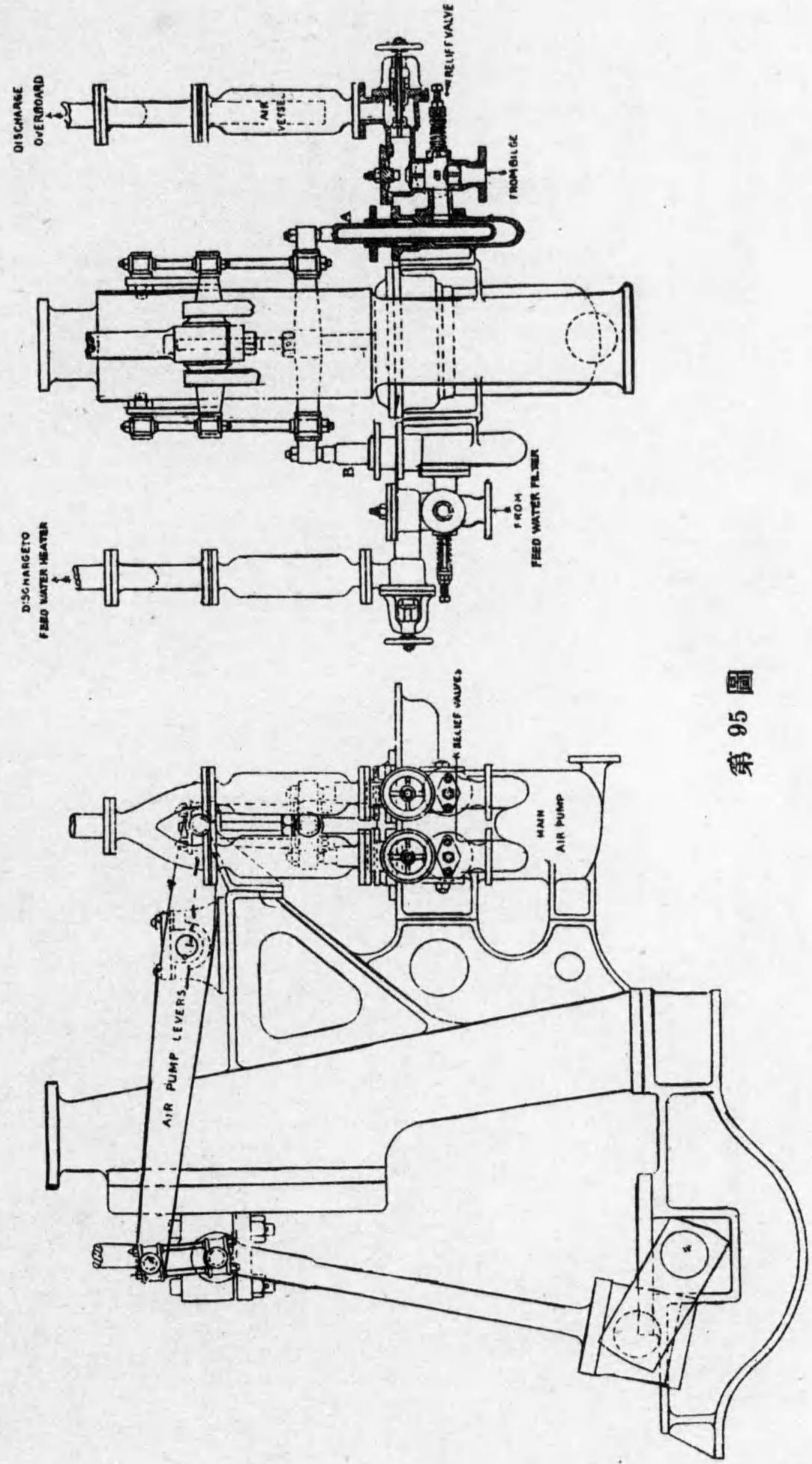
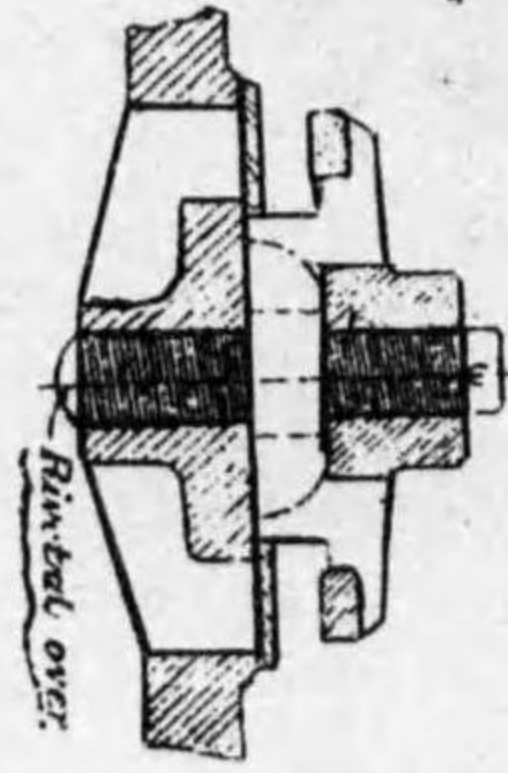

第 95 圖

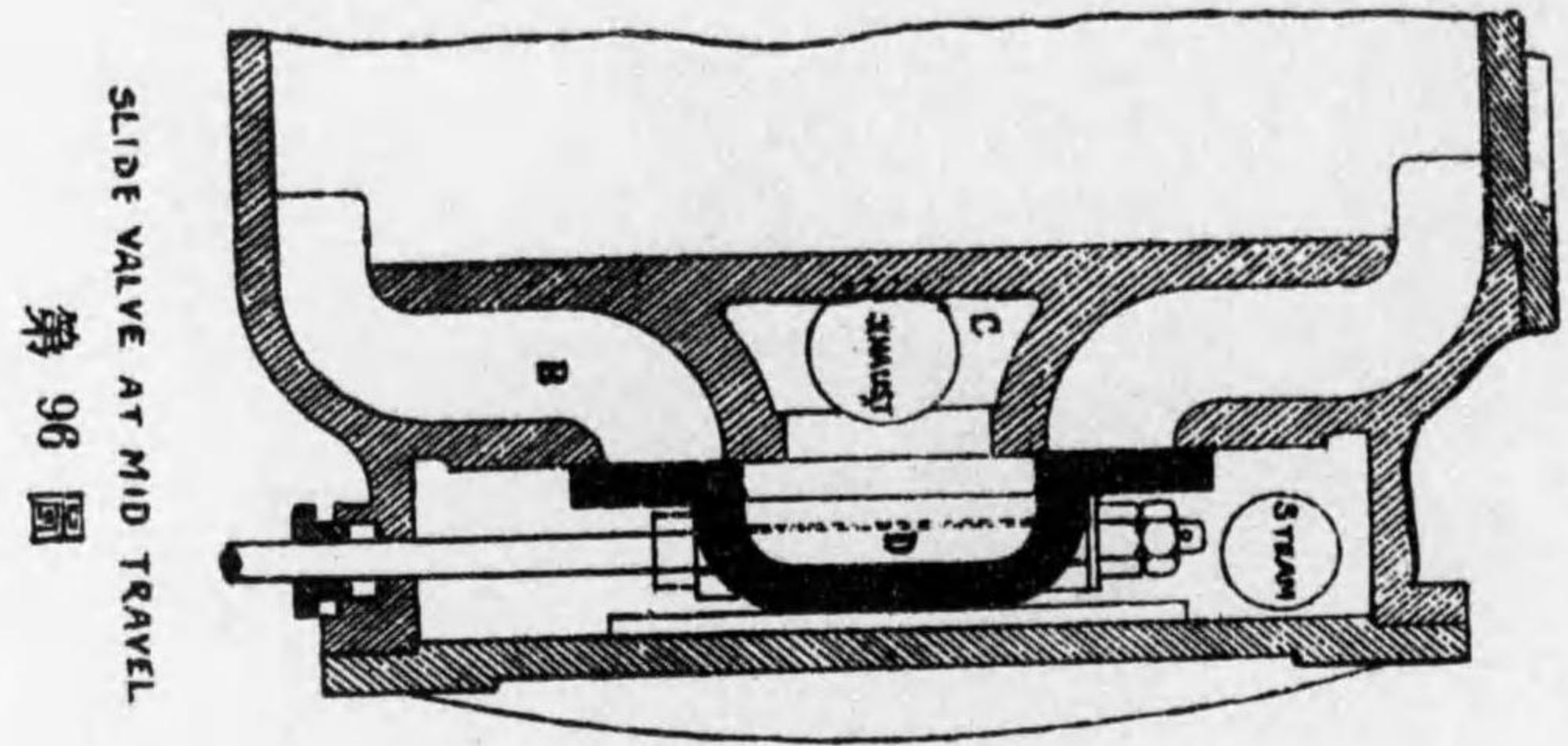

SLIDE VALVE AT MID TRAVEL
第 96 圖

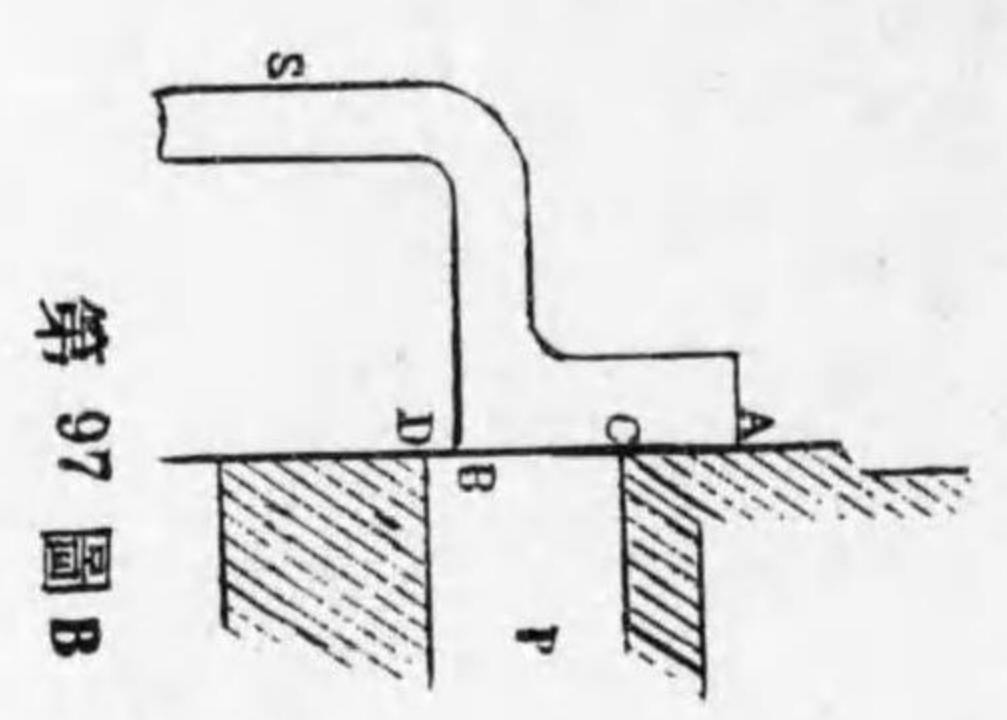

第 97 圖 B

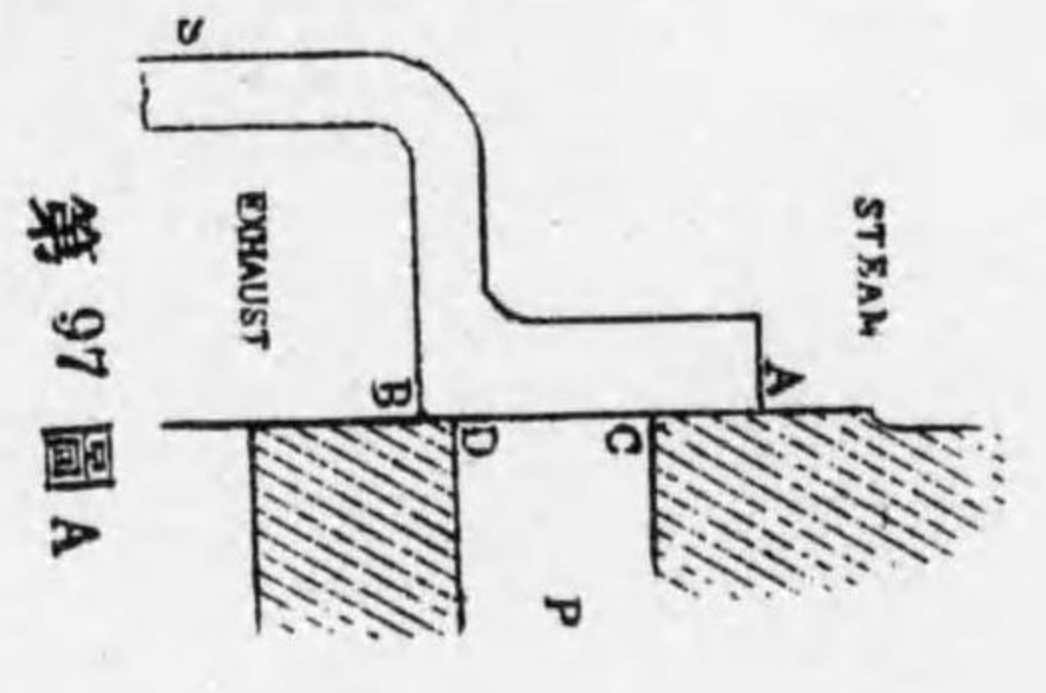

第 97 圖 A

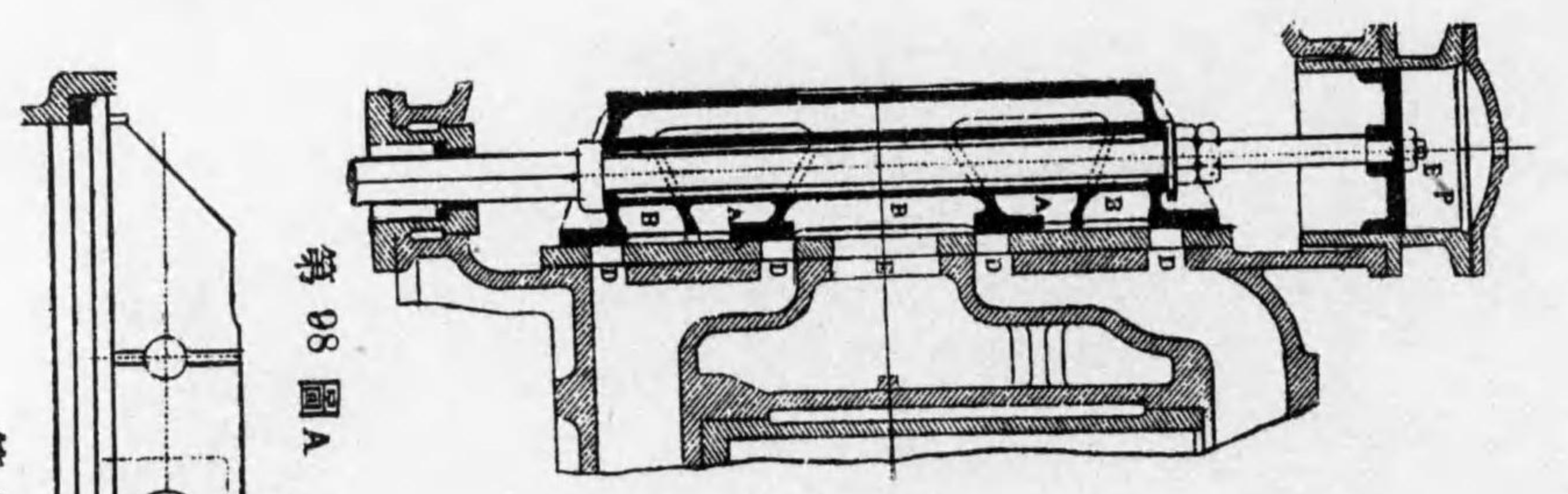

第 98 圖 A

第 98 圖 B

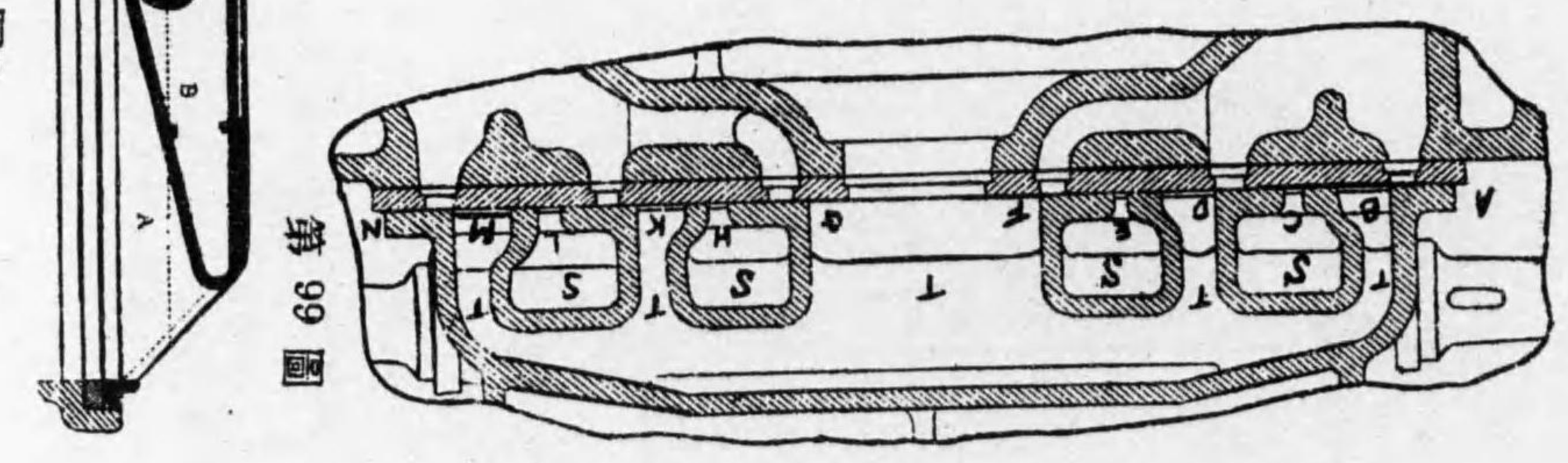

第 99 圖

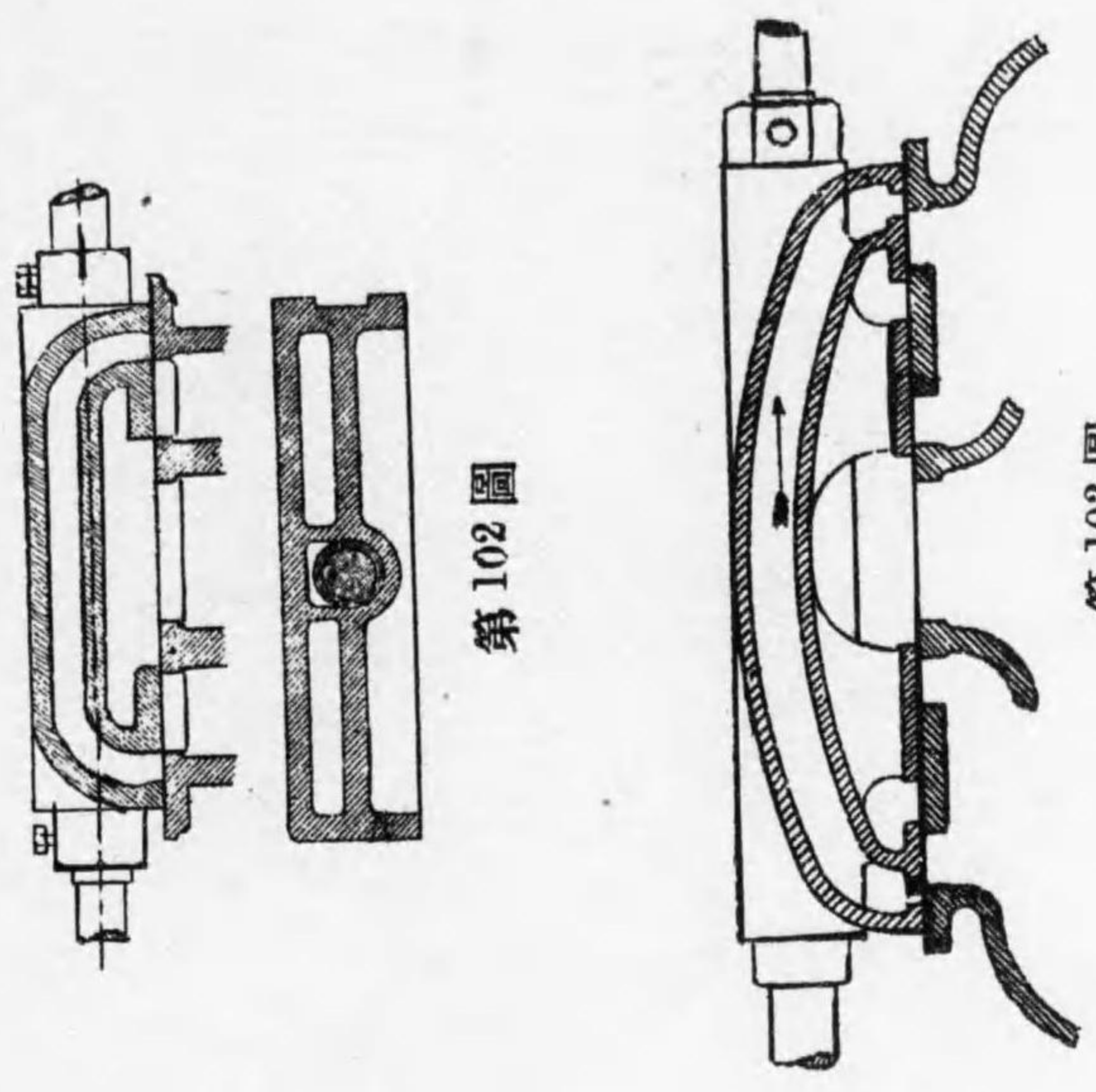

第 102 圖

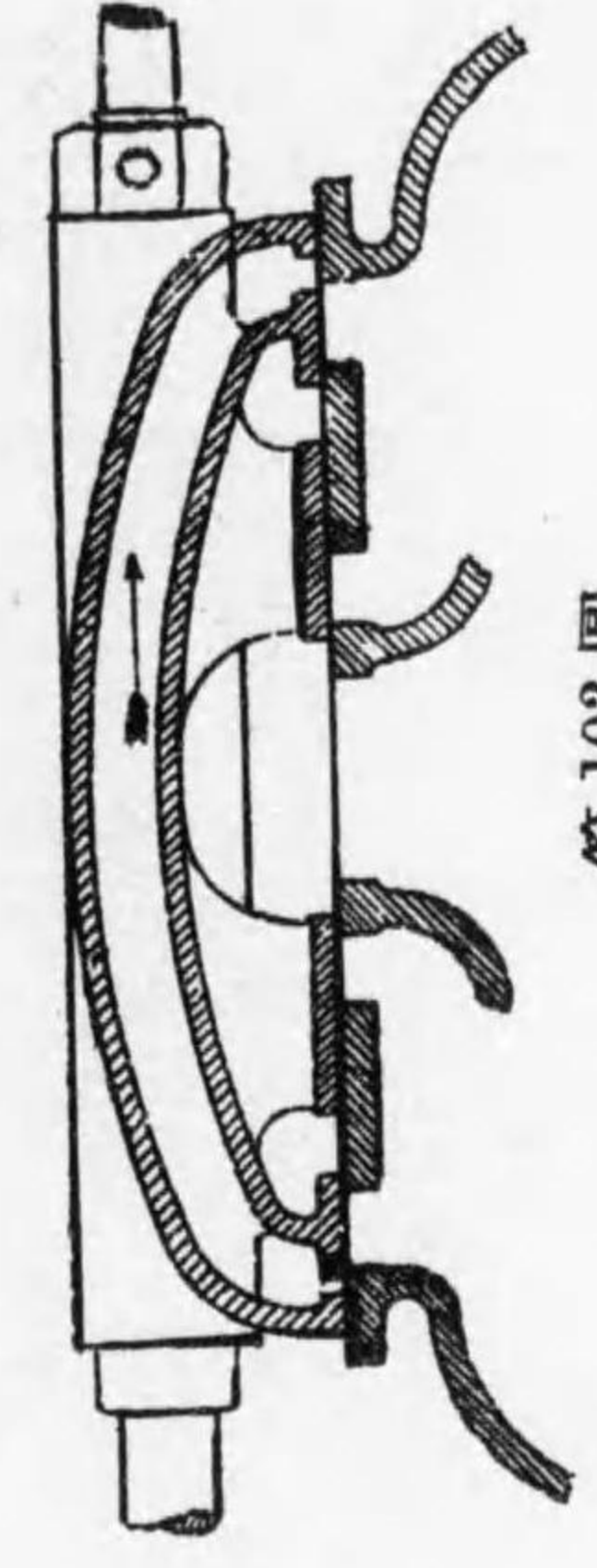

第 103 圖

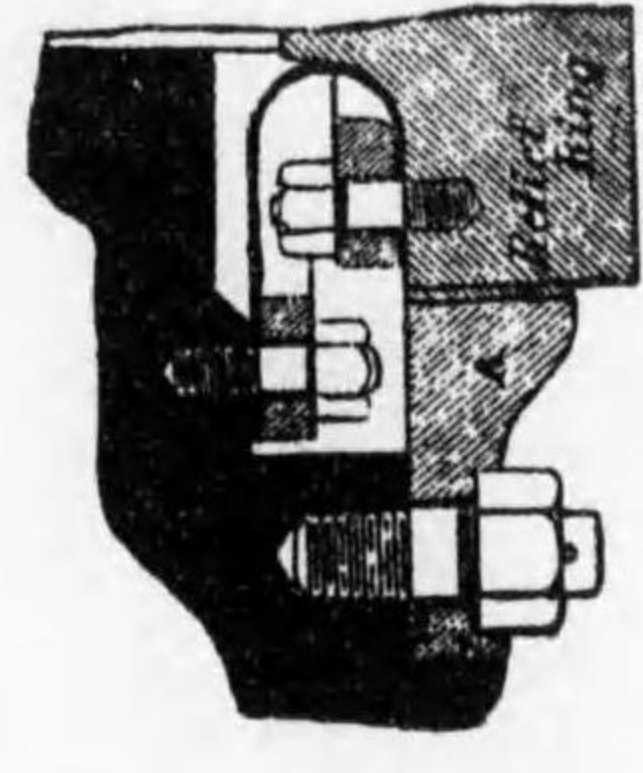

第 101 圖

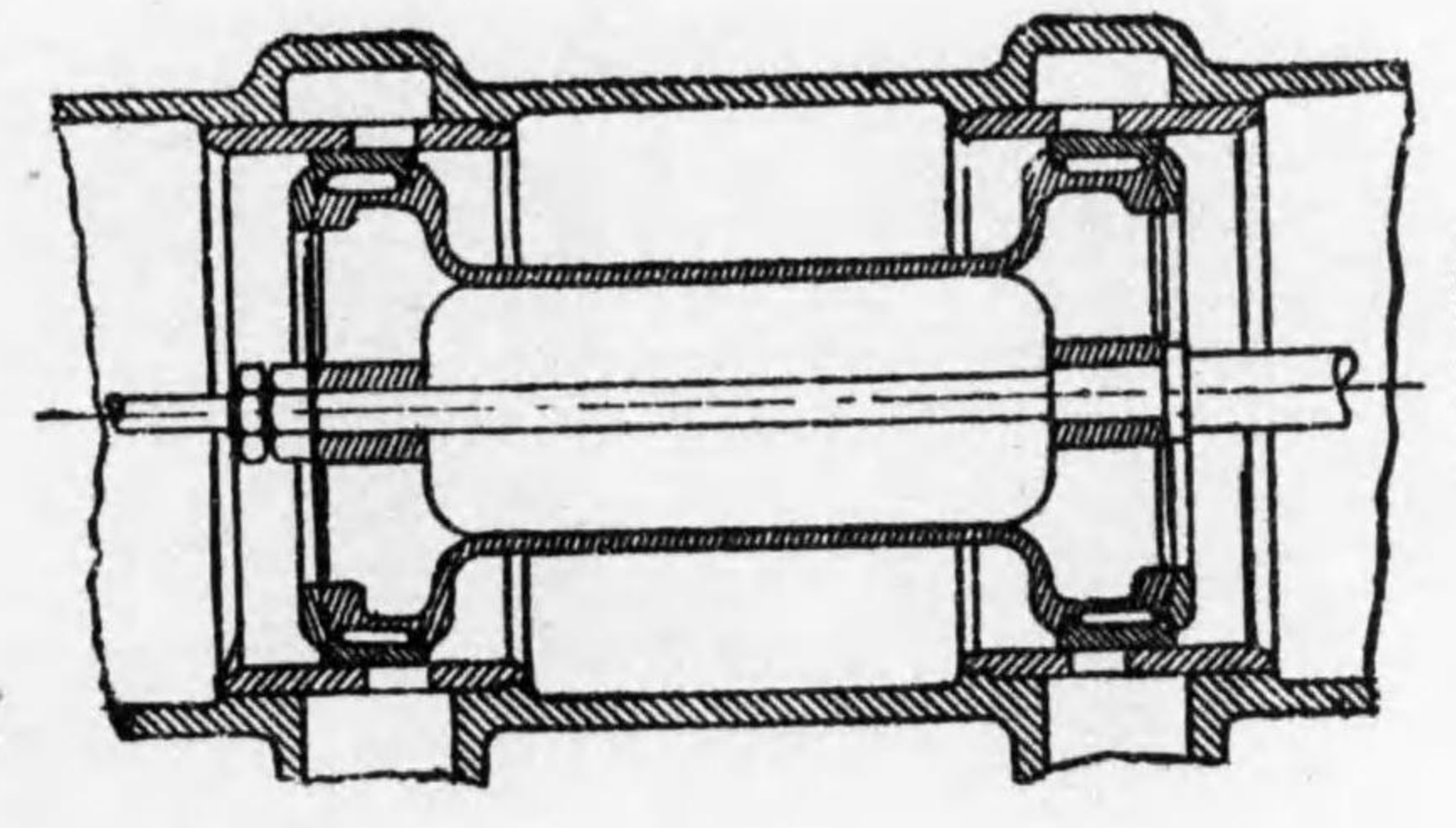

第 100 圖 B

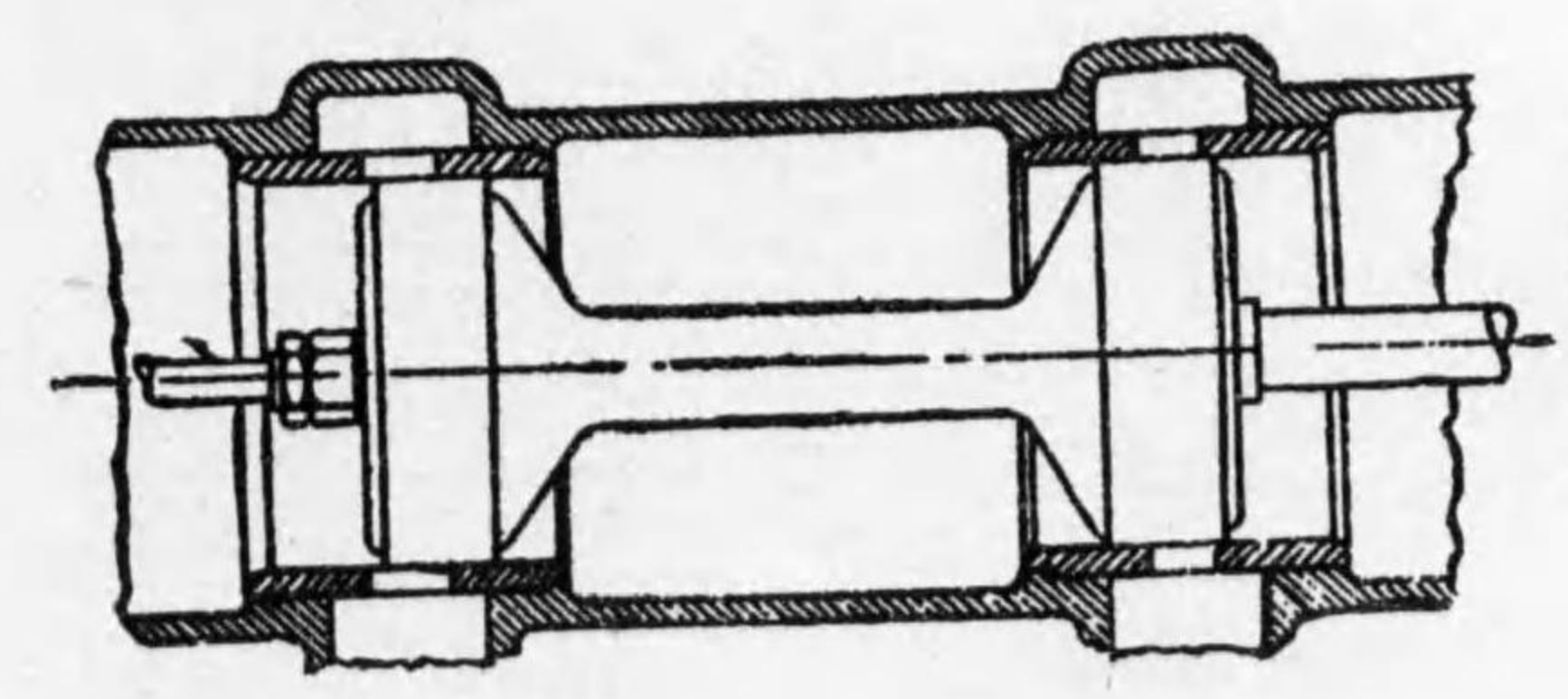

第 100 圖 A

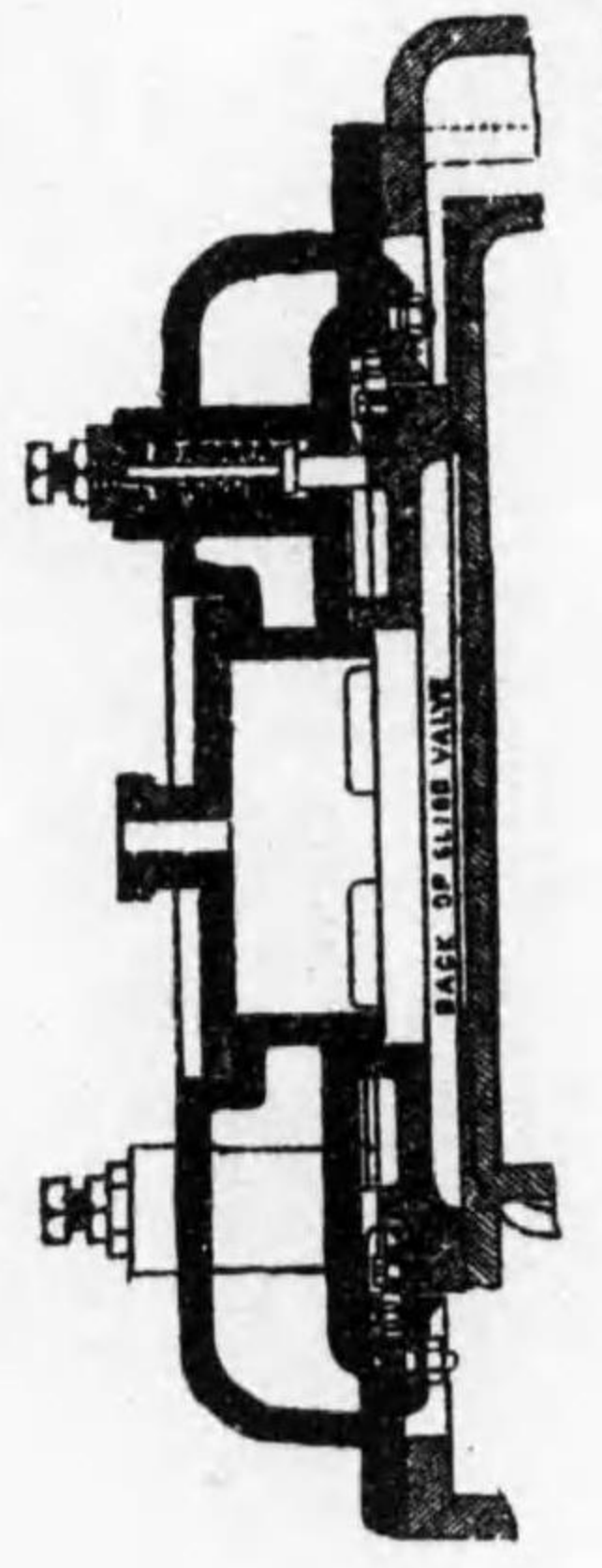

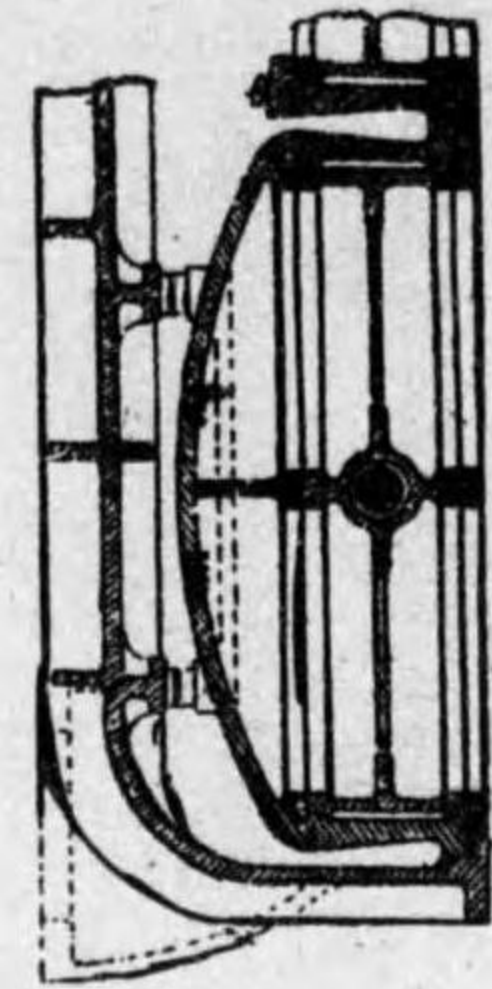
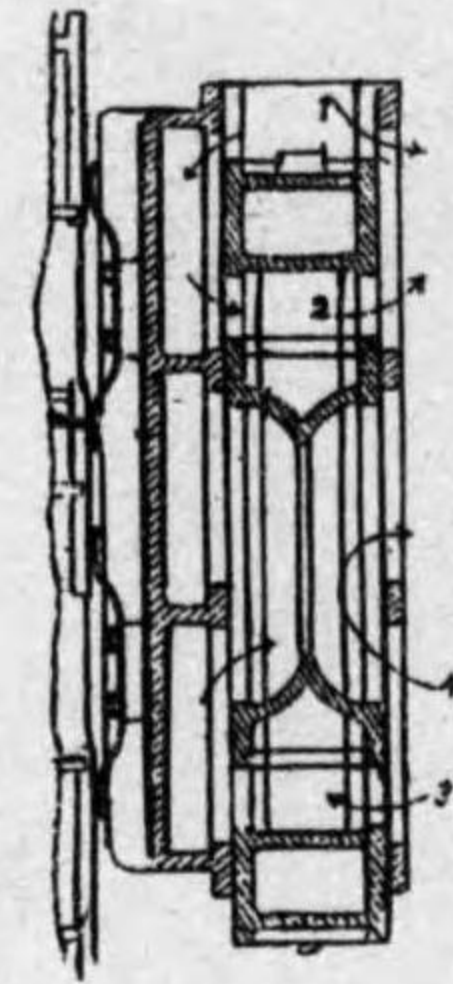
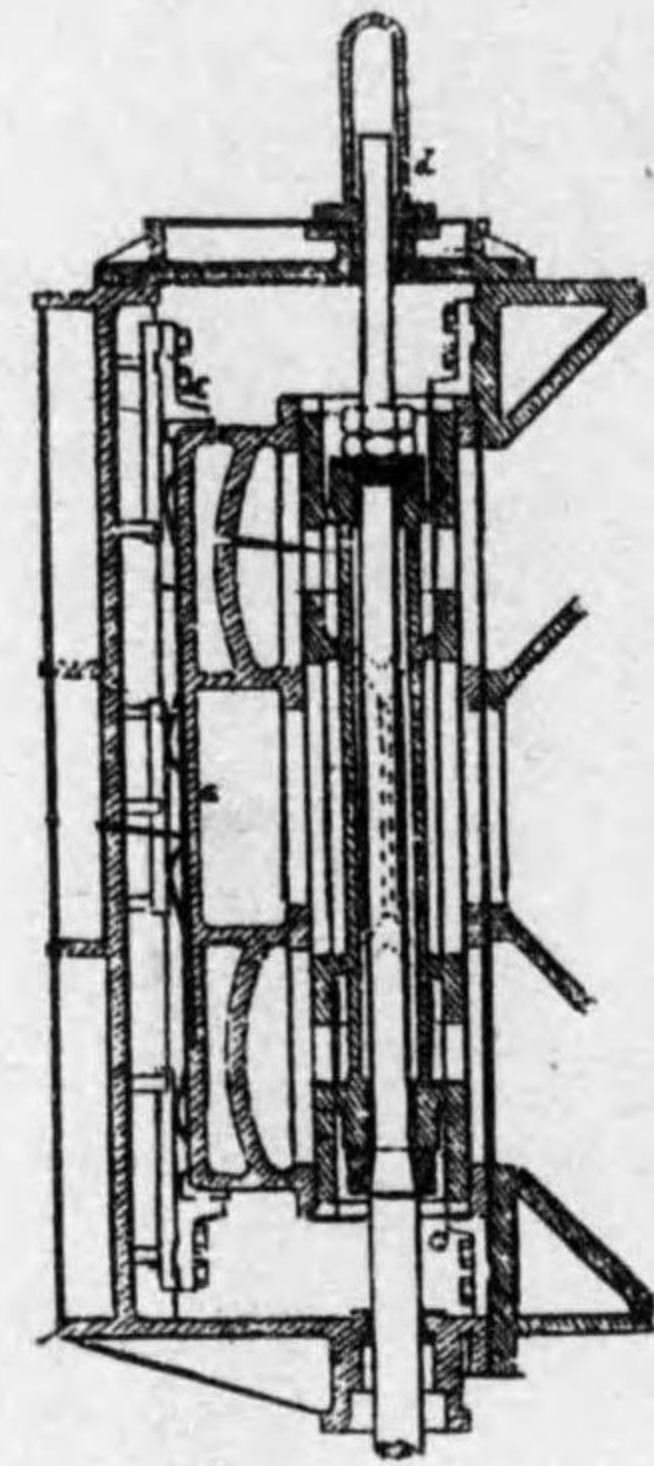

第 104 圖

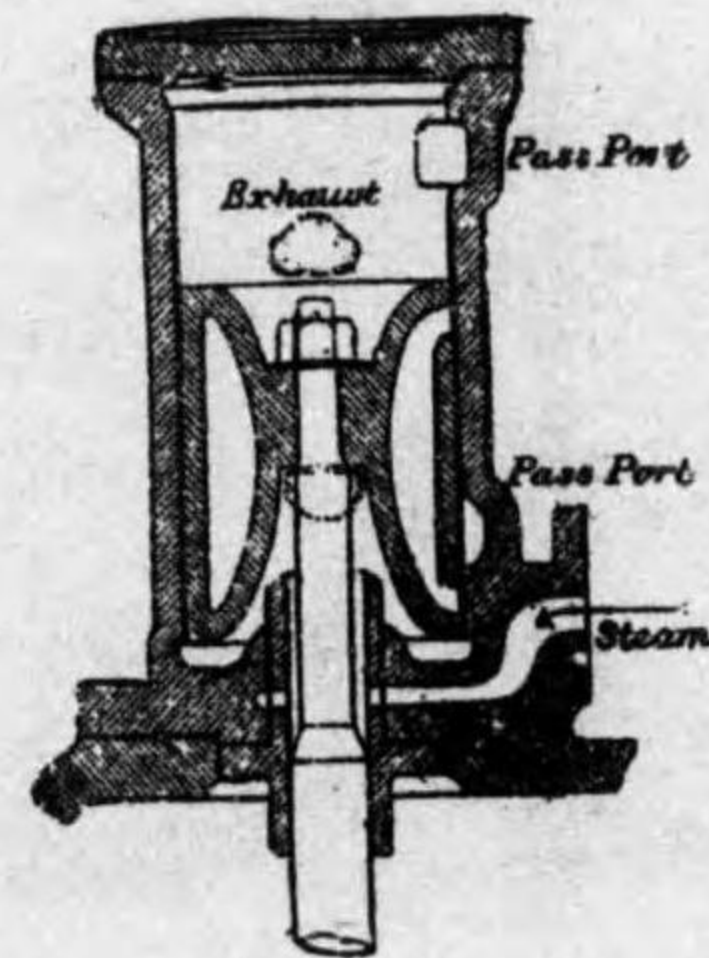
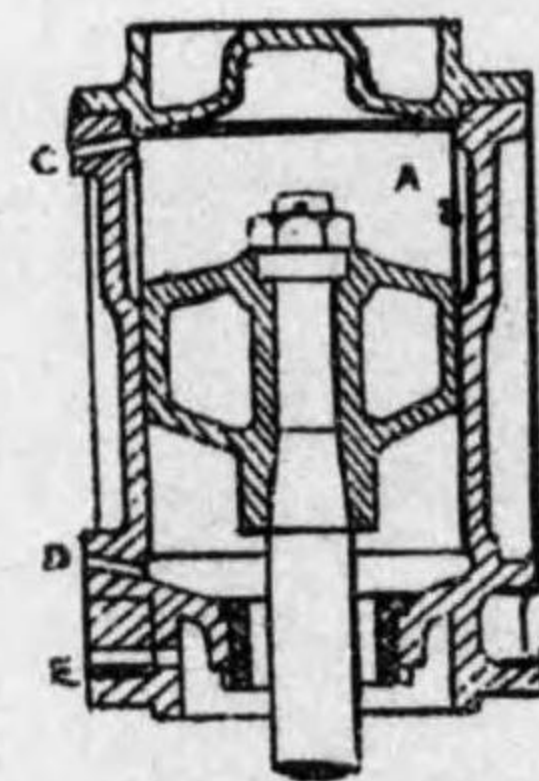
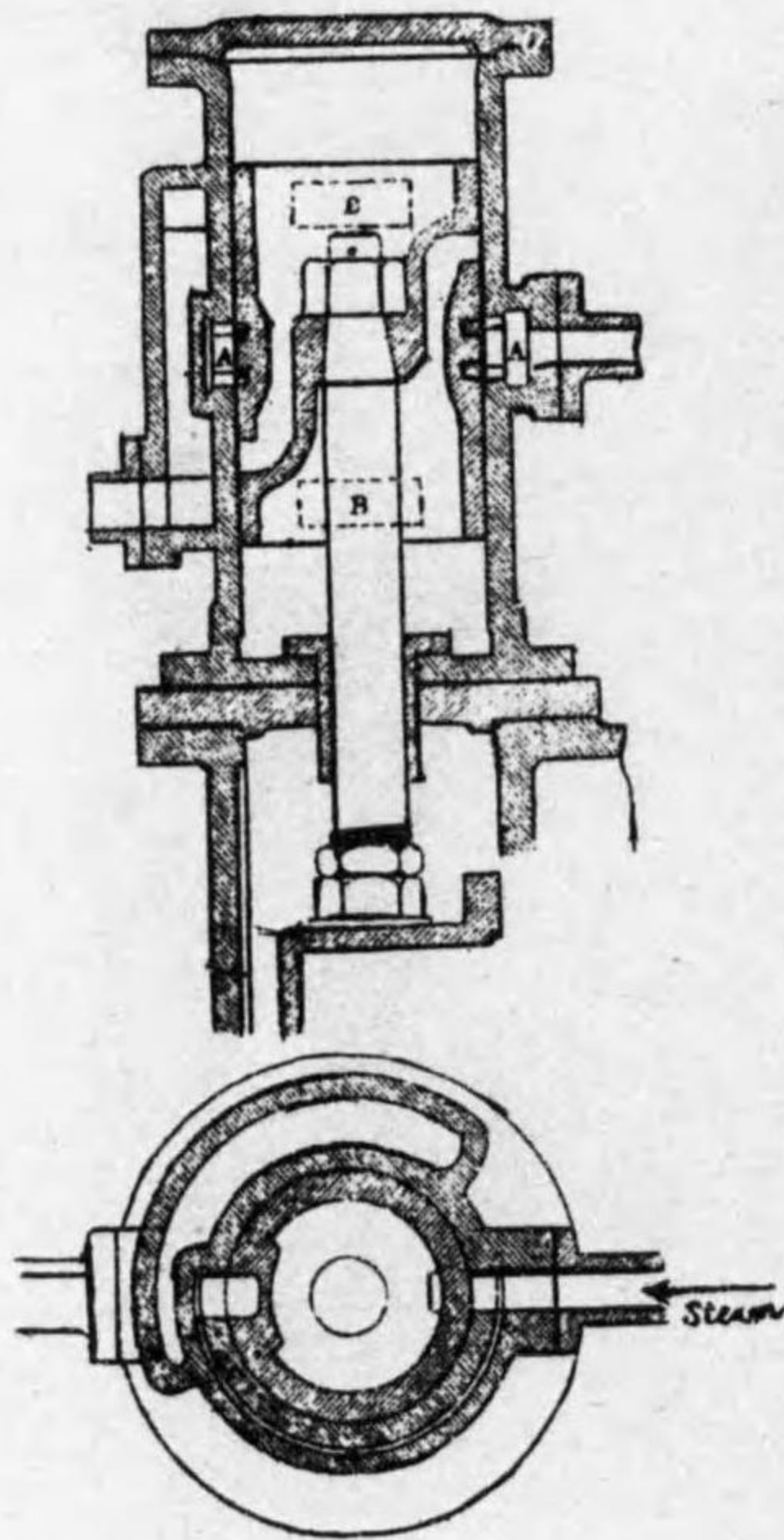

第 105 圖

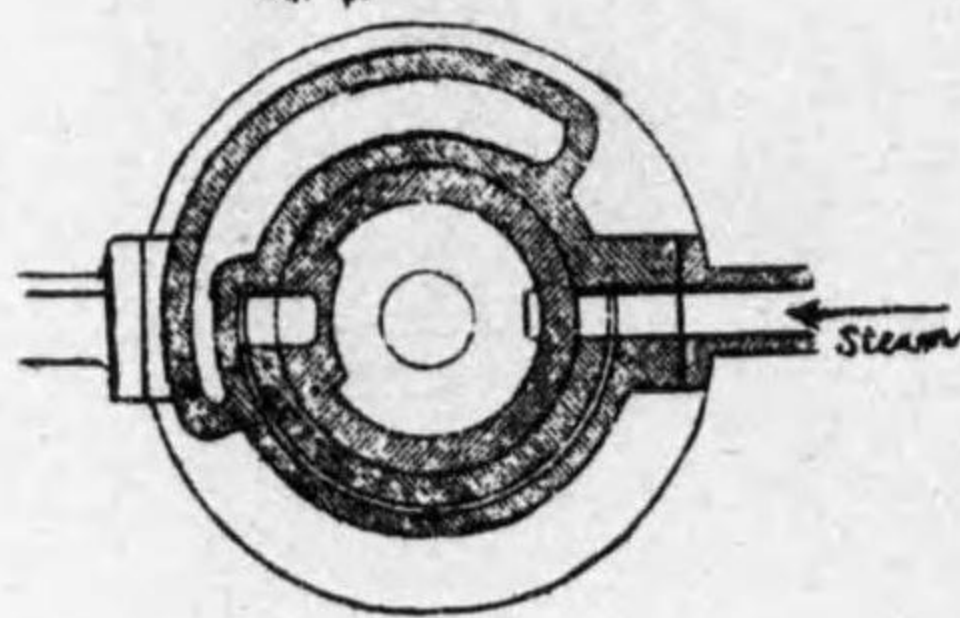

A

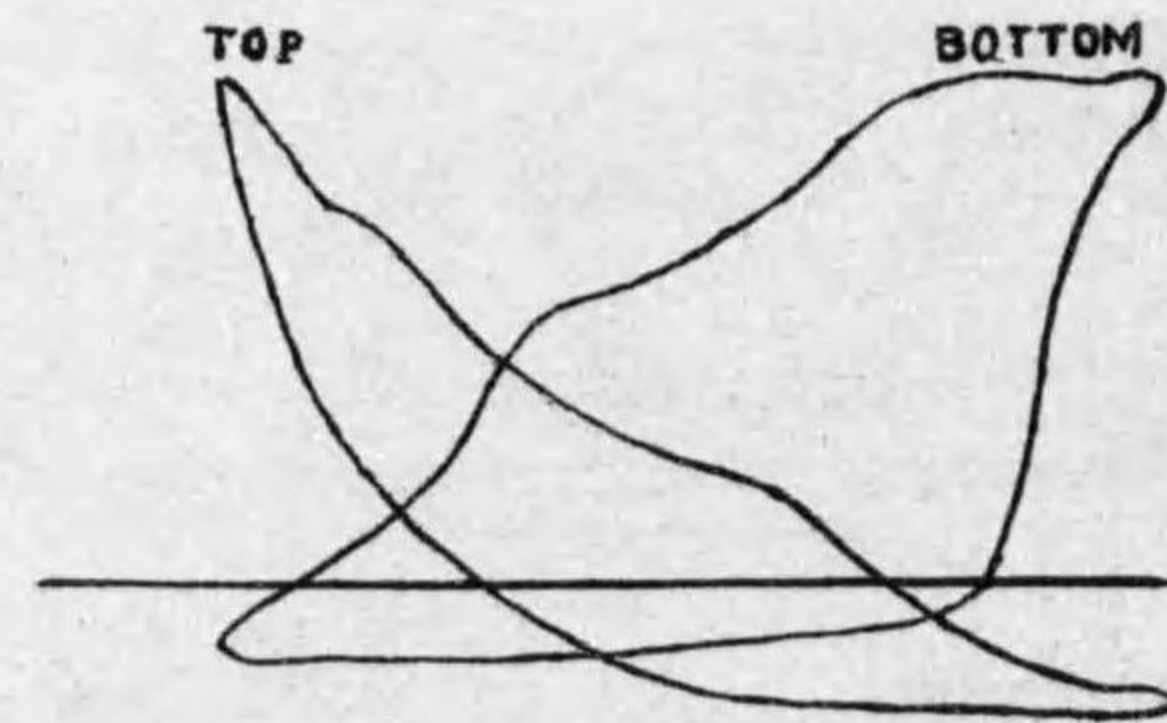

第 106 圖

C

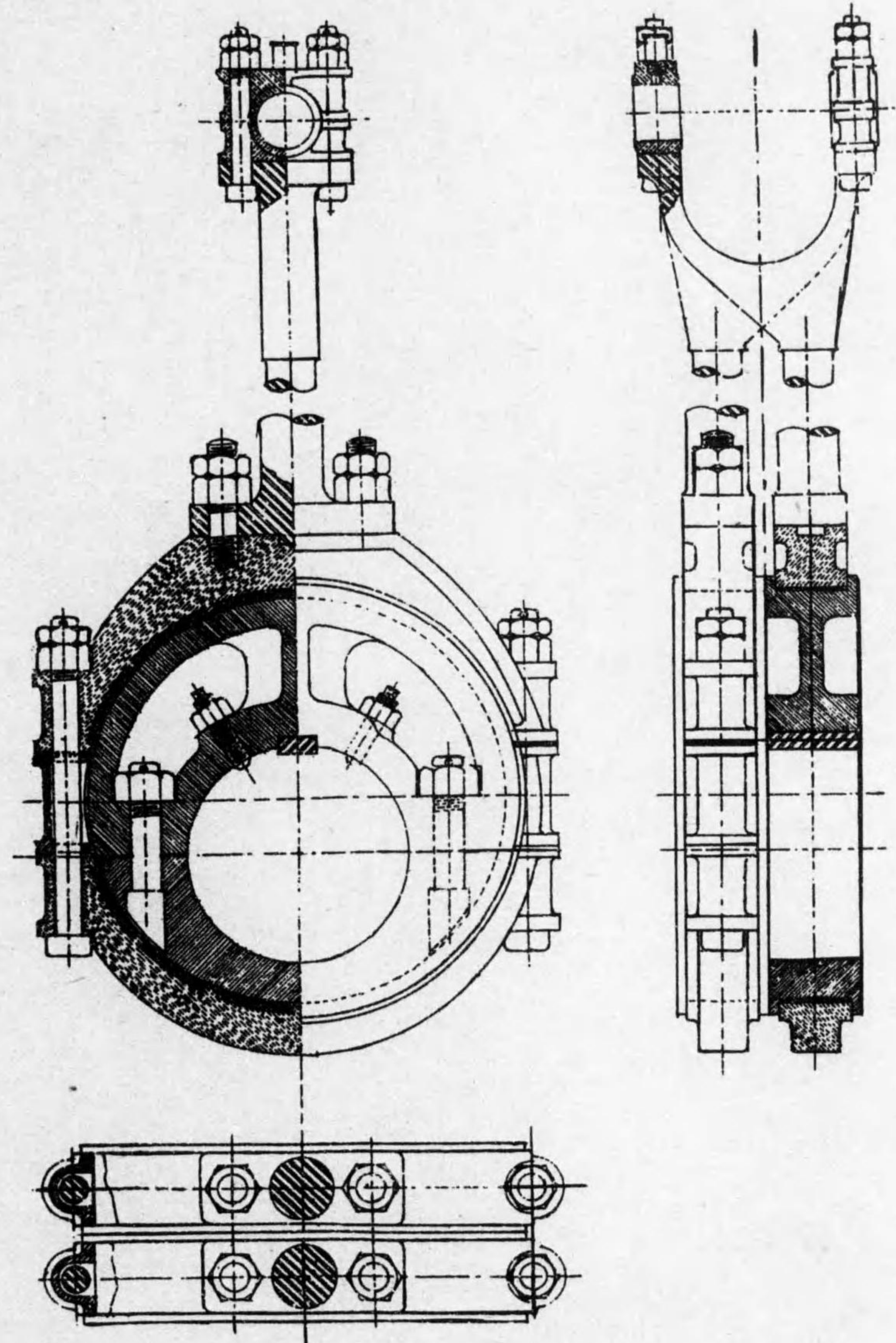

第 107 圖 A

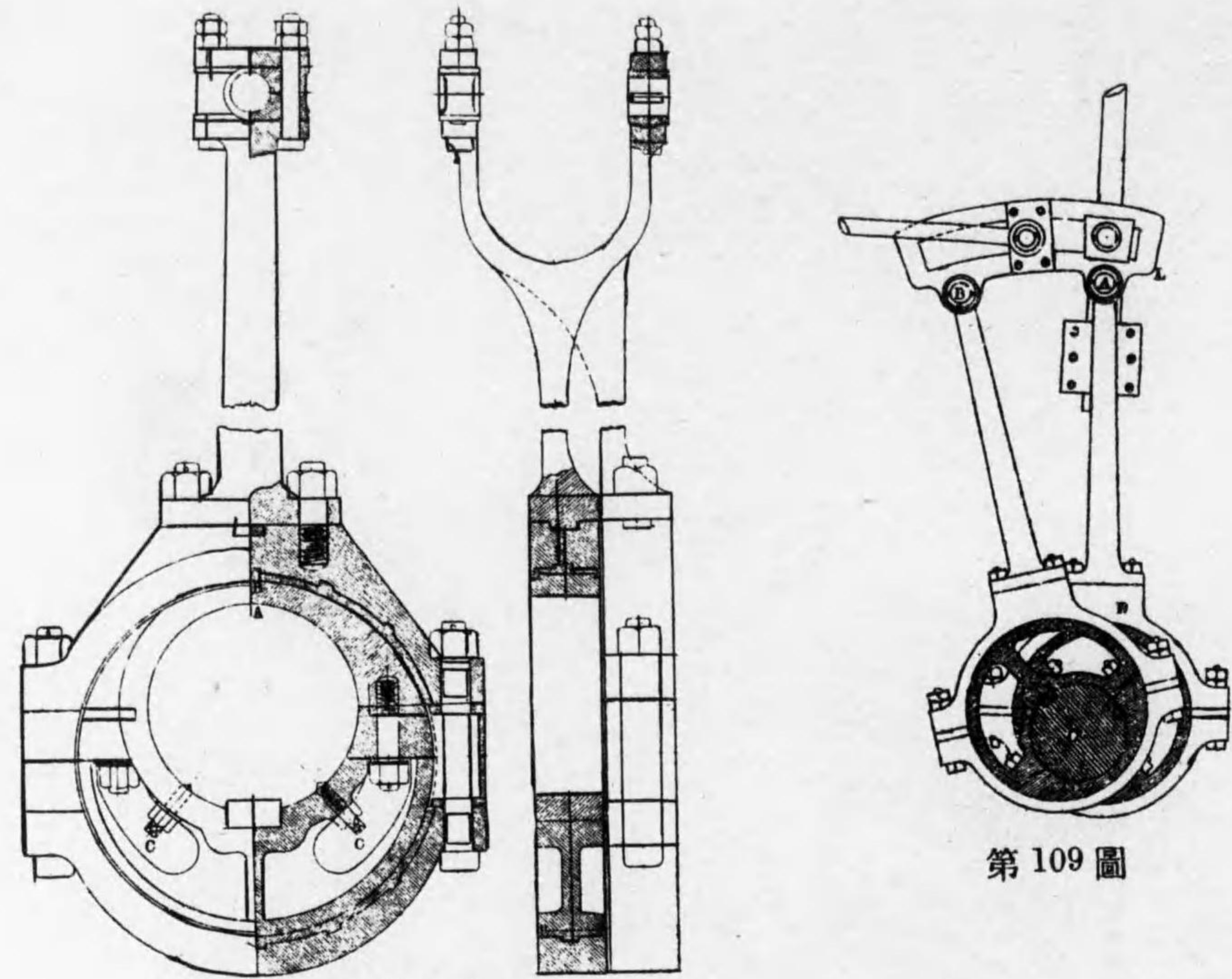

第107圖 B

第109圖

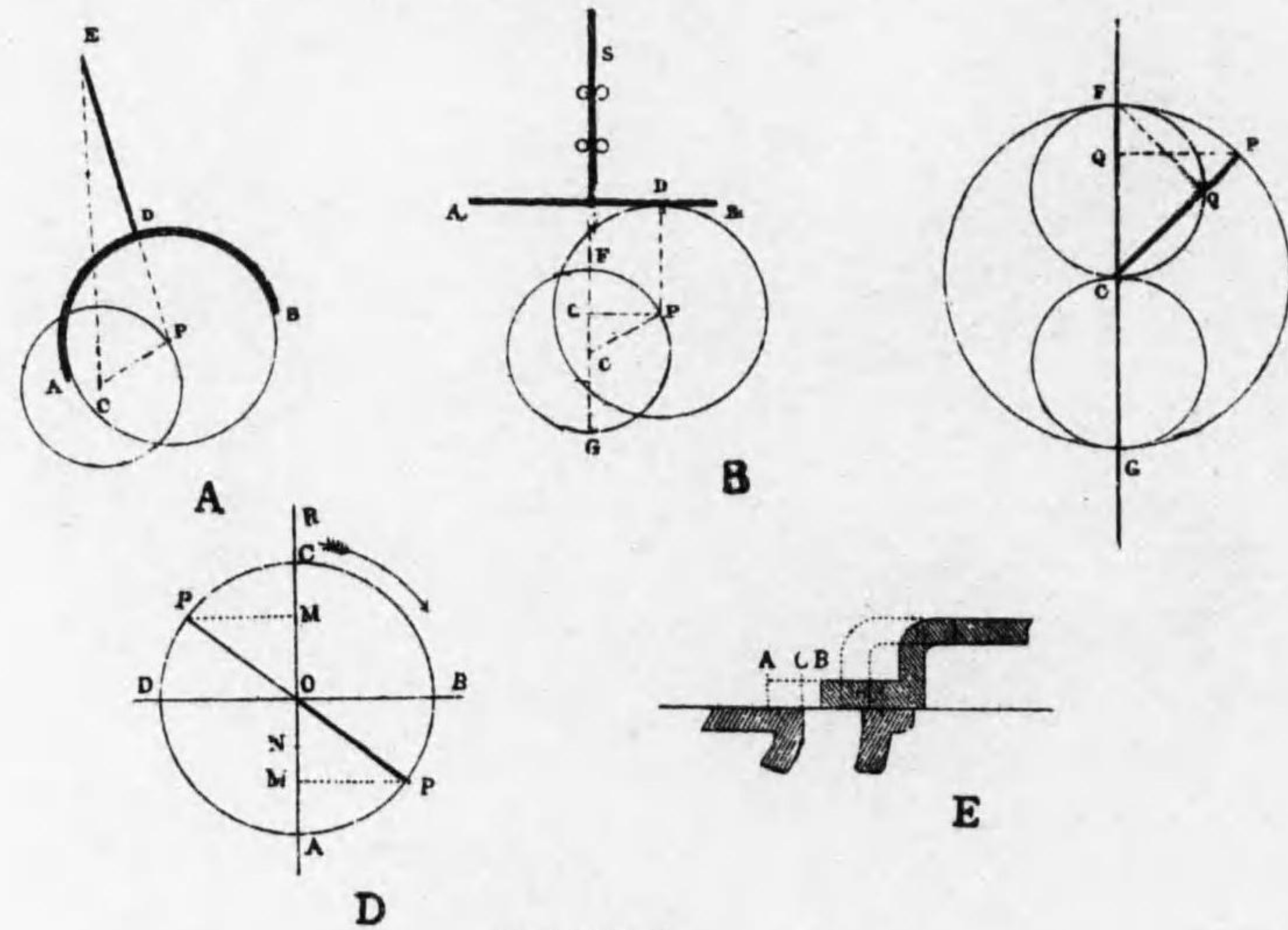

第108圖

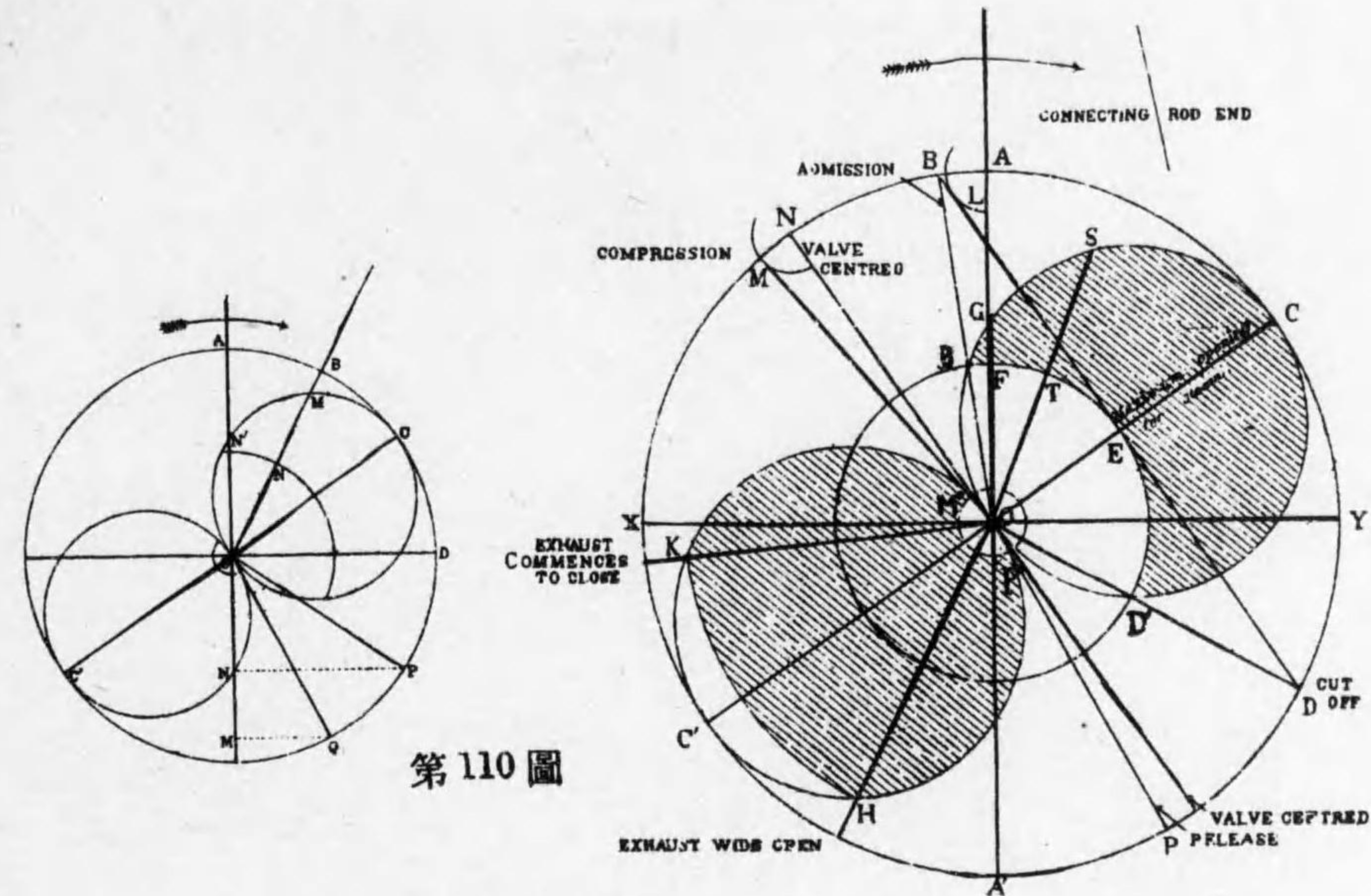

第110圖

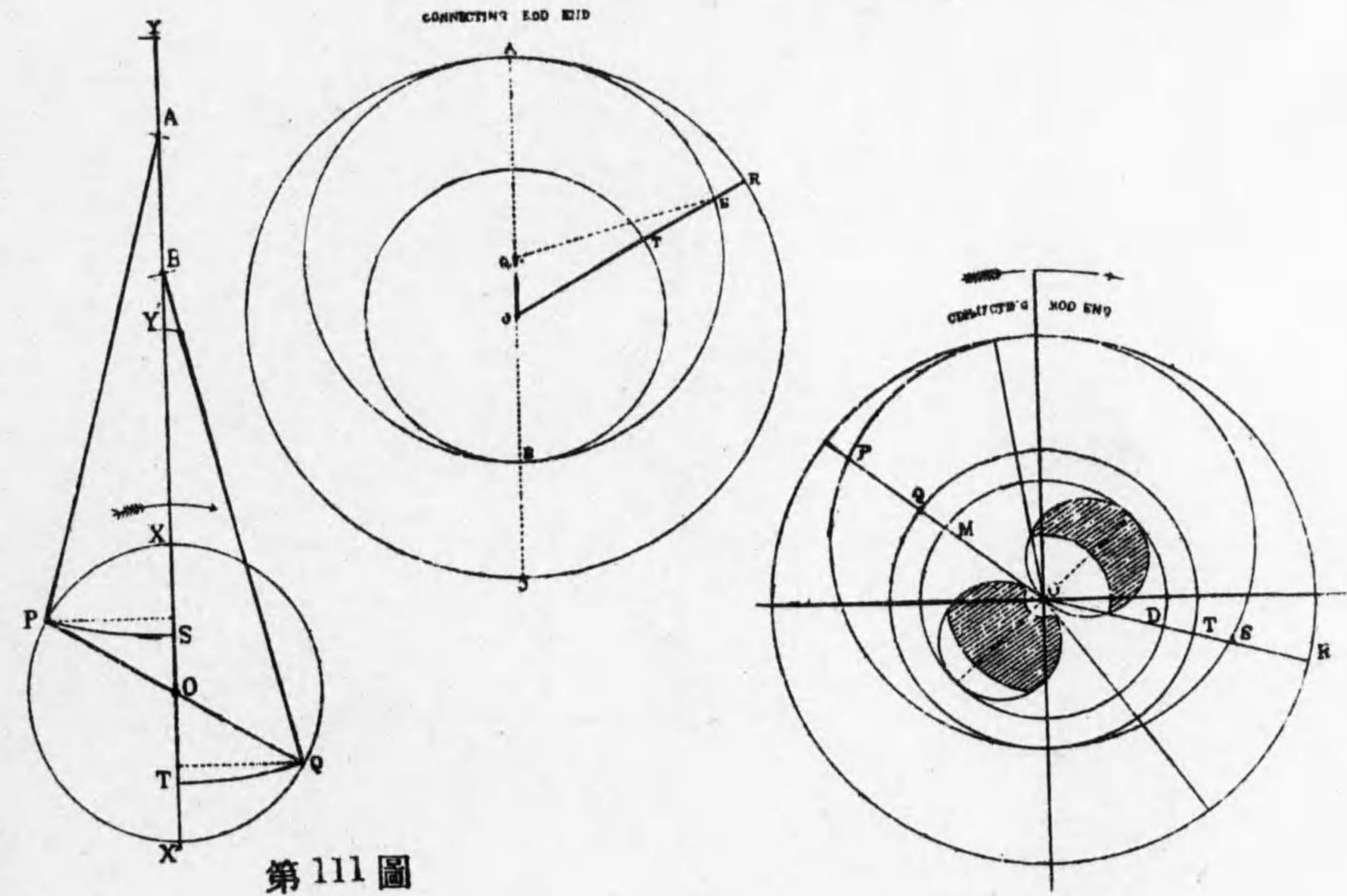

第111圖

第112圖

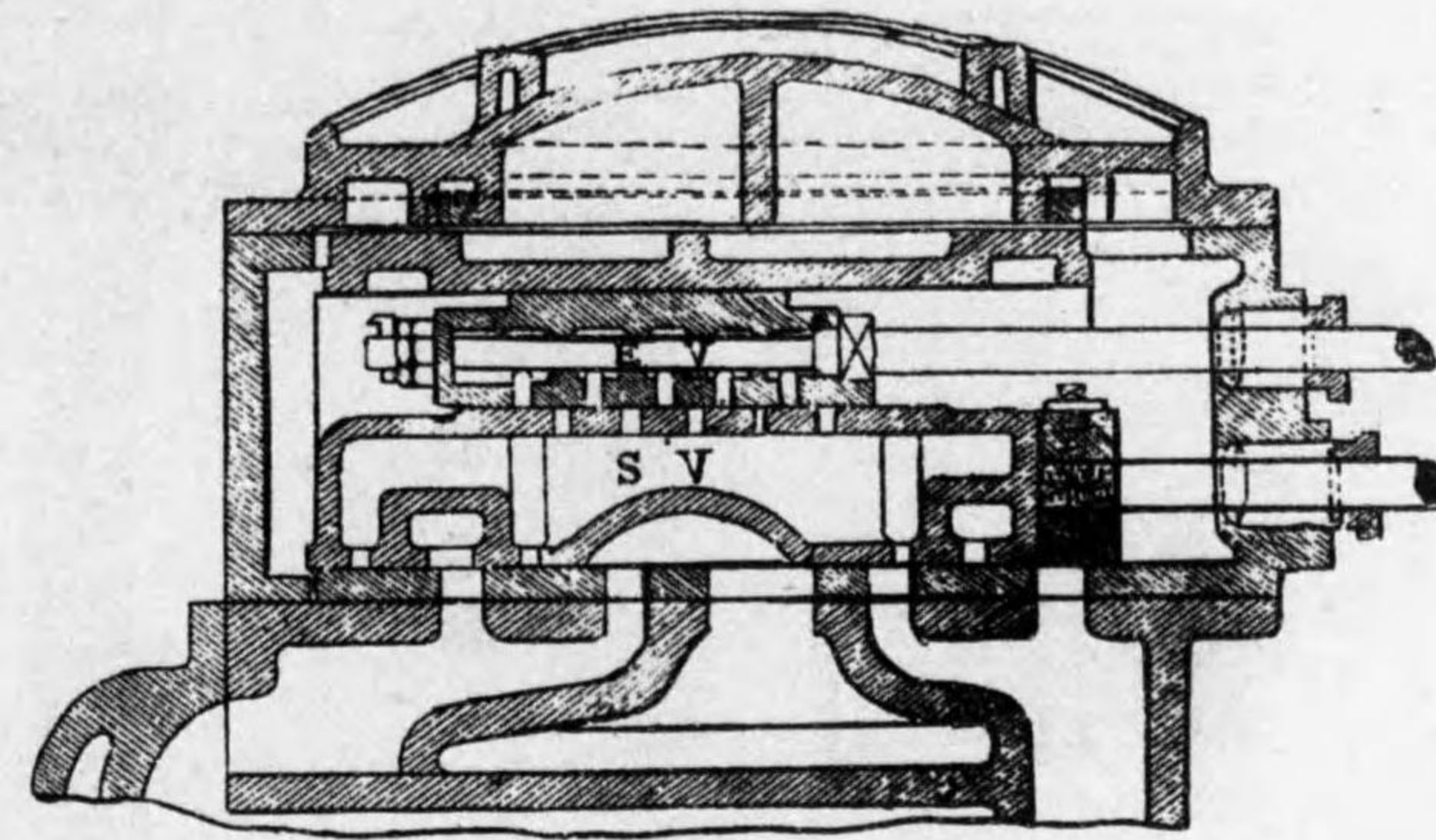
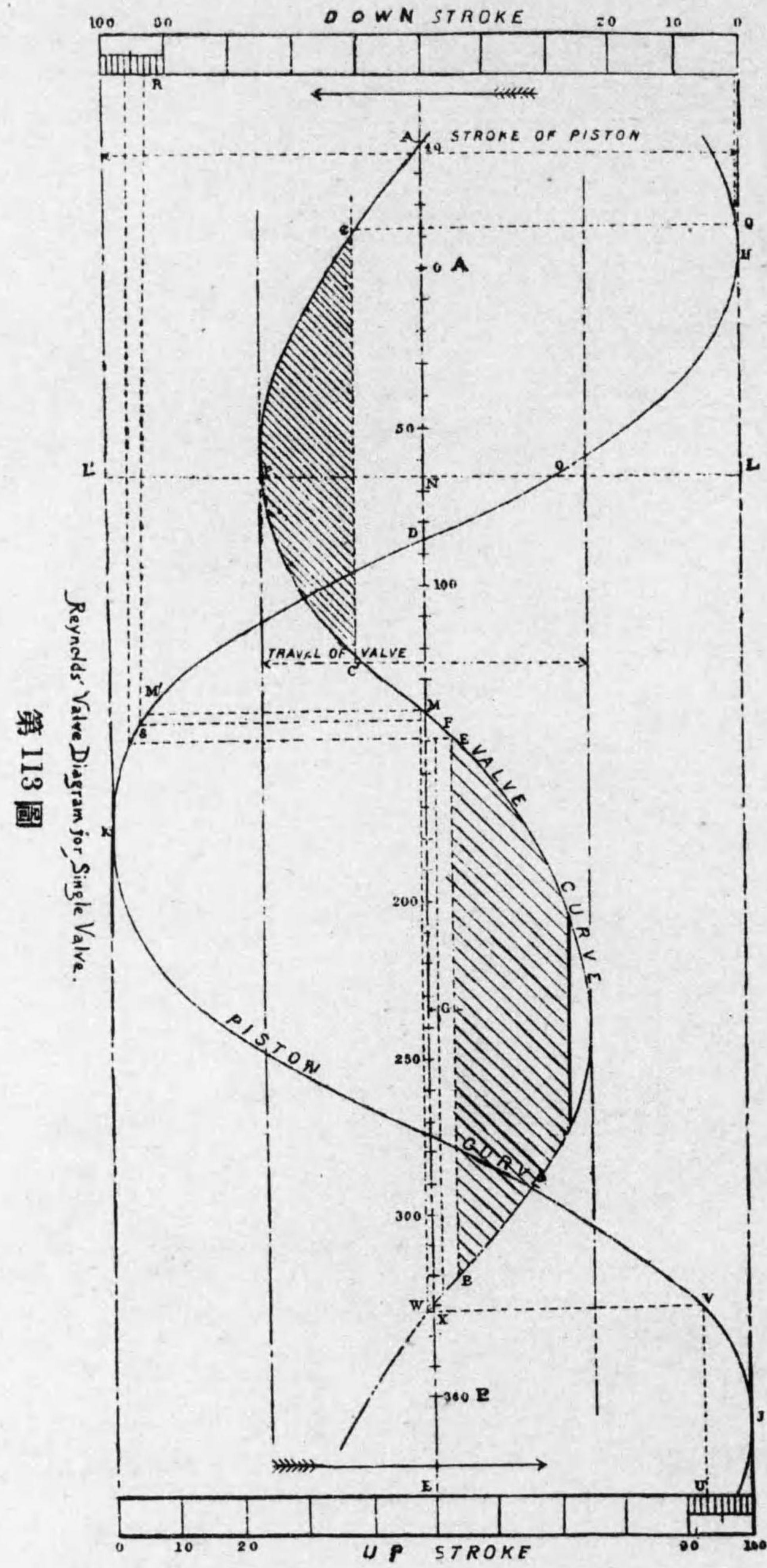

第114圖A

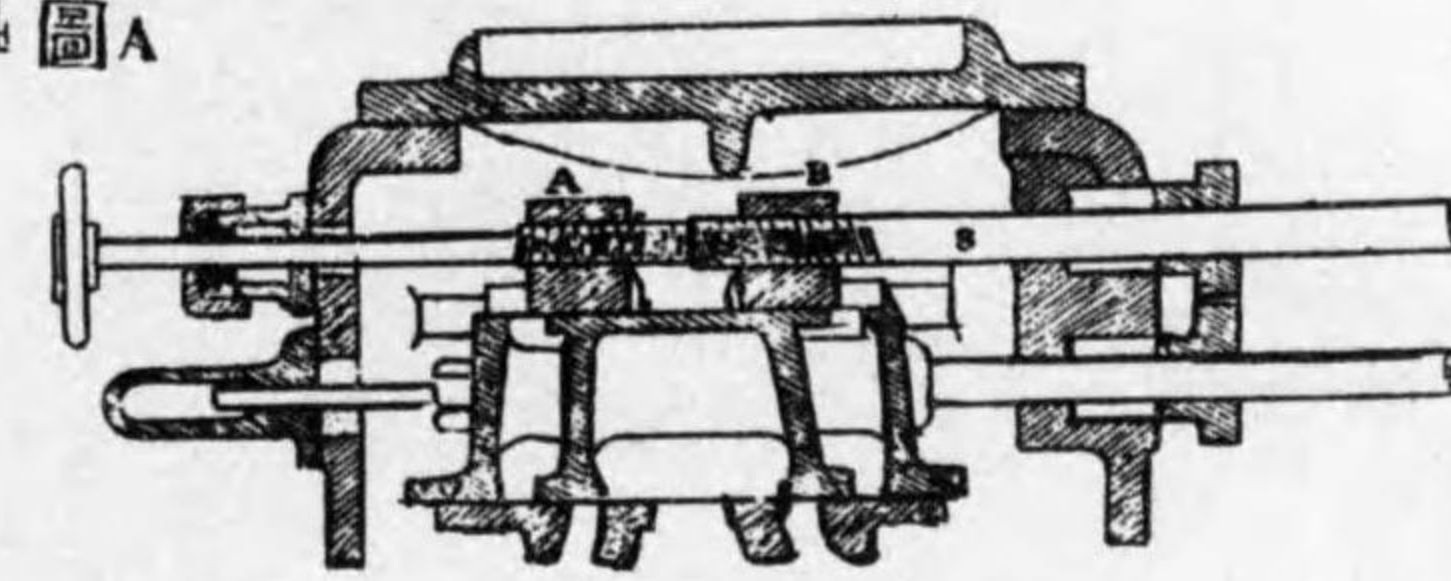

第114圖B

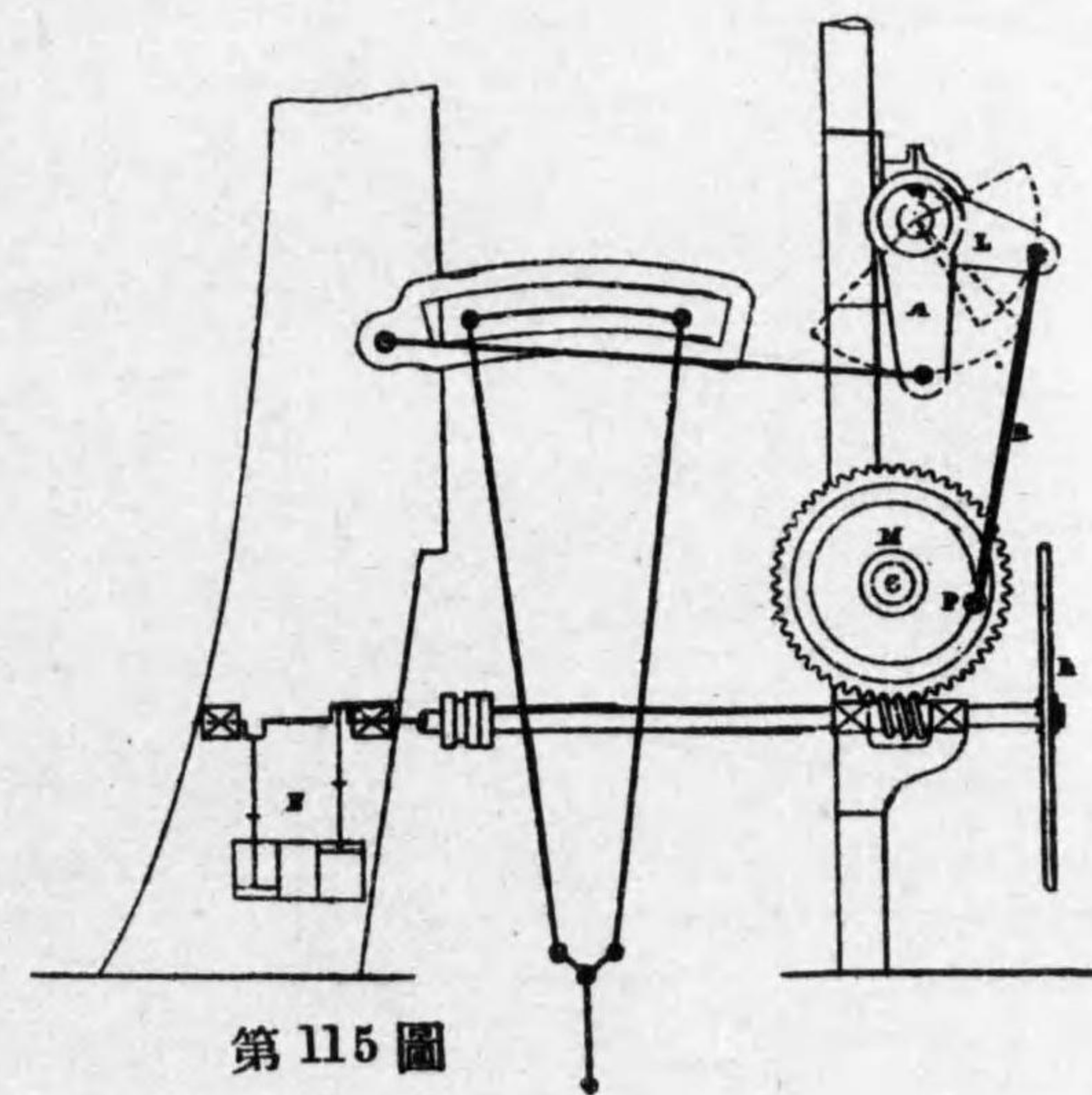

第115圖

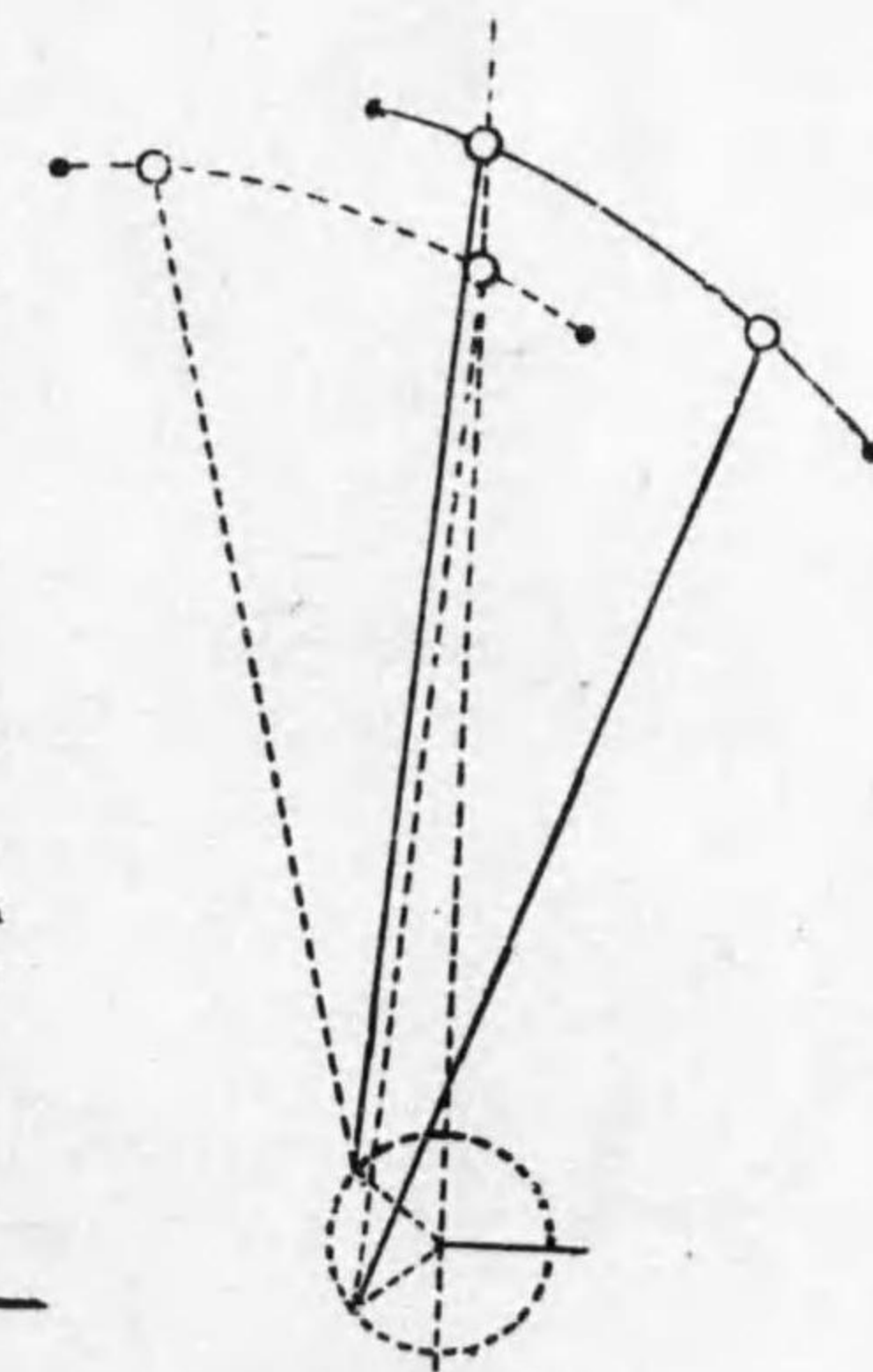

第116圖

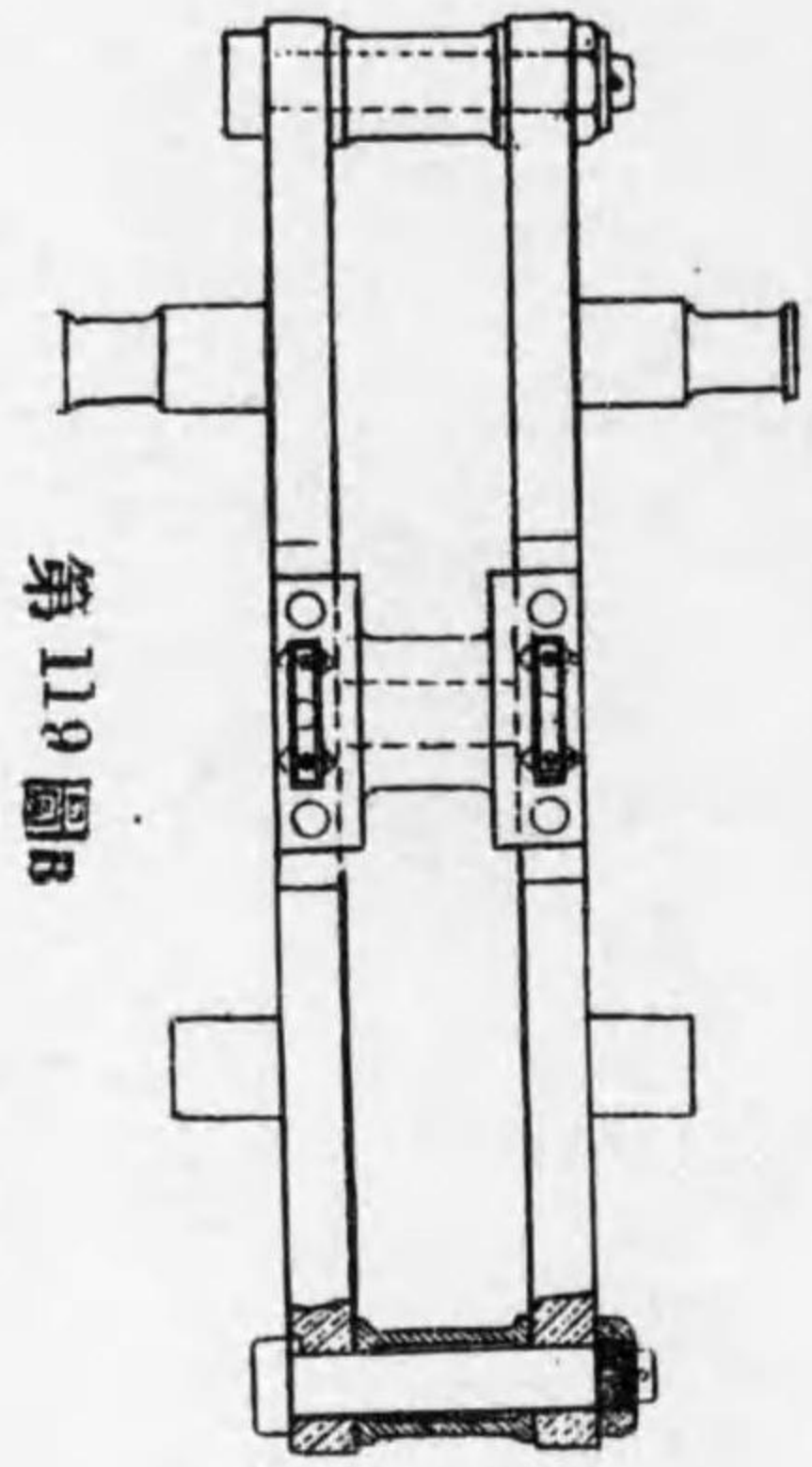

第 119 圖 B

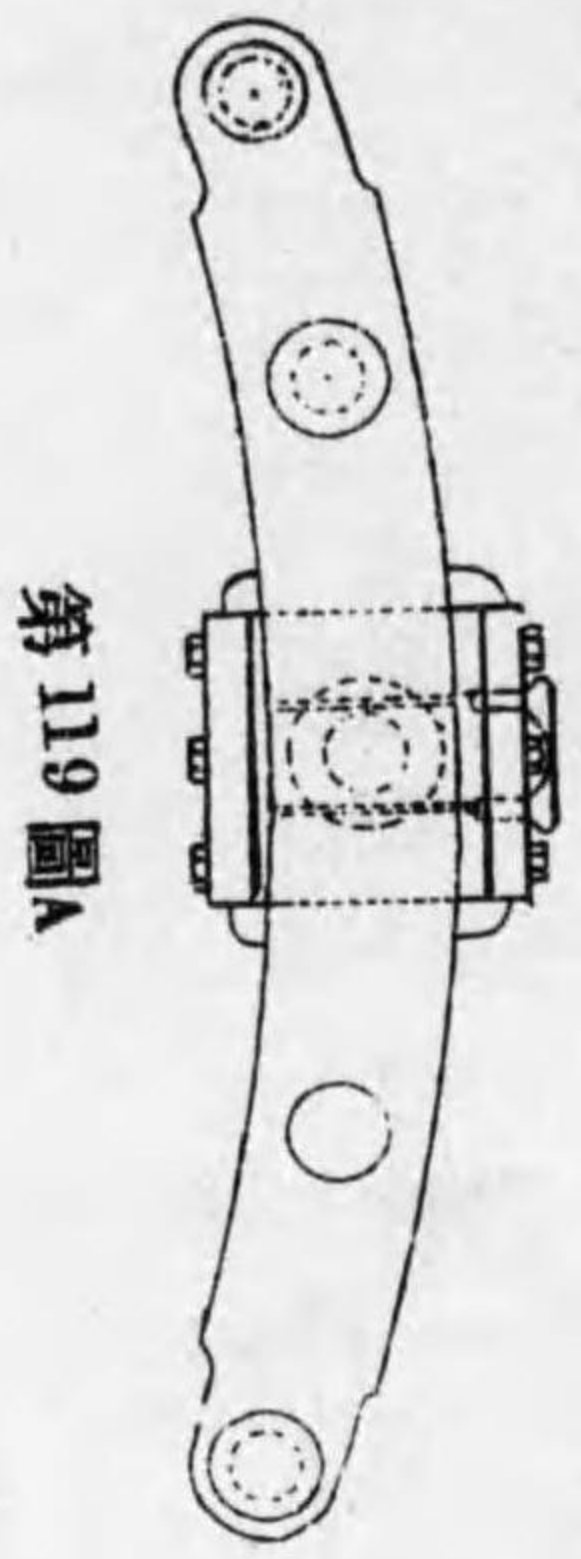

第 119 圖 A

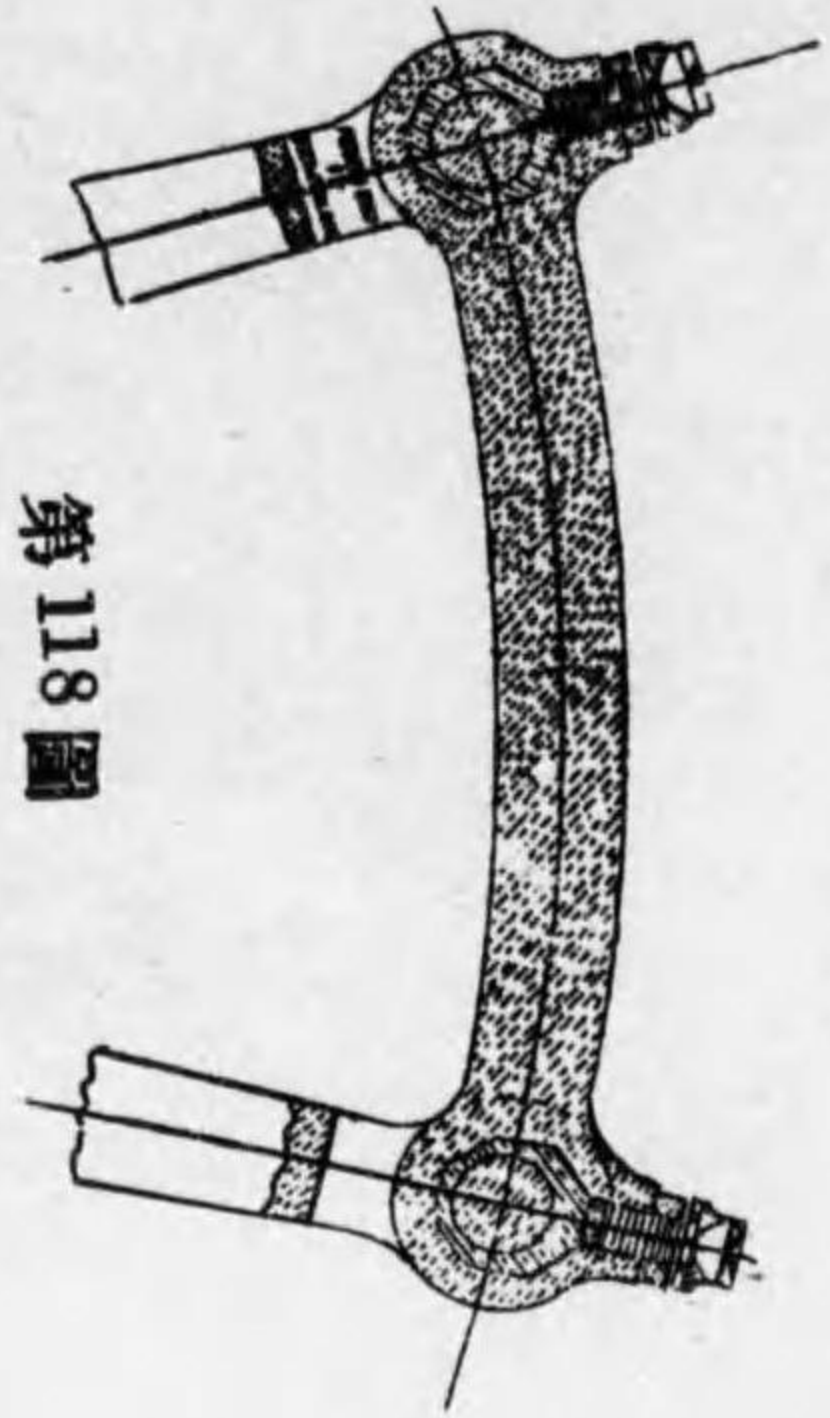

第 118 圖

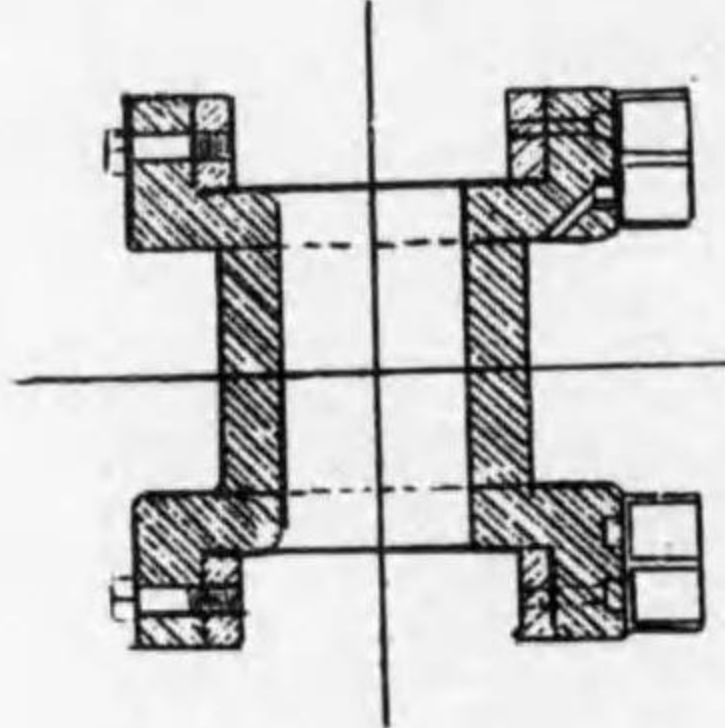

第 119 圖 C

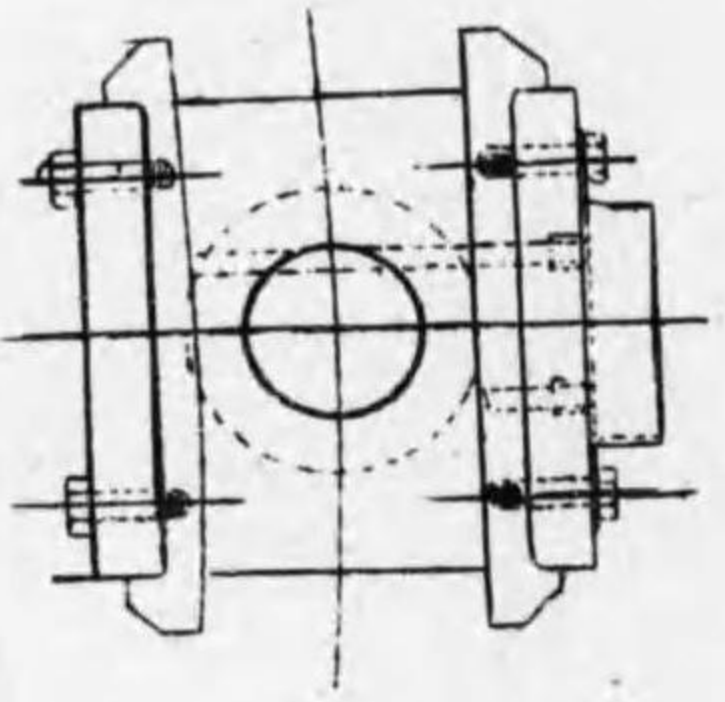

第 117 圖

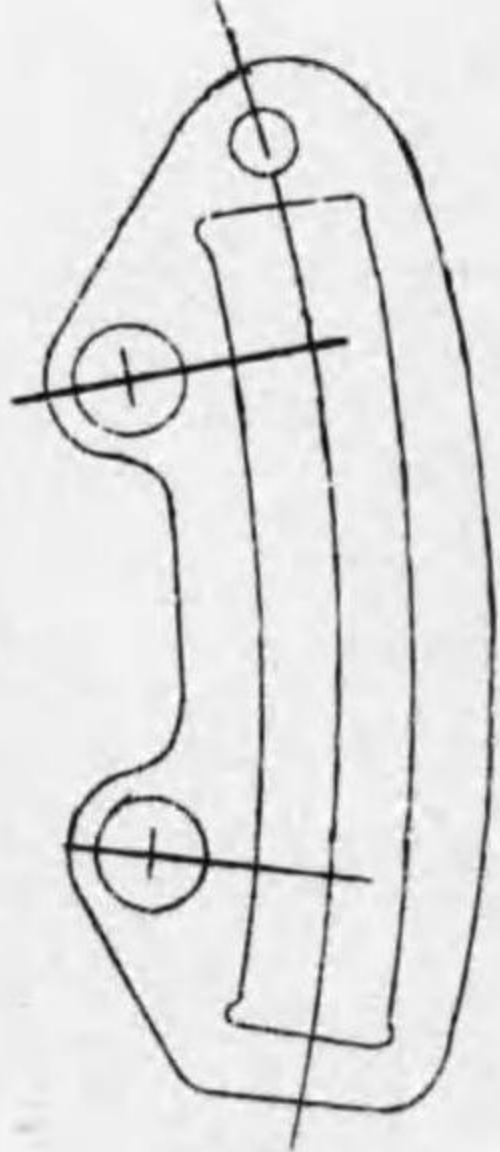

第 120 圖

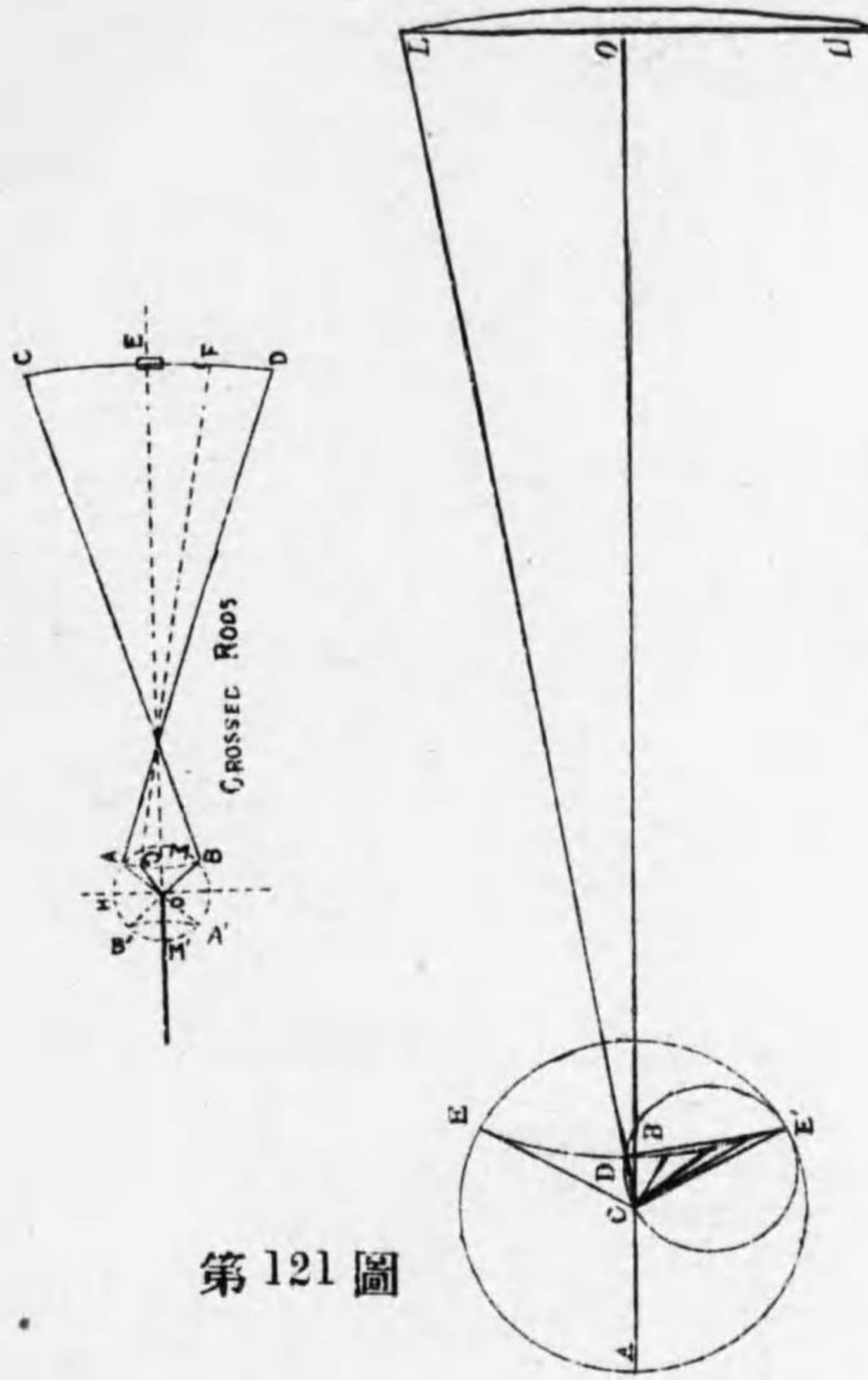
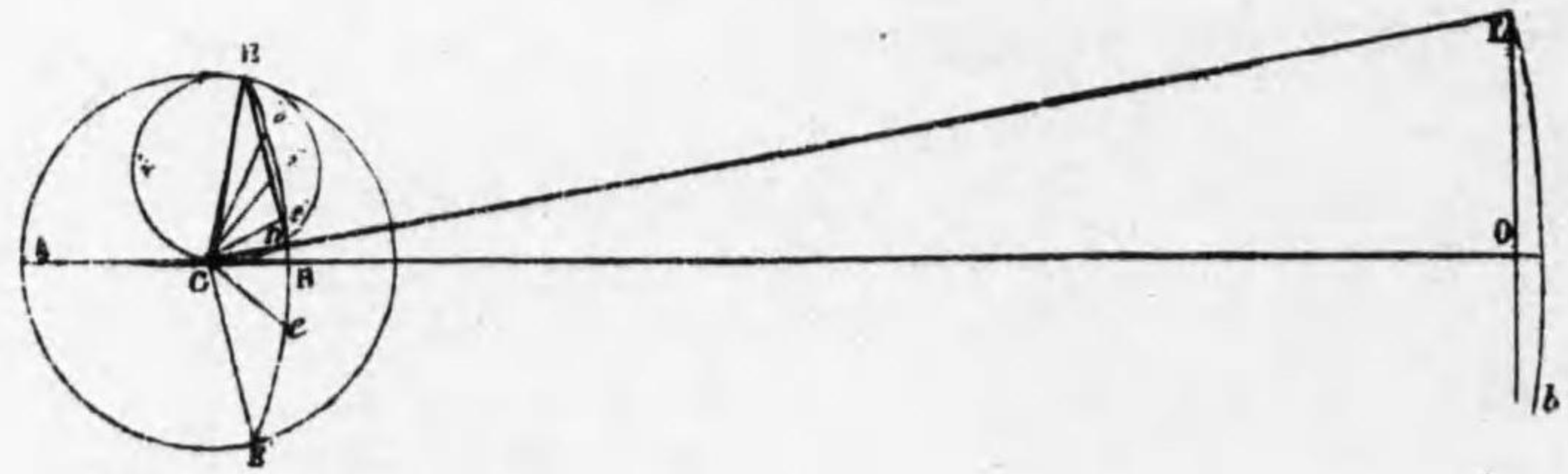
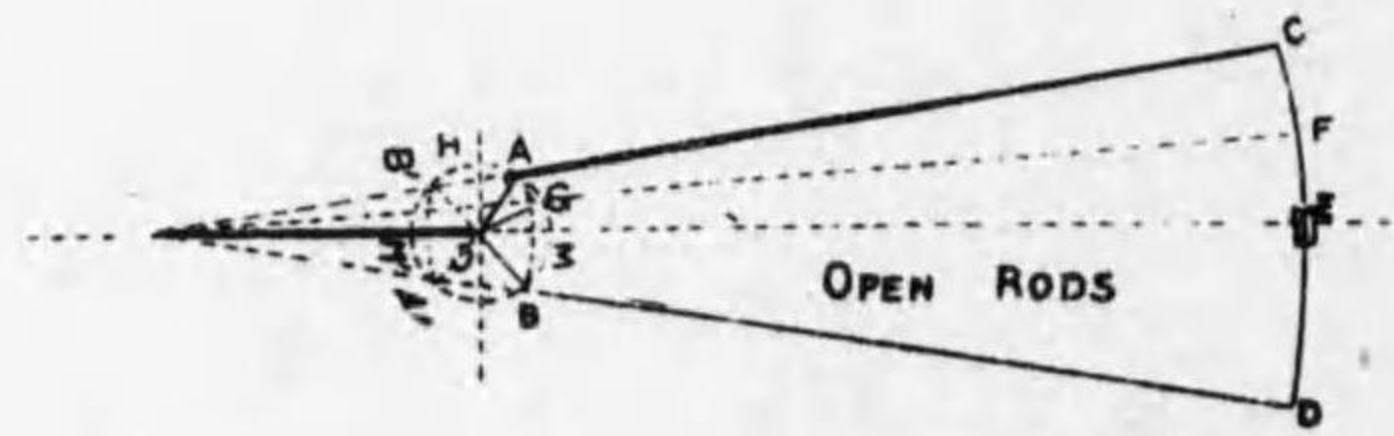

第 121 圖

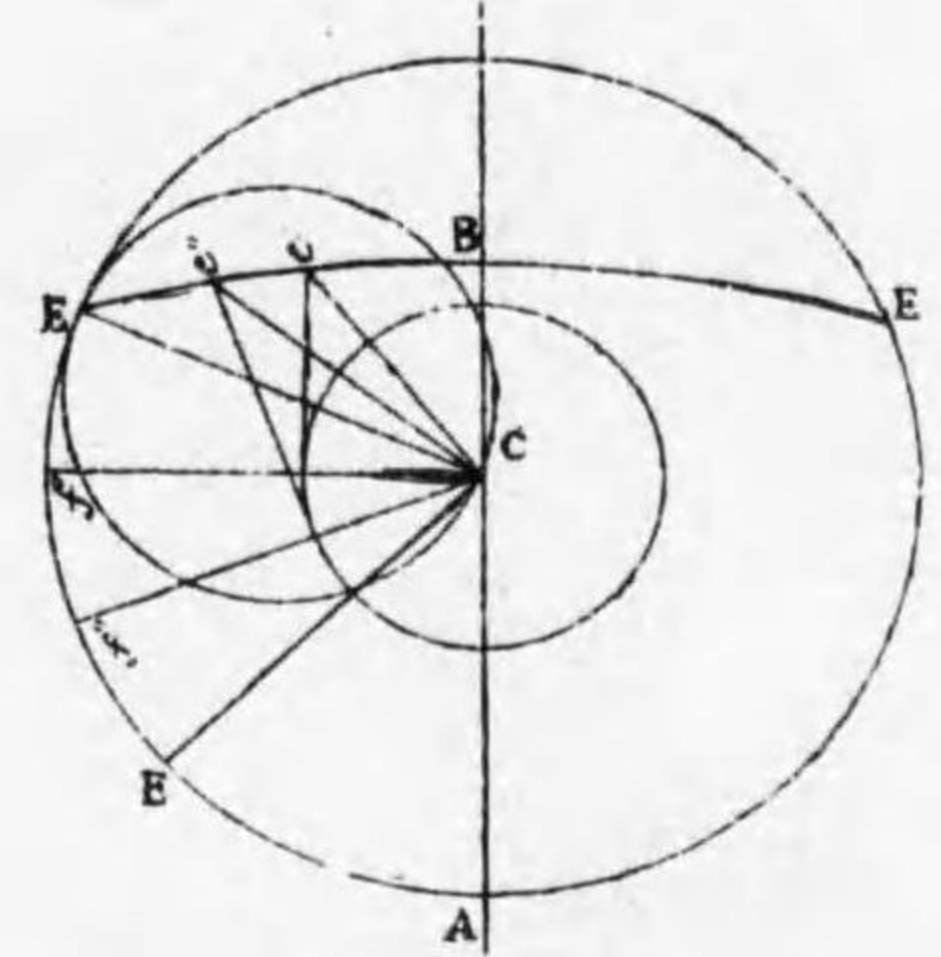

第 122 圖

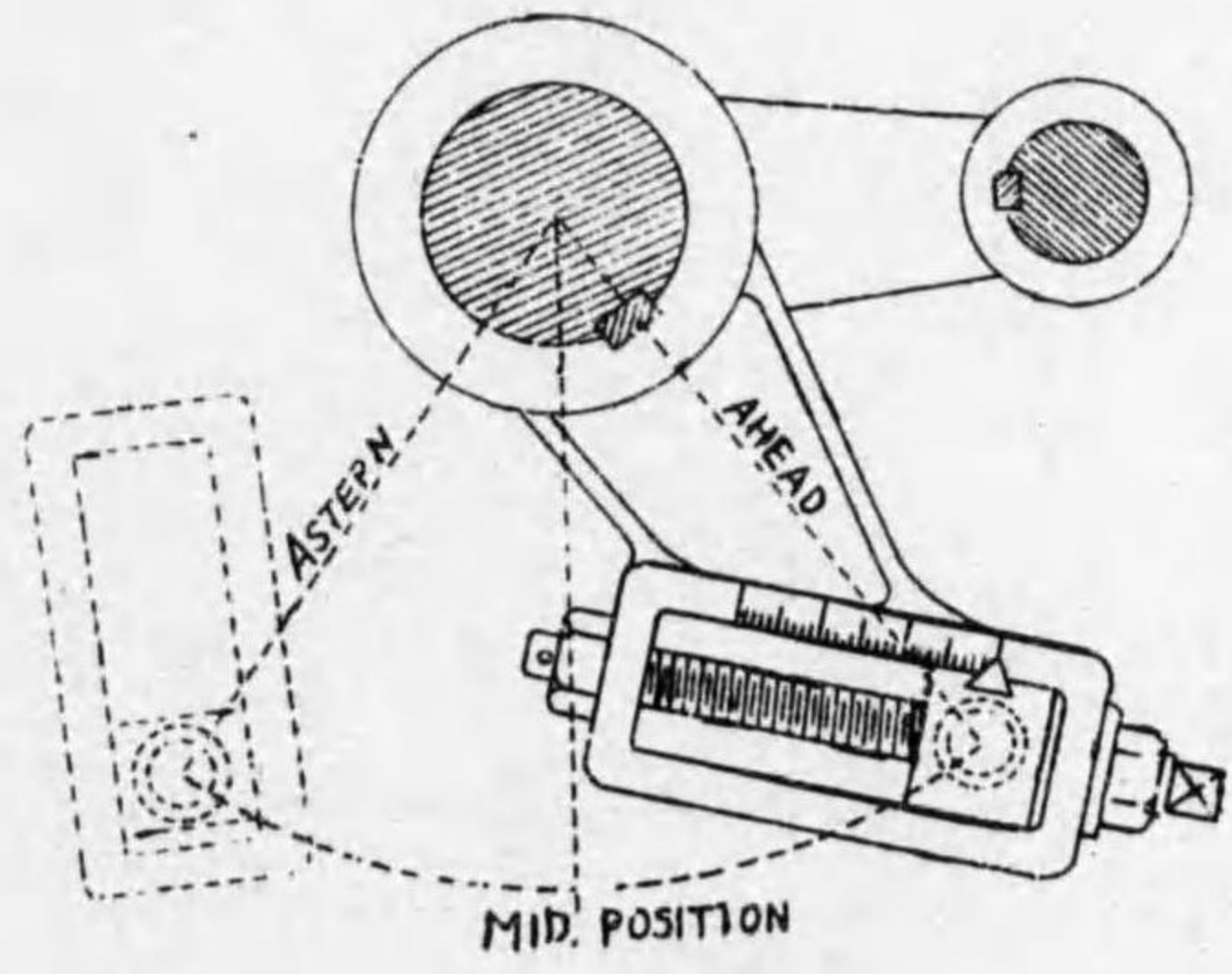

第 124 圖

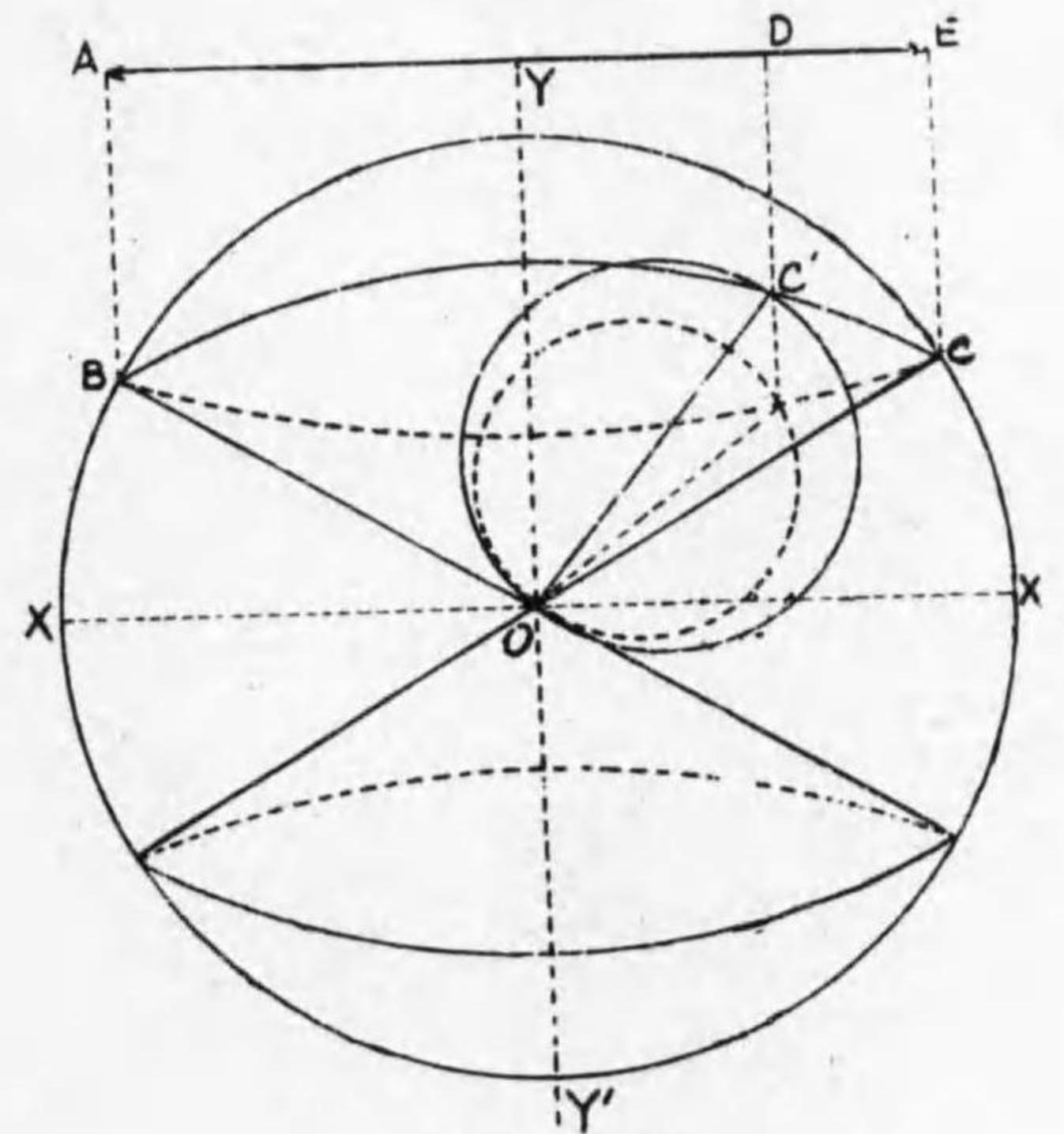

第 123 圖

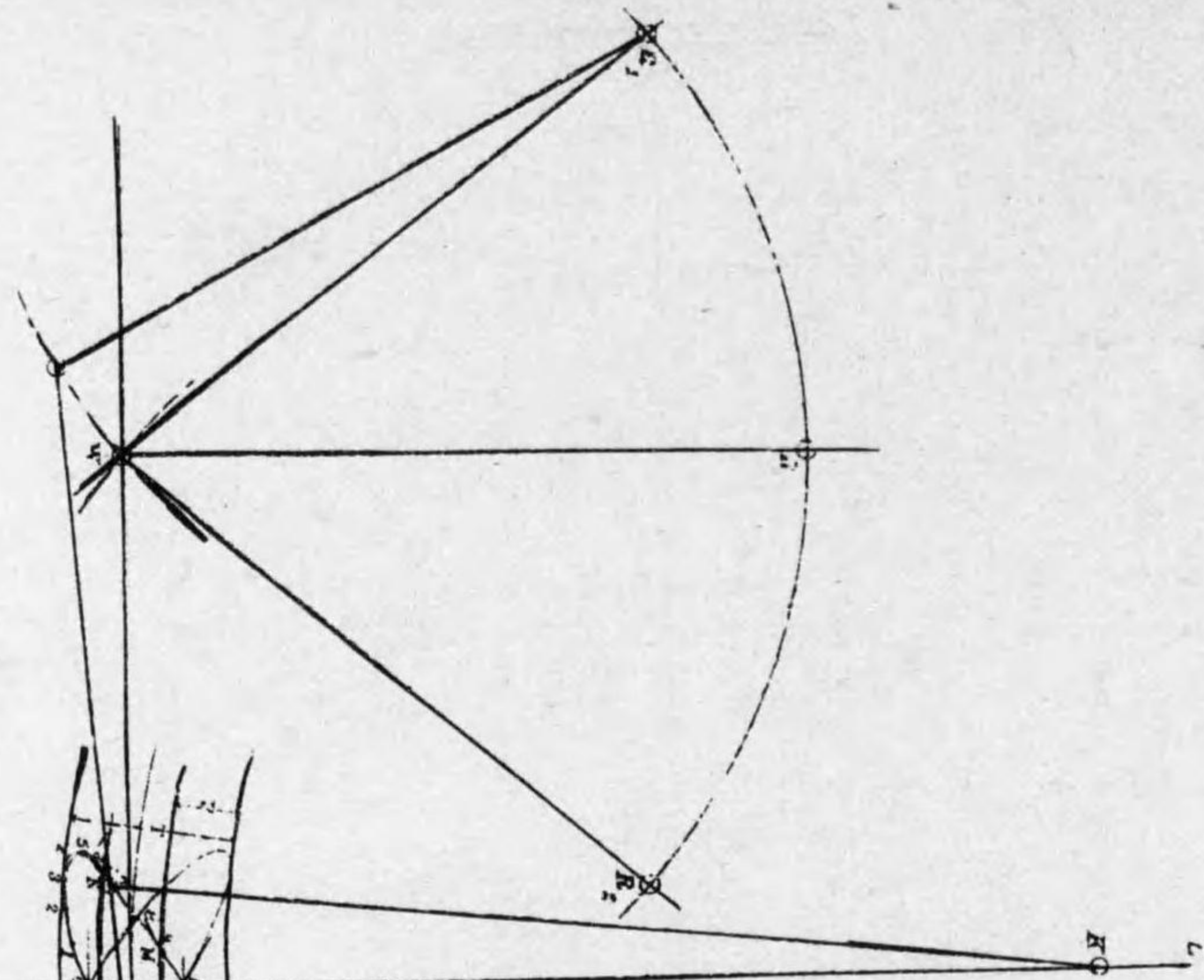

第 126 圖

C	Hub of the slide valve gear.
S	Center of crank shaft.
P	Center of piston pin.
W	Weight of piston.
WR	Weight of rod.
RG	Radius of gyration of rod.
PO	Point of crank pin.
RS	Radius of crank pin.
RL	Radius of crank pin.
R	Radius of slide valve.
D	Lead of slide valve.
F	Full diameter of steam port.
T	Point of slide valve.
M	Distance of steam.
N	Cut-off.

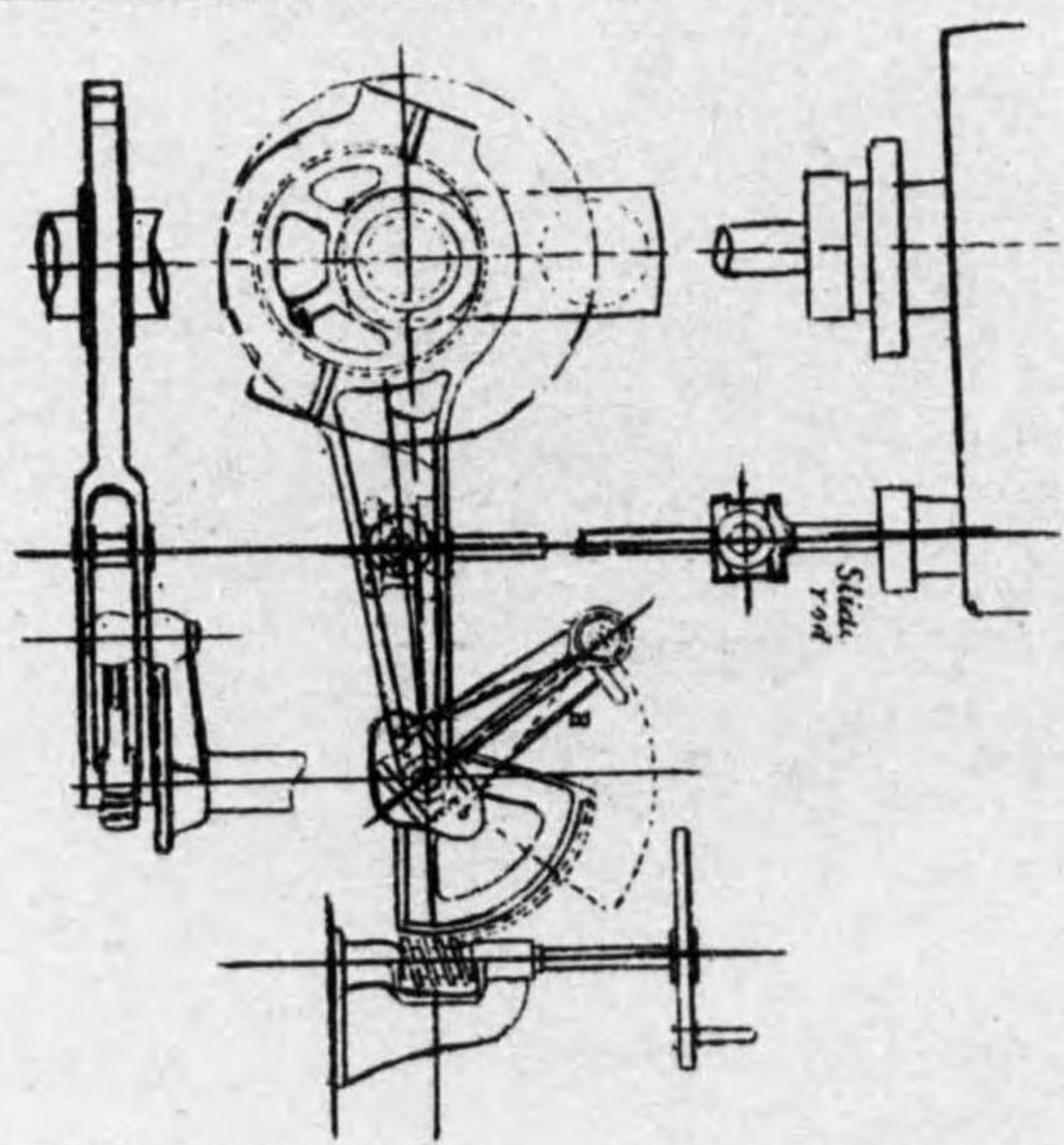

第 125 圖

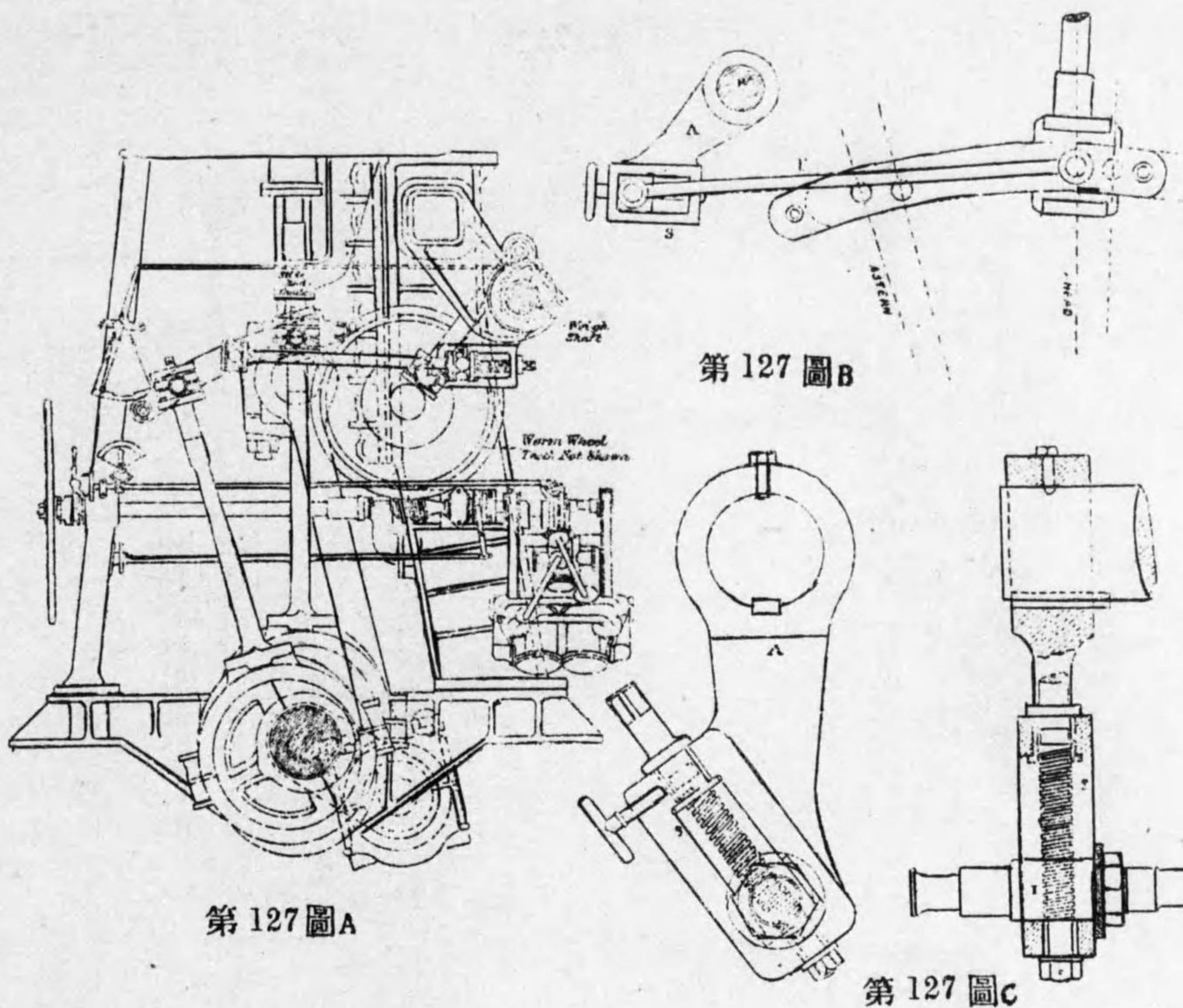
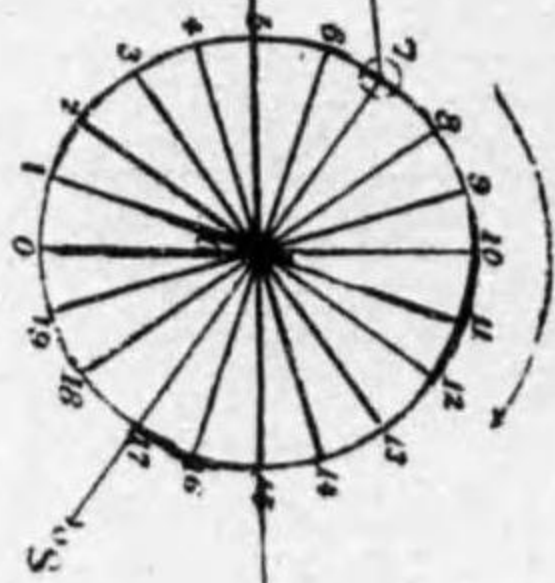

第 127 圖A

第 127 圖B

第 127 圖C

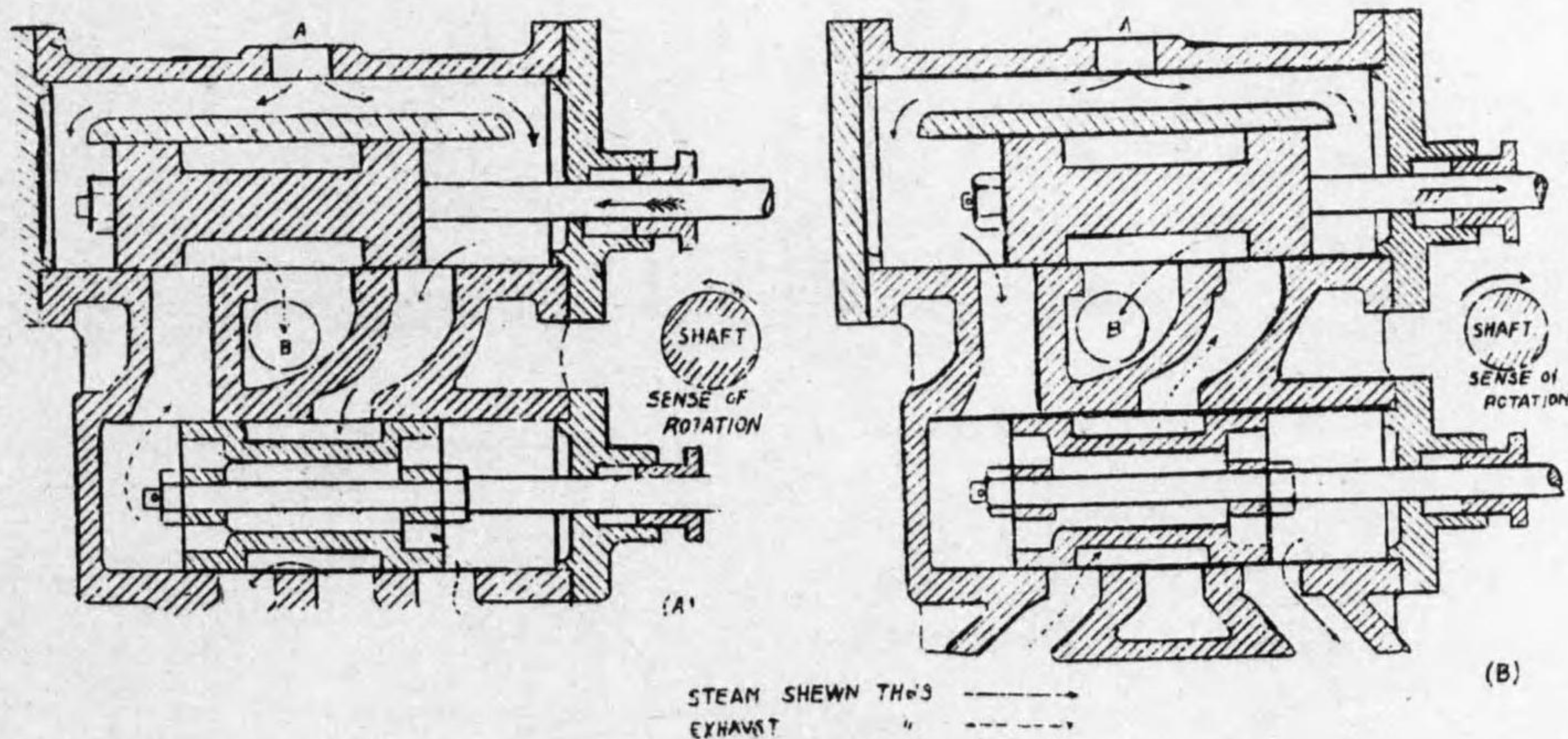

STEAM SHOWN THUS
EXHAUST " " " " " "

第 128 圖

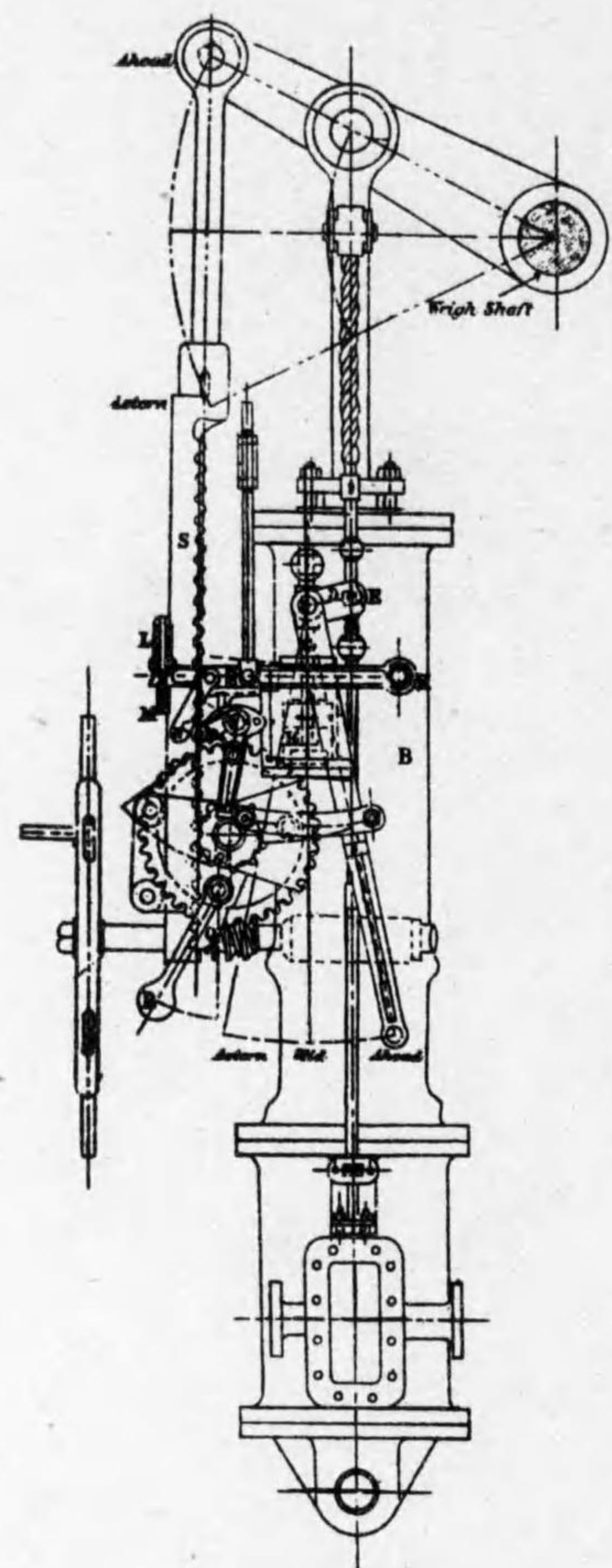

第 129 圖A

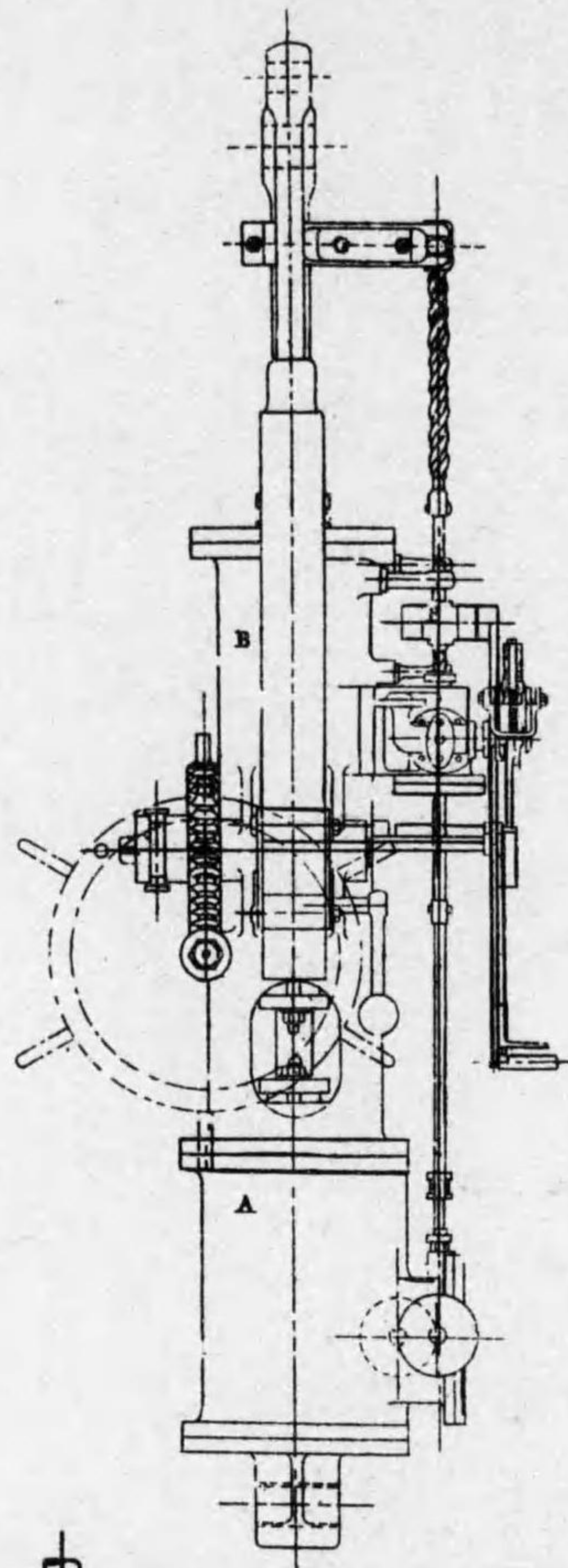

第 129 圖B

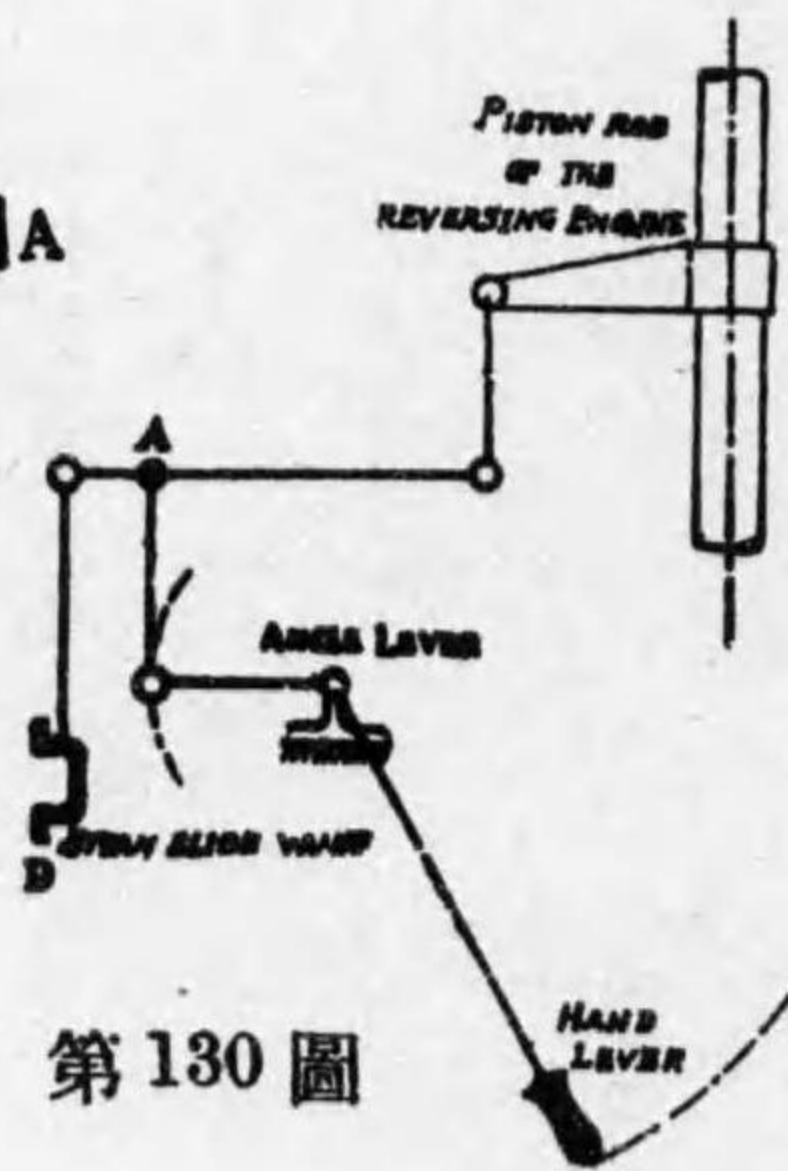

第 130 圖

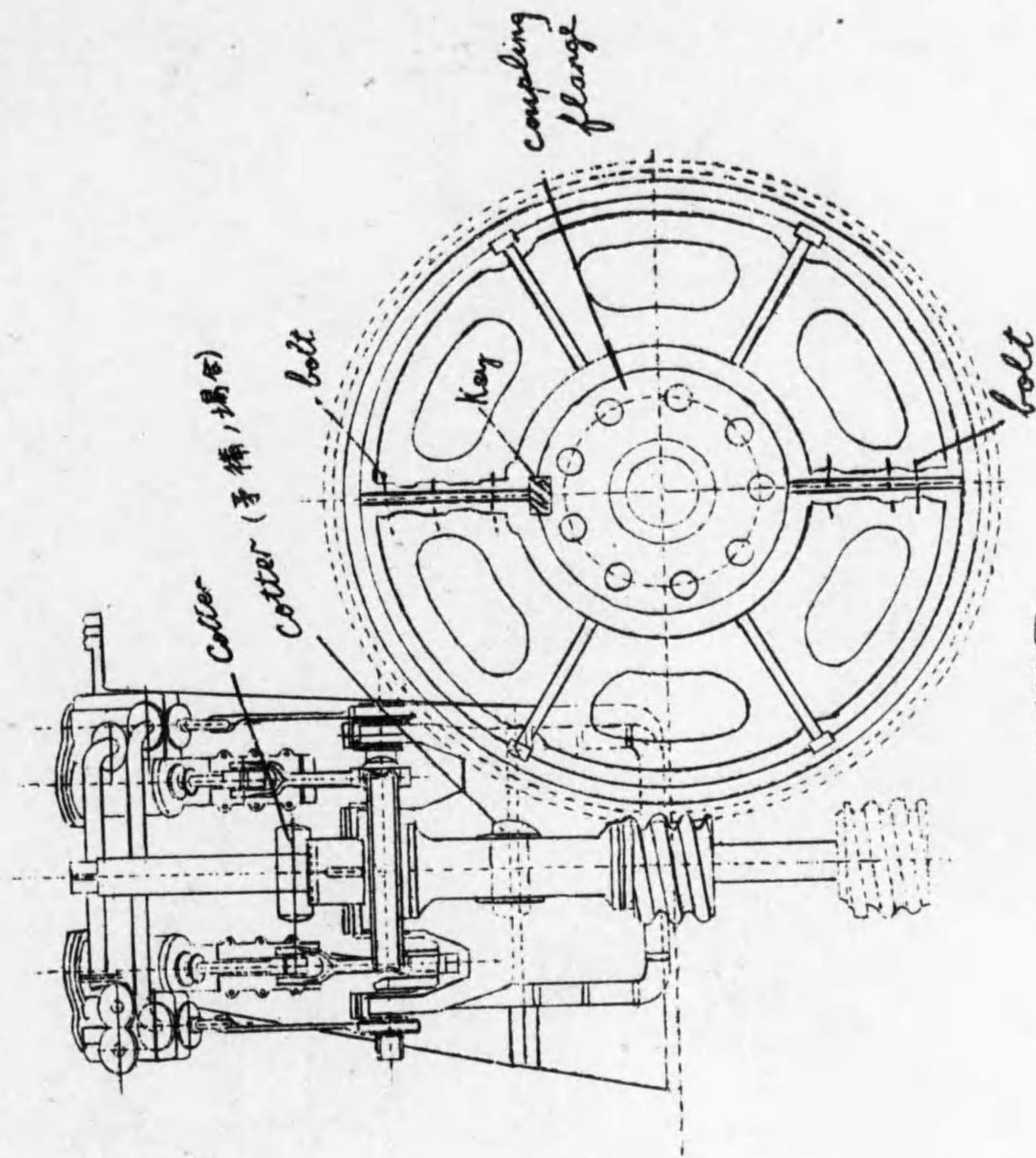

第 131 圖B

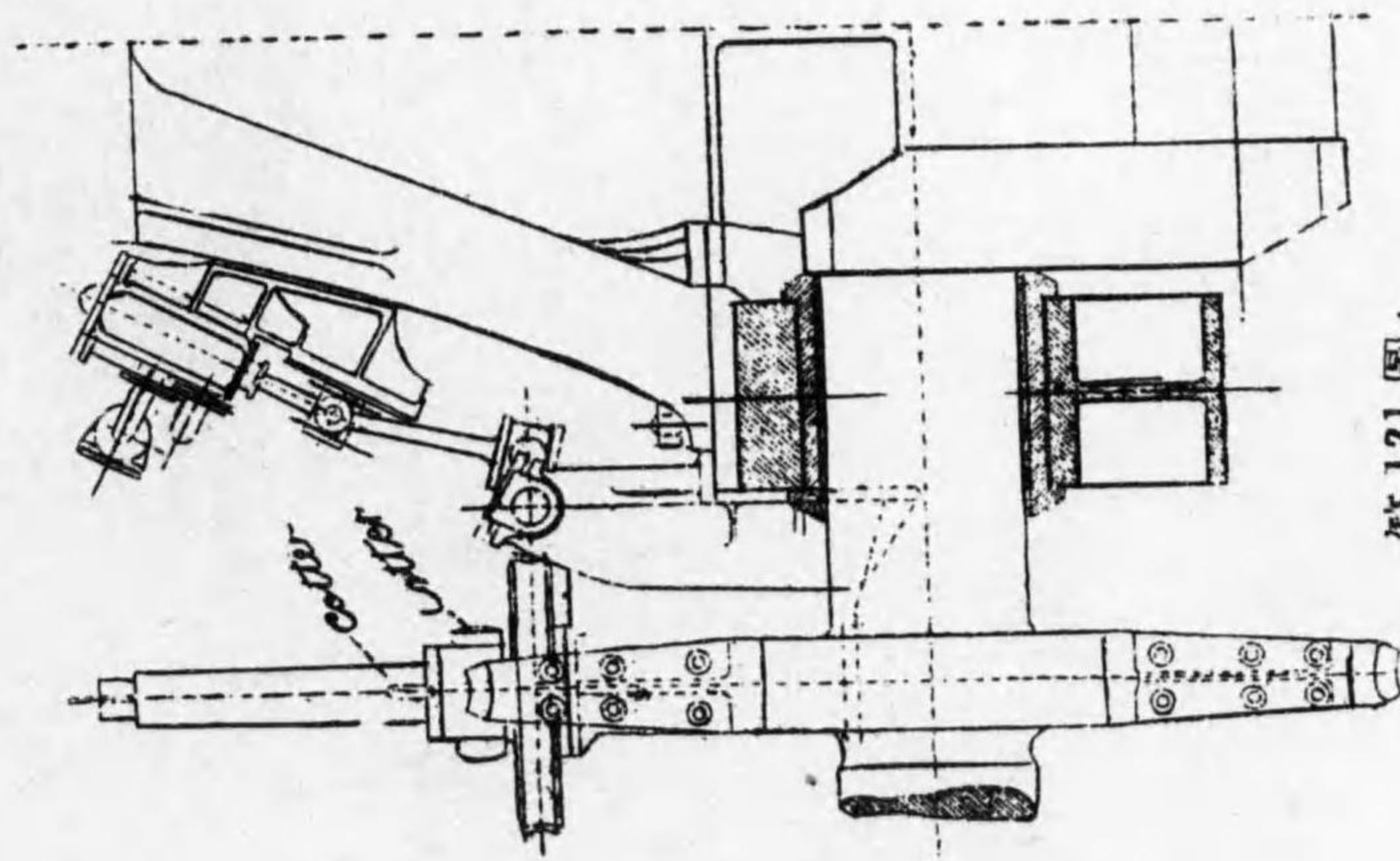

第 131 圖A

第 132 圖

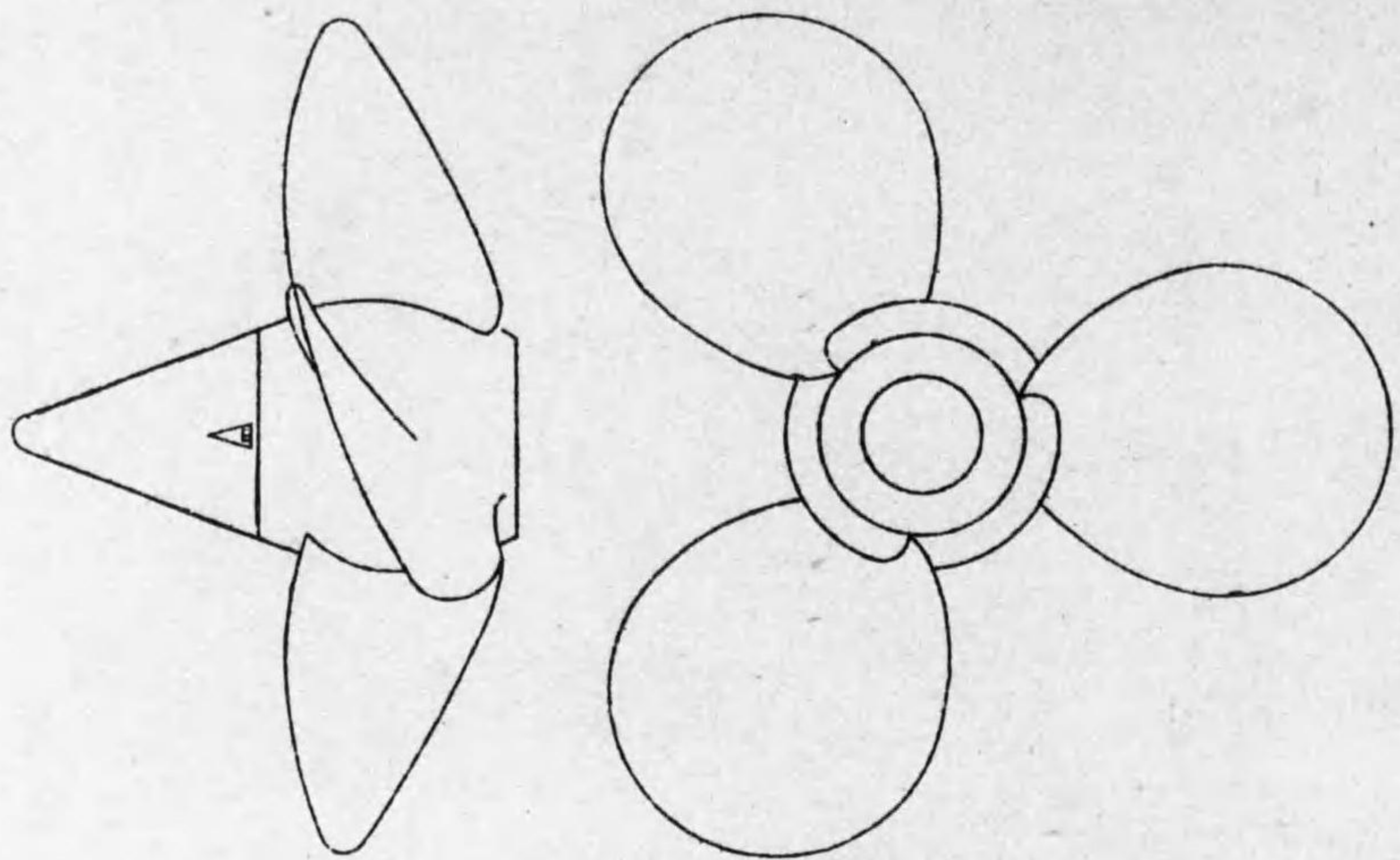

第 133 圖 B

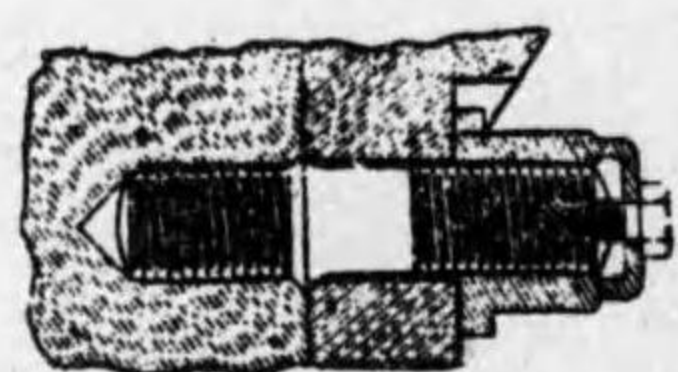
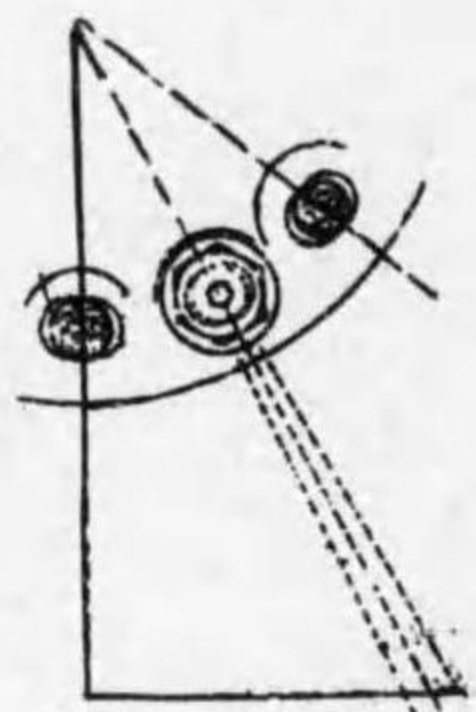

第 133 圖 A

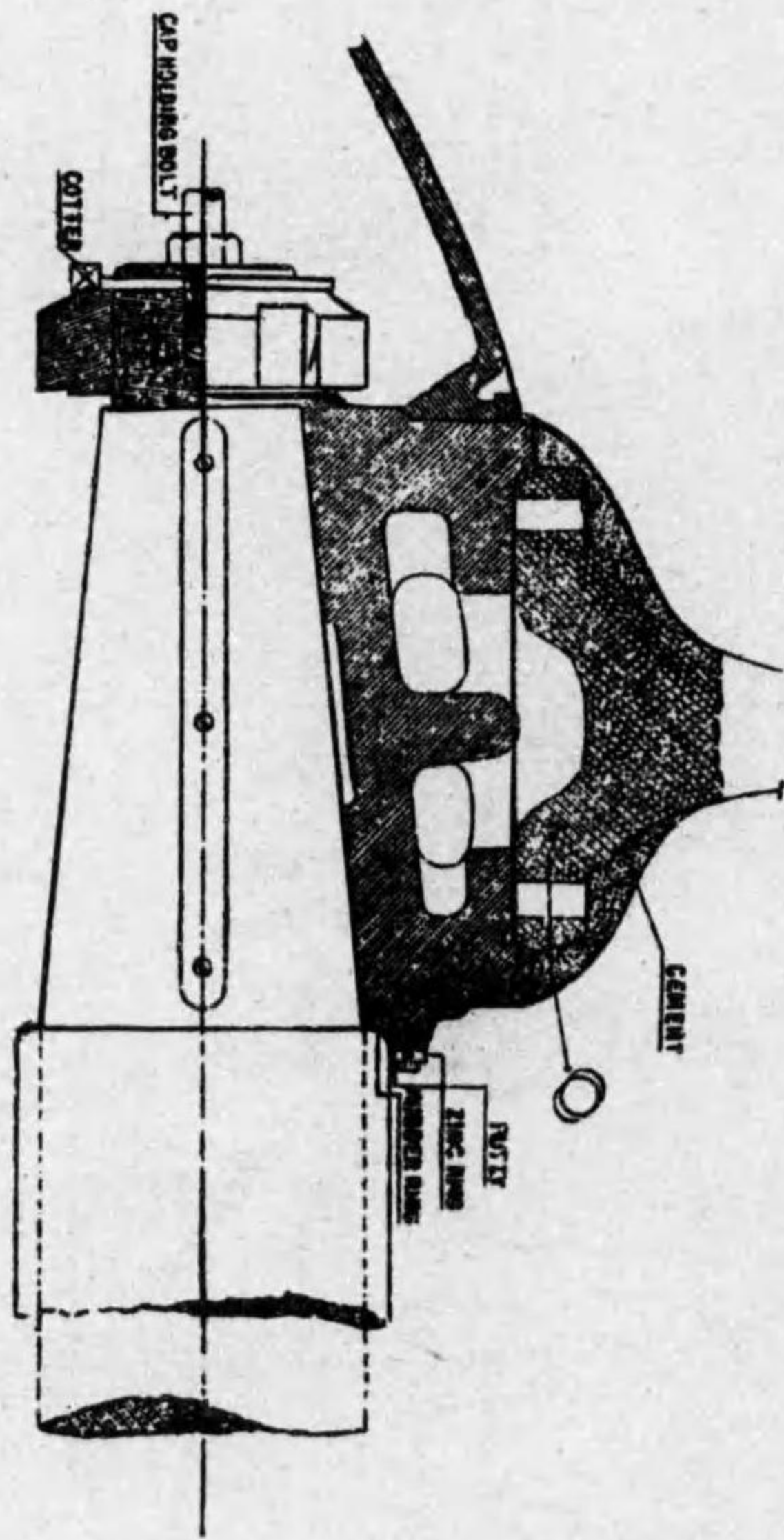

第 134 圖

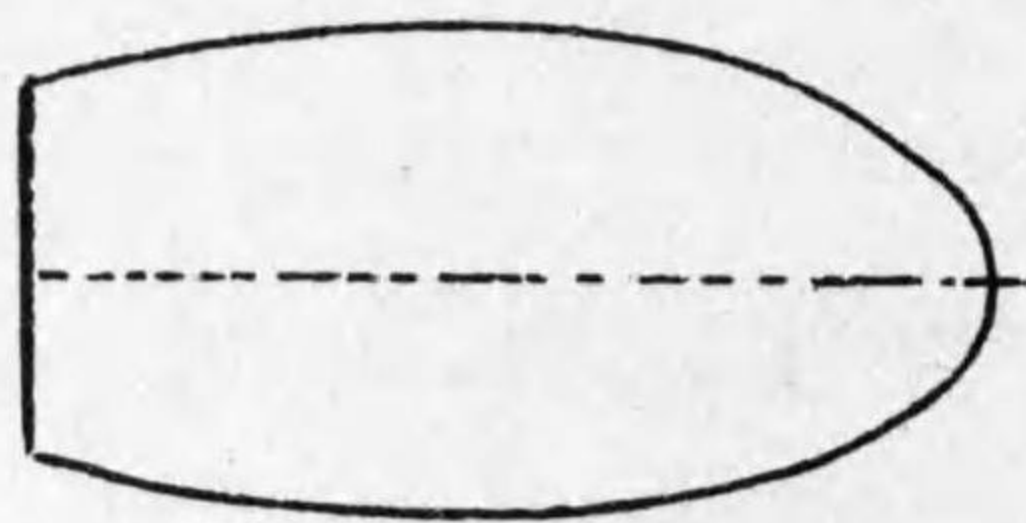

第 135 圖

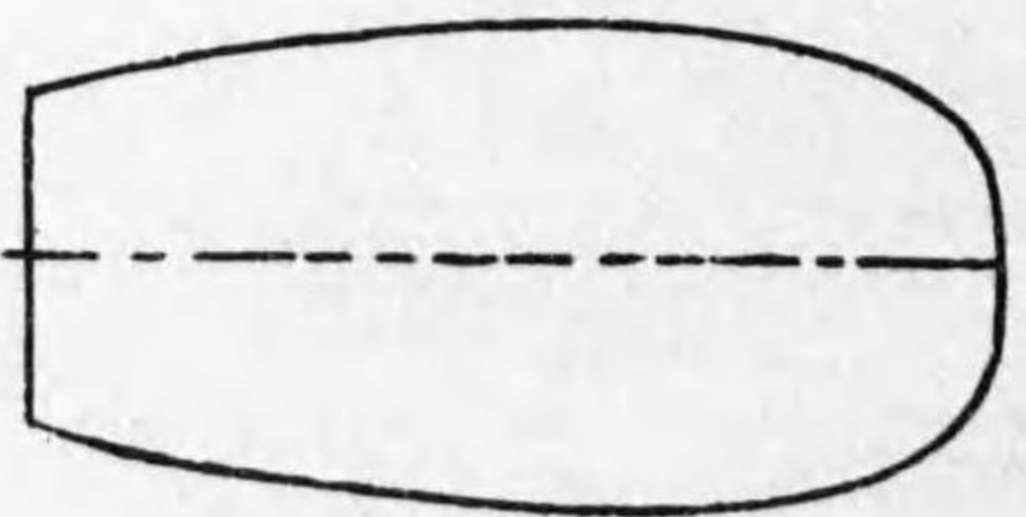

第 138 圖

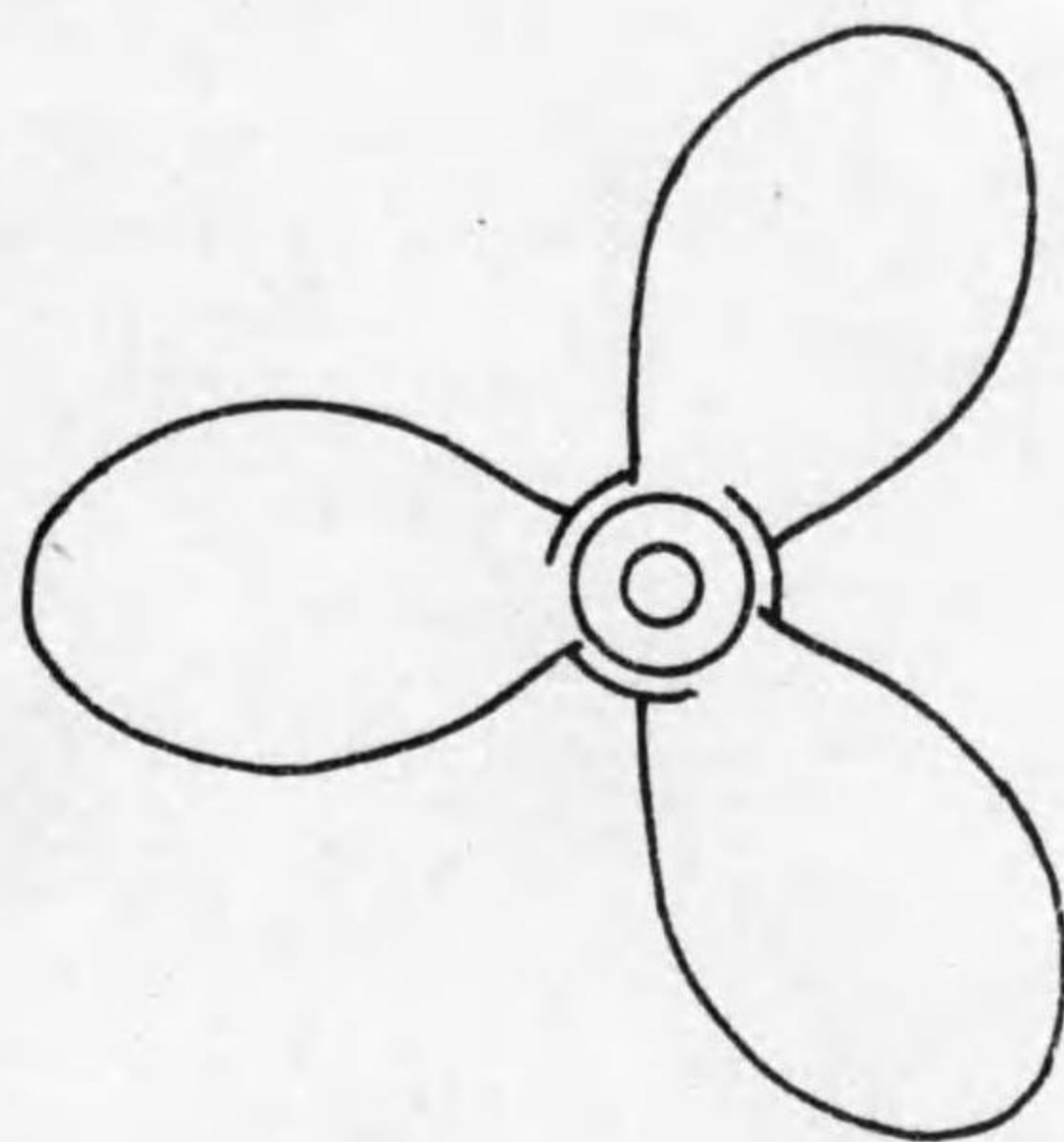

第 137 圖

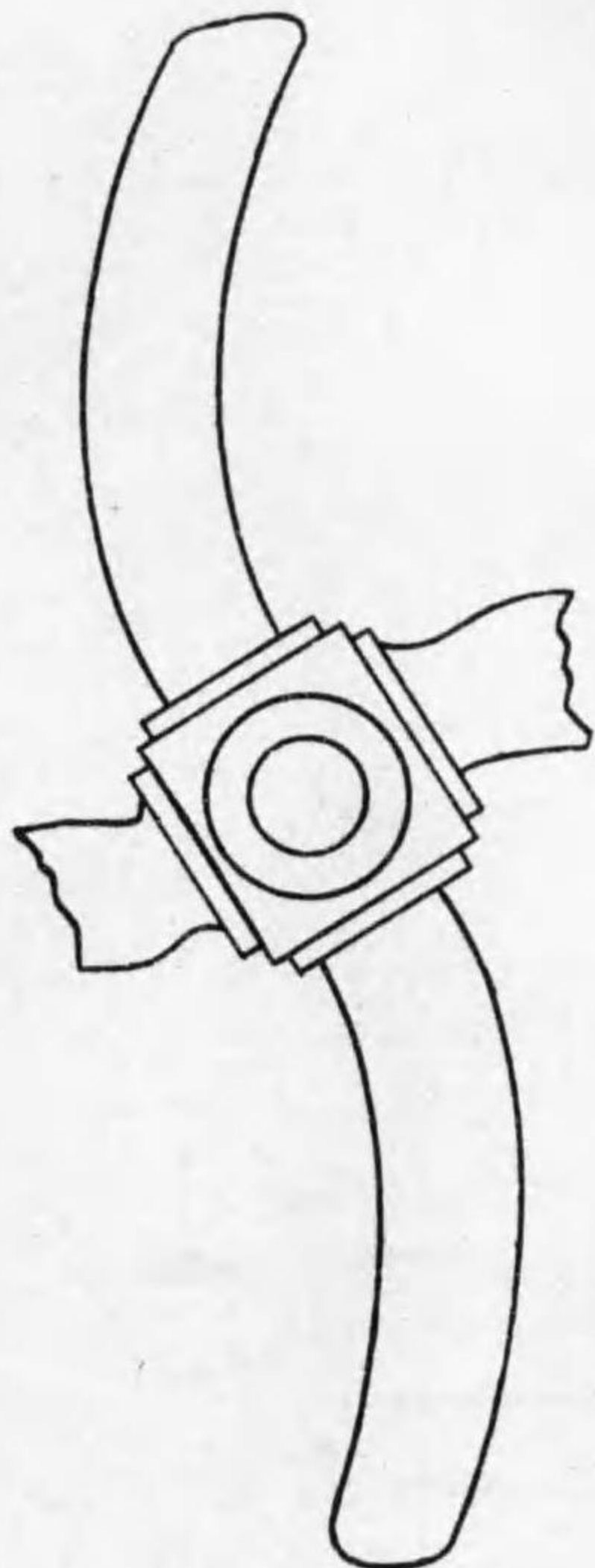

第 136 圖

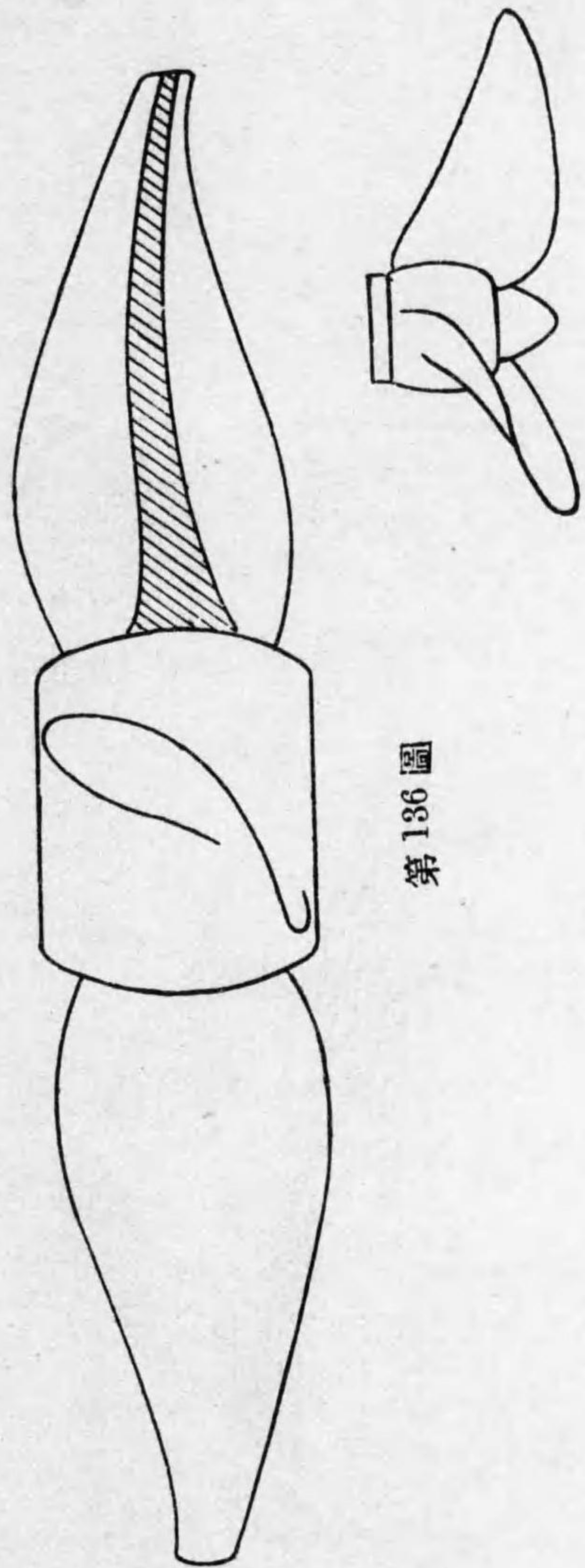

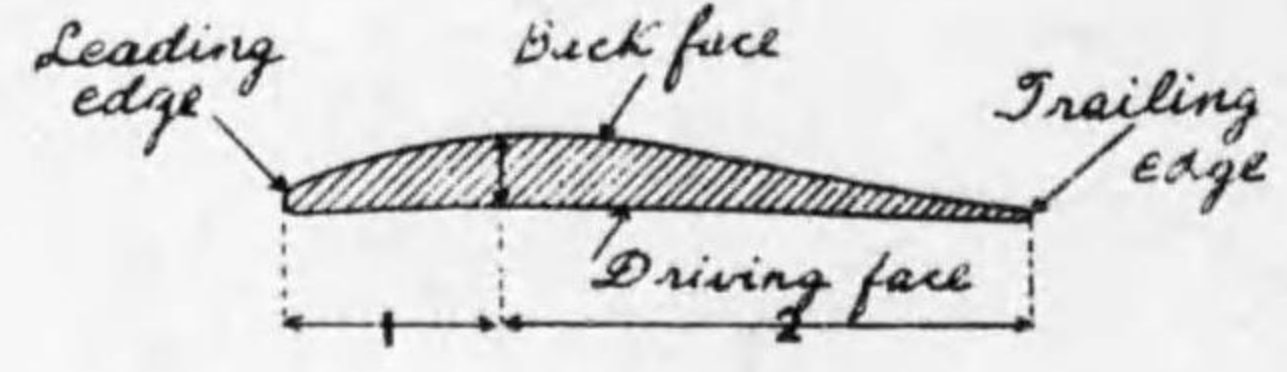

第 139 圖

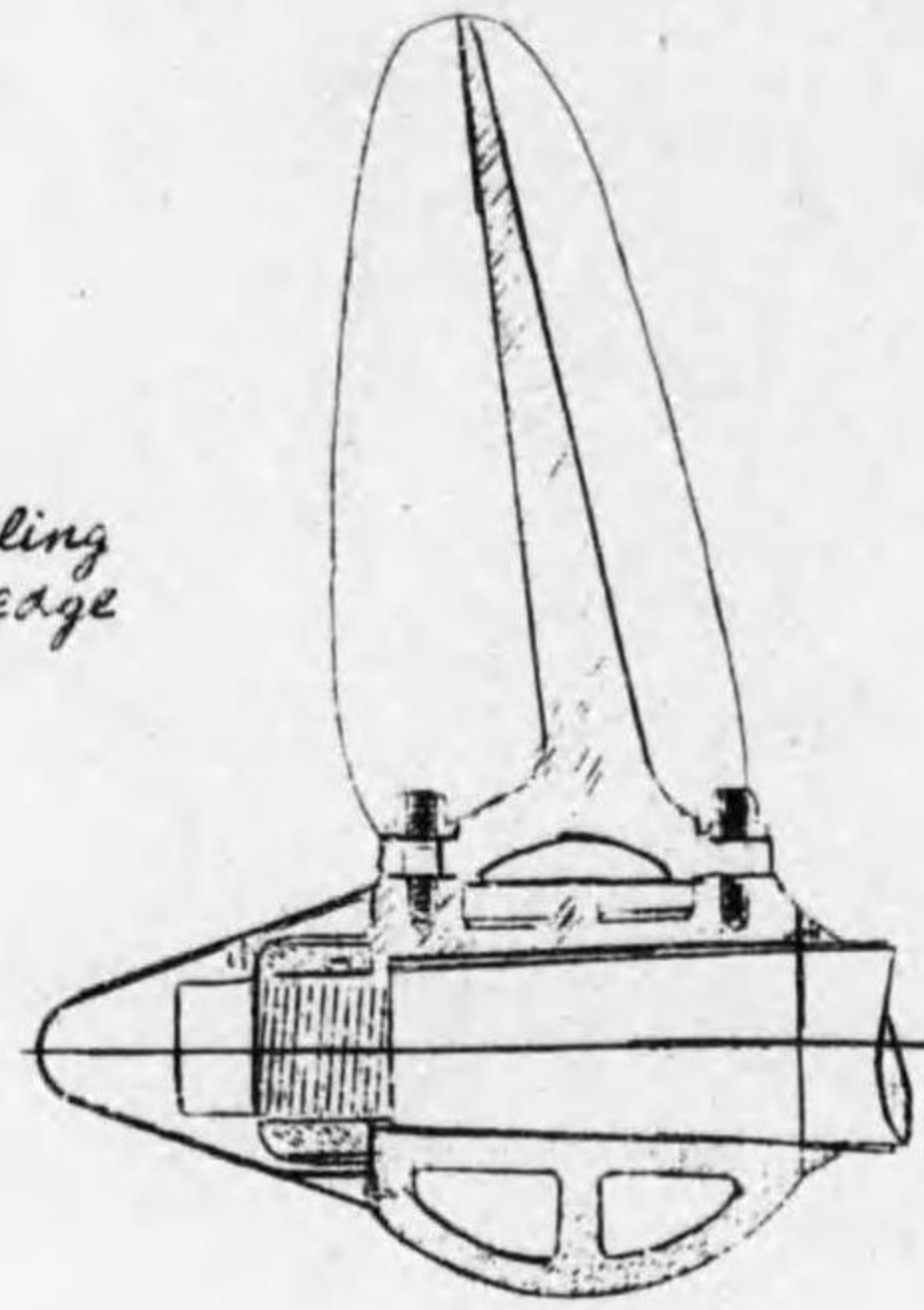

第 140 圖A

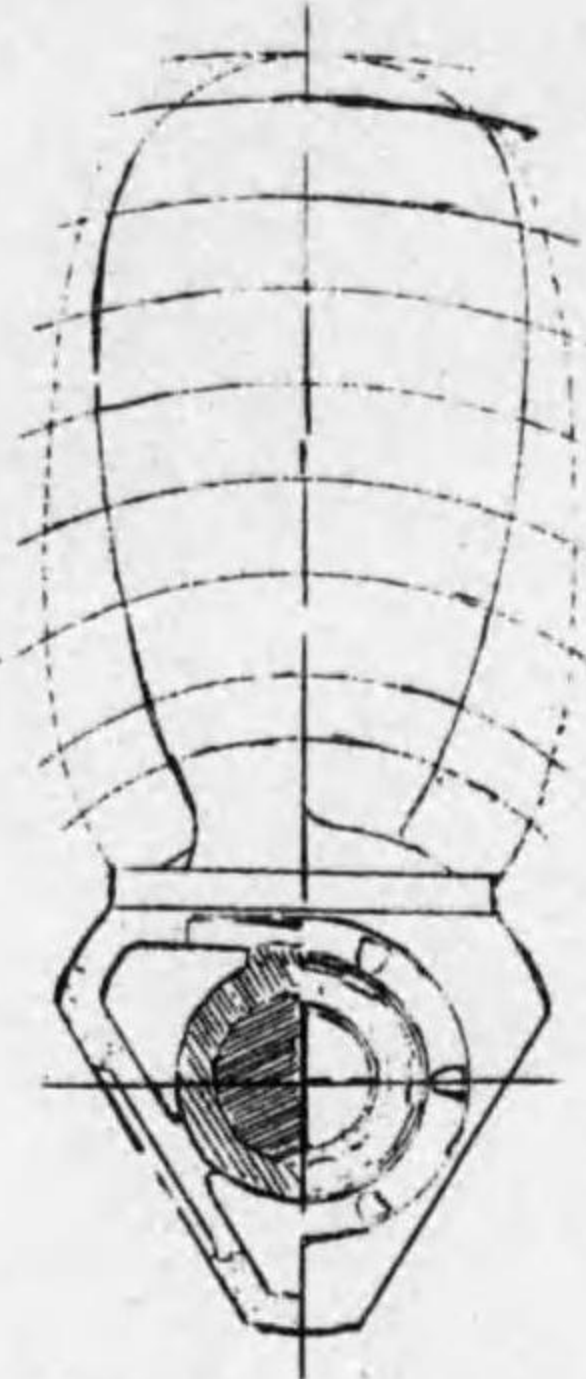

第 140 圖B

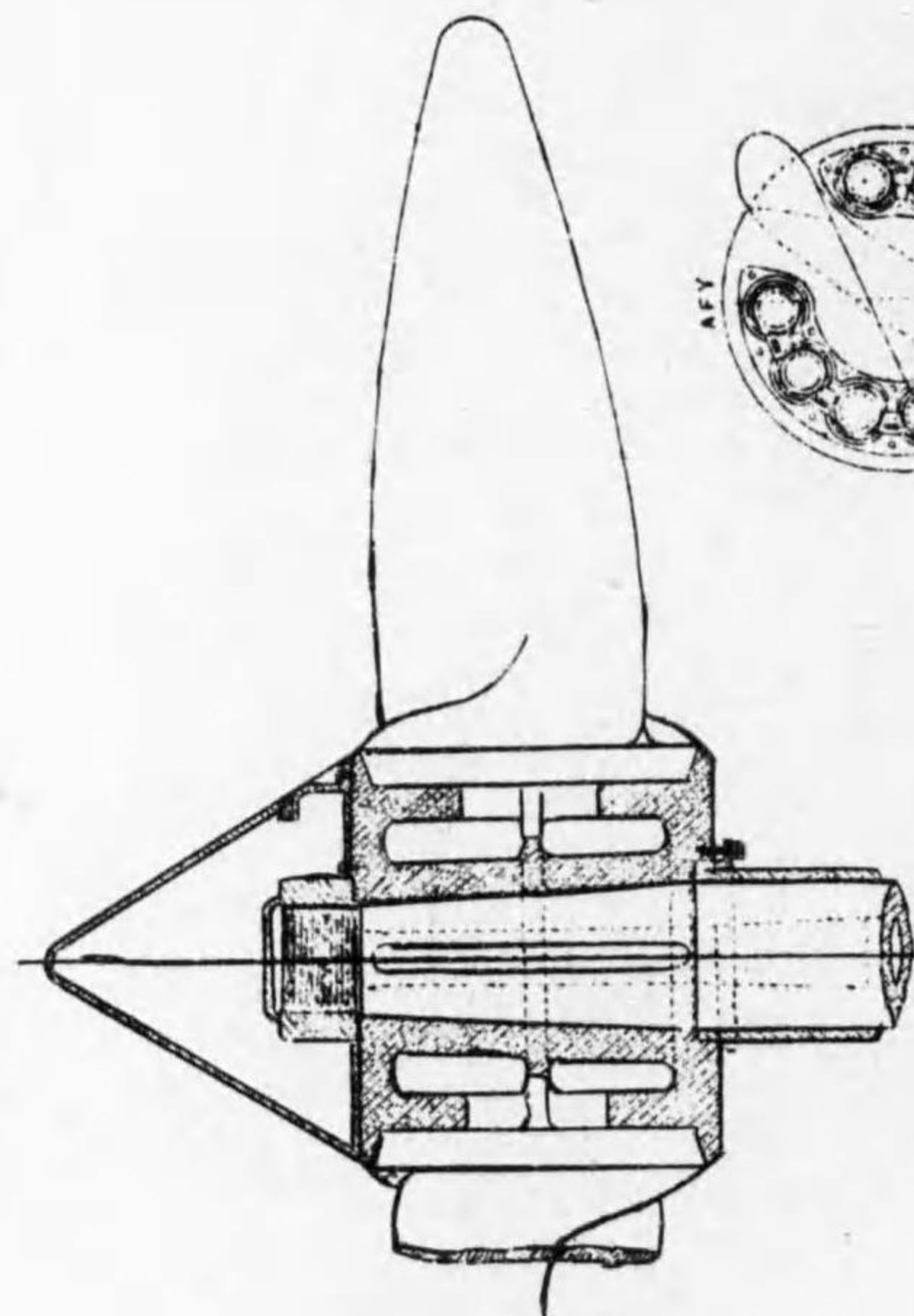

第 141 圖A

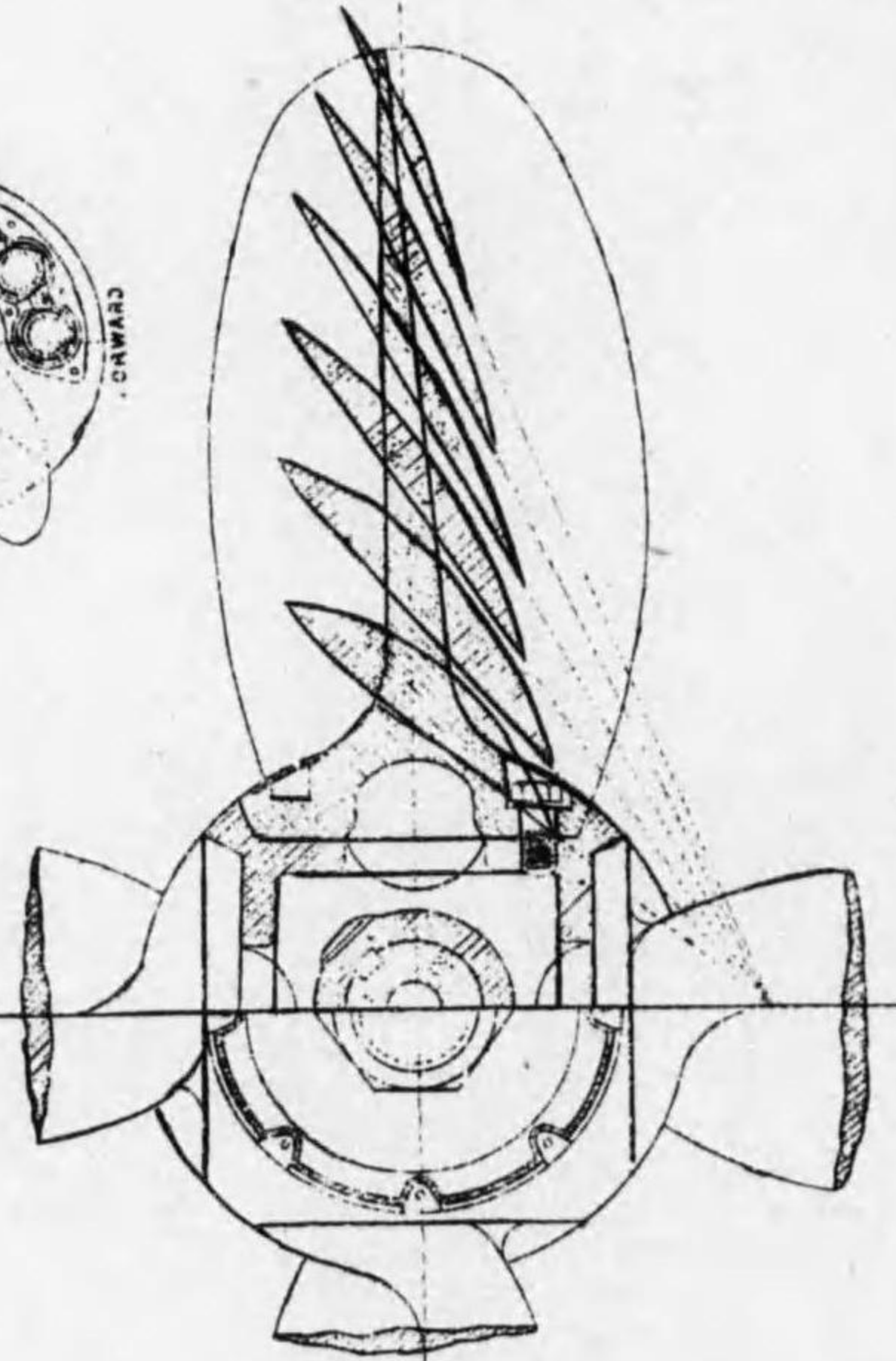
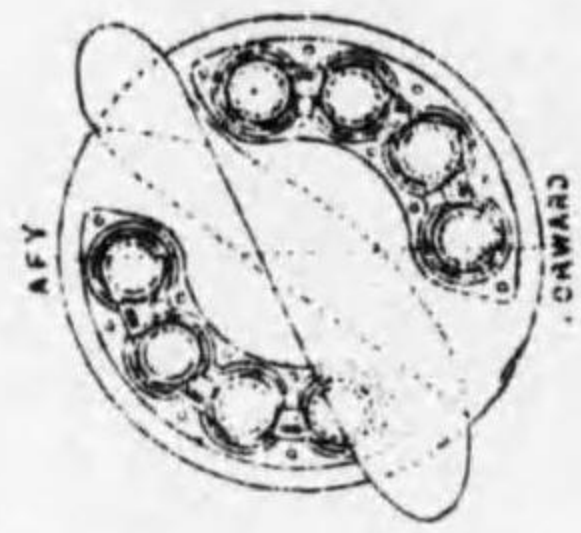

第 141 圖B

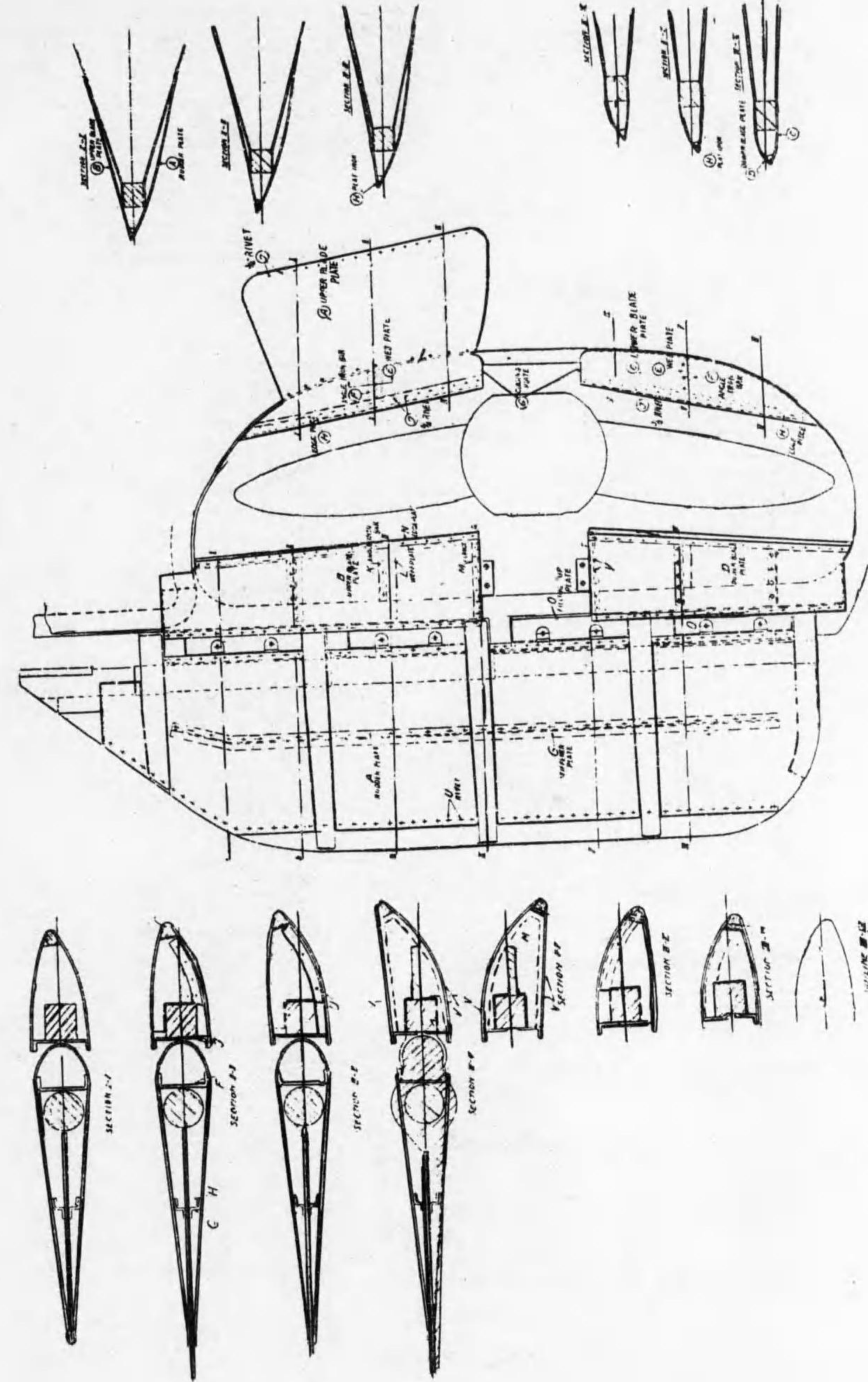

第 142 圖A

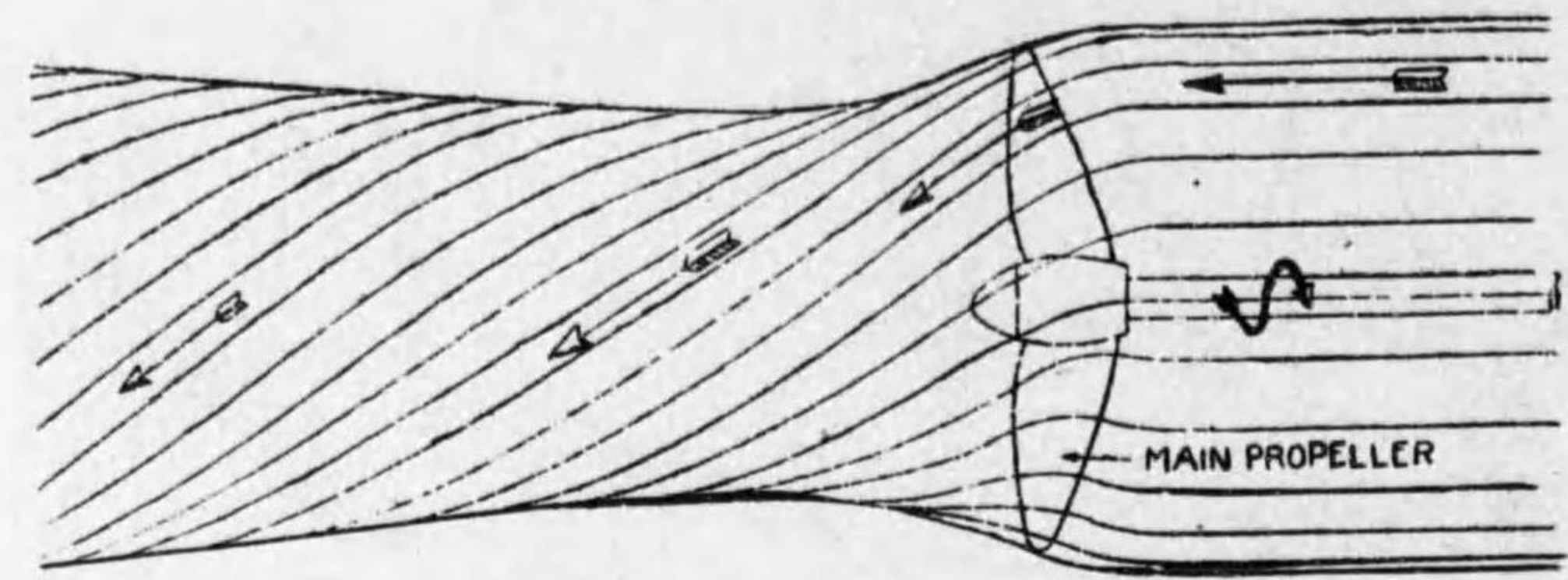

PROPELLER WITHOUT CONTRA PROPELLER.

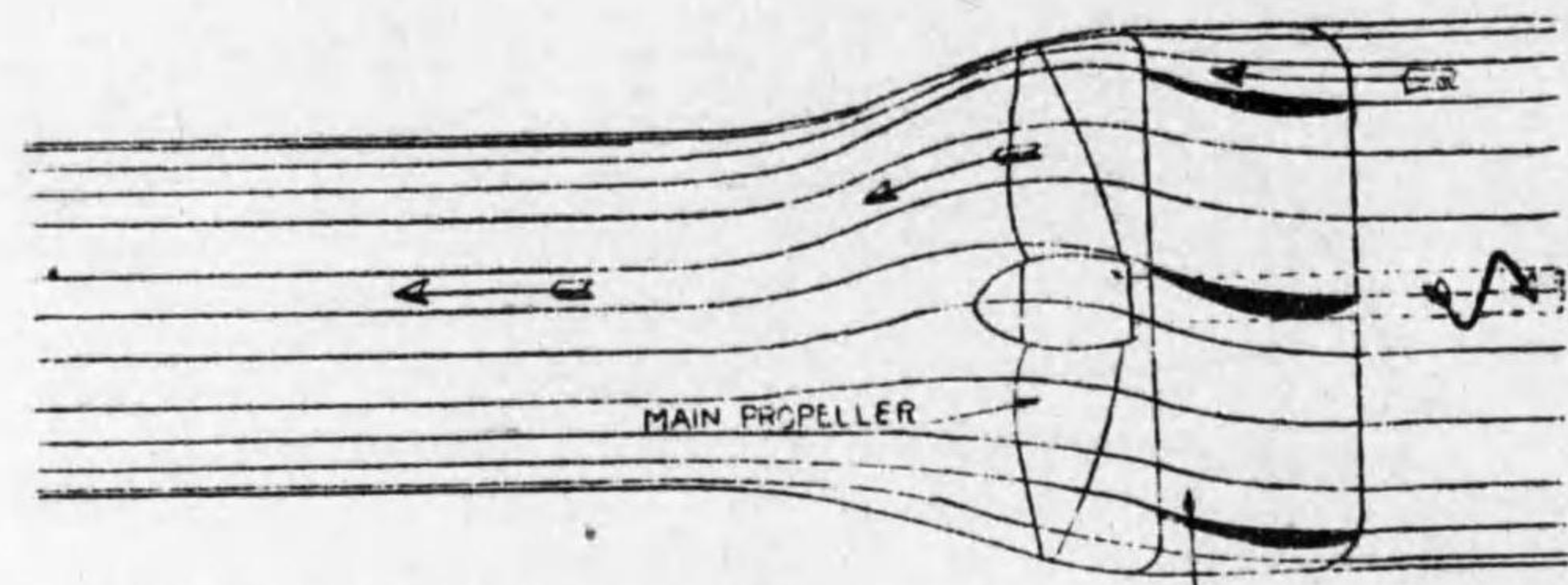

PROPELLER WITH CONTRA PROPELLER

CONTRA PROPELLER

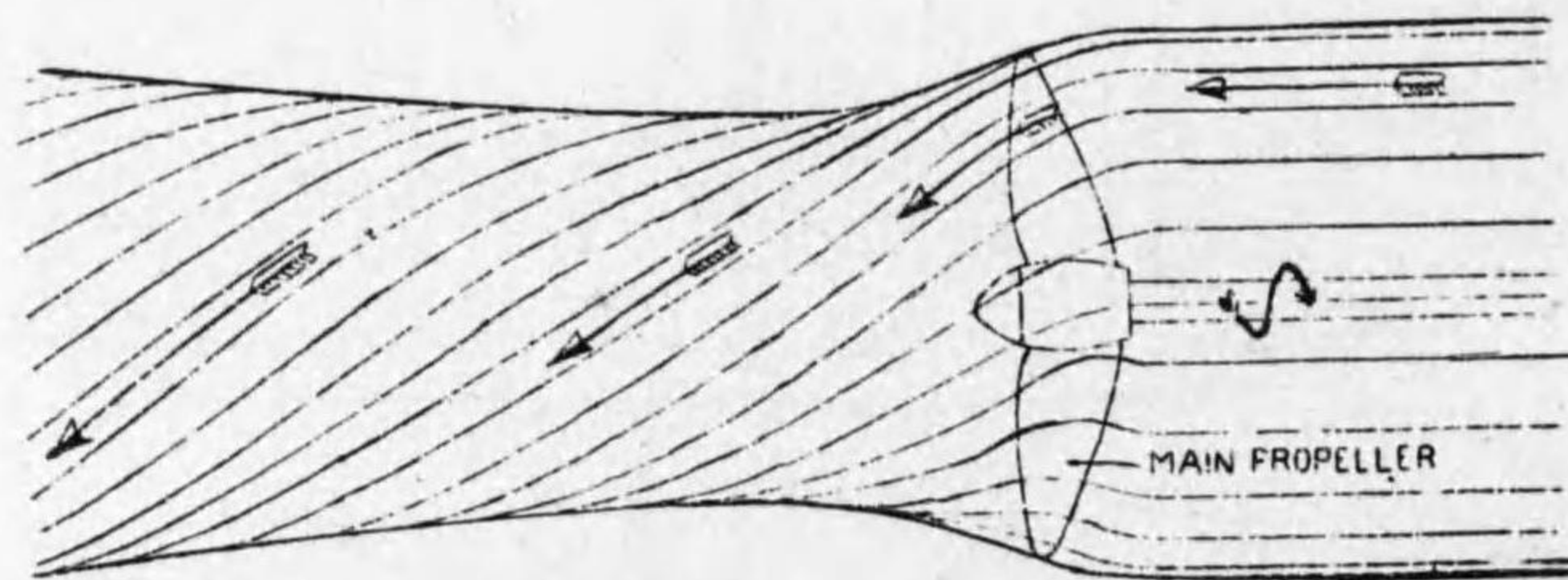

PROPELLER WITHOUT CONTRA PROPELLER.

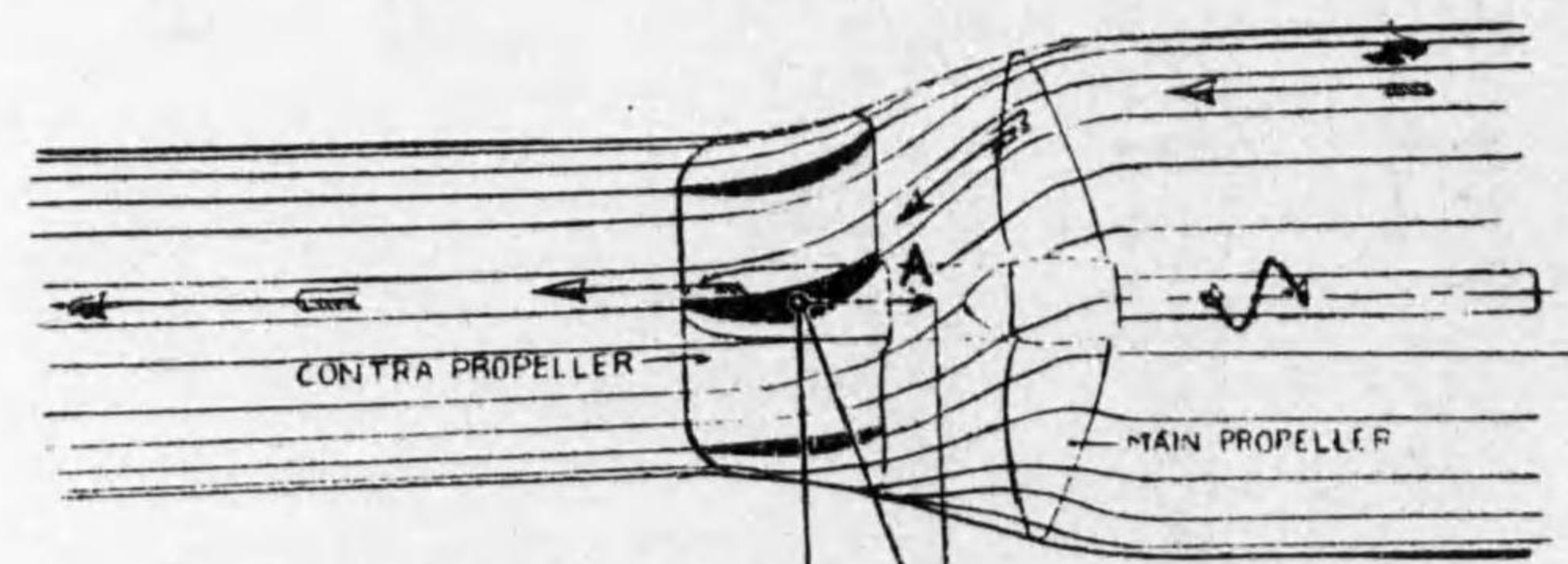

PROPELLER WITH CONTRA PROPELLER

T R
第 142 圖 B

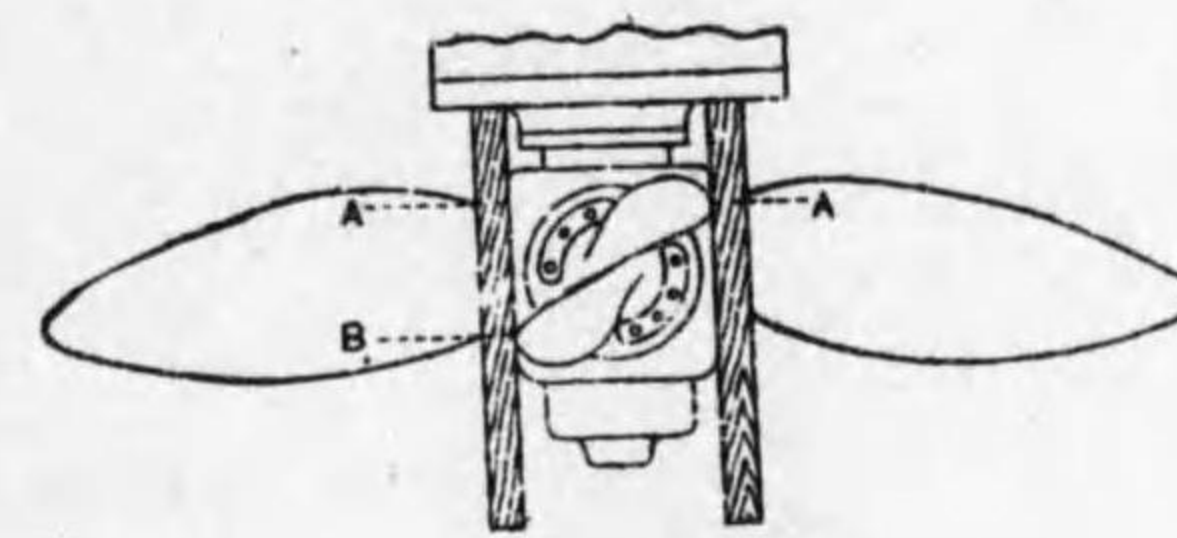
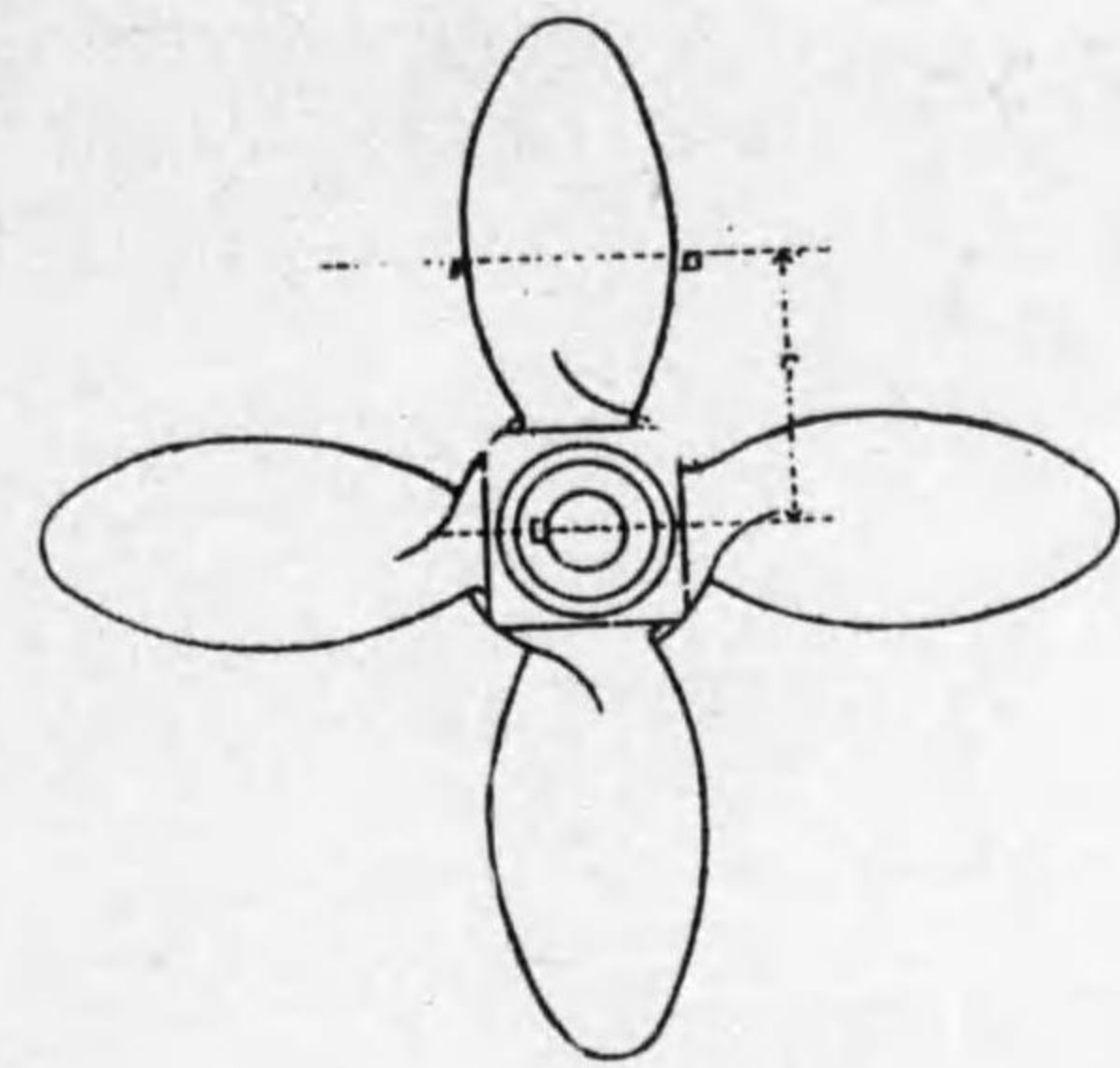

第 145 圖

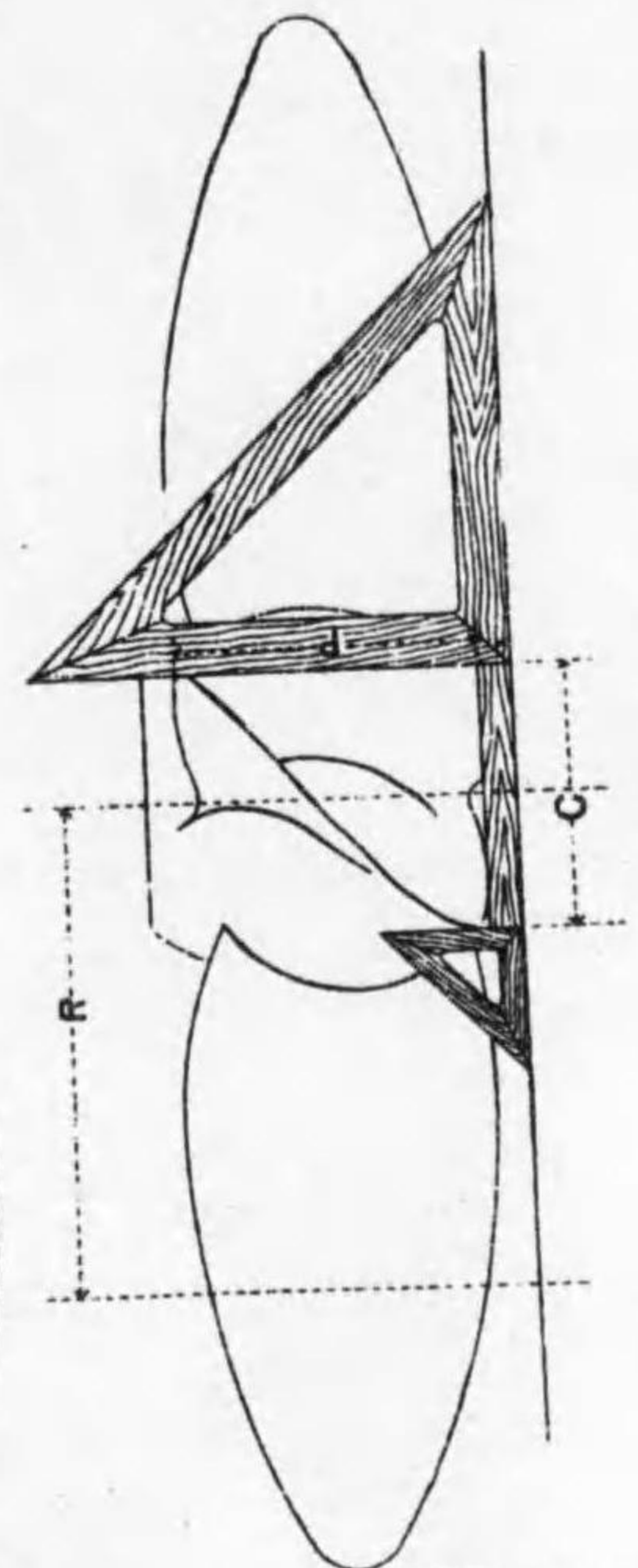

第 143 圖

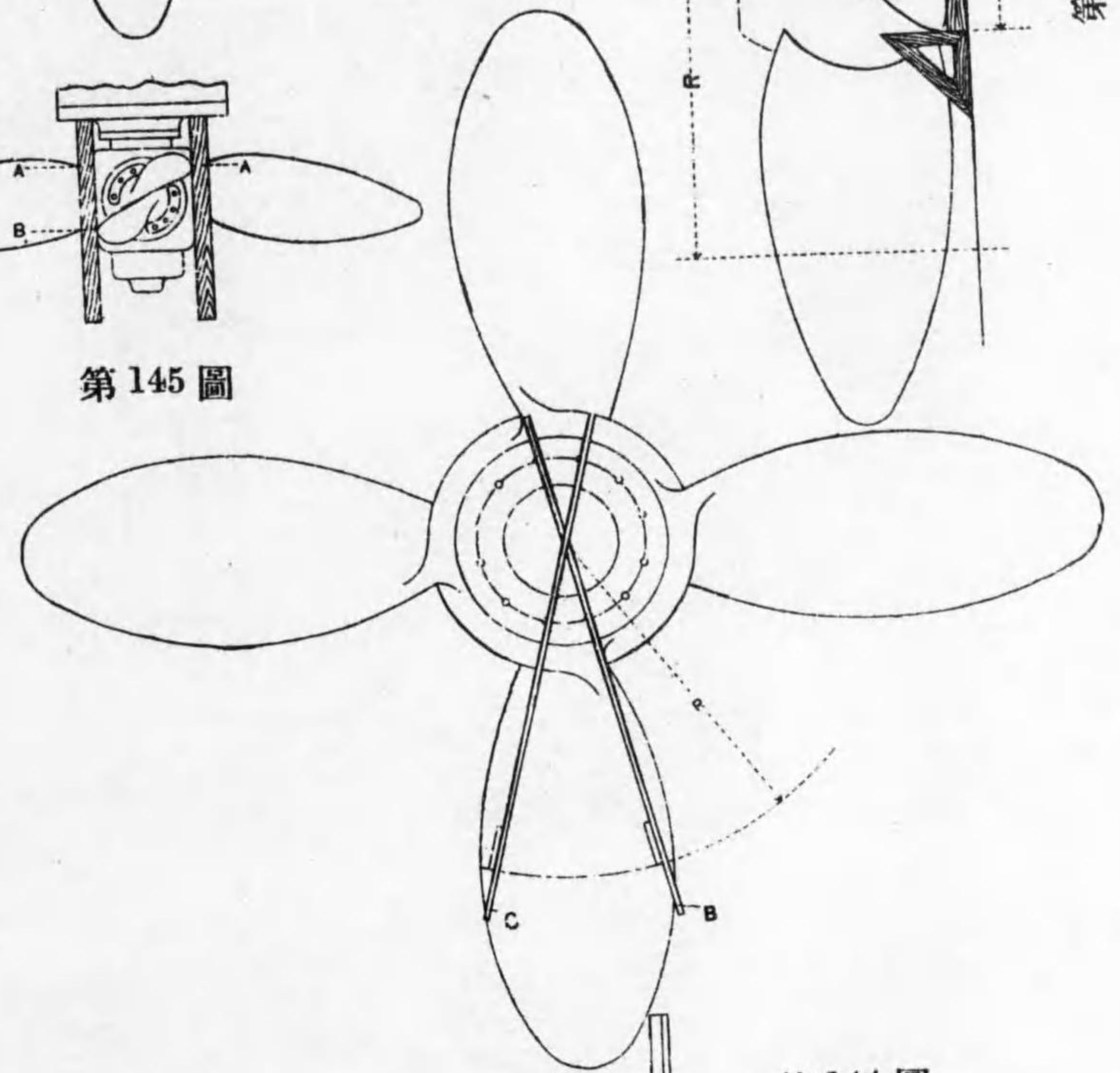

第 144 圖

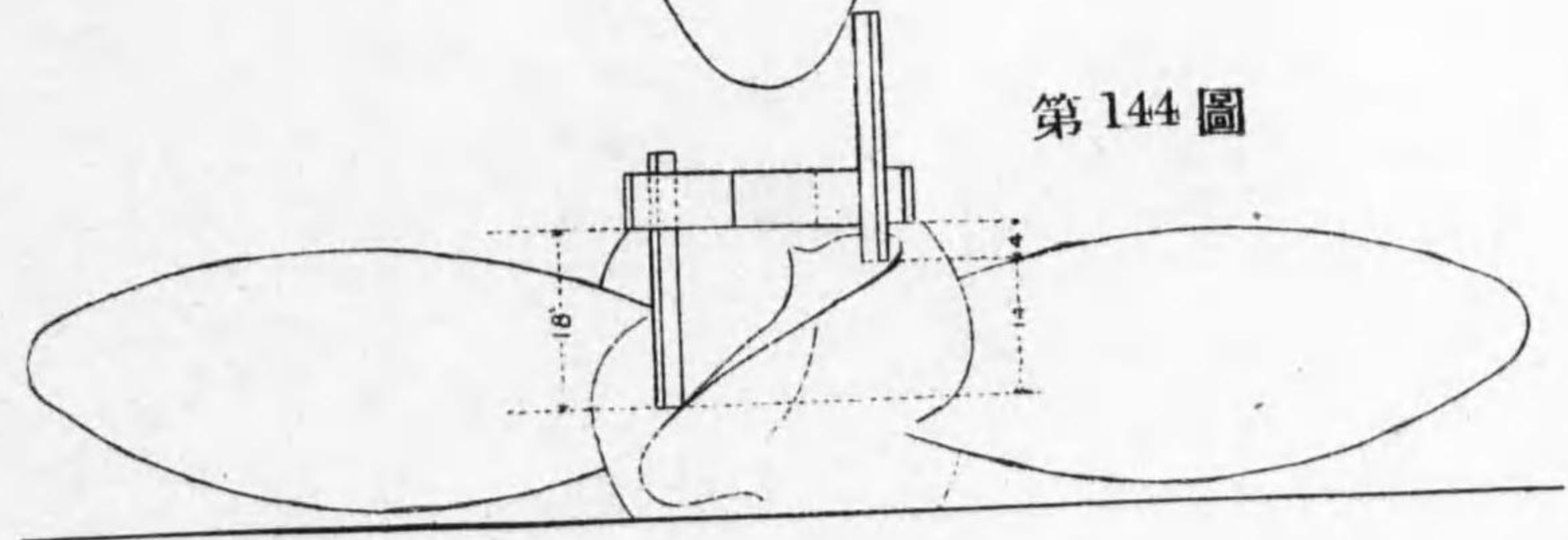

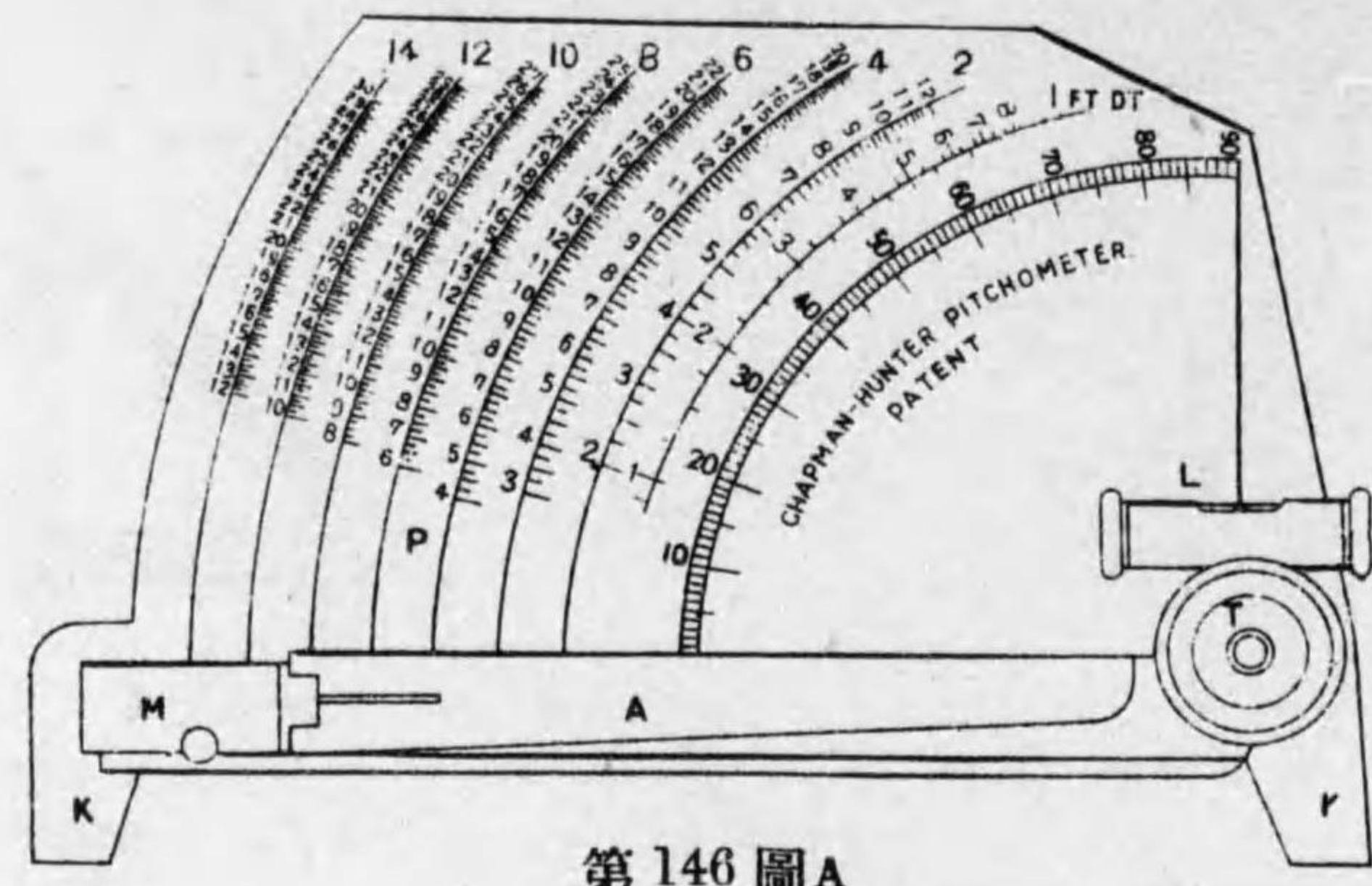

第146圖A

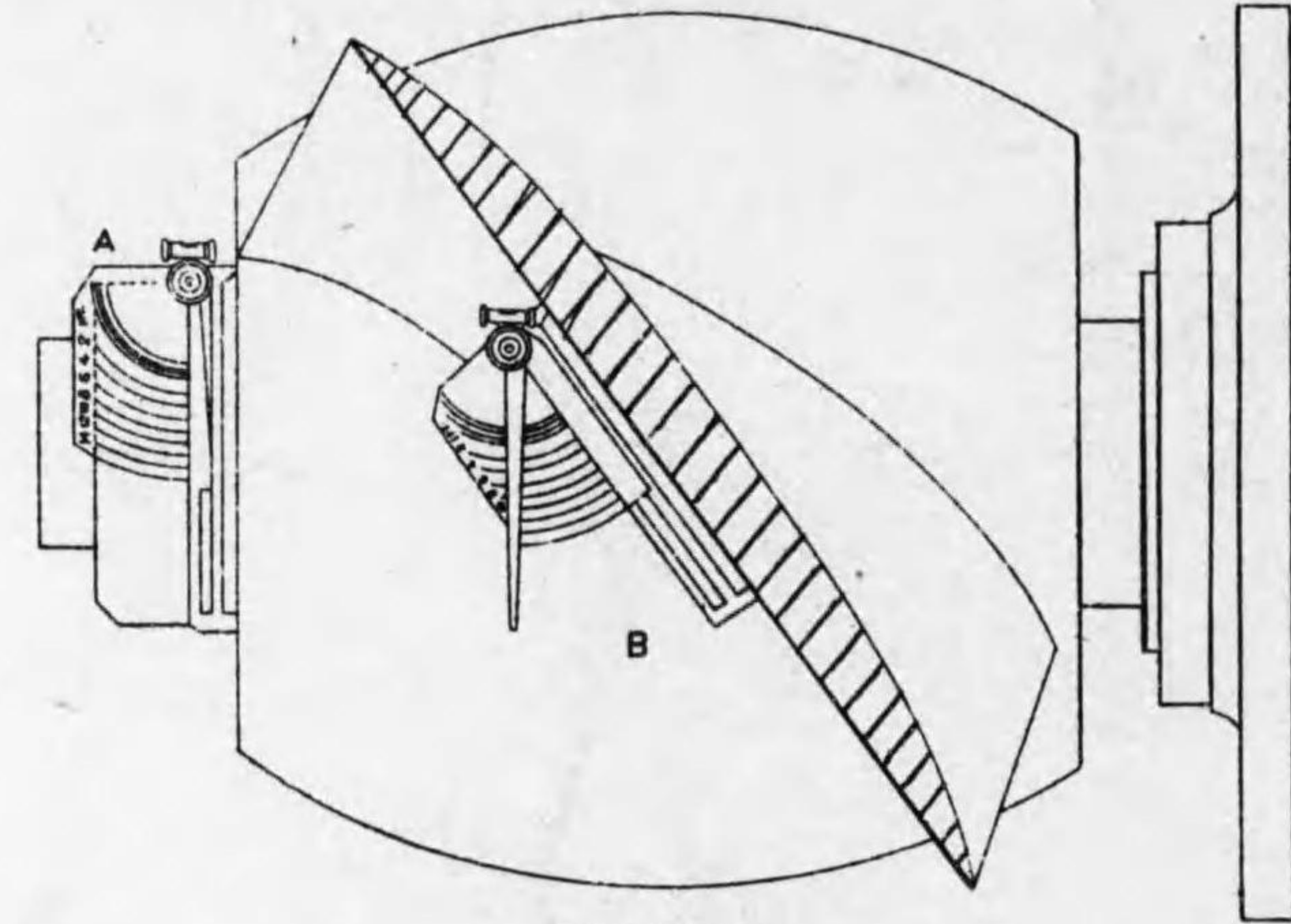

第146圖B

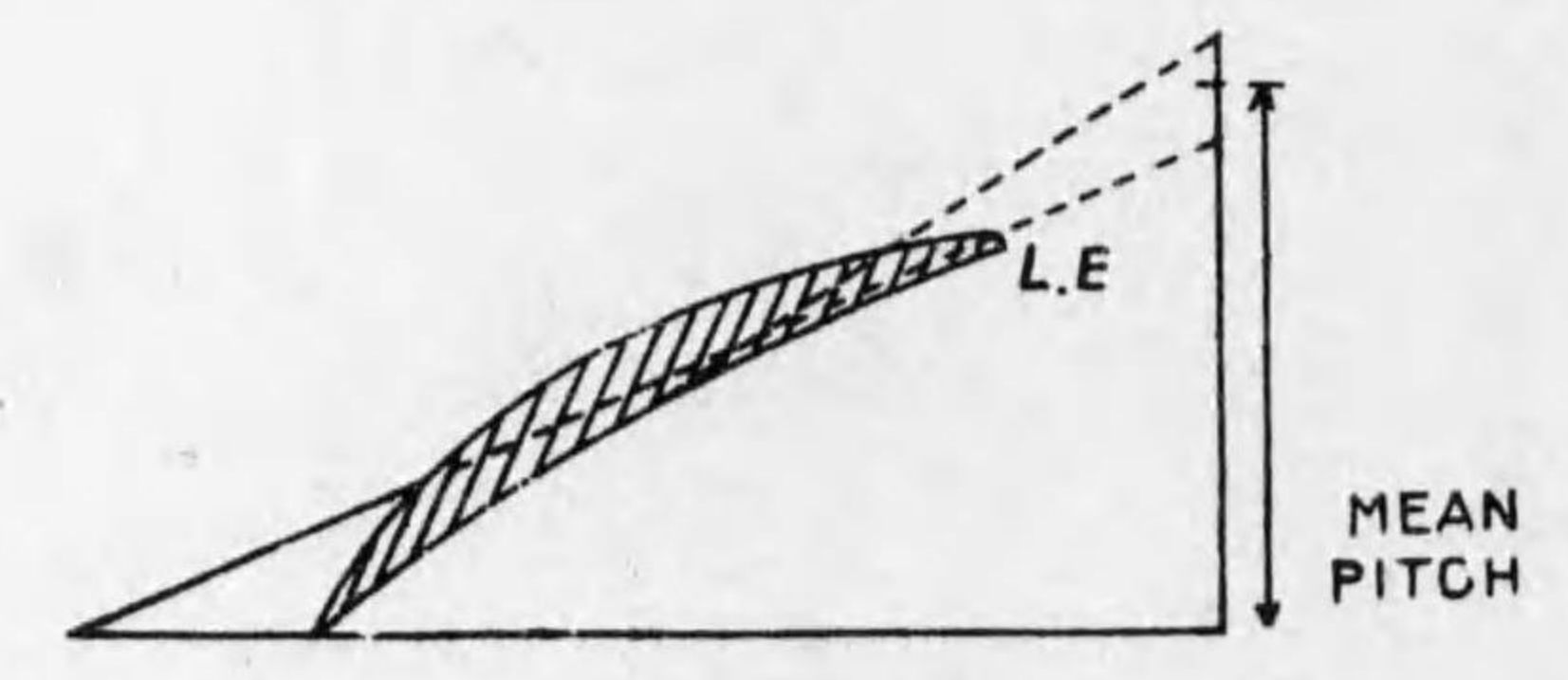

第147圖

昭和十四年七月十五日
 昭和十一年五月二十五日
 昭和七年六月二十五日
 昭和七年六月二十五日
 印刷
 發行
 增訂
 增發
 發行

臨時公立商船學校
 教科書編纂委員會

編纂者

發行者 賀集喜一郎
 東京市神田區小川町二丁目一番地

印刷者 川橋源三郎
 東京市京橋區築地一丁目十四番地

發行所 海文堂出版部

振替東京八〇九九三番
 電話神田二七〇二番

東京市神田區小川町二丁目一番地

特205

516

終